



FCC Radio Test Report

FCC ID: 2BCGWAP9665

This report concerns: Class II permissive Change

Project No. : 2308G050B
Equipment : AX3600 Ceiling Mount Wi-Fi 6 Access Point
Brand Name : tp-link
Test Model : AP9665
Series Model : N/A
Applicant : TP-LINK CORPORATION PTE. LTD.
Address : 7 Temasek Boulevard #29-03 Suntec Tower One, Singapore 038987
Manufacturer : TP-LINK CORPORATION PTE. LTD.
Address : 7 Temasek Boulevard #29-03 Suntec Tower One, Singapore 038987
Date of Receipt : May 24, 2024
Date of Test : May 24, 2024 ~ Jun. 05, 2024
Issued Date : Jun. 07, 2024
Report Version : R00
Test Sample : Engineering Sample No.: SSL20240524127
Standard(s) : FCC CFR Title 47, Part 15, Subpart C

The above equipment has been tested and found compliance with the requirement of the relative standards by BTL Inc.

Prepared by : Chella Zheng
Chella Zheng

Approved by : Chay Cai
Chay Cai

Room 108, Building 2, No.1, Yile Road, Songshan Lake Zone, Dongguan City, Guangdong,
People's Republic of China

Tel: +86-769-8318-3000 Web: www.newbtl.com Service mail: btl_qa@newbtl.com

Declaration

BTL represents to the client that testing is done in accordance with standard procedures as applicable and that test instruments used has been calibrated with standards traceable to international standard(s) and/or national standard(s).

BTL's reports apply only to the specific samples tested under conditions. It is manufacture's responsibility to ensure that additional production units of this model are manufactured with the identical electrical and mechanical components. **BTL** assumes no responsibility for the data provided by the customer, any statements, inferences or generalizations drawn by the customer or others from the reports issued by **BTL**.

The report must not be used by the client to claim product certification, approval, or endorsement by A2LA or any agency of the U.S. Government.

This report is the confidential property of the client. As a mutual protection to the clients, the public and ourselves, the test report shall not be reproduced, except in full, without our written approval.

BTL's laboratory quality assurance procedures are in compliance with the ISO/IEC 17025: 2017 requirements, and accredited by the conformity assessment authorities listed in this test report.

BTL is not responsible for the sampling stage, so the results only apply to the sample as received.

The information, data and test plan are provided by manufacturer which may affect the validity of results, so it is manufacturer's responsibility to ensure that the apparatus meets the essential requirements of applied standards and in all the possible configurations as representative of its intended use.

Limitation

For the use of the authority's logo is limited unless the Test Standard(s)/Scope(s)/Item(s) mentioned in this test report is (are) included in the conformity assessment authorities acceptance respective.

Please note that the measurement uncertainty is provided for informational purpose only and are not use in determining the Pass/Fail results.

Table of Contents	Page
REPORT ISSUED HISTORY	4
1 . APPLICABLE STANDARDS	5
2 . SUMMARY OF TEST RESULTS	5
2.1 TEST FACILITY	6
2.2 MEASUREMENT UNCERTAINTY	6
2.3 TEST ENVIRONMENT CONDITIONS	6
3 . GENERAL INFORMATION	7
3.1 GENERAL DESCRIPTION OF EUT	7
3.2 DESCRIPTION OF TEST MODES	8
3.3 BLOCK DIAGRAM SHOWING THE CONFIGURATION OF SYSTEM TESTED	9
3.4 SUPPORT UNITS	9
3.5 CUSTOMER INFORMATION DESCRIPTION	9
4 . AC POWER LINE CONDUCTED EMISSIONS	10
4.1 LIMIT	10
4.2 TEST PROCEDURE	10
4.3 DEVIATION FROM TEST STANDARD	10
4.4 TEST SETUP	11
4.5 EUT OPERATING CONDITIONS	11
4.6 TEST RESULTS	11
5 . RADIATED EMISSIONS	12
5.1 LIMIT	12
5.2 TEST PROCEDURE	12
5.3 DEVIATION FROM TEST STANDARD	13
5.4 TEST SETUP	13
5.5 EUT OPERATING CONDITIONS	13
5.6 TEST RESULTS - 30 MHZ TO 1000 MHZ	13
6 . MEASUREMENT INSTRUMENTS LIST	14
7 . EUT TEST PHOTO	15
APPENDIX A - AC POWER LINE CONDUCTED EMISSIONS	17
APPENDIX B - RADIATED EMISSION - 30 MHZ TO 1000 MHZ	20

REPORT ISSUED HISTORY

Report No.	Version	Description	Issued Date	Note
BTL-FCCP-1-2308G050B	R00	Original Report.	Jun. 07, 2024	Valid

1. APPLICABLE STANDARDS

According to the specifications of the manufacturer, the EUT must comply with the requirements of the following standards:

ANSI C63.10-2013

The following reference test guidance is not within the scope of accreditation of A2LA:

KDB 558074 D01 15.247 Meas Guidance v05r02

KDB 662911 D01 Multiple Transmitter Output v02r01

2. SUMMARY OF TEST RESULTS

Test procedures according to the technical standard(s):

FCC CFR Title 47, Part 15, Subpart C				
Standard(s) Section	Test Item	Test Result	Judgment	Remark
15.207	AC Power Line Conducted Emissions	APPENDIX A	PASS	-----
15.247(d) 15.205(a) 15.209(a)	Radiated Emission	APPENDIX B	PASS	-----

Note:

- (1) "N/A" denotes test is not applicable in this test report.
- (2) The worst cases of AC power line conducted emissions and radiated emissions below 1GHz have been re-evaluated by sample of FCC ID: 2BCGWAP9665, model name: AP9665. It is found that the new data are the worse, so the test data are reissue from the FCC ID: 2BCGWAP9665, model name: AP9665. Model difference(s):
 1. Changed the signal transformer of the network port.
 2. Updated the power rating.
- (3) The other test records and results please refer to the test report number: eLab-FCCP-1-2308G050A, issued date is 2024-01-08, and issued by: Test Laboratory: eLab Inc.
Address: 10F., No. 167, Sec. 2, Datong Rd., Xizhi Dist., New Taipei City 221, Taiwan

Which was accredited by TAF, FCC registration number is 681248, with the scopes of cited standards in this test report.

This report is only valid conjunction with the above referenced test report.

2.1 TEST FACILITY

The test facilities used to collect the test data in this report is at the location of No.3, Jinshagang 1st Road, Dalang, Dongguan City, Guangdong People's Republic of China.

BTL's Registration Number for FCC: 747969

BTL's Designation Number for FCC: CN1377

2.2 MEASUREMENT UNCERTAINTY

ISO/IEC 17025 requires that an estimate of the measurement uncertainties associated with the emissions test results be included in the report. The measurement uncertainties given below are based on a 95.45% confidence level (based on a coverage factor (k=2))

The BTL measurement uncertainty as below table:

A. AC power line conducted emissions Measurement:

Test Site	Method	Measurement Frequency Range	U ,(dB)
DG-C02	CISPR	150kHz ~ 30MHz	2.88

B. Radiated emissions test:

Test Site	Method	Measurement Frequency Range	Ant. H / V	U ,(dB)
DG-CB03 (3m)	CISPR	30MHz ~ 200MHz	V	4.40
		30MHz ~ 200MHz	H	3.62
		200MHz ~ 1,000MHz	V	4.58
		200MHz ~ 1,000MHz	H	3.98

Note: Unless specifically mentioned, the uncertainty of measurement has not been taken into account to declare the compliance or non-compliance to the specification.

2.3 TEST ENVIRONMENT CONDITIONS

Test Item	Temperature	Humidity	Test Voltage	Tested By	Test Date
AC Power Line Conducted Emissions	25°C	58%	AC 120V/60Hz	Hayden Chen	May 31, 2024
Radiated Emissions -30MHz to 1000MHz	24°C	56%	AC 120V/60Hz	Jensen Zhou	May 31, 2024

3. GENERAL INFORMATION

3.1 GENERAL DESCRIPTION OF EUT

Equipment	AX3600 Ceiling Mount Wi-Fi 6 Access Point
Brand Name	tp-link
Test Model	AP9665
Series Model	N/A
Model Difference(s)	N/A
Power Source	1# DC Voltage supplied from AC adapter. (Support unit) 2# DC Voltage supplied from PoE adapter.(Support unit)
Power Rating	1# I/P: 100-240V~ 50/60Hz 0.8A O/P: 12.0V $\overline{=}$ 2.5A 2# 802.3bt PoE: 42.5-57V 1.2A
Operation Frequency	2402 MHz ~ 2480 MHz
Modulation Type	GFSK
Bit Rate of Transmitter	1Mbps

Note:

- For a more detailed features description, please refer to the manufacturer's specifications or the user's manual.

2. Channel List:

Channel	Frequency (MHz)	Channel	Frequency (MHz)
00	2402	20	2442
01	2404	21	2444
02	2406	22	2446
03	2408	23	2448
04	2410	24	2450
05	2412	25	2452
06	2414	26	2454
07	2416	27	2456
08	2418	28	2458
09	2420	29	2460
10	2422	30	2462
11	2424	31	2464
12	2426	32	2466
13	2428	33	2468
14	2430	34	2470
15	2432	35	2472
16	2434	36	2474
17	2436	37	2476
18	2438	38	2478
19	2440	39	2480

3. Table for Filed Antenna:

Brand Name	P/N	Type	Frequency (MHz)	Gain (dBi)
tp-link	EAP660-Ant1	PIFA	2400-2500	2

3.2 DESCRIPTION OF TEST MODES

The test system was pre-tested based on the consideration of all possible combinations of EUT operation mode.

Pretest Mode	Description
Mode 1	TX Mode_1Mbps Channel 19

Following mode(s) was (were) found to be the worst case(s) and selected for the final test.

AC power line conducted emissions test	
Final Test Mode	Description
Mode 1	TX Mode_1Mbps Channel 19

Radiated emissions test - Below 1GHz	
Final Test Mode	Description
Mode 1	TX Mode_1Mbps Channel 19

Note: The adapter supplied and PoE supplied are evaluated Wall mounted (vertical) and desktop (horizontal), the desktop (horizontal) and PoE supplied is the worst case and recorded in the test report.

3.3 BLOCK DIAGRAM SHOWING THE CONFIGURATION OF SYSTEM TESTED

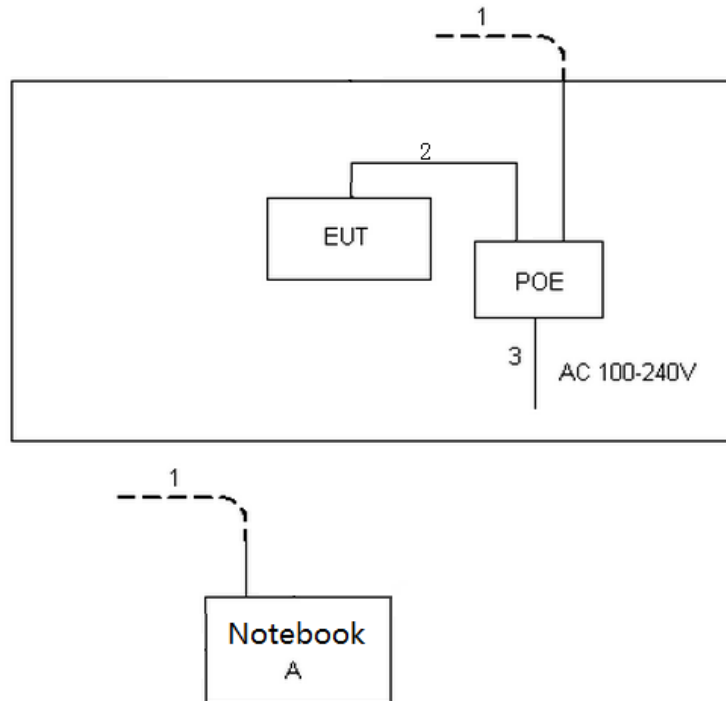

3.4 SUPPORT UNITS

Item	Equipment	Brand	Model No.	Series No.
A	Notebook	HUAWEI	WFH9	N/A

Item	Cable Type	Shielded Type	Ferrite Core	Length
1	RJ45 Cable	NO	NO	10m
2	RJ45 Cable	NO	NO	1m
3	AC Cable	NO	NO	1.5m

3.5 CUSTOMER INFORMATION DESCRIPTION

- 1) The antenna gain is provided by the manufacturer.

4. AC POWER LINE CONDUCTED EMISSIONS

4.1 LIMIT

Frequency of Emission (MHz)	Limit (dB μ V)	
	Quasi-peak	Average
0.15 - 0.5	66 to 56*	56 to 46*
0.5 - 5.0	56	46
5.0 - 30.0	60	50

Note:

- (1) The tighter limit applies at the band edges.
- (2) The limit of " * " marked band means the limitation decreases linearly with the logarithm of the frequency in the range.
- (3) The test result calculated as following:
 Measurement Value = Reading Level + Correct Factor
 Correct Factor = Insertion Loss + Cable Loss + Attenuator Factor (if use)
 Margin Level = Measurement Value – Limit Value

4.2 TEST PROCEDURE

- a. The EUT was placed 0.8 meters from the horizontal ground plane with EUT being connected to the power mains through a line impedance stabilization network (LISN). All other support equipment powered from additional LISN(s). The LISN provide 50 Ohm/ 50uH of coupling impedance for the measuring instrument.
- b. Interconnecting cables that hang closer than 40 cm to the ground plane shall be folded back and forth in the center forming a bundle 30 to 40 cm long.
- c. I/O cables that are not connected to a peripheral shall be bundled in the center. The end of the cable may be terminated, if required, using the correct terminating impedance. The overall length shall not exceed 1 m.
- d. LISN at least 80 cm from nearest part of EUT chassis.
- e. For the actual test configuration, please refer to the related Item –EUT Test Photos.

The following table is the setting of the receiver:

Receiver Parameters	Setting
Start Frequency	0.15 MHz
Stop Frequency	30 MHz
IF Bandwidth	9 kHz

4.3 DEVIATION FROM TEST STANDARD

No deviation.

4.4 TEST SETUP

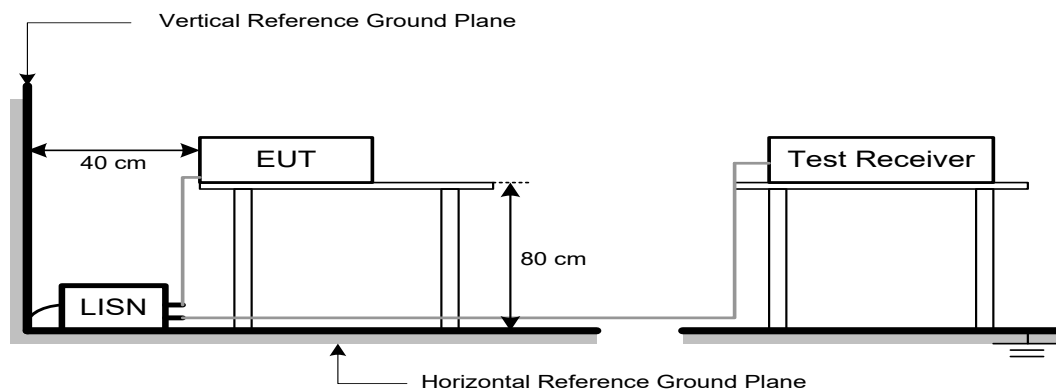

4.5 EUT OPERATING CONDITIONS

The EUT was configured for testing in a typical fashion (as a customer would normally use it). The EUT has been programmed to continuously transmit during test. This operating condition was tested and used to collect the included data.

4.6 TEST RESULTS

Please refer to the APPENDIX A.

Remark:

- (1) All readings are QP Mode value unless otherwise stated AVG in column of 『Note』 . If the QP Mode Measured value compliance with the QP Limits and lower than AVG Limits, the EUT shall be deemed to meet both QP & AVG Limits and then only QP Mode was measured, but AVG Mode didn't perform. In this case, a “*” marked in AVG Mode column of Interference Voltage Measured.
- (2) Measuring frequency range from 150 kHz to 30 MHz.

5. RADIATED EMISSIONS

5.1 LIMIT

In case the emission fall within the restricted band specified on 15.205(a), then the 15.209(a) limit in the table below has to be followed.

LIMITS OF RADIATED EMISSION MEASUREMENT (30 MHz-1000 MHz)

Frequency (MHz)	Field Strength ($\mu\text{V}/\text{m}$ at 3m)
30-88	100
88-216	150
216-960	200
Above 960	500

Note:

- (1) The limit for radiated test was performed according to FCC CFR Title 47, Part 15, Subpart C.
- (2) The tighter limit applies at the band edges.
- (3) Emission level (dBuV/m)=20log Emission level (uV/m).
- (4) The test result calculated as following:
 Measurement Value = Reading Level + Correct Factor
 Correct Factor = Antenna Factor + Cable Loss - Amplifier Gain(if use)
 Margin Level = Measurement Value - Limit Value

5.2 TEST PROCEDURE

- a. The measuring distance of 3 m shall be used for measurements. The EUT was placed on the top of a rotating table 0.8 meter above the ground at a 3 meter semi-anechoic chamber. The table was rotated 360 degrees to determine the position of the highest radiation.(below 1 GHz)
- b. The height of the equipment or of the substitution antenna shall be 0.8m or 1.5m; the height of the test antenna shall vary between 1 m to 4 m. Both horizontal and vertical polarizations of the antenna are set to make the measurement.
- c. For each suspected emission, the EUT was arranged to its worst case and then the antenna was tuned to heights find the maximum reading (used Bore sight function).
- d. The initial step in collecting radiated emission data is a receiver peak detector mode pre-scanning the measurement frequency range. Significant peaks are then marked and then Quasi Peak detector mode re-measured.
- e. All readings are Peak unless otherwise stated QP in column of Note. Peak denotes that the Peak reading compliance with the QP Limits and then QP Mode measurement didn't perform. (below 1 GHz)
- f. For the actual test configuration, please refer to the related Item -EUT Test Photos.

The following table is the setting of the receiver:

Spectrum Parameters	Setting
Start ~ Stop Frequency	30 MHz~1000 MHz for RBW 100 kHz

Receiver Parameters	Setting
Start ~ Stop Frequency	30 MHz~1000 MHz for QP detector

5.3 DEVIATION FROM TEST STANDARD

No deviation.

5.4 TEST SETUP

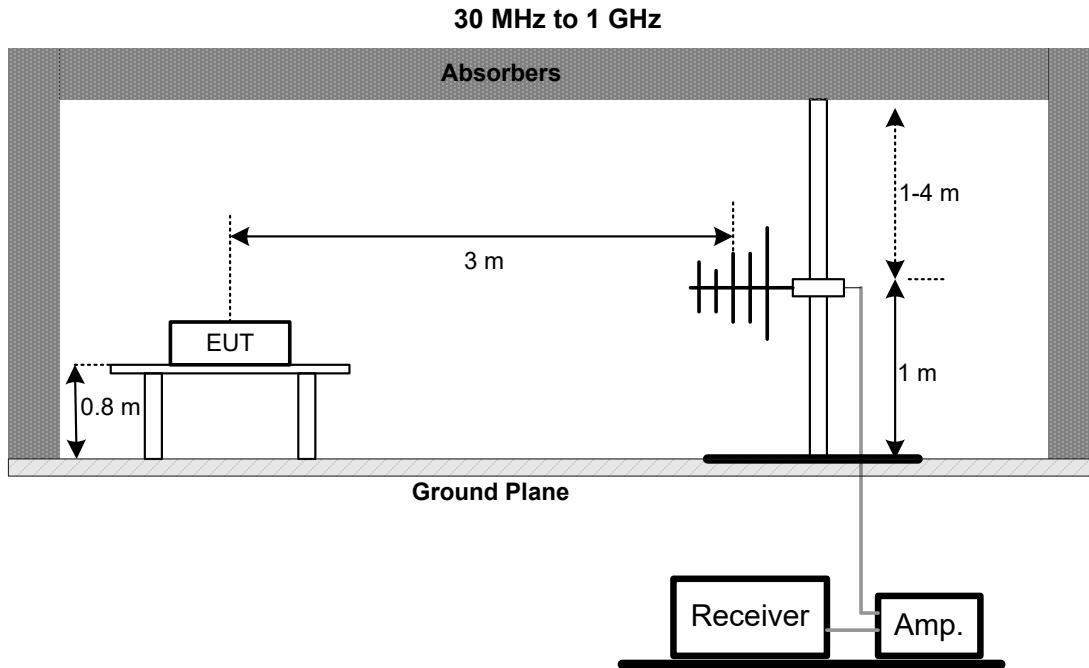

5.5 EUT OPERATING CONDITIONS

The EUT was programmed to be in continuously transmitting mode.

5.6 TEST RESULTS - 30 MHZ TO 1000 MHZ

Please refer to the APPENDIX B.

6. MEASUREMENT INSTRUMENTS LIST

AC Power Line Conducted Emissions					
Item	Kind of Equipment	Manufacturer	Type No.	Serial No.	Calibrated until
1	EMI Test Receiver	R&S	ESR3	103027	Jun. 16, 2024
2	TWO-LINE V-NETWORK	R&S	ENV216	101447	Dec. 22, 2024
3	Measurement Software	Farad	EZ-EMC Ver.NB-03A1-01	N/A	N/A
4	Cable	N/A	SFT205-NMNM-9M-001	9M	Nov. 27, 2024

Radiated Emissions - 30 MHz to 1 GHz					
Item	Kind of Equipment	Manufacturer	Type No.	Serial No.	Calibrated until
1	Trilog-Broadband Antenna	Schwarzbeck	VULB 9168	1462	Dec. 13, 2024
2	Attenuator	EMC INSTRUMENT	EMCI-N-6-06	AT-06009	Dec. 13, 2024
3	Preamplifier	EMC INSTRUMENT	EMC001330	980863	Apr. 07, 2025
4	Cable	RegalWay	LMR400-NMNM-12.5m	N/A	N/A
5	Cable	RegalWay	LMR400-NMNM-3m	N/A	N/A
6	Cable	RegalWay	LMR400-NMNM-0.5m	N/A	N/A
7	Receiver	Agilent	N9038A	MY52130039	Dec. 22, 2024
8	Positioning Controller	MF	MF-7802	N/A	N/A
9	Measurement Software	Farad	EZ-EMC Ver.NB-03A1-01	N/A	N/A
10	966 Chamber room	CM	9*6*6	N/A	May 16, 2025

Remark "N/A" denotes no model name, serial no. or calibration specified.

All calibration period of equipment list is one year.

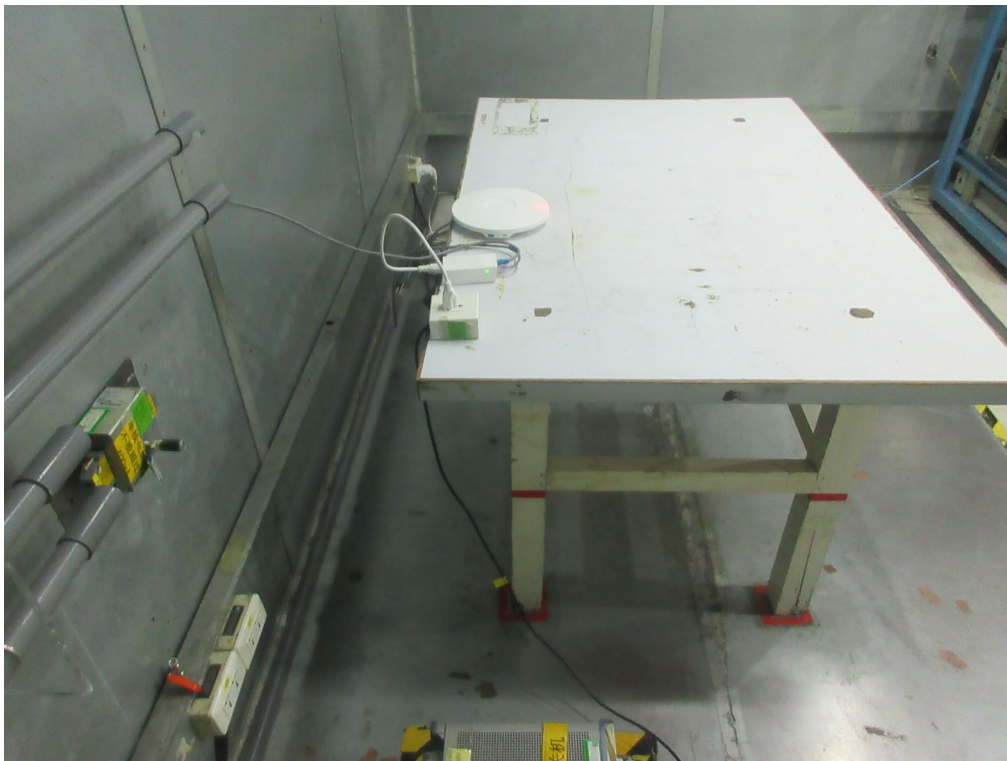
7. EUT TEST PHOTO**AC Power Line Conducted Emissions Test Photos**

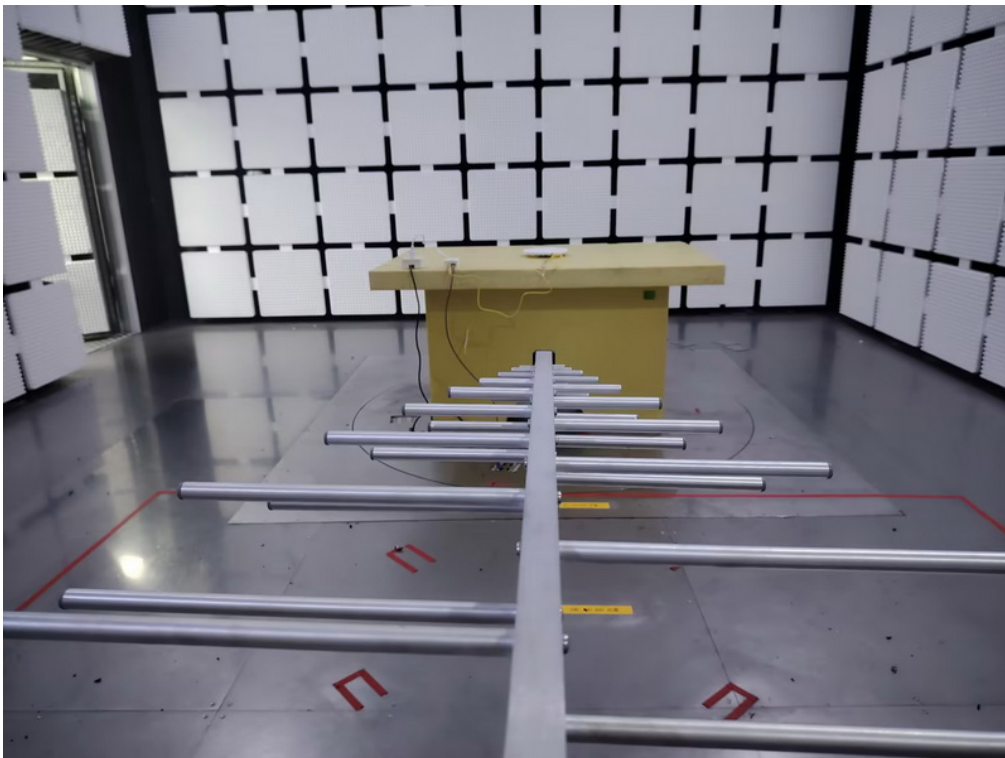
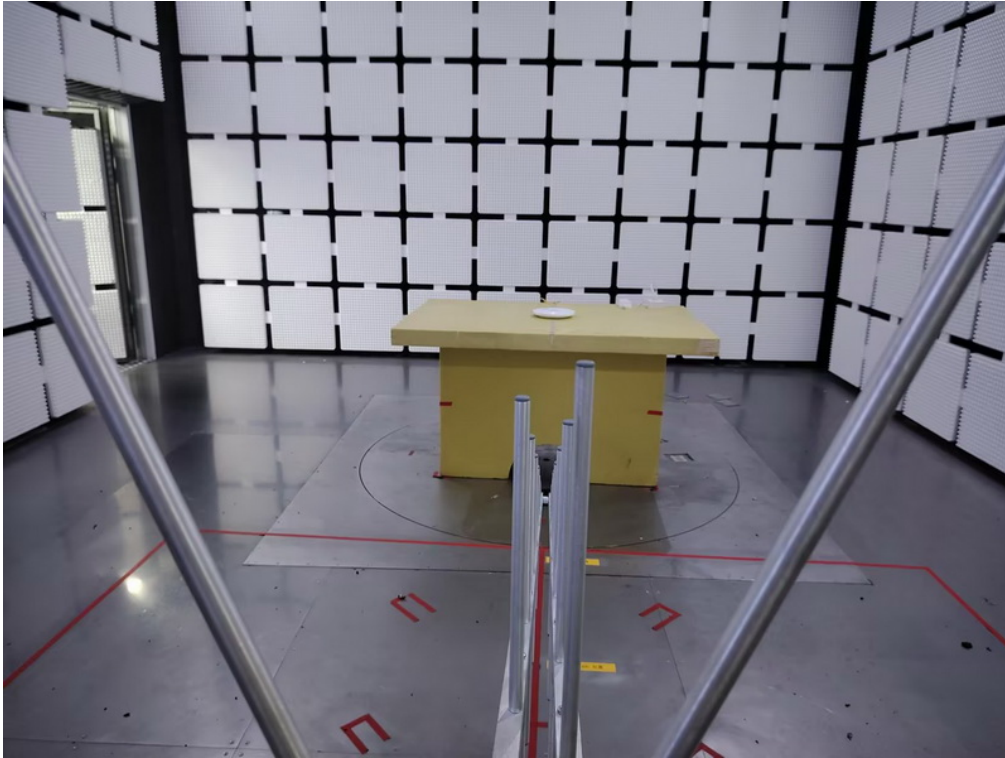
Radiated Emissions Test Photos**30 MHz to 1 GHz**

APPENDIX A - AC POWER LINE CONDUCTED EMISSIONS

Test Mode	TX Mode_1Mbps Channel 19	Phase	Line
-----------	--------------------------	-------	------



No.	Mk.	Freq. MHz	Reading Level dBuV	Correct Factor dB	Measure- ment dBuV	Limit dBuV	Margin dB	Detector	Comment
1		0.1635	45.60	9.74	55.34	65.28	-9.94	QP	
2		0.1635	36.70	9.74	46.44	55.28	-8.84	AVG	
3		0.1973	39.90	9.74	49.64	63.72	-14.08	QP	
4		0.1973	30.80	9.74	40.54	53.72	-13.18	AVG	
5		0.2647	41.72	9.76	51.48	61.28	-9.80	QP	
6		0.2647	32.50	9.76	42.26	51.28	-9.02	AVG	
7		0.3952	37.10	9.77	46.87	57.95	-11.08	QP	
8		0.3952	28.70	9.77	38.47	47.95	-9.48	AVG	
9		3.7725	37.50	9.94	47.44	56.00	-8.56	QP	
10		3.7725	28.10	9.94	38.04	46.00	-7.96	AVG	
11		27.1140	43.90	10.62	54.52	60.00	-5.48	QP	
12	*	27.1140	39.20	10.62	49.82	50.00	-0.18	AVG	

REMARKS:

- (1) Measurement Value = Reading Level + Correct Factor.
- (2) Margin Level = Measurement Value - Limit Value.

Test Mode	TX Mode_1Mbps Channel 19	Phase	Neutral
-----------	--------------------------	-------	---------

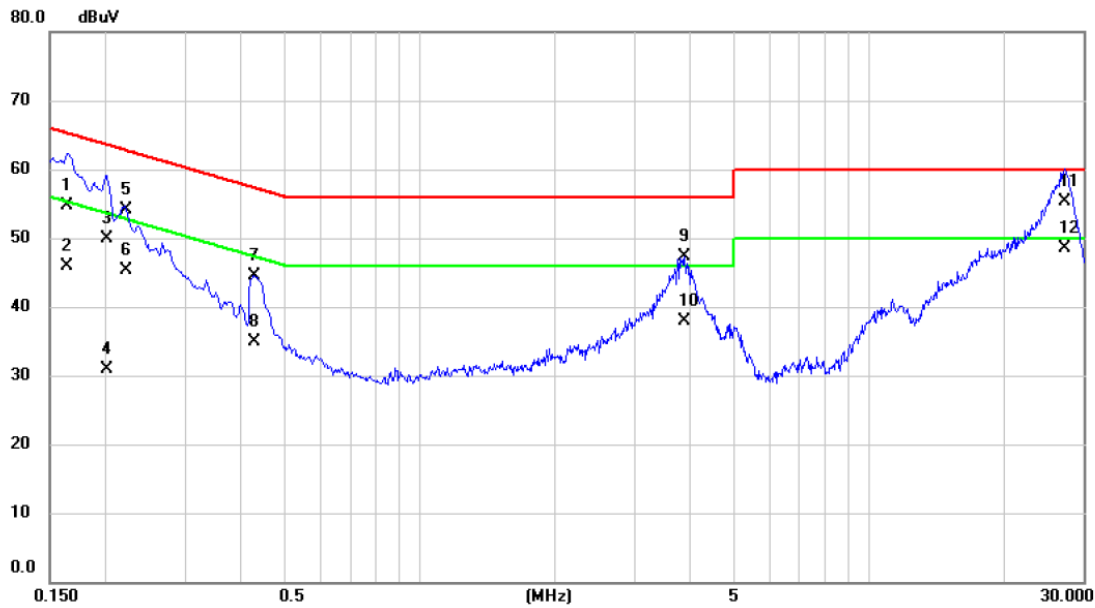

No.	Mk.	Freq. MHz	Reading Level dBuV	Correct Factor dB	Measure- ment dBuV	Limit dBuV	Margin dB	Detector	Comment
1		0.1635	45.20	9.59	54.79	65.28	-10.49	QP	
2		0.1635	36.30	9.59	45.89	55.28	-9.39	AVG	
3		0.2017	40.30	9.60	49.90	63.54	-13.64	QP	
4		0.2017	21.40	9.60	31.00	53.54	-22.54	AVG	
5		0.2220	44.59	9.60	54.19	62.74	-8.55	QP	
6		0.2220	35.70	9.60	45.30	52.74	-7.44	AVG	
7		0.4290	34.91	9.64	44.55	57.27	-12.72	QP	
8		0.4290	25.20	9.64	34.84	47.27	-12.43	AVG	
9		3.8828	37.43	9.80	47.23	56.00	-8.77	QP	
10		3.8828	28.10	9.80	37.90	46.00	-8.10	AVG	
11		27.3548	44.80	10.51	55.31	60.00	-4.69	QP	
12	*	27.3548	37.90	10.51	48.41	50.00	-1.59	AVG	

REMARKS:

- (1) Measurement Value = Reading Level + Correct Factor.
- (2) Margin Level = Measurement Value - Limit Value.

APPENDIX B - RADIATED EMISSION - 30 MHZ TO 1000 MHZ

Test Mode	TX Mode_1Mbps Channel 19	Polarization	Vertical
-----------	--------------------------	--------------	----------

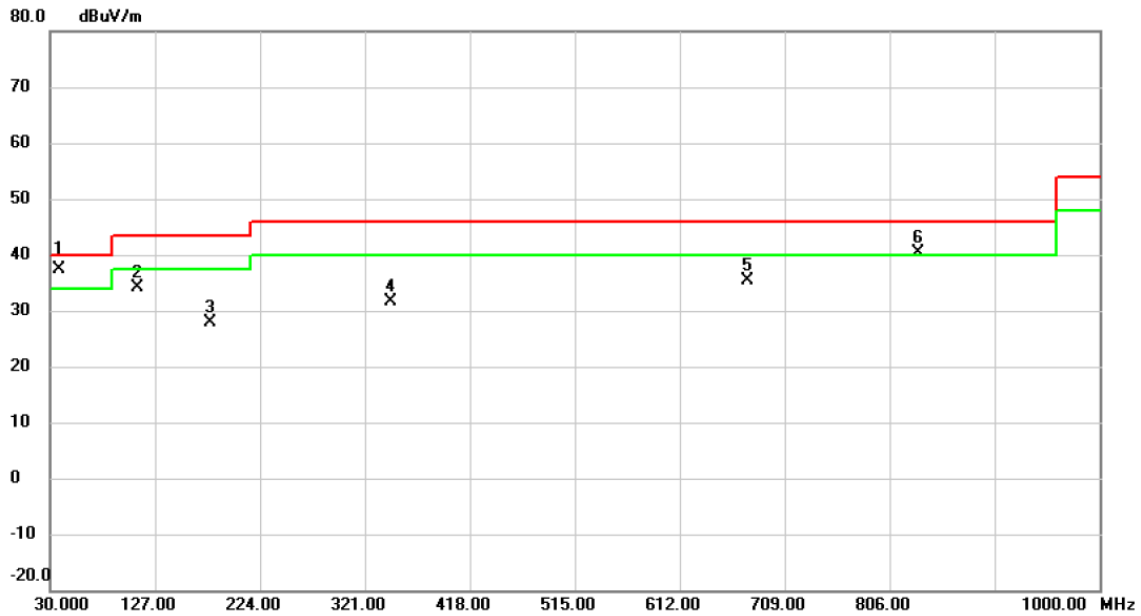

No.	Mk.	Freq.	Reading Level	Correct Factor	Measurement	Limit	Margin	Detector	Comment
		MHz	dBuV	dB	dBuV/m	dBuV/m	dB		
1	*	38.000	49.34	-12.02	37.32	40.00	-2.68	QP	
2		110.453	48.43	-14.21	34.22	43.50	-9.28	peak	
3		178.097	39.98	-12.05	27.93	43.50	-15.57	peak	
4		345.457	41.04	-9.43	31.61	46.00	-14.39	peak	
5		674.659	37.90	-2.59	35.31	46.00	-10.69	peak	
6	!	832.541	41.21	-0.78	40.43	46.00	-5.57	peak	

REMARKS:

- (1) Measurement Value = Reading Level + Correct Factor.
- (2) Margin Level = Measurement Value - Limit Value.

Test Mode	TX Mode_1Mbps Channel 19	Polarization	Horizontal
-----------	--------------------------	--------------	------------

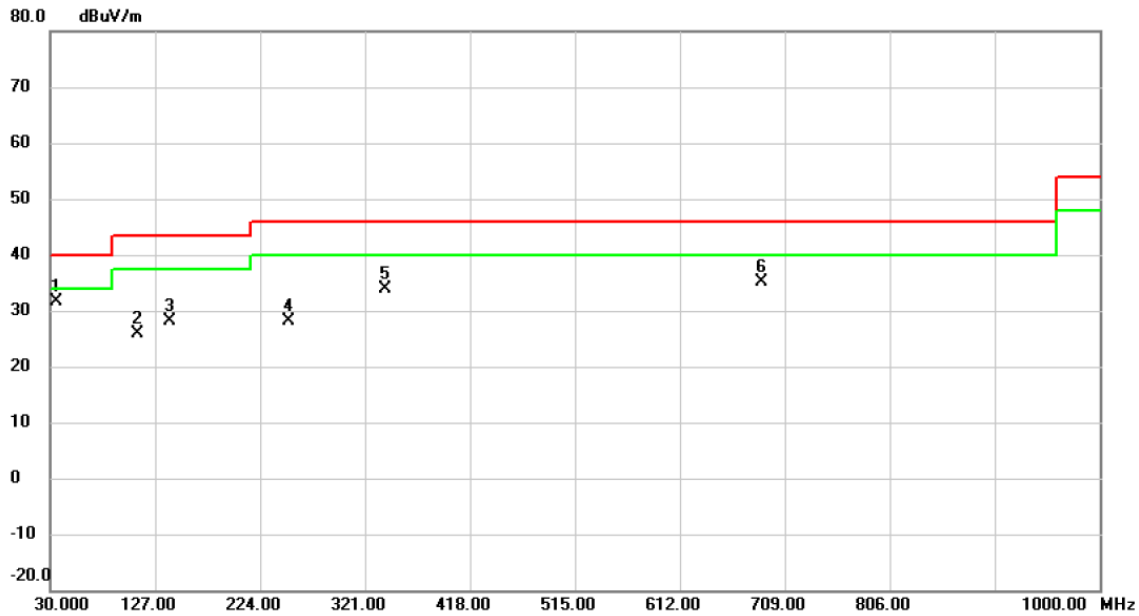

No.	Mk.	Freq.	Reading Level	Correct Factor	Measurement	Limit	Margin	Detector	Comment
		MHz	dBuV	dB	dBuV/m	dBuV/m	dB		
1	*	36.110	43.98	-12.23	31.75	40.00	-8.25	peak	
2		110.453	40.06	-14.21	25.85	43.50	-17.65	peak	
3		141.089	39.65	-11.63	28.02	43.50	-15.48	peak	
4		250.243	40.43	-12.31	28.12	46.00	-17.88	peak	
5		340.309	43.43	-9.48	33.95	46.00	-12.05	peak	
6		688.099	37.69	-2.45	35.24	46.00	-10.76	peak	

REMARKS:

- (1) Measurement Value = Reading Level + Correct Factor.
- (2) Margin Level = Measurement Value - Limit Value

End of Test Report