

EUT	AX1800 Indoor/Outdoor Wi-Fi Access Point	Date of Test	2023-09-22
Factor	DRH18-E	Temp. / Humidity	20°C /60%
Polarity	Horizontal	Site / Test Engineer	AC2 / Stanley
Test Mode	802.11a_TX_Band2_CH 60_ANT 0+1	Test Voltage	AC 120V/60Hz

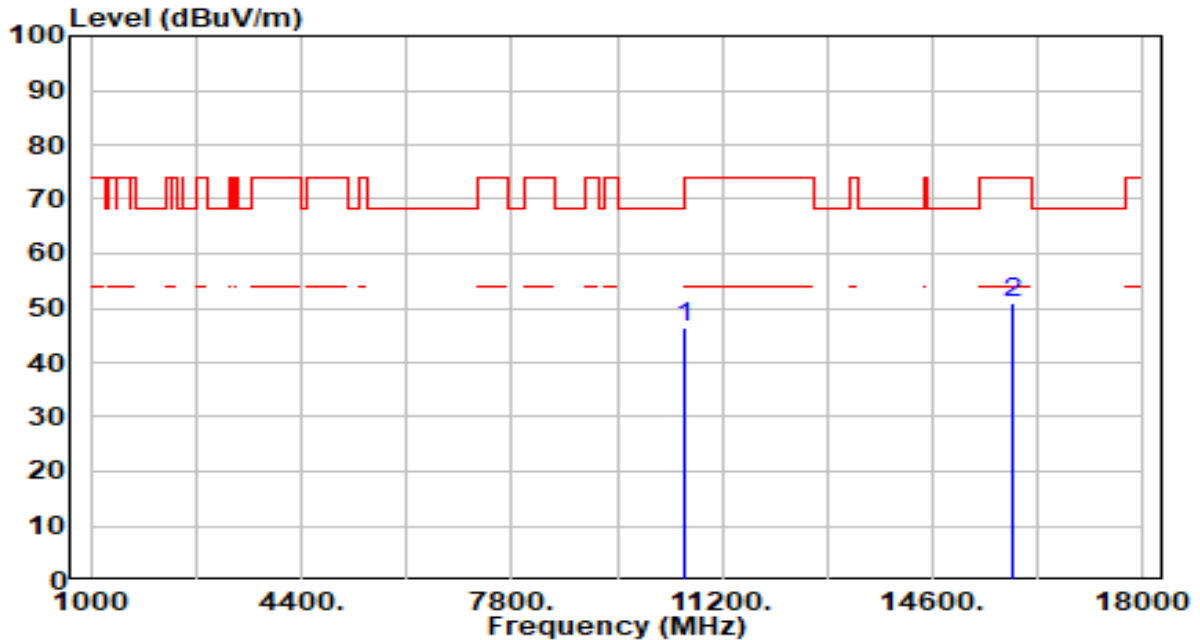

No	Frequency (MHz)	Reading (dBuV)	C.F (dB/m)	Measurement (dBuV/m)	Margin (dB)	Limit (dBuV/m)	Height (cm)	Angle (deg)	Remark (QP/PK/AV)
1	* 10600.000	43.97	2.60	46.57	-21.63	68.20	300	338	Peak
2	15900.000	46.00	5.13	51.13	-22.87	74.00	300	123	Peak

Note:

1. " *", means this data is the worst emission level.
2. C.F (Correction Factor) = Antenna Factor (dB/m)+ Cable Loss (dB) – Preamplifier(dB).
3. Measurement (dBuV/m) = Reading(dBuV) + C.F (Correction Factor).
4. The emission levels of other frequencies are very lower than the limit and not show in test report.

EUT	AX1800 Indoor/Outdoor Wi-Fi Access Point	Date of Test	2023-09-22
Factor	DRH18-E	Temp. / Humidity	20°C /60%
Polarity	Vertical	Site / Test Engineer	AC2 / Stanley
Test Mode	802.11a_TX_Band2_CH 60_ANT 0+1	Test Voltage	AC 120V/60Hz

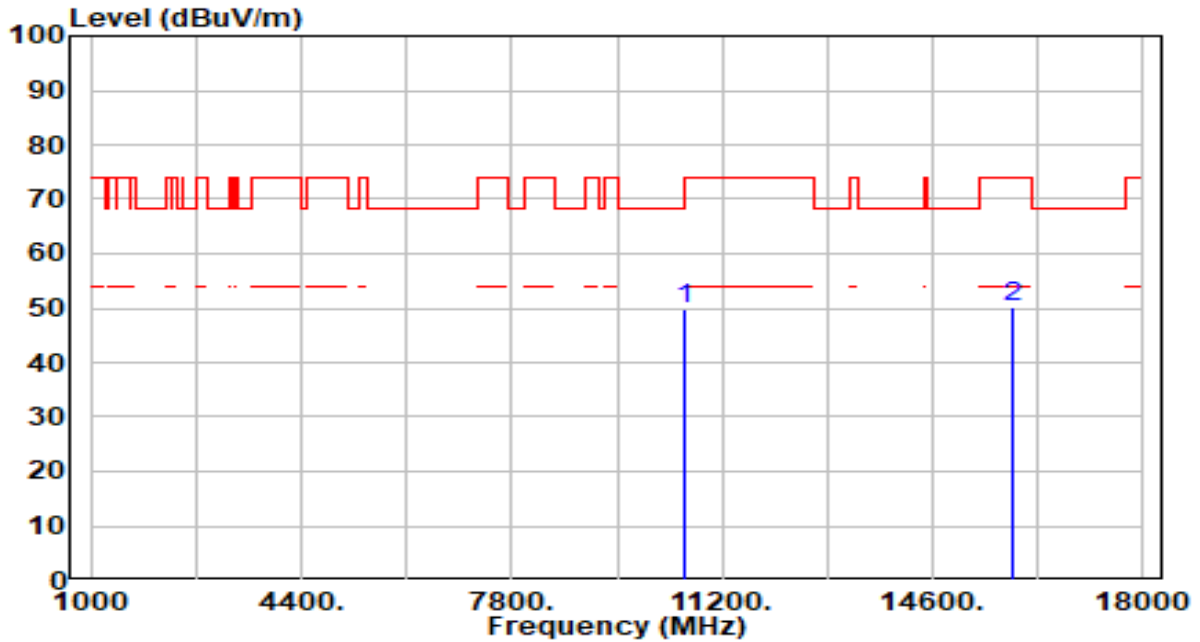

No	Frequency (MHz)	Reading (dBuV)	C.F (dB/m)	Measurement (dBuV/m)	Margin (dB)	Limit (dBuV/m)	Height (cm)	Angle (deg)	Remark (QP/PK/AV)
1	* 10600.000	47.40	2.60	50.00	-18.20	68.20	300	13	Peak
2	15900.000	44.90	5.13	50.03	-23.97	74.00	300	0	Peak

Note:

1. " *", means this data is the worst emission level.
2. C.F (Correction Factor) = Antenna Factor (dB/m)+ Cable Loss (dB) – Preamplifier(dB).
3. Measurement (dBuV/m) = Reading(dBuV) + C.F (Correction Factor).
4. The emission levels of other frequencies are very lower than the limit and not show in test report.

EUT	AX1800 Indoor/Outdoor Wi-Fi Access Point	Date of Test	2023-09-22
Factor	DRH18-E	Temp. / Humidity	20°C /60%
Polarity	Horizontal	Site / Test Engineer	AC2 / Stanley
Test Mode	802.11a_TX_Band2_CH 64_ANT 0+1	Test Voltage	AC 120V/60Hz

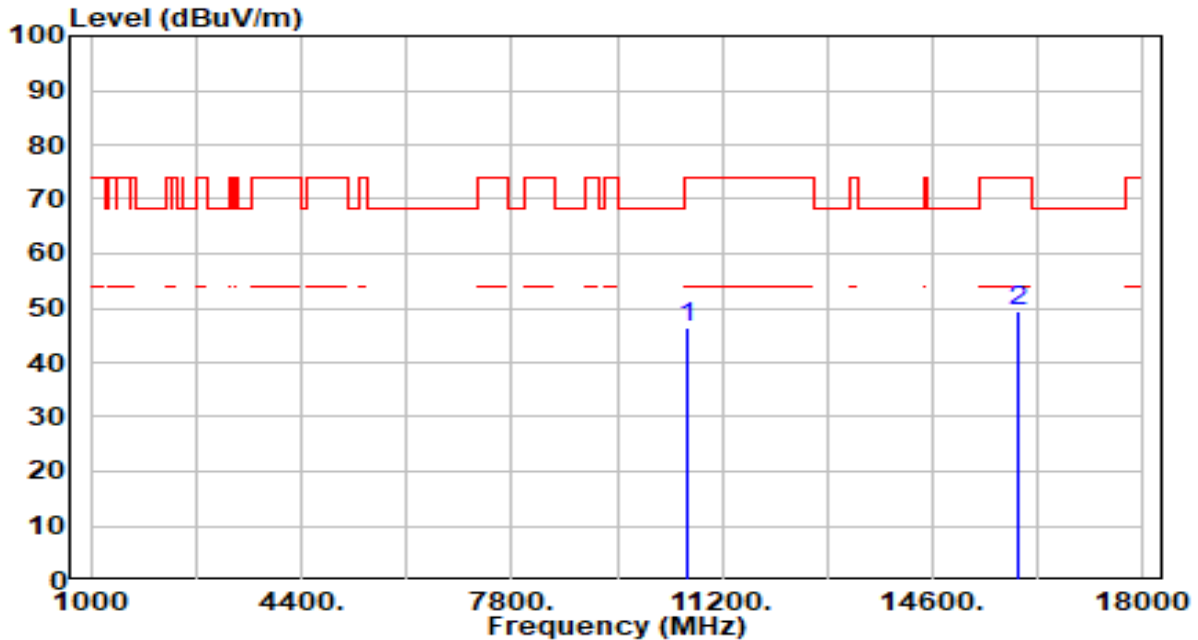

No	Frequency (MHz)	Reading (dBUV)	C.F (dB/m)	Measurement (dBUV/m)	Margin (dB)	Limit (dBUV/m)	Height (cm)	Angle (deg)	Remark (QP/PK/AV)
1	10640.000	43.61	2.62	46.23	-27.77	74.00	300	312	Peak
2	* 15960.000	44.12	5.17	49.29	-24.71	74.00	300	238	Peak

Note:

1. " *", means this data is the worst emission level.
2. C.F (Correction Factor) = Antenna Factor (dB/m)+ Cable Loss (dB) – Preamplifier(dB).
3. Measurement (dBUV/m) = Reading(dBUV) + C.F (Correction Factor).
4. The emission levels of other frequencies are very lower than the limit and not show in test report.

EUT	AX1800 Indoor/Outdoor Wi-Fi Access Point	Date of Test	2023-09-22
Factor	DRH18-E	Temp. / Humidity	20°C /60%
Polarity	Vertical	Site / Test Engineer	AC2 / Stanley
Test Mode	802.11a_TX_Band2_CH 64_ANT 0+1	Test Voltage	AC 120V/60Hz

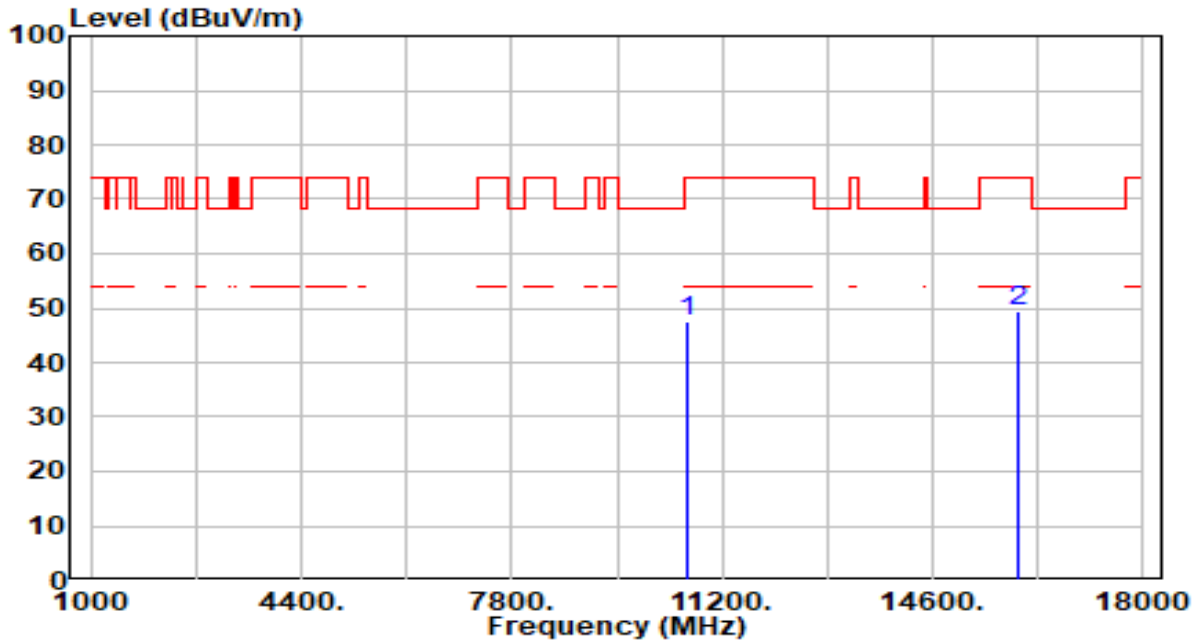

No	Frequency (MHz)	Reading (dBuV)	C.F (dB/m)	Measurement (dBuV/m)	Margin (dB)	Limit (dBuV/m)	Height (cm)	Angle (deg)	Remark (QP/PK/AV)
1	10640.000	44.92	2.62	47.54	-26.46	74.00	300	360	Peak
2	* 15960.000	44.12	5.17	49.29	-24.71	74.00	300	150	Peak

Note:

1. " *", means this data is the worst emission level.
2. C.F (Correction Factor) = Antenna Factor (dB/m)+ Cable Loss (dB) – Preamplifier(dB).
3. Measurement (dBuV/m) = Reading(dBuV) + C.F (Correction Factor).
4. The emission levels of other frequencies are very lower than the limit and not show in test report.

EUT	AX1800 Indoor/Outdoor Wi-Fi Access Point	Date of Test	2023-09-22
Factor	DRH18-E	Temp. / Humidity	20°C /60%
Polarity	Horizontal	Site / Test Engineer	AC2 / Stanley
Test Mode	802.11a_TX_Band3_CH 100_ANT 0+1	Test Voltage	AC 120V/60Hz

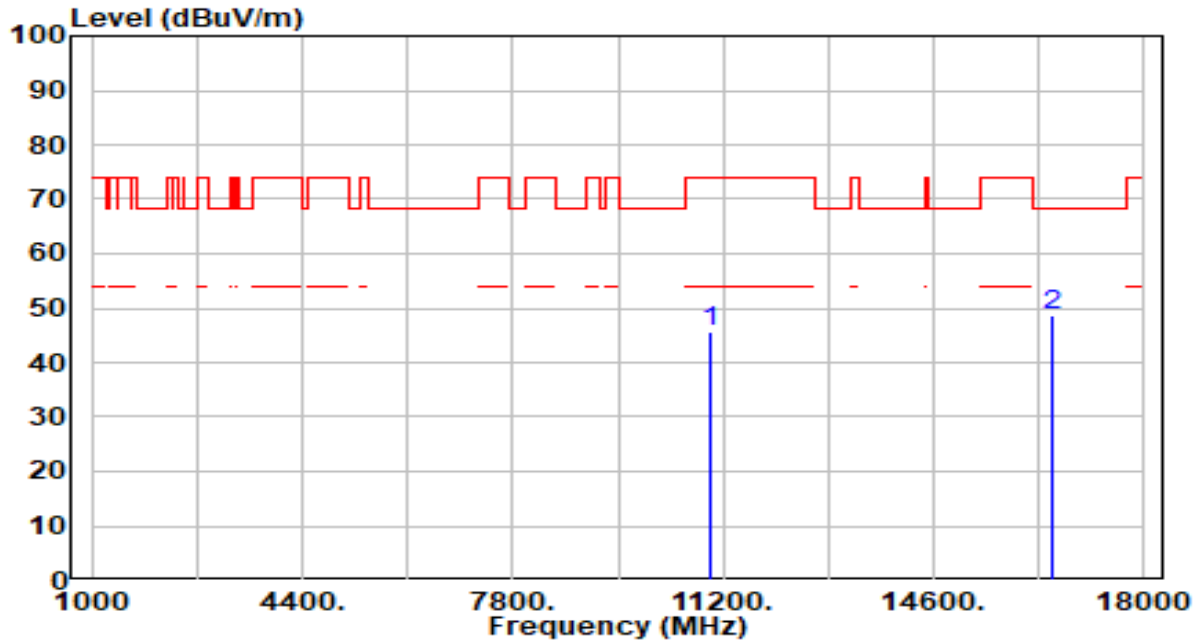

No	Frequency (MHz)	Reading (dBUV)	C.F (dB/m)	Measurement (dBUV/m)	Margin (dB)	Limit (dBUV/m)	Height (cm)	Angle (deg)	Remark (QP/PK/AV)
1	11000.000	42.96	2.60	45.56	-28.44	74.00	300	0	Peak
2	* 16500.000	44.07	4.63	48.70	-19.50	68.20	300	169	Peak

Note:

1. " *", means this data is the worst emission level.
2. C.F (Correction Factor) = Antenna Factor (dB/m)+ Cable Loss (dB) – Preamplifier(dB).
3. Measurement (dBUV/m) = Reading(dBUV) + C.F (Correction Factor).
4. The emission levels of other frequencies are very lower than the limit and not show in test report.

EUT	AX1800 Indoor/Outdoor Wi-Fi Access Point	Date of Test	2023-09-22
Factor	DRH18-E	Temp. / Humidity	20°C /60%
Polarity	Vertical	Site / Test Engineer	AC2 / Stanley
Test Mode	802.11a_TX_Band3_CH 100_ANT 0+1	Test Voltage	AC 120V/60Hz

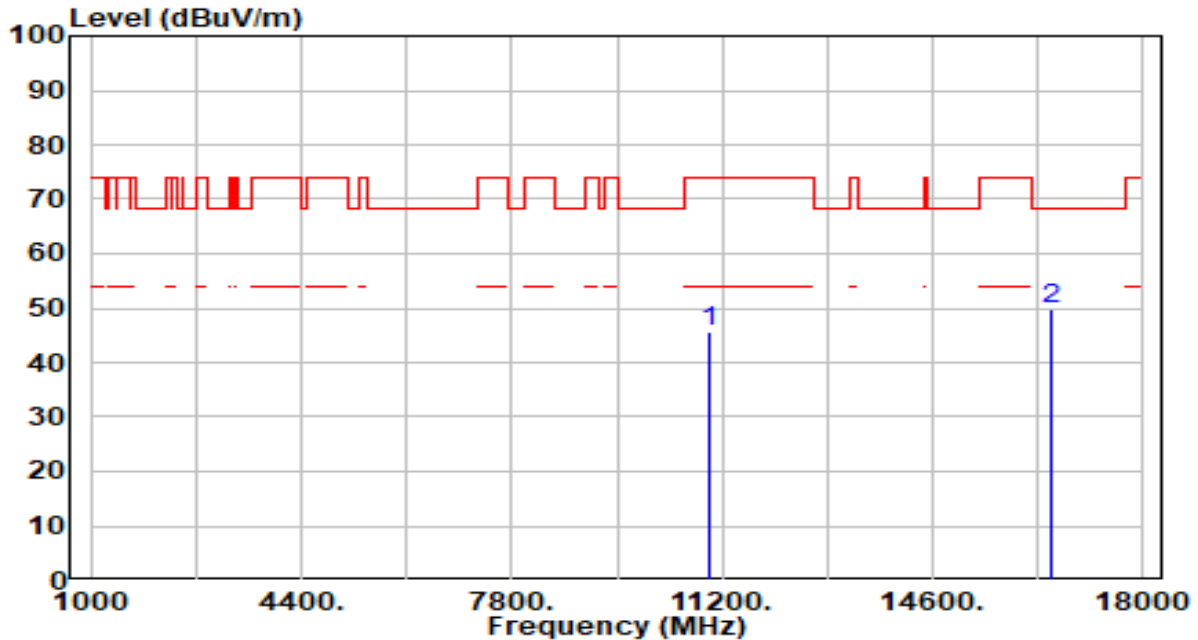

No	Frequency (MHz)	Reading (dBUV)	C.F (dB/m)	Measurement (dBUV/m)	Margin (dB)	Limit (dBUV/m)	Height (cm)	Angle (deg)	Remark (QP/PK/AV)
1	11000.000	43.12	2.60	45.72	-28.28	74.00	300	268	Peak
2	* 16500.000	45.18	4.63	49.81	-18.39	68.20	300	49	Peak

Note:

1. " *", means this data is the worst emission level.
2. C.F (Correction Factor) = Antenna Factor (dB/m)+ Cable Loss (dB) – Preamplifier(dB).
3. Measurement (dBUV/m) = Reading(dBUV) + C.F (Correction Factor).
4. The emission levels of other frequencies are very lower than the limit and not show in test report.

EUT	AX1800 Indoor/Outdoor Wi-Fi Access Point	Date of Test	2023-09-22
Factor	DRH18-E	Temp. / Humidity	20°C /60%
Polarity	Horizontal	Site / Test Engineer	AC2 / Stanley
Test Mode	802.11a_TX_Band3_CH 116_ANT 0+1	Test Voltage	AC 120V/60Hz

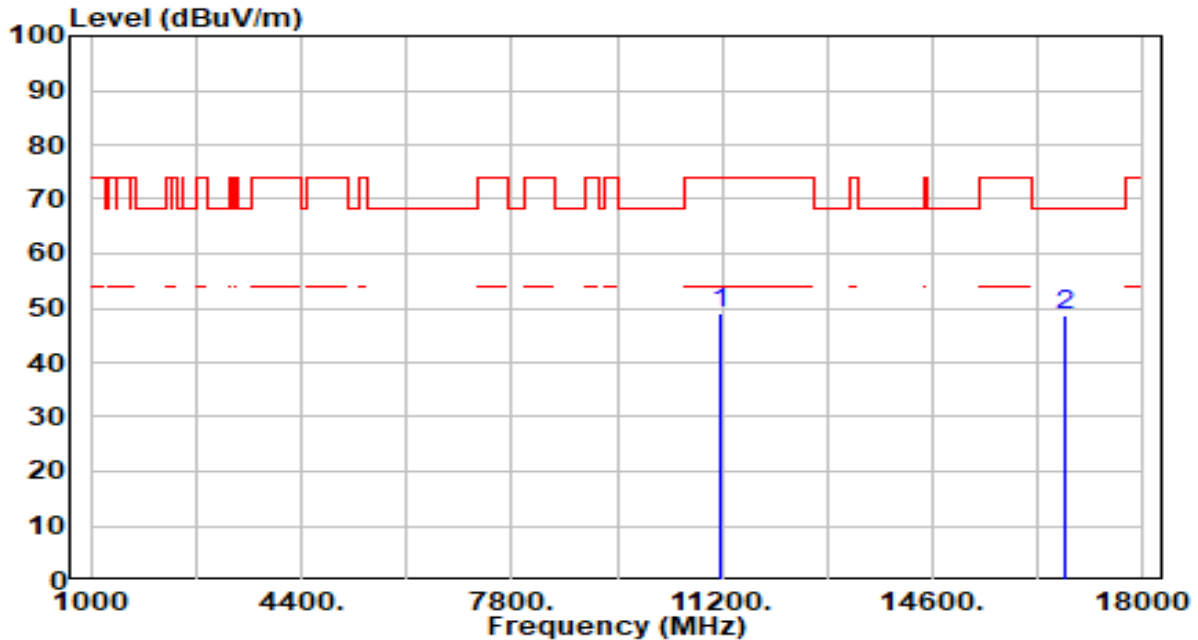

No	Frequency (MHz)	Reading (dBUV)	C.F (dB/m)	Measurement (dBUV/m)	Margin (dB)	Limit (dBUV/m)	Height (cm)	Angle (deg)	Remark (QP/PK/AV)
1	11160.000	46.02	3.07	49.09	-24.91	74.00	300	40	Peak
2	* 16740.000	43.84	4.66	48.50	-19.70	68.20	300	329	Peak

Note:

1. " *", means this data is the worst emission level.
2. C.F (Correction Factor) = Antenna Factor (dB/m)+ Cable Loss (dB) – Preamplifier(dB).
3. Measurement (dBUV/m) = Reading(dBUV) + C.F (Correction Factor).
4. The emission levels of other frequencies are very lower than the limit and not show in test report.

EUT	AX1800 Indoor/Outdoor Wi-Fi Access Point	Date of Test	2023-09-22
Factor	DRH18-E	Temp. / Humidity	20°C /60%
Polarity	Vertical	Site / Test Engineer	AC2 / Stanley
Test Mode	802.11a_TX_Band3_CH 116_ANT 0+1	Test Voltage	AC 120V/60Hz

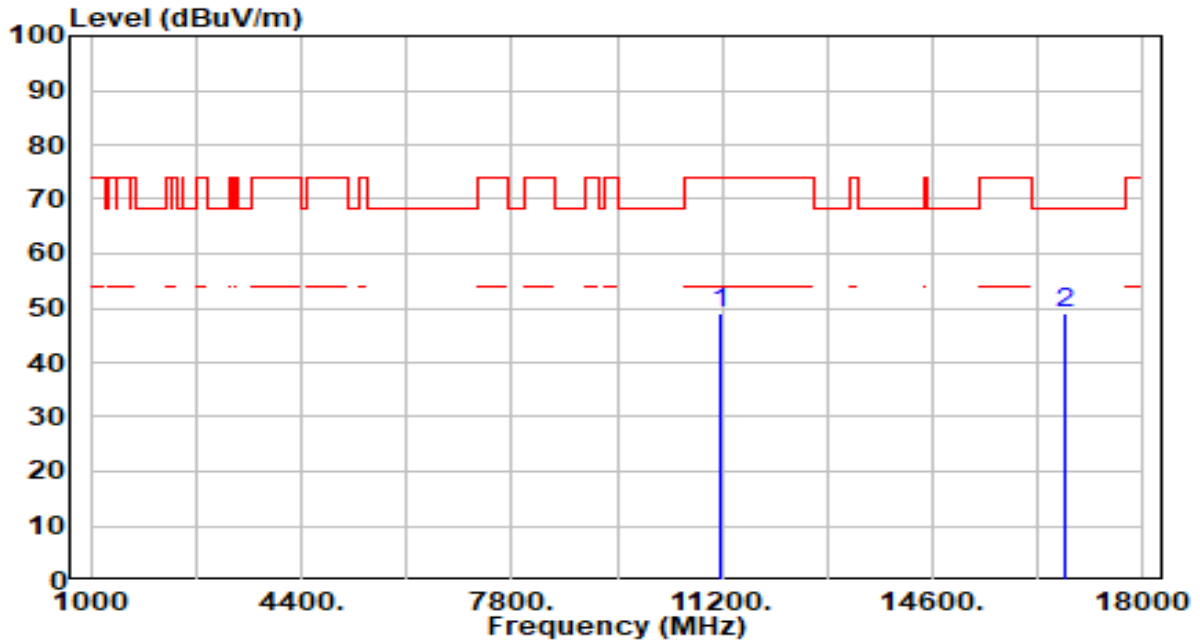

No	Frequency (MHz)	Reading (dBUV)	C.F (dB/m)	Measurement (dBUV/m)	Margin (dB)	Limit (dBUV/m)	Height (cm)	Angle (deg)	Remark (QP/PK/AV)
1	11160.000	45.83	3.07	48.90	-25.10	74.00	300	11	Peak
2	* 16740.000	44.51	4.66	49.18	-19.02	68.20	300	360	Peak

Note:

1. " *", means this data is the worst emission level.
2. C.F (Correction Factor) = Antenna Factor (dB/m)+ Cable Loss (dB) – Preamplifier(dB).
3. Measurement (dBUV/m) = Reading(dBUV) + C.F (Correction Factor).
4. The emission levels of other frequencies are very lower than the limit and not show in test report.

EUT	AX1800 Indoor/Outdoor Wi-Fi Access Point	Date of Test	2023-09-22
Factor	DRH18-E	Temp. / Humidity	20°C /60%
Polarity	Horizontal	Site / Test Engineer	AC2 / Stanley
Test Mode	802.11a_TX_Band3_CH 140_ANT 0+1	Test Voltage	AC 120V/60Hz

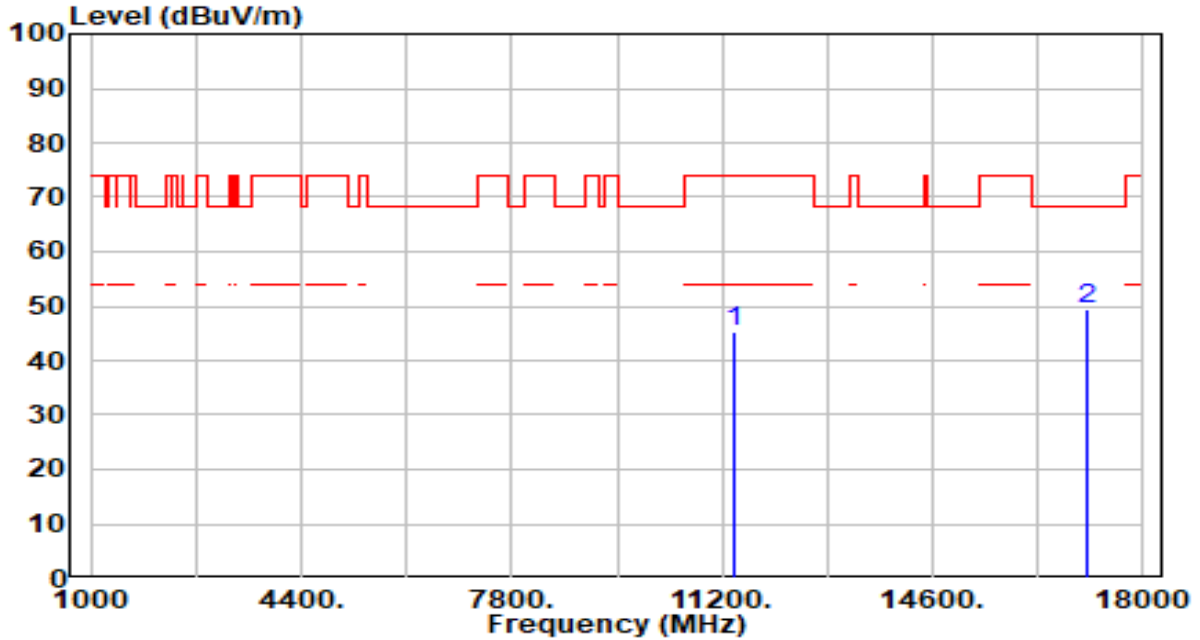

No	Frequency (MHz)	Reading (dBUV)	C.F (dB/m)	Measurement (dBUV/m)	Margin (dB)	Limit (dBUV/m)	Height (cm)	Angle (deg)	Remark (QP/PK/AV)
1	11400.000	41.90	3.48	45.38	-28.62	74.00	300	360	Peak
2	* 17100.000	44.49	4.79	49.28	-18.92	68.20	300	272	Peak

Note:

1. " *", means this data is the worst emission level.
2. C.F (Correction Factor) = Antenna Factor (dB/m)+ Cable Loss (dB) – Preamplifier(dB).
3. Measurement (dBUV/m) = Reading(dBUV) + C.F (Correction Factor).
4. The emission levels of other frequencies are very lower than the limit and not show in test report.

EUT	AX1800 Indoor/Outdoor Wi-Fi Access Point	Date of Test	2023-09-22
Factor	DRH18-E	Temp. / Humidity	20°C /60%
Polarity	Vertical	Site / Test Engineer	AC2 / Stanley
Test Mode	802.11a_TX_Band3_CH 140_ANT 0+1	Test Voltage	AC 120V/60Hz

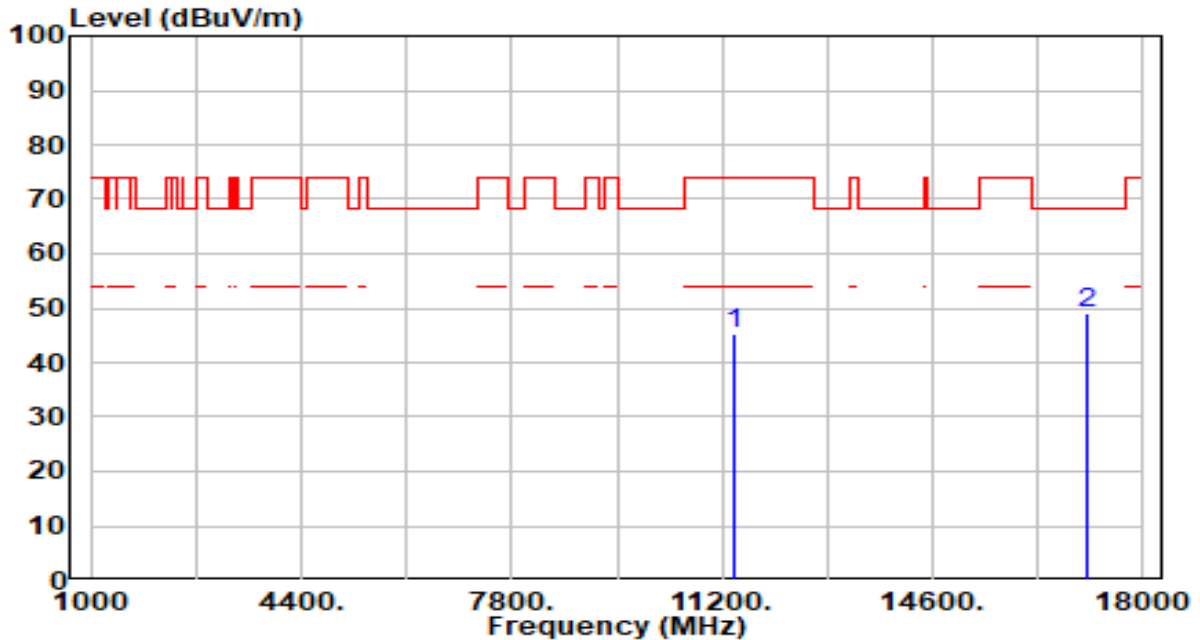

No	Frequency (MHz)	Reading (dBUV)	C.F (dB/m)	Measurement (dBUV/m)	Margin (dB)	Limit (dBUV/m)	Height (cm)	Angle (deg)	Remark (QP/PK/AV)
1	11400.000	41.98	3.48	45.46	-28.54	74.00	300	360	Peak
2	* 17100.000	44.38	4.79	49.17	-19.03	68.20	300	226	Peak

Note:

1. " *", means this data is the worst emission level.
2. C.F (Correction Factor) = Antenna Factor (dB/m)+ Cable Loss (dB) – Preamplifier(dB).
3. Measurement (dBUV/m) = Reading(dBUV) + C.F (Correction Factor).
4. The emission levels of other frequencies are very lower than the limit and not show in test report.

EUT	AX1800 Indoor/Outdoor Wi-Fi Access Point	Date of Test	2023-09-22
Factor	DRH18-E	Temp. / Humidity	20°C /60%
Polarity	Horizontal	Site / Test Engineer	AC2 / Stanley
Test Mode	802.11a_TX_Band3_CH 144_ANT 0+1	Test Voltage	AC 120V/60Hz

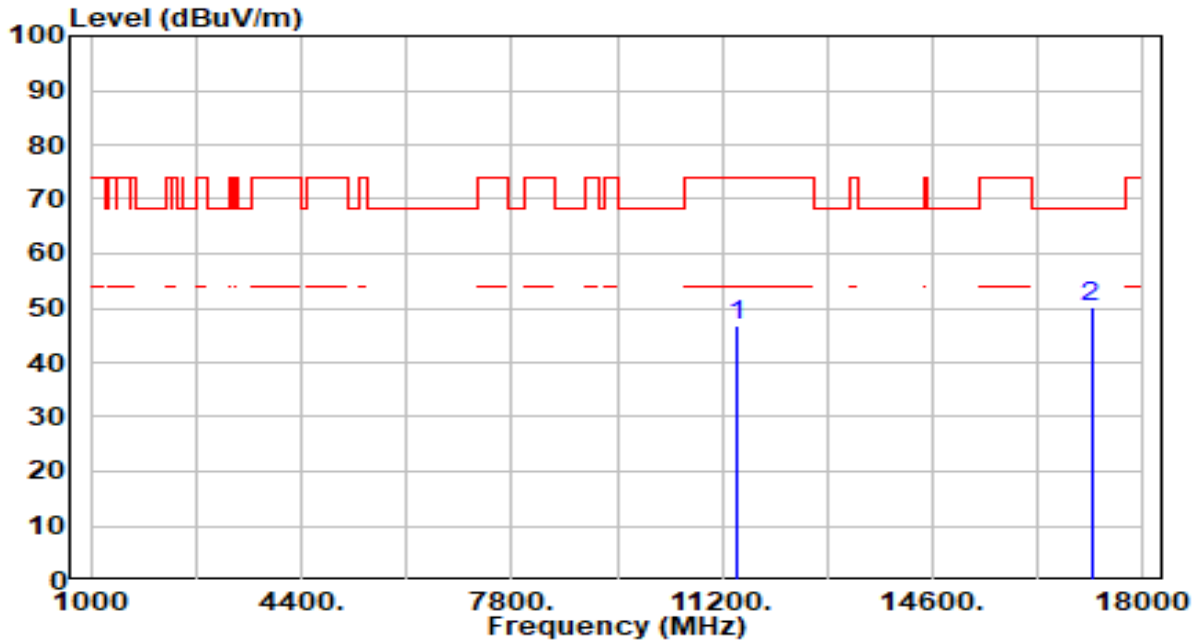

No	Frequency (MHz)	Reading (dBUV)	C.F (dB/m)	Measurement (dBUV/m)	Margin (dB)	Limit (dBUV/m)	Height (cm)	Angle (deg)	Remark (QP/PK/AV)
1	11440.000	43.13	3.52	46.65	-27.35	74.00	300	43	Peak
2	* 17160.000	45.48	4.66	50.13	-18.07	68.20	300	329	Peak

Note:

1. " *", means this data is the worst emission level.
2. C.F (Correction Factor) = Antenna Factor (dB/m)+ Cable Loss (dB) – Preamplifier(dB).
3. Measurement (dBUV/m) = Reading(dBUV) + C.F (Correction Factor).
4. The emission levels of other frequencies are very lower than the limit and not show in test report.

EUT	AX1800 Indoor/Outdoor Wi-Fi Access Point	Date of Test	2023-09-22
Factor	DRH18-E	Temp. / Humidity	20°C /60%
Polarity	Vertical	Site / Test Engineer	AC2 / Stanley
Test Mode	802.11a_TX_Band3_CH 144_ANT 0+1	Test Voltage	AC 120V/60Hz

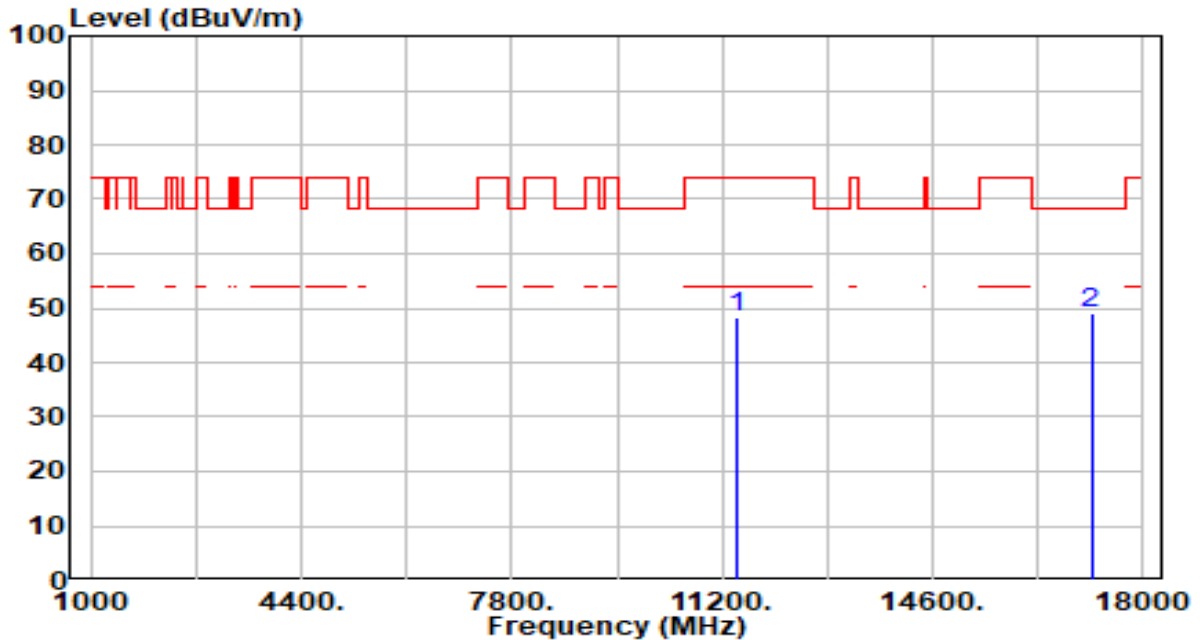

No	Frequency (MHz)	Reading (dBUV)	C.F (dB/m)	Measurement (dBUV/m)	Margin (dB)	Limit (dBUV/m)	Height (cm)	Angle (deg)	Remark (QP/PK/AV)
1	11440.000	44.84	3.52	48.36	-25.64	74.00	300	360	Peak
2	* 17160.000	44.27	4.66	48.93	-19.27	68.20	300	343	Peak

Note:

1. " *", means this data is the worst emission level.
2. C.F (Correction Factor) = Antenna Factor (dB/m)+ Cable Loss (dB) – Preamplifier(dB).
3. Measurement (dBUV/m) = Reading(dBUV) + C.F (Correction Factor).
4. The emission levels of other frequencies are very lower than the limit and not show in test report.

EUT	AX1800 Indoor/Outdoor Wi-Fi Access Point	Date of Test	2023-09-22
Factor	DRH18-E	Temp. / Humidity	20°C /60%
Polarity	Horizontal	Site / Test Engineer	AC2 / Stanley
Test Mode	802.11a_TX_Band4_CH 149_ANT 0+1	Test Voltage	AC 120V/60Hz

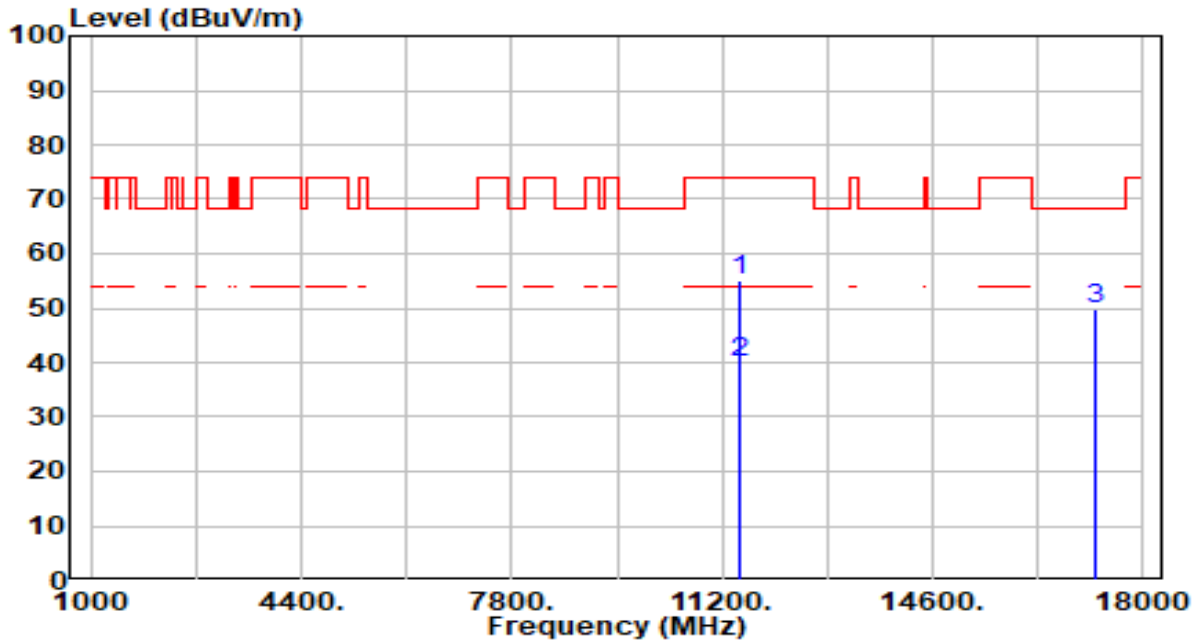

No	Frequency (MHz)	Reading (dBUV)	C.F (dB/m)	Measurement (dBUV/m)	Margin (dB)	Limit (dBUV/m)	Height (cm)	Angle (deg)	Remark (QP/PK/AV)
1	11490.000	51.35	3.57	54.92	-19.08	74.00	300	338	Peak
2	* 11490.000	36.50	3.57	40.07	-13.93	54.00	300	338	Average
3	* 17235.000	45.47	4.45	49.93	-18.27	68.20	100	316	Peak

Note:

- "*", means this data is the worst emission level.
- C.F (Correction Factor) = Antenna Factor (dB/m)+ Cable Loss (dB) – Pre-amplifier(dB).
- Measurement (dBUV/m) = Reading(dBUV) + C.F (Correction Factor).
- The emission levels of other frequencies are very lower than the limit and not show in test report.

EUT	AX1800 Indoor/Outdoor Wi-Fi Access Point	Date of Test	2023-09-22
Factor	DRH18-E	Temp. / Humidity	20°C /60%
Polarity	Vertical	Site / Test Engineer	AC2 / Stanley
Test Mode	802.11a_TX_Band4_CH 149_ANT 0+1	Test Voltage	AC 120V/60Hz

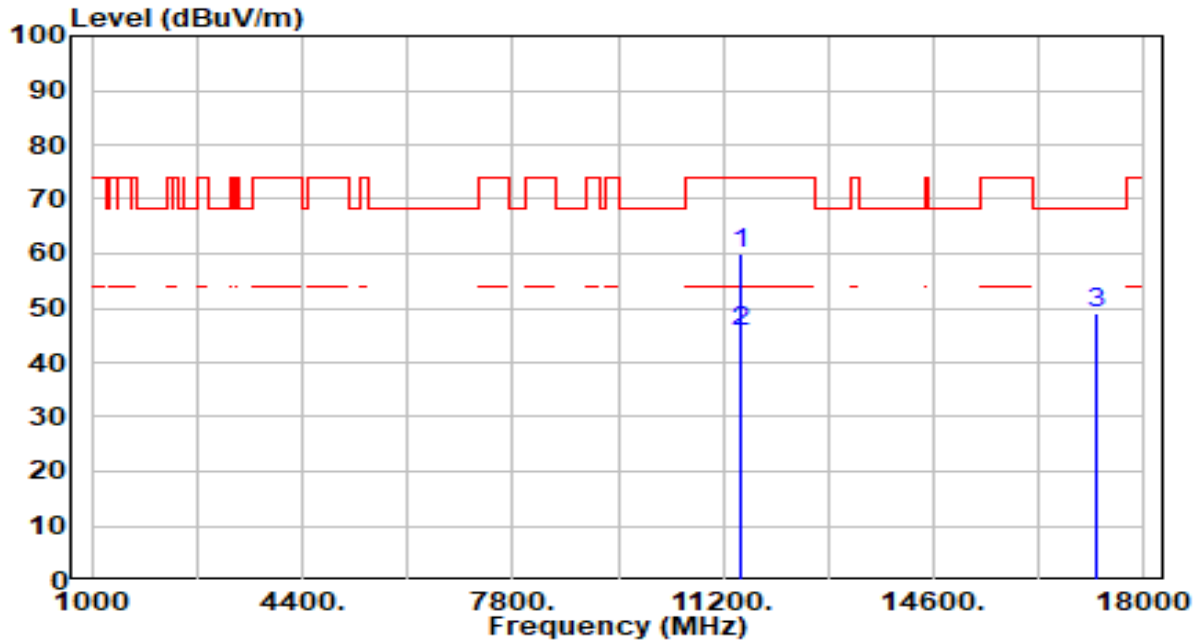

No	Frequency (MHz)	Reading (dBUV)	C.F (dB/m)	Measurement (dBUV/m)	Margin (dB)	Limit (dBUV/m)	Height (cm)	Angle (deg)	Remark (QP/PK/AV)
1	* 11490.000	56.62	3.57	60.19	-13.81	74.00	300	10	Peak
2	* 11490.000	42.03	3.57	45.60	-8.40	54.00	300	10	Average
3	17235.000	44.68	4.45	49.13	-19.07	68.20	100	166	Peak

Note:

1. " *", means this data is the worst emission level.
2. C.F (Correction Factor) = Antenna Factor (dB/m)+ Cable Loss (dB) – Preamplifier(dB).
3. Measurement (dBUV/m) = Reading(dBUV) + C.F (Correction Factor).
4. The emission levels of other frequencies are very lower than the limit and not show in test report.

EUT	AX1800 Indoor/Outdoor Wi-Fi Access Point	Date of Test	2023-09-22
Factor	DRH18-E	Temp. / Humidity	20°C /60%
Polarity	Horizontal	Site / Test Engineer	AC2 / Stanley
Test Mode	802.11a_TX_Band4_CH 157_ANT 0+1	Test Voltage	AC 120V/60Hz

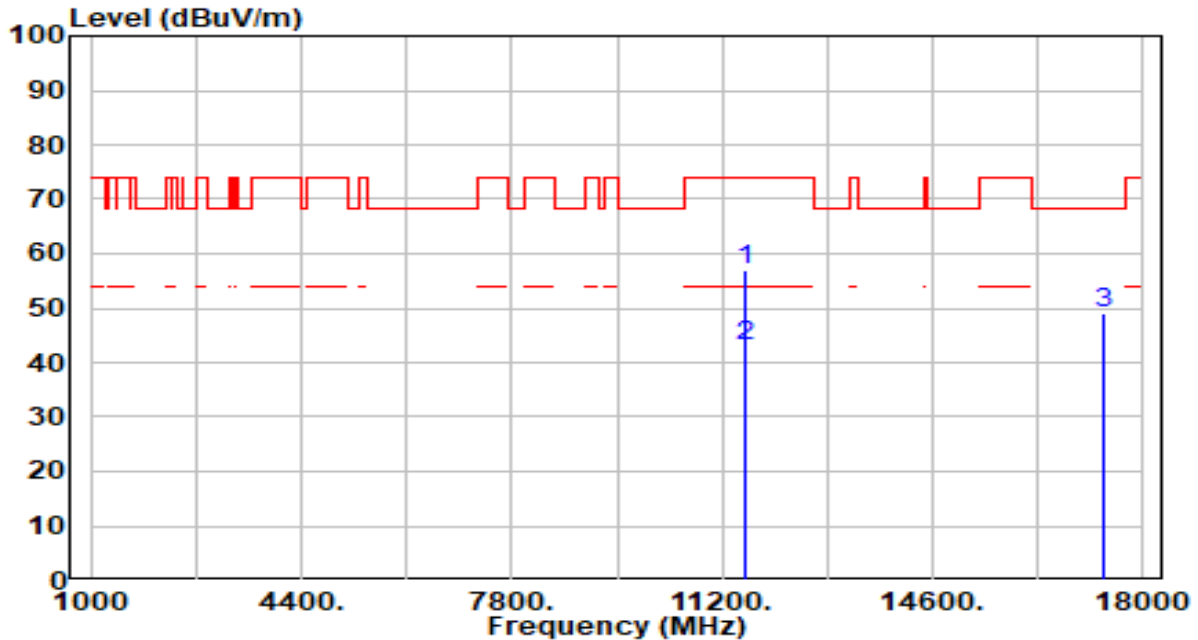

No	Frequency (MHz)	Reading (dBUV)	C.F (dB/m)	Measurement (dBUV/m)	Margin (dB)	Limit (dBUV/m)	Height (cm)	Angle (deg)	Remark (QP/PK/AV)
1	* 11570.000	53.27	3.65	56.92	-17.08	74.00	300	331	Peak
2	* 11570.000	39.33	3.65	42.98	-11.02	54.00	300	331	Average
3	17355.000	44.83	4.06	48.89	-19.31	68.20	300	121	Peak

Note:

1. " *", means this data is the worst emission level.
2. C.F (Correction Factor) = Antenna Factor (dB/m)+ Cable Loss (dB) – Preamplifier(dB).
3. Measurement (dBUV/m) = Reading(dBUV) + C.F (Correction Factor).
4. The emission levels of other frequencies are very lower than the limit and not show in test report.

EUT	AX1800 Indoor/Outdoor Wi-Fi Access Point	Date of Test	2023-09-22
Factor	DRH18-E	Temp. / Humidity	20°C /60%
Polarity	Vertical	Site / Test Engineer	AC2 / Stanley
Test Mode	802.11a_TX_Band4_CH 157_ANT 0+1	Test Voltage	AC 120V/60Hz

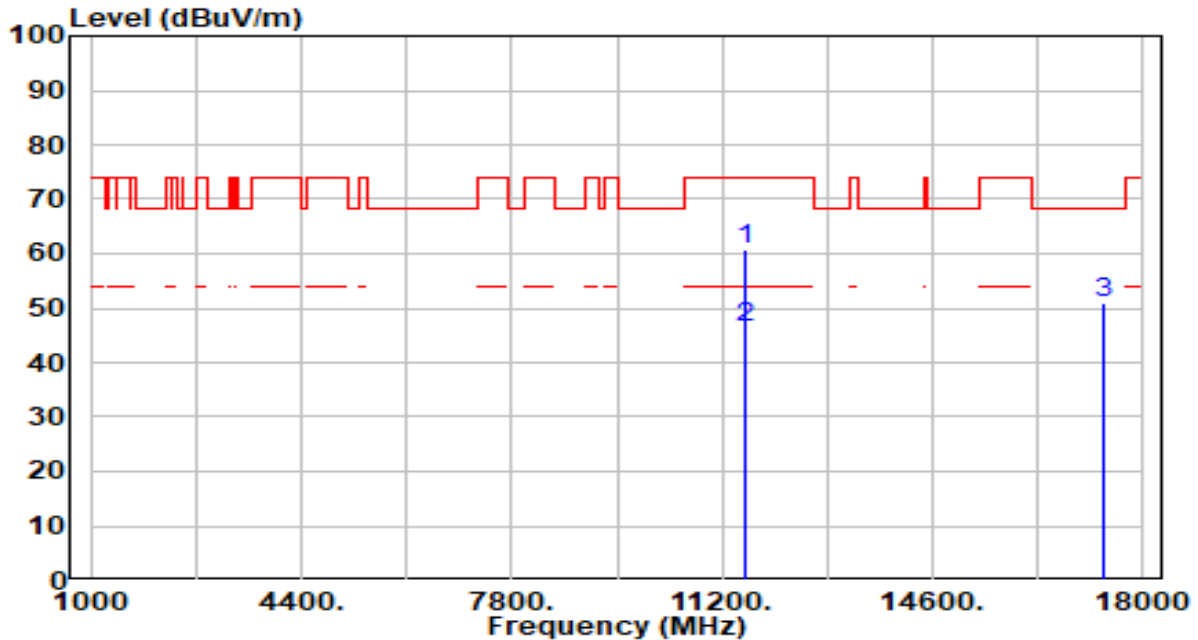

No	Frequency (MHz)	Reading (dBuV)	C.F (dB/m)	Measurement (dBuV/m)	Margin (dB)	Limit (dBuV/m)	Height (cm)	Angle (deg)	Remark (QP/PK/AV)
1	* 11570.000	57.13	3.65	60.78	-13.22	74.00	300	2	Peak
2	* 11570.000	42.83	3.65	46.48	-7.52	54.00	300	2	Average
3	17355.000	46.83	4.06	50.89	-17.31	68.20	300	48	Peak

Note:

1. " *", means this data is the worst emission level.
2. C.F (Correction Factor) = Antenna Factor (dB/m)+ Cable Loss (dB) – Pre-amplifier(dB).
3. Measurement (dBuV/m) = Reading(dBuV) + C.F (Correction Factor).
4. The emission levels of other frequencies are very lower than the limit and not show in test report.

EUT	AX1800 Indoor/Outdoor Wi-Fi Access Point	Date of Test	2023-09-22
Factor	DRH18-E	Temp. / Humidity	20°C /60%
Polarity	Horizontal	Site / Test Engineer	AC2 / Stanley
Test Mode	802.11a_TX_Band4_CH 165_ANT 0+1	Test Voltage	AC 120V/60Hz

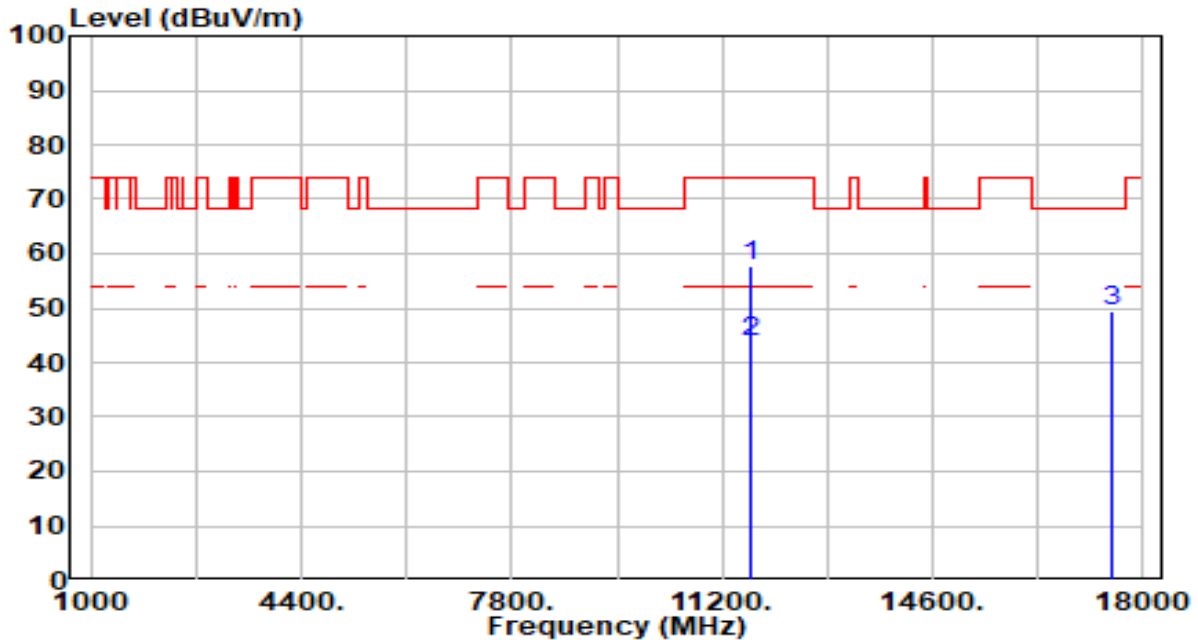

No	Frequency (MHz)	Reading (dBUV)	C.F (dB/m)	Measurement (dBUV/m)	Margin (dB)	Limit (dBUV/m)	Height (cm)	Angle (deg)	Remark (QP/PK/AV)
1	* 11650.000	54.03	3.66	57.69	-16.31	74.00	300	330	Peak
2	* 11650.000	39.98	3.66	43.64	-10.36	54.00	300	330	Average
3	17475.000	45.38	3.89	49.27	-18.93	68.20	300	32	Peak

Note:

1. " *", means this data is the worst emission level.
2. C.F (Correction Factor) = Antenna Factor (dB/m)+ Cable Loss (dB) – Preamplifier(dB).
3. Measurement (dBUV/m) = Reading(dBUV) + C.F (Correction Factor).
4. The emission levels of other frequencies are very lower than the limit and not show in test report.

EUT	AX1800 Indoor/Outdoor Wi-Fi Access Point	Date of Test	2023-09-22
Factor	DRH18-E	Temp. / Humidity	20°C /60%
Polarity	Vertical	Site / Test Engineer	AC2 / Stanley
Test Mode	802.11a_TX_Band4_CH 165_ANT 0+1	Test Voltage	AC 120V/60Hz

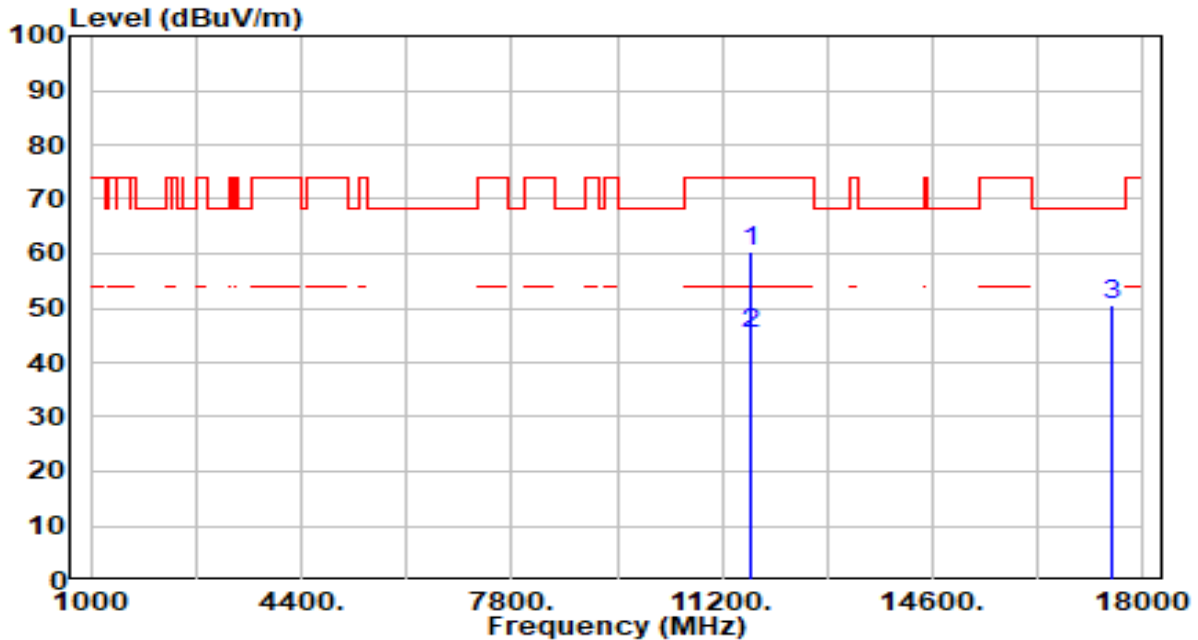

No	Frequency (MHz)	Reading (dBuV)	C.F (dB/m)	Measurement (dBuV/m)	Margin (dB)	Limit (dBuV/m)	Height (cm)	Angle (deg)	Remark (QP/PK/AV)
1	* 11650.000	56.82	3.66	60.48	-13.52	74.00	300	8	Peak
2	* 11650.000	41.68	3.66	45.34	-8.66	54.00	300	8	Average
3	17475.000	46.50	3.89	50.39	-17.81	68.20	300	25	Peak

Note:

1. " *", means this data is the worst emission level.
2. C.F (Correction Factor) = Antenna Factor (dB/m)+ Cable Loss (dB) – Pre-amplifier(dB).
3. Measurement (dBuV/m) = Reading(dBuV) + C.F (Correction Factor).
4. The emission levels of other frequencies are very lower than the limit and not show in test report.

EUT	AX1800 Indoor/Outdoor Wi-Fi Access Point	Date of Test	2023-09-22
Factor	DRH18-E	Temp. / Humidity	20°C /60%
Polarity	Horizontal	Site / Test Engineer	AC2 / Stanley
Test Mode	802.11ac-20MHz_TX_Band1_CH 36_ANT 0+1	Test Voltage	AC 120V/60Hz

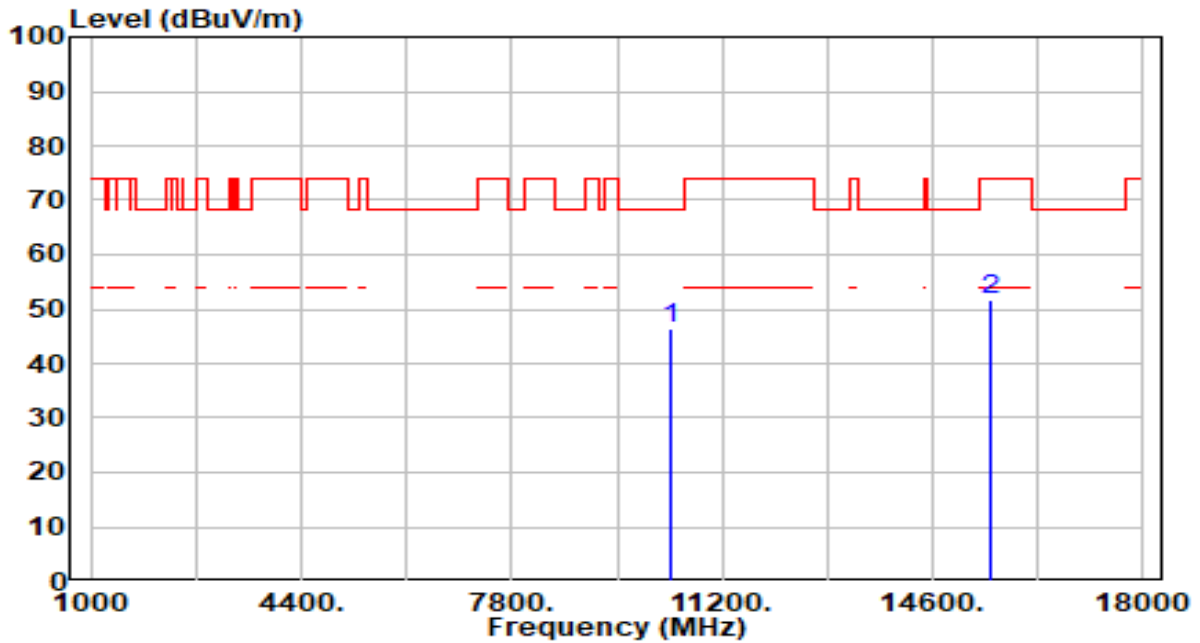

No	Frequency (MHz)	Reading (dBuV)	C.F (dB/m)	Measurement (dBuV/m)	Margin (dB)	Limit (dBuV/m)	Height (cm)	Angle (deg)	Remark (QP/PK/AV)
1	* 10360.000	43.68	2.81	46.49	-21.71	68.20	300	338	Peak
2	15540.000	47.02	4.52	51.55	-22.45	74.00	300	360	Peak

Note:

1. " *", means this data is the worst emission level.
2. C.F (Correction Factor) = Antenna Factor (dB/m)+ Cable Loss (dB) – Pre-amplifier(dB).
3. Measurement (dBuV/m) = Reading(dBuV) + C.F (Correction Factor).
4. The emission levels of other frequencies are very lower than the limit and not show in test report.

EUT	AX1800 Indoor/Outdoor Wi-Fi Access Point	Date of Test	2023-09-22
Factor	DRH18-E	Temp. / Humidity	20°C /60%
Polarity	Vertical	Site / Test Engineer	AC2 / Stanley
Test Mode	802.11ac-20MHz_TX_Band1_CH 36_ANT 0+1	Test Voltage	AC 120V/60Hz

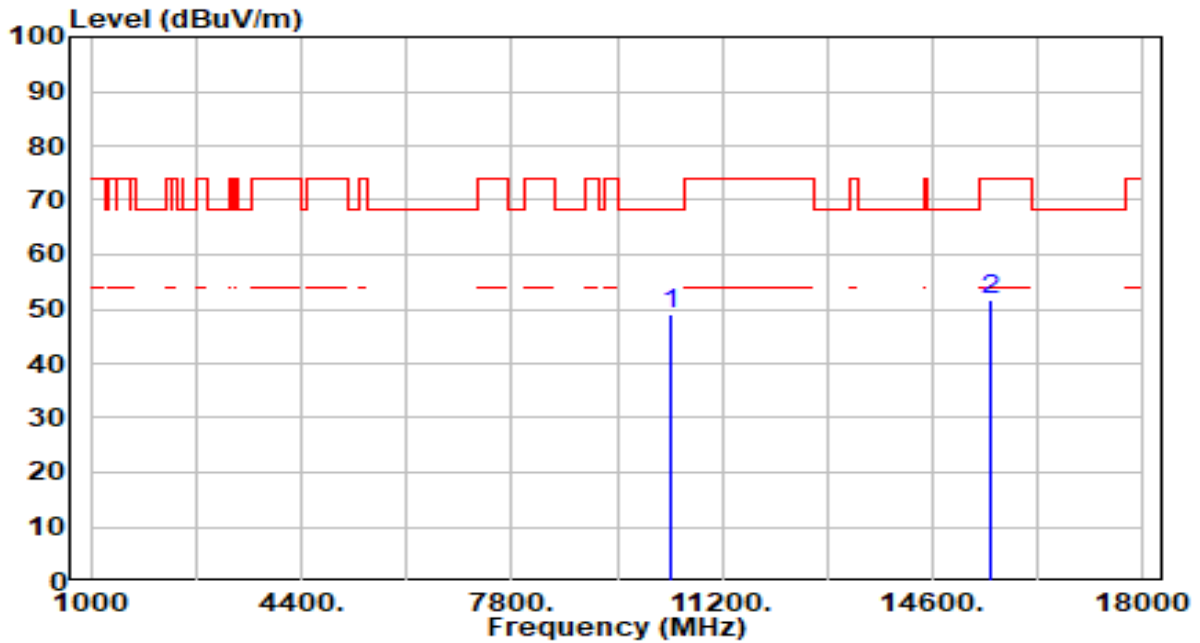

No	Frequency (MHz)	Reading (dBuV)	C.F (dB/m)	Measurement (dBuV/m)	Margin (dB)	Limit (dBuV/m)	Height (cm)	Angle (deg)	Remark (QP/PK/AV)
1	* 10360.000	46.29	2.81	49.10	-19.10	68.20	300	337	Peak
2	15540.000	47.19	4.52	51.72	-22.28	74.00	300	360	Peak

Note:

1. " *", means this data is the worst emission level.
2. C.F (Correction Factor) = Antenna Factor (dB/m)+ Cable Loss (dB) – Pre-amplifier(dB).
3. Measurement (dBuV/m) = Reading(dBuV) + C.F (Correction Factor).
4. The emission levels of other frequencies are very lower than the limit and not show in test report.

EUT	AX1800 Indoor/Outdoor Wi-Fi Access Point	Date of Test	2023-09-22
Factor	DRH18-E	Temp. / Humidity	20°C /60%
Polarity	Horizontal	Site / Test Engineer	AC2 / Stanley
Test Mode	802.11ac-20MHz_TX_Band1_CH 44_ANT 0+1	Test Voltage	AC 120V/60Hz

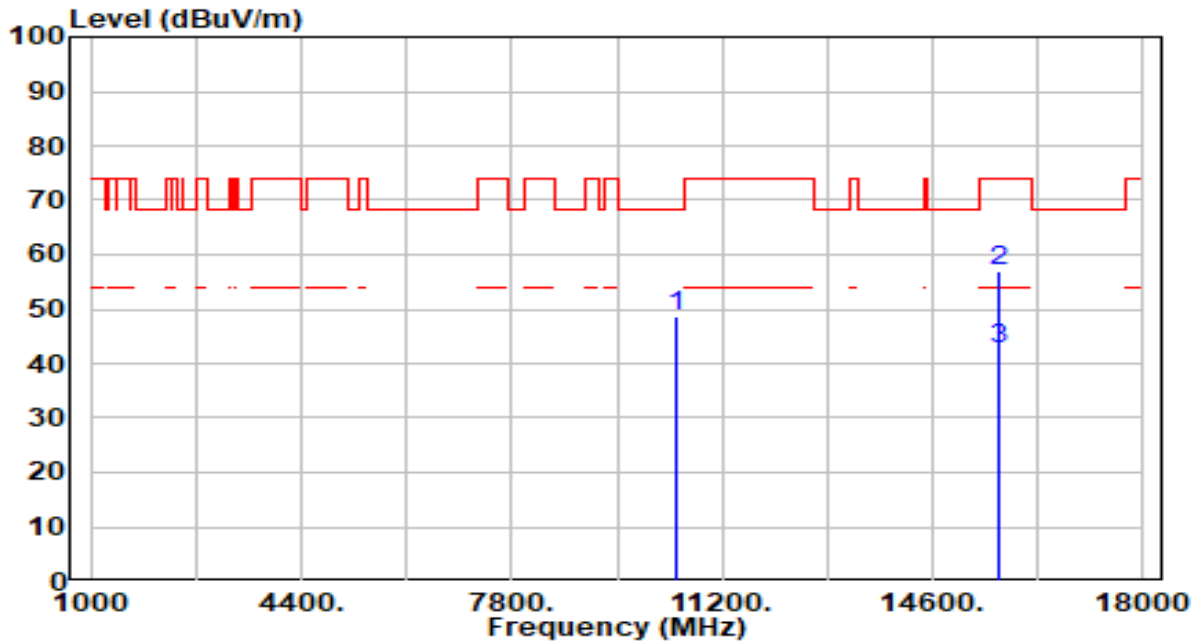

No	Frequency (MHz)	Reading (dBuV)	C.F (dB/m)	Measurement (dBuV/m)	Margin (dB)	Limit (dBuV/m)	Height (cm)	Angle (deg)	Remark (QP/PK/AV)
1	10440.000	45.97	2.72	48.70	-19.50	68.20	300	57	Peak
2	* 15660.000	52.35	4.67	57.02	-16.98	74.00	300	0	Peak
3	* 15660.000	38.13	4.67	42.80	-11.20	54.00	300	0	Average

Note:

1. " *", means this data is the worst emission level.
2. C.F (Correction Factor) = Antenna Factor (dB/m)+ Cable Loss (dB) – Preamplifier(dB).
3. Measurement (dBuV/m) = Reading(dBuV) + C.F (Correction Factor).
4. The emission levels of other frequencies are very lower than the limit and not show in test report.

EUT	AX1800 Indoor/Outdoor Wi-Fi Access Point	Date of Test	2023-09-22
Factor	DRH18-E	Temp. / Humidity	20°C /60%
Polarity	Vertical	Site / Test Engineer	AC2 / Stanley
Test Mode	802.11ac-20MHz_TX_Band1_CH 44_ANT 0+1	Test Voltage	AC 120V/60Hz

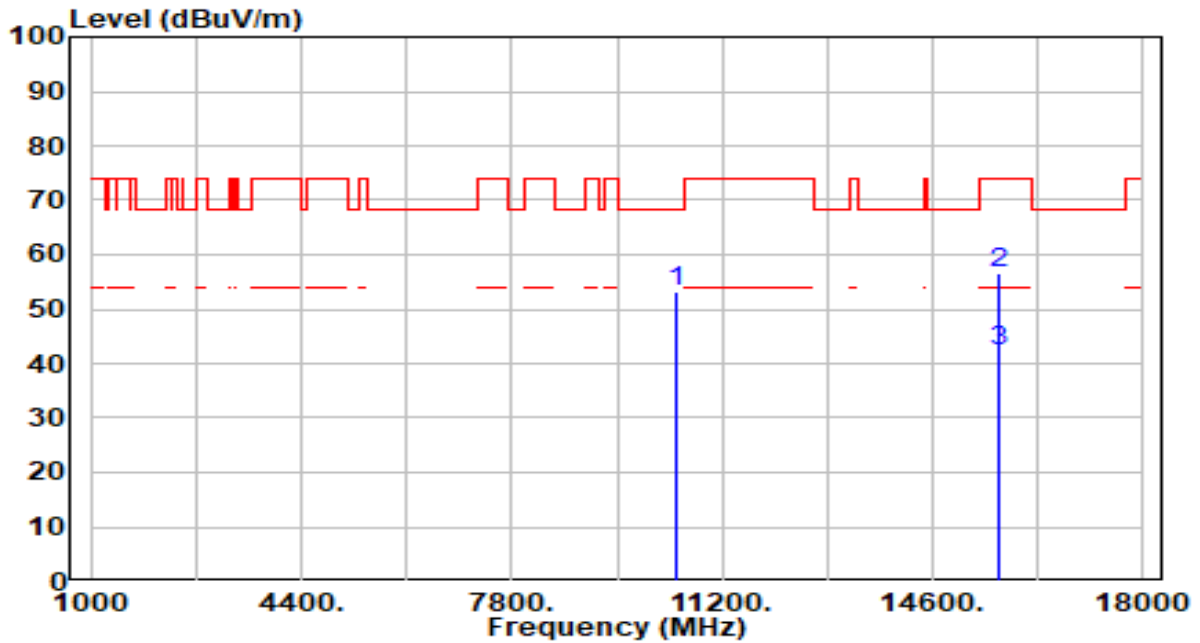

No	Frequency (MHz)	Reading (dBuV)	C.F (dB/m)	Measurement (dBuV/m)	Margin (dB)	Limit (dBuV/m)	Height (cm)	Angle (deg)	Remark (QP/PK/AV)	
1	*	10440.000	50.59	2.72	53.31	-14.89	68.20	300	3	Peak
2		15660.000	51.82	4.67	56.49	-17.51	74.00	300	360	Peak
3	*	15660.000	37.62	4.67	42.29	-11.71	54.00	300	360	Average

Note:

1. " *", means this data is the worst emission level.
2. C.F (Correction Factor) = Antenna Factor (dB/m)+ Cable Loss (dB) – Preamplifier(dB).
3. Measurement (dBuV/m) = Reading(dBuV) + C.F (Correction Factor).
4. The emission levels of other frequencies are very lower than the limit and not show in test report.

EUT	AX1800 Indoor/Outdoor Wi-Fi Access Point	Date of Test	2023-09-22
Factor	DRH18-E	Temp. / Humidity	20°C /60%
Polarity	Horizontal	Site / Test Engineer	AC2 / Stanley
Test Mode	802.11ac-20MHz_TX_Band1_CH 48_ANT 0+1	Test Voltage	AC 120V/60Hz

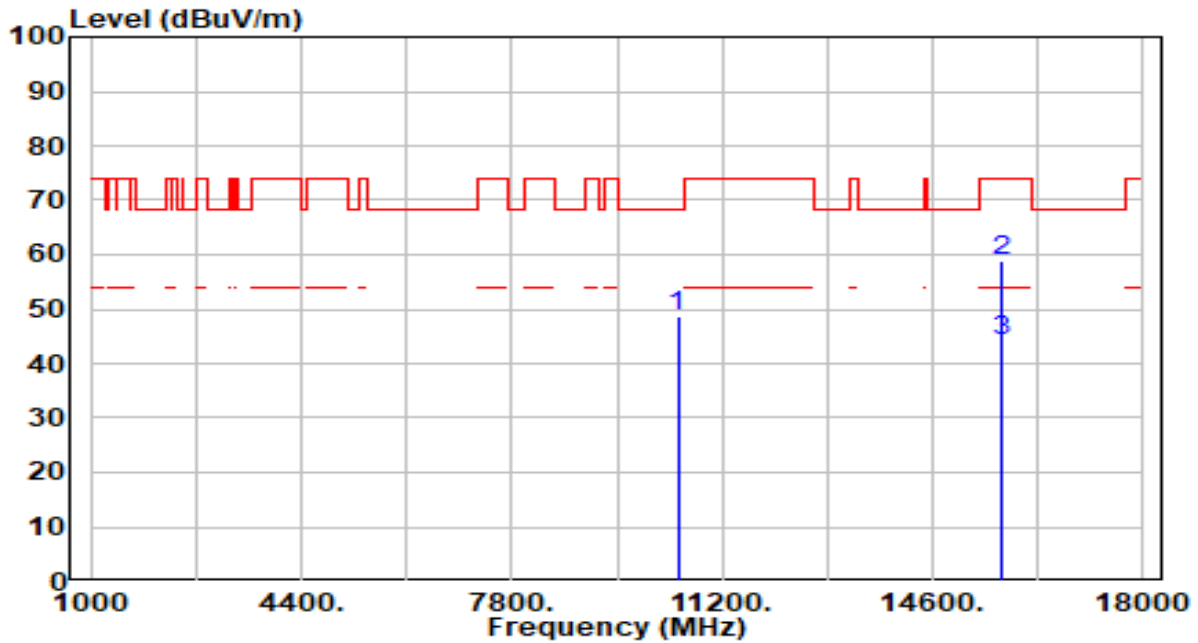

No	Frequency (MHz)	Reading (dBuV)	C.F (dB/m)	Measurement (dBuV/m)	Margin (dB)	Limit (dBuV/m)	Height (cm)	Angle (deg)	Remark (QP/PK/AV)
1	10480.000	46.14	2.68	48.82	-19.38	68.20	300	338	Peak
2	* 15720.000	53.99	4.84	58.83	-15.17	74.00	300	118	Peak
3	* 15720.000	39.44	4.84	44.28	-9.72	54.00	300	118	Average

Note:

1. " *", means this data is the worst emission level.
2. C.F (Correction Factor) = Antenna Factor (dB/m)+ Cable Loss (dB) – Preamplifier(dB).
3. Measurement (dBuV/m) = Reading(dBuV) + C.F (Correction Factor).
4. The emission levels of other frequencies are very lower than the limit and not show in test report.

EUT	AX1800 Indoor/Outdoor Wi-Fi Access Point	Date of Test	2023-09-22
Factor	DRH18-E	Temp. / Humidity	20°C /60%
Polarity	Vertical	Site / Test Engineer	AC2 / Stanley
Test Mode	802.11ac-20MHz_TX_Band1_CH 48_ANT 0+1	Test Voltage	AC 120V/60Hz

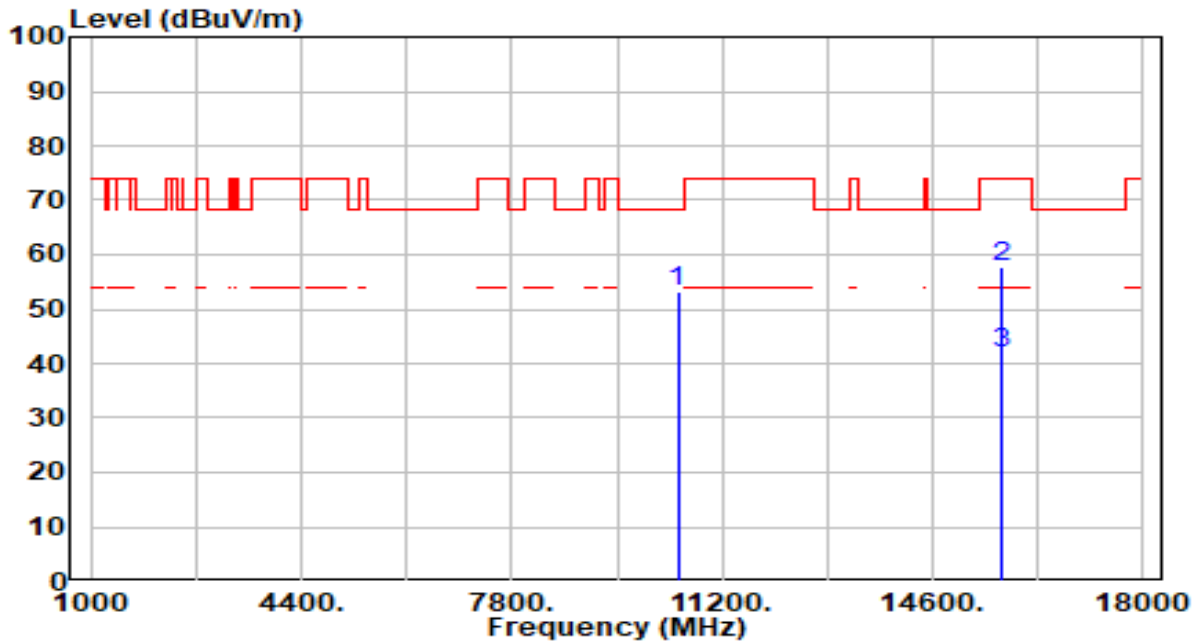

No	Frequency (MHz)	Reading (dBuV)	C.F (dB/m)	Measurement (dBuV/m)	Margin (dB)	Limit (dBuV/m)	Height (cm)	Angle (deg)	Remark (QP/PK/AV)
1	*	50.71	2.68	53.39	-14.81	68.20	300	6	Peak
2		52.93	4.84	57.77	-16.23	74.00	300	360	Peak
3	*	37.22	4.84	42.06	-11.94	54.00	300	360	Average

Note:

1. " *", means this data is the worst emission level.
2. C.F (Correction Factor) = Antenna Factor (dB/m)+ Cable Loss (dB) – Preamplifier(dB).
3. Measurement (dBuV/m) = Reading(dBuV) + C.F (Correction Factor).
4. The emission levels of other frequencies are very lower than the limit and not show in test report.

EUT	AX1800 Indoor/Outdoor Wi-Fi Access Point	Date of Test	2023-09-22
Factor	DRH18-E	Temp. / Humidity	20°C /60%
Polarity	Horizontal	Site / Test Engineer	AC2 / Stanley
Test Mode	802.11ac-20MHz_TX_Band2_CH 52_ANT 0+1	Test Voltage	AC 120V/60Hz

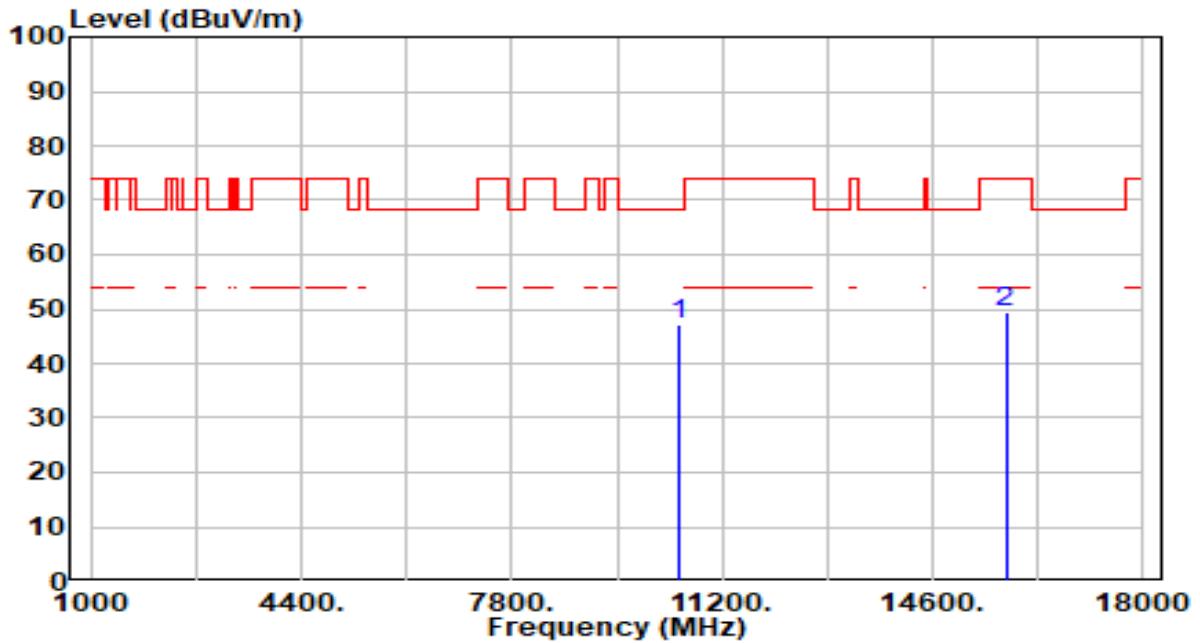

No	Frequency (MHz)	Reading (dBuV)	C.F (dB/m)	Measurement (dBuV/m)	Margin (dB)	Limit (dBuV/m)	Height (cm)	Angle (deg)	Remark (QP/PK/AV)
1	* 10520.000	44.55	2.64	47.19	-21.01	68.20	300	23	Peak
2	15780.000	44.50	5.00	49.50	-24.50	74.00	300	149	Peak

Note:

1. " *", means this data is the worst emission level.
2. C.F (Correction Factor) = Antenna Factor (dB/m)+ Cable Loss (dB) – Pre-amplifier(dB).
3. Measurement (dBuV/m) = Reading(dBuV) + C.F (Correction Factor).
4. The emission levels of other frequencies are very lower than the limit and not show in test report.

EUT	AX1800 Indoor/Outdoor Wi-Fi Access Point	Date of Test	2023-09-22
Factor	DRH18-E	Temp. / Humidity	20°C /60%
Polarity	Vertical	Site / Test Engineer	AC2 / Stanley
Test Mode	802.11ac-20MHz_TX_Band2_CH 52_ANT 0+1	Test Voltage	AC 120V/60Hz

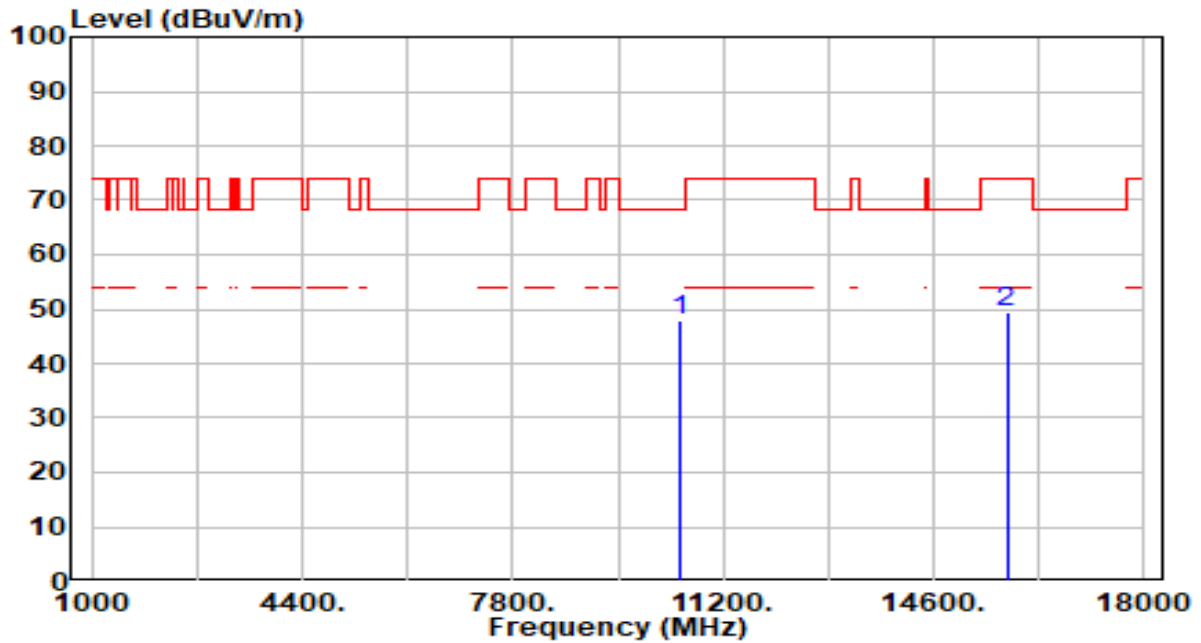

No	Frequency (MHz)	Reading (dBuV)	C.F (dB/m)	Measurement (dBuV/m)	Margin (dB)	Limit (dBuV/m)	Height (cm)	Angle (deg)	Remark (QP/PK/AV)
1	* 10520.000	45.34	2.64	47.99	-20.21	68.20	300	13	Peak
2	15780.000	44.44	5.00	49.44	-24.56	74.00	300	291	Peak

Note:

1. " *", means this data is the worst emission level.
2. C.F (Correction Factor) = Antenna Factor (dB/m)+ Cable Loss (dB) – Pre-amplifier(dB).
3. Measurement (dBuV/m) = Reading(dBuV) + C.F (Correction Factor).
4. The emission levels of other frequencies are very lower than the limit and not show in test report.

EUT	AX1800 Indoor/Outdoor Wi-Fi Access Point	Date of Test	2023-09-22
Factor	DRH18-E	Temp. / Humidity	20°C /60%
Polarity	Horizontal	Site / Test Engineer	AC2 / Stanley
Test Mode	802.11ac-20MHz_TX_Band2_CH 60_ANT 0+1	Test Voltage	AC 120V/60Hz

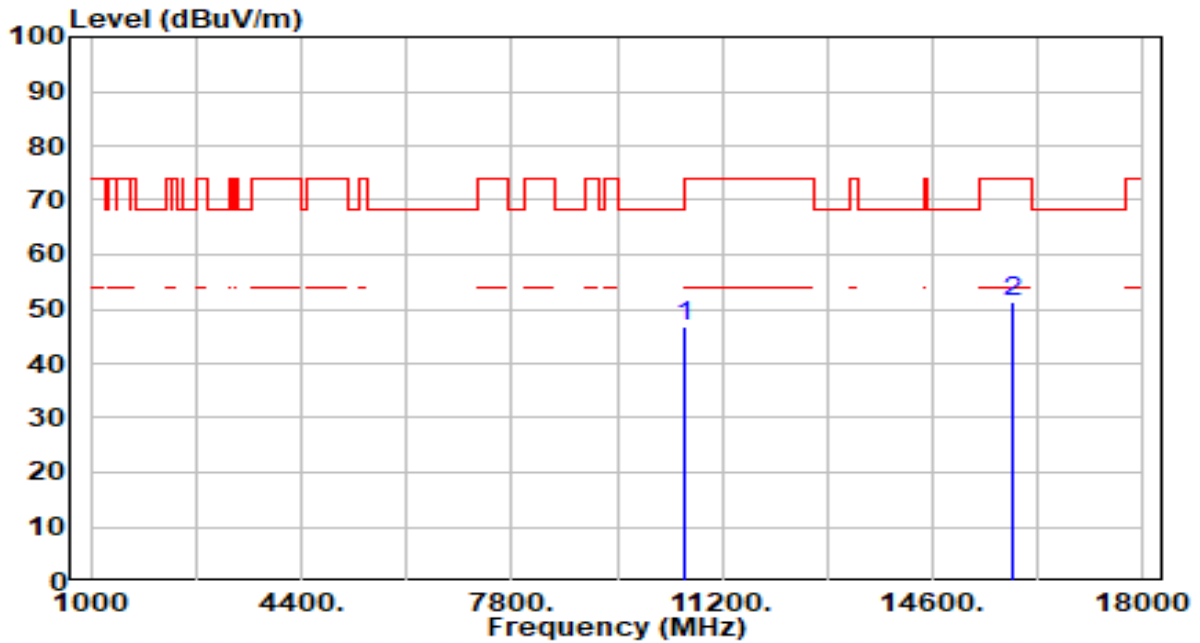

No	Frequency (MHz)	Reading (dBuV)	C.F (dB/m)	Measurement (dBuV/m)	Margin (dB)	Limit (dBuV/m)	Height (cm)	Angle (deg)	Remark (QP/PK/AV)
1	* 10600.000	44.28	2.60	46.89	-21.31	68.20	300	32	Peak
2	15900.000	46.36	5.13	51.49	-22.51	74.00	300	322	Peak

Note:

1. " *", means this data is the worst emission level.
2. C.F (Correction Factor) = Antenna Factor (dB/m)+ Cable Loss (dB) – Preamplifier(dB).
3. Measurement (dBuV/m) = Reading(dBuV) + C.F (Correction Factor).
4. The emission levels of other frequencies are very lower than the limit and not show in test report.

EUT	AX1800 Indoor/Outdoor Wi-Fi Access Point	Date of Test	2023-09-22
Factor	DRH18-E	Temp. / Humidity	20°C /60%
Polarity	Vertical	Site / Test Engineer	AC2 / Stanley
Test Mode	802.11ac-20MHz_TX_Band2_CH 60_ANT 0+1	Test Voltage	AC 120V/60Hz

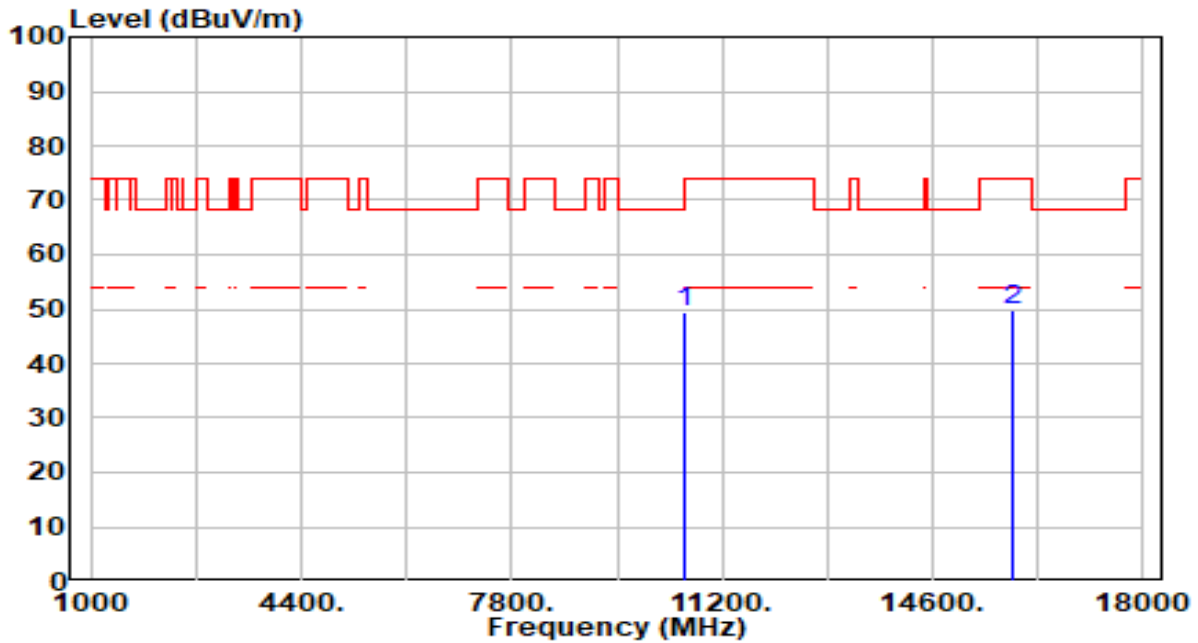

No	Frequency (MHz)	Reading (dBuV)	C.F (dB/m)	Measurement (dBuV/m)	Margin (dB)	Limit (dBuV/m)	Height (cm)	Angle (deg)	Remark (QP/PK/AV)
1	* 10600.000	46.75	2.60	49.35	-18.85	68.20	300	360	Peak
2	15900.000	44.75	5.13	49.87	-24.13	74.00	300	32	Peak

Note:

1. " *", means this data is the worst emission level.
2. C.F (Correction Factor) = Antenna Factor (dB/m)+ Cable Loss (dB) – Pre-amplifier(dB).
3. Measurement (dBuV/m) = Reading(dBuV) + C.F (Correction Factor).
4. The emission levels of other frequencies are very lower than the limit and not show in test report.

EUT	AX1800 Indoor/Outdoor Wi-Fi Access Point	Date of Test	2023-09-22
Factor	DRH18-E	Temp. / Humidity	20°C /60%
Polarity	Horizontal	Site / Test Engineer	AC2 / Stanley
Test Mode	802.11ac-20MHz_TX_Band2_CH 64_ANT 0+1	Test Voltage	AC 120V/60Hz

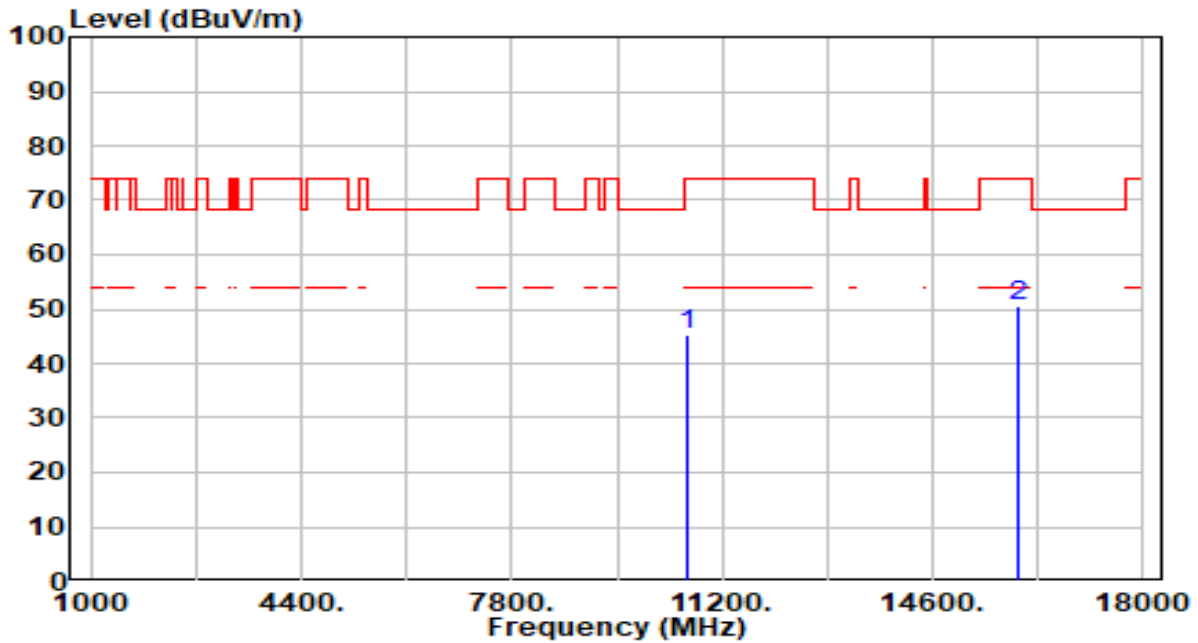

No	Frequency (MHz)	Reading (dBuV)	C.F (dB/m)	Measurement (dBuV/m)	Margin (dB)	Limit (dBuV/m)	Height (cm)	Angle (deg)	Remark (QP/PK/AV)
1	10640.000	42.69	2.62	45.31	-28.69	74.00	300	26	Peak
2	* 15960.000	45.36	5.17	50.53	-23.47	74.00	300	302	Peak

Note:

1. " *", means this data is the worst emission level.
2. C.F (Correction Factor) = Antenna Factor (dB/m)+ Cable Loss (dB) – Pre-amplifier(dB).
3. Measurement (dBuV/m) = Reading(dBuV) + C.F (Correction Factor).
4. The emission levels of other frequencies are very lower than the limit and not show in test report.

EUT	AX1800 Indoor/Outdoor Wi-Fi Access Point	Date of Test	2023-09-22
Factor	DRH18-E	Temp. / Humidity	20°C /60%
Polarity	Vertical	Site / Test Engineer	AC2 / Stanley
Test Mode	802.11ac-20MHz_TX_Band2_CH 64_ANT 0+1	Test Voltage	AC 120V/60Hz

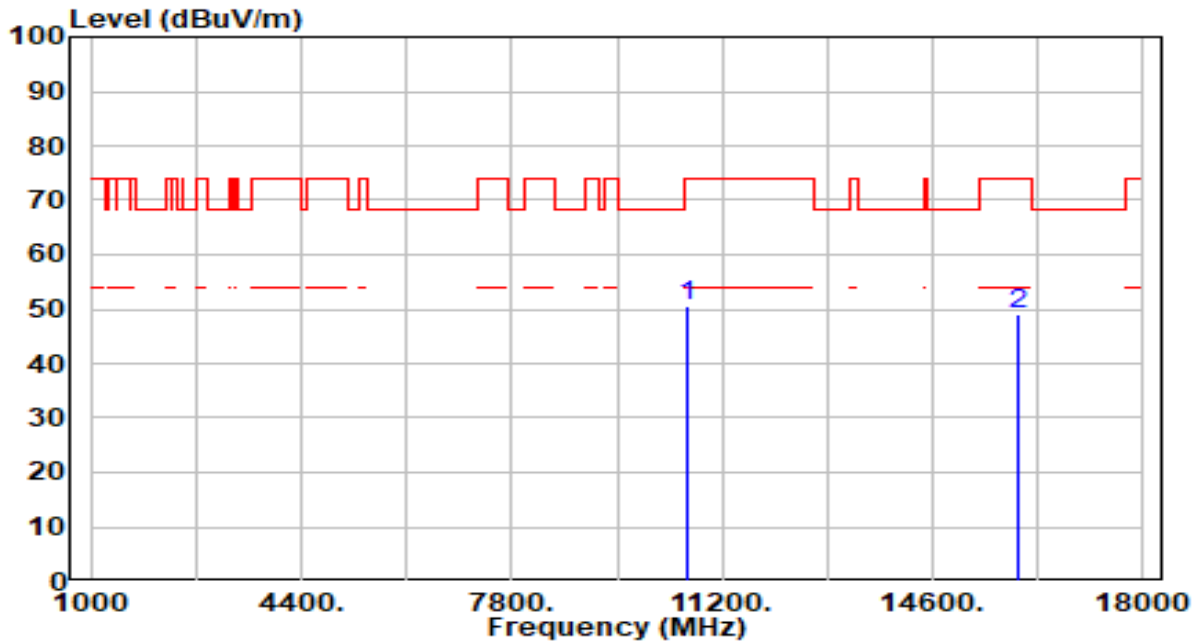

No	Frequency (MHz)	Reading (dBuV)	C.F (dB/m)	Measurement (dBuV/m)	Margin (dB)	Limit (dBuV/m)	Height (cm)	Angle (deg)	Remark (QP/PK/AV)
1	* 10640.000	47.94	2.62	50.56	-23.44	74.00	300	361	Peak
2	15960.000	43.78	5.17	48.95	-25.05	74.00	300	37	Peak

Note:

1. " *", means this data is the worst emission level.
2. C.F (Correction Factor) = Antenna Factor (dB/m)+ Cable Loss (dB) – Pre-amplifier(dB).
3. Measurement (dBuV/m) = Reading(dBuV) + C.F (Correction Factor).
4. The emission levels of other frequencies are very lower than the limit and not show in test report.

EUT	AX1800 Indoor/Outdoor Wi-Fi Access Point	Date of Test	2023-09-22
Factor	DRH18-E	Temp. / Humidity	20°C /60%
Polarity	Horizontal	Site / Test Engineer	AC2 / Stanley
Test Mode	802.11ac-20MHz_TX_Band3_CH 100_ANT 0+1	Test Voltage	AC 120V/60Hz

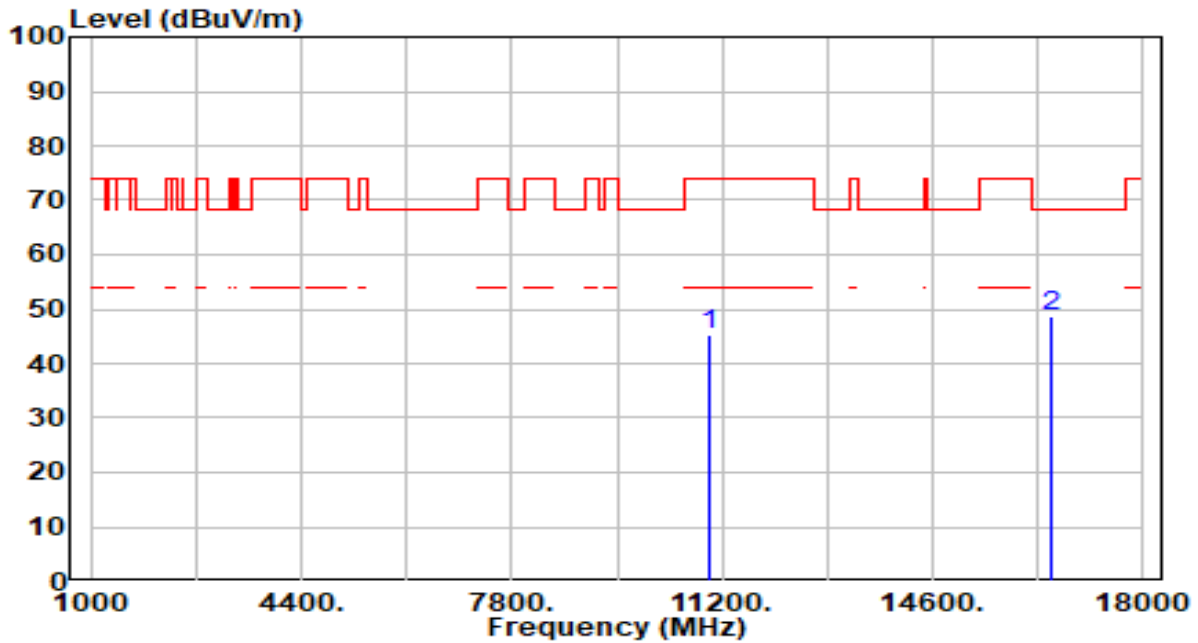

No	Frequency (MHz)	Reading (dBuV)	C.F (dB/m)	Measurement (dBuV/m)	Margin (dB)	Limit (dBuV/m)	Height (cm)	Angle (deg)	Remark (QP/PK/AV)
1	11000.000	42.80	2.60	45.40	-28.60	74.00	300	72	Peak
2	* 16500.000	44.00	4.63	48.63	-19.57	68.20	300	75	Peak

Note:

1. " *", means this data is the worst emission level.
2. C.F (Correction Factor) = Antenna Factor (dB/m)+ Cable Loss (dB) – Pre-amplifier(dB).
3. Measurement (dBuV/m) = Reading(dBuV) + C.F (Correction Factor).
4. The emission levels of other frequencies are very lower than the limit and not show in test report.

EUT	AX1800 Indoor/Outdoor Wi-Fi Access Point	Date of Test	2023-09-22
Factor	DRH18-E	Temp. / Humidity	20°C /60%
Polarity	Vertical	Site / Test Engineer	AC2 / Stanley
Test Mode	802.11ac-20MHz_TX_Band3_CH 100_ANT 0+1	Test Voltage	AC 120V/60Hz

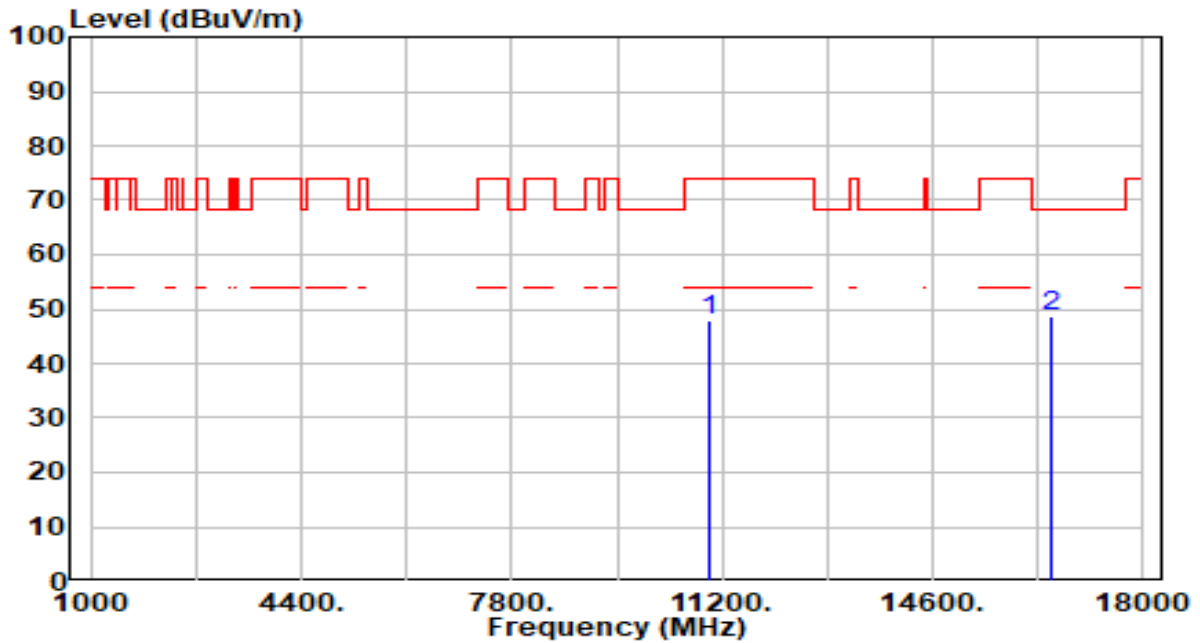

No	Frequency (MHz)	Reading (dBuV)	C.F (dB/m)	Measurement (dBuV/m)	Margin (dB)	Limit (dBuV/m)	Height (cm)	Angle (deg)	Remark (QP/PK/AV)
1	11000.000	45.48	2.60	48.08	-25.92	74.00	300	7	Peak
2	* 16500.000	44.06	4.63	48.69	-19.51	68.20	300	188	Peak

Note:

1. " *", means this data is the worst emission level.
2. C.F (Correction Factor) = Antenna Factor (dB/m)+ Cable Loss (dB) – Preamplifier(dB).
3. Measurement (dBuV/m) = Reading(dBuV) + C.F (Correction Factor).
4. The emission levels of other frequencies are very lower than the limit and not show in test report.

EUT	AX1800 Indoor/Outdoor Wi-Fi Access Point	Date of Test	2023-09-22
Factor	DRH18-E	Temp. / Humidity	20°C /60%
Polarity	Horizontal	Site / Test Engineer	AC2 / Stanley
Test Mode	802.11ac-20MHz_TX_Band3_CH 116_ANT 0+1	Test Voltage	AC 120V/60Hz

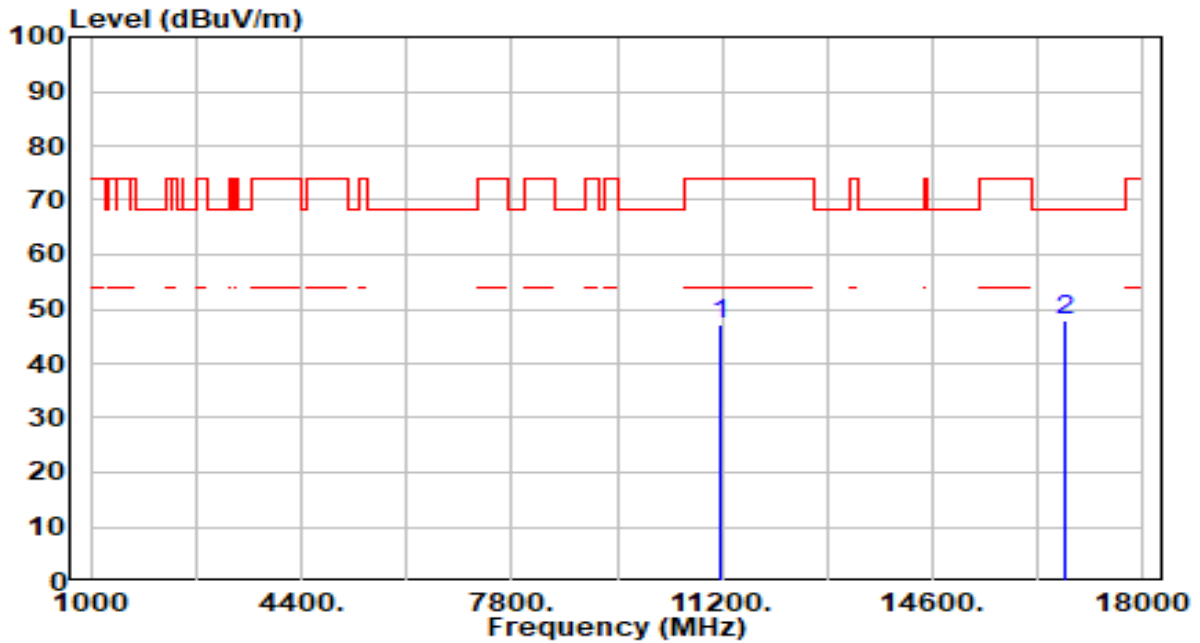

No	Frequency (MHz)	Reading (dBuV)	C.F (dB/m)	Measurement (dBuV/m)	Margin (dB)	Limit (dBuV/m)	Height (cm)	Angle (deg)	Remark (QP/PK/AV)
1	11160.000	43.92	3.07	46.99	-27.01	74.00	300	37	Peak
2	* 16740.000	43.40	4.66	48.06	-20.14	68.20	300	314	Peak

Note:

1. " *", means this data is the worst emission level.
2. C.F (Correction Factor) = Antenna Factor (dB/m)+ Cable Loss (dB) – Pre-amplifier(dB).
3. Measurement (dBuV/m) = Reading(dBuV) + C.F (Correction Factor).
4. The emission levels of other frequencies are very lower than the limit and not show in test report.

EUT	AX1800 Indoor/Outdoor Wi-Fi Access Point	Date of Test	2023-09-22
Factor	DRH18-E	Temp. / Humidity	20°C /60%
Polarity	Vertical	Site / Test Engineer	AC2 / Stanley
Test Mode	802.11ac-20MHz_TX_Band3_CH 116_ANT 0+1	Test Voltage	AC 120V/60Hz

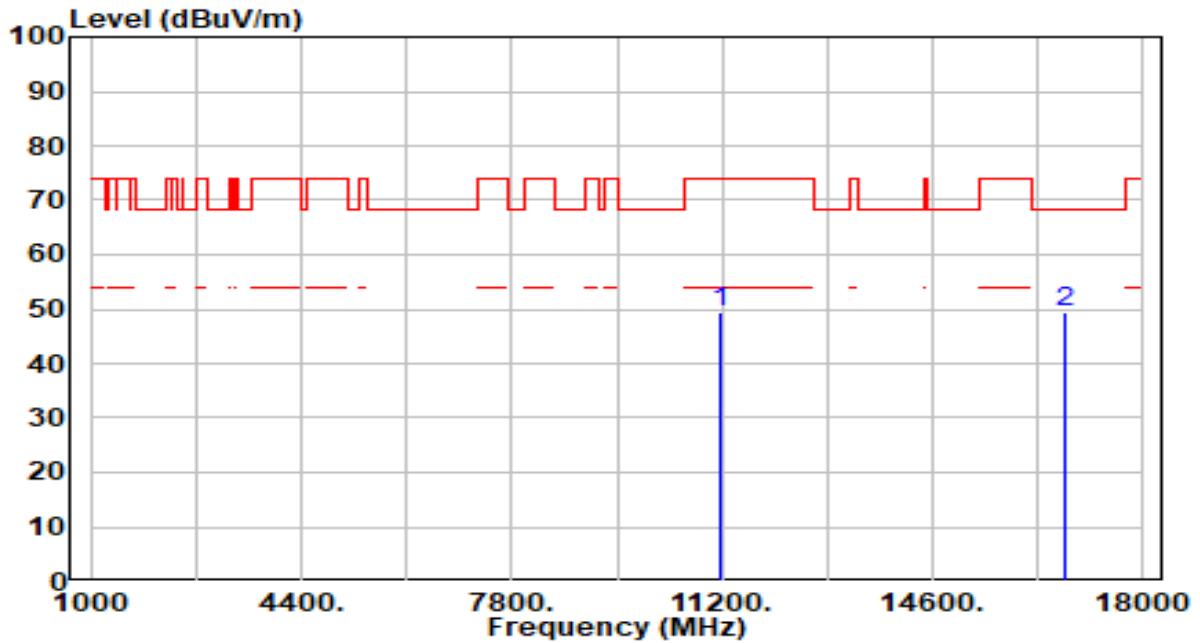

No	Frequency (MHz)	Reading (dBuV)	C.F (dB/m)	Measurement (dBuV/m)	Margin (dB)	Limit (dBuV/m)	Height (cm)	Angle (deg)	Remark (QP/PK/AV)
1	11160.000	46.28	3.07	49.35	-24.65	74.00	300	18	Peak
2	* 16740.000	44.63	4.66	49.30	-18.90	68.20	300	360	Peak

Note:

1. " *", means this data is the worst emission level.
2. C.F (Correction Factor) = Antenna Factor (dB/m)+ Cable Loss (dB) – Pre-amplifier(dB).
3. Measurement (dBuV/m) = Reading(dBuV) + C.F (Correction Factor).
4. The emission levels of other frequencies are very lower than the limit and not show in test report.

EUT	AX1800 Indoor/Outdoor Wi-Fi Access Point	Date of Test	2023-09-22
Factor	DRH18-E	Temp. / Humidity	20°C /60%
Polarity	Horizontal	Site / Test Engineer	AC2 / Stanley
Test Mode	802.11ac-20MHz_TX_Band3_CH 140_ANT 0+1	Test Voltage	AC 120V/60Hz

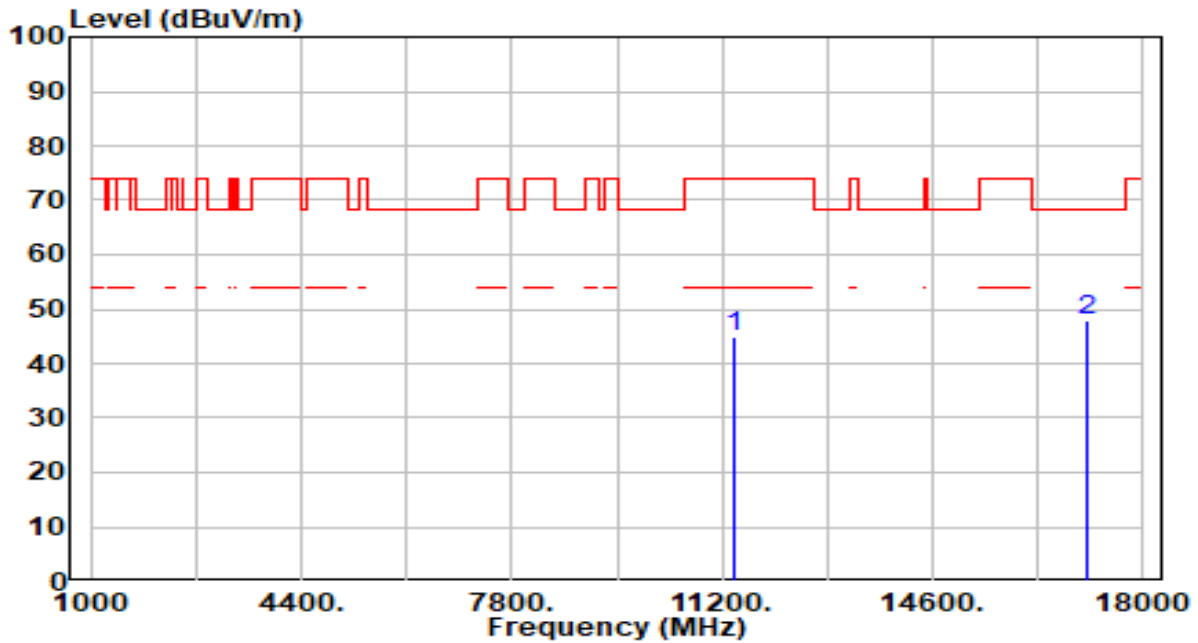

No	Frequency (MHz)	Reading (dBuV)	C.F (dB/m)	Measurement (dBuV/m)	Margin (dB)	Limit (dBuV/m)	Height (cm)	Angle (deg)	Remark (QP/PK/AV)
1	11400.000	41.47	3.48	44.95	-29.05	74.00	300	128	Peak
2	* 17100.000	43.28	4.79	48.07	-20.13	68.20	300	323	Peak

Note:

1. " *", means this data is the worst emission level.
2. C.F (Correction Factor) = Antenna Factor (dB/m)+ Cable Loss (dB) – Pre-amplifier(dB).
3. Measurement (dBuV/m) = Reading(dBuV) + C.F (Correction Factor).
4. The emission levels of other frequencies are very lower than the limit and not show in test report.

EUT	AX1800 Indoor/Outdoor Wi-Fi Access Point	Date of Test	2023-09-22
Factor	DRH18-E	Temp. / Humidity	20°C /60%
Polarity	Vertical	Site / Test Engineer	AC2 / Stanley
Test Mode	802.11ac-20MHz_TX_Band3_CH 140_ANT 0+1	Test Voltage	AC 120V/60Hz

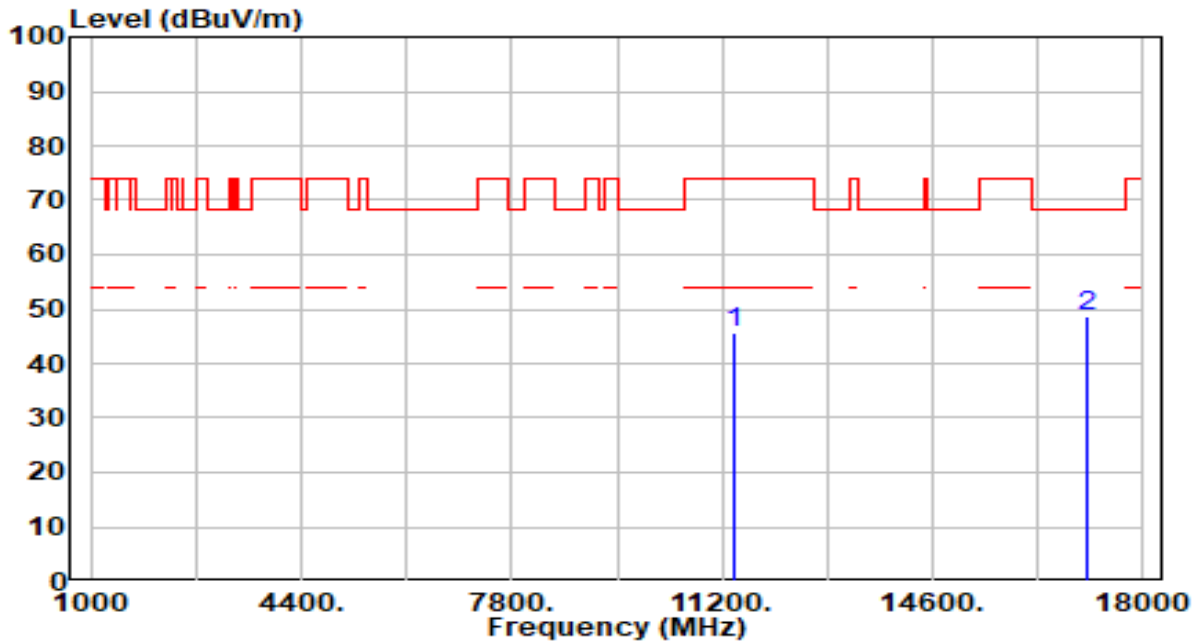

No	Frequency (MHz)	Reading (dBuV)	C.F (dB/m)	Measurement (dBuV/m)	Margin (dB)	Limit (dBuV/m)	Height (cm)	Angle (deg)	Remark (QP/PK/AV)
1	11400.000	42.00	3.48	45.48	-28.52	74.00	300	360	Peak
2	* 17100.000	44.07	4.79	48.87	-19.33	68.20	300	35	Peak

Note:

1. " *", means this data is the worst emission level.
2. C.F (Correction Factor) = Antenna Factor (dB/m)+ Cable Loss (dB) – Pre-amplifier(dB).
3. Measurement (dBuV/m) = Reading(dBuV) + C.F (Correction Factor).
4. The emission levels of other frequencies are very lower than the limit and not show in test report.

EUT	AX1800 Indoor/Outdoor Wi-Fi Access Point	Date of Test	2023-09-22
Factor	DRH18-E	Temp. / Humidity	20°C /60%
Polarity	Horizontal	Site / Test Engineer	AC2 / Stanley
Test Mode	802.11ac-20MHz_TX_Band3_CH 144_ANT 0+1	Test Voltage	AC 120V/60Hz

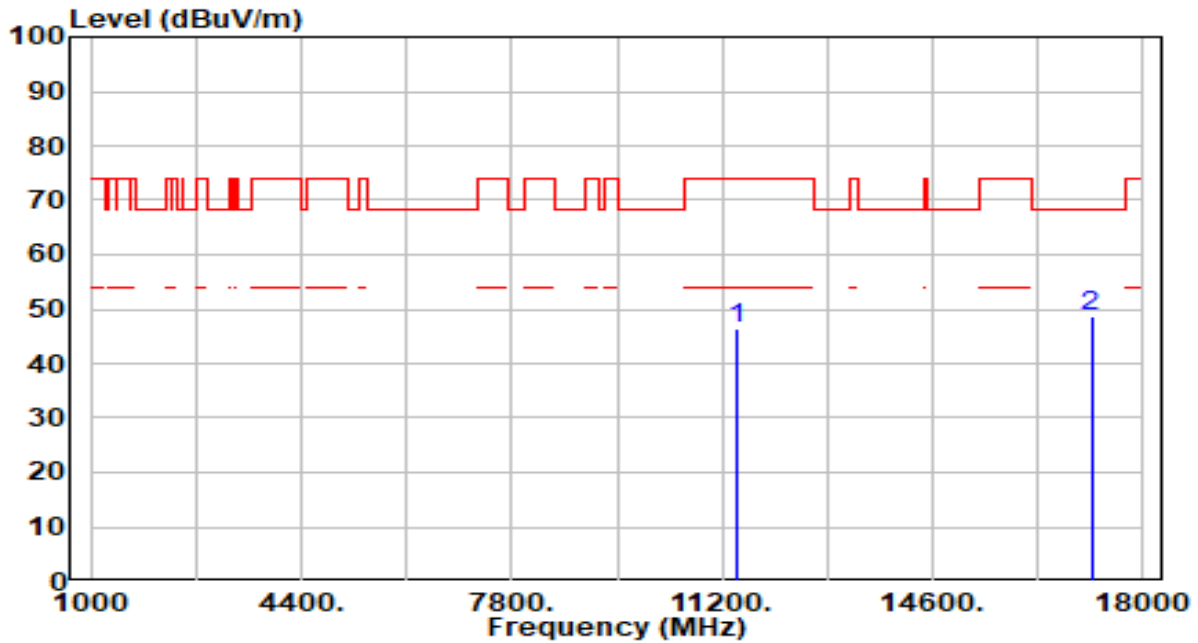

No	Frequency (MHz)	Reading (dBuV)	C.F (dB/m)	Measurement (dBuV/m)	Margin (dB)	Limit (dBuV/m)	Height (cm)	Angle (deg)	Remark (QP/PK/AV)
1	11440.000	43.00	3.52	46.52	-27.48	74.00	300	43	Peak
2	* 17160.000	44.16	4.66	48.82	-19.38	68.20	300	0	Peak

Note:

1. " *", means this data is the worst emission level.
2. C.F (Correction Factor) = Antenna Factor (dB/m)+ Cable Loss (dB) – Pre-amplifier(dB).
3. Measurement (dBuV/m) = Reading(dBuV) + C.F (Correction Factor).
4. The emission levels of other frequencies are very lower than the limit and not show in test report.

EUT	AX1800 Indoor/Outdoor Wi-Fi Access Point	Date of Test	2023-09-22
Factor	DRH18-E	Temp. / Humidity	20°C /60%
Polarity	Vertical	Site / Test Engineer	AC2 / Stanley
Test Mode	802.11ac-20MHz_TX_Band3_CH 144_ANT 0+1	Test Voltage	AC 120V/60Hz

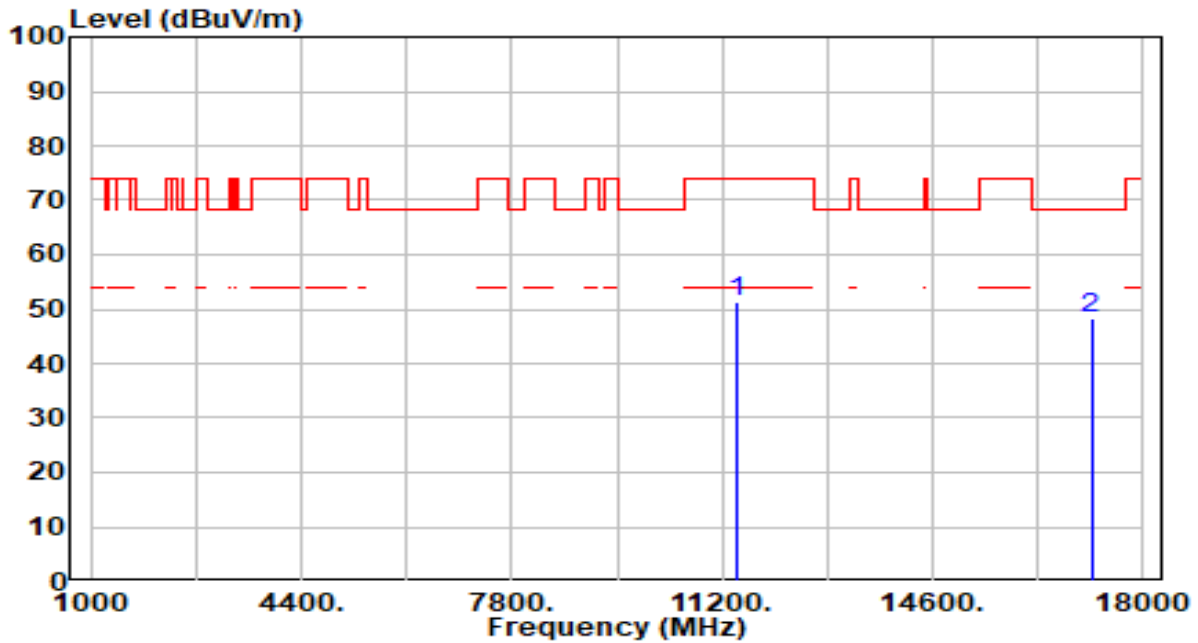

No	Frequency (MHz)	Reading (dBuV)	C.F (dB/m)	Measurement (dBuV/m)	Margin (dB)	Limit (dBuV/m)	Height (cm)	Angle (deg)	Remark (QP/PK/AV)
1	11440.000	47.76	3.52	51.27	-22.73	74.00	300	360	Peak
2	* 17160.000	43.67	4.66	48.33	-19.87	68.20	300	190	Peak

Note:

1. " *", means this data is the worst emission level.
2. C.F (Correction Factor) = Antenna Factor (dB/m)+ Cable Loss (dB) – Pre-amplifier(dB).
3. Measurement (dBuV/m) = Reading(dBuV) + C.F (Correction Factor).
4. The emission levels of other frequencies are very lower than the limit and not show in test report.

EUT	AX1800 Indoor/Outdoor Wi-Fi Access Point	Date of Test	2023-09-22
Factor	DRH18-E	Temp. / Humidity	20°C /60%
Polarity	Horizontal	Site / Test Engineer	AC2 / Stanley
Test Mode	802.11ac-20MHz_TX_Band4_CH 149_ANT 0+1	Test Voltage	AC 120V/60Hz

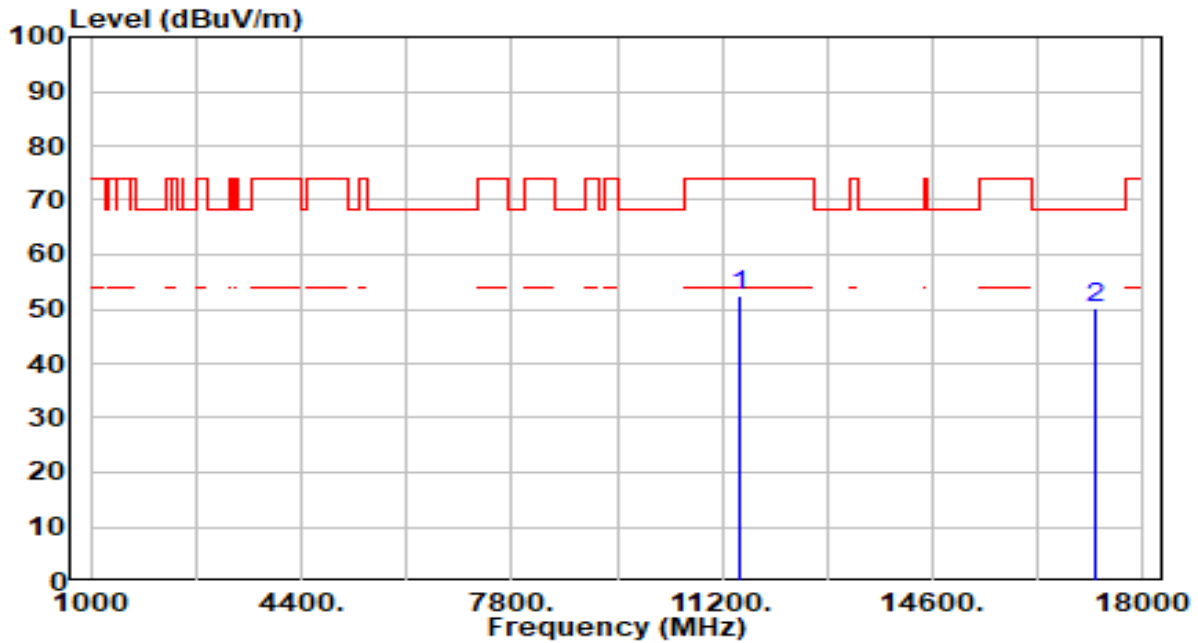

No	Frequency (MHz)	Reading (dBuV)	C.F (dB/m)	Measurement (dBuV/m)	Margin (dB)	Limit (dBuV/m)	Height (cm)	Angle (deg)	Remark (QP/PK/AV)
1	11490.000	48.77	3.57	52.33	-21.67	74.00	300	333	Peak
2	* 17235.000	45.83	4.45	50.28	-17.92	68.20	300	212	Peak

Note:

1. " *", means this data is the worst emission level.
2. C.F (Correction Factor) = Antenna Factor (dB/m)+ Cable Loss (dB) – Pre-amplifier(dB).
3. Measurement (dBuV/m) = Reading(dBuV) + C.F (Correction Factor).
4. The emission levels of other frequencies are very lower than the limit and not show in test report.

EUT	AX1800 Indoor/Outdoor Wi-Fi Access Point	Date of Test	2023-09-22
Factor	DRH18-E	Temp. / Humidity	20°C /60%
Polarity	Vertical	Site / Test Engineer	AC2 / Stanley
Test Mode	802.11ac-20MHz_TX_Band4_CH 149_ANT 0+1	Test Voltage	AC 120V/60Hz

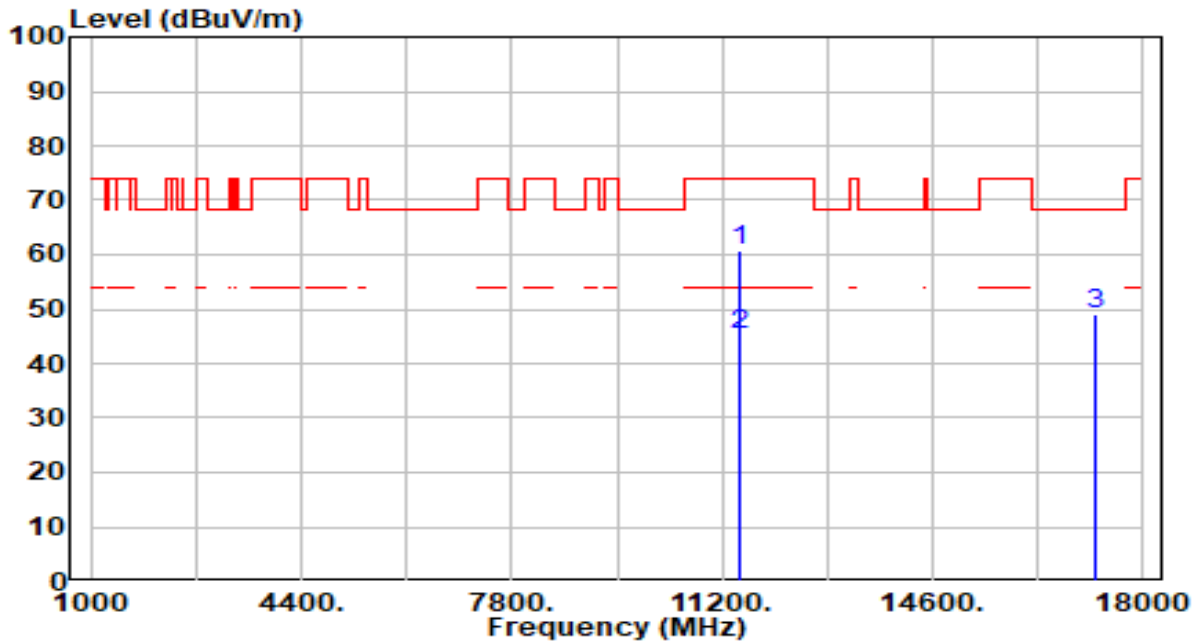

No	Frequency (MHz)	Reading (dBuV)	C.F (dB/m)	Measurement (dBuV/m)	Margin (dB)	Limit (dBuV/m)	Height (cm)	Angle (deg)	Remark (QP/PK/AV)
1	11490.000	57.27	3.57	60.84	-13.16	74.00	300	2	Peak
2	* 11490.000	41.76	3.57	45.33	-8.67	54.00	300	2	Average
3	17235.000	44.56	4.45	49.01	-19.19	68.20	300	27	Peak

Note:

1. " *", means this data is the worst emission level.
2. C.F (Correction Factor) = Antenna Factor (dB/m)+ Cable Loss (dB) – Preamplifier(dB).
3. Measurement (dBuV/m) = Reading(dBuV) + C.F (Correction Factor).
4. The emission levels of other frequencies are very lower than the limit and not show in test report.

EUT	AX1800 Indoor/Outdoor Wi-Fi Access Point	Date of Test	2023-09-22
Factor	DRH18-E	Temp. / Humidity	20°C /60%
Polarity	Horizontal	Site / Test Engineer	AC2 / Stanley
Test Mode	802.11ac-20MHz_TX_Band4_CH 157_ANT 0+1	Test Voltage	AC 120V/60Hz

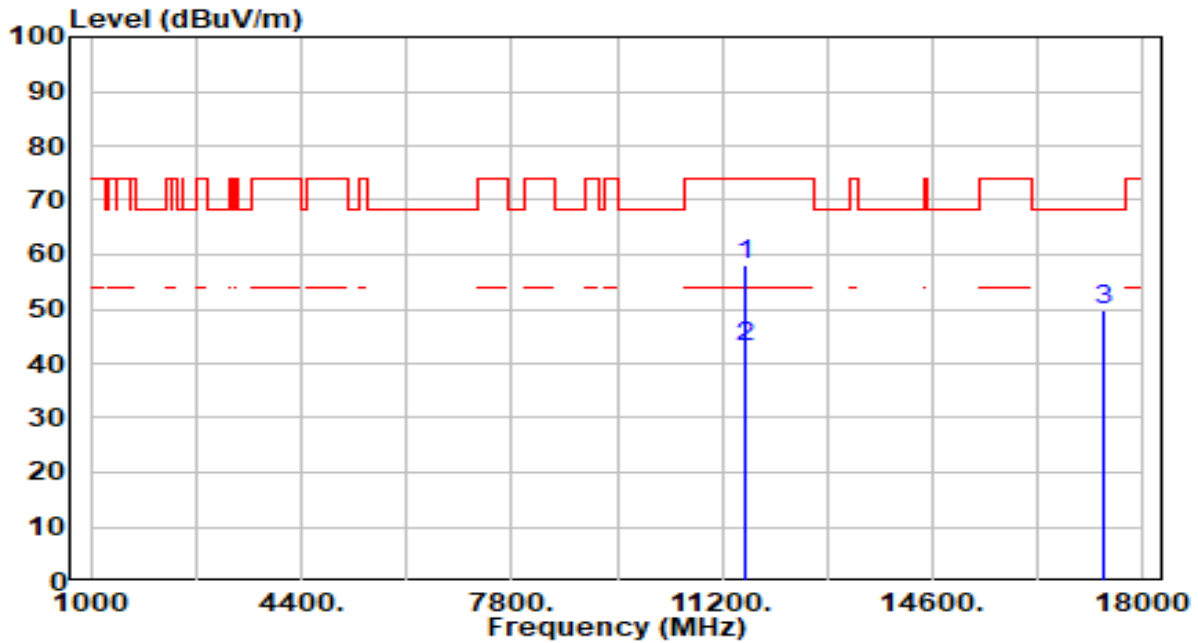

No	Frequency (MHz)	Reading (dBuV)	C.F (dB/m)	Measurement (dBuV/m)	Margin (dB)	Limit (dBuV/m)	Height (cm)	Angle (deg)	Remark (QP/PK/AV)
1	11570.000	54.39	3.65	58.04	-15.96	74.00	300	320	Peak
2	* 11570.000	39.38	3.65	43.03	-10.97	54.00	300	320	Average
3	17355.000	45.81	4.06	49.87	-18.33	68.20	300	106	Peak

Note:

1. " *", means this data is the worst emission level.
2. C.F (Correction Factor) = Antenna Factor (dB/m)+ Cable Loss (dB) – Preamplifier(dB).
3. Measurement (dBuV/m) = Reading(dBuV) + C.F (Correction Factor).
4. The emission levels of other frequencies are very lower than the limit and not show in test report.

EUT	AX1800 Indoor/Outdoor Wi-Fi Access Point	Date of Test	2023-09-22
Factor	DRH18-E	Temp. / Humidity	20°C /60%
Polarity	Vertical	Site / Test Engineer	AC2 / Stanley
Test Mode	802.11ac-20MHz_TX_Band4_CH 157_ANT 0+1	Test Voltage	AC 120V/60Hz

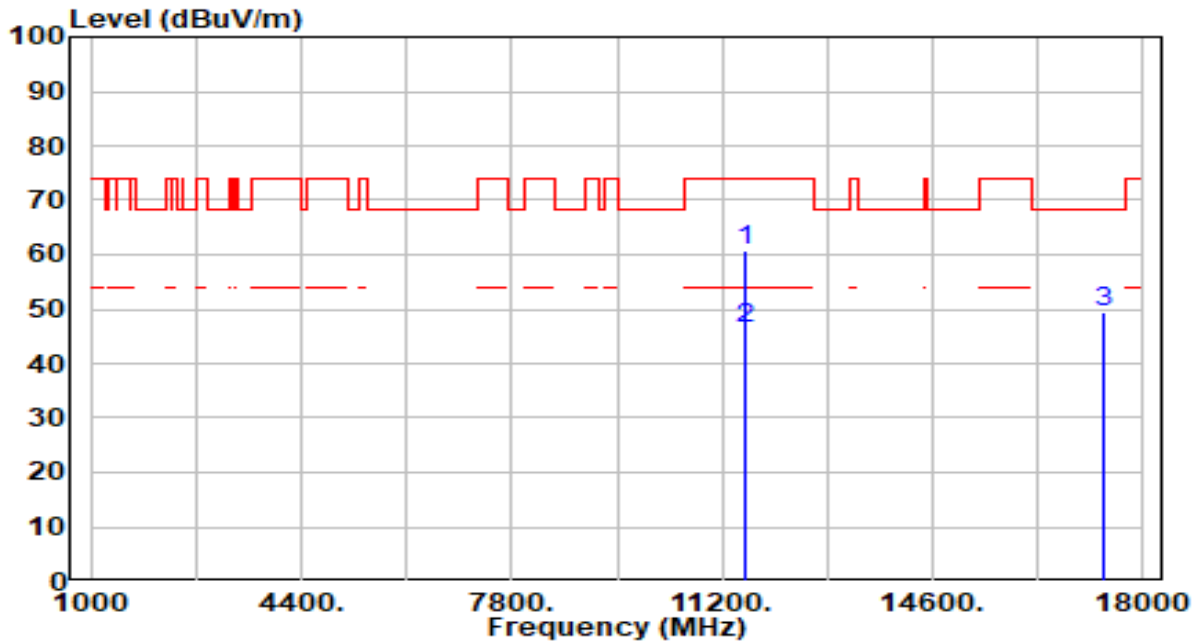

No	Frequency (MHz)	Reading (dBuV)	C.F (dB/m)	Measurement (dBuV/m)	Margin (dB)	Limit (dBuV/m)	Height (cm)	Angle (deg)	Remark (QP/PK/AV)
1	11570.000	57.04	3.65	60.69	-13.31	74.00	300	360	Peak
2	* 11570.000	42.58	3.65	46.23	-7.77	54.00	300	360	Average
3	17355.000	45.23	4.06	49.29	-18.91	68.20	300	47	Peak

Note:

1. " *", means this data is the worst emission level.
2. C.F (Correction Factor) = Antenna Factor (dB/m)+ Cable Loss (dB) – Preamplifier(dB).
3. Measurement (dBuV/m) = Reading(dBuV) + C.F (Correction Factor).
4. The emission levels of other frequencies are very lower than the limit and not show in test report.

EUT	AX1800 Indoor/Outdoor Wi-Fi Access Point	Date of Test	2023-09-22
Factor	DRH18-E	Temp. / Humidity	20°C /60%
Polarity	Horizontal	Site / Test Engineer	AC2 / Stanley
Test Mode	802.11ac-20MHz_TX_Band4_CH 165_ANT 0+1	Test Voltage	AC 120V/60Hz

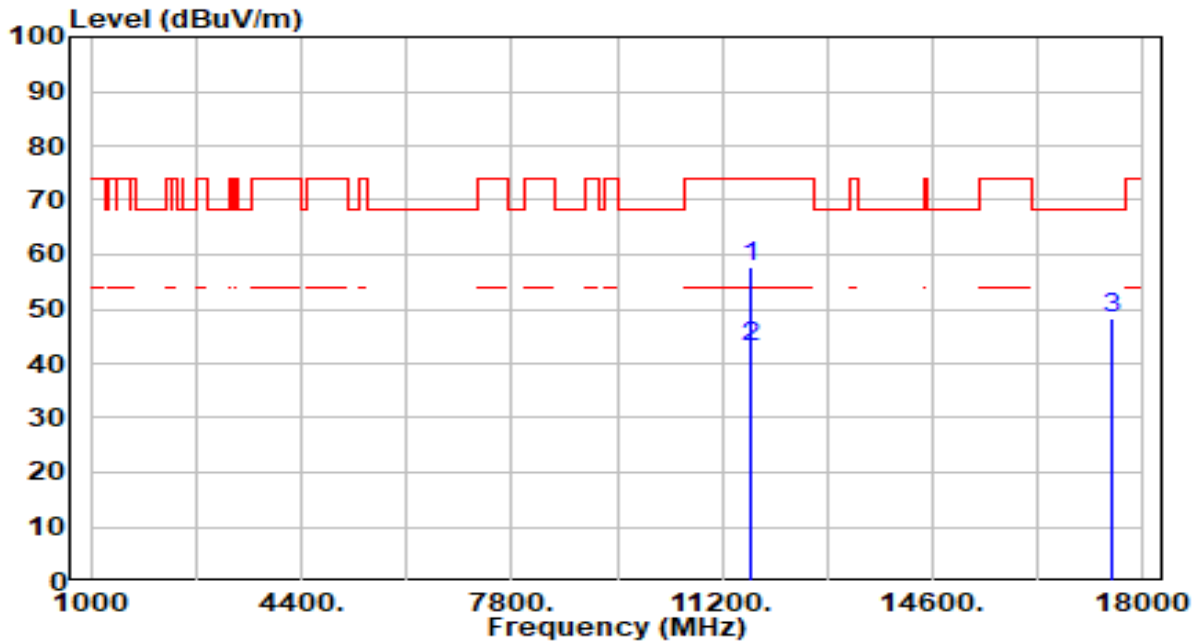

No	Frequency (MHz)	Reading (dBuV)	C.F (dB/m)	Measurement (dBuV/m)	Margin (dB)	Limit (dBuV/m)	Height (cm)	Angle (deg)	Remark (QP/PK/AV)
1	11650.000	54.06	3.66	57.72	-16.28	74.00	300	324	Peak
2	* 11650.000	39.29	3.66	42.95	-11.05	54.00	300	324	Average
3	17475.000	44.28	3.89	48.17	-20.03	68.20	300	170	Peak

Note:

1. " *", means this data is the worst emission level.
2. C.F (Correction Factor) = Antenna Factor (dB/m)+ Cable Loss (dB) – Preamplifier(dB).
3. Measurement (dBuV/m) = Reading(dBuV) + C.F (Correction Factor).
4. The emission levels of other frequencies are very lower than the limit and not show in test report.

EUT	AX1800 Indoor/Outdoor Wi-Fi Access Point	Date of Test	2023-09-22
Factor	DRH18-E	Temp. / Humidity	20°C /60%
Polarity	Vertical	Site / Test Engineer	AC2 / Stanley
Test Mode	802.11ac-20MHz_TX_Band4_CH 165_ANT 0+1	Test Voltage	AC 120V/60Hz

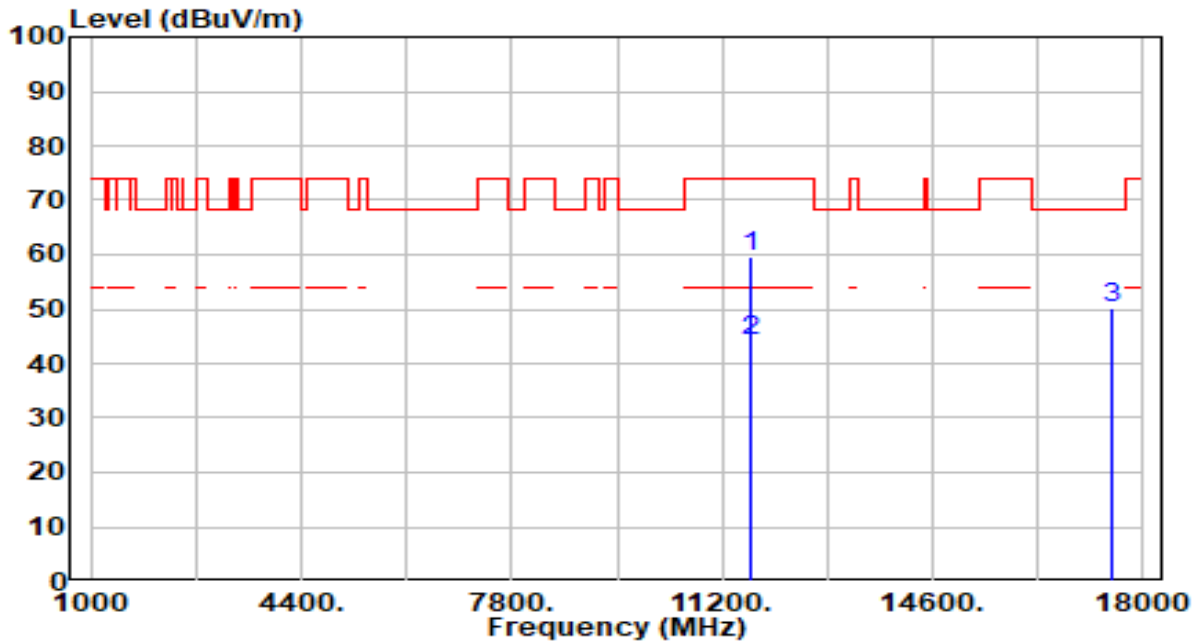

No	Frequency (MHz)	Reading (dBuV)	C.F (dB/m)	Measurement (dBuV/m)	Margin (dB)	Limit (dBuV/m)	Height (cm)	Angle (deg)	Remark (QP/PK/AV)
1	11650.000	56.13	3.66	59.79	-14.21	74.00	300	360	Peak
2	* 11650.000	40.39	3.66	44.05	-9.95	54.00	300	360	Average
3	17475.000	46.21	3.89	50.11	-18.09	68.20	300	25	Peak

Note:

1. " *", means this data is the worst emission level.
2. C.F (Correction Factor) = Antenna Factor (dB/m)+ Cable Loss (dB) – Preamplifier(dB).
3. Measurement (dBuV/m) = Reading(dBuV) + C.F (Correction Factor).
4. The emission levels of other frequencies are very lower than the limit and not show in test report.

EUT	AX1800 Indoor/Outdoor Wi-Fi Access Point	Date of Test	2023-09-22
Factor	DRH18-E	Temp. / Humidity	20°C /60%
Polarity	Horizontal	Site / Test Engineer	AC2 / Stanley
Test Mode	802.11ac-40MHz_TX_Band1_CH 38_ANT 0+1	Test Voltage	AC 120V/60Hz

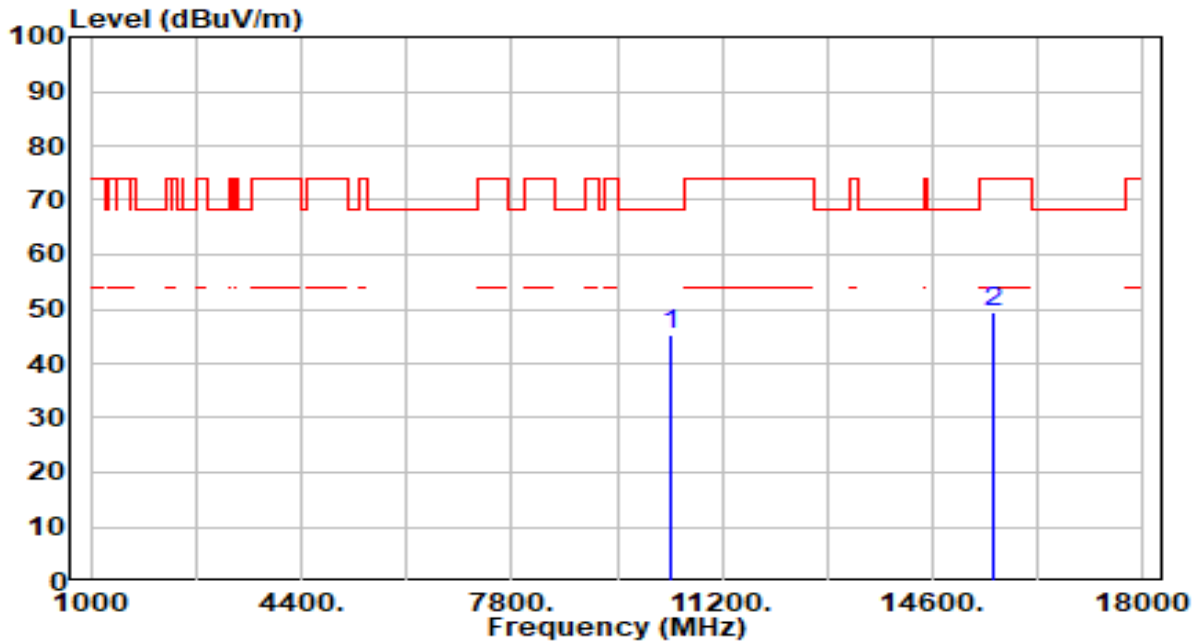

No	Frequency (MHz)	Reading (dBuV)	C.F (dB/m)	Measurement (dBuV/m)	Margin (dB)	Limit (dBuV/m)	Height (cm)	Angle (deg)	Remark (QP/PK/AV)
1	* 10380.000	42.47	2.79	45.26	-22.94	68.20	300	134	Peak
2	15570.000	45.06	4.52	49.57	-24.43	74.00	300	258	Peak

Note:

1. " *", means this data is the worst emission level.
2. C.F (Correction Factor) = Antenna Factor (dB/m)+ Cable Loss (dB) – Pre-amplifier(dB).
3. Measurement (dBuV/m) = Reading(dBuV) + C.F (Correction Factor).
4. The emission levels of other frequencies are very lower than the limit and not show in test report.

EUT	AX1800 Indoor/Outdoor Wi-Fi Access Point	Date of Test	2023-09-22
Factor	DRH18-E	Temp. / Humidity	20°C /60%
Polarity	Vertical	Site / Test Engineer	AC2 / Stanley
Test Mode	802.11ac-40MHz_TX_Band1_CH 38_ANT 0+1	Test Voltage	AC 120V/60Hz

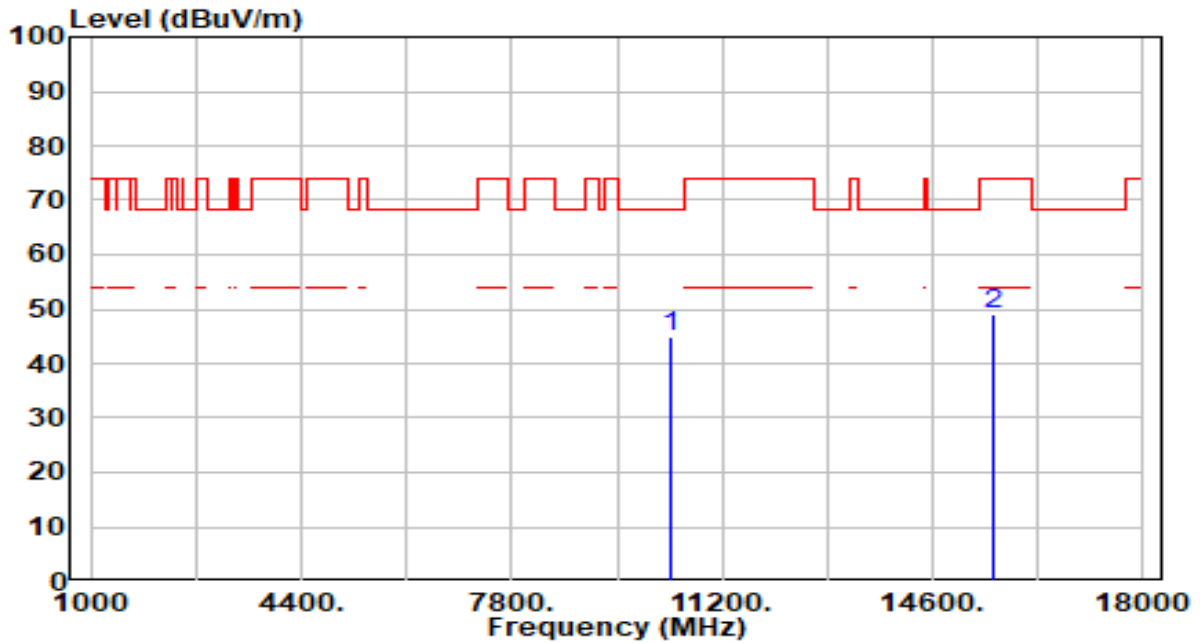

No	Frequency (MHz)	Reading (dBuV)	C.F (dB/m)	Measurement (dBuV/m)	Margin (dB)	Limit (dBuV/m)	Height (cm)	Angle (deg)	Remark (QP/PK/AV)
1	* 10380.000	42.17	2.79	44.96	-23.24	68.20	300	360	Peak
2	15570.000	44.64	4.52	49.15	-24.85	74.00	300	46	Peak

Note:

1. " *", means this data is the worst emission level.
2. C.F (Correction Factor) = Antenna Factor (dB/m)+ Cable Loss (dB) – Pre-amplifier(dB).
3. Measurement (dBuV/m) = Reading(dBuV) + C.F (Correction Factor).
4. The emission levels of other frequencies are very lower than the limit and not show in test report.

EUT	AX1800 Indoor/Outdoor Wi-Fi Access Point	Date of Test	2023-09-22
Factor	DRH18-E	Temp. / Humidity	20°C /60%
Polarity	Horizontal	Site / Test Engineer	AC2 / Stanley
Test Mode	802.11ac-40MHz_TX_Band1_CH 46_ANT 0+1	Test Voltage	AC 120V/60Hz

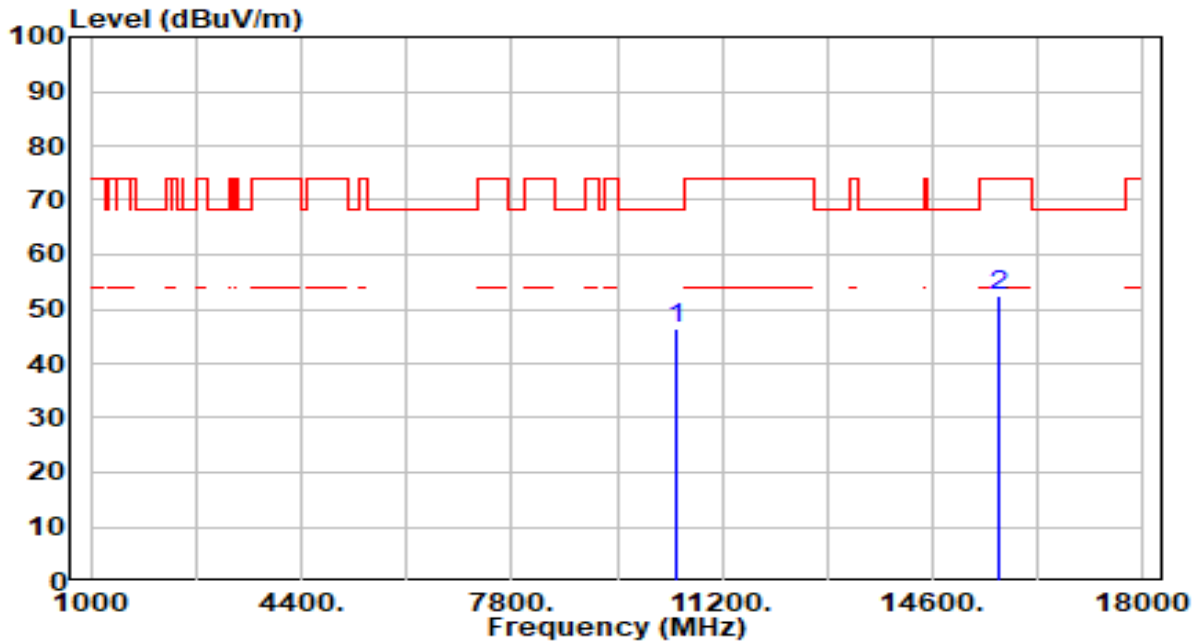

No	Frequency (MHz)	Reading (dBuV)	C.F (dB/m)	Measurement (dBuV/m)	Margin (dB)	Limit (dBuV/m)	Height (cm)	Angle (deg)	Remark (QP/PK/AV)
1	10460.000	43.74	2.70	46.44	-21.76	68.20	300	31	Peak
2	* 15690.000	47.67	4.75	52.42	-21.58	74.00	300	129	Peak

Note:

1. " *", means this data is the worst emission level.
2. C.F (Correction Factor) = Antenna Factor (dB/m)+ Cable Loss (dB) – Preamplifier(dB).
3. Measurement (dBuV/m) = Reading(dBuV) + C.F (Correction Factor).
4. The emission levels of other frequencies are very lower than the limit and not show in test report.

EUT	AX1800 Indoor/Outdoor Wi-Fi Access Point	Date of Test	2023-09-22
Factor	DRH18-E	Temp. / Humidity	20°C /60%
Polarity	Vertical	Site / Test Engineer	AC2 / Stanley
Test Mode	802.11ac-40MHz_TX_Band1_CH 46_ANT 0+1	Test Voltage	AC 120V/60Hz

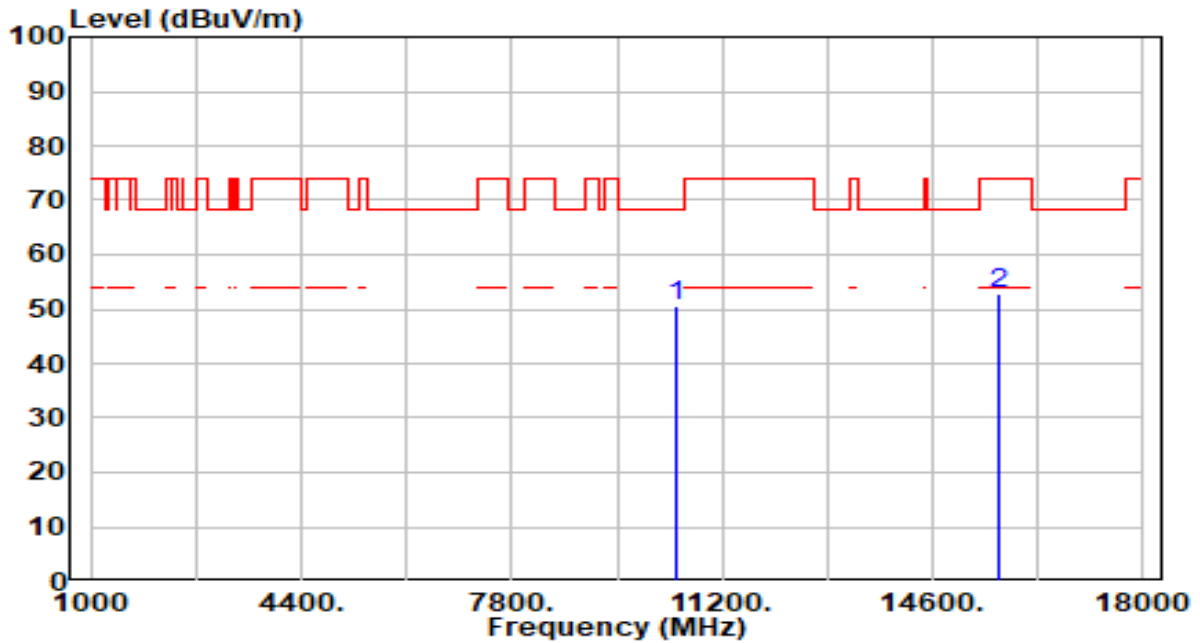

No	Frequency (MHz)	Reading (dBuV)	C.F (dB/m)	Measurement (dBuV/m)	Margin (dB)	Limit (dBuV/m)	Height (cm)	Angle (deg)	Remark (QP/PK/AV)
1	* 10460.000	47.70	2.70	50.40	-17.80	68.20	300	9	Peak
2	15690.000	47.99	4.75	52.75	-21.25	74.00	300	23	Peak

Note:

1. " *", means this data is the worst emission level.
2. C.F (Correction Factor) = Antenna Factor (dB/m)+ Cable Loss (dB) – Pre-amplifier(dB).
3. Measurement (dBuV/m) = Reading(dBuV) + C.F (Correction Factor).
4. The emission levels of other frequencies are very lower than the limit and not show in test report.

EUT	AX1800 Indoor/Outdoor Wi-Fi Access Point	Date of Test	2023-09-22
Factor	DRH18-E	Temp. / Humidity	20°C /60%
Polarity	Horizontal	Site / Test Engineer	AC2 / Stanley
Test Mode	802.11ac-40MHz_TX_Band2_CH 54_ANT 0+1	Test Voltage	AC 120V/60Hz

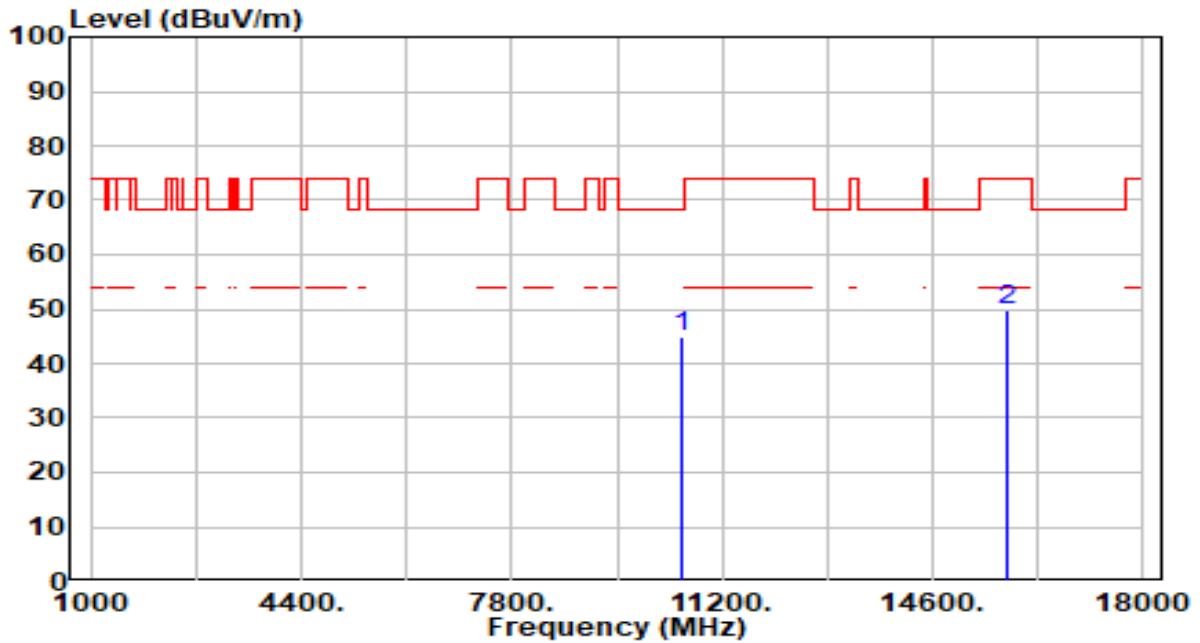

No	Frequency (MHz)	Reading (dBuV)	C.F (dB/m)	Measurement (dBuV/m)	Margin (dB)	Limit (dBuV/m)	Height (cm)	Angle (deg)	Remark (QP/PK/AV)
1	* 10540.000	42.31	2.63	44.94	-23.26	68.20	300	264	Peak
2	15810.000	44.91	5.06	49.97	-24.03	74.00	300	248	Peak

Note:

1. " *", means this data is the worst emission level.
2. C.F (Correction Factor) = Antenna Factor (dB/m)+ Cable Loss (dB) – Pre-amplifier(dB).
3. Measurement (dBuV/m) = Reading(dBuV) + C.F (Correction Factor).
4. The emission levels of other frequencies are very lower than the limit and not show in test report.

EUT	AX1800 Indoor/Outdoor Wi-Fi Access Point	Date of Test	2023-09-22
Factor	DRH18-E	Temp. / Humidity	20°C /60%
Polarity	Vertical	Site / Test Engineer	AC2 / Stanley
Test Mode	802.11ac-40MHz_TX_Band2_CH 54_ANT 0+1	Test Voltage	AC 120V/60Hz

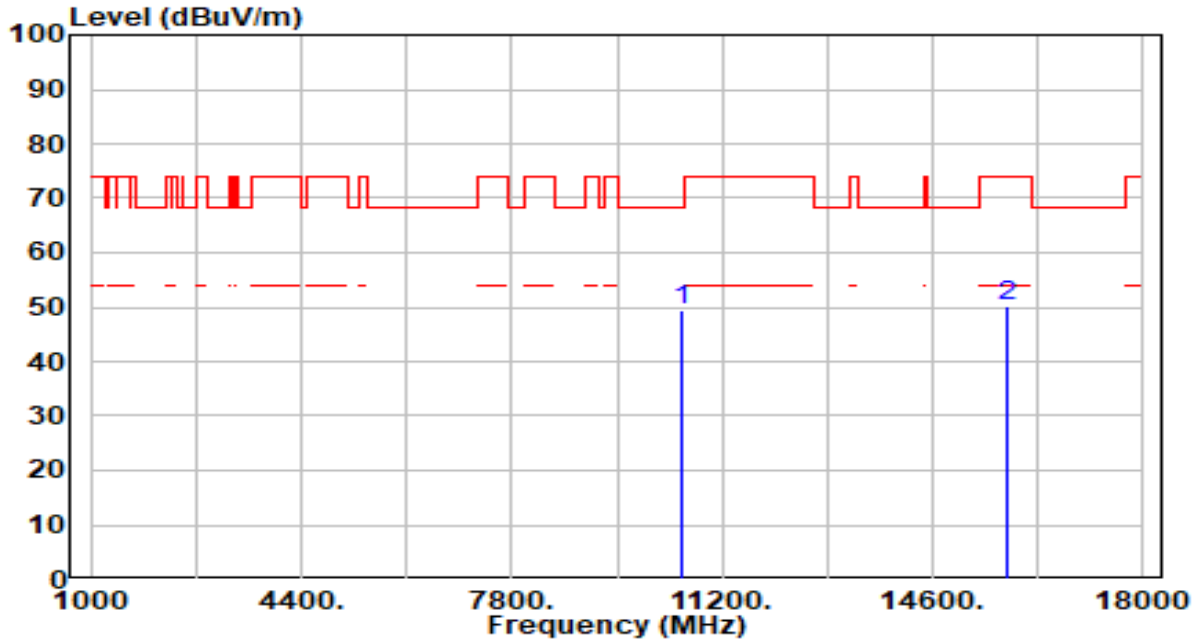

No	Frequency (MHz)	Reading (dBuV)	C.F (dB/m)	Measurement (dBuV/m)	Margin (dB)	Limit (dBuV/m)	Height (cm)	Angle (deg)	Remark (QP/PK/AV)
1	* 10540.000	46.64	2.63	49.27	-18.93	68.20	300	7	Peak
2	15810.000	45.21	5.06	50.27	-23.73	74.00	300	351	Peak

Note:

1. " *", means this data is the worst emission level.
2. C.F (Correction Factor) = Antenna Factor (dB/m)+ Cable Loss (dB) – Pre-amplifier(dB).
3. Measurement (dBuV/m) = Reading(dBuV) + C.F (Correction Factor).
4. The emission levels of other frequencies are very lower than the limit and not show in test report.

EUT	AX1800 Indoor/Outdoor Wi-Fi Access Point	Date of Test	2023-09-22
Factor	DRH18-E	Temp. / Humidity	20°C /60%
Polarity	Horizontal	Site / Test Engineer	AC2 / Stanley
Test Mode	802.11ac-40MHz_TX_Band2_CH 62_ANT 0+1	Test Voltage	AC 120V/60Hz

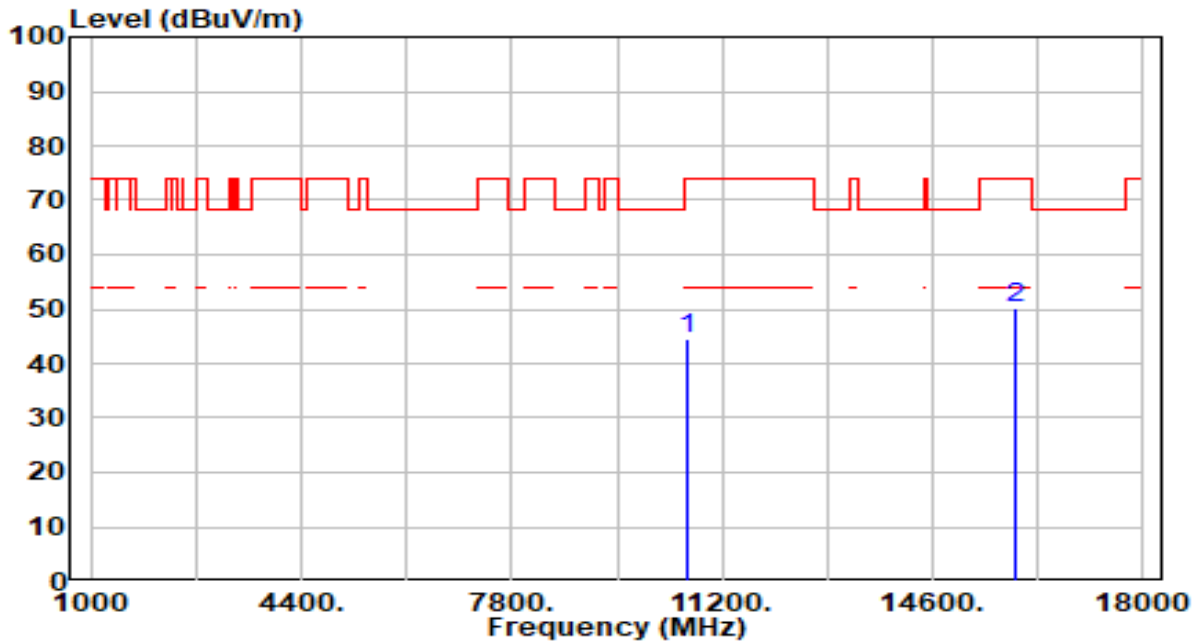

No	Frequency (MHz)	Reading (dBuV)	C.F (dB/m)	Measurement (dBuV/m)	Margin (dB)	Limit (dBuV/m)	Height (cm)	Angle (deg)	Remark (QP/PK/AV)
1	10620.000	41.74	2.61	44.36	-29.64	74.00	300	146	Peak
2	* 15930.000	44.90	5.15	50.05	-23.95	74.00	300	63	Peak

Note:

1. " *", means this data is the worst emission level.
2. C.F (Correction Factor) = Antenna Factor (dB/m)+ Cable Loss (dB) – Pre-amplifier(dB).
3. Measurement (dBuV/m) = Reading(dBuV) + C.F (Correction Factor).
4. The emission levels of other frequencies are very lower than the limit and not show in test report.

EUT	AX1800 Indoor/Outdoor Wi-Fi Access Point	Date of Test	2023-09-22
Factor	DRH18-E	Temp. / Humidity	20°C /60%
Polarity	Vertical	Site / Test Engineer	AC2 / Stanley
Test Mode	802.11ac-40MHz_TX_Band2_CH 62_ANT 0+1	Test Voltage	AC 120V/60Hz

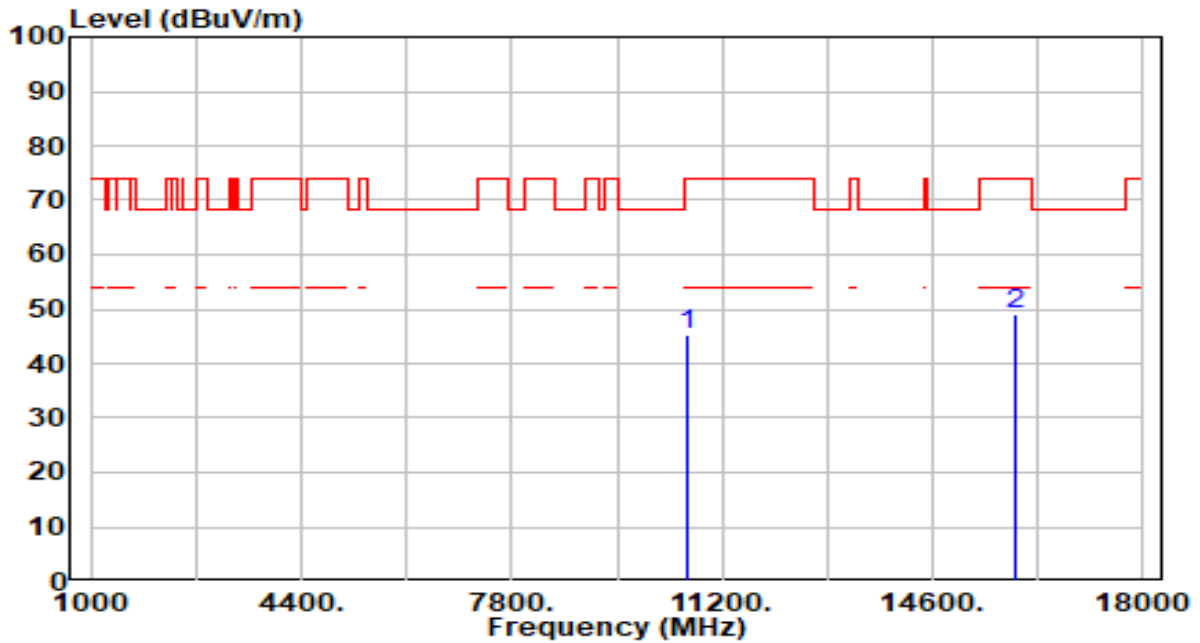

No	Frequency (MHz)	Reading (dBuV)	C.F (dB/m)	Measurement (dBuV/m)	Margin (dB)	Limit (dBuV/m)	Height (cm)	Angle (deg)	Remark (QP/PK/AV)
1	10620.000	42.70	2.61	45.31	-28.69	74.00	300	271	Peak
2	* 15930.000	43.84	5.15	48.99	-25.01	74.00	300	254	Peak

Note:

1. " *", means this data is the worst emission level.
2. C.F (Correction Factor) = Antenna Factor (dB/m)+ Cable Loss (dB) – Pre-amplifier(dB).
3. Measurement (dBuV/m) = Reading(dBuV) + C.F (Correction Factor).
4. The emission levels of other frequencies are very lower than the limit and not show in test report.

EUT	AX1800 Indoor/Outdoor Wi-Fi Access Point	Date of Test	2023-09-22
Factor	DRH18-E	Temp. / Humidity	20°C /60%
Polarity	Horizontal	Site / Test Engineer	AC2 / Stanley
Test Mode	802.11ac-40MHz_TX_Band3_CH 102_ANT 0+1	Test Voltage	AC 120V/60Hz

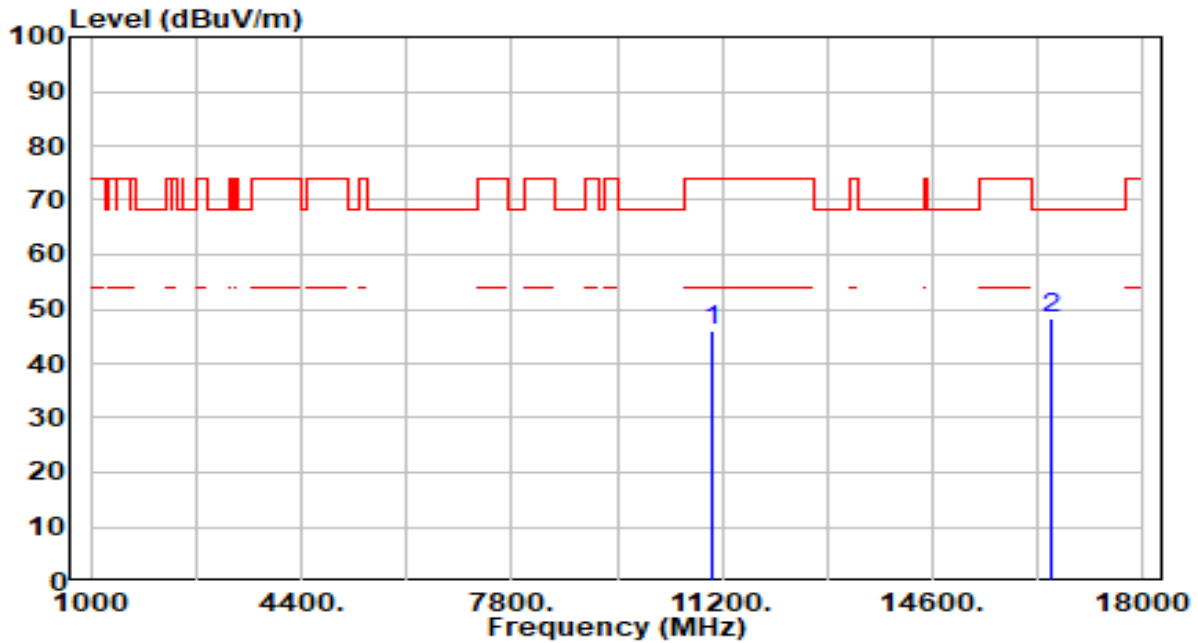

No	Frequency (MHz)	Reading (dBuV)	C.F (dB/m)	Measurement (dBuV/m)	Margin (dB)	Limit (dBuV/m)	Height (cm)	Angle (deg)	Remark (QP/PK/AV)
1	11020.000	43.31	2.66	45.97	-28.03	74.00	300	323	Peak
2	* 16530.000	43.75	4.63	48.37	-19.83	68.20	300	272	Peak

Note:

1. " *", means this data is the worst emission level.
2. C.F (Correction Factor) = Antenna Factor (dB/m)+ Cable Loss (dB) – Pre-amplifier(dB).
3. Measurement (dBuV/m) = Reading(dBuV) + C.F (Correction Factor).
4. The emission levels of other frequencies are very lower than the limit and not show in test report.

EUT	AX1800 Indoor/Outdoor Wi-Fi Access Point	Date of Test	2023-09-22
Factor	DRH18-E	Temp. / Humidity	20°C /60%
Polarity	Vertical	Site / Test Engineer	AC2 / Stanley
Test Mode	802.11ac-40MHz_TX_Band3_CH 102_ANT 0+1	Test Voltage	AC 120V/60Hz

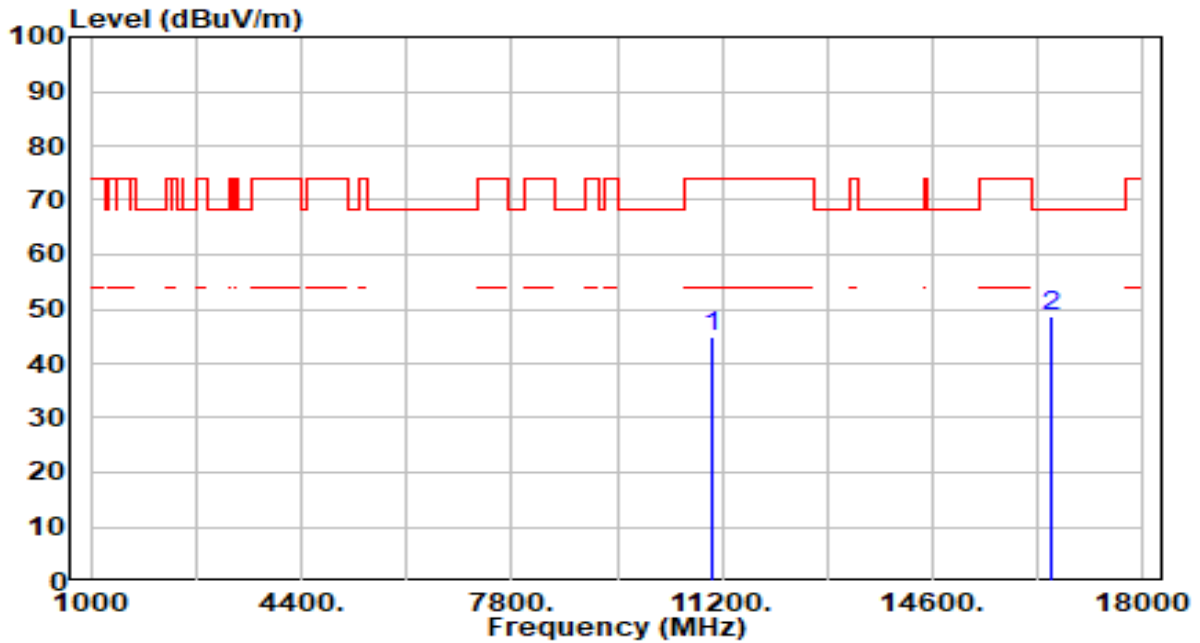

No	Frequency (MHz)	Reading (dBuV)	C.F (dB/m)	Measurement (dBuV/m)	Margin (dB)	Limit (dBuV/m)	Height (cm)	Angle (deg)	Remark (QP/PK/AV)
1	11020.000	42.38	2.66	45.04	-28.96	74.00	300	0	Peak
2	* 16530.000	44.10	4.63	48.73	-19.47	68.20	300	0	Peak

Note:

1. " *", means this data is the worst emission level.
2. C.F (Correction Factor) = Antenna Factor (dB/m)+ Cable Loss (dB) – Pre-amplifier(dB).
3. Measurement (dBuV/m) = Reading(dBuV) + C.F (Correction Factor).
4. The emission levels of other frequencies are very lower than the limit and not show in test report.

EUT	AX1800 Indoor/Outdoor Wi-Fi Access Point	Date of Test	2023-09-22
Factor	DRH18-E	Temp. / Humidity	20°C /60%
Polarity	Horizontal	Site / Test Engineer	AC2 / Stanley
Test Mode	802.11ac-40MHz_TX_Band3_CH 110_ANT 0+1	Test Voltage	AC 120V/60Hz

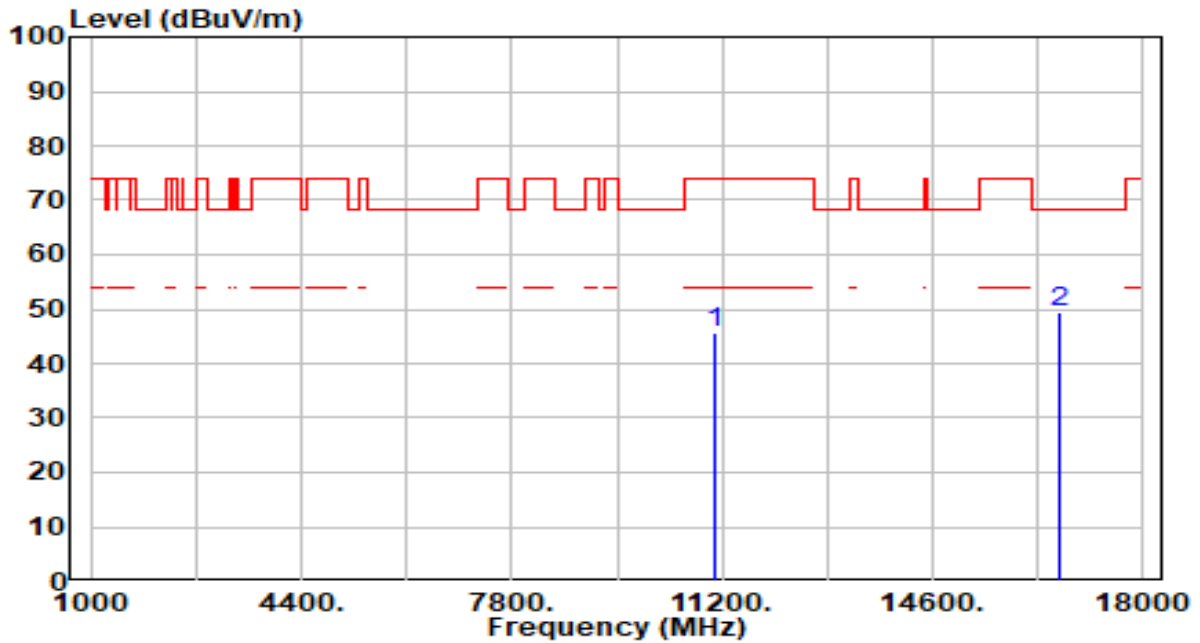

No	Frequency (MHz)	Reading (dBuV)	C.F (dB/m)	Measurement (dBuV/m)	Margin (dB)	Limit (dBuV/m)	Height (cm)	Angle (deg)	Remark (QP/PK/AV)
1	11100.000	42.60	2.90	45.49	-28.51	74.00	300	227	Peak
2	* 16650.000	44.93	4.63	49.56	-18.64	68.20	300	244	Peak

Note:

1. " *", means this data is the worst emission level.
2. C.F (Correction Factor) = Antenna Factor (dB/m)+ Cable Loss (dB) – Pre-amplifier(dB).
3. Measurement (dBuV/m) = Reading(dBuV) + C.F (Correction Factor).
4. The emission levels of other frequencies are very lower than the limit and not show in test report.

EUT	AX1800 Indoor/Outdoor Wi-Fi Access Point	Date of Test	2023-09-22
Factor	DRH18-E	Temp. / Humidity	20°C /60%
Polarity	Vertical	Site / Test Engineer	AC2 / Stanley
Test Mode	802.11ac-40MHz_TX_Band3_CH 110_ANT 0+1	Test Voltage	AC 120V/60Hz

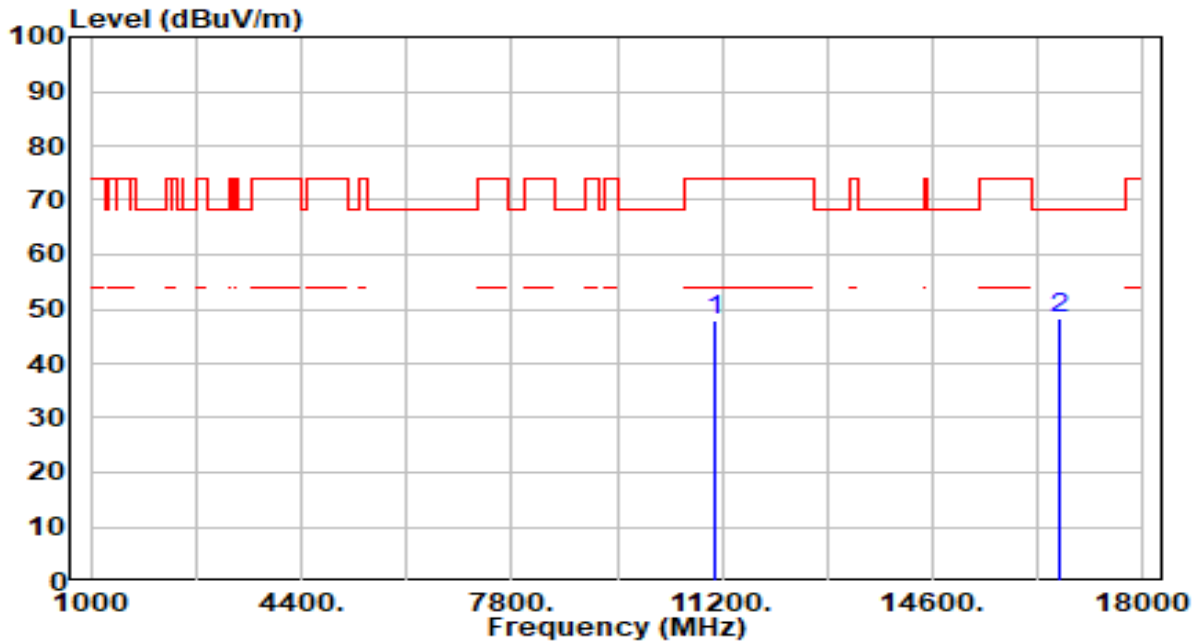

No	Frequency (MHz)	Reading (dBuV)	C.F (dB/m)	Measurement (dBuV/m)	Margin (dB)	Limit (dBuV/m)	Height (cm)	Angle (deg)	Remark (QP/PK/AV)
1	11100.000	45.19	2.90	48.09	-25.91	74.00	300	6	Peak
2	* 16650.000	43.75	4.63	48.38	-19.82	68.20	300	86	Peak

Note:

1. " *", means this data is the worst emission level.
2. C.F (Correction Factor) = Antenna Factor (dB/m)+ Cable Loss (dB) – Pre-amplifier(dB).
3. Measurement (dBuV/m) = Reading(dBuV) + C.F (Correction Factor).
4. The emission levels of other frequencies are very lower than the limit and not show in test report.

EUT	AX1800 Indoor/Outdoor Wi-Fi Access Point	Date of Test	2023-09-22
Factor	DRH18-E	Temp. / Humidity	20°C /60%
Polarity	Horizontal	Site / Test Engineer	AC2 / Stanley
Test Mode	802.11ac-40MHz_TX_Band3_CH 134_ANT 0+1	Test Voltage	AC 120V/60Hz

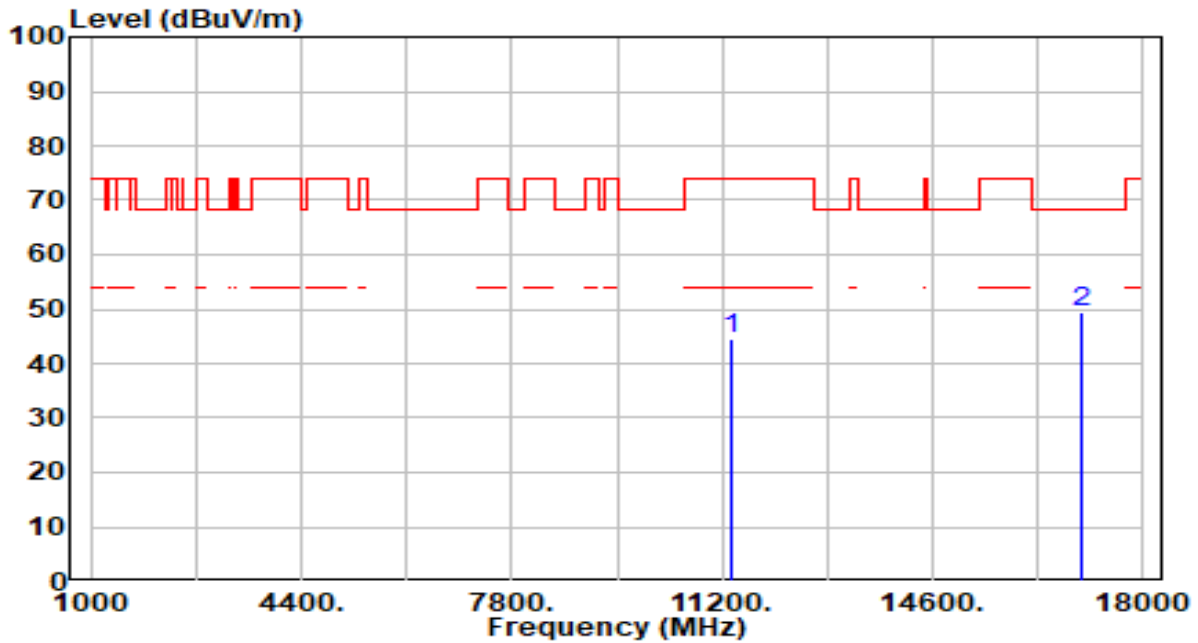

No	Frequency (MHz)	Reading (dBuV)	C.F (dB/m)	Measurement (dBuV/m)	Margin (dB)	Limit (dBuV/m)	Height (cm)	Angle (deg)	Remark (QP/PK/AV)
1	11340.000	41.23	3.39	44.62	-29.38	74.00	300	329	Peak
2	* 17010.000	44.36	5.00	49.35	-18.85	68.20	300	129	Peak

Note:

1. " *", means this data is the worst emission level.
2. C.F (Correction Factor) = Antenna Factor (dB/m)+ Cable Loss (dB) – Pre-amplifier(dB).
3. Measurement (dBuV/m) = Reading(dBuV) + C.F (Correction Factor).
4. The emission levels of other frequencies are very lower than the limit and not show in test report.

EUT	AX1800 Indoor/Outdoor Wi-Fi Access Point	Date of Test	2023-09-22
Factor	DRH18-E	Temp. / Humidity	20°C /60%
Polarity	Vertical	Site / Test Engineer	AC2 / Stanley
Test Mode	802.11ac-40MHz_TX_Band3_CH 134_ANT 0+1	Test Voltage	AC 120V/60Hz

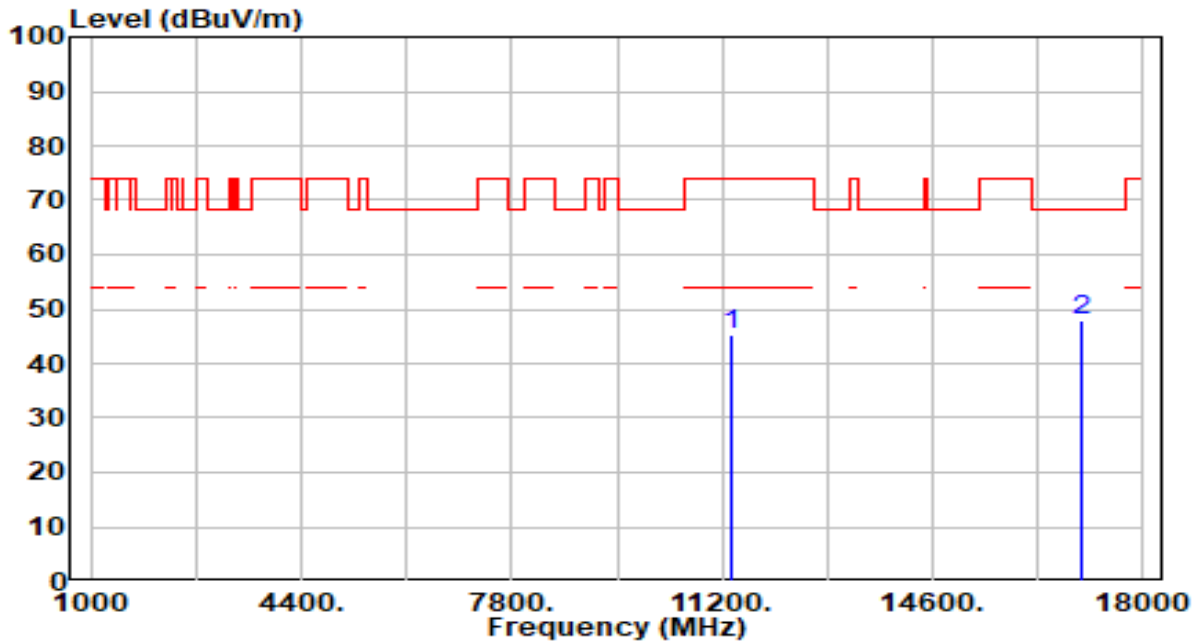

No	Frequency (MHz)	Reading (dBuV)	C.F (dB/m)	Measurement (dBuV/m)	Margin (dB)	Limit (dBuV/m)	Height (cm)	Angle (deg)	Remark (QP/PK/AV)
1	11340.000	42.06	3.39	45.45	-28.55	74.00	300	282	Peak
2	* 17010.000	42.98	5.00	47.97	-20.23	68.20	300	207	Peak

Note:

1. " *", means this data is the worst emission level.
2. C.F (Correction Factor) = Antenna Factor (dB/m)+ Cable Loss (dB) – Pre-amplifier(dB).
3. Measurement (dBuV/m) = Reading(dBuV) + C.F (Correction Factor).
4. The emission levels of other frequencies are very lower than the limit and not show in test report.

EUT	AX1800 Indoor/Outdoor Wi-Fi Access Point	Date of Test	2023-09-22
Factor	DRH18-E	Temp. / Humidity	20°C /60%
Polarity	Horizontal	Site / Test Engineer	AC2 / Stanley
Test Mode	802.11ac-40MHz_TX_Band3_CH 142_ANT 0+1	Test Voltage	AC 120V/60Hz

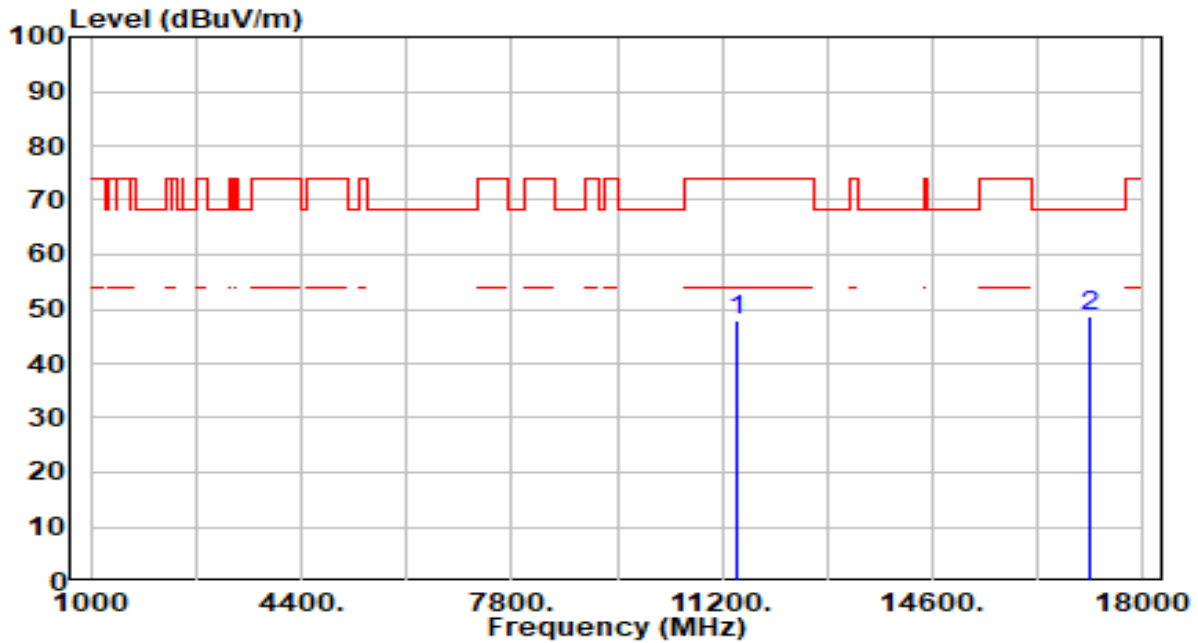

No	Frequency (MHz)	Reading (dBuV)	C.F (dB/m)	Measurement (dBuV/m)	Margin (dB)	Limit (dBuV/m)	Height (cm)	Angle (deg)	Remark (QP/PK/AV)
1	11420.000	44.46	3.50	47.96	-26.04	74.00	300	329	Peak
2	* 17130.000	43.88	4.72	48.60	-19.60	68.20	300	314	Peak

Note:

1. " *", means this data is the worst emission level.
2. C.F (Correction Factor) = Antenna Factor (dB/m)+ Cable Loss (dB) – Pre-amplifier(dB).
3. Measurement (dBuV/m) = Reading(dBuV) + C.F (Correction Factor).
4. The emission levels of other frequencies are very lower than the limit and not show in test report.

EUT	AX1800 Indoor/Outdoor Wi-Fi Access Point	Date of Test	2023-09-22
Factor	DRH18-E	Temp. / Humidity	20°C /60%
Polarity	Vertical	Site / Test Engineer	AC2 / Stanley
Test Mode	802.11ac-40MHz_TX_Band3_CH 142_ANT 0+1	Test Voltage	AC 120V/60Hz

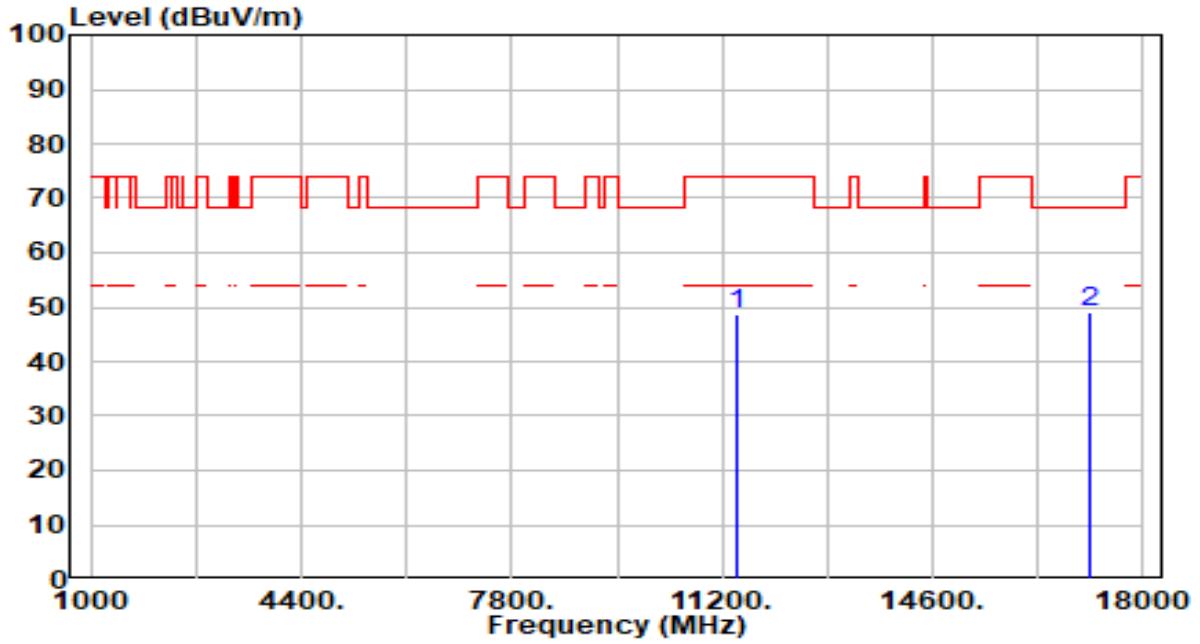

No	Frequency (MHz)	Reading (dBuV)	C.F (dB/m)	Measurement (dBuV/m)	Margin (dB)	Limit (dBuV/m)	Height (cm)	Angle (deg)	Remark (QP/PK/AV)
1	11420.000	45.14	3.50	48.64	-25.36	74.00	300	360	Peak
2	* 17130.000	44.29	4.72	49.02	-19.18	68.20	300	43	Peak

Note:

1. " *", means this data is the worst emission level.
2. C.F (Correction Factor) = Antenna Factor (dB/m)+ Cable Loss (dB) – Pre-amplifier(dB).
3. Measurement (dBuV/m) = Reading(dBuV) + C.F (Correction Factor).
4. The emission levels of other frequencies are very lower than the limit and not show in test report.

EUT	AX1800 Indoor/Outdoor Wi-Fi Access Point	Date of Test	2023-09-22
Factor	DRH18-E	Temp. / Humidity	20°C /60%
Polarity	Horizontal	Site / Test Engineer	AC2 / Stanley
Test Mode	802.11ac-40MHz_TX_Band4_CH 151_ANT 0+1	Test Voltage	AC 120V/60Hz

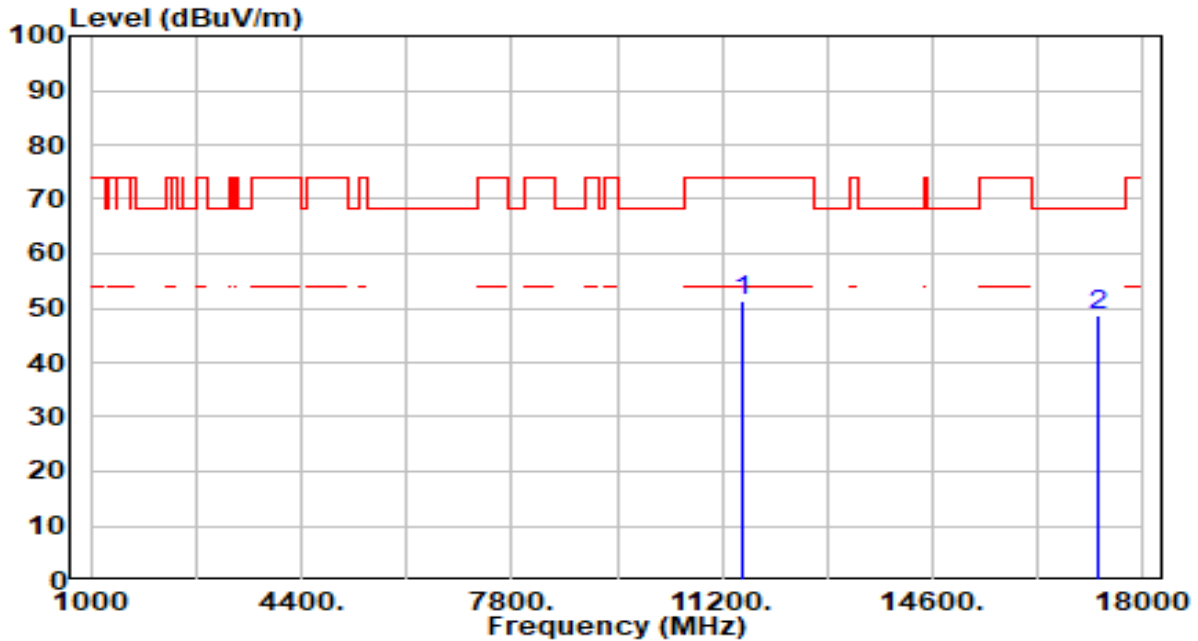

No	Frequency (MHz)	Reading (dBuV)	C.F (dB/m)	Measurement (dBuV/m)	Margin (dB)	Limit (dBuV/m)	Height (cm)	Angle (deg)	Remark (QP/PK/AV)
1	11510.000	47.87	3.59	51.46	-22.54	74.00	300	332	Peak
2	* 17265.000	44.15	4.35	48.50	-19.70	68.20	300	292	Peak

Note:

1. " *", means this data is the worst emission level.
2. C.F (Correction Factor) = Antenna Factor (dB/m)+ Cable Loss (dB) – Preamplifier(dB).
3. Measurement (dBuV/m) = Reading(dBuV) + C.F (Correction Factor).
4. The emission levels of other frequencies are very lower than the limit and not show in test report.

EUT	AX1800 Indoor/Outdoor Wi-Fi Access Point	Date of Test	2023-09-22
Factor	DRH18-E	Temp. / Humidity	20°C /60%
Polarity	Vertical	Site / Test Engineer	AC2 / Stanley
Test Mode	802.11ac-40MHz_TX_Band4_CH 151_ANT 0+1	Test Voltage	AC 120V/60Hz

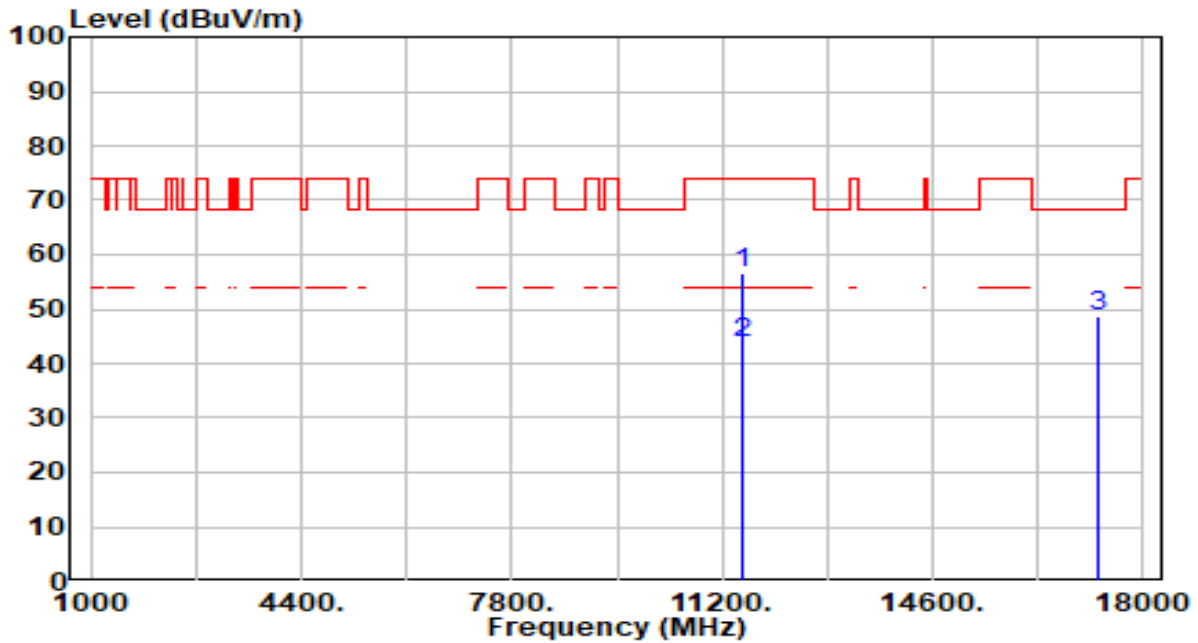

No	Frequency (MHz)	Reading (dBuV)	C.F (dB/m)	Measurement (dBuV/m)	Margin (dB)	Limit (dBuV/m)	Height (cm)	Angle (deg)	Remark (QP/PK/AV)
1	11510.000	53.05	3.59	56.64	-17.36	74.00	300	360	Peak
2	* 11510.000	40.09	3.59	43.68	-10.32	54.00	300	360	Average
3	17265.000	44.15	4.35	48.50	-19.70	68.20	300	300	Peak

Note:

1. " *", means this data is the worst emission level.
2. C.F (Correction Factor) = Antenna Factor (dB/m)+ Cable Loss (dB) – Preamplifier(dB).
3. Measurement (dBuV/m) = Reading(dBuV) + C.F (Correction Factor).
4. The emission levels of other frequencies are very lower than the limit and not show in test report.

EUT	AX1800 Indoor/Outdoor Wi-Fi Access Point	Date of Test	2023-09-22
Factor	DRH18-E	Temp. / Humidity	20°C /60%
Polarity	Horizontal	Site / Test Engineer	AC2 / Stanley
Test Mode	802.11ac-40MHz_TX_Band4_CH 159_ANT 0+1	Test Voltage	AC 120V/60Hz

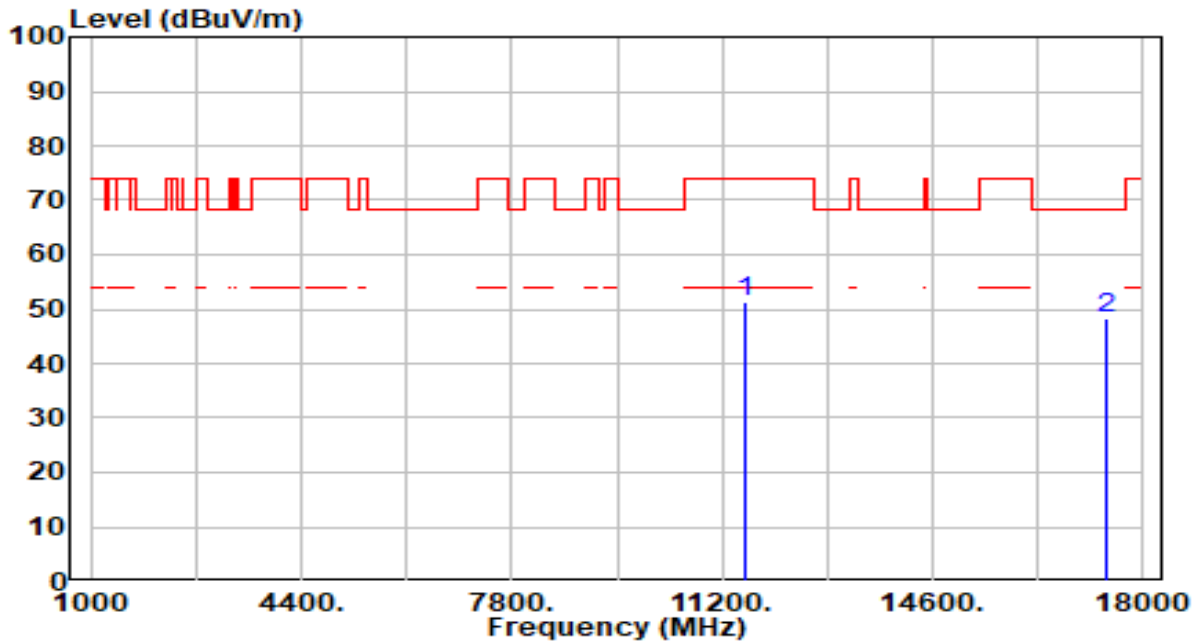

No	Frequency (MHz)	Reading (dBuV)	C.F (dB/m)	Measurement (dBuV/m)	Margin (dB)	Limit (dBuV/m)	Height (cm)	Angle (deg)	Remark (QP/PK/AV)
1	11590.000	47.81	3.67	51.48	-22.52	74.00	300	328	Peak
2	* 17385.000	44.33	3.96	48.30	-19.90	68.20	300	247	Peak

Note:

1. " *", means this data is the worst emission level.
2. C.F (Correction Factor) = Antenna Factor (dB/m)+ Cable Loss (dB) – Preamplifier(dB).
3. Measurement (dBuV/m) = Reading(dBuV) + C.F (Correction Factor).
4. The emission levels of other frequencies are very lower than the limit and not show in test report.

EUT	AX1800 Indoor/Outdoor Wi-Fi Access Point	Date of Test	2023-09-22
Factor	DRH18-E	Temp. / Humidity	20°C /60%
Polarity	Vertical	Site / Test Engineer	AC2 / Stanley
Test Mode	802.11ac-40MHz_TX_Band4_CH 159_ANT 0+1	Test Voltage	AC 120V/60Hz

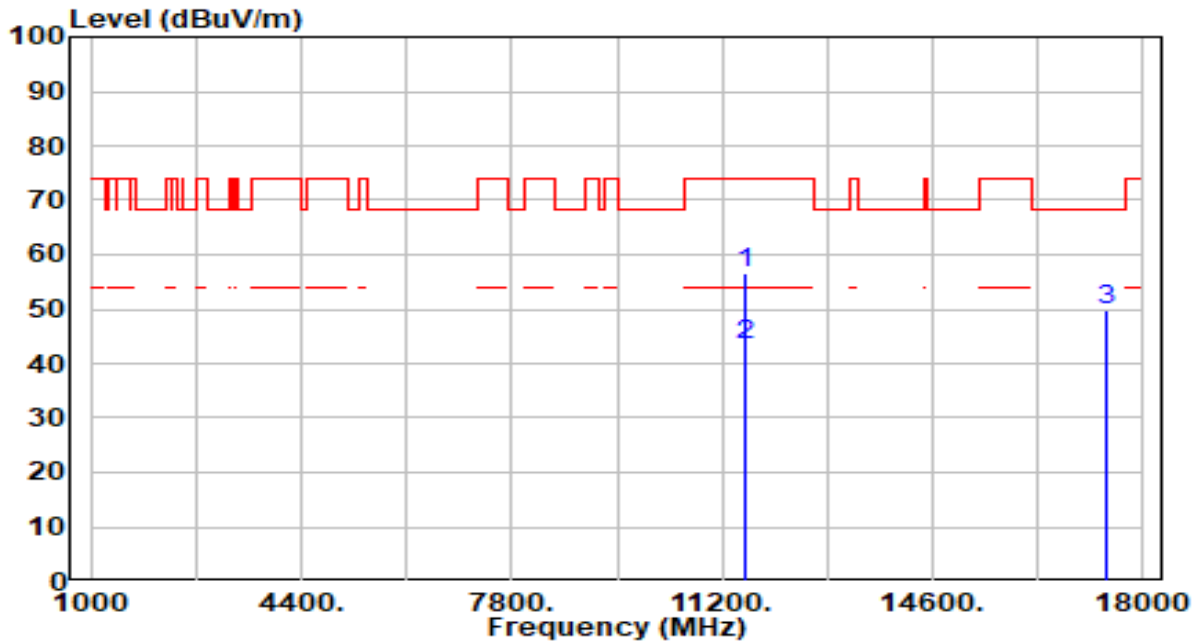

No	Frequency (MHz)	Reading (dBuV)	C.F (dB/m)	Measurement (dBuV/m)	Margin (dB)	Limit (dBuV/m)	Height (cm)	Angle (deg)	Remark (QP/PK/AV)
1	11590.000	53.00	3.67	56.67	-17.33	74.00	300	147	Peak
2	* 11590.000	39.86	3.67	43.53	-10.47	54.00	300	147	Average
3	17385.000	45.85	3.96	49.81	-18.39	68.20	300	20	Peak

Note:

1. " *", means this data is the worst emission level.
2. C.F (Correction Factor) = Antenna Factor (dB/m)+ Cable Loss (dB) – Preamplifier(dB).
3. Measurement (dBuV/m) = Reading(dBuV) + C.F (Correction Factor).
4. The emission levels of other frequencies are very lower than the limit and not show in test report.

EUT	AX1800 Indoor/Outdoor Wi-Fi Access Point	Date of Test	2023-09-22
Factor	DRH18-E	Temp. / Humidity	20°C /60%
Polarity	Horizontal	Site / Test Engineer	AC2 / Stanley
Test Mode	802.11ac-80MHz_TX_Band1_CH 42_ANT 0+1	Test Voltage	AC 120V/60Hz

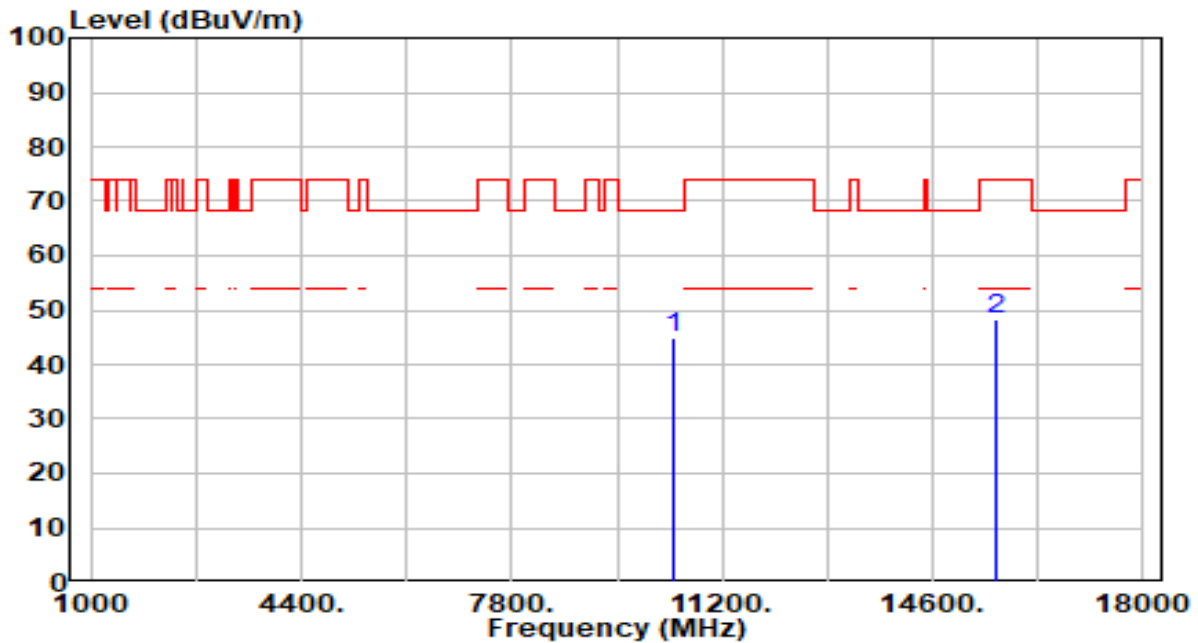

No	Frequency (MHz)	Reading (dBuV)	C.F (dB/m)	Measurement (dBuV/m)	Margin (dB)	Limit (dBuV/m)	Height (cm)	Angle (deg)	Remark (QP/PK/AV)
1	*	42.34	2.74	45.09	-23.11	68.20	300	340	Peak
2		43.60	4.59	48.19	-25.81	74.00	300	14	Peak

Note:

1. " *", means this data is the worst emission level.
2. C.F (Correction Factor) = Antenna Factor (dB/m)+ Cable Loss (dB) – Preamplifier(dB).
3. Measurement (dBuV/m) = Reading(dBuV) + C.F (Correction Factor).
4. The emission levels of other frequencies are very lower than the limit and not show in test report.

EUT	AX1800 Indoor/Outdoor Wi-Fi Access Point	Date of Test	2023-09-22
Factor	DRH18-E	Temp. / Humidity	20°C /60%
Polarity	Vertical	Site / Test Engineer	AC2 / Stanley
Test Mode	802.11ac-80MHz_TX_Band1_CH 42_ANT 0+1	Test Voltage	AC 120V/60Hz

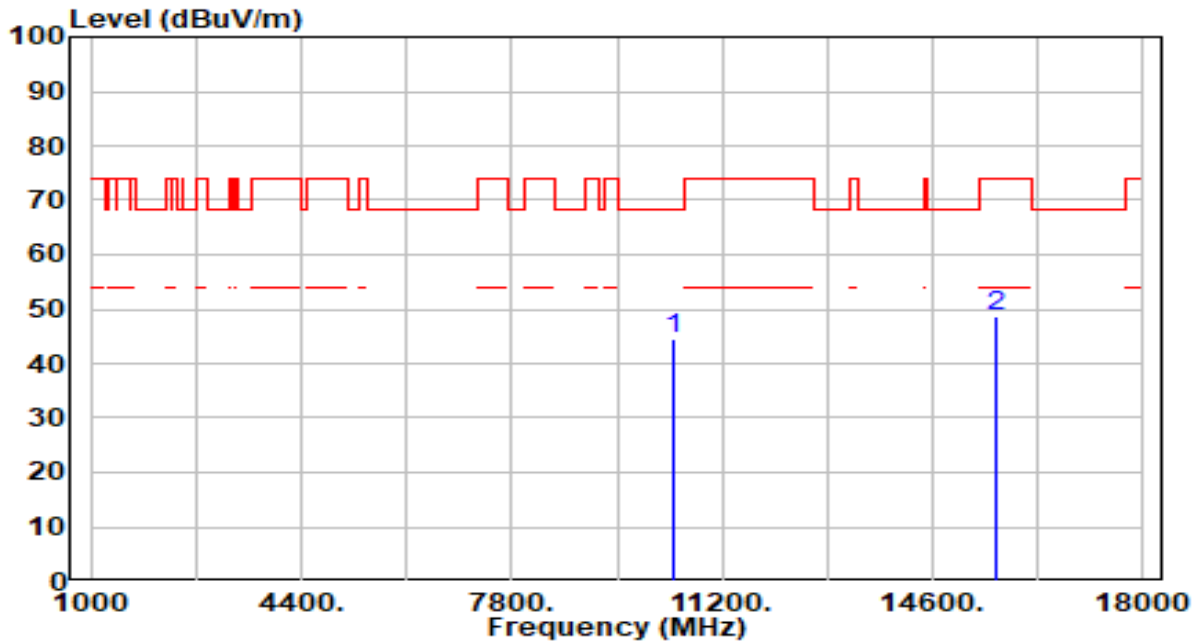

No	Frequency (MHz)	Reading (dBuV)	C.F (dB/m)	Measurement (dBuV/m)	Margin (dB)	Limit (dBuV/m)	Height (cm)	Angle (deg)	Remark (QP/PK/AV)
1	* 10420.000	41.75	2.74	44.49	-23.71	68.20	300	14	Peak
2	15630.000	43.91	4.59	48.50	-25.50	74.00	300	26	Peak

Note:

1. " *", means this data is the worst emission level.
2. C.F (Correction Factor) = Antenna Factor (dB/m)+ Cable Loss (dB) – Pre-amplifier(dB).
3. Measurement (dBuV/m) = Reading(dBuV) + C.F (Correction Factor).
4. The emission levels of other frequencies are very lower than the limit and not show in test report.

EUT	AX1800 Indoor/Outdoor Wi-Fi Access Point	Date of Test	2023-09-22
Factor	DRH18-E	Temp. / Humidity	20°C /60%
Polarity	Horizontal	Site / Test Engineer	AC2 / Stanley
Test Mode	802.11ac-80MHz_TX_Band2_CH 58_ANT 0+1	Test Voltage	AC 120V/60Hz

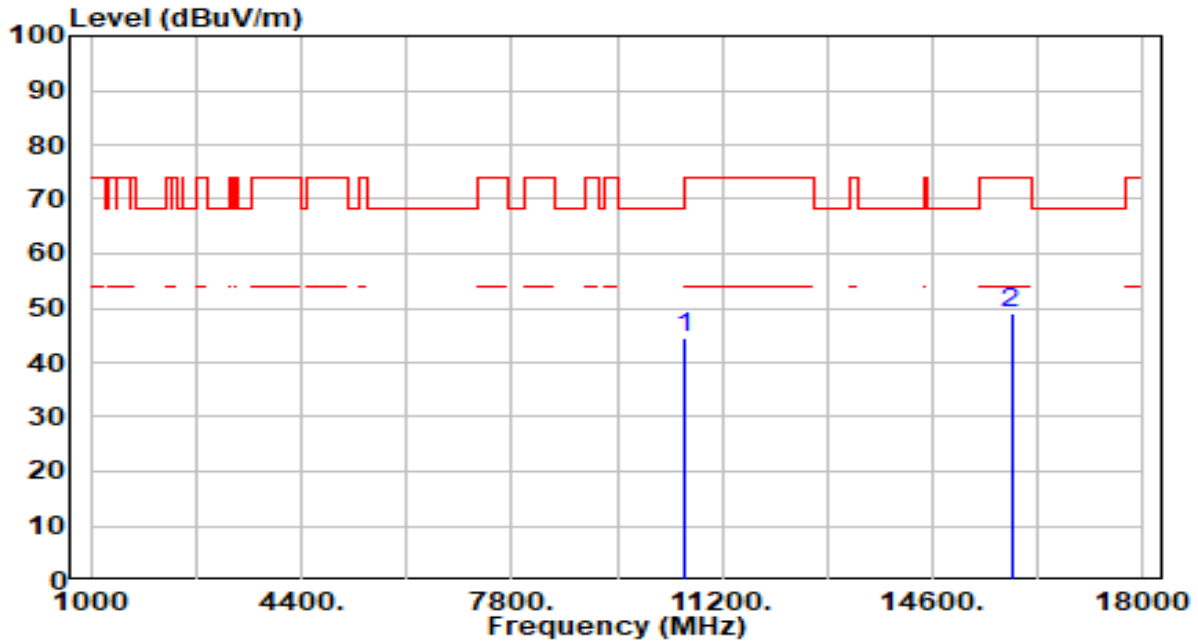

No	Frequency (MHz)	Reading (dBuV)	C.F (dB/m)	Measurement (dBuV/m)	Margin (dB)	Limit (dBuV/m)	Height (cm)	Angle (deg)	Remark (QP/PK/AV)
1	*	42.02	2.61	44.63	-23.57	68.20	300	326	Peak
2		43.96	5.11	49.06	-24.94	74.00	300	279	Peak

Note:

1. " *", means this data is the worst emission level.
2. C.F (Correction Factor) = Antenna Factor (dB/m)+ Cable Loss (dB) – Preamplifier(dB).
3. Measurement (dBuV/m) = Reading(dBuV) + C.F (Correction Factor).
4. The emission levels of other frequencies are very lower than the limit and not show in test report.

EUT	AX1800 Indoor/Outdoor Wi-Fi Access Point	Date of Test	2023-09-22
Factor	DRH18-E	Temp. / Humidity	20°C /60%
Polarity	Vertical	Site / Test Engineer	AC2 / Stanley
Test Mode	802.11ac-80MHz_TX_Band2_CH 58_ANT 0+1	Test Voltage	AC 120V/60Hz

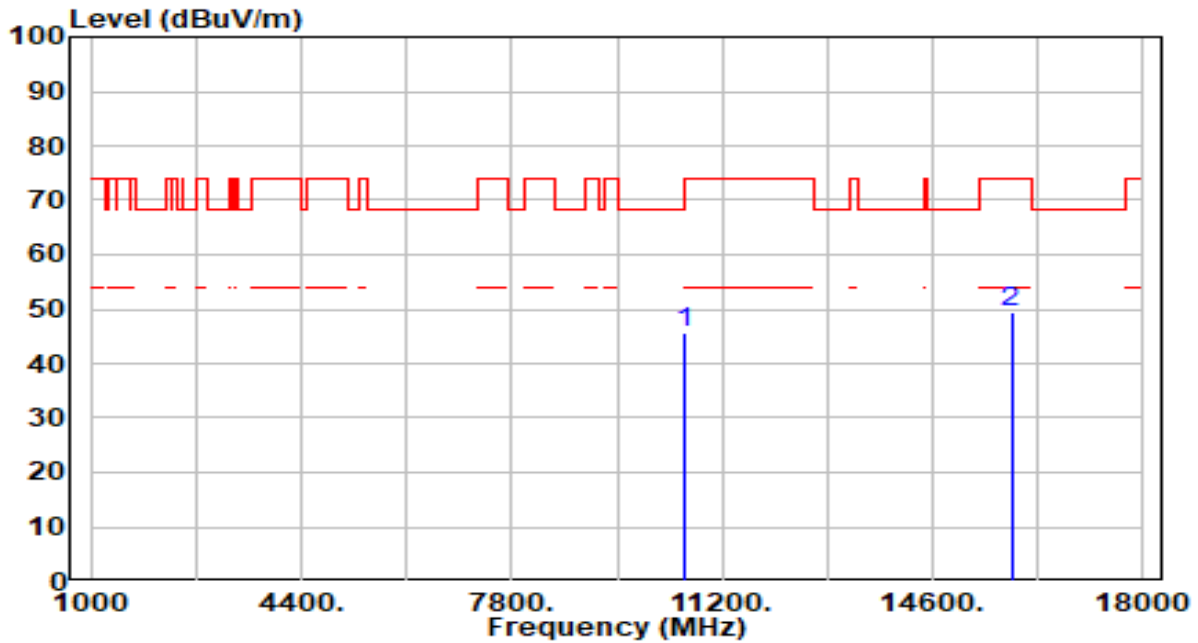

No	Frequency (MHz)	Reading (dBuV)	C.F (dB/m)	Measurement (dBuV/m)	Margin (dB)	Limit (dBuV/m)	Height (cm)	Angle (deg)	Remark (QP/PK/AV)
1	* 10580.000	43.09	2.61	45.70	-22.50	68.20	300	360	Peak
2	15870.000	44.48	5.11	49.58	-24.42	74.00	300	245	Peak

Note:

1. " *", means this data is the worst emission level.
2. C.F (Correction Factor) = Antenna Factor (dB/m)+ Cable Loss (dB) – Pre-amplifier(dB).
3. Measurement (dBuV/m) = Reading(dBuV) + C.F (Correction Factor).
4. The emission levels of other frequencies are very lower than the limit and not show in test report.

EUT	AX1800 Indoor/Outdoor Wi-Fi Access Point	Date of Test	2023-09-22
Factor	DRH18-E	Temp. / Humidity	20°C /60%
Polarity	Horizontal	Site / Test Engineer	AC2 / Stanley
Test Mode	802.11ac-80MHz_TX_Band3_CH 106_ANT 0+1	Test Voltage	AC 120V/60Hz

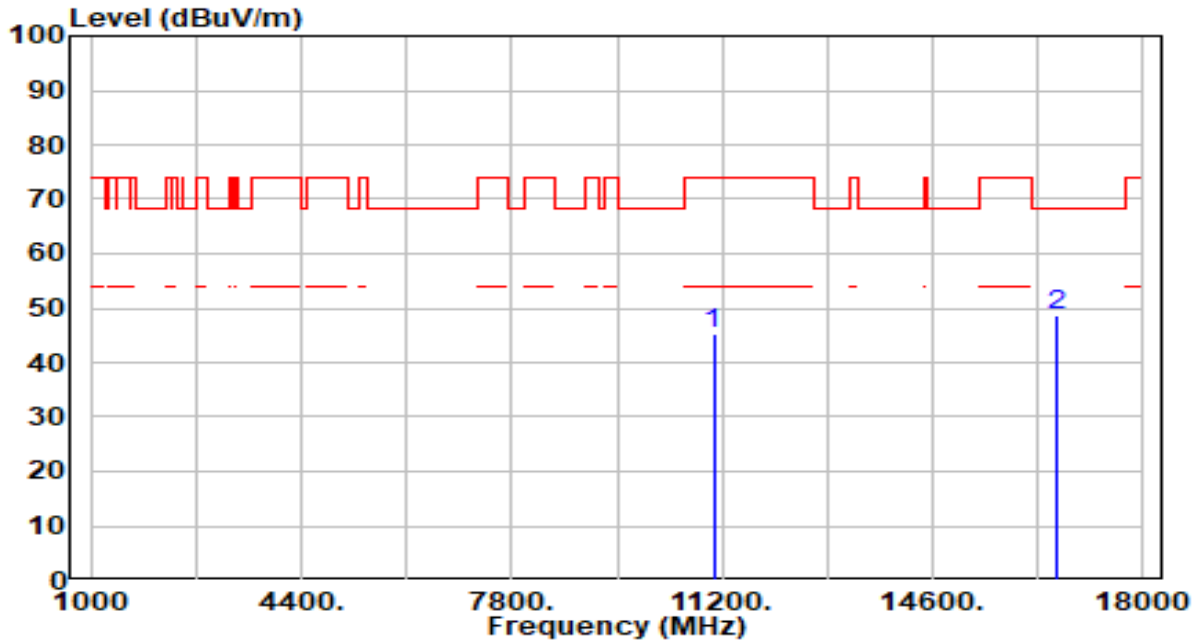

No	Frequency (MHz)	Reading (dBuV)	C.F (dB/m)	Measurement (dBuV/m)	Margin (dB)	Limit (dBuV/m)	Height (cm)	Angle (deg)	Remark (QP/PK/AV)
1	11060.000	42.43	2.78	45.21	-28.79	74.00	300	20	Peak
2	* 16590.000	44.16	4.62	48.78	-19.42	68.20	300	298	Peak

Note:

1. " *", means this data is the worst emission level.
2. C.F (Correction Factor) = Antenna Factor (dB/m)+ Cable Loss (dB) – Preamplifier(dB).
3. Measurement (dBuV/m) = Reading(dBuV) + C.F (Correction Factor).
4. The emission levels of other frequencies are very lower than the limit and not show in test report.

EUT	AX1800 Indoor/Outdoor Wi-Fi Access Point	Date of Test	2023-09-22
Factor	DRH18-E	Temp. / Humidity	20°C /60%
Polarity	Vertical	Site / Test Engineer	AC2 / Stanley
Test Mode	802.11ac-80MHz_TX_Band3_CH 106_ANT 0+1	Test Voltage	AC 120V/60Hz

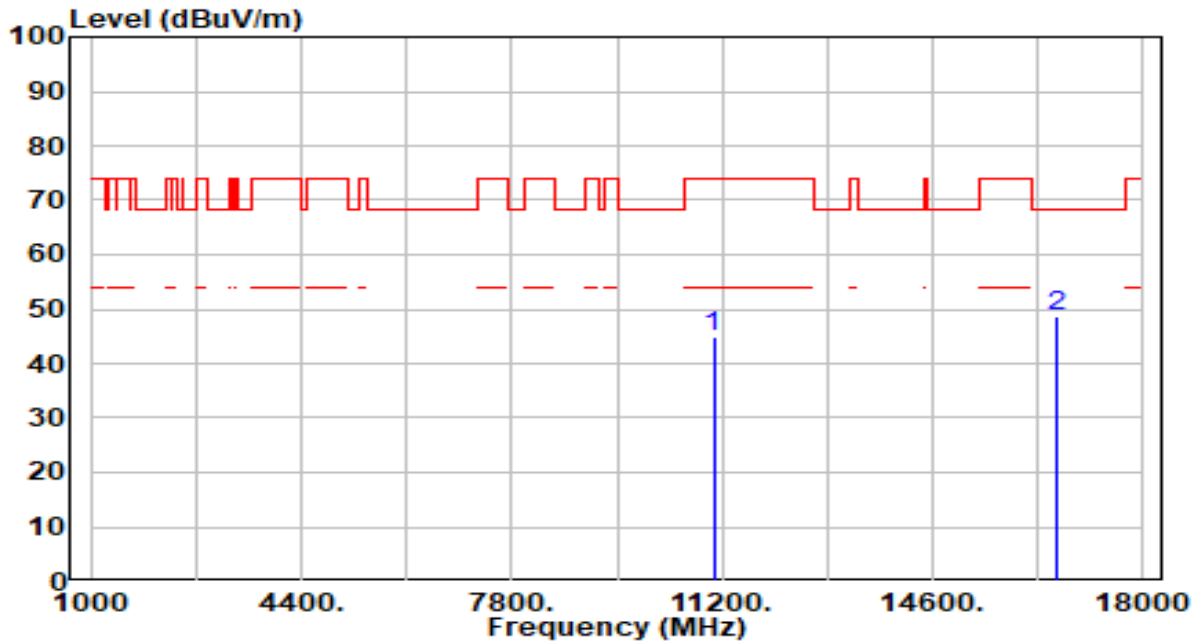

No	Frequency (MHz)	Reading (dBuV)	C.F (dB/m)	Measurement (dBuV/m)	Margin (dB)	Limit (dBuV/m)	Height (cm)	Angle (deg)	Remark (QP/PK/AV)
1	11060.000	42.28	2.78	45.05	-28.95	74.00	300	332	Peak
2	* 16590.000	44.23	4.62	48.85	-19.35	68.20	300	360	Peak

Note:

1. " *", means this data is the worst emission level.
2. C.F (Correction Factor) = Antenna Factor (dB/m)+ Cable Loss (dB) – Pre-amplifier(dB).
3. Measurement (dBuV/m) = Reading(dBuV) + C.F (Correction Factor).
4. The emission levels of other frequencies are very lower than the limit and not show in test report.

EUT	AX1800 Indoor/Outdoor Wi-Fi Access Point	Date of Test	2023-09-22
Factor	DRH18-E	Temp. / Humidity	20°C /60%
Polarity	Horizontal	Site / Test Engineer	AC2 / Stanley
Test Mode	802.11ac-80MHz_TX_Band3_CH 122_ANT 0+1	Test Voltage	AC 120V/60Hz

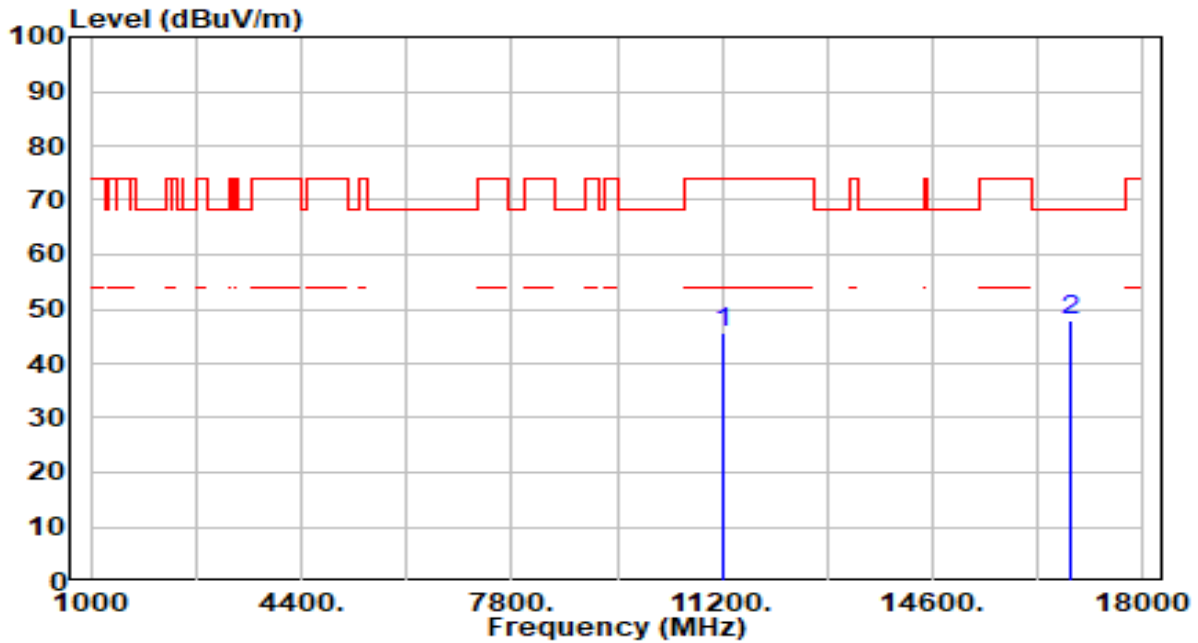

No	Frequency (MHz)	Reading (dBuV)	C.F (dB/m)	Measurement (dBuV/m)	Margin (dB)	Limit (dBuV/m)	Height (cm)	Angle (deg)	Remark (QP/PK/AV)
1	11220.000	42.56	3.22	45.78	-28.22	74.00	300	54	Peak
2	* 16830.000	43.49	4.61	48.10	-20.10	68.20	300	308	Peak

Note:

1. " *", means this data is the worst emission level.
2. C.F (Correction Factor) = Antenna Factor (dB/m)+ Cable Loss (dB) – Preamplifier(dB).
3. Measurement (dBuV/m) = Reading(dBuV) + C.F (Correction Factor).
4. The emission levels of other frequencies are very lower than the limit and not show in test report.

EUT	AX1800 Indoor/Outdoor Wi-Fi Access Point	Date of Test	2023-09-22
Factor	DRH18-E	Temp. / Humidity	20°C /60%
Polarity	Vertical	Site / Test Engineer	AC2 / Stanley
Test Mode	802.11ac-80MHz_TX_Band3_CH 122_ANT 0+1	Test Voltage	AC 120V/60Hz

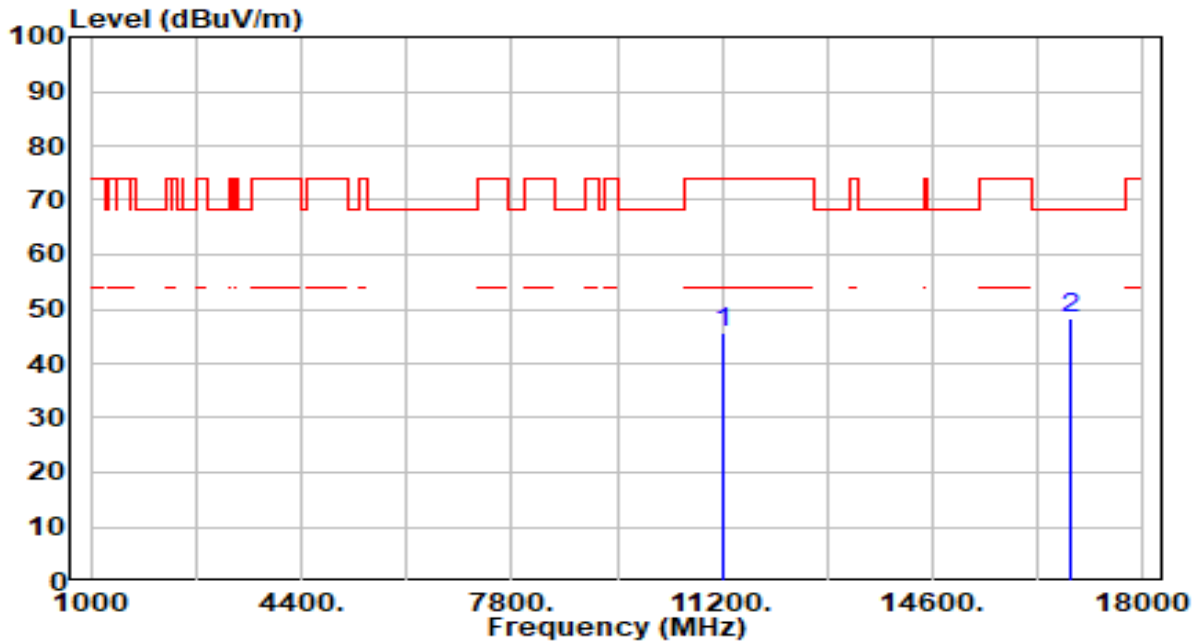

No	Frequency (MHz)	Reading (dBUV)	C.F (dB/m)	Measurement (dBUV/m)	Margin (dB)	Limit (dBUV/m)	Height (cm)	Angle (deg)	Remark (QP/PK/AV)
1	11220.000	42.52	3.22	45.74	-28.26	74.00	300	9	Peak
2	* 16830.000	43.56	4.61	48.17	-20.03	68.20	300	270	Peak

Note:

1. " *", means this data is the worst emission level.
2. C.F (Correction Factor) = Antenna Factor (dB/m)+ Cable Loss (dB) – Pre-amplifier(dB).
3. Measurement (dBUV/m) = Reading(dBUV) + C.F (Correction Factor).
4. The emission levels of other frequencies are very lower than the limit and not show in test report.

EUT	AX1800 Indoor/Outdoor Wi-Fi Access Point	Date of Test	2023-09-22
Factor	DRH18-E	Temp. / Humidity	20°C /60%
Polarity	Horizontal	Site / Test Engineer	AC2 / Stanley
Test Mode	802.11ac-80MHz_TX_Band3_CH 138_ANT 0+1	Test Voltage	AC 120V/60Hz

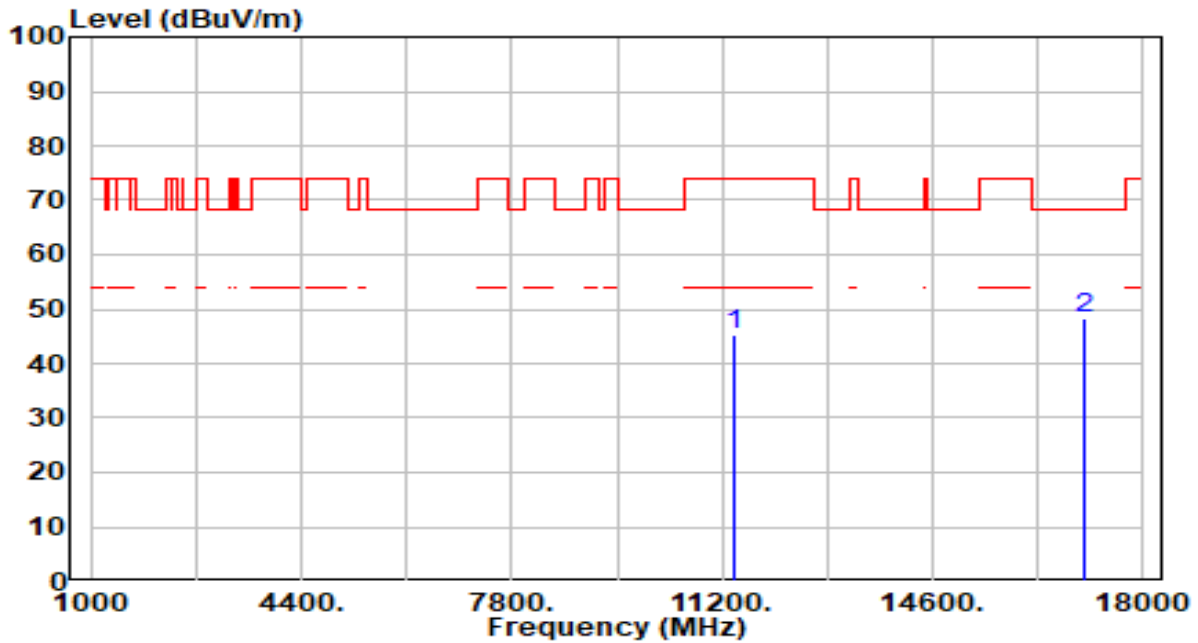

No	Frequency (MHz)	Reading (dBuV)	C.F (dB/m)	Measurement (dBuV/m)	Margin (dB)	Limit (dBuV/m)	Height (cm)	Angle (deg)	Remark (QP/PK/AV)
1	11380.000	41.90	3.45	45.35	-28.65	74.00	300	124	Peak
2	* 17070.000	43.61	4.86	48.47	-19.73	68.20	300	360	Peak

Note:

1. " *", means this data is the worst emission level.
2. C.F (Correction Factor) = Antenna Factor (dB/m)+ Cable Loss (dB) – Pre-amplifier(dB).
3. Measurement (dBuV/m) = Reading(dBuV) + C.F (Correction Factor).
4. The emission levels of other frequencies are very lower than the limit and not show in test report.

EUT	AX1800 Indoor/Outdoor Wi-Fi Access Point	Date of Test	2023-09-22
Factor	DRH18-E	Temp. / Humidity	20°C /60%
Polarity	Vertical	Site / Test Engineer	AC2 / Stanley
Test Mode	802.11ac-80MHz_TX_Band3_CH 138_ANT 0+1	Test Voltage	AC 120V/60Hz

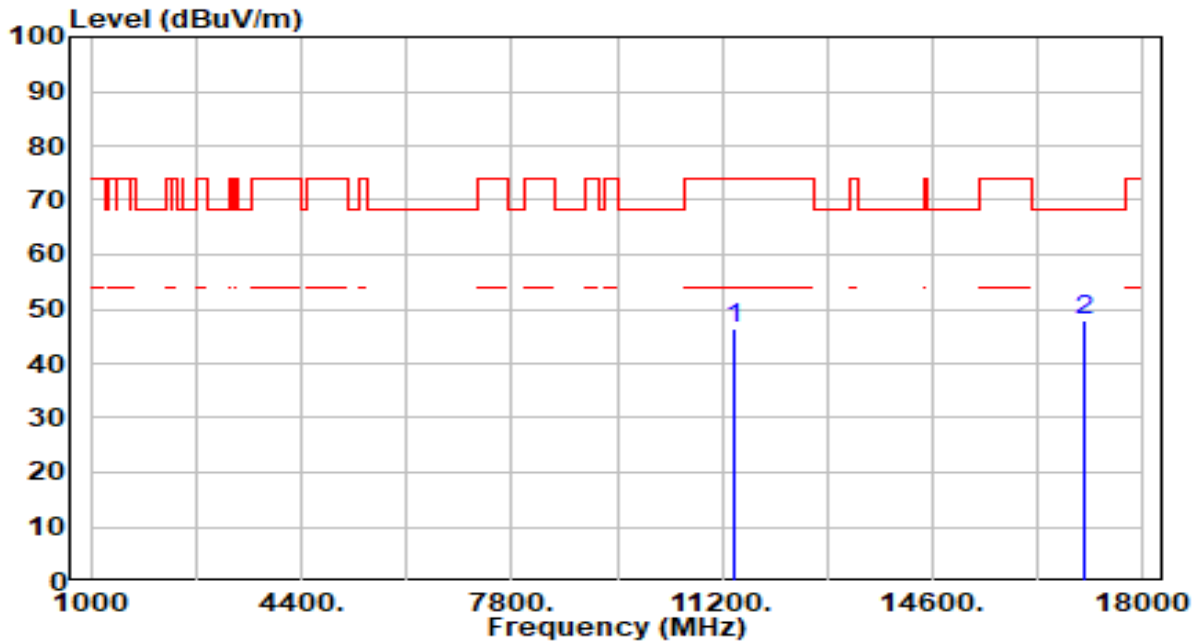

No	Frequency (MHz)	Reading (dBuV)	C.F (dB/m)	Measurement (dBuV/m)	Margin (dB)	Limit (dBuV/m)	Height (cm)	Angle (deg)	Remark (QP/PK/AV)
1	11380.000	42.91	3.45	46.36	-27.64	74.00	300	0	Peak
2	* 17070.000	42.99	4.86	47.85	-20.35	68.20	300	360	Peak

Note:

1. " *", means this data is the worst emission level.
2. C.F (Correction Factor) = Antenna Factor (dB/m)+ Cable Loss (dB) – Pre-amplifier(dB).
3. Measurement (dBuV/m) = Reading(dBuV) + C.F (Correction Factor).
4. The emission levels of other frequencies are very lower than the limit and not show in test report.

EUT	AX1800 Indoor/Outdoor Wi-Fi Access Point	Date of Test	2023-09-22
Factor	DRH18-E	Temp. / Humidity	20°C /60%
Polarity	Horizontal	Site / Test Engineer	AC2 / Stanley
Test Mode	802.11ac-80MHz_TX_Band4_CH 155_ANT 0+1	Test Voltage	AC 120V/60Hz

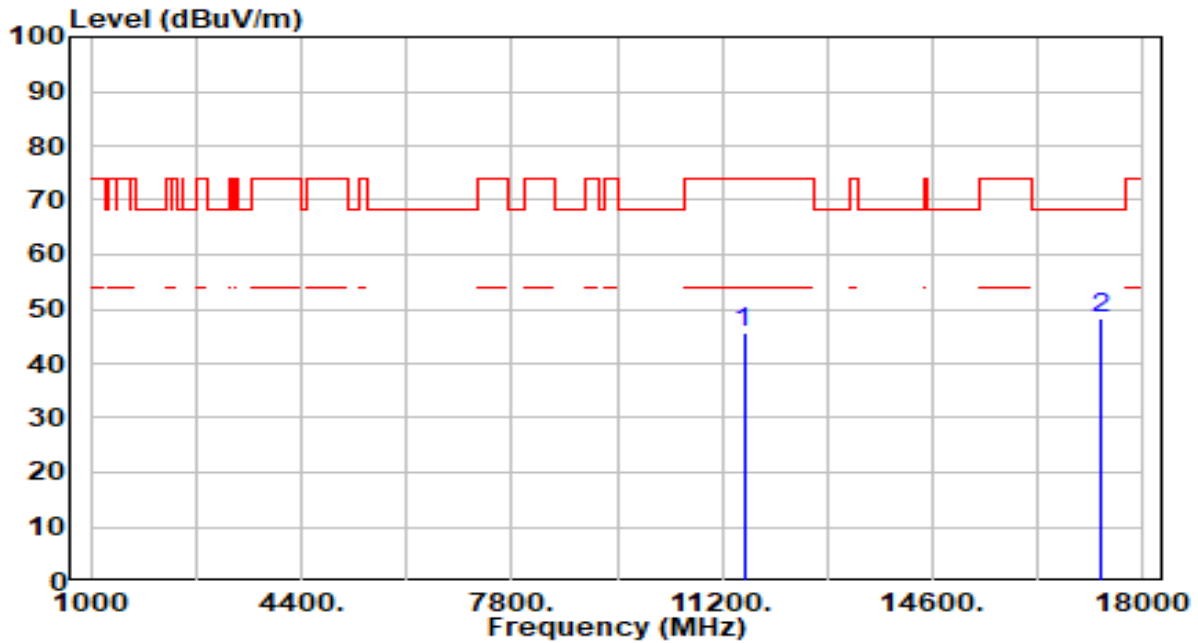

No	Frequency (MHz)	Reading (dBuV)	C.F (dB/m)	Measurement (dBuV/m)	Margin (dB)	Limit (dBuV/m)	Height (cm)	Angle (deg)	Remark (QP/PK/AV)
1	11550.000	41.93	3.63	45.56	-28.44	74.00	300	70	Peak
2	* 17325.000	44.00	4.16	48.16	-20.04	68.20	300	230	Peak

Note:

1. " *", means this data is the worst emission level.
2. C.F (Correction Factor) = Antenna Factor (dB/m)+ Cable Loss (dB) – Pre-amplifier(dB).
3. Measurement (dBuV/m) = Reading(dBuV) + C.F (Correction Factor).
4. The emission levels of other frequencies are very lower than the limit and not show in test report.

EUT	AX1800 Indoor/Outdoor Wi-Fi Access Point	Date of Test	2023-09-22
Factor	DRH18-E	Temp. / Humidity	20°C /60%
Polarity	Vertical	Site / Test Engineer	AC2 / Stanley
Test Mode	802.11ac-80MHz_TX_Band4_CH 155_ANT 0+1	Test Voltage	AC 120V/60Hz

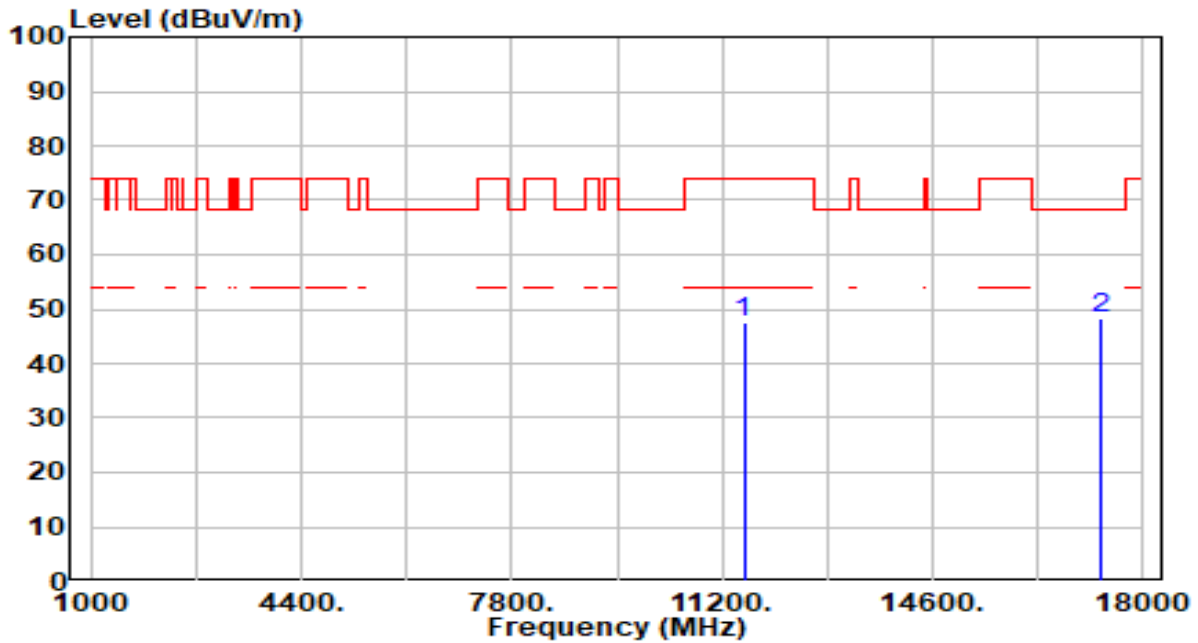

No	Frequency (MHz)	Reading (dBuV)	C.F (dB/m)	Measurement (dBuV/m)	Margin (dB)	Limit (dBuV/m)	Height (cm)	Angle (deg)	Remark (QP/PK/AV)
1	11550.000	43.79	3.63	47.42	-26.58	74.00	300	360	Peak
2	* 17325.000	43.97	4.16	48.13	-20.07	68.20	300	352	Peak

Note:

1. " *", means this data is the worst emission level.
2. C.F (Correction Factor) = Antenna Factor (dB/m)+ Cable Loss (dB) – Pre-amplifier(dB).
3. Measurement (dBuV/m) = Reading(dBuV) + C.F (Correction Factor).
4. The emission levels of other frequencies are very lower than the limit and not show in test report.

EUT	AX1800 Indoor/Outdoor Wi-Fi Access Point	Date of Test	2023-09-22
Factor	DRH18-E	Temp. / Humidity	20°C /60%
Polarity	Horizontal	Site / Test Engineer	AC2 / Stanley
Test Mode	802.11ax-20MHz_TX_Band1_CH 36_ANT 0+1	Test Voltage	AC 120V/60Hz

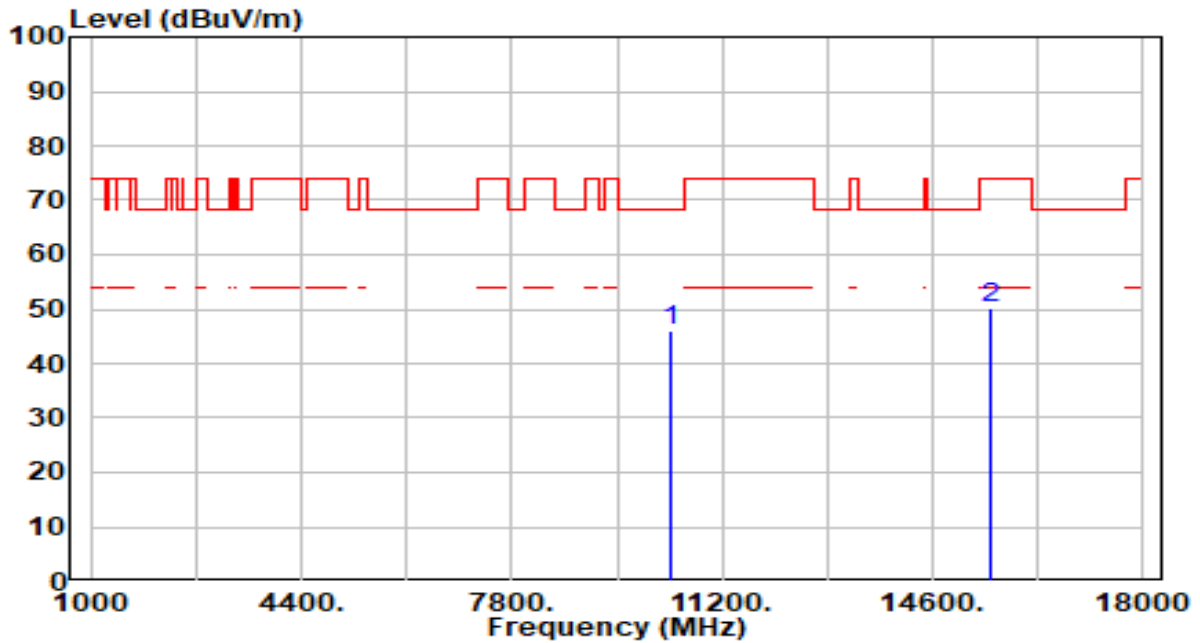

No	Frequency (MHz)	Reading (dBuV)	C.F (dB/m)	Measurement (dBuV/m)	Margin (dB)	Limit (dBuV/m)	Height (cm)	Angle (deg)	Remark (QP/PK/AV)
1	* 10360.000	43.39	2.81	46.20	-22.00	68.20	300	32	Peak
2	15540.000	45.51	4.52	50.03	-23.97	74.00	300	0	Peak

Note:

1. " *", means this data is the worst emission level.
2. C.F (Correction Factor) = Antenna Factor (dB/m)+ Cable Loss (dB) – Pre-amplifier(dB).
3. Measurement (dBuV/m) = Reading(dBuV) + C.F (Correction Factor).
4. The emission levels of other frequencies are very lower than the limit and not show in test report.

EUT	AX1800 Indoor/Outdoor Wi-Fi Access Point	Date of Test	2023-09-22
Factor	DRH18-E	Temp. / Humidity	20°C /60%
Polarity	Vertical	Site / Test Engineer	AC2 / Stanley
Test Mode	802.11ax-20MHz_TX_Band1_CH 36_ANT 0+1	Test Voltage	AC 120V/60Hz

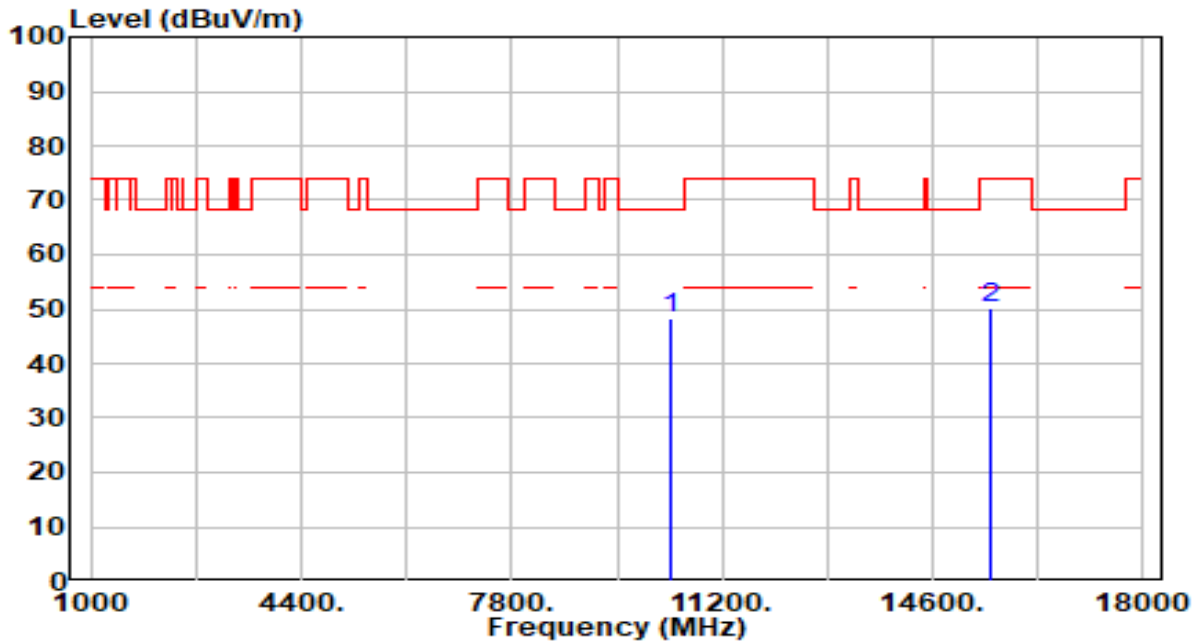

No	Frequency (MHz)	Reading (dBuV)	C.F (dB/m)	Measurement (dBuV/m)	Margin (dB)	Limit (dBuV/m)	Height (cm)	Angle (deg)	Remark (QP/PK/AV)
1	* 10360.000	45.59	2.81	48.40	-19.80	68.20	300	360	Peak
2	15540.000	45.71	4.52	50.23	-23.77	74.00	300	360	Peak

Note:

1. " *", means this data is the worst emission level.
2. C.F (Correction Factor) = Antenna Factor (dB/m)+ Cable Loss (dB) – Pre-amplifier(dB).
3. Measurement (dBuV/m) = Reading(dBuV) + C.F (Correction Factor).
4. The emission levels of other frequencies are very lower than the limit and not show in test report.

EUT	AX1800 Indoor/Outdoor Wi-Fi Access Point	Date of Test	2023-09-22
Factor	DRH18-E	Temp. / Humidity	20°C /60%
Polarity	Horizontal	Site / Test Engineer	AC2 / Stanley
Test Mode	802.11ax-20MHz_TX_Band1_CH 44_ANT 0+1	Test Voltage	AC 120V/60Hz

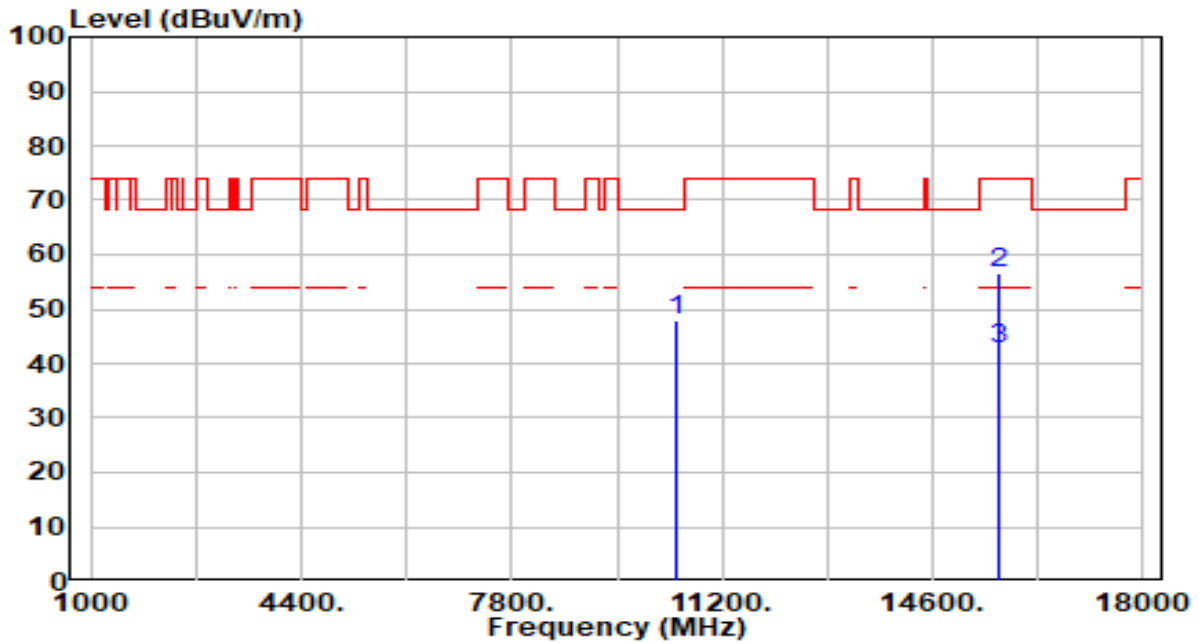

No	Frequency (MHz)	Reading (dBuV)	C.F (dB/m)	Measurement (dBuV/m)	Margin (dB)	Limit (dBuV/m)	Height (cm)	Angle (deg)	Remark (QP/PK/AV)
1	10440.000	45.05	2.72	47.78	-20.42	68.20	300	34	Peak
2	* 15660.000	51.81	4.67	56.48	-17.52	74.00	300	126	Peak
3	* 15660.000	38.06	4.67	42.73	-11.27	54.00	300	126	Average

Note:

1. " *", means this data is the worst emission level.
2. C.F (Correction Factor) = Antenna Factor (dB/m)+ Cable Loss (dB) – Preamplifier(dB).
3. Measurement (dBuV/m) = Reading(dBuV) + C.F (Correction Factor).
4. The emission levels of other frequencies are very lower than the limit and not show in test report.

EUT	AX1800 Indoor/Outdoor Wi-Fi Access Point	Date of Test	2023-09-22
Factor	DRH18-E	Temp. / Humidity	20°C /60%
Polarity	Vertical	Site / Test Engineer	AC2 / Stanley
Test Mode	802.11ax-20MHz_TX_Band1_CH 44_ANT 0+1	Test Voltage	AC 120V/60Hz

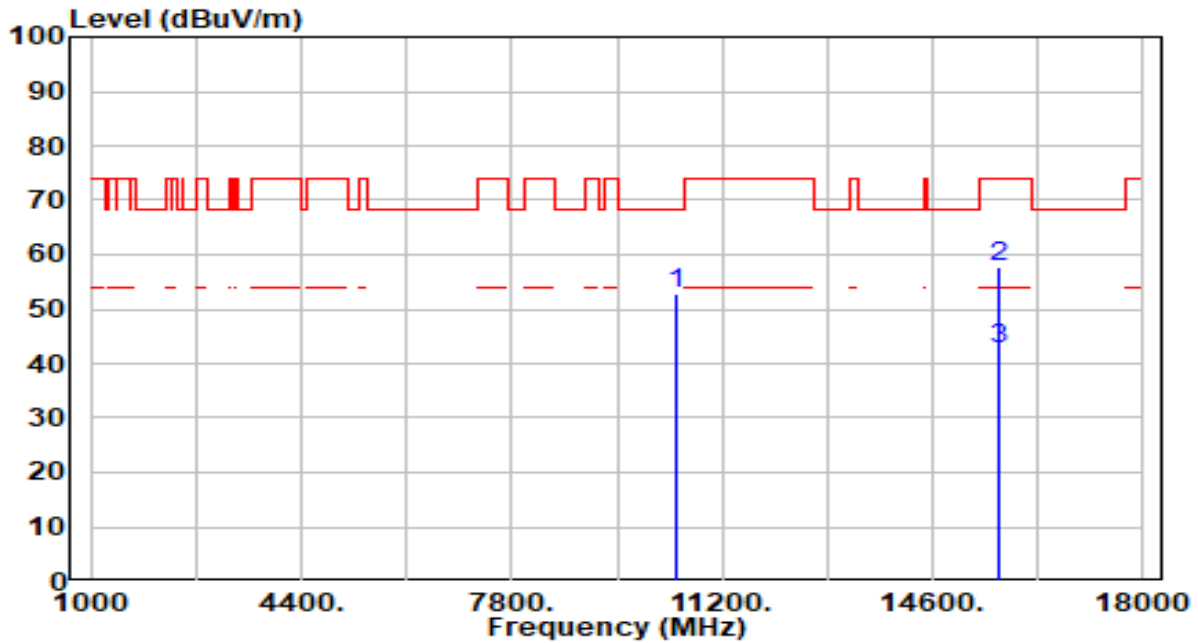

No	Frequency (MHz)	Reading (dBuV)	C.F (dB/m)	Measurement (dBuV/m)	Margin (dB)	Limit (dBuV/m)	Height (cm)	Angle (deg)	Remark (QP/PK/AV)
1	*	50.11	2.72	52.83	-15.37	68.20	300	0	Peak
2		52.92	4.67	57.59	-16.41	74.00	300	211	Peak
3	*	37.81	4.67	42.48	-11.52	54.00	300	211	Average

Note:

1. " *", means this data is the worst emission level.
2. C.F (Correction Factor) = Antenna Factor (dB/m)+ Cable Loss (dB) – Preamplifier(dB).
3. Measurement (dBuV/m) = Reading(dBuV) + C.F (Correction Factor).
4. The emission levels of other frequencies are very lower than the limit and not show in test report.

EUT	AX1800 Indoor/Outdoor Wi-Fi Access Point	Date of Test	2023-09-22
Factor	DRH18-E	Temp. / Humidity	20°C /60%
Polarity	Horizontal	Site / Test Engineer	AC2 / Stanley
Test Mode	802.11ax-20MHz_TX_Band1_CH 48_ANT 0+1	Test Voltage	AC 120V/60Hz

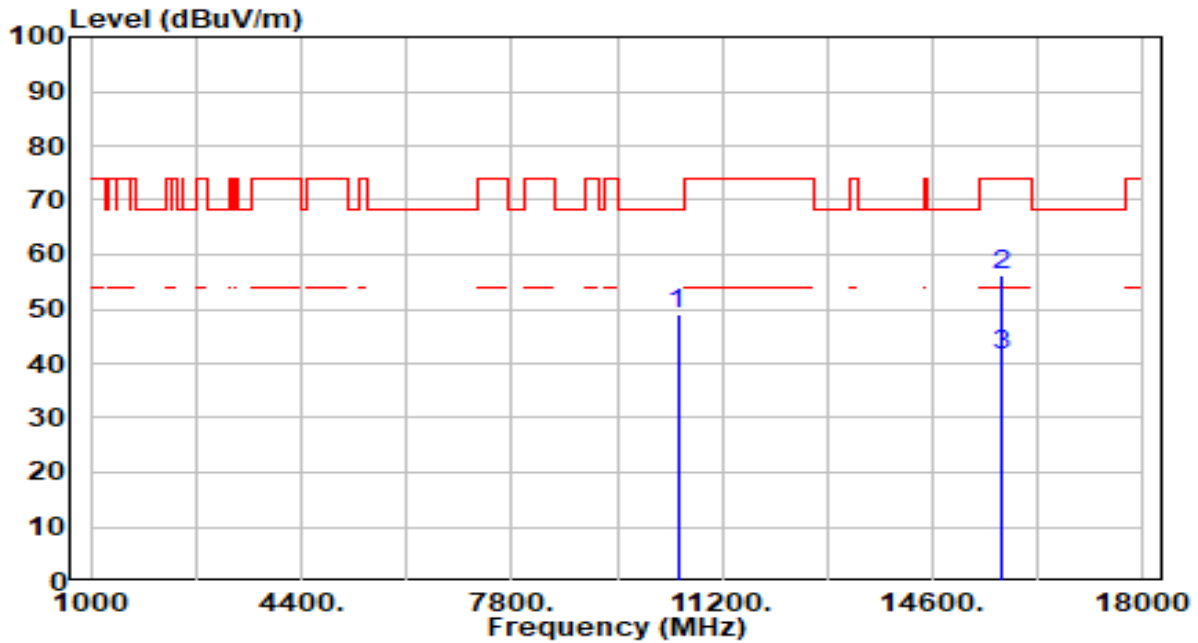

No	Frequency (MHz)	Reading (dBuV)	C.F (dB/m)	Measurement (dBuV/m)	Margin (dB)	Limit (dBuV/m)	Height (cm)	Angle (deg)	Remark (QP/PK/AV)
1	10480.000	46.25	2.68	48.93	-19.27	68.20	300	23	Peak
2	* 15720.000	51.57	4.84	56.41	-17.59	74.00	300	0	Peak
3	* 15720.000	36.71	4.84	41.55	-12.45	54.00	300	0	Average

Note:

1. " *", means this data is the worst emission level.
2. C.F (Correction Factor) = Antenna Factor (dB/m)+ Cable Loss (dB) – Preamplifier(dB).
3. Measurement (dBuV/m) = Reading(dBuV) + C.F (Correction Factor).
4. The emission levels of other frequencies are very lower than the limit and not show in test report.

EUT	AX1800 Indoor/Outdoor Wi-Fi Access Point	Date of Test	2023-09-22
Factor	DRH18-E	Temp. / Humidity	20°C /60%
Polarity	Vertical	Site / Test Engineer	AC2 / Stanley
Test Mode	802.11ax-20MHz_TX_Band1_CH 48_ANT 0+1	Test Voltage	AC 120V/60Hz

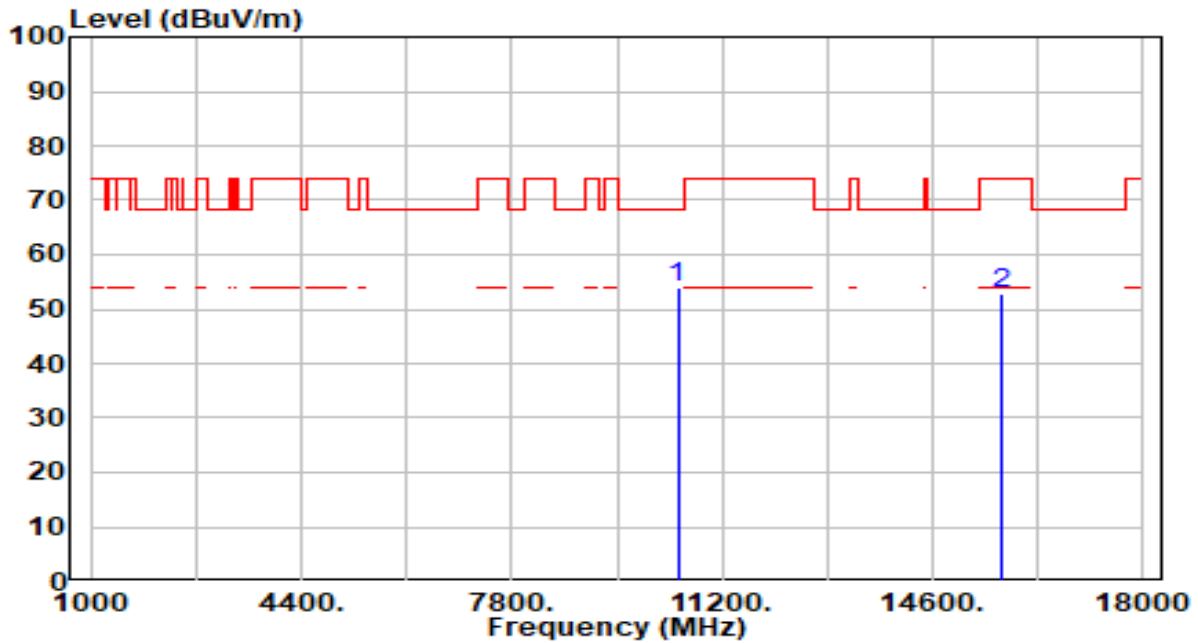

No	Frequency (MHz)	Reading (dBuV)	C.F (dB/m)	Measurement (dBuV/m)	Margin (dB)	Limit (dBuV/m)	Height (cm)	Angle (deg)	Remark (QP/PK/AV)
1	* 10480.000	51.23	2.68	53.91	-14.29	68.20	300	360	Peak
2	15720.000	48.14	4.84	52.97	-21.03	74.00	300	0	Peak

Note:

1. " *", means this data is the worst emission level.
2. C.F (Correction Factor) = Antenna Factor (dB/m)+ Cable Loss (dB) – Pre-amplifier(dB).
3. Measurement (dBuV/m) = Reading(dBuV) + C.F (Correction Factor).
4. The emission levels of other frequencies are very lower than the limit and not show in test report.

EUT	AX1800 Indoor/Outdoor Wi-Fi Access Point	Date of Test	2023-09-22
Factor	DRH18-E	Temp. / Humidity	20°C /60%
Polarity	Horizontal	Site / Test Engineer	AC2 / Stanley
Test Mode	802.11ax-20MHz_TX_Band2_CH 52_ANT 0+1	Test Voltage	AC 120V/60Hz

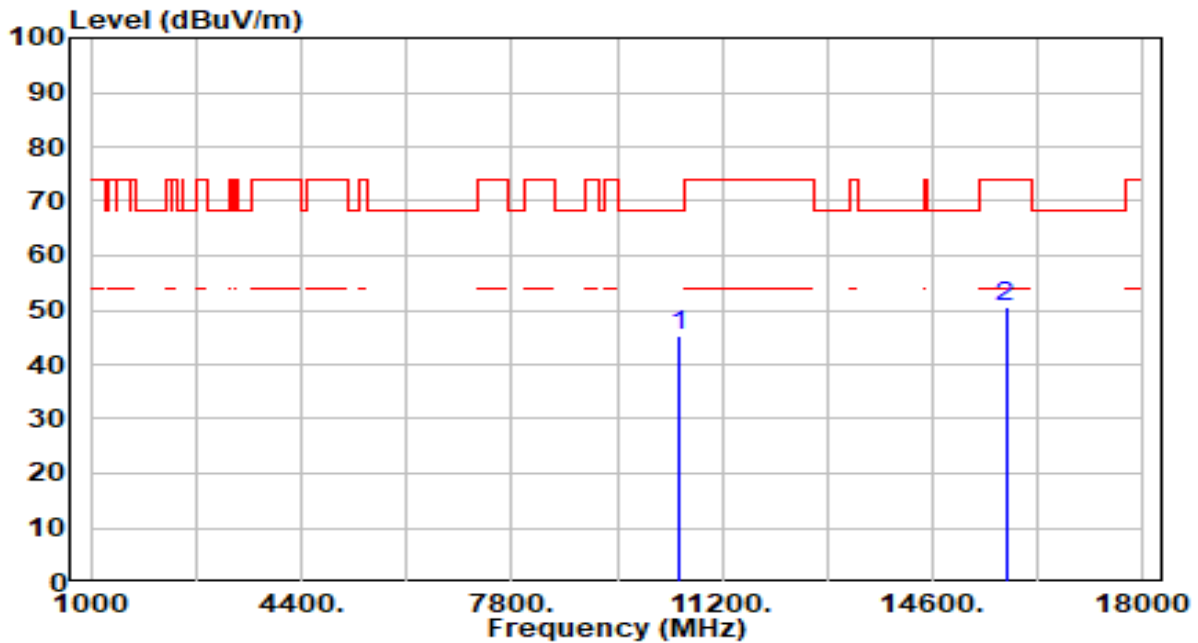

No	Frequency (MHz)	Reading (dBuV)	C.F (dB/m)	Measurement (dBuV/m)	Margin (dB)	Limit (dBuV/m)	Height (cm)	Angle (deg)	Remark (QP/PK/AV)
1	* 10520.000	42.61	2.64	45.25	-22.95	68.20	300	302	Peak
2	15780.000	45.71	5.00	50.71	-23.29	74.00	300	132	Peak

Note:

1. " *", means this data is the worst emission level.
2. C.F (Correction Factor) = Antenna Factor (dB/m)+ Cable Loss (dB) – Preamplifier(dB).
3. Measurement (dBuV/m) = Reading(dBuV) + C.F (Correction Factor).
4. The emission levels of other frequencies are very lower than the limit and not show in test report.

EUT	AX1800 Indoor/Outdoor Wi-Fi Access Point	Date of Test	2023-09-22
Factor	DRH18-E	Temp. / Humidity	20°C /60%
Polarity	Vertical	Site / Test Engineer	AC2 / Stanley
Test Mode	802.11ax-20MHz_TX_Band2_CH 52_ANT 0+1	Test Voltage	AC 120V/60Hz

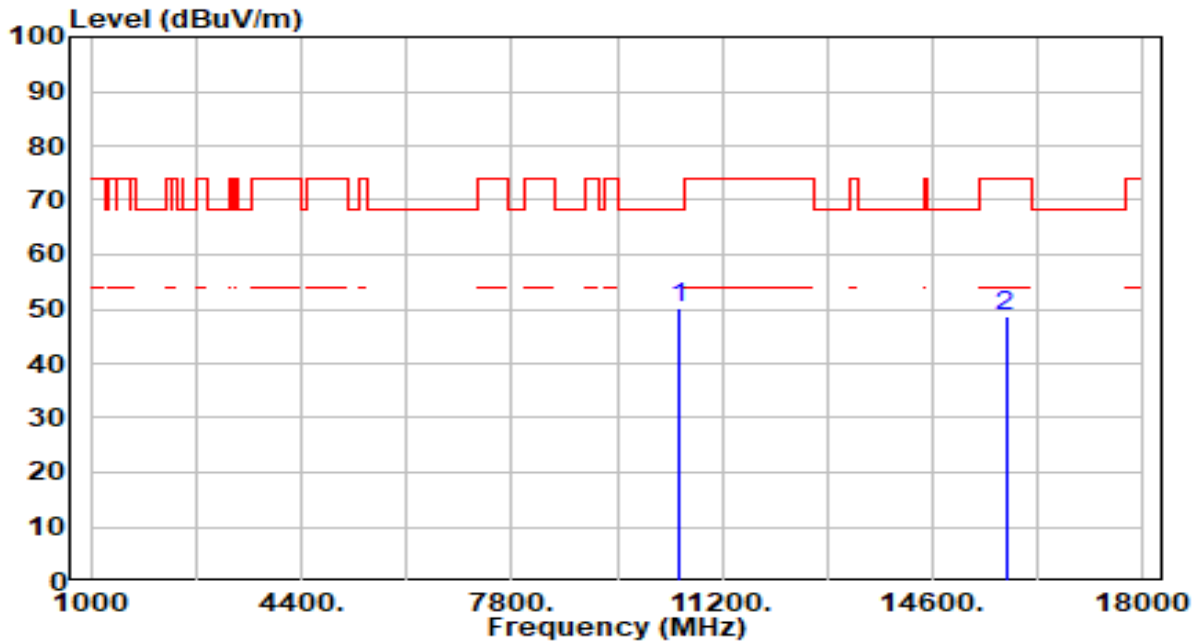

No	Frequency (MHz)	Reading (dBuV)	C.F (dB/m)	Measurement (dBuV/m)	Margin (dB)	Limit (dBuV/m)	Height (cm)	Angle (deg)	Remark (QP/PK/AV)
1	* 10520.000	47.53	2.64	50.17	-18.03	68.20	300	4	Peak
2	15780.000	43.52	5.00	48.52	-25.48	74.00	300	360	Peak

Note:

1. " *", means this data is the worst emission level.
2. C.F (Correction Factor) = Antenna Factor (dB/m)+ Cable Loss (dB) – Pre-amplifier(dB).
3. Measurement (dBuV/m) = Reading(dBuV) + C.F (Correction Factor).
4. The emission levels of other frequencies are very lower than the limit and not show in test report.

EUT	AX1800 Indoor/Outdoor Wi-Fi Access Point	Date of Test	2023-09-22
Factor	DRH18-E	Temp. / Humidity	20°C /60%
Polarity	Horizontal	Site / Test Engineer	AC2 / Stanley
Test Mode	802.11ax-20MHz_TX_Band2_CH 60_ANT 0+1	Test Voltage	AC 120V/60Hz

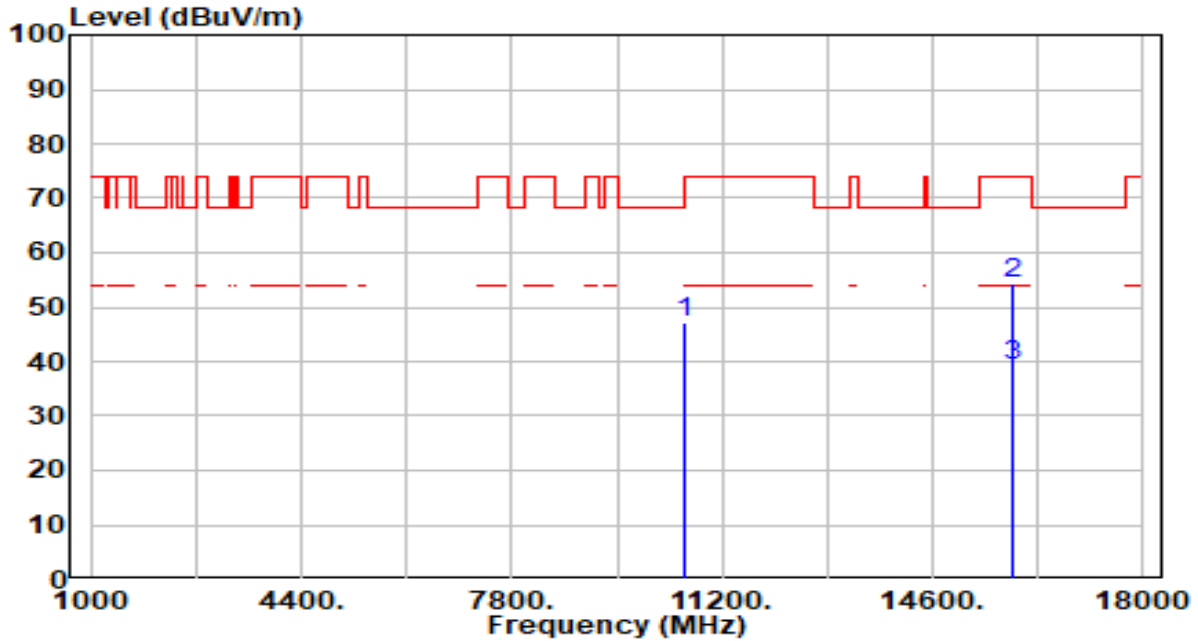

No	Frequency (MHz)	Reading (dBuV)	C.F (dB/m)	Measurement (dBuV/m)	Margin (dB)	Limit (dBuV/m)	Height (cm)	Angle (deg)	Remark (QP/PK/AV)
1	10600.000	44.60	2.60	47.21	-20.99	68.20	300	37	Peak
2	* 15900.000	49.28	5.13	54.41	-19.59	74.00	300	129	Peak
3	* 15900.000	34.24	5.13	39.37	-14.63	54.00	300	129	Average

Note:

1. " *", means this data is the worst emission level.
2. C.F (Correction Factor) = Antenna Factor (dB/m)+ Cable Loss (dB) – Preamplifier(dB).
3. Measurement (dBuV/m) = Reading(dBuV) + C.F (Correction Factor).
4. The emission levels of other frequencies are very lower than the limit and not show in test report.

EUT	AX1800 Indoor/Outdoor Wi-Fi Access Point	Date of Test	2023-09-22
Factor	DRH18-E	Temp. / Humidity	20°C /60%
Polarity	Vertical	Site / Test Engineer	AC2 / Stanley
Test Mode	802.11ax-20MHz_TX_Band2_CH 60_ANT 0+1	Test Voltage	AC 120V/60Hz

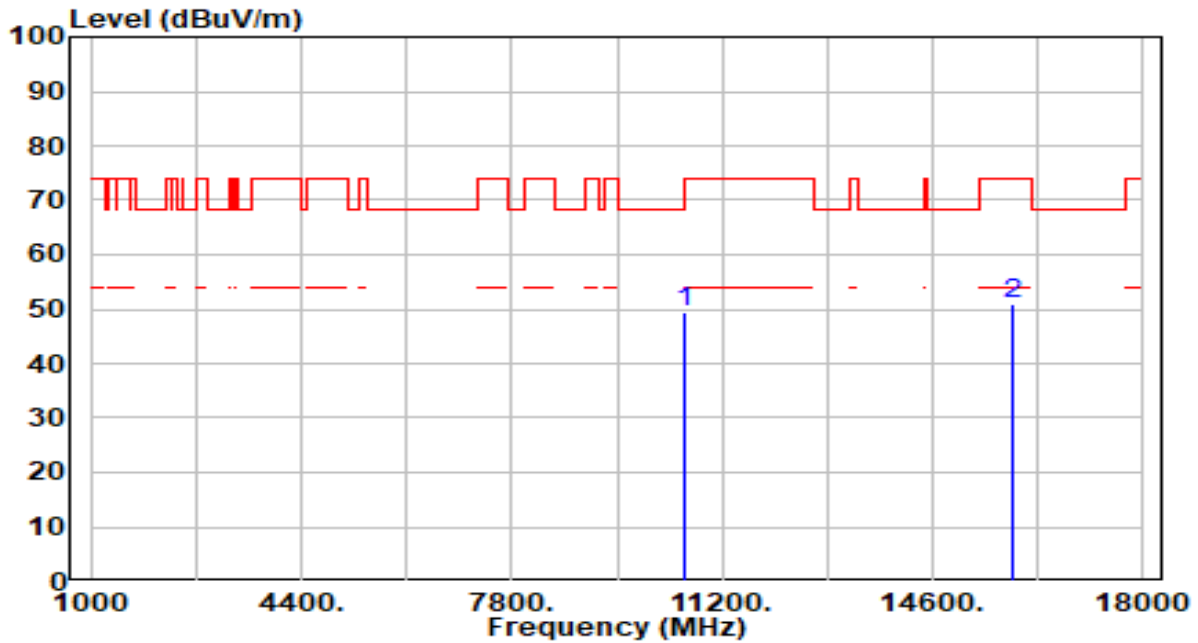

No	Frequency (MHz)	Reading (dBuV)	C.F (dB/m)	Measurement (dBuV/m)	Margin (dB)	Limit (dBuV/m)	Height (cm)	Angle (deg)	Remark (QP/PK/AV)
1	* 10600.000	46.87	2.60	49.48	-18.72	68.20	300	341	Peak
2	15900.000	45.91	5.13	51.03	-22.97	74.00	300	326	Peak

Note:

1. " *", means this data is the worst emission level.
2. C.F (Correction Factor) = Antenna Factor (dB/m)+ Cable Loss (dB) – Pre-amplifier(dB).
3. Measurement (dBuV/m) = Reading(dBuV) + C.F (Correction Factor).
4. The emission levels of other frequencies are very lower than the limit and not show in test report.

EUT	AX1800 Indoor/Outdoor Wi-Fi Access Point	Date of Test	2023-09-22
Factor	DRH18-E	Temp. / Humidity	20°C /60%
Polarity	Horizontal	Site / Test Engineer	AC2 / Stanley
Test Mode	802.11ax-20MHz_TX_Band2_CH 64_ANT 0+1	Test Voltage	AC 120V/60Hz

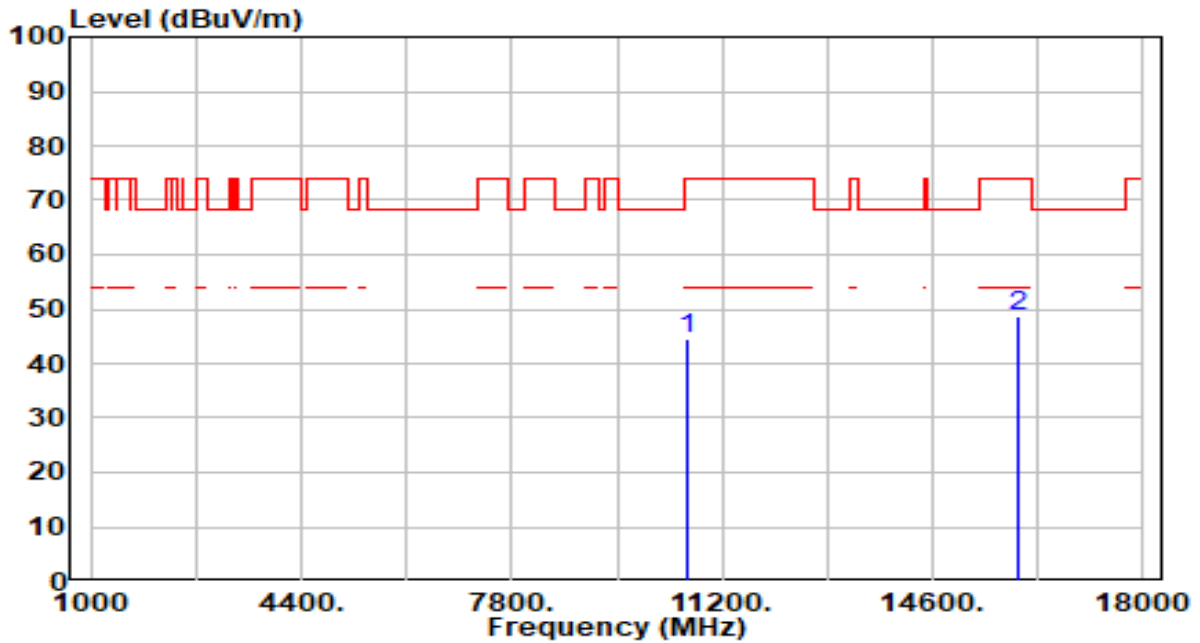

No	Frequency (MHz)	Reading (dBuV)	C.F (dB/m)	Measurement (dBuV/m)	Margin (dB)	Limit (dBuV/m)	Height (cm)	Angle (deg)	Remark (QP/PK/AV)
1	10640.000	41.95	2.62	44.58	-29.42	74.00	300	289	Peak
2	* 15960.000	43.56	5.17	48.73	-25.27	74.00	300	124	Peak

Note:

- " *", means this data is the worst emission level.
- C.F (Correction Factor) = Antenna Factor (dB/m)+ Cable Loss (dB) – Pre-amplifier(dB).
- Measurement (dBuV/m) = Reading(dBuV) + C.F (Correction Factor).
- The emission levels of other frequencies are very lower than the limit and not show in test report.

EUT	AX1800 Indoor/Outdoor Wi-Fi Access Point	Date of Test	2023-09-22
Factor	DRH18-E	Temp. / Humidity	20°C /60%
Polarity	Vertical	Site / Test Engineer	AC2 / Stanley
Test Mode	802.11ax-20MHz_TX_Band2_CH 64_ANT 0+1	Test Voltage	AC 120V/60Hz

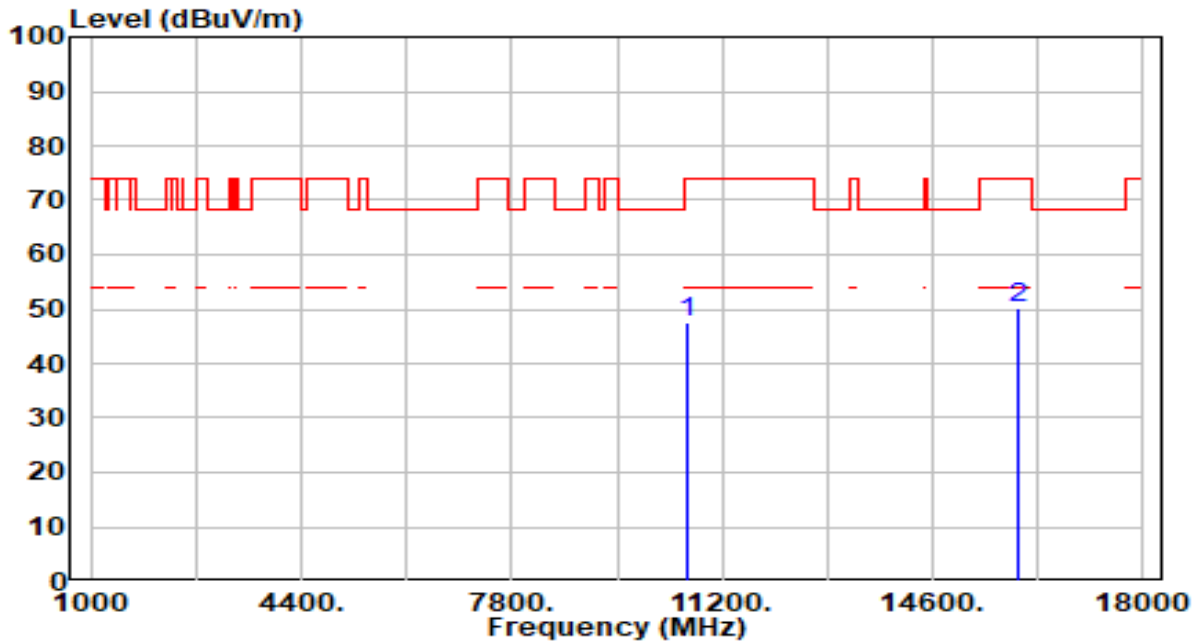

No	Frequency (MHz)	Reading (dBuV)	C.F (dB/m)	Measurement (dBuV/m)	Margin (dB)	Limit (dBuV/m)	Height (cm)	Angle (deg)	Remark (QP/PK/AV)
1	10640.000	44.77	2.62	47.40	-26.60	74.00	300	360	Peak
2	* 15960.000	44.84	5.17	50.01	-23.99	74.00	300	99	Peak

Note:

1. " *", means this data is the worst emission level.
2. C.F (Correction Factor) = Antenna Factor (dB/m)+ Cable Loss (dB) – Pre-amplifier(dB).
3. Measurement (dBuV/m) = Reading(dBuV) + C.F (Correction Factor).
4. The emission levels of other frequencies are very lower than the limit and not show in test report.

EUT	AX1800 Indoor/Outdoor Wi-Fi Access Point	Date of Test	2023-09-22
Factor	DRH18-E	Temp. / Humidity	20°C /60%
Polarity	Horizontal	Site / Test Engineer	AC2 / Stanley
Test Mode	802.11ax-20MHz_TX_Band3_CH 100_ANT 0+1	Test Voltage	AC 120V/60Hz

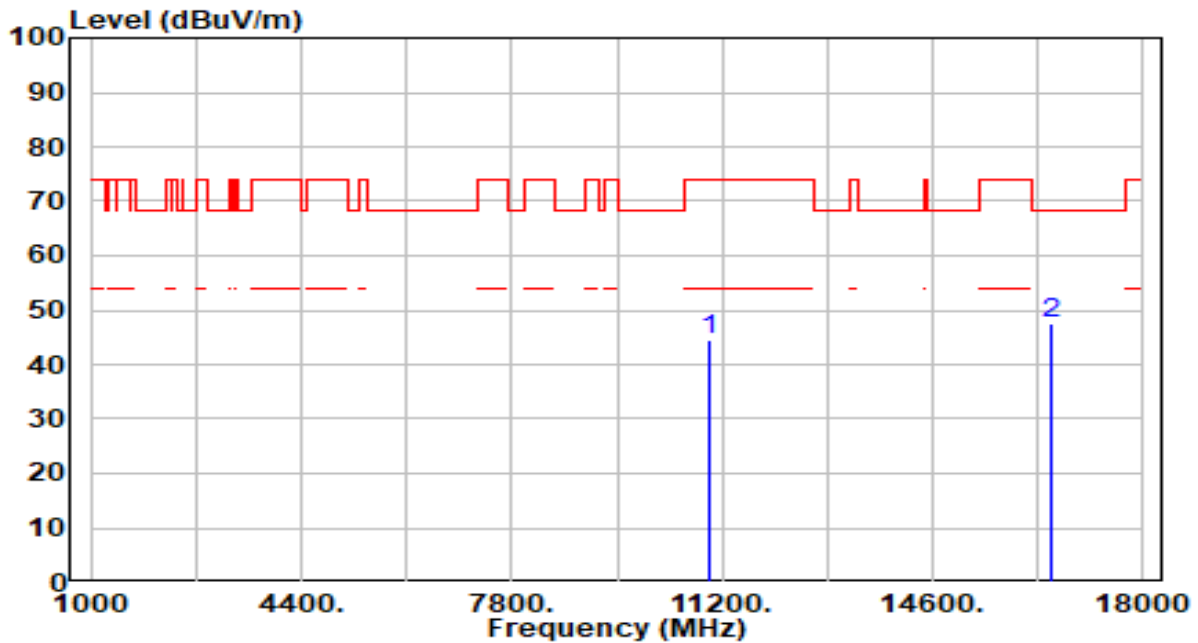

No	Frequency (MHz)	Reading (dBuV)	C.F (dB/m)	Measurement (dBuV/m)	Margin (dB)	Limit (dBuV/m)	Height (cm)	Angle (deg)	Remark (QP/PK/AV)
1	11000.000	41.98	2.60	44.58	-29.42	74.00	300	235	Peak
2	* 16500.000	42.96	4.63	47.59	-20.61	68.20	300	121	Peak

Note:

1. " *", means this data is the worst emission level.
2. C.F (Correction Factor) = Antenna Factor (dB/m)+ Cable Loss (dB) – Preamplifier(dB).
3. Measurement (dBuV/m) = Reading(dBuV) + C.F (Correction Factor).
4. The emission levels of other frequencies are very lower than the limit and not show in test report.

EUT	AX1800 Indoor/Outdoor Wi-Fi Access Point	Date of Test	2023-09-22
Factor	DRH18-E	Temp. / Humidity	20°C /60%
Polarity	Vertical	Site / Test Engineer	AC2 / Stanley
Test Mode	802.11ax-20MHz_TX_Band3_CH 100_ANT 0+1	Test Voltage	AC 120V/60Hz

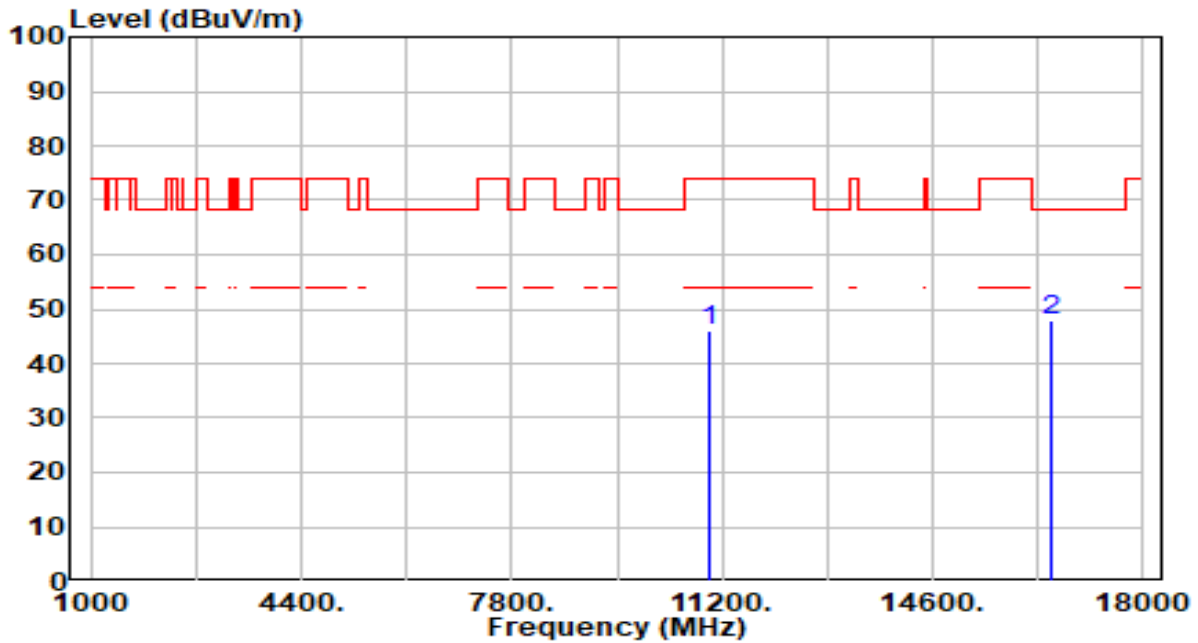

No	Frequency (MHz)	Reading (dBuV)	C.F (dB/m)	Measurement (dBuV/m)	Margin (dB)	Limit (dBuV/m)	Height (cm)	Angle (deg)	Remark (QP/PK/AV)
1	11000.000	43.28	2.60	45.88	-28.12	74.00	300	2	Peak
2	* 16500.000	43.45	4.63	48.08	-20.12	68.20	300	4	Peak

Note:

1. " *", means this data is the worst emission level.
2. C.F (Correction Factor) = Antenna Factor (dB/m)+ Cable Loss (dB) – Pre-amplifier(dB).
3. Measurement (dBuV/m) = Reading(dBuV) + C.F (Correction Factor).
4. The emission levels of other frequencies are very lower than the limit and not show in test report.

EUT	AX1800 Indoor/Outdoor Wi-Fi Access Point	Date of Test	2023-09-22
Factor	DRH18-E	Temp. / Humidity	20°C /60%
Polarity	Horizontal	Site / Test Engineer	AC2 / Stanley
Test Mode	802.11ax-20MHz_TX_Band3_CH 116_ANT 0+1	Test Voltage	AC 120V/60Hz

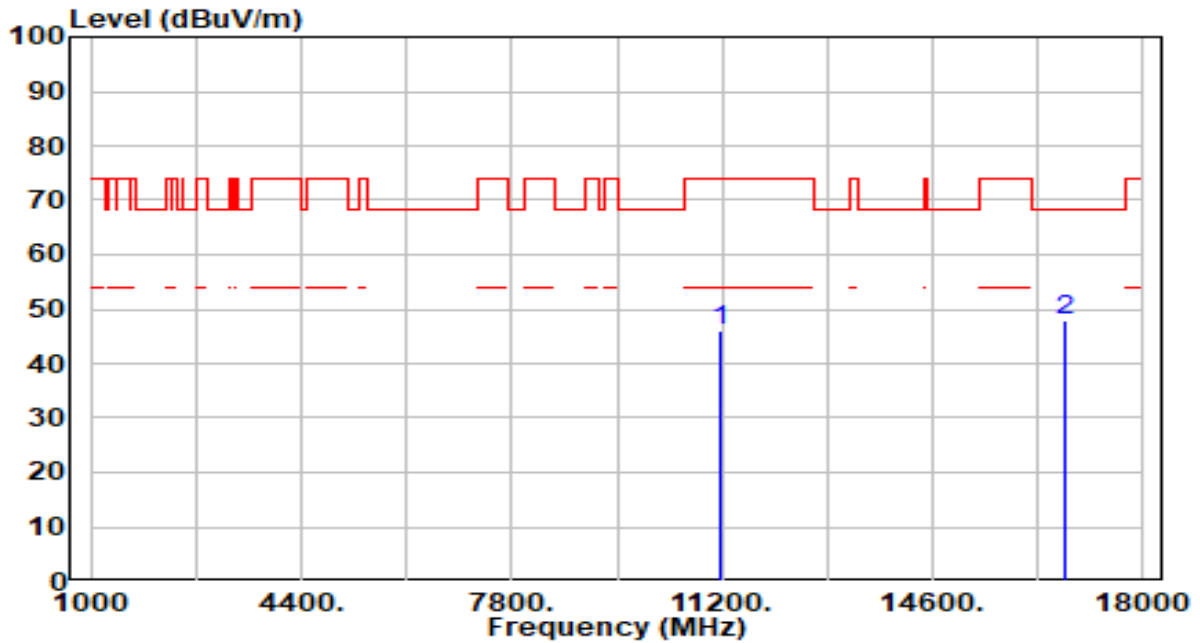

No	Frequency (MHz)	Reading (dBuV)	C.F (dB/m)	Measurement (dBuV/m)	Margin (dB)	Limit (dBuV/m)	Height (cm)	Angle (deg)	Remark (QP/PK/AV)
1	11160.000	42.98	3.07	46.05	-27.95	74.00	300	260	Peak
2	* 16740.000	43.38	4.66	48.04	-20.16	68.20	300	49	Peak

Note:

1. " *", means this data is the worst emission level.
2. C.F (Correction Factor) = Antenna Factor (dB/m)+ Cable Loss (dB) – Pre-amplifier(dB).
3. Measurement (dBuV/m) = Reading(dBuV) + C.F (Correction Factor).
4. The emission levels of other frequencies are very lower than the limit and not show in test report.

EUT	AX1800 Indoor/Outdoor Wi-Fi Access Point	Date of Test	2023-09-22
Factor	DRH18-E	Temp. / Humidity	20°C /60%
Polarity	Vertical	Site / Test Engineer	AC2 / Stanley
Test Mode	802.11ax-20MHz_TX_Band3_CH 116_ANT 0+1	Test Voltage	AC 120V/60Hz

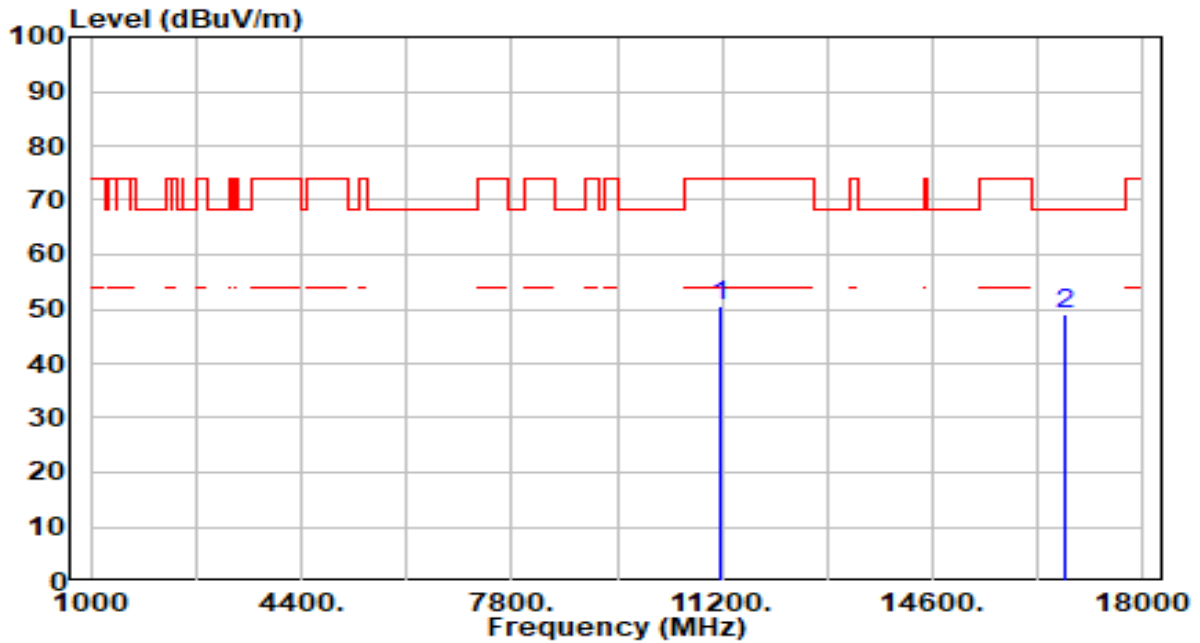

No	Frequency (MHz)	Reading (dBuV)	C.F (dB/m)	Measurement (dBuV/m)	Margin (dB)	Limit (dBuV/m)	Height (cm)	Angle (deg)	Remark (QP/PK/AV)
1	11160.000	47.46	3.07	50.53	-23.47	74.00	300	18	Peak
2	* 16740.000	44.41	4.66	49.07	-19.13	68.20	300	211	Peak

Note:

1. " *", means this data is the worst emission level.
2. C.F (Correction Factor) = Antenna Factor (dB/m)+ Cable Loss (dB) – Pre-amplifier(dB).
3. Measurement (dBuV/m) = Reading(dBuV) + C.F (Correction Factor).
4. The emission levels of other frequencies are very lower than the limit and not show in test report.

EUT	AX1800 Indoor/Outdoor Wi-Fi Access Point	Date of Test	2023-09-22
Factor	DRH18-E	Temp. / Humidity	20°C /60%
Polarity	Horizontal	Site / Test Engineer	AC2 / Stanley
Test Mode	802.11ax-20MHz_TX_Band3_CH 140_ANT 0+1	Test Voltage	AC 120V/60Hz

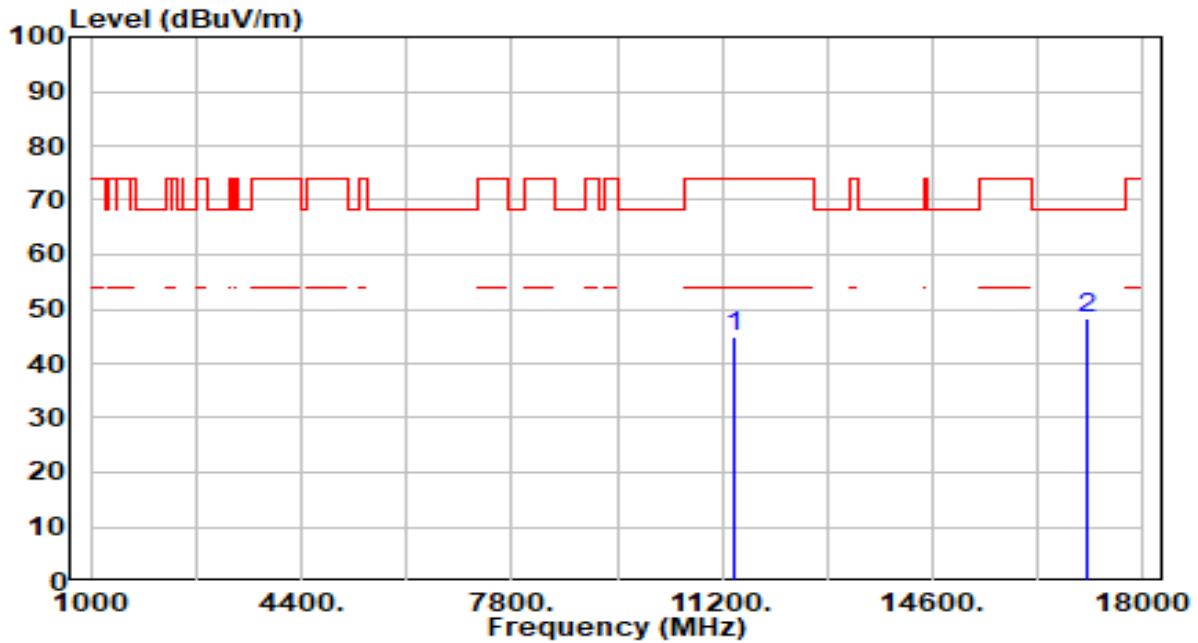

No	Frequency (MHz)	Reading (dBUV)	C.F (dB/m)	Measurement (dBUV/m)	Margin (dB)	Limit (dBUV/m)	Height (cm)	Angle (deg)	Remark (QP/PK/AV)
1	11400.000	41.51	3.48	44.99	-29.01	74.00	300	144	Peak
2	* 17100.000	43.64	4.79	48.43	-19.77	68.20	300	124	Peak

Note:

1. " *", means this data is the worst emission level.
2. C.F (Correction Factor) = Antenna Factor (dB/m)+ Cable Loss (dB) – Pre-amplifier(dB).
3. Measurement (dBUV/m) = Reading(dBUV) + C.F (Correction Factor).
4. The emission levels of other frequencies are very lower than the limit and not show in test report.

EUT	AX1800 Indoor/Outdoor Wi-Fi Access Point	Date of Test	2023-09-22
Factor	DRH18-E	Temp. / Humidity	20°C /60%
Polarity	Vertical	Site / Test Engineer	AC2 / Stanley
Test Mode	802.11ax-20MHz_TX_Band3_CH 140_ANT 0+1	Test Voltage	AC 120V/60Hz

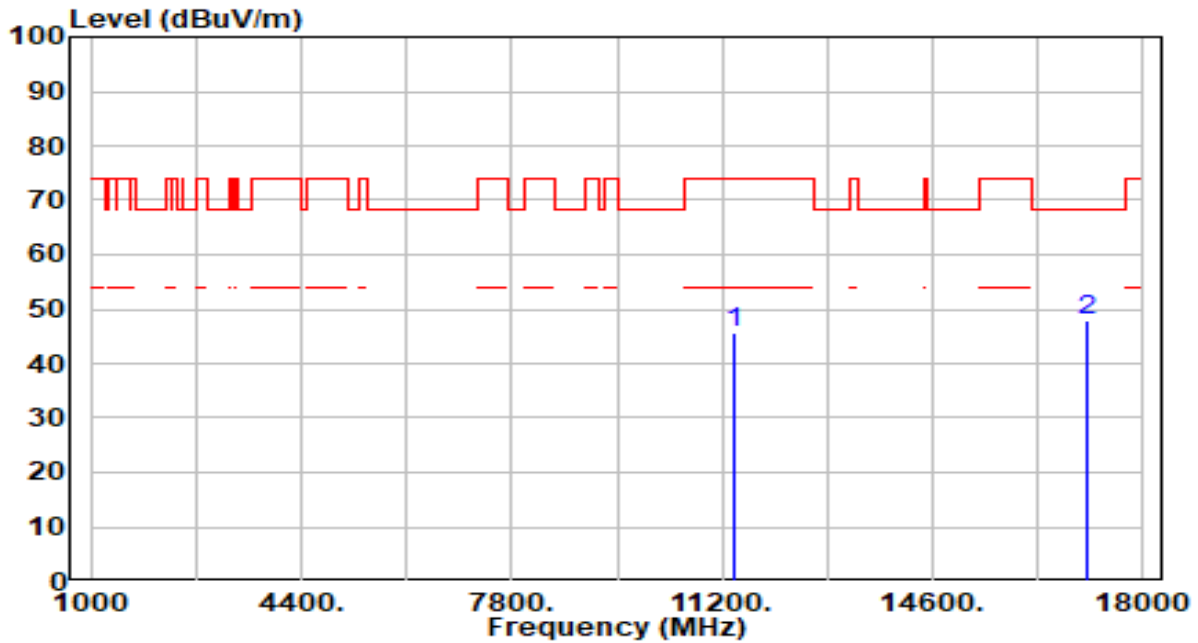

No	Frequency (MHz)	Reading (dBuV)	C.F (dB/m)	Measurement (dBuV/m)	Margin (dB)	Limit (dBuV/m)	Height (cm)	Angle (deg)	Remark (QP/PK/AV)
1	11400.000	42.21	3.48	45.69	-28.31	74.00	300	200	Peak
2	* 17100.000	43.02	4.79	47.81	-20.39	68.20	300	244	Peak

Note:

1. " *", means this data is the worst emission level.
2. C.F (Correction Factor) = Antenna Factor (dB/m)+ Cable Loss (dB) – Pre-amplifier(dB).
3. Measurement (dBuV/m) = Reading(dBuV) + C.F (Correction Factor).
4. The emission levels of other frequencies are very lower than the limit and not show in test report.

EUT	AX1800 Indoor/Outdoor Wi-Fi Access Point	Date of Test	2023-09-22
Factor	DRH18-E	Temp. / Humidity	20°C /60%
Polarity	Horizontal	Site / Test Engineer	AC2 / Stanley
Test Mode	802.11ax-20MHz_TX_Band3_CH 144_ANT 0+1	Test Voltage	AC 120V/60Hz

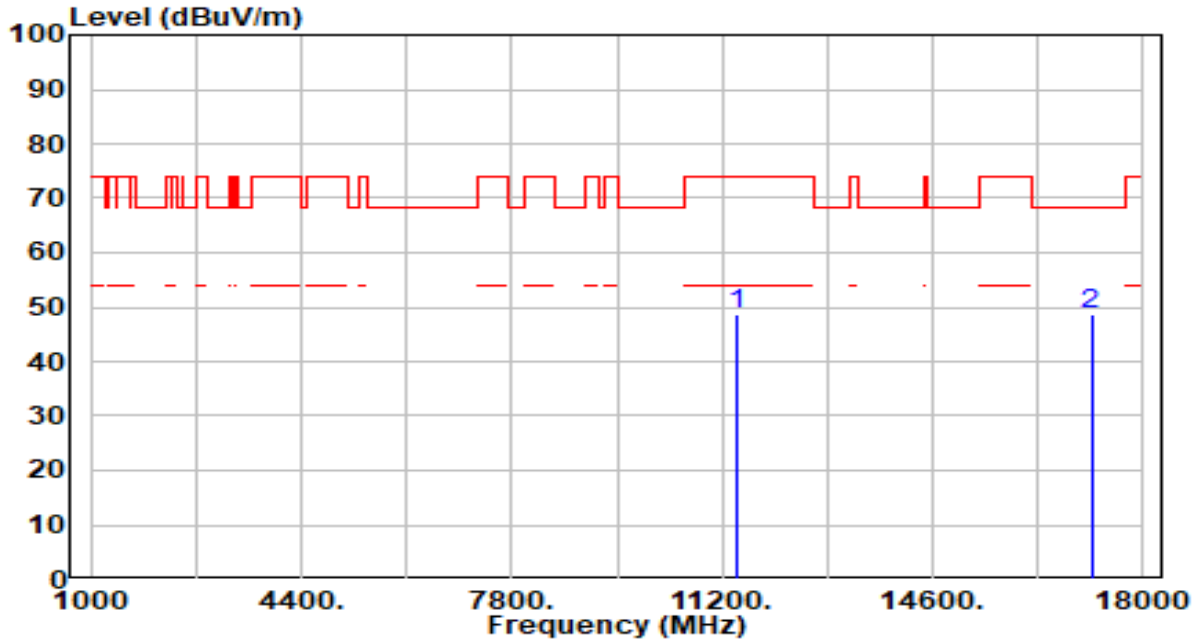

No	Frequency (MHz)	Reading (dBuV)	C.F (dB/m)	Measurement (dBuV/m)	Margin (dB)	Limit (dBuV/m)	Height (cm)	Angle (deg)	Remark (QP/PK/AV)
1	11440.000	45.25	3.52	48.77	-25.23	74.00	300	325	Peak
2	* 17160.000	44.12	4.66	48.77	-19.43	68.20	300	221	Peak

Note:

1. " *", means this data is the worst emission level.
2. C.F (Correction Factor) = Antenna Factor (dB/m)+ Cable Loss (dB) – Pre-amplifier(dB).
3. Measurement (dBuV/m) = Reading(dBuV) + C.F (Correction Factor).
4. The emission levels of other frequencies are very lower than the limit and not show in test report.

EUT	AX1800 Indoor/Outdoor Wi-Fi Access Point	Date of Test	2023-09-22
Factor	DRH18-E	Temp. / Humidity	20°C /60%
Polarity	Vertical	Site / Test Engineer	AC2 / Stanley
Test Mode	802.11ax-20MHz_TX_Band3_CH 144_ANT 0+1	Test Voltage	AC 120V/60Hz

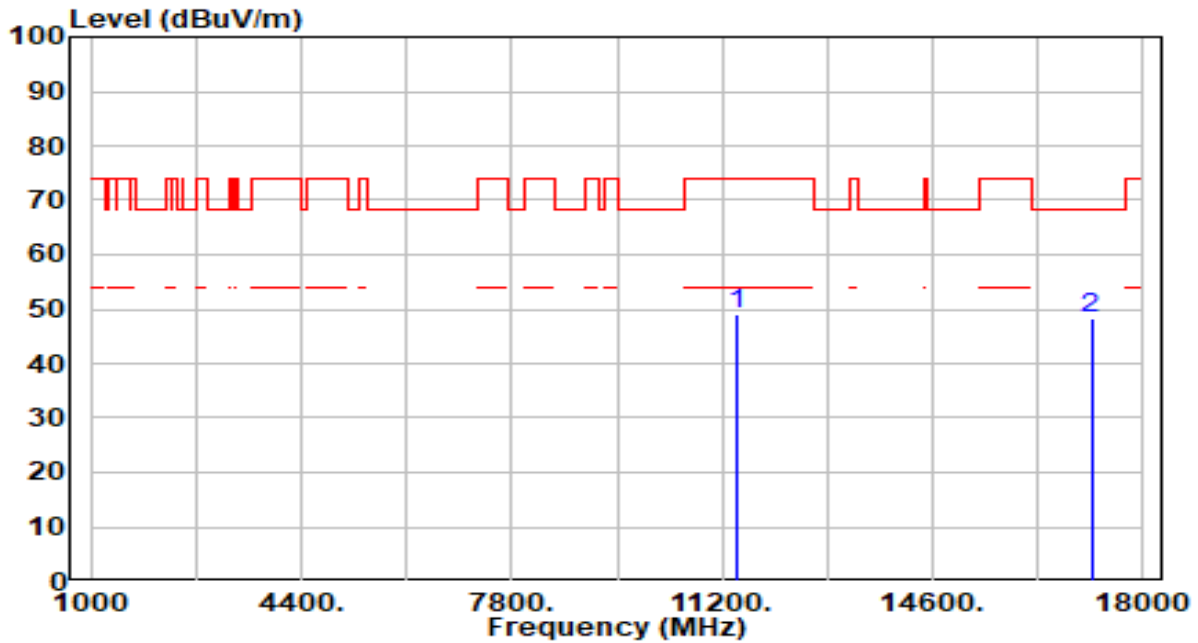

No	Frequency (MHz)	Reading (dBuV)	C.F (dB/m)	Measurement (dBuV/m)	Margin (dB)	Limit (dBuV/m)	Height (cm)	Angle (deg)	Remark (QP/PK/AV)
1	11440.000	45.36	3.52	48.88	-25.12	74.00	300	0	Peak
2	* 17160.000	43.68	4.66	48.33	-19.87	68.20	300	360	Peak

Note:

1. " *", means this data is the worst emission level.
2. C.F (Correction Factor) = Antenna Factor (dB/m)+ Cable Loss (dB) – Pre-amplifier(dB).
3. Measurement (dBuV/m) = Reading(dBuV) + C.F (Correction Factor).
4. The emission levels of other frequencies are very lower than the limit and not show in test report.

EUT	AX1800 Indoor/Outdoor Wi-Fi Access Point	Date of Test	2023-09-22
Factor	DRH18-E	Temp. / Humidity	20°C /60%
Polarity	Horizontal	Site / Test Engineer	AC2 / Stanley
Test Mode	802.11ax-20MHz_TX_Band4_CH 149_ANT 0+1	Test Voltage	AC 120V/60Hz

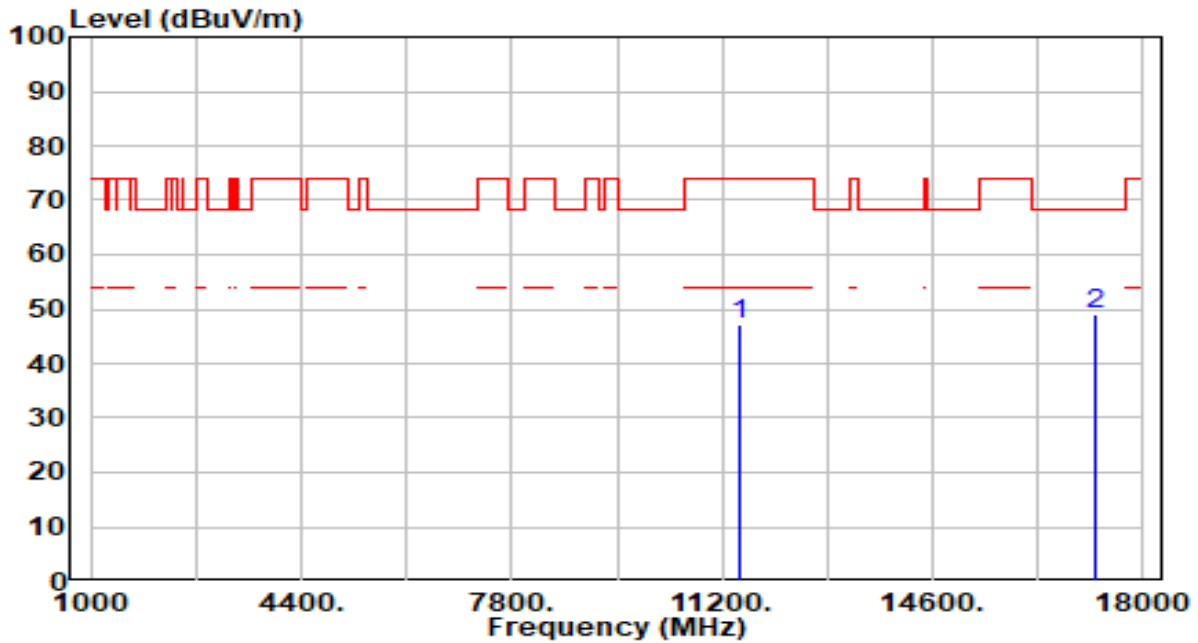

No	Frequency (MHz)	Reading (dBuV)	C.F (dB/m)	Measurement (dBuV/m)	Margin (dB)	Limit (dBuV/m)	Height (cm)	Angle (deg)	Remark (QP/PK/AV)
1	11490.000	43.69	3.57	47.25	-26.75	74.00	300	49	Peak
2	* 17235.000	44.64	4.45	49.09	-19.11	68.20	300	23	Peak

Note:

1. " *", means this data is the worst emission level.
2. C.F (Correction Factor) = Antenna Factor (dB/m)+ Cable Loss (dB) – Pre-amplifier(dB).
3. Measurement (dBuV/m) = Reading(dBuV) + C.F (Correction Factor).
4. The emission levels of other frequencies are very lower than the limit and not show in test report.

EUT	AX1800 Indoor/Outdoor Wi-Fi Access Point	Date of Test	2023-09-22
Factor	DRH18-E	Temp. / Humidity	20°C /60%
Polarity	Vertical	Site / Test Engineer	AC2 / Stanley
Test Mode	802.11ax-20MHz_TX_Band4_CH 149_ANT 0+1	Test Voltage	AC 120V/60Hz

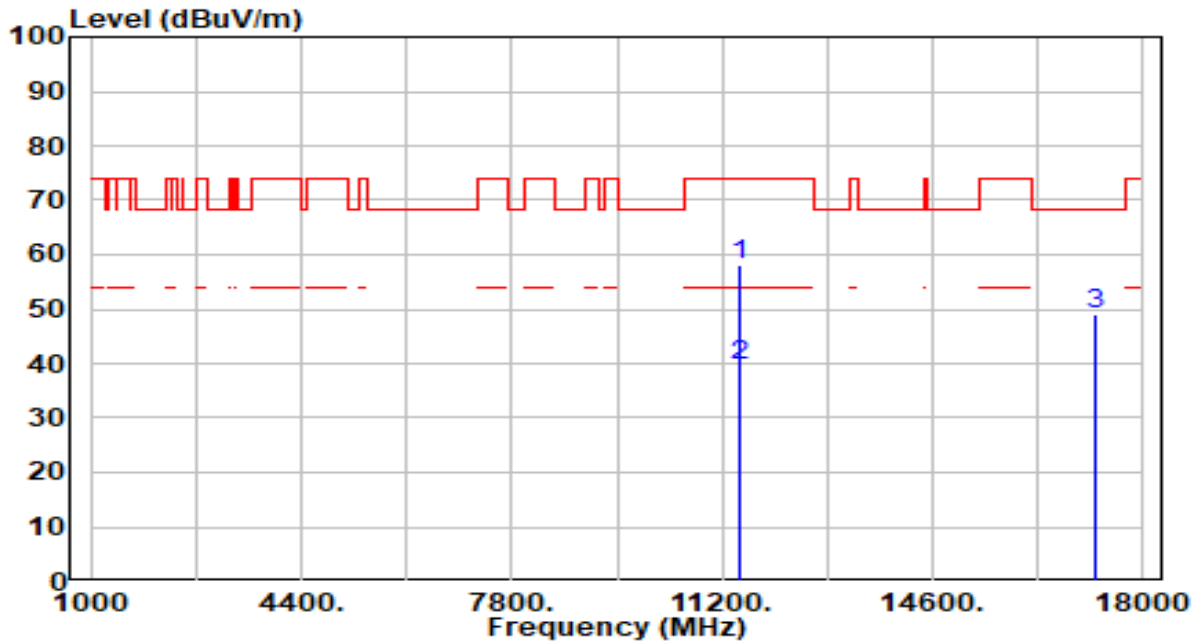

No	Frequency (MHz)	Reading (dBuV)	C.F (dB/m)	Measurement (dBuV/m)	Margin (dB)	Limit (dBuV/m)	Height (cm)	Angle (deg)	Remark (QP/PK/AV)	
1	*	11490.000	54.56	3.57	58.13	-15.87	74.00	300	360	Peak
2	*	11490.000	36.24	3.57	39.81	-14.19	54.00	300	360	Average
3		17235.000	44.54	4.45	48.99	-19.21	68.20	300	300	Peak

Note:

1. " *", means this data is the worst emission level.
2. C.F (Correction Factor) = Antenna Factor (dB/m)+ Cable Loss (dB) – Preamplifier(dB).
3. Measurement (dBuV/m) = Reading(dBuV) + C.F (Correction Factor).
4. The emission levels of other frequencies are very lower than the limit and not show in test report.

EUT	AX1800 Indoor/Outdoor Wi-Fi Access Point	Date of Test	2023-09-22
Factor	DRH18-E	Temp. / Humidity	20°C /60%
Polarity	Horizontal	Site / Test Engineer	AC2 / Stanley
Test Mode	802.11ax-20MHz_TX_Band4_CH 157_ANT 0+1	Test Voltage	AC 120V/60Hz

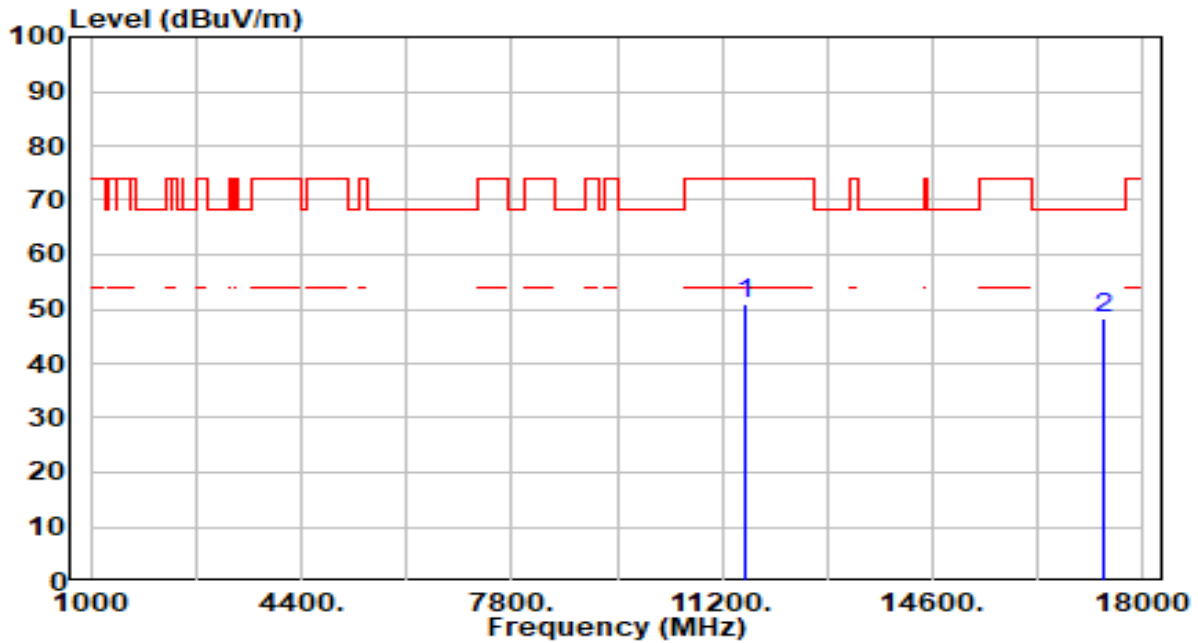

No	Frequency (MHz)	Reading (dBuV)	C.F (dB/m)	Measurement (dBuV/m)	Margin (dB)	Limit (dBuV/m)	Height (cm)	Angle (deg)	Remark (QP/PK/AV)
1	11570.000	47.44	3.65	51.09	-22.91	74.00	300	330	Peak
2	* 17355.000	44.41	4.06	48.47	-19.73	68.20	300	26	Peak

Note:

1. " *", means this data is the worst emission level.
2. C.F (Correction Factor) = Antenna Factor (dB/m)+ Cable Loss (dB) – Preamplifier(dB).
3. Measurement (dBuV/m) = Reading(dBuV) + C.F (Correction Factor).
4. The emission levels of other frequencies are very lower than the limit and not show in test report.

EUT	AX1800 Indoor/Outdoor Wi-Fi Access Point	Date of Test	2023-09-22
Factor	DRH18-E	Temp. / Humidity	20°C /60%
Polarity	Vertical	Site / Test Engineer	AC2 / Stanley
Test Mode	802.11ax-20MHz_TX_Band4_CH 157_ANT 0+1	Test Voltage	AC 120V/60Hz

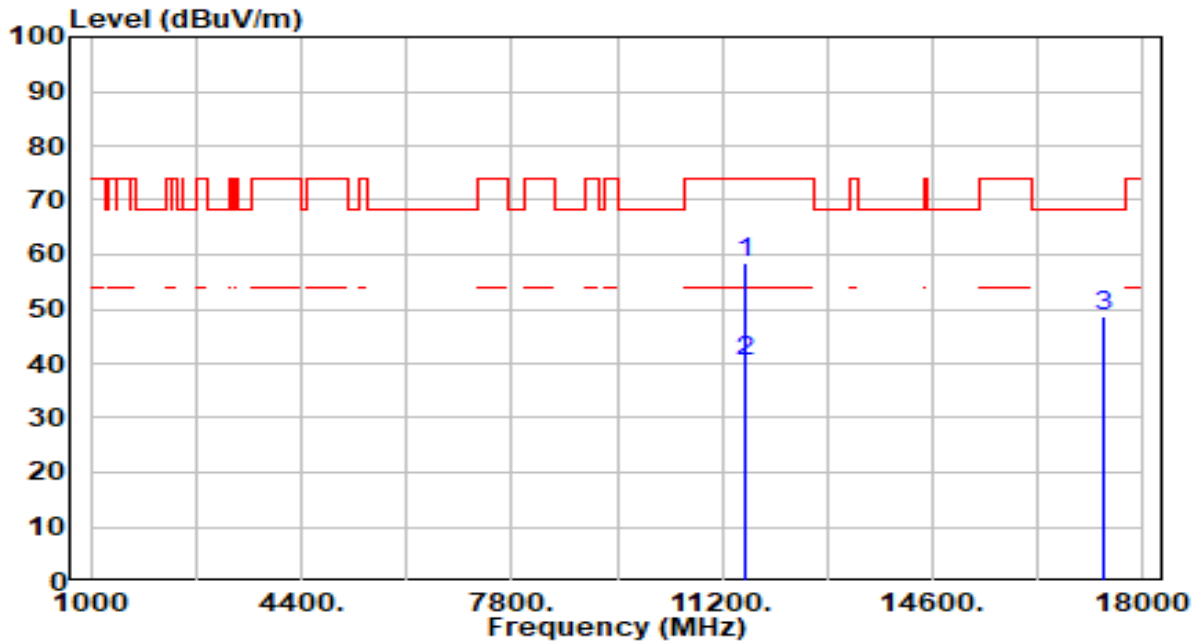

No	Frequency (MHz)	Reading (dBuV)	C.F (dB/m)	Measurement (dBuV/m)	Margin (dB)	Limit (dBuV/m)	Height (cm)	Angle (deg)	Remark (QP/PK/AV)	
1	*	11570.000	54.68	3.65	58.33	-15.67	74.00	300	2	Peak
2	*	11570.000	36.55	3.65	40.20	-13.80	54.00	300	2	Average
3		17355.000	44.57	4.06	48.63	-19.57	68.20	300	45	Peak

Note:

1. " *", means this data is the worst emission level.
2. C.F (Correction Factor) = Antenna Factor (dB/m)+ Cable Loss (dB) – Preamplifier(dB).
3. Measurement (dBuV/m) = Reading(dBuV) + C.F (Correction Factor).
4. The emission levels of other frequencies are very lower than the limit and not show in test report.

EUT	AX1800 Indoor/Outdoor Wi-Fi Access Point	Date of Test	2023-09-22
Factor	DRH18-E	Temp. / Humidity	20°C /60%
Polarity	Horizontal	Site / Test Engineer	AC2 / Stanley
Test Mode	802.11ax-20MHz_TX_Band4_CH 165_ANT 0+1	Test Voltage	AC 120V/60Hz

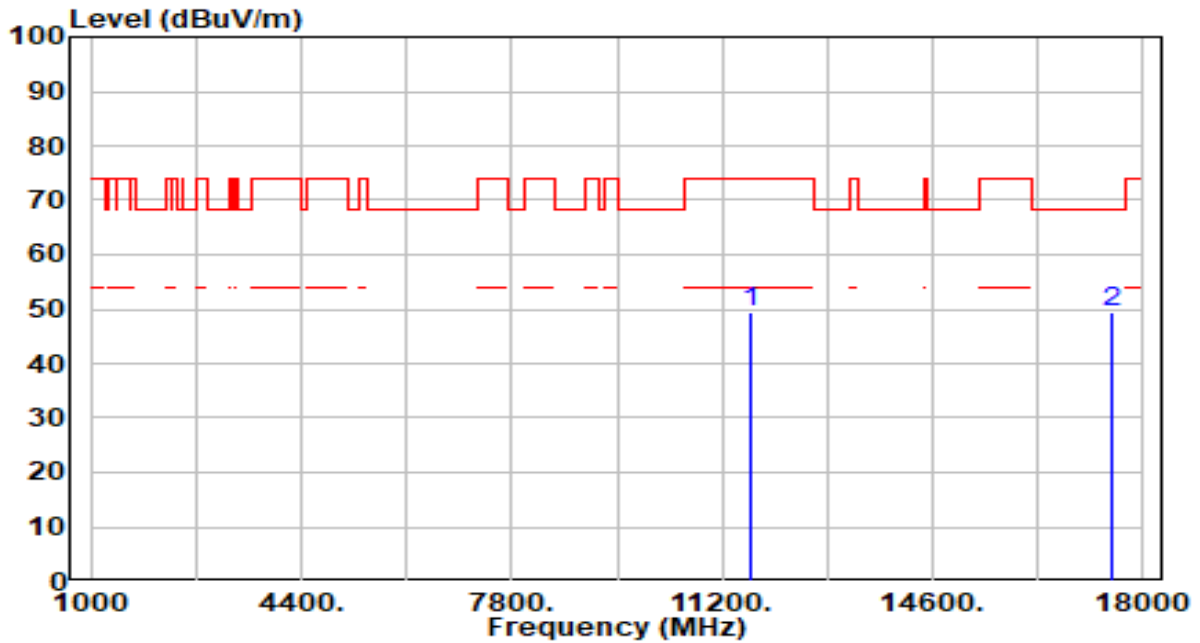

No	Frequency (MHz)	Reading (dBuV)	C.F (dB/m)	Measurement (dBuV/m)	Margin (dB)	Limit (dBuV/m)	Height (cm)	Angle (deg)	Remark (QP/PK/AV)
1	11650.000	45.89	3.66	49.55	-24.45	74.00	300	330	Peak
2	* 17475.000	45.63	3.89	49.52	-18.68	68.20	300	244	Peak

Note:

1. " *", means this data is the worst emission level.
2. C.F (Correction Factor) = Antenna Factor (dB/m)+ Cable Loss (dB) – Pre-amplifier(dB).
3. Measurement (dBuV/m) = Reading(dBuV) + C.F (Correction Factor).
4. The emission levels of other frequencies are very lower than the limit and not show in test report.

EUT	AX1800 Indoor/Outdoor Wi-Fi Access Point	Date of Test	2023-09-22
Factor	DRH18-E	Temp. / Humidity	20°C /60%
Polarity	Vertical	Site / Test Engineer	AC2 / Stanley
Test Mode	802.11ax-20MHz_TX_Band4_CH 165_ANT 0+1	Test Voltage	AC 120V/60Hz

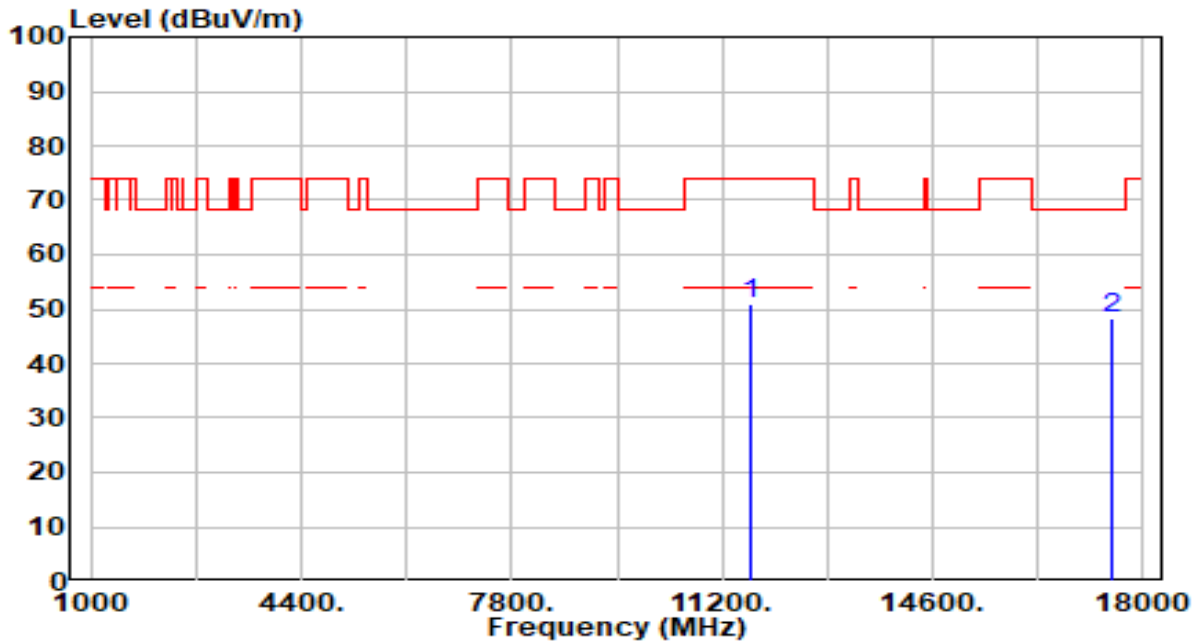

No	Frequency (MHz)	Reading (dBuV)	C.F (dB/m)	Measurement (dBuV/m)	Margin (dB)	Limit (dBuV/m)	Height (cm)	Angle (deg)	Remark (QP/PK/AV)
1	11650.000	47.31	3.66	50.97	-23.03	74.00	300	360	Peak
2	* 17475.000	44.43	3.89	48.32	-19.88	68.20	300	128	Peak

Note:

1. " *", means this data is the worst emission level.
2. C.F (Correction Factor) = Antenna Factor (dB/m)+ Cable Loss (dB) – Pre-amplifier(dB).
3. Measurement (dBuV/m) = Reading(dBuV) + C.F (Correction Factor).
4. The emission levels of other frequencies are very lower than the limit and not show in test report.

EUT	AX1800 Indoor/Outdoor Wi-Fi Access Point	Date of Test	2023-09-22
Factor	DRH18-E	Temp. / Humidity	20°C /60%
Polarity	Horizontal	Site / Test Engineer	AC2 / Stanley
Test Mode	802.11ax-40MHz_TX_Band1_CH 38_ANT 0+1	Test Voltage	AC 120V/60Hz

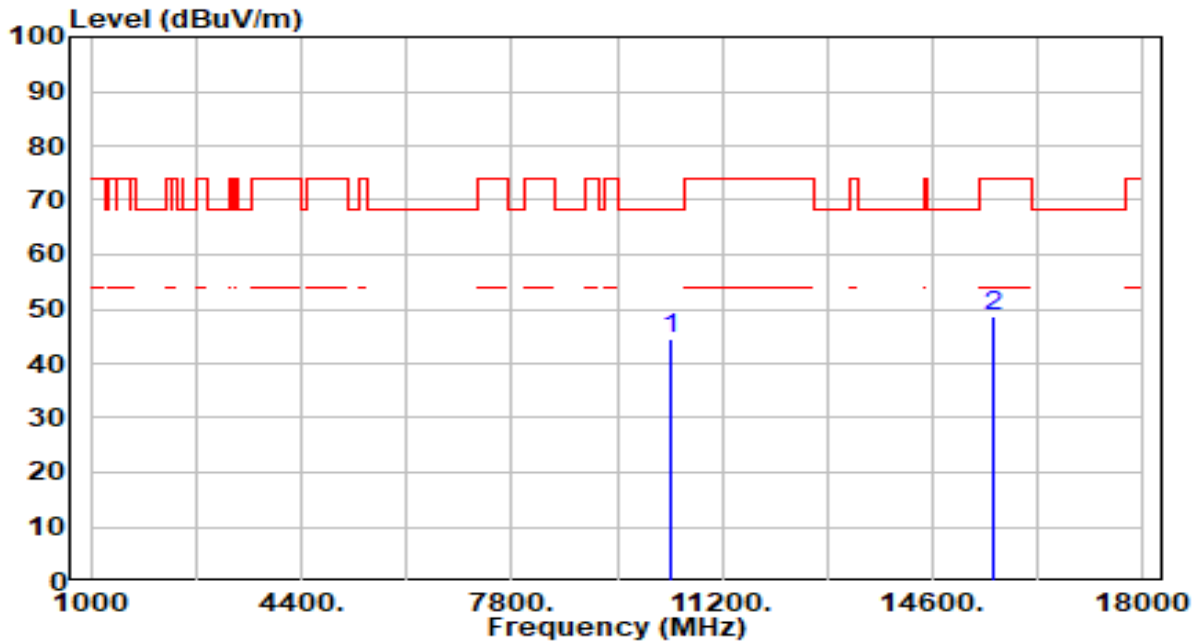

No	Frequency (MHz)	Reading (dBuV)	C.F (dB/m)	Measurement (dBuV/m)	Margin (dB)	Limit (dBuV/m)	Height (cm)	Angle (deg)	Remark (QP/PK/AV)
1	* 10380.000	41.82	2.79	44.61	-23.59	68.20	300	8	Peak
2	15570.000	44.27	4.52	48.78	-25.22	74.00	300	126	Peak

Note:

1. " *", means this data is the worst emission level.
2. C.F (Correction Factor) = Antenna Factor (dB/m)+ Cable Loss (dB) – Pre-amplifier(dB).
3. Measurement (dBuV/m) = Reading(dBuV) + C.F (Correction Factor).
4. The emission levels of other frequencies are very lower than the limit and not show in test report.

EUT	AX1800 Indoor/Outdoor Wi-Fi Access Point	Date of Test	2023-09-22
Factor	DRH18-E	Temp. / Humidity	20°C /60%
Polarity	Vertical	Site / Test Engineer	AC2 / Stanley
Test Mode	802.11ax-40MHz_TX_Band1_CH 38_ANT 0+1	Test Voltage	AC 120V/60Hz

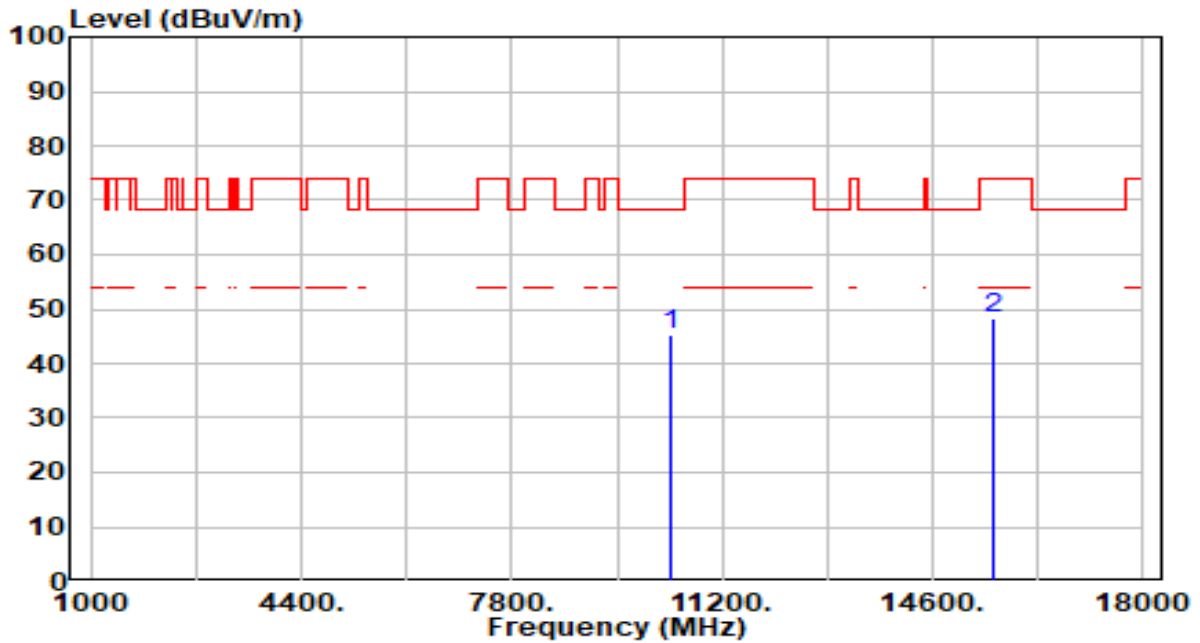

No	Frequency (MHz)	Reading (dBuV)	C.F (dB/m)	Measurement (dBuV/m)	Margin (dB)	Limit (dBuV/m)	Height (cm)	Angle (deg)	Remark (QP/PK/AV)
1	* 10380.000	42.35	2.79	45.13	-23.07	68.20	300	25	Peak
2	15570.000	43.74	4.52	48.26	-25.74	74.00	300	311	Peak

Note:

1. " *", means this data is the worst emission level.
2. C.F (Correction Factor) = Antenna Factor (dB/m)+ Cable Loss (dB) – Pre-amplifier(dB).
3. Measurement (dBuV/m) = Reading(dBuV) + C.F (Correction Factor).
4. The emission levels of other frequencies are very lower than the limit and not show in test report.

EUT	AX1800 Indoor/Outdoor Wi-Fi Access Point	Date of Test	2023-09-22
Factor	DRH18-E	Temp. / Humidity	20°C /60%
Polarity	Horizontal	Site / Test Engineer	AC2 / Stanley
Test Mode	802.11ax-40MHz_TX_Band1_CH 46_ANT 0+1	Test Voltage	AC 120V/60Hz

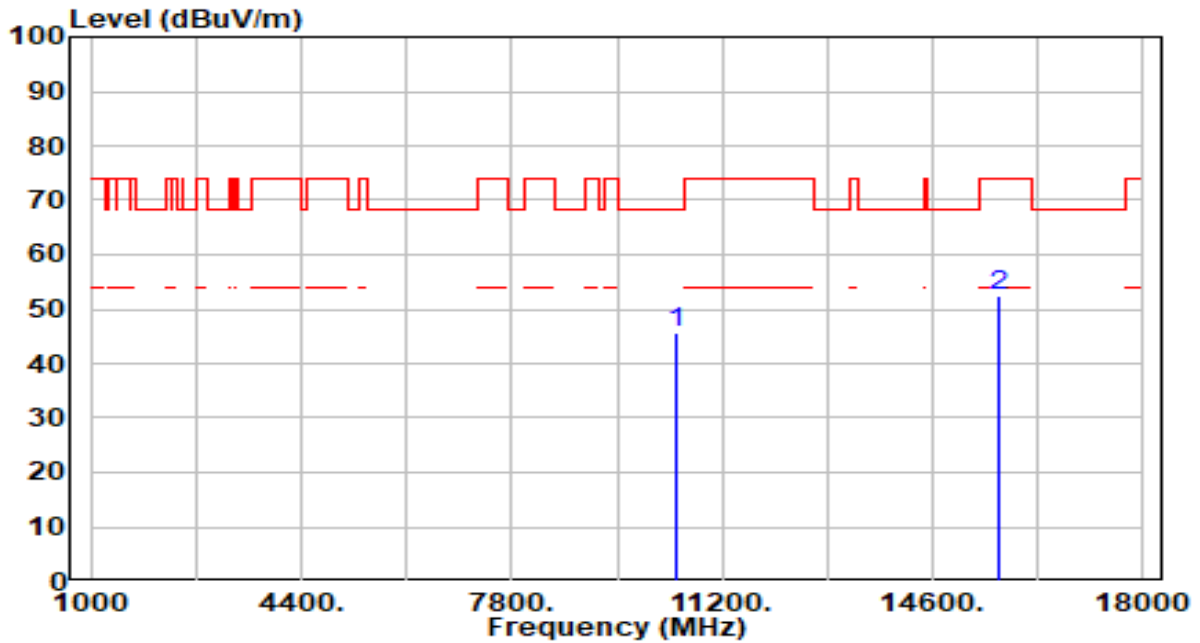

No	Frequency (MHz)	Reading (dBuV)	C.F (dB/m)	Measurement (dBuV/m)	Margin (dB)	Limit (dBuV/m)	Height (cm)	Angle (deg)	Remark (QP/PK/AV)
1	10460.000	42.79	2.70	45.49	-22.71	68.20	300	333	Peak
2	* 15690.000	47.84	4.75	52.59	-21.41	74.00	300	124	Peak

Note:

1. " *", means this data is the worst emission level.
2. C.F (Correction Factor) = Antenna Factor (dB/m)+ Cable Loss (dB) – Pre-amplifier(dB).
3. Measurement (dBuV/m) = Reading(dBuV) + C.F (Correction Factor).
4. The emission levels of other frequencies are very lower than the limit and not show in test report.

EUT	AX1800 Indoor/Outdoor Wi-Fi Access Point	Date of Test	2023-09-22
Factor	DRH18-E	Temp. / Humidity	20°C /60%
Polarity	Vertical	Site / Test Engineer	AC2 / Stanley
Test Mode	802.11ax-40MHz_TX_Band1_CH 46_ANT 0+1	Test Voltage	AC 120V/60Hz

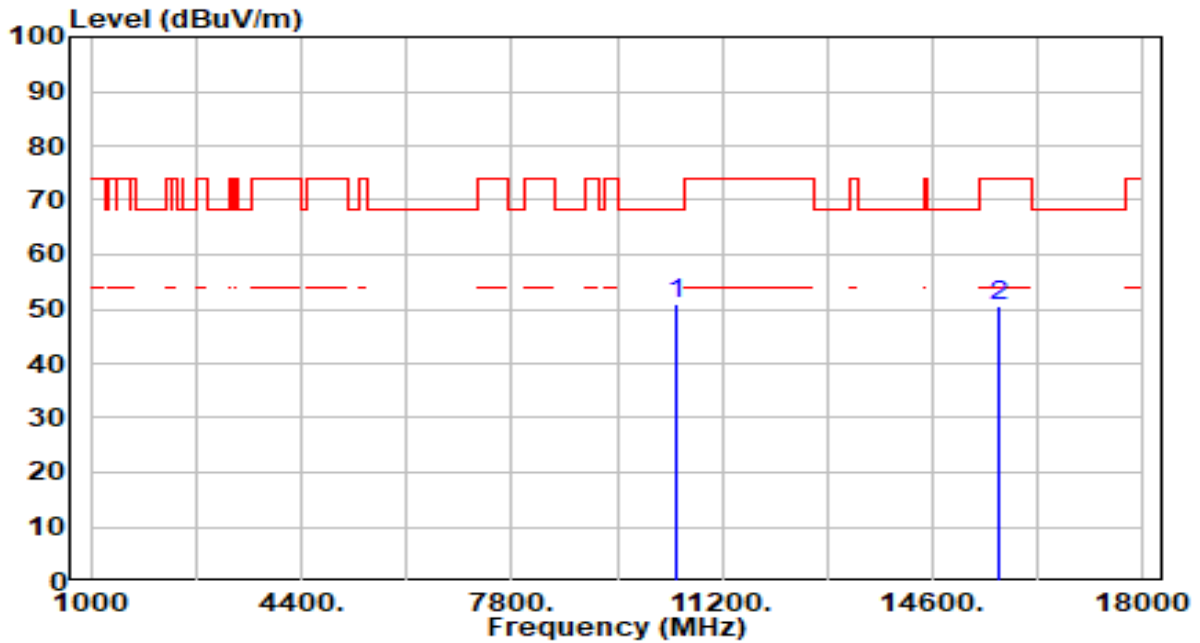

No	Frequency (MHz)	Reading (dBuV)	C.F (dB/m)	Measurement (dBuV/m)	Margin (dB)	Limit (dBuV/m)	Height (cm)	Angle (deg)	Remark (QP/PK/AV)
1	* 10460.000	48.24	2.70	50.94	-17.26	68.20	300	4	Peak
2	15690.000	45.91	4.75	50.67	-23.33	74.00	300	32	Peak

Note:

1. " *", means this data is the worst emission level.
2. C.F (Correction Factor) = Antenna Factor (dB/m)+ Cable Loss (dB) – Pre-amplifier(dB).
3. Measurement (dBuV/m) = Reading(dBuV) + C.F (Correction Factor).
4. The emission levels of other frequencies are very lower than the limit and not show in test report.

EUT	AX1800 Indoor/Outdoor Wi-Fi Access Point	Date of Test	2023-09-22
Factor	DRH18-E	Temp. / Humidity	20°C /60%
Polarity	Horizontal	Site / Test Engineer	AC2 / Stanley
Test Mode	802.11ax-40MHz_TX_Band2_CH 54_ANT 0+1	Test Voltage	AC 120V/60Hz

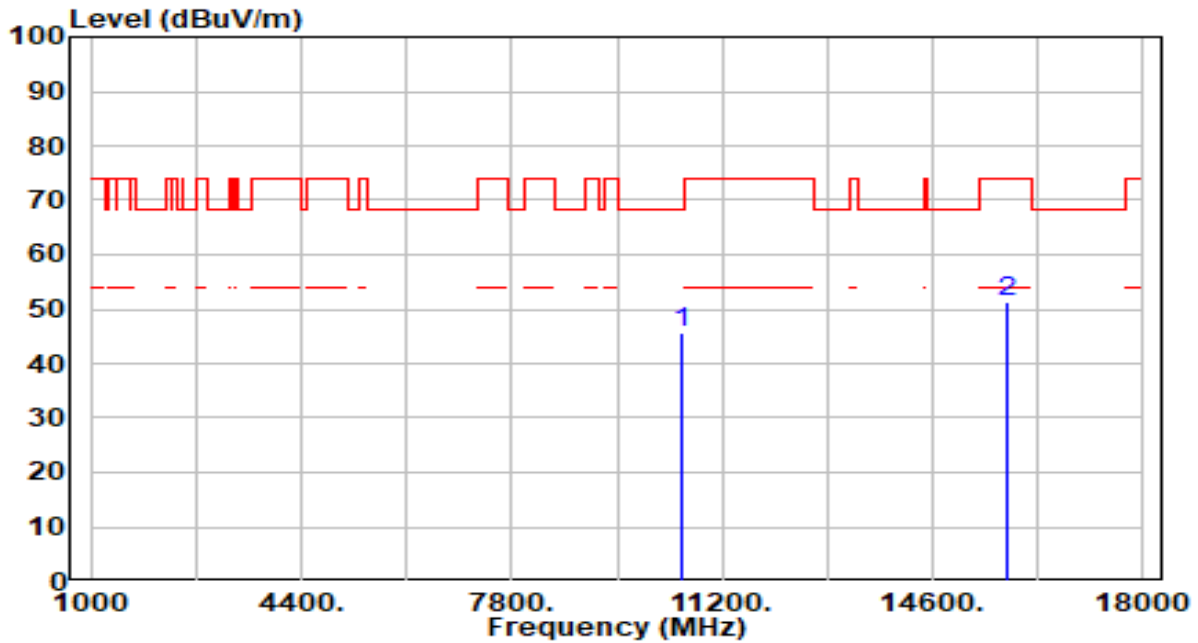

No	Frequency (MHz)	Reading (dBuV)	C.F (dB/m)	Measurement (dBuV/m)	Margin (dB)	Limit (dBuV/m)	Height (cm)	Angle (deg)	Remark (QP/PK/AV)
1	10540.000	42.97	2.63	45.61	-22.59	68.20	300	216	Peak
2	* 15810.000	46.38	5.06	51.44	-22.56	74.00	300	126	Peak

Note:

1. " *", means this data is the worst emission level.
2. C.F (Correction Factor) = Antenna Factor (dB/m)+ Cable Loss (dB) – Pre-amplifier(dB).
3. Measurement (dBuV/m) = Reading(dBuV) + C.F (Correction Factor).
4. The emission levels of other frequencies are very lower than the limit and not show in test report.

EUT	AX1800 Indoor/Outdoor Wi-Fi Access Point	Date of Test	2023-09-22
Factor	DRH18-E	Temp. / Humidity	20°C /60%
Polarity	Vertical	Site / Test Engineer	AC2 / Stanley
Test Mode	802.11ax-40MHz_TX_Band2_CH 54_ANT 0+1	Test Voltage	AC 120V/60Hz

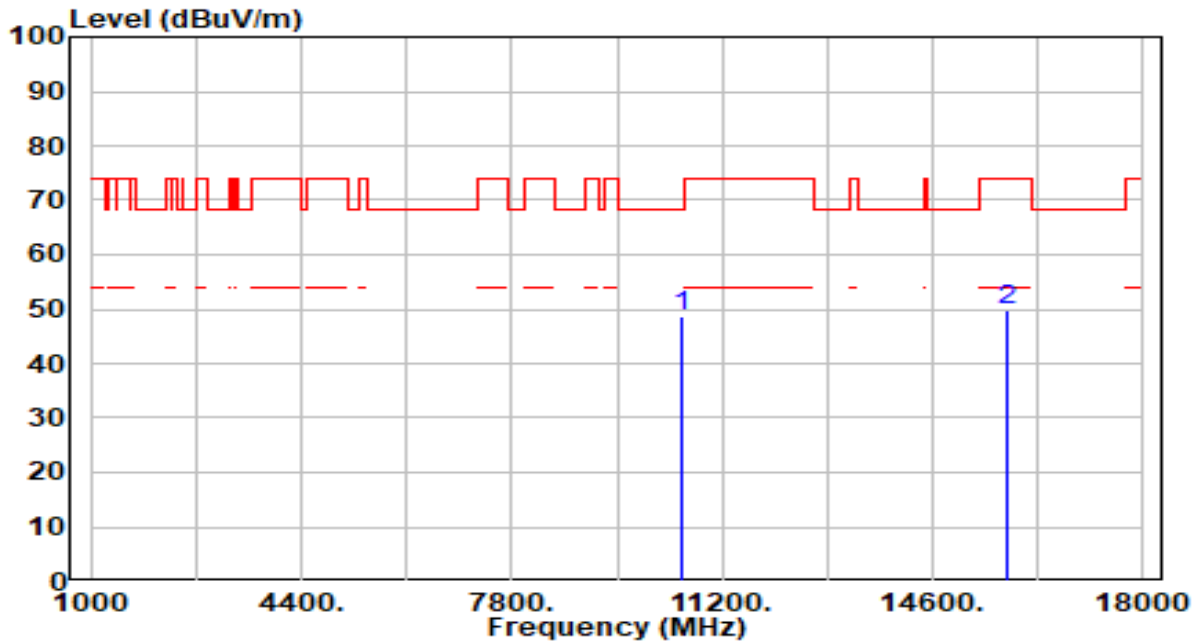

No	Frequency (MHz)	Reading (dBuV)	C.F (dB/m)	Measurement (dBuV/m)	Margin (dB)	Limit (dBuV/m)	Height (cm)	Angle (deg)	Remark (QP/PK/AV)
1	* 10540.000	46.06	2.63	48.70	-19.50	68.20	300	3	Peak
2	15810.000	44.82	5.06	49.88	-24.12	74.00	300	113	Peak

Note:

1. " *", means this data is the worst emission level.
2. C.F (Correction Factor) = Antenna Factor (dB/m)+ Cable Loss (dB) – Pre-amplifier(dB).
3. Measurement (dBuV/m) = Reading(dBuV) + C.F (Correction Factor).
4. The emission levels of other frequencies are very lower than the limit and not show in test report.

EUT	AX1800 Indoor/Outdoor Wi-Fi Access Point	Date of Test	2023-09-22
Factor	DRH18-E	Temp. / Humidity	20°C /60%
Polarity	Horizontal	Site / Test Engineer	AC2 / Stanley
Test Mode	802.11ax-40MHz_TX_Band2_CH 62_ANT 0+1	Test Voltage	AC 120V/60Hz

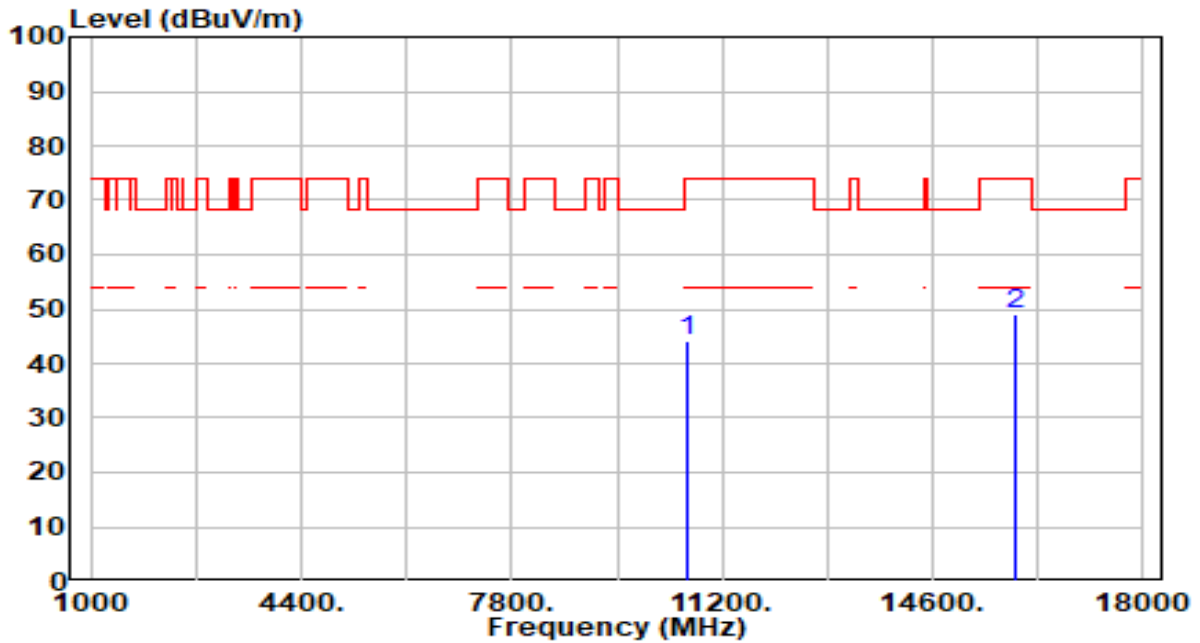

No	Frequency (MHz)	Reading (dBuV)	C.F (dB/m)	Measurement (dBuV/m)	Margin (dB)	Limit (dBuV/m)	Height (cm)	Angle (deg)	Remark (QP/PK/AV)
1	10620.000	41.59	2.61	44.20	-29.80	74.00	300	203	Peak
2	* 15930.000	44.06	5.15	49.21	-24.79	74.00	300	297	Peak

Note:

1. " *", means this data is the worst emission level.
2. C.F (Correction Factor) = Antenna Factor (dB/m)+ Cable Loss (dB) – Pre-amplifier(dB).
3. Measurement (dBuV/m) = Reading(dBuV) + C.F (Correction Factor).
4. The emission levels of other frequencies are very lower than the limit and not show in test report.

EUT	AX1800 Indoor/Outdoor Wi-Fi Access Point	Date of Test	2023-09-22
Factor	DRH18-E	Temp. / Humidity	20°C /60%
Polarity	Vertical	Site / Test Engineer	AC2 / Stanley
Test Mode	802.11ax-40MHz_TX_Band2_CH 62_ANT 0+1	Test Voltage	AC 120V/60Hz

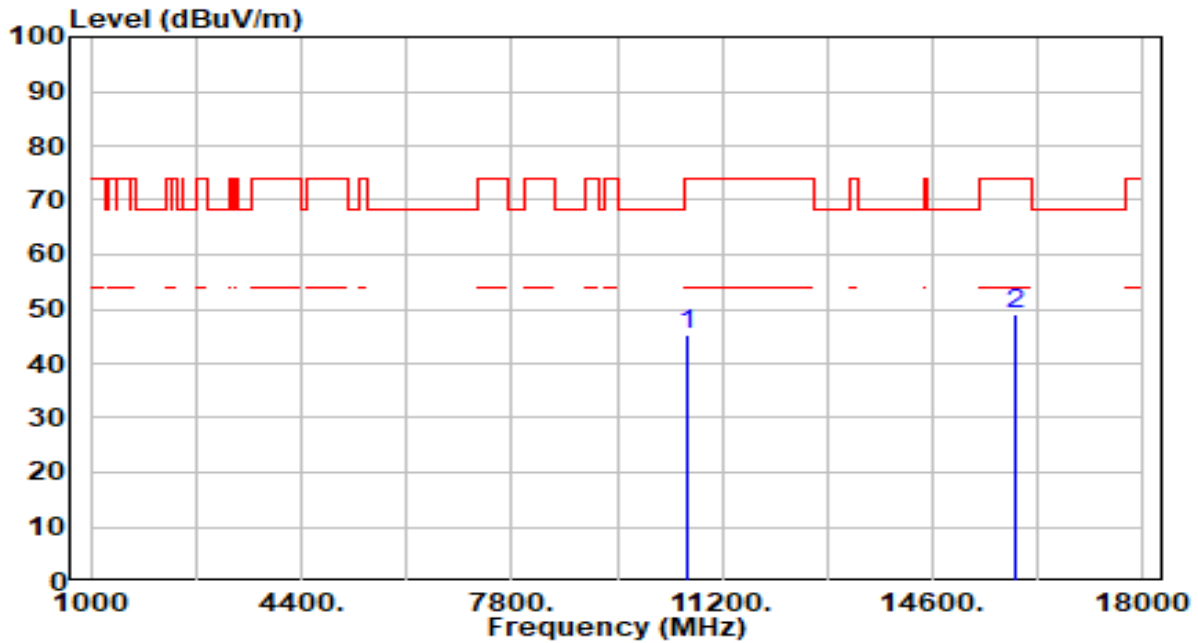

No	Frequency (MHz)	Reading (dBuV)	C.F (dB/m)	Measurement (dBuV/m)	Margin (dB)	Limit (dBuV/m)	Height (cm)	Angle (deg)	Remark (QP/PK/AV)
1	10620.000	42.70	2.61	45.31	-28.69	74.00	300	360	Peak
2	* 15930.000	43.91	5.15	49.06	-24.94	74.00	300	360	Peak

Note:

1. " *", means this data is the worst emission level.
2. C.F (Correction Factor) = Antenna Factor (dB/m)+ Cable Loss (dB) – Preamplifier(dB).
3. Measurement (dBuV/m) = Reading(dBuV) + C.F (Correction Factor).
4. The emission levels of other frequencies are very lower than the limit and not show in test report.

EUT	AX1800 Indoor/Outdoor Wi-Fi Access Point	Date of Test	2023-09-22
Factor	DRH18-E	Temp. / Humidity	20°C /60%
Polarity	Horizontal	Site / Test Engineer	AC2 / Stanley
Test Mode	802.11ax-40MHz_TX_Band3_CH 102_ANT 0+1	Test Voltage	AC 120V/60Hz

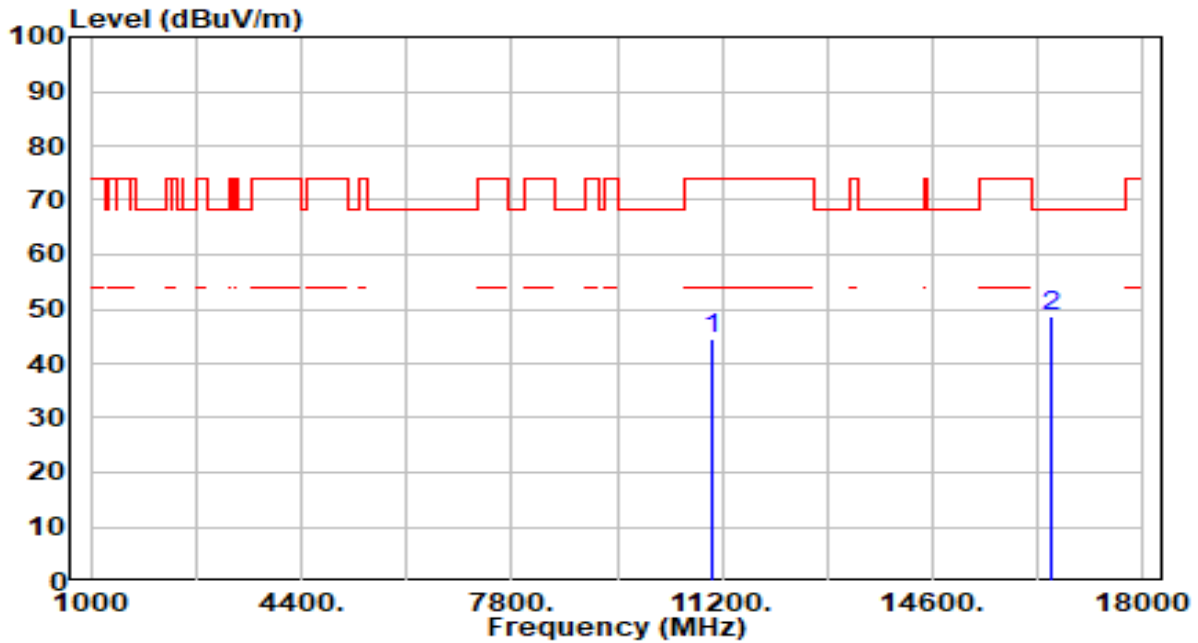

No	Frequency (MHz)	Reading (dBuV)	C.F (dB/m)	Measurement (dBuV/m)	Margin (dB)	Limit (dBuV/m)	Height (cm)	Angle (deg)	Remark (QP/PK/AV)
1	11020.000	42.06	2.66	44.71	-29.29	74.00	300	255	Peak
2	* 16530.000	44.18	4.63	48.81	-19.39	68.20	300	333	Peak

Note:

1. " *", means this data is the worst emission level.
2. C.F (Correction Factor) = Antenna Factor (dB/m)+ Cable Loss (dB) – Pre-amplifier(dB).
3. Measurement (dBuV/m) = Reading(dBuV) + C.F (Correction Factor).
4. The emission levels of other frequencies are very lower than the limit and not show in test report.

EUT	AX1800 Indoor/Outdoor Wi-Fi Access Point	Date of Test	2023-09-22
Factor	DRH18-E	Temp. / Humidity	20°C /60%
Polarity	Vertical	Site / Test Engineer	AC2 / Stanley
Test Mode	802.11ax-40MHz_TX_Band3_CH 102_ANT 0+1	Test Voltage	AC 120V/60Hz

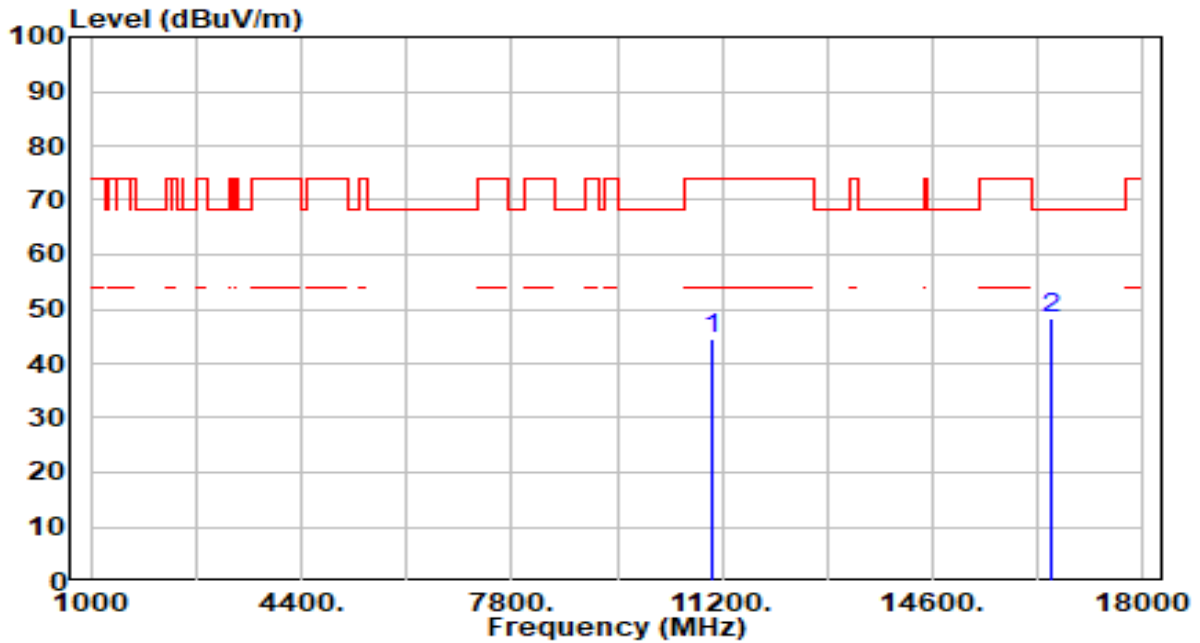

No	Frequency (MHz)	Reading (dBuV)	C.F (dB/m)	Measurement (dBuV/m)	Margin (dB)	Limit (dBuV/m)	Height (cm)	Angle (deg)	Remark (QP/PK/AV)
1	11020.000	41.81	2.66	44.47	-29.53	74.00	300	4	Peak
2	* 16530.000	43.75	4.63	48.37	-19.83	68.20	300	67	Peak

Note:

1. " *", means this data is the worst emission level.
2. C.F (Correction Factor) = Antenna Factor (dB/m)+ Cable Loss (dB) – Preamplifier(dB).
3. Measurement (dBuV/m) = Reading(dBuV) + C.F (Correction Factor).
4. The emission levels of other frequencies are very lower than the limit and not show in test report.

EUT	AX1800 Indoor/Outdoor Wi-Fi Access Point	Date of Test	2023-09-22
Factor	DRH18-E	Temp. / Humidity	20°C /60%
Polarity	Horizontal	Site / Test Engineer	AC2 / Stanley
Test Mode	802.11ax-40MHz_TX_Band3_CH 110_ANT 0+1	Test Voltage	AC 120V/60Hz

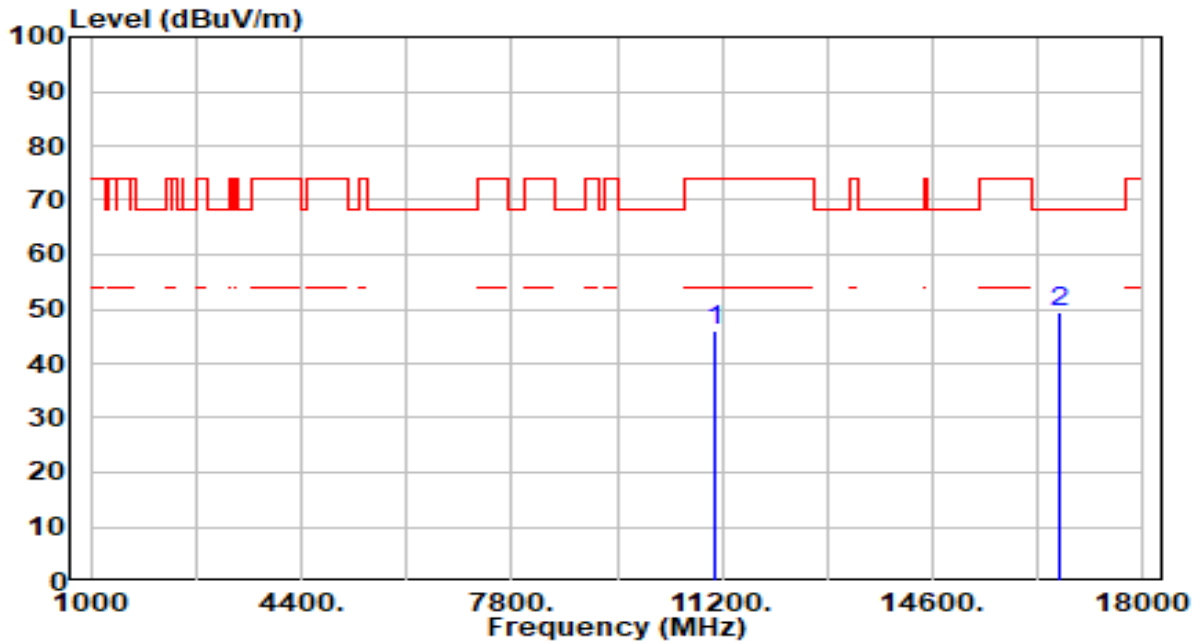

No	Frequency (MHz)	Reading (dBuV)	C.F (dB/m)	Measurement (dBuV/m)	Margin (dB)	Limit (dBuV/m)	Height (cm)	Angle (deg)	Remark (QP/PK/AV)
1	11100.000	43.11	2.90	46.01	-27.99	74.00	300	32	Peak
2	* 16650.000	44.64	4.63	49.27	-18.93	68.20	300	52	Peak

Note:

1. " *", means this data is the worst emission level.
2. C.F (Correction Factor) = Antenna Factor (dB/m)+ Cable Loss (dB) – Pre-amplifier(dB).
3. Measurement (dBuV/m) = Reading(dBuV) + C.F (Correction Factor).
4. The emission levels of other frequencies are very lower than the limit and not show in test report.

EUT	AX1800 Indoor/Outdoor Wi-Fi Access Point	Date of Test	2023-09-22
Factor	DRH18-E	Temp. / Humidity	20°C /60%
Polarity	Vertical	Site / Test Engineer	AC2 / Stanley
Test Mode	802.11ax-40MHz_TX_Band3_CH 110_ANT 0+1	Test Voltage	AC 120V/60Hz

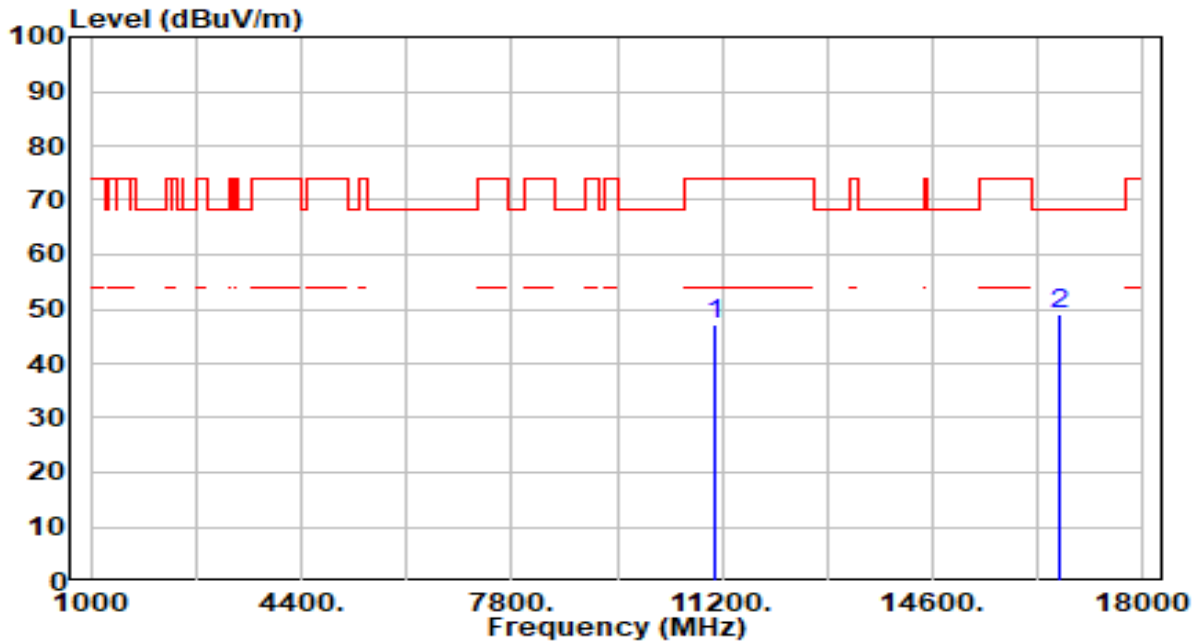

No	Frequency (MHz)	Reading (dBuV)	C.F (dB/m)	Measurement (dBuV/m)	Margin (dB)	Limit (dBuV/m)	Height (cm)	Angle (deg)	Remark (QP/PK/AV)
1	11100.000	44.11	2.90	47.00	-27.00	74.00	300	7	Peak
2	* 16650.000	44.54	4.63	49.17	-19.03	68.20	300	246	Peak

Note:

1. " *", means this data is the worst emission level.
2. C.F (Correction Factor) = Antenna Factor (dB/m)+ Cable Loss (dB) – Pre-amplifier(dB).
3. Measurement (dBuV/m) = Reading(dBuV) + C.F (Correction Factor).
4. The emission levels of other frequencies are very lower than the limit and not show in test report.

EUT	AX1800 Indoor/Outdoor Wi-Fi Access Point	Date of Test	2023-09-22
Factor	DRH18-E	Temp. / Humidity	20°C /60%
Polarity	Horizontal	Site / Test Engineer	AC2 / Stanley
Test Mode	802.11ax-40MHz_TX_Band3_CH 134_ANT 0+1	Test Voltage	AC 120V/60Hz

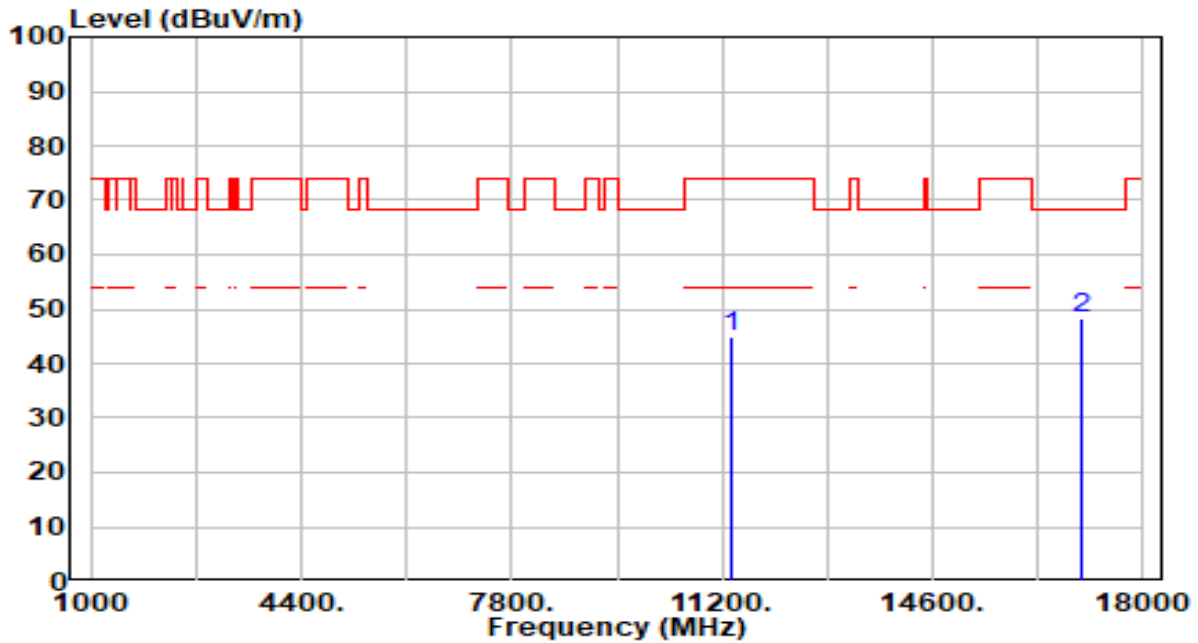

No	Frequency (MHz)	Reading (dBuV)	C.F (dB/m)	Measurement (dBuV/m)	Margin (dB)	Limit (dBuV/m)	Height (cm)	Angle (deg)	Remark (QP/PK/AV)
1	11340.000	41.37	3.39	44.77	-29.23	74.00	300	126	Peak
2	* 17010.000	43.17	5.00	48.17	-20.03	68.20	300	226	Peak

Note:

1. " *", means this data is the worst emission level.
2. C.F (Correction Factor) = Antenna Factor (dB/m)+ Cable Loss (dB) – Pre-amplifier(dB).
3. Measurement (dBuV/m) = Reading(dBuV) + C.F (Correction Factor).
4. The emission levels of other frequencies are very lower than the limit and not show in test report.

EUT	AX1800 Indoor/Outdoor Wi-Fi Access Point	Date of Test	2023-09-22
Factor	DRH18-E	Temp. / Humidity	20°C /60%
Polarity	Vertical	Site / Test Engineer	AC2 / Stanley
Test Mode	802.11ax-40MHz_TX_Band3_CH 134_ANT 0+1	Test Voltage	AC 120V/60Hz

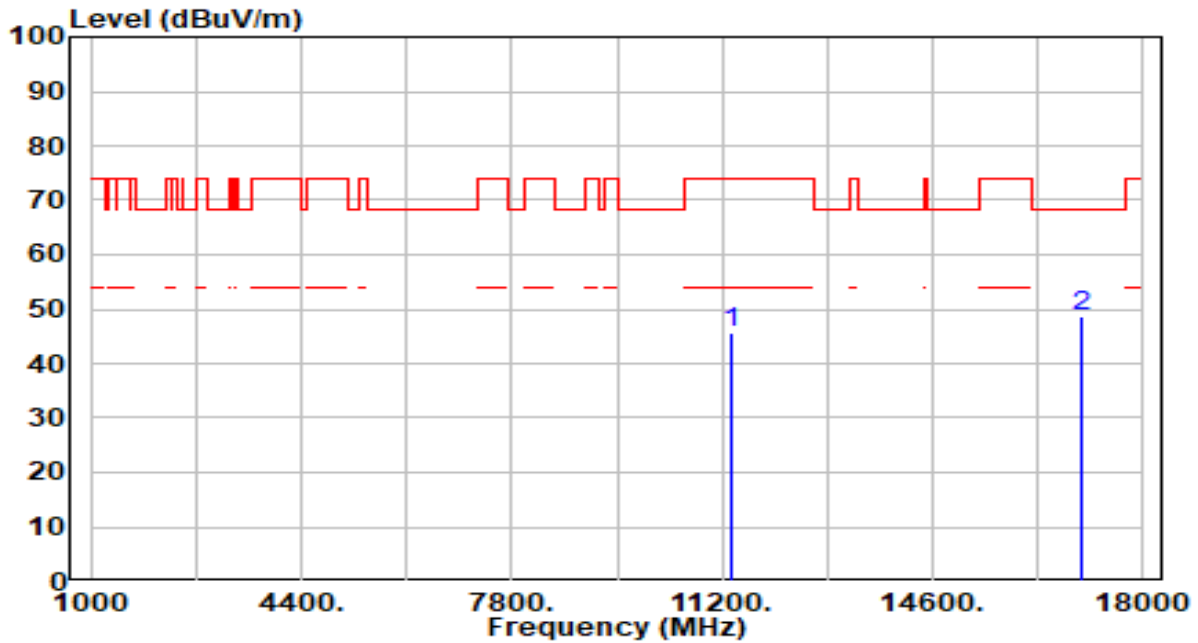

No	Frequency (MHz)	Reading (dBuV)	C.F (dB/m)	Measurement (dBuV/m)	Margin (dB)	Limit (dBuV/m)	Height (cm)	Angle (deg)	Remark (QP/PK/AV)
1	11340.000	42.39	3.39	45.78	-28.22	74.00	300	96	Peak
2	* 17010.000	43.52	5.00	48.52	-19.68	68.20	300	300	Peak

Note:

1. " *", means this data is the worst emission level.
2. C.F (Correction Factor) = Antenna Factor (dB/m)+ Cable Loss (dB) – Pre-amplifier(dB).
3. Measurement (dBuV/m) = Reading(dBuV) + C.F (Correction Factor).
4. The emission levels of other frequencies are very lower than the limit and not show in test report.

EUT	AX1800 Indoor/Outdoor Wi-Fi Access Point	Date of Test	2023-09-22
Factor	DRH18-E	Temp. / Humidity	20°C /60%
Polarity	Horizontal	Site / Test Engineer	AC2 / Stanley
Test Mode	802.11ax-40MHz_TX_Band3_CH 142_ANT 0+1	Test Voltage	AC 120V/60Hz

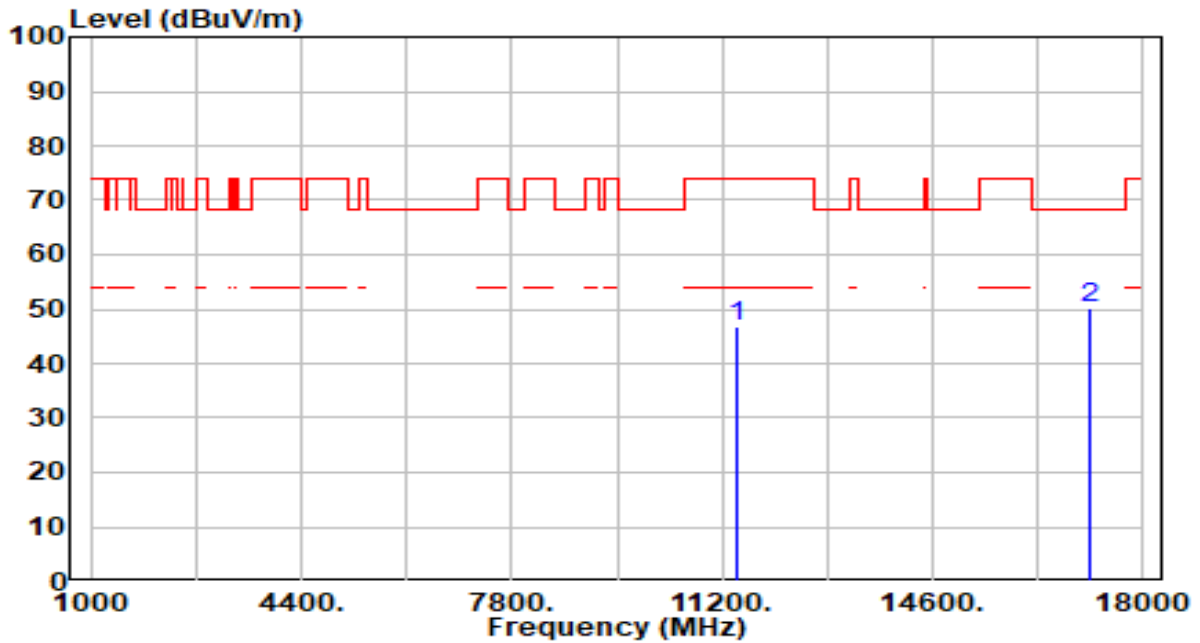

No	Frequency (MHz)	Reading (dBuV)	C.F (dB/m)	Measurement (dBuV/m)	Margin (dB)	Limit (dBuV/m)	Height (cm)	Angle (deg)	Remark (QP/PK/AV)
1	11420.000	43.16	3.50	46.66	-27.34	74.00	300	341	Peak
2	* 17130.000	45.36	4.72	50.08	-18.12	68.20	300	166	Peak

Note:

1. " *", means this data is the worst emission level.
2. C.F (Correction Factor) = Antenna Factor (dB/m)+ Cable Loss (dB) – Pre-amplifier(dB).
3. Measurement (dBuV/m) = Reading(dBuV) + C.F (Correction Factor).
4. The emission levels of other frequencies are very lower than the limit and not show in test report.

EUT	AX1800 Indoor/Outdoor Wi-Fi Access Point	Date of Test	2023-09-22
Factor	DRH18-E	Temp. / Humidity	20°C /60%
Polarity	Vertical	Site / Test Engineer	AC2 / Stanley
Test Mode	802.11ax-40MHz_TX_Band3_CH 142_ANT 0+1	Test Voltage	AC 120V/60Hz

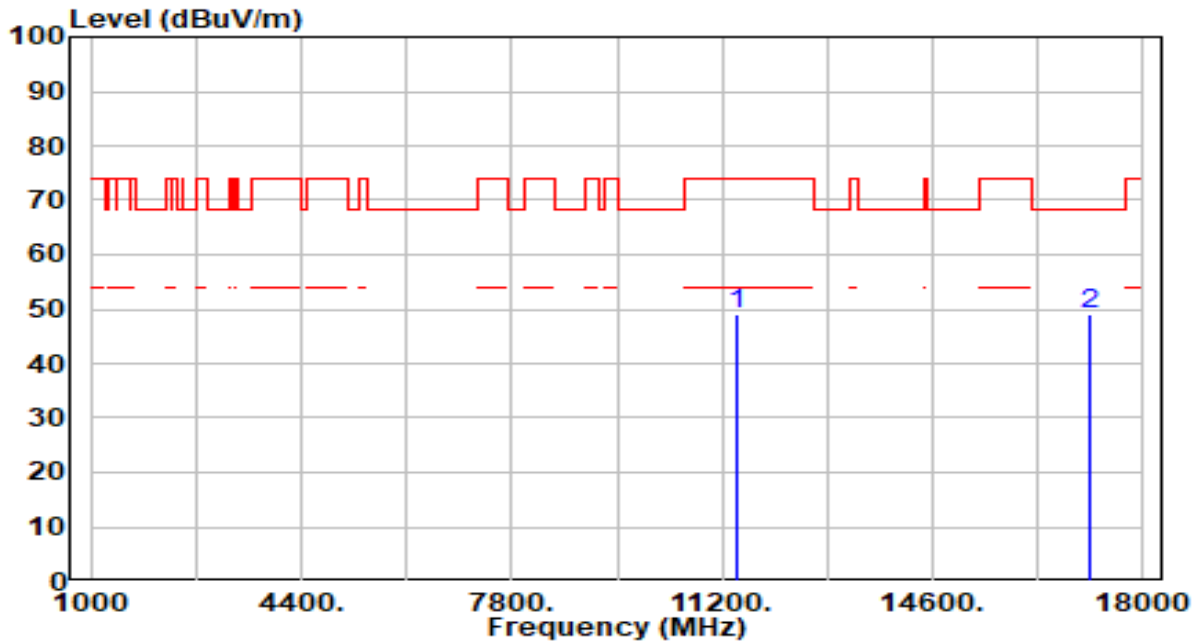

No	Frequency (MHz)	Reading (dBuV)	C.F (dB/m)	Measurement (dBuV/m)	Margin (dB)	Limit (dBuV/m)	Height (cm)	Angle (deg)	Remark (QP/PK/AV)
1	11420.000	45.59	3.50	49.09	-24.91	74.00	300	357	Peak
2	* 17130.000	44.48	4.72	49.21	-18.99	68.20	300	208	Peak

Note:

1. " *", means this data is the worst emission level.
2. C.F (Correction Factor) = Antenna Factor (dB/m)+ Cable Loss (dB) – Pre-amplifier(dB).
3. Measurement (dBuV/m) = Reading(dBuV) + C.F (Correction Factor).
4. The emission levels of other frequencies are very lower than the limit and not show in test report.

EUT	AX1800 Indoor/Outdoor Wi-Fi Access Point	Date of Test	2023-09-22
Factor	DRH18-E	Temp. / Humidity	20°C /60%
Polarity	Horizontal	Site / Test Engineer	AC2 / Stanley
Test Mode	802.11ax-40MHz_TX_Band4_CH 151_ANT 0+1	Test Voltage	AC 120V/60Hz

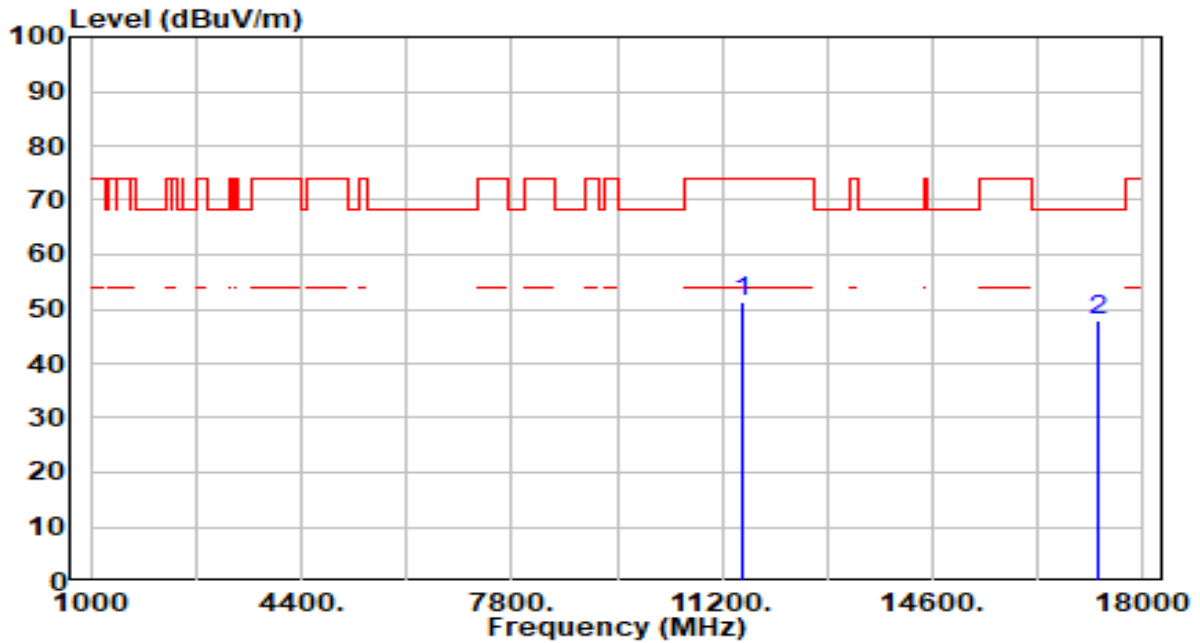

No	Frequency (MHz)	Reading (dBuV)	C.F (dB/m)	Measurement (dBuV/m)	Margin (dB)	Limit (dBuV/m)	Height (cm)	Angle (deg)	Remark (QP/PK/AV)
1	11510.000	47.57	3.59	51.16	-22.84	74.00	300	327	Peak
2	* 17265.000	43.61	4.35	47.96	-20.24	68.20	300	292	Peak

Note:

1. " *", means this data is the worst emission level.
2. C.F (Correction Factor) = Antenna Factor (dB/m)+ Cable Loss (dB) – Pre-amplifier(dB).
3. Measurement (dBuV/m) = Reading(dBuV) + C.F (Correction Factor).
4. The emission levels of other frequencies are very lower than the limit and not show in test report.

EUT	AX1800 Indoor/Outdoor Wi-Fi Access Point	Date of Test	2023-09-22
Factor	DRH18-E	Temp. / Humidity	20°C /60%
Polarity	Vertical	Site / Test Engineer	AC2 / Stanley
Test Mode	802.11ax-40MHz_TX_Band4_CH 151_ANT 0+1	Test Voltage	AC 120V/60Hz

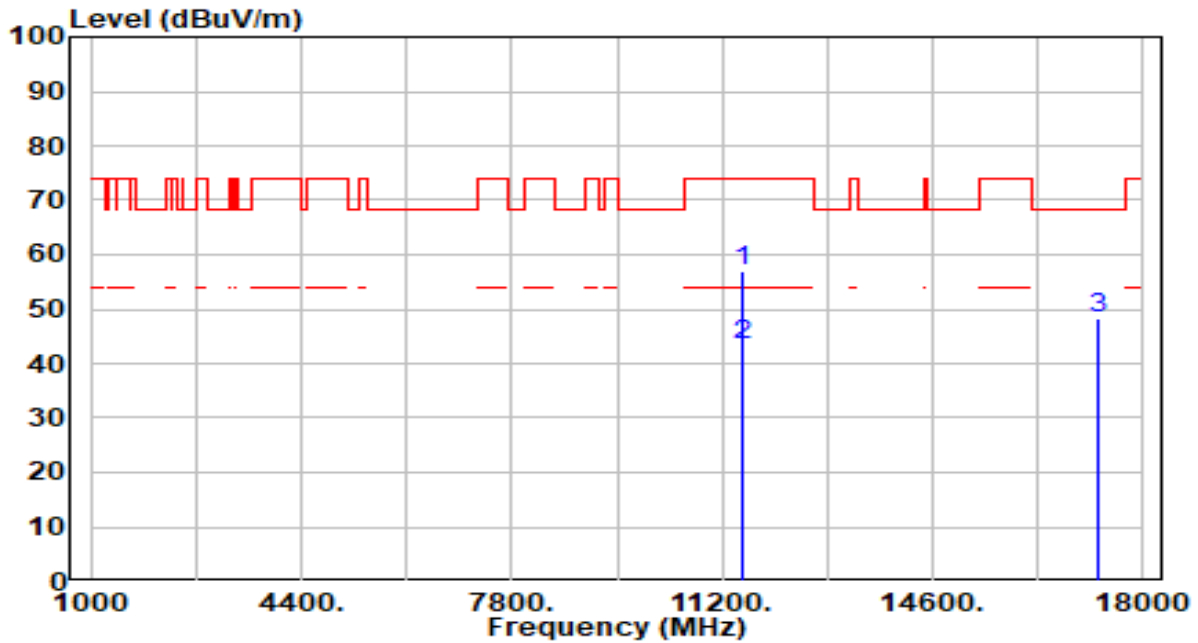

No	Frequency (MHz)	Reading (dBuV)	C.F (dB/m)	Measurement (dBuV/m)	Margin (dB)	Limit (dBuV/m)	Height (cm)	Angle (deg)	Remark (QP/PK/AV)
1	*	53.47	3.59	57.06	-16.94	74.00	300	0	Peak
2	*	39.75	3.59	43.34	-10.66	54.00	300	0	Average
3		43.91	4.35	48.27	-19.93	68.20	300	231	Peak

Note:

1. " *", means this data is the worst emission level.
2. C.F (Correction Factor) = Antenna Factor (dB/m)+ Cable Loss (dB) – Preamplifier(dB).
3. Measurement (dBuV/m) = Reading(dBuV) + C.F (Correction Factor).
4. The emission levels of other frequencies are very lower than the limit and not show in test report.

EUT	AX1800 Indoor/Outdoor Wi-Fi Access Point	Date of Test	2023-09-22
Factor	DRH18-E	Temp. / Humidity	20°C /60%
Polarity	Horizontal	Site / Test Engineer	AC2 / Stanley
Test Mode	802.11ax-40MHz_TX_Band4_CH 159_ANT 0+1	Test Voltage	AC 120V/60Hz

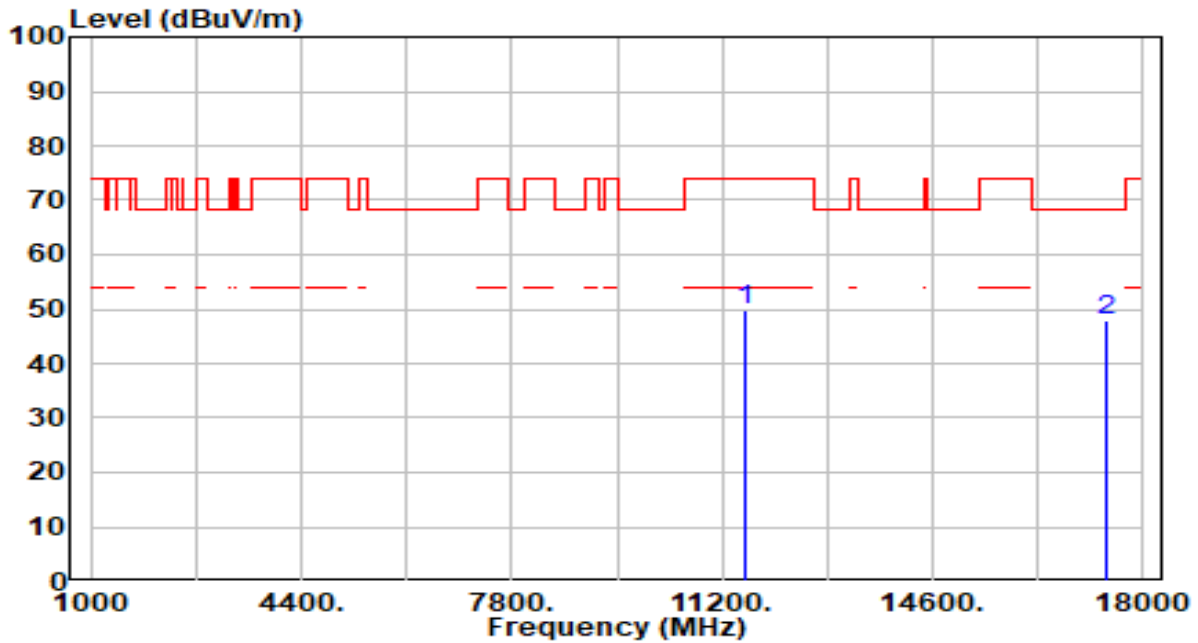

No	Frequency (MHz)	Reading (dBuV)	C.F (dB/m)	Measurement (dBuV/m)	Margin (dB)	Limit (dBuV/m)	Height (cm)	Angle (deg)	Remark (QP/PK/AV)
1	11590.000	46.28	3.67	49.95	-24.05	74.00	300	323	Peak
2	* 17385.000	43.91	3.96	47.87	-20.33	68.20	300	31	Peak

Note:

1. " *", means this data is the worst emission level.
2. C.F (Correction Factor) = Antenna Factor (dB/m)+ Cable Loss (dB) – Pre-amplifier(dB).
3. Measurement (dBuV/m) = Reading(dBuV) + C.F (Correction Factor).
4. The emission levels of other frequencies are very lower than the limit and not show in test report.

EUT	AX1800 Indoor/Outdoor Wi-Fi Access Point	Date of Test	2023-09-22
Factor	DRH18-E	Temp. / Humidity	20°C /60%
Polarity	Vertical	Site / Test Engineer	AC2 / Stanley
Test Mode	802.11ax-40MHz_TX_Band4_CH 159_ANT 0+1	Test Voltage	AC 120V/60Hz

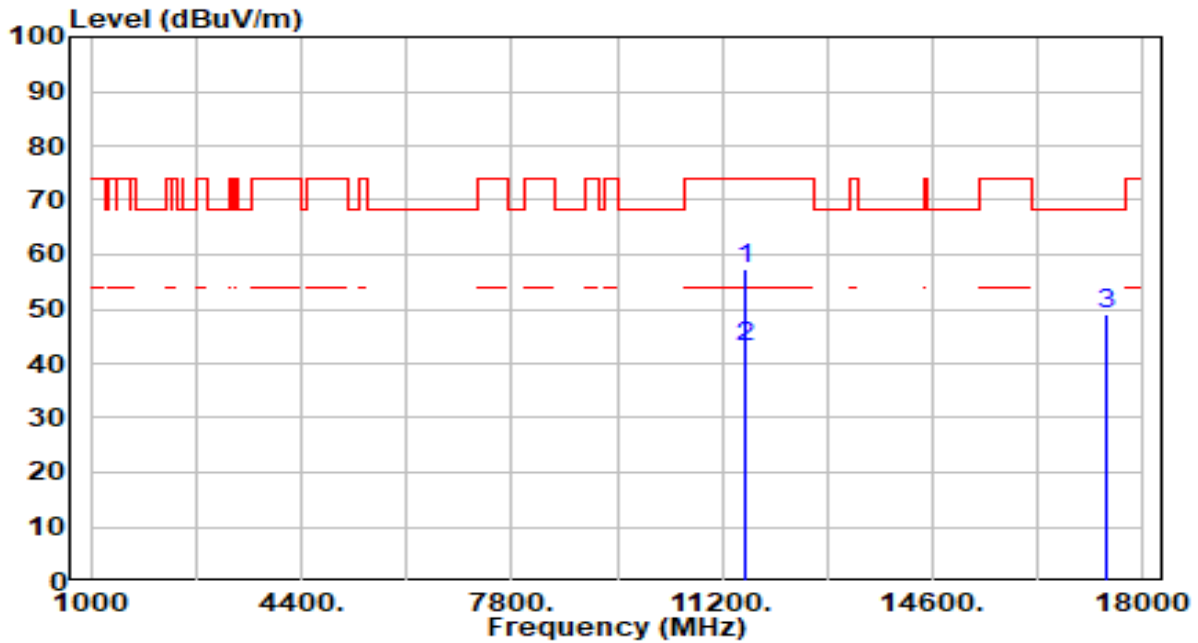

No	Frequency (MHz)	Reading (dBuV)	C.F (dB/m)	Measurement (dBuV/m)	Margin (dB)	Limit (dBuV/m)	Height (cm)	Angle (deg)	Remark (QP/PK/AV)	
1	*	11590.000	53.78	3.67	57.45	-16.55	74.00	300	9	Peak
2	*	11590.000	39.52	3.67	43.19	-10.81	54.00	300	9	Average
3		17385.000	45.12	3.96	49.08	-19.12	68.20	300	24	Peak

Note:

1. " *", means this data is the worst emission level.
2. C.F (Correction Factor) = Antenna Factor (dB/m)+ Cable Loss (dB) – Preamplifier(dB).
3. Measurement (dBuV/m) = Reading(dBuV) + C.F (Correction Factor).
4. The emission levels of other frequencies are very lower than the limit and not show in test report.

EUT	AX1800 Indoor/Outdoor Wi-Fi Access Point	Date of Test	2023-09-22
Factor	DRH18-E	Temp. / Humidity	20°C /60%
Polarity	Horizontal	Site / Test Engineer	AC2 / Stanley
Test Mode	802.11ax-80MHz_TX_Band1_CH 42_ANT 0+1	Test Voltage	AC 120V/60Hz

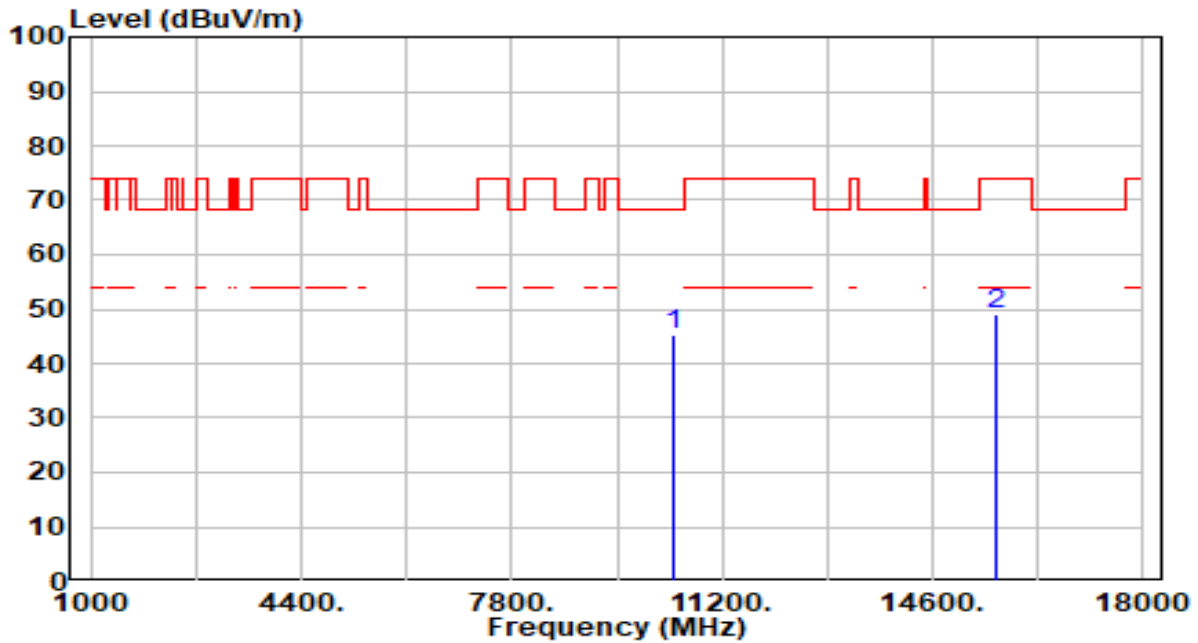

No	Frequency (MHz)	Reading (dBuV)	C.F (dB/m)	Measurement (dBuV/m)	Margin (dB)	Limit (dBuV/m)	Height (cm)	Angle (deg)	Remark (QP/PK/AV)
1	* 10420.000	42.46	2.74	45.21	-22.99	68.20	300	327	Peak
2	15630.000	44.64	4.59	49.23	-24.77	74.00	300	11	Peak

Note:

1. " *", means this data is the worst emission level.
2. C.F (Correction Factor) = Antenna Factor (dB/m)+ Cable Loss (dB) – Pre-amplifier(dB).
3. Measurement (dBuV/m) = Reading(dBuV) + C.F (Correction Factor).
4. The emission levels of other frequencies are very lower than the limit and not show in test report.

EUT	AX1800 Indoor/Outdoor Wi-Fi Access Point	Date of Test	2023-09-22
Factor	DRH18-E	Temp. / Humidity	20°C /60%
Polarity	Vertical	Site / Test Engineer	AC2 / Stanley
Test Mode	802.11ax-80MHz_TX_Band1_CH 42_ANT 0+1	Test Voltage	AC 120V/60Hz

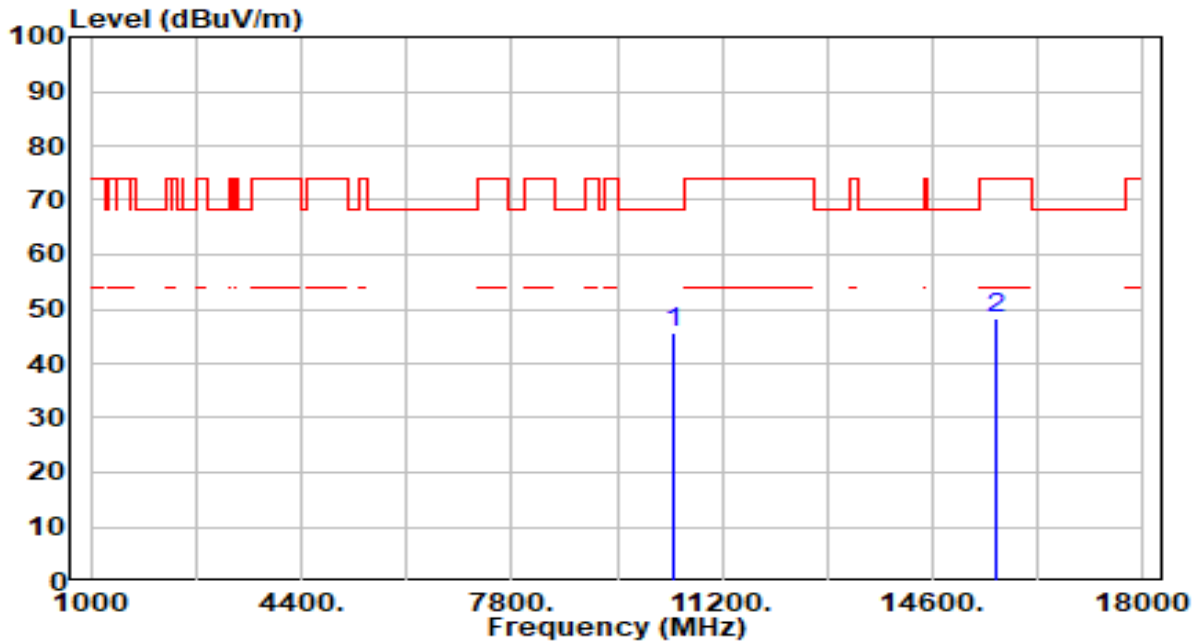

No	Frequency (MHz)	Reading (dBuV)	C.F (dB/m)	Measurement (dBuV/m)	Margin (dB)	Limit (dBuV/m)	Height (cm)	Angle (deg)	Remark (QP/PK/AV)
1	* 10420.000	43.10	2.74	45.84	-22.36	68.20	300	11	Peak
2	15630.000	43.85	4.59	48.44	-25.56	74.00	300	108	Peak

Note:

1. " *", means this data is the worst emission level.
2. C.F (Correction Factor) = Antenna Factor (dB/m)+ Cable Loss (dB) – Pre-amplifier(dB).
3. Measurement (dBuV/m) = Reading(dBuV) + C.F (Correction Factor).
4. The emission levels of other frequencies are very lower than the limit and not show in test report.

EUT	AX1800 Indoor/Outdoor Wi-Fi Access Point	Date of Test	2023-09-22
Factor	DRH18-E	Temp. / Humidity	20°C /60%
Polarity	Horizontal	Site / Test Engineer	AC2 / Stanley
Test Mode	802.11ax-80MHz_TX_Band2_CH 58_ANT 0+1	Test Voltage	AC 120V/60Hz

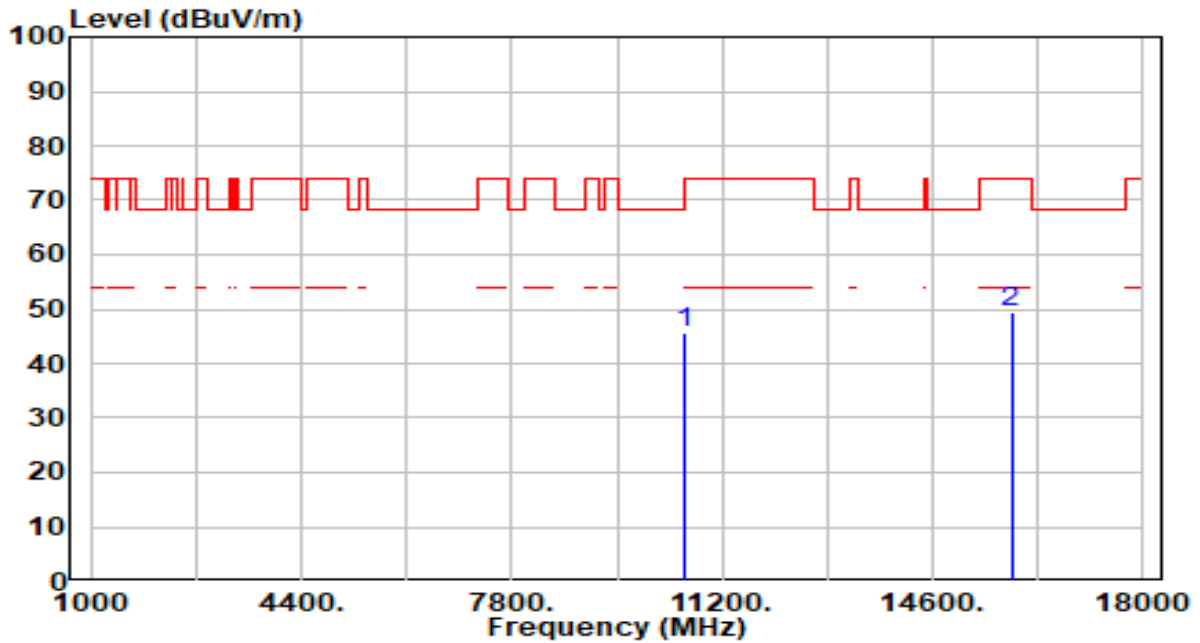

No	Frequency (MHz)	Reading (dBuV)	C.F (dB/m)	Measurement (dBuV/m)	Margin (dB)	Limit (dBuV/m)	Height (cm)	Angle (deg)	Remark (QP/PK/AV)
1	* 10580.000	43.12	2.61	45.74	-22.46	68.20	300	360	Peak
2	15870.000	44.20	5.11	49.30	-24.70	74.00	300	64	Peak

Note:

1. " *", means this data is the worst emission level.
2. C.F (Correction Factor) = Antenna Factor (dB/m)+ Cable Loss (dB) – Pre-amplifier(dB).
3. Measurement (dBuV/m) = Reading(dBuV) + C.F (Correction Factor).
4. The emission levels of other frequencies are very lower than the limit and not show in test report.

EUT	AX1800 Indoor/Outdoor Wi-Fi Access Point	Date of Test	2023-09-22
Factor	DRH18-E	Temp. / Humidity	20°C /60%
Polarity	Vertical	Site / Test Engineer	AC2 / Stanley
Test Mode	802.11ax-80MHz_TX_Band2_CH 58_ANT 0+1	Test Voltage	AC 120V/60Hz

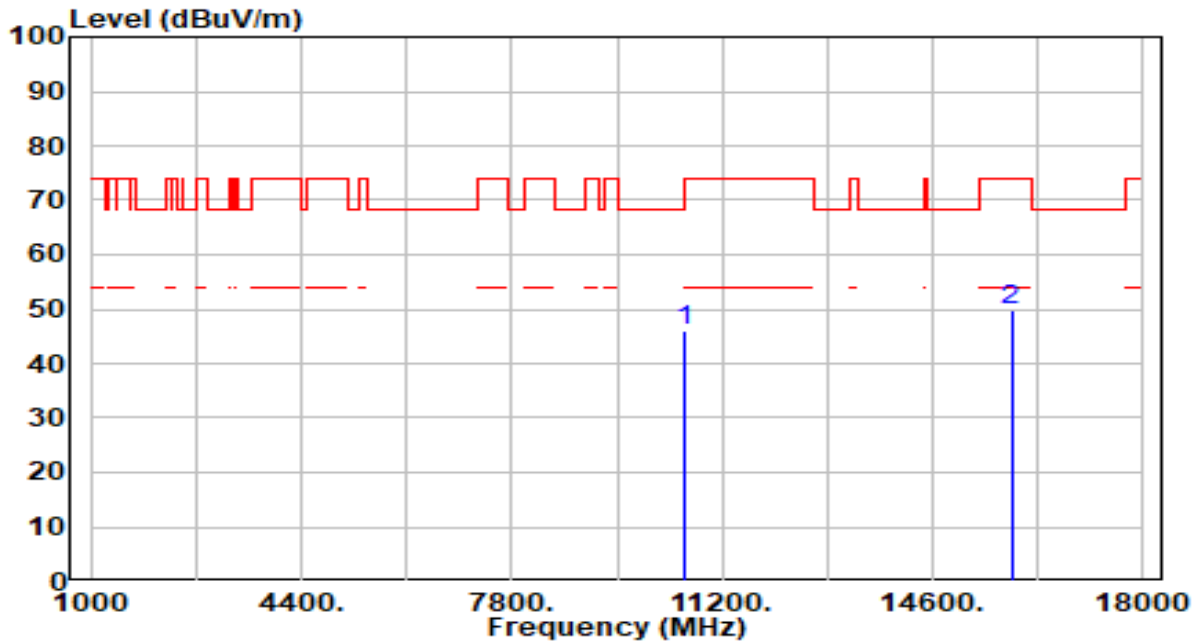

No	Frequency (MHz)	Reading (dBuV)	C.F (dB/m)	Measurement (dBuV/m)	Margin (dB)	Limit (dBuV/m)	Height (cm)	Angle (deg)	Remark (QP/PK/AV)
1	*	43.36	2.61	45.98	-22.22	68.20	300	272	Peak
2		44.53	5.11	49.63	-24.37	74.00	300	197	Peak

Note:

1. " *", means this data is the worst emission level.
2. C.F (Correction Factor) = Antenna Factor (dB/m)+ Cable Loss (dB) – Pre-amplifier(dB).
3. Measurement (dBuV/m) = Reading(dBuV) + C.F (Correction Factor).
4. The emission levels of other frequencies are very lower than the limit and not show in test report.

EUT	AX1800 Indoor/Outdoor Wi-Fi Access Point	Date of Test	2023-09-22
Factor	DRH18-E	Temp. / Humidity	20°C /60%
Polarity	Horizontal	Site / Test Engineer	AC2 / Stanley
Test Mode	802.11ax-80MHz_TX_Band3_CH 106_ANT 0+1	Test Voltage	AC 120V/60Hz

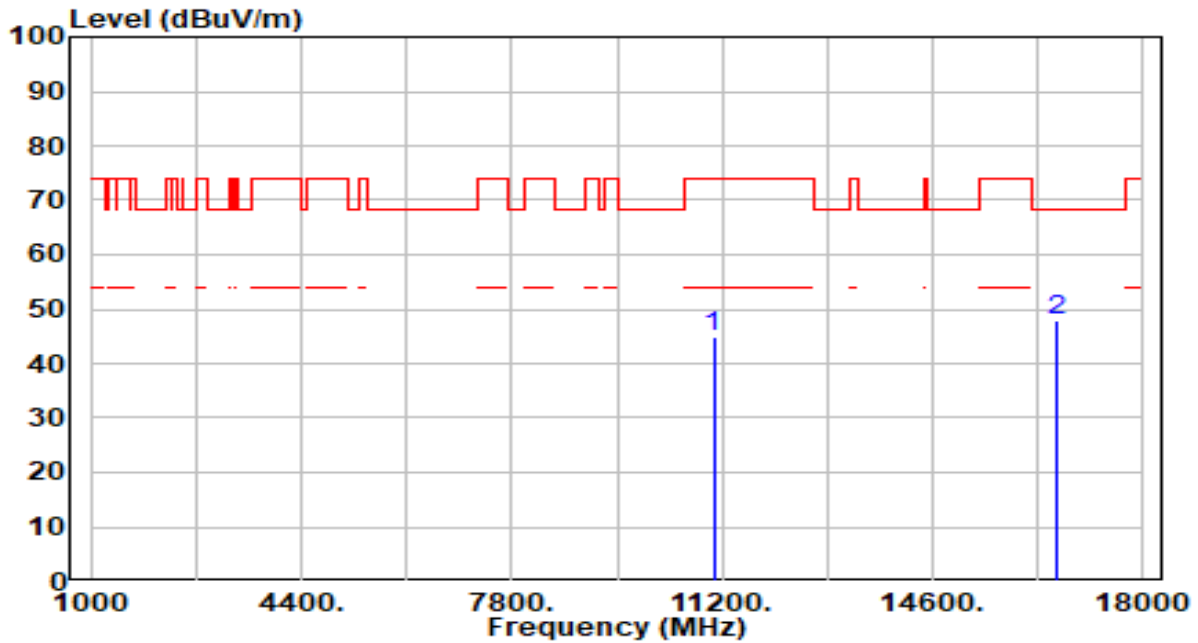

No	Frequency (MHz)	Reading (dBuV)	C.F (dB/m)	Measurement (dBuV/m)	Margin (dB)	Limit (dBuV/m)	Height (cm)	Angle (deg)	Remark (QP/PK/AV)
1	11060.000	42.03	2.78	44.81	-29.19	74.00	300	183	Peak
2	* 16590.000	43.45	4.62	48.07	-20.13	68.20	300	20	Peak

Note:

1. " *", means this data is the worst emission level.
2. C.F (Correction Factor) = Antenna Factor (dB/m)+ Cable Loss (dB) – Preamplifier(dB).
3. Measurement (dBuV/m) = Reading(dBuV) + C.F (Correction Factor).
4. The emission levels of other frequencies are very lower than the limit and not show in test report.

EUT	AX1800 Indoor/Outdoor Wi-Fi Access Point	Date of Test	2023-09-22
Factor	DRH18-E	Temp. / Humidity	20°C /60%
Polarity	Vertical	Site / Test Engineer	AC2 / Stanley
Test Mode	802.11ax-80MHz_TX_Band3_CH 106_ANT 0+1	Test Voltage	AC 120V/60Hz

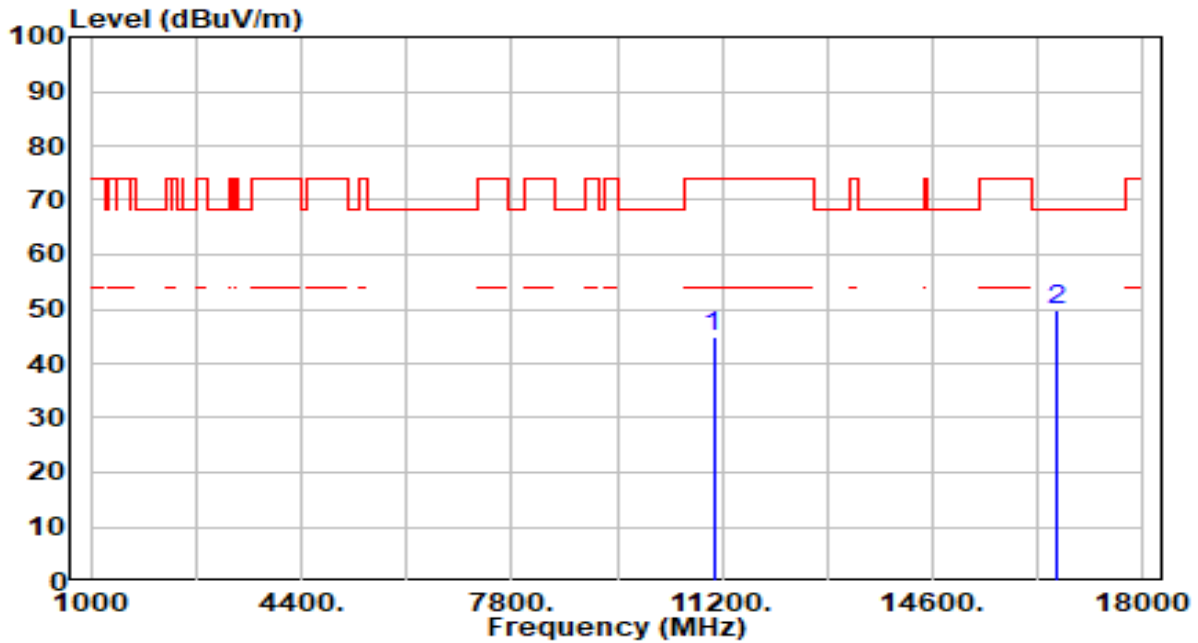

No	Frequency (MHz)	Reading (dBuV)	C.F (dB/m)	Measurement (dBuV/m)	Margin (dB)	Limit (dBuV/m)	Height (cm)	Angle (deg)	Remark (QP/PK/AV)
1	11060.000	42.14	2.78	44.92	-29.08	74.00	300	212	Peak
2	* 16590.000	45.05	4.62	49.66	-18.54	68.20	300	83	Peak

Note:

- "*", means this data is the worst emission level.
- C.F (Correction Factor) = Antenna Factor (dB/m)+ Cable Loss (dB) – Pre-amplifier(dB).
- Measurement (dBuV/m) = Reading(dBuV) + C.F (Correction Factor).
- The emission levels of other frequencies are very lower than the limit and not show in test report.

EUT	AX1800 Indoor/Outdoor Wi-Fi Access Point	Date of Test	2023-09-22
Factor	DRH18-E	Temp. / Humidity	20°C /60%
Polarity	Horizontal	Site / Test Engineer	AC2 / Stanley
Test Mode	802.11ax-80MHz_TX_Band3_CH 122_ANT 0+1	Test Voltage	AC 120V/60Hz

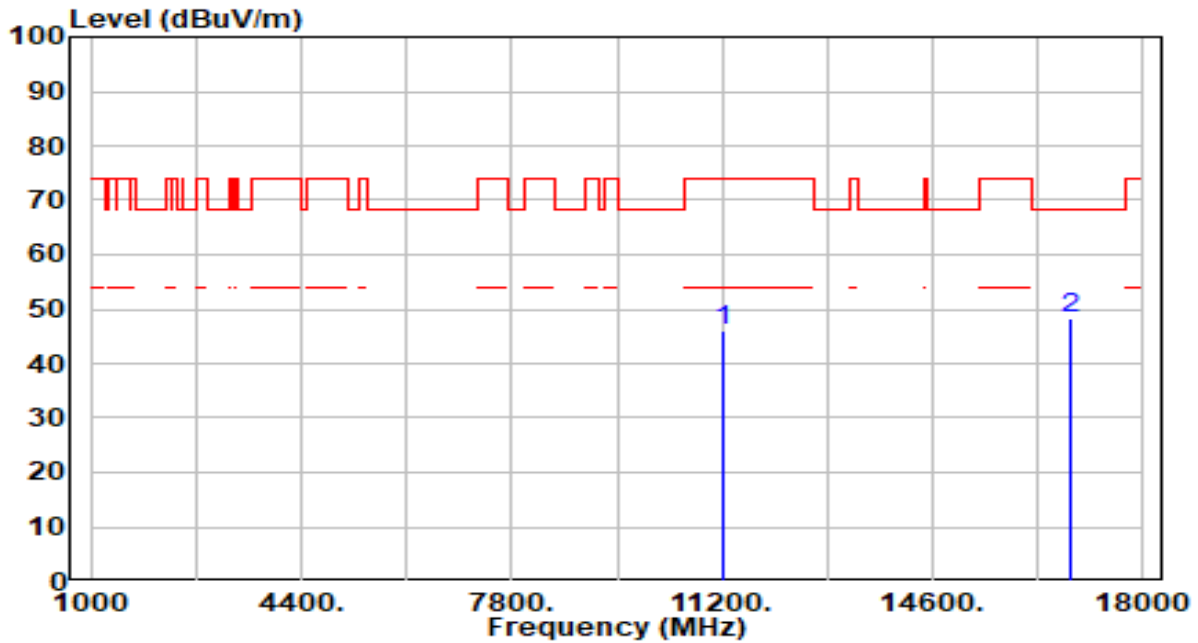

No	Frequency (MHz)	Reading (dBuV)	C.F (dB/m)	Measurement (dBuV/m)	Margin (dB)	Limit (dBuV/m)	Height (cm)	Angle (deg)	Remark (QP/PK/AV)
1	11220.000	42.75	3.22	45.97	-28.03	74.00	300	246	Peak
2	* 16830.000	43.71	4.61	48.33	-19.87	68.20	300	143	Peak

Note:

- "*", means this data is the worst emission level.
- C.F (Correction Factor) = Antenna Factor (dB/m)+ Cable Loss (dB) – Pre-amplifier(dB).
- Measurement (dBuV/m) = Reading(dBuV) + C.F (Correction Factor).
- The emission levels of other frequencies are very lower than the limit and not show in test report.

EUT	AX1800 Indoor/Outdoor Wi-Fi Access Point	Date of Test	2023-09-22
Factor	DRH18-E	Temp. / Humidity	20°C /60%
Polarity	Vertical	Site / Test Engineer	AC2 / Stanley
Test Mode	802.11ax-80MHz_TX_Band3_CH 122_ANT 0+1	Test Voltage	AC 120V/60Hz

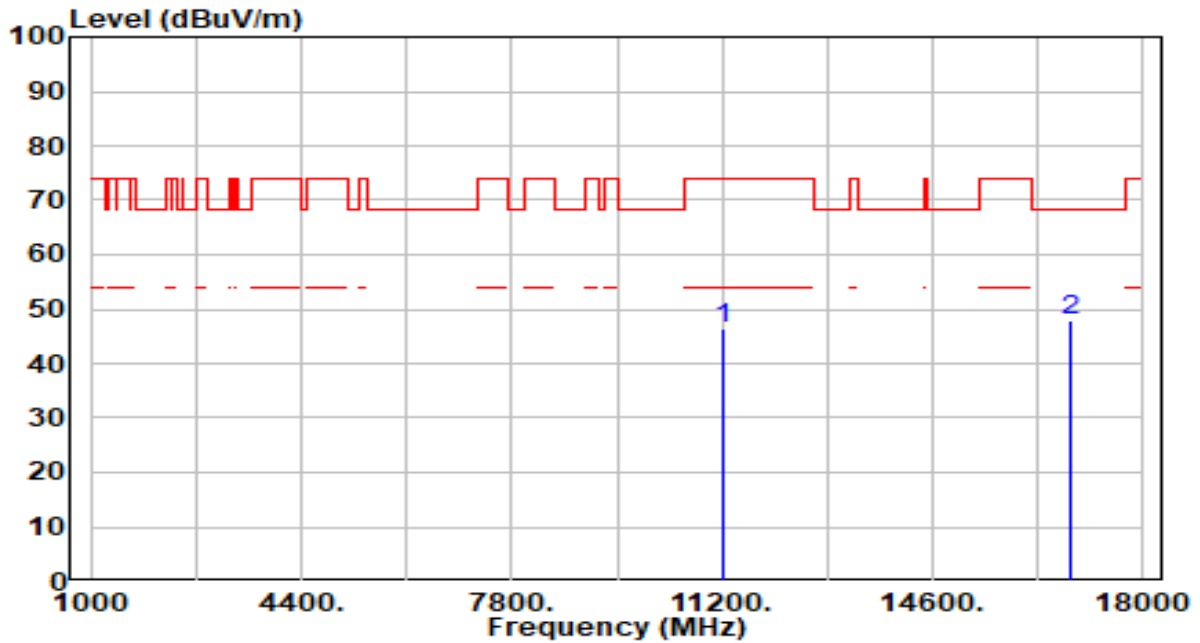

No	Frequency (MHz)	Reading (dBuV)	C.F (dB/m)	Measurement (dBuV/m)	Margin (dB)	Limit (dBuV/m)	Height (cm)	Angle (deg)	Remark (QP/PK/AV)
1	11220.000	43.29	3.22	46.51	-27.49	74.00	300	326	Peak
2	* 16830.000	43.41	4.61	48.02	-20.18	68.20	300	53	Peak

Note:

1. " *", means this data is the worst emission level.
2. C.F (Correction Factor) = Antenna Factor (dB/m)+ Cable Loss (dB) – Pre-amplifier(dB).
3. Measurement (dBuV/m) = Reading(dBuV) + C.F (Correction Factor).
4. The emission levels of other frequencies are very lower than the limit and not show in test report.

EUT	AX1800 Indoor/Outdoor Wi-Fi Access Point	Date of Test	2023-09-22
Factor	DRH18-E	Temp. / Humidity	20°C /60%
Polarity	Horizontal	Site / Test Engineer	AC2 / Stanley
Test Mode	802.11ax-80MHz_TX_Band3_CH 138_ANT 0+1	Test Voltage	AC 120V/60Hz

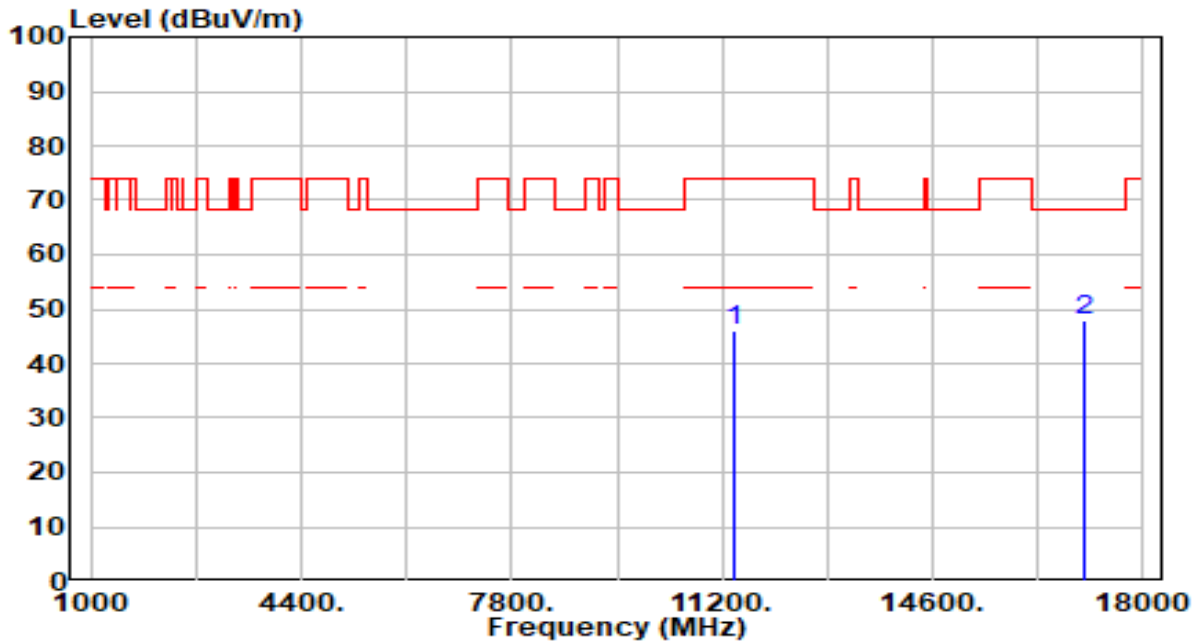

No	Frequency (MHz)	Reading (dBuV)	C.F (dB/m)	Measurement (dBuV/m)	Margin (dB)	Limit (dBuV/m)	Height (cm)	Angle (deg)	Remark (QP/PK/AV)
1	11380.000	42.72	3.45	46.17	-27.83	74.00	300	319	Peak
2	* 17070.000	42.93	4.86	47.79	-20.41	68.20	300	34	Peak

Note:

1. " *", means this data is the worst emission level.
2. C.F (Correction Factor) = Antenna Factor (dB/m)+ Cable Loss (dB) – Pre-amplifier(dB).
3. Measurement (dBuV/m) = Reading(dBuV) + C.F (Correction Factor).
4. The emission levels of other frequencies are very lower than the limit and not show in test report.

EUT	AX1800 Indoor/Outdoor Wi-Fi Access Point	Date of Test	2023-09-22
Factor	DRH18-E	Temp. / Humidity	20°C /60%
Polarity	Vertical	Site / Test Engineer	AC2 / Stanley
Test Mode	802.11ax-80MHz_TX_Band3_CH 138_ANT 0+1	Test Voltage	AC 120V/60Hz

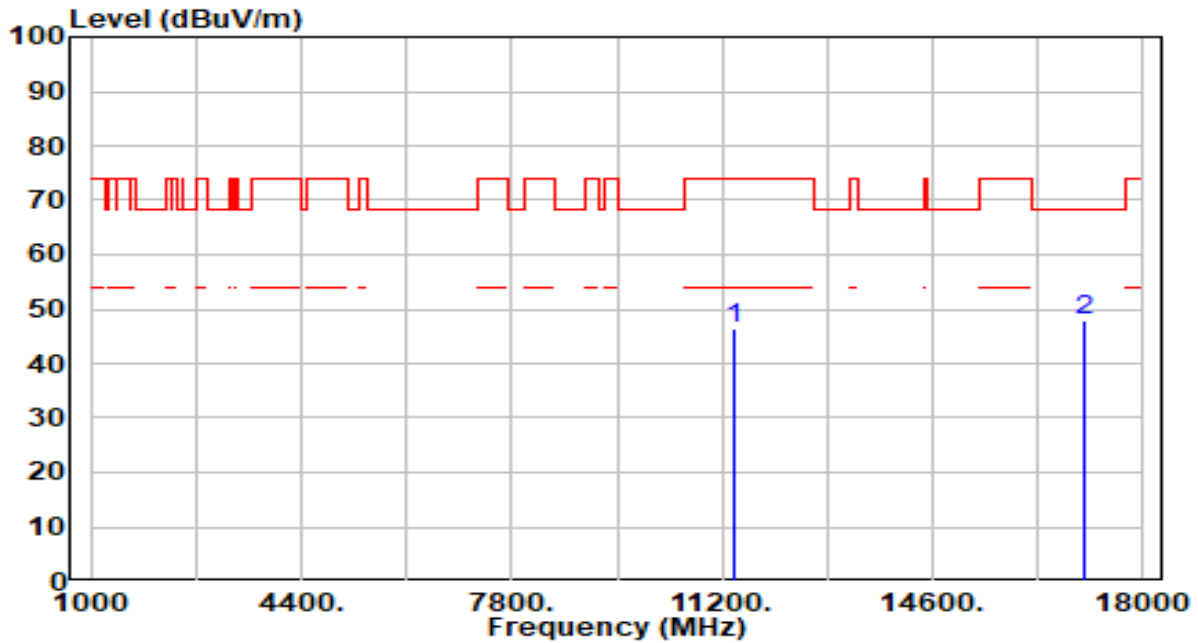

No	Frequency (MHz)	Reading (dBuV)	C.F (dB/m)	Measurement (dBuV/m)	Margin (dB)	Limit (dBuV/m)	Height (cm)	Angle (deg)	Remark (QP/PK/AV)
1	11380.000	43.13	3.45	46.58	-27.42	74.00	300	360	Peak
2	* 17070.000	43.10	4.86	47.96	-20.24	68.20	300	168	Peak

Note:

1. " *", means this data is the worst emission level.
2. C.F (Correction Factor) = Antenna Factor (dB/m)+ Cable Loss (dB) – Pre-amplifier(dB).
3. Measurement (dBuV/m) = Reading(dBuV) + C.F (Correction Factor).
4. The emission levels of other frequencies are very lower than the limit and not show in test report.

EUT	AX1800 Indoor/Outdoor Wi-Fi Access Point	Date of Test	2023-09-22
Factor	DRH18-E	Temp. / Humidity	20°C /60%
Polarity	Horizontal	Site / Test Engineer	AC2 / Stanley
Test Mode	802.11ax-80MHz_TX_Band4_CH 155_ANT 0+1	Test Voltage	AC 120V/60Hz

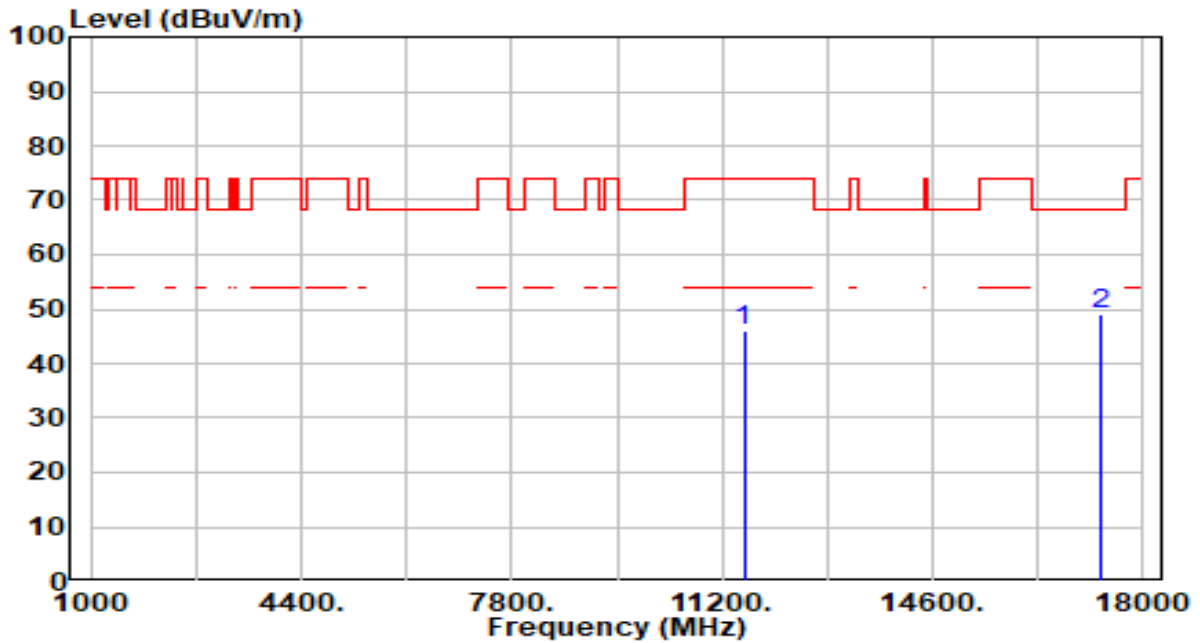

No	Frequency (MHz)	Reading (dBuV)	C.F (dB/m)	Measurement (dBuV/m)	Margin (dB)	Limit (dBuV/m)	Height (cm)	Angle (deg)	Remark (QP/PK/AV)
1	11550.000	42.41	3.63	46.03	-27.97	74.00	300	322	Peak
2	* 17325.000	45.03	4.16	49.19	-19.01	68.20	300	279	Peak

Note:

1. " *", means this data is the worst emission level.
2. C.F (Correction Factor) = Antenna Factor (dB/m)+ Cable Loss (dB) – Pre-amplifier(dB).
3. Measurement (dBuV/m) = Reading(dBuV) + C.F (Correction Factor).
4. The emission levels of other frequencies are very lower than the limit and not show in test report.

EUT	AX1800 Indoor/Outdoor Wi-Fi Access Point	Date of Test	2023-09-22
Factor	DRH18-E	Temp. / Humidity	20°C /60%
Polarity	Vertical	Site / Test Engineer	AC2 / Stanley
Test Mode	802.11ax-80MHz_TX_Band4_CH 155_ANT 0+1	Test Voltage	AC 120V/60Hz

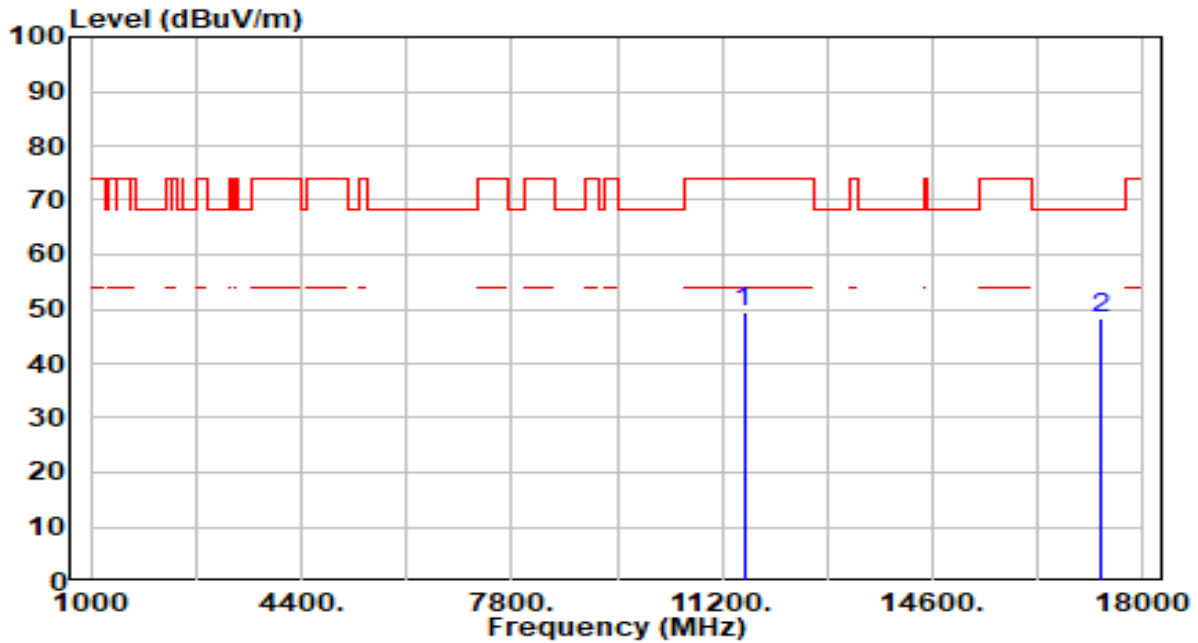

No	Frequency (MHz)	Reading (dBUV)	C.F (dB/m)	Measurement (dBUV/m)	Margin (dB)	Limit (dBUV/m)	Height (cm)	Angle (deg)	Remark (QP/PK/AV)
1	11550.000	45.63	3.63	49.26	-24.74	74.00	300	0	Peak
2	* 17325.000	44.14	4.16	48.30	-19.90	68.20	300	70	Peak

Note:

1. " *", means this data is the worst emission level.
2. C.F (Correction Factor) = Antenna Factor (dB/m)+ Cable Loss (dB) – Pre-amplifier(dB).
3. Measurement (dBUV/m) = Reading(dBUV) + C.F (Correction Factor).
4. The emission levels of other frequencies are very lower than the limit and not show in test report.

EUT	AX1800 Indoor/Outdoor Wi-Fi Access Point	Date of Test	2023-09-05
Factor	BBHA 9170	Temp. / Humidity	20°C /60%
Polarity	Horizontal	Site / Test Engineer	AC2 / Marvin
Test Mode	802.11ac-20MHz_TX_Band1_CH 44_ANT 0+1	Test Voltage	AC 120V/60Hz

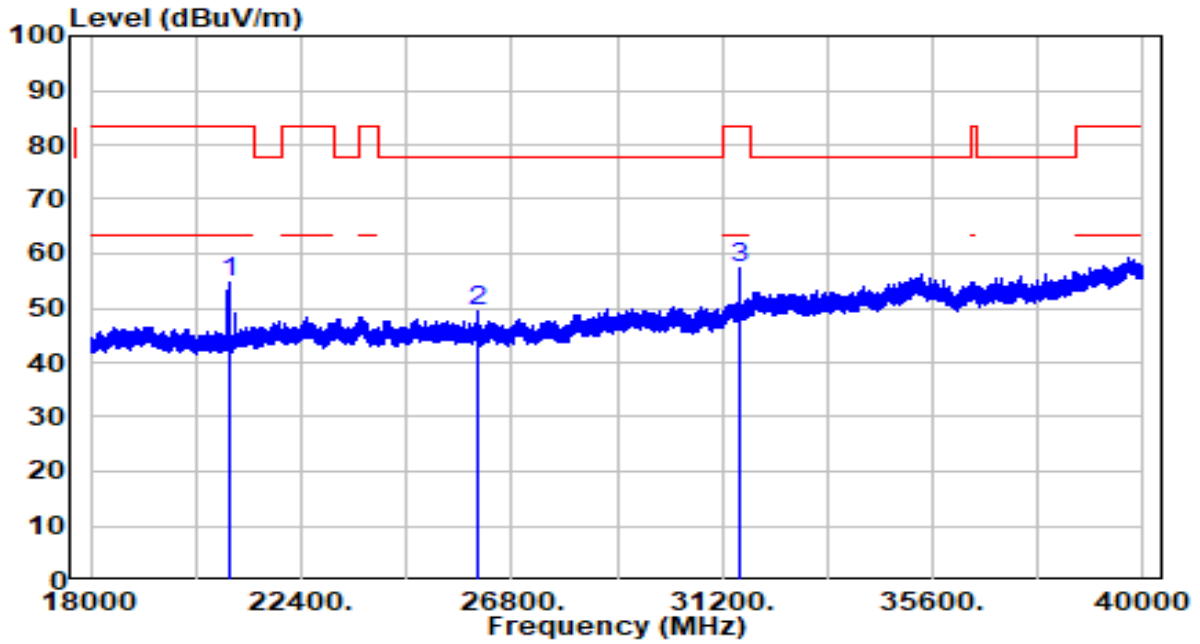

No	Frequency (MHz)	Reading (dBuV)	C.F (dB/m)	Measurement (dBuV/m)	Margin (dB)	Limit (dBuV/m)	Height (cm)	Angle (deg)	Remark (QP/PK/AV)
1	20880.000	43.79	10.84	54.63	-28.87	83.50	150	360	Peak
2	* 26100.000	36.22	13.28	49.50	-28.20	77.70	150	360	Peak
3	* 31567.810	39.33	18.01	57.34	-26.16	83.50	150	360	Peak

Note:

1. " *", means this data is the worst emission level.
2. C.F (Correction Factor) = Antenna Factor (dB/m)+ Cable Loss (dB) – Preamplifier(dB).
3. Measurement (dBuV/m) = Reading(dBuV) + C.F (Correction Factor).
4. The emission levels of other frequencies are very lower than the limit and not show in test report.

EUT	AX1800 Indoor/Outdoor Wi-Fi Access Point	Date of Test	2023-09-05
Factor	BBHA 9170	Temp. / Humidity	20°C /60%
Polarity	Vertical	Site / Test Engineer	AC2 / Marvin
Test Mode	802.11ac-20MHz_TX_Band1_CH 44_ANT 0+1	Test Voltage	AC 120V/60Hz

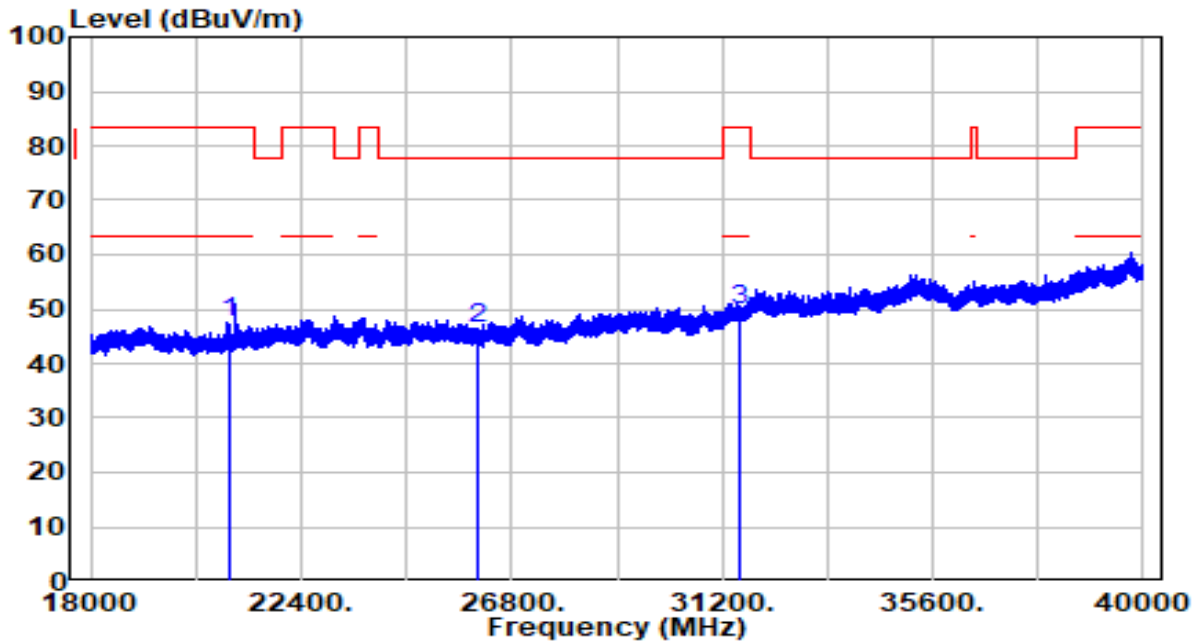

No	Frequency (MHz)	Reading (dBUV)	C.F (dB/m)	Measurement (dBUV/m)	Margin (dB)	Limit (dBUV/m)	Height (cm)	Angle (deg)	Remark (QP/PK/AV)
1	20880.000	36.85	10.84	47.69	-35.81	83.50	150	360	Peak
2	* 26100.000	32.95	13.28	46.23	-31.47	77.70	150	360	Peak
3	31567.810	31.95	18.01	49.96	-33.54	83.50	150	360	Peak

Note:

1. " *", means this data is the worst emission level.
2. C.F (Correction Factor) = Antenna Factor (dB/m)+ Cable Loss (dB) – Preamplifier(dB).
3. Measurement (dBUV/m) = Reading(dBUV) + C.F (Correction Factor).
4. The emission levels of other frequencies are very lower than the limit and not show in test report.

7.9. Radiated Restricted Band Edge Measurement

7.9.1. Test Limit

For 15.205 requirement:

Radiated emissions which fall in the restricted bands, as defined in Section 15.205(a) of FCC part 15, must also comply with the radiated emission limits specified in Section 15.209(a).

Frequency (MHz)	Frequency (MHz)	Frequency (MHz)	Frequency (GHz)
0.090 - 0.110	16.42-16.423	399.9 - 410	4.5-5.15
¹ 0.495 - 0.505	16.69475-16.69525	608 - 614	5.35-5.46
2.1735-2.1905	16.80425-16.80475	960 - 1240	7.25-7.75
4.125-4.128	25.5 -25.67	1300 - 1427	8.025 - 8.5
4.17725-4.17775	37.5-38.25	1435-1626.5	9.0-9.2
4.20725-4.20775	73-74.6	1645.5-1646.5	9.3-9.5
6.215-6.218	74.8-75.2	1660 - 1710	10.6-12.7
6.26775-6.26825	108-121.94	1718.8-1722.2	13.25-13.4
6.31175-6.31225	123 - 138	2200 - 2300	14.47-14.5
8.291-8.294	149.9-150.05	2310 - 2390	15.35-16.2
8.362-8.366	156.52475-156.525	2483.5 - 2500	17.7-21.4
8.37625-8.38675	156.7-156.9	2690 - 2900	22.01-23.12
8.41425-8.41475	162.0125-167.17	3260 - 3267	23.6-24.0
12.29-12.293	167.72-173.2	3332 - 3339	31.2-31.8
12.51975-12.52025	240 - 285	3345.8 - 3358	36.43-36.5
12.57675-12.57725	322-335.4	3600 - 4400	(²)
13.36-13.41	--	--	--

For 15.407(b) requirement:

For transmitters operating in the 5.15-5.25 GHz band: All emissions outside of the 5.15-5.35 GHz band shall not exceed an e.i.r.p. of -27 dBm/MHz.

For transmitters operating in the 5.25-5.35 GHz band: All emissions outside of the 5.15-5.35 GHz band shall not exceed an e.i.r.p. of -27 dBm/MHz.

For transmitters operating in the 5.47-5.725 GHz band: All emissions outside of the 5.47-5.725 GHz band shall not exceed an e.i.r.p. of -27 dBm/MHz.

For transmitters operating in the 5.725-5.85 GHz band: All emissions shall be limited to a level of -27 dBm/MHz at 75 MHz or more above or below the band edge increasing linearly to 10 dBm/MHz at 25 MHz above or below the band edge, and from 25 MHz above or below the band edge

increasing linearly to a level of 15.6 dBm/MHz at 5 MHz above or below the band edge, and from 5 MHz above or below the band edge increasing linearly to a level of 27 dBm/MHz at the band edge.

Refer to KDB 789033 D02v02r01 G)2)c), as specified in § 15.407(b), emissions above 1000 MHz that are outside of the restricted bands are subject to a maximum emission limit of -27 dBm/MHz (or -17 dBm/MHz as specified in § 15.407(b)(4)). However, an out-of-band emission that complies with both the peak and average limits of § 15.209 is not required to satisfy the -27 dBm/MHz or -17 dBm/MHz maximum emission limit.

All out of band emissions appearing in a restricted band as specified in Section 15.205 of the Title 47CFR must not exceed the limits shown in Table per Section 15.209.

FCC Part 15 Subpart C Paragraph 15.209		
Frequency [MHz]	Field Strength [uV/m]	Measured Distance [Meters]
0.009 - 0.490	2400/F (kHz)	300
0.490 - 1.705	24000/F (kHz)	30
1.705 - 30	30	30
30 - 88	100	3
88 - 216	150	3
216 - 960	200	3
Above 960	500	3

7.9.2. Test Procedure Used

KDB 789033 D02v02r01- Section G

7.9.3. Test Setting

Peak Measurements above 1GHz

1. Analyzer center frequency was set to the frequency of the radiated spurious emission of interest
2. RBW = 1MHz
3. VBW = 3MHz
4. Detector = peak
5. Sweep time = auto couple
6. Trace mode = max hold

7. Trace was allowed to stabilize

Average Measurements above 1GHz (Method VB)

1. Analyzer center frequency was set to the frequency of the radiated spurious emission of interest
2. RBW = 1MHz
3. VBW If the EUT is configured to transmit with duty cycle $\geq 98\%$, set $VBW \leq RBW/100$ (i.e., 10 kHz) but not less than 10 Hz. If the EUT duty cycle is $< 98\%$, set $VBW \geq 1/T$.
4. Detector = Peak
5. Sweep time = auto
6. Allow max hold to run for at least 50 traces if the transmitted signal is continuous or has at least 98% duty cycle. For lower duty cycles, increase the minimum number of traces by a factor of $1/x$, where x is the duty cycle.

7.9.4. Test Setup

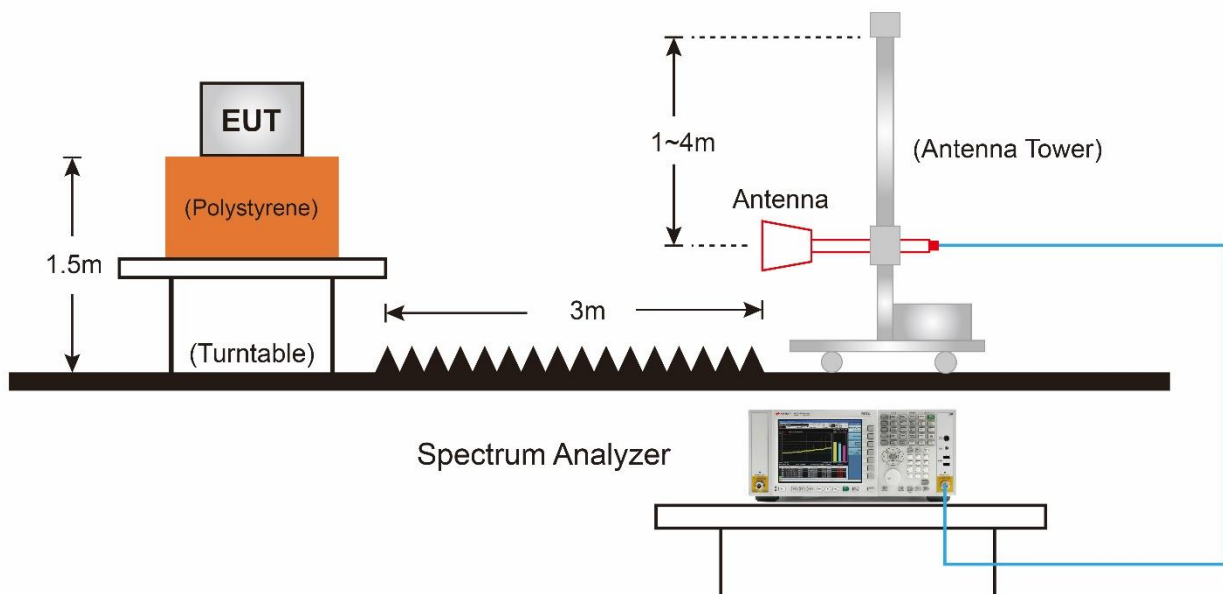

7.9.5. Test Result

EUT	AX1800 Indoor/Outdoor Wi-Fi 6 Access Point	Date of Test	2023-09-21
Factor	DRH18-E	Temp. / Humidity	20°C /60%
Polarity	Horizontal	Site / Test Engineer	AC2 / Stanley
Test Mode	802.11a_Band1_TX_CH 36_ANT 0+1	Test Voltage	AC120V/60Hz

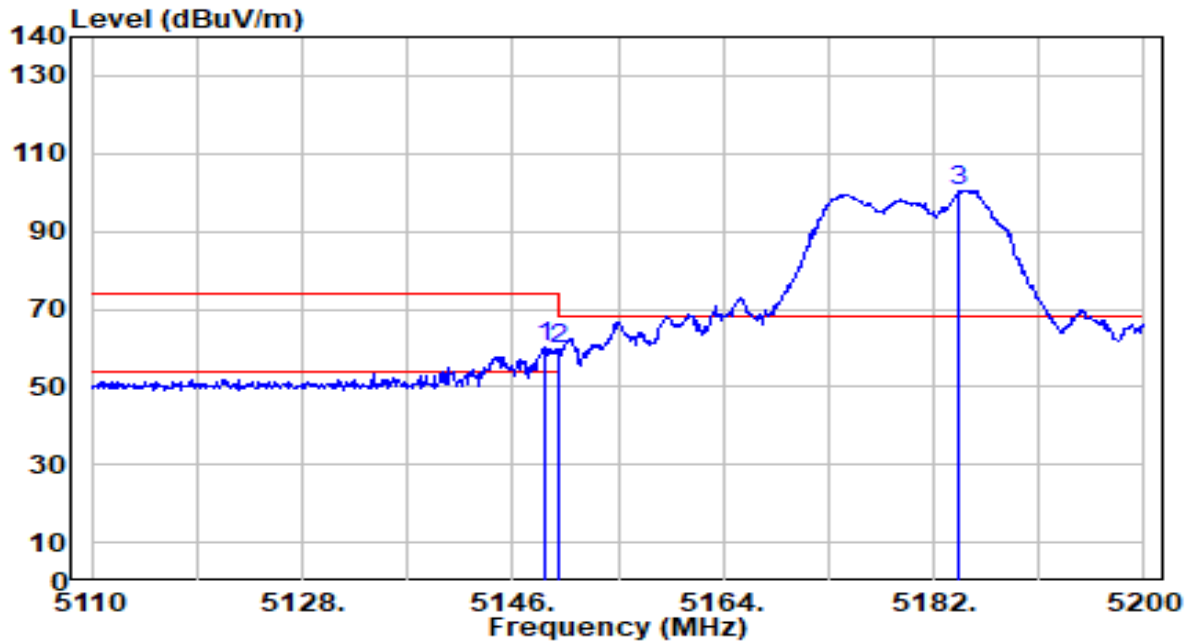

No	Frequency (MHz)	Reading (dBUV)	C.F (dB/m)	Measurement (dBUV/m)	Margin (dB)	Limit (dBUV/m)	Height (cm)	Angle (deg)	Remark (QP/PK/AV)
1	* 5148.700	60.89	-0.72	60.17	-13.83	74.00	104	355	Peak
2	5150.000	60.62	-0.72	59.90	-14.10	74.00	104	355	Peak
3	5184.160	101.30	-0.74	100.56	N/A	N/A	104	355	Peak

Note:

1. " *", means this data is the worst emission level.
2. C.F (Correction Factor) = Antenna Factor (dB/m)+ Cable Loss (dB) – Preamplifier(dB) + 10dB Attenuation.
3. Measurement (dBUV/m) = Reading(dBUV) + C.F (Correction Factor).
4. The emission levels of other frequencies are very lower than the limit and not show in test report.

EUT	AX1800 Indoor/Outdoor Wi-Fi 6 Access Point	Date of Test	2023-09-21
Factor	DRH18-E	Temp. / Humidity	20°C /60%
Polarity	Horizontal	Site / Test Engineer	AC2 / Stanley
Test Mode	802.11a_Band1_TX_CH 36_ANT 0+1	Test Voltage	AC120V/60Hz

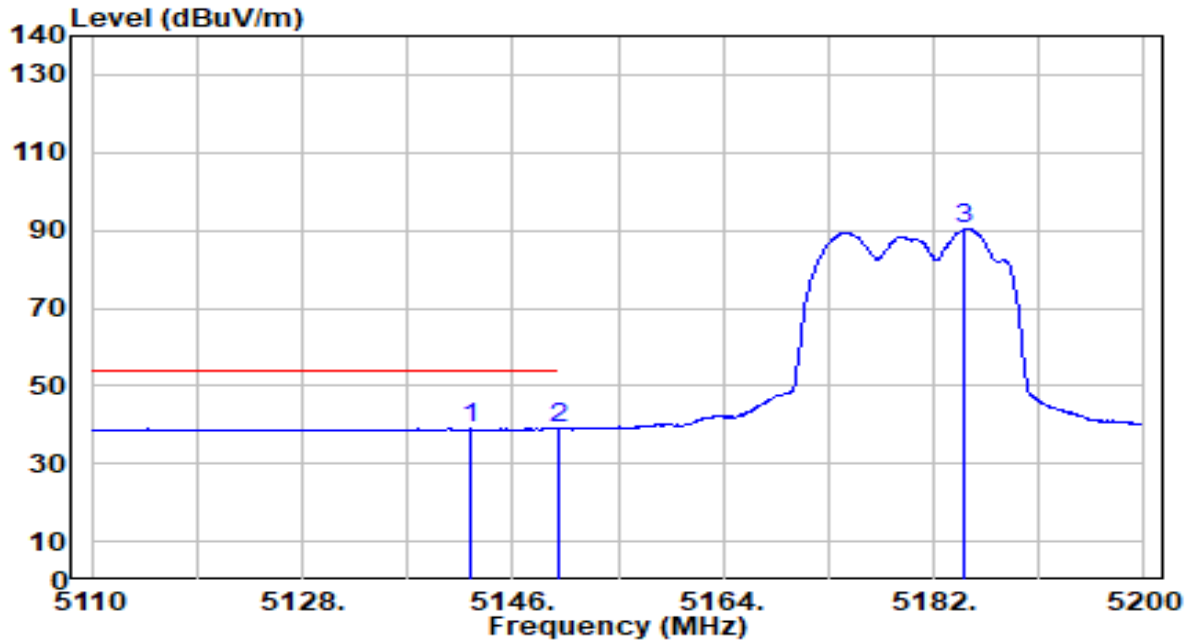

No	Frequency (MHz)	Reading (dBUV)	C.F (dB/m)	Measurement (dBUV/m)	Margin (dB)	Limit (dBUV/m)	Height (cm)	Angle (deg)	Remark (QP/PK/AV)
1	* 5142.490	39.74	-0.71	39.03	-14.97	54.00	104	355	Average
2	5150.000	39.74	-0.72	39.02	-14.98	54.00	104	355	Average
3	5184.610	90.93	-0.74	90.19	N/A	N/A	104	355	Average

Note:

1. " *", means this data is the worst emission level.
2. C.F (Correction Factor) = Antenna Factor (dB/m)+ Cable Loss (dB) – Preamplifier(dB) + 10dB Attenuation.
3. Measurement (dBUV/m) = Reading(dBUV) + C.F (Correction Factor).
4. The emission levels of other frequencies are very lower than the limit and not show in test report.

EUT	AX1800 Indoor/Outdoor Wi-Fi 6 Access Point	Date of Test	2023-09-21
Factor	DRH18-E	Temp. / Humidity	20°C /60%
Polarity	Vertical	Site / Test Engineer	AC2 / Stanley
Test Mode	802.11a_Band1_TX_CH 36_ANT 0+1	Test Voltage	AC120V/60Hz

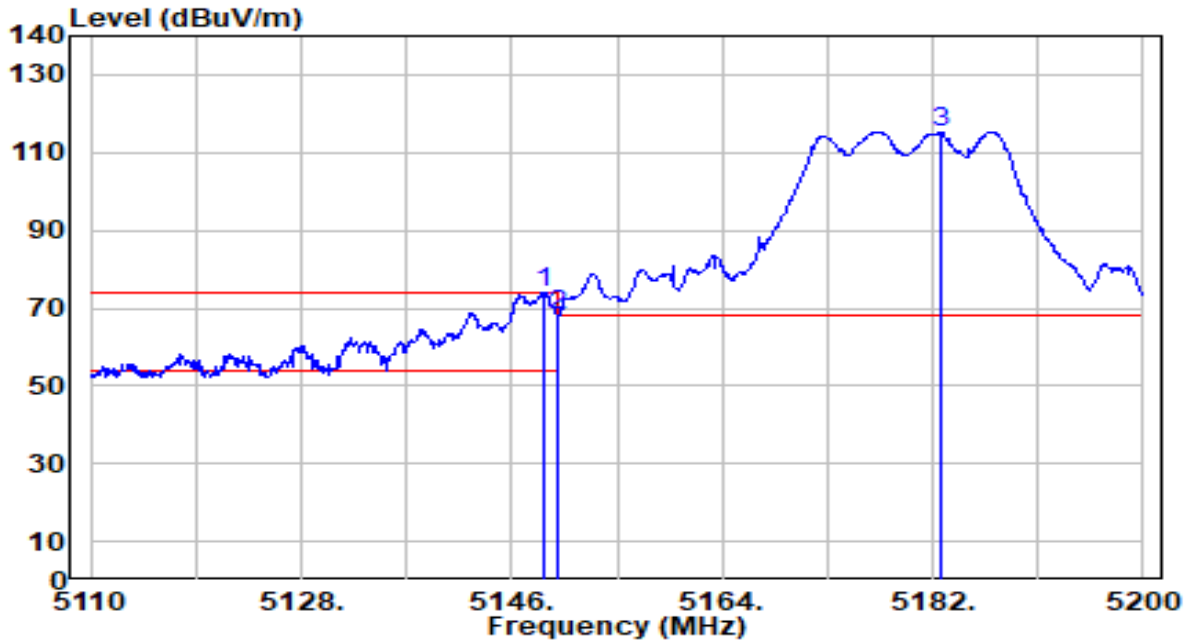

No	Frequency (MHz)	Reading (dBUV)	C.F (dB/m)	Measurement (dBUV/m)	Margin (dB)	Limit (dBUV/m)	Height (cm)	Angle (deg)	Remark (QP/PK/AV)
1	* 5148.700	74.50	-0.72	73.78	-0.22	74.00	175	43	Peak
2	5150.000	69.01	-0.72	68.30	-5.70	74.00	175	43	Peak
3	5182.720	116.05	-0.74	115.31	N/A	N/A	175	43	Peak

Note:

1. " *", means this data is the worst emission level.
2. C.F (Correction Factor) = Antenna Factor (dB/m)+ Cable Loss (dB) – Preamplifier(dB) + 10dB Attenuation.
3. Measurement (dBUV/m) = Reading(dBUV) + C.F (Correction Factor).
4. The emission levels of other frequencies are very lower than the limit and not show in test report.

EUT	AX1800 Indoor/Outdoor Wi-Fi 6 Access Point	Date of Test	2023-09-21
Factor	DRH18-E	Temp. / Humidity	20°C /60%
Polarity	Vertical	Site / Test Engineer	AC2 / Stanley
Test Mode	802.11a_Band1_TX_CH 36_ANT 0+1	Test Voltage	AC120V/60Hz

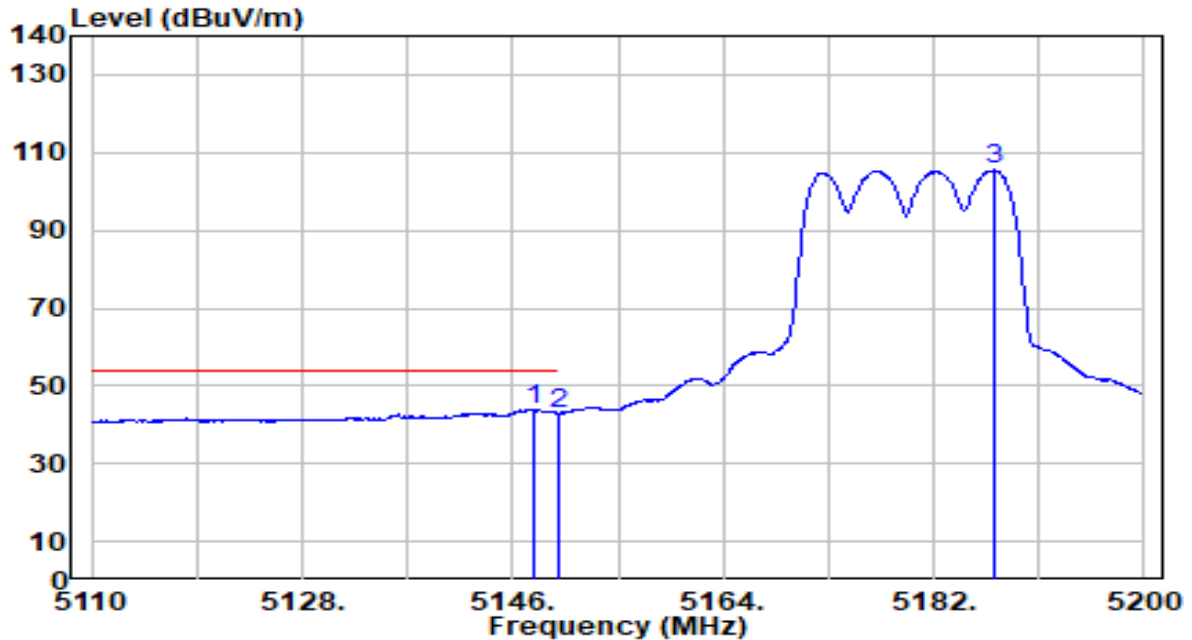

No	Frequency (MHz)	Reading (dBuV)	C.F (dB/m)	Measurement (dBuV/m)	Margin (dB)	Limit (dBuV/m)	Height (cm)	Angle (deg)	Remark (QP/PK/AV)
1	* 5147.800	44.42	-0.72	43.70	-10.30	54.00	175	43	Average
2	5150.000	43.66	-0.72	42.94	-11.06	54.00	175	43	Average
3	5187.130	106.15	-0.74	105.41	N/A	N/A	175	43	Average

Note:

1. " *", means this data is the worst emission level.
2. C.F (Correction Factor) = Antenna Factor (dB/m)+ Cable Loss (dB) – Preamplifier(dB) + 10dB Attenuation.
3. Measurement (dBuV/m) = Reading(dBuV) + C.F (Correction Factor).
4. The emission levels of other frequencies are very lower than the limit and not show in test report.

EUT	AX1800 Indoor/Outdoor Wi-Fi 6 Access Point	Date of Test	2023-09-21
Factor	DRH18-E	Temp. / Humidity	20°C /60%
Polarity	Horizontal	Site / Test Engineer	AC2 / Stanley
Test Mode	802.11a_Band2_TX_CH 64_ANT 0+1	Test Voltage	AC120V/60Hz

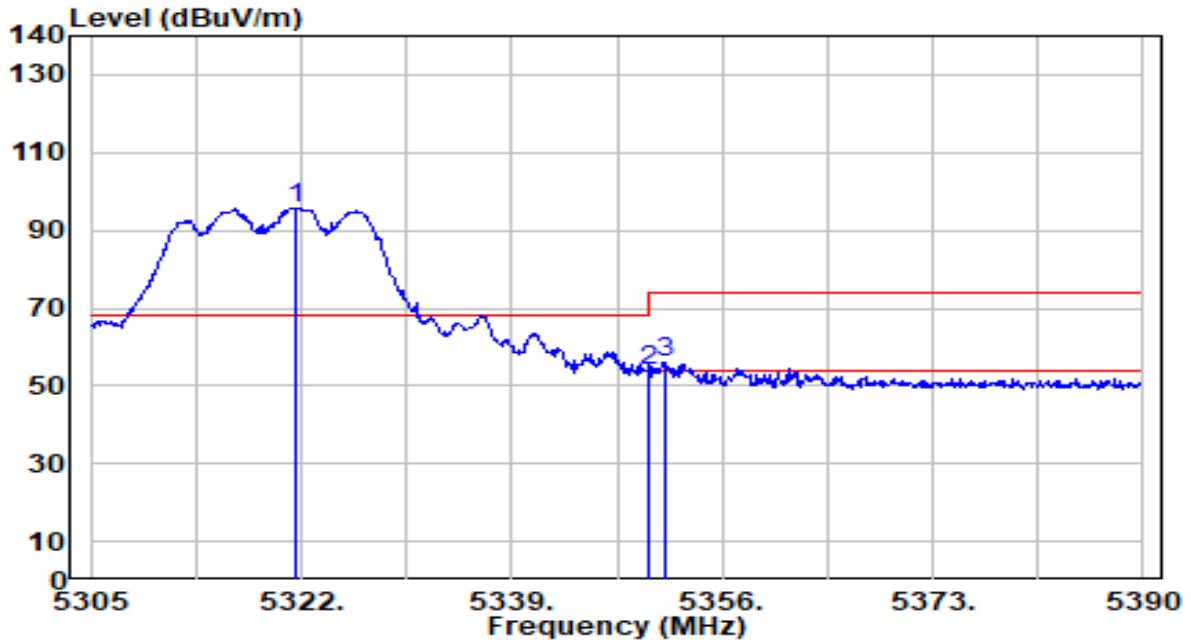

No	Frequency (MHz)	Reading (dBUV)	C.F (dB/m)	Measurement (dBUV/m)	Margin (dB)	Limit (dBUV/m)	Height (cm)	Angle (deg)	Remark (QP/PK/AV)
1	5321.490	96.74	-0.93	95.81	N/A	N/A	264	333	Peak
2	5350.000	54.95	-0.97	53.98	-20.02	74.00	264	333	Peak
3	* 5351.495	56.79	-0.97	55.82	-18.18	74.00	264	333	Peak

Note:

1. " *", means this data is the worst emission level.
2. C.F (Correction Factor) = Antenna Factor (dB/m)+ Cable Loss (dB) – Preamplifier(dB) + 10dB Attenuation.
3. Measurement (dBUV/m) = Reading(dBUV) + C.F (Correction Factor).
4. The emission levels of other frequencies are very lower than the limit and not show in test report.

EUT	AX1800 Indoor/Outdoor Wi-Fi 6 Access Point	Date of Test	2023-09-21
Factor	DRH18-E	Temp. / Humidity	20°C /60%
Polarity	Horizontal	Site / Test Engineer	AC2 / Stanley
Test Mode	802.11a_Band2_TX_CH 64_ANT 0+1	Test Voltage	AC120V/60Hz

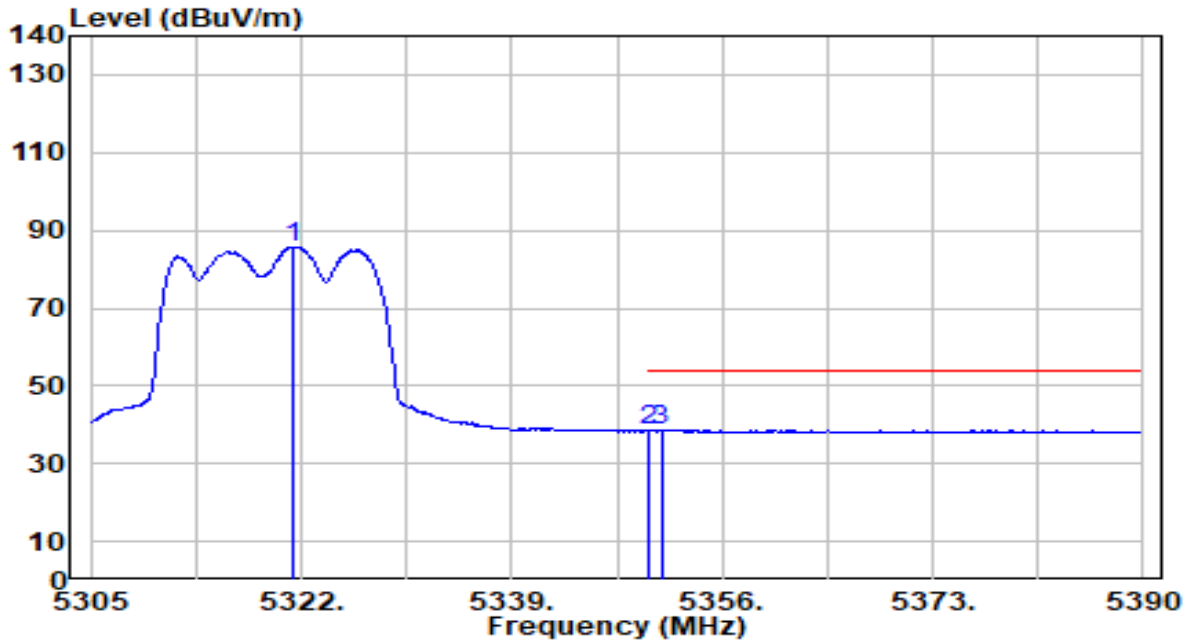

No	Frequency (MHz)	Reading (dBUV)	C.F (dB/m)	Measurement (dBUV/m)	Margin (dB)	Limit (dBUV/m)	Height (cm)	Angle (deg)	Remark (QP/PK/AV)
1	5321.405	86.75	-0.93	85.83	N/A	N/A	264	333	Average
2	5350.000	39.30	-0.97	38.33	-15.67	54.00	264	333	Average
3	* 5351.070	39.75	-0.97	38.77	-15.23	54.00	264	333	Average

Note:

1. " *", means this data is the worst emission level.
2. C.F (Correction Factor) = Antenna Factor (dB/m)+ Cable Loss (dB) – Preamplifier(dB) + 10dB Attenuation.
3. Measurement (dBUV/m) = Reading(dBUV) + C.F (Correction Factor).
4. The emission levels of other frequencies are very lower than the limit and not show in test report.

EUT	AX1800 Indoor/Outdoor Wi-Fi 6 Access Point	Date of Test	2023-09-21
Factor	DRH18-E	Temp. / Humidity	20°C /60%
Polarity	Vertical	Site / Test Engineer	AC2 / Stanley
Test Mode	802.11a_Band2_TX_CH 64_ANT 0+1	Test Voltage	AC120V/60Hz

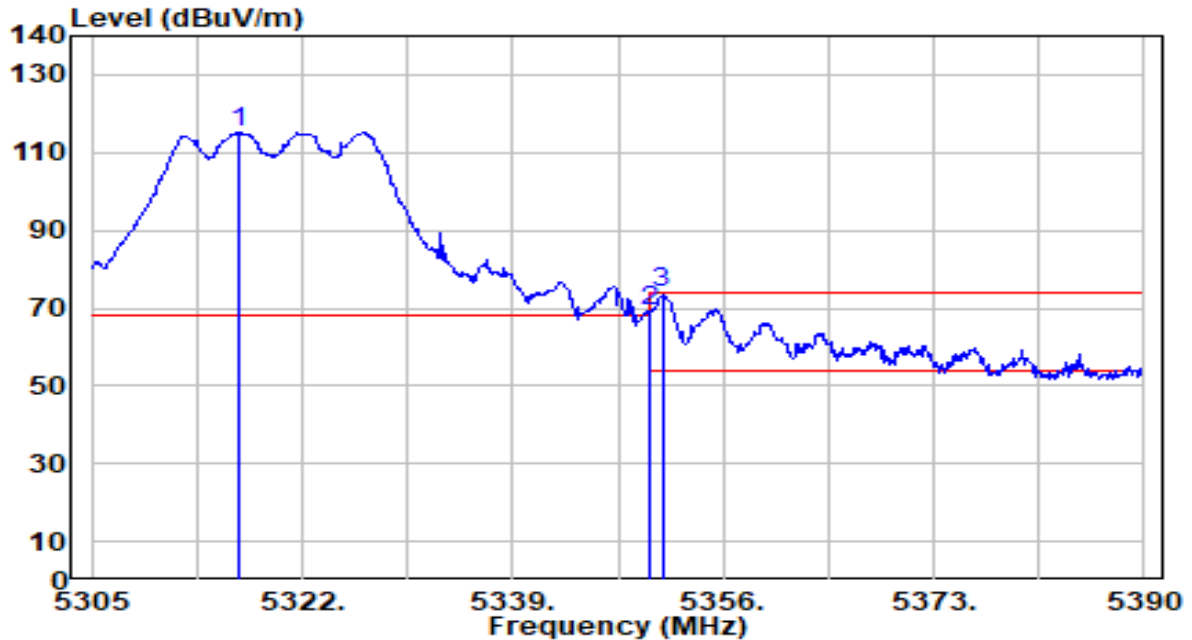

No	Frequency (MHz)	Reading (dBuV)	C.F (dB/m)	Measurement (dBuV/m)	Margin (dB)	Limit (dBuV/m)	Height (cm)	Angle (deg)	Remark (QP/PK/AV)
1	5316.900	115.96	-0.92	115.03	N/A	N/A	192	360	Peak
2	5350.000	70.03	-0.97	69.05	-4.95	74.00	192	360	Peak
3	* 5351.070	74.70	-0.97	73.73	-0.27	74.00	192	360	Peak

Note:

1. " *", means this data is the worst emission level.
2. C.F (Correction Factor) = Antenna Factor (dB/m)+ Cable Loss (dB) – Preamplifier(dB) + 10dB Attenuation.
3. Measurement (dBuV/m) = Reading(dBuV) + C.F (Correction Factor).
4. The emission levels of other frequencies are very lower than the limit and not show in test report.

EUT	AX1800 Indoor/Outdoor Wi-Fi 6 Access Point	Date of Test	2023-09-21
Factor	DRH18-E	Temp. / Humidity	20°C /60%
Polarity	Vertical	Site / Test Engineer	AC2 / Stanley
Test Mode	802.11a_Band2_TX_CH 64_ANT 0+1	Test Voltage	AC120V/60Hz

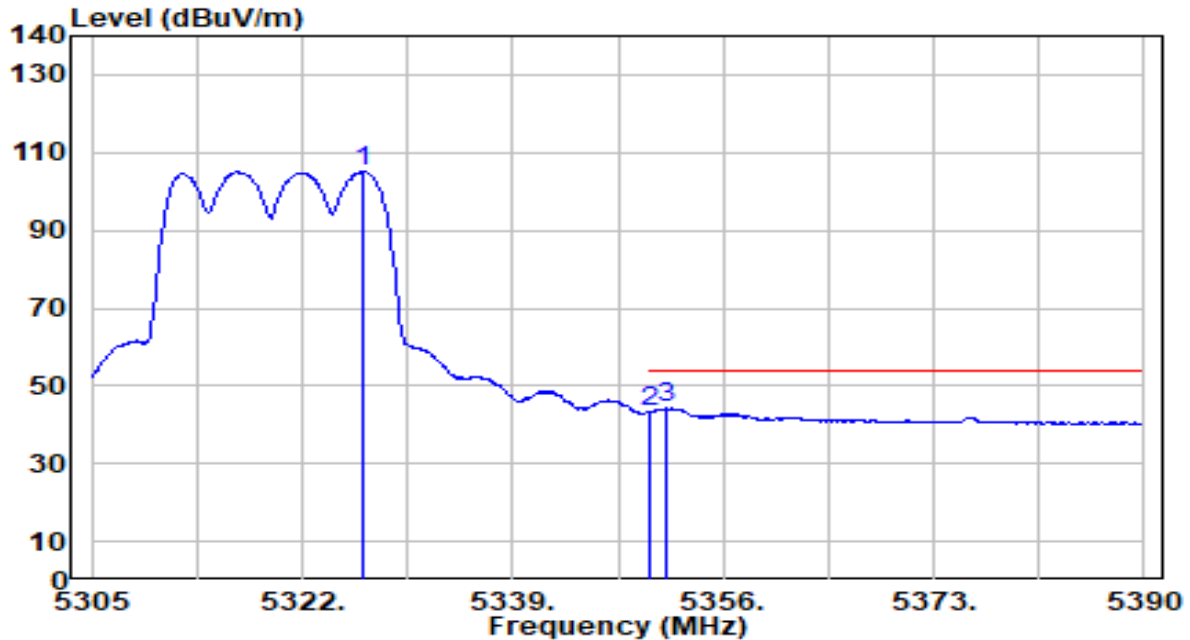

No	Frequency (MHz)	Reading (dBUV)	C.F (dB/m)	Measurement (dBUV/m)	Margin (dB)	Limit (dBUV/m)	Height (cm)	Angle (deg)	Remark (QP/PK/AV)
1	5326.845	105.99	-0.94	105.06	N/A	N/A	192	360	Average
2	5350.000	44.11	-0.97	43.14	-10.86	54.00	192	360	Average
3	* 5351.410	45.25	-0.97	44.28	-9.72	54.00	192	360	Average

Note:

1. " *", means this data is the worst emission level.
2. C.F (Correction Factor) = Antenna Factor (dB/m)+ Cable Loss (dB) – Preamplifier(dB) + 10dB Attenuation.
3. Measurement (dBUV/m) = Reading(dBUV) + C.F (Correction Factor).
4. The emission levels of other frequencies are very lower than the limit and not show in test report.

EUT	AX1800 Indoor/Outdoor Wi-Fi 6 Access Point	Date of Test	2023-09-21
Factor	DRH18-E	Temp. / Humidity	20°C /60%
Polarity	Horizontal	Site / Test Engineer	AC2 / Stanley
Test Mode	802.11a_Band3_TX_CH 100_ANT 0+1	Test Voltage	AC120V/60Hz

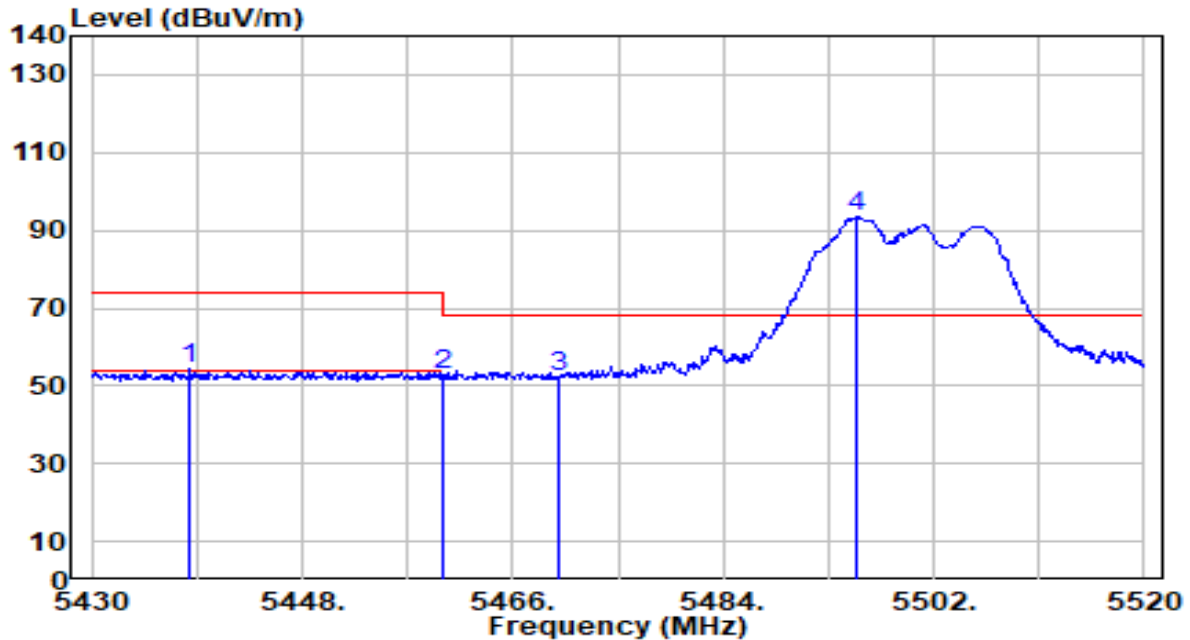

No	Frequency (MHz)	Reading (dBUV)	C.F (dB/m)	Measurement (dBUV/m)	Margin (dB)	Limit (dBUV/m)	Height (cm)	Angle (deg)	Remark (QP/PK/AV)
1	5438.370	55.15	-0.93	54.22	-19.78	74.00	238	331	Peak
2	5460.000	53.73	-0.87	52.87	-21.13	74.00	238	331	Peak
3	* 5470.000	53.12	-0.84	52.28	-15.92	68.20	238	331	Peak
4	5495.430	94.08	-0.76	93.32	N/A	N/A	238	331	Peak

Note:

1. " *", means this data is the worst emission level.
2. C.F (Correction Factor) = Antenna Factor (dB/m)+ Cable Loss (dB) – Preamplifier(dB) + 10dB Attenuation.
3. Measurement (dBUV/m) = Reading(dBUV) + C.F (Correction Factor).
4. The emission levels of other frequencies are very lower than the limit and not show in test report.

EUT	AX1800 Indoor/Outdoor 6 Wi-Fi Access Point	Date of Test	2023-09-21
Factor	DRH18-E	Temp. / Humidity	20°C /60%
Polarity	Horizontal	Site / Test Engineer	AC2 / Stanley
Test Mode	802.11a_Band3_TX_CH 100_ANT 0+1	Test Voltage	AC120V/60Hz

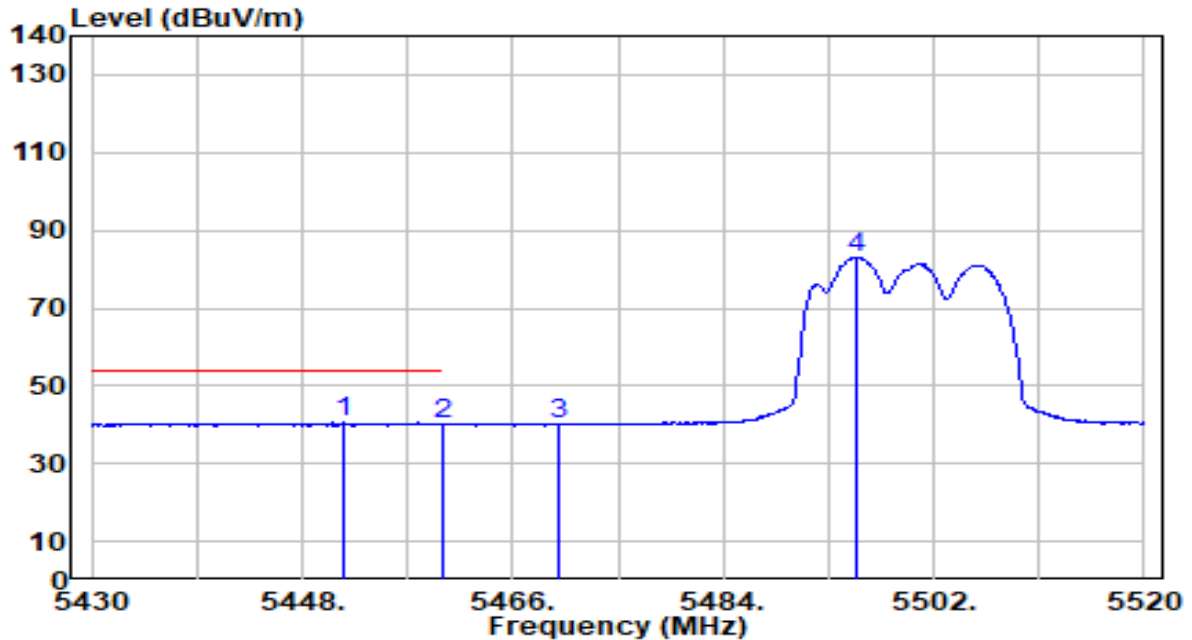

No	Frequency (MHz)	Reading (dBUV)	C.F (dB/m)	Measurement (dBUV/m)	Margin (dB)	Limit (dBUV/m)	Height (cm)	Angle (deg)	Remark (QP/PK/AV)
1	* 5451.510	41.40	-0.89	40.51	-13.49	54.00	238	331	Average
2	5460.000	41.08	-0.87	40.21	-13.79	54.00	238	331	Average
3	5470.000	40.99	-0.84	40.15	N/A	N/A	238	331	Average
4	5495.340	83.82	-0.76	83.06	N/A	N/A	238	331	Average

Note:

1. " *", means this data is the worst emission level.
2. C.F (Correction Factor) = Antenna Factor (dB/m)+ Cable Loss (dB) – Preamplifier(dB) + 10dB Attenuation.
3. Measurement (dBUV/m) = Reading(dBUV) + C.F (Correction Factor).
4. The emission levels of other frequencies are very lower than the limit and not show in test report.

EUT	AX1800 Indoor/Outdoor Wi-Fi 6 Access Point	Date of Test	2023-09-21
Factor	DRH18-E	Temp. / Humidity	20°C /60%
Polarity	Vertical	Site / Test Engineer	AC2 / Stanley
Test Mode	802.11a_Band3_TX_CH 100_ANT 0+1	Test Voltage	AC120V/60Hz

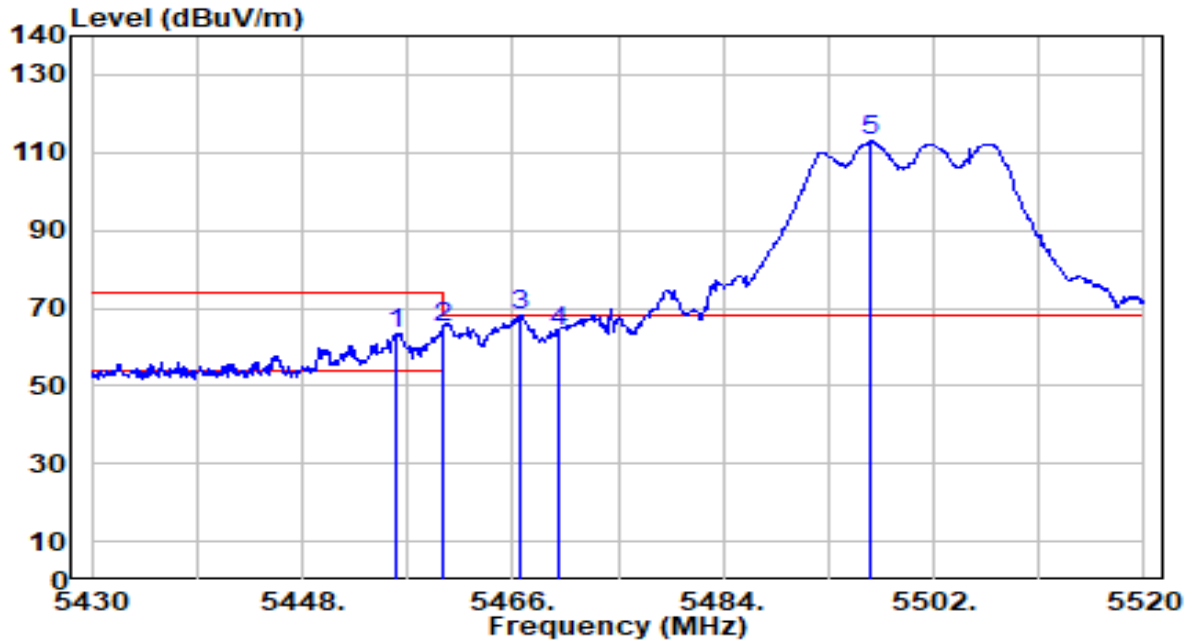

No	Frequency (MHz)	Reading (dBUV)	C.F (dB/m)	Measurement (dBUV/m)	Margin (dB)	Limit (dBUV/m)	Height (cm)	Angle (deg)	Remark (QP/PK/AV)
1	5456.010	64.52	-0.88	63.64	-10.36	74.00	199	331	Peak
2	5460.000	66.04	-0.87	65.17	-8.83	74.00	199	331	Peak
3	* 5466.540	68.94	-0.85	68.09	-0.11	68.20	199	331	Peak
4	5470.000	64.69	-0.84	63.85	-4.35	68.20	199	331	Peak
5	5496.690	113.82	-0.76	113.06	N/A	N/A	199	331	Peak

Note:

1. " *", means this data is the worst emission level.
2. C.F (Correction Factor) = Antenna Factor (dB/m)+ Cable Loss (dB) – Preamplifier(dB) + 10dB Attenuation.
3. Measurement (dBUV/m) = Reading(dBUV) + C.F (Correction Factor).
4. The emission levels of other frequencies are very lower than the limit and not show in test report.

EUT	AX1800 Indoor/Outdoor Wi-Fi 6 Access Point	Date of Test	2023-09-21
Factor	DRH18-E	Temp. / Humidity	20°C /60%
Polarity	Vertical	Site / Test Engineer	AC2 / Stanley
Test Mode	802.11a_Band3_TX_CH 100_ANT 0+1	Test Voltage	AC120V/60Hz

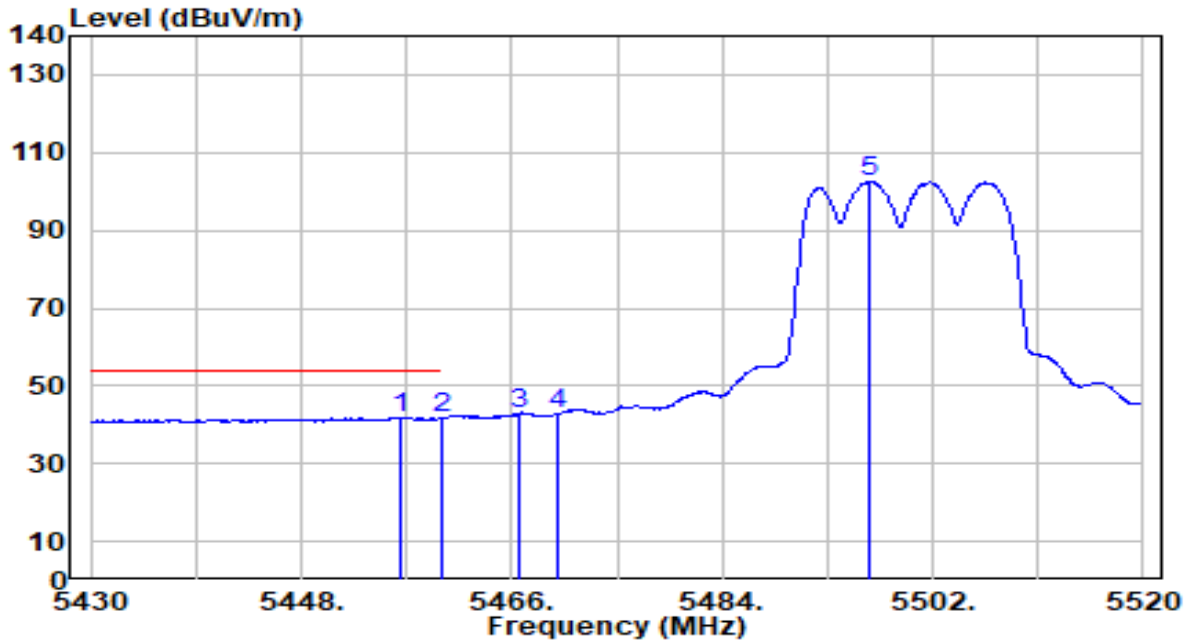

No	Frequency (MHz)	Reading (dBUV)	C.F (dB/m)	Measurement (dBUV/m)	Margin (dB)	Limit (dBUV/m)	Height (cm)	Angle (deg)	Remark (QP/PK/AV)
1	* 5456.460	42.75	-0.88	41.87	-12.13	54.00	199	331	Average
2	5460.000	42.57	-0.87	41.70	-12.30	54.00	199	331	Average
3	5466.540	43.49	-0.85	42.64	N/A	N/A	199	331	Average
4	5470.000	43.74	-0.84	42.90	N/A	N/A	199	331	Average
5	5496.690	103.32	-0.76	102.56	N/A	N/A	199	331	Average

Note:

1. " *", means this data is the worst emission level.
2. C.F (Correction Factor) = Antenna Factor (dB/m)+ Cable Loss (dB) – Preamplifier(dB) + 10dB Attenuation.
3. Measurement (dBUV/m) = Reading(dBUV) + C.F (Correction Factor).
4. The emission levels of other frequencies are very lower than the limit and not show in test report.

EUT	AX1800 Indoor/Outdoor Wi-Fi 6 Access Point	Date of Test	2023-09-21
Factor	DRH18-E	Temp. / Humidity	20°C /60%
Polarity	Horizontal	Site / Test Engineer	AC2 / Marvin
Test Mode	802.11a_Band3_TX_CH 140_ANT 0+1	Test Voltage	AC120V/60Hz

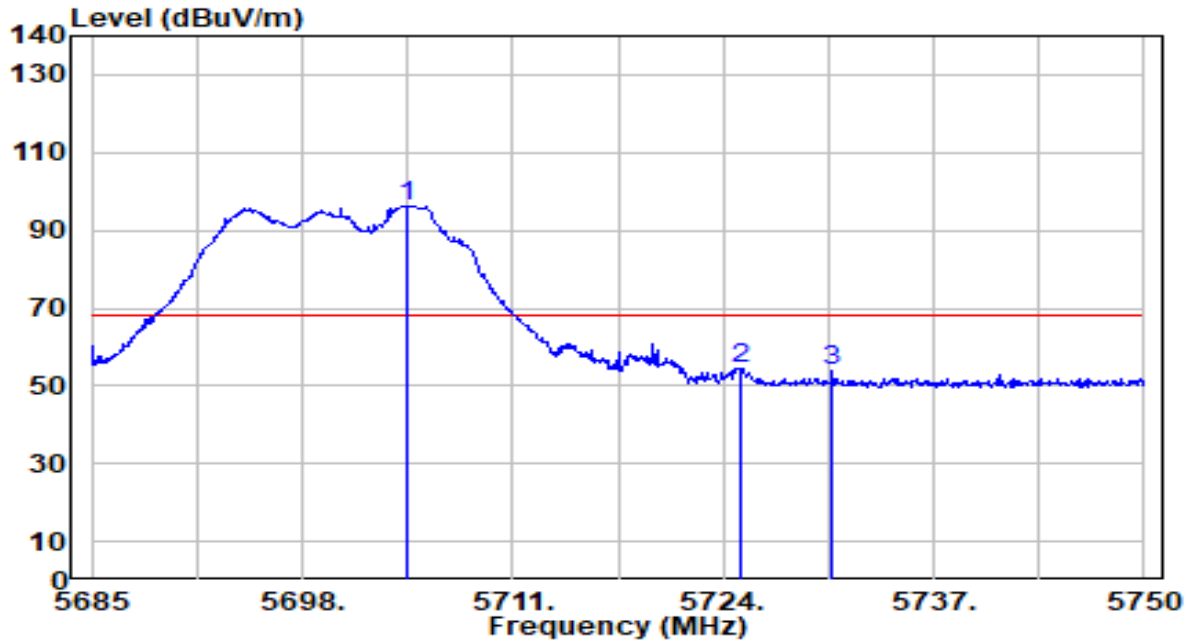

No	Frequency (MHz)	Reading (dBuV)	C.F (dB/m)	Measurement (dBuV/m)	Margin (dB)	Limit (dBuV/m)	Height (cm)	Angle (deg)	Remark (QP/PK/AV)
1	5704.500	96.29	0.12	96.41	N/A	N/A	100	21	Peak
2	* 5725.000	54.29	0.23	54.52	-13.68	68.20	100	21	Peak
3	5730.760	53.59	0.26	53.85	-14.35	68.20	100	21	Peak

Note:

1. " *", means this data is the worst emission level.
2. C.F (Correction Factor) = Antenna Factor (dB/m)+ Cable Loss (dB) – Preamplifier(dB) + 10dB Attenuation.
3. Measurement (dBuV/m) = Reading(dBuV) + C.F (Correction Factor).
4. The emission levels of other frequencies are very lower than the limit and not show in test report.

EUT	AX1800 Indoor/Outdoor Wi-Fi 6 Access Point	Date of Test	2023-09-21
Factor	DRH18-E	Temp. / Humidity	20°C /60%
Polarity	Vertical	Site / Test Engineer	AC2 / Marvin
Test Mode	802.11a_Band3_TX_CH 140_ANT 0+1	Test Voltage	AC120V/60Hz

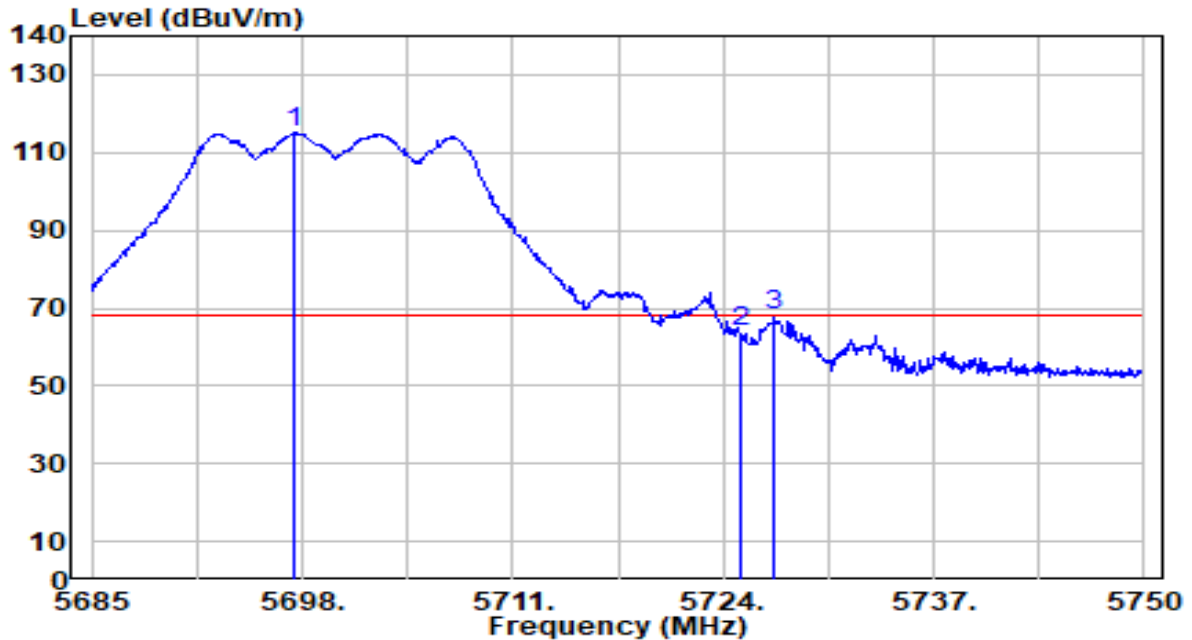

No	Frequency (MHz)	Reading (dBUV)	C.F (dB/m)	Measurement (dBUV/m)	Margin (dB)	Limit (dBUV/m)	Height (cm)	Angle (deg)	Remark (QP/PK/AV)
1	5697.415	115.33	0.08	115.41	N/A	N/A	200	238	Peak
2	5725.000	63.82	0.23	64.04	-4.16	68.20	200	238	Peak
3	* 5727.120	67.77	0.24	68.01	-0.19	68.20	200	238	Peak

Note:

1. " *", means this data is the worst emission level.
2. C.F (Correction Factor) = Antenna Factor (dB/m)+ Cable Loss (dB) – Preamplifier(dB) + 10dB Attenuation.
3. Measurement (dBUV/m) = Reading(dBUV) + C.F (Correction Factor).
4. The emission levels of other frequencies are very lower than the limit and not show in test report.

EUT	AX1800 Indoor/Outdoor Wi-Fi 6 Access Point	Date of Test	2023-09-21
Factor	DRH18-E	Temp. / Humidity	20°C /60%
Polarity	Horizontal	Site / Test Engineer	AC2 / Marvin
Test Mode	802.11a_Band4_TX_CH 149_ANT 0+1	Test Voltage	AC120V/60Hz

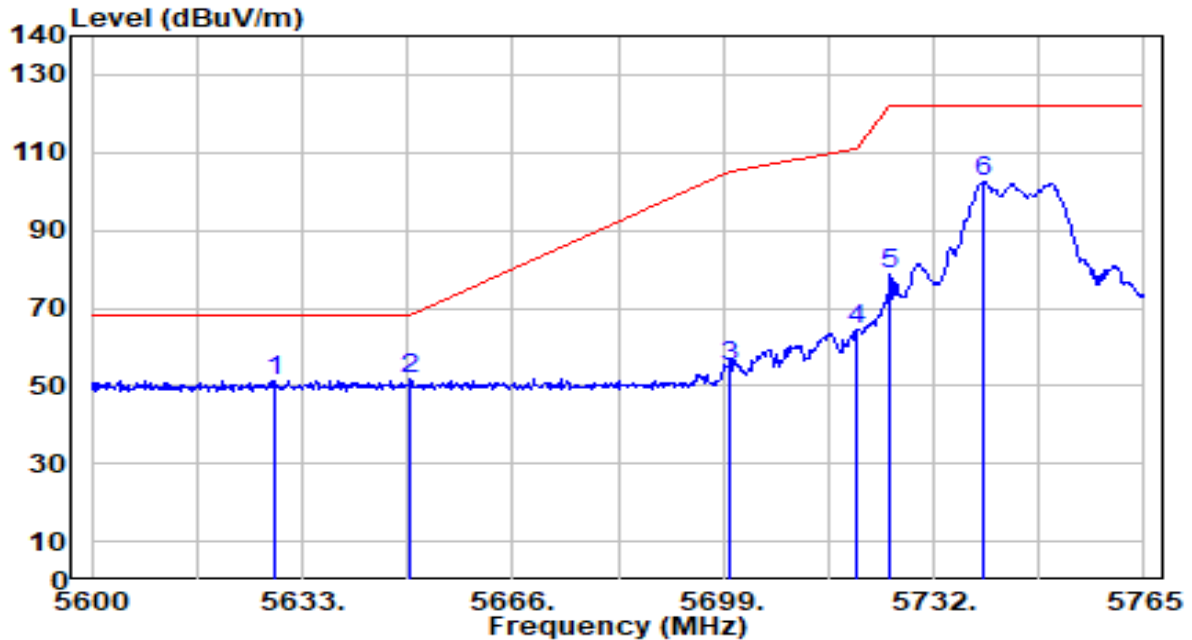

No	Frequency (MHz)	Reading (dBUV)	C.F (dB/m)	Measurement (dBUV/m)	Margin (dB)	Limit (dBUV/m)	Height (cm)	Angle (deg)	Remark (QP/PK/AV)
1	5628.545	51.71	-0.28	51.43	-16.77	68.20	100	19	Peak
2	* 5650.000	52.15	-0.16	51.99	-16.21	68.20	100	19	Peak
3	5700.000	54.84	0.10	54.94	-50.26	105.20	100	19	Peak
4	5720.000	64.27	0.20	64.47	-46.33	110.80	100	19	Peak
5	5725.000	78.58	0.23	78.81	-43.39	122.20	100	19	Peak
6	5739.755	102.23	0.31	102.54	N/A	N/A	100	19	Peak

Note:

- " *", means this data is the worst emission level.
- C.F (Correction Factor) = Antenna Factor (dB/m)+ Cable Loss (dB) – Preamplifier(dB) + 10dB Attenuation.
- Measurement (dBUV/m) = Reading(dBUV) + C.F (Correction Factor).
- The emission levels of other frequencies are very lower than the limit and not show in test report.

EUT	AX1800 Indoor/Outdoor Wi-Fi 6 Access Point	Date of Test	2023-09-21
Factor	DRH18-E	Temp. / Humidity	20°C /60%
Polarity	Vertical	Site / Test Engineer	AC2 / Marvin
Test Mode	802.11a_Band4_TX_CH 149_ANT 0+1	Test Voltage	AC120V/60Hz

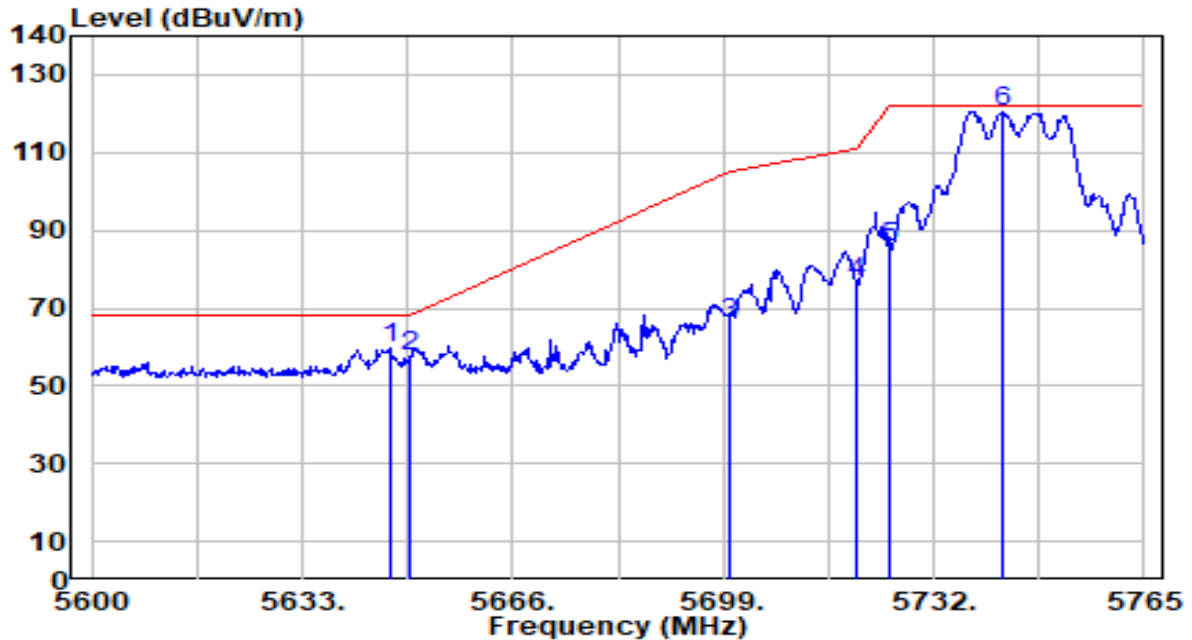

No	Frequency (MHz)	Reading (dBUV)	C.F (dB/m)	Measurement (dBUV/m)	Margin (dB)	Limit (dBUV/m)	Height (cm)	Angle (deg)	Remark (QP/PK/AV)
1	* 5646.695	59.81	-0.18	59.63	-8.57	68.20	200	304	Peak
2	5650.000	57.50	-0.16	57.34	-10.86	68.20	200	304	Peak
3	5700.000	66.03	0.10	66.13	-39.07	105.20	200	304	Peak
4	5720.000	76.38	0.20	76.58	-34.22	110.80	200	304	Peak
5	5725.000	85.53	0.23	85.76	-36.44	122.20	200	304	Peak
6	5742.890	120.20	0.32	120.53	N/A	N/A	200	304	Peak

Note:

1. " *", means this data is the worst emission level.
2. C.F (Correction Factor) = Antenna Factor (dB/m)+ Cable Loss (dB) – Preamplifier(dB) + 10dB Attenuation.
3. Measurement (dBUV/m) = Reading(dBUV) + C.F (Correction Factor).
4. The emission levels of other frequencies are very lower than the limit and not show in test report.

EUT	AX1800 Indoor/Outdoor Wi-Fi 6 Access Point	Date of Test	2023-09-21
Factor	DRH18-E	Temp. / Humidity	20°C /60%
Polarity	Horizontal	Site / Test Engineer	AC2 / Marvin
Test Mode	802.11a_Band4_TX_CH 165_ANT 0+1	Test Voltage	AC120V/60Hz

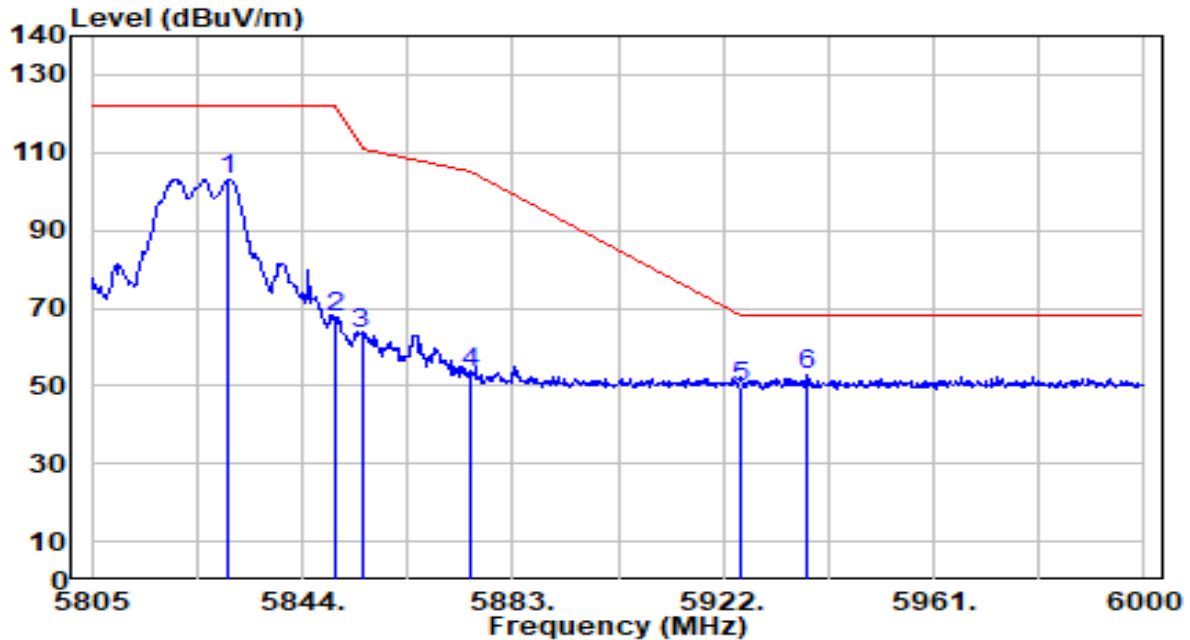

No	Frequency (MHz)	Reading (dBUV)	C.F (dB/m)	Measurement (dBUV/m)	Margin (dB)	Limit (dBUV/m)	Height (cm)	Angle (deg)	Remark (QP/PK/AV)
1	5830.350	102.60	0.60	103.19	N/A	N/A	200	30	Peak
2	5850.000	66.99	0.58	67.58	-54.62	122.20	200	30	Peak
3	5855.000	62.83	0.58	63.41	-47.39	110.80	200	30	Peak
4	5875.000	52.98	0.57	53.55	-51.65	105.20	200	30	Peak
5	5925.000	49.16	0.53	49.68	-18.52	68.20	200	30	Peak
6	* 5937.405	52.14	0.52	52.66	-15.54	68.20	200	30	Peak

Note:

1. " *", means this data is the worst emission level.
2. C.F (Correction Factor) = Antenna Factor (dB/m)+ Cable Loss (dB) – Preamplifier(dB) + 10dB Attenuation.
3. Measurement (dBUV/m) = Reading(dBUV) + C.F (Correction Factor).
4. The emission levels of other frequencies are very lower than the limit and not show in test report.

EUT	AX1800 Indoor/Outdoor Wi-Fi 6 Access Point	Date of Test	2023-09-21
Factor	DRH18-E	Temp. / Humidity	20°C /60%
Polarity	Vertical	Site / Test Engineer	AC2 / Marvin
Test Mode	802.11a_Band4_TX_CH 165_ANT 0+1	Test Voltage	AC120V/60Hz

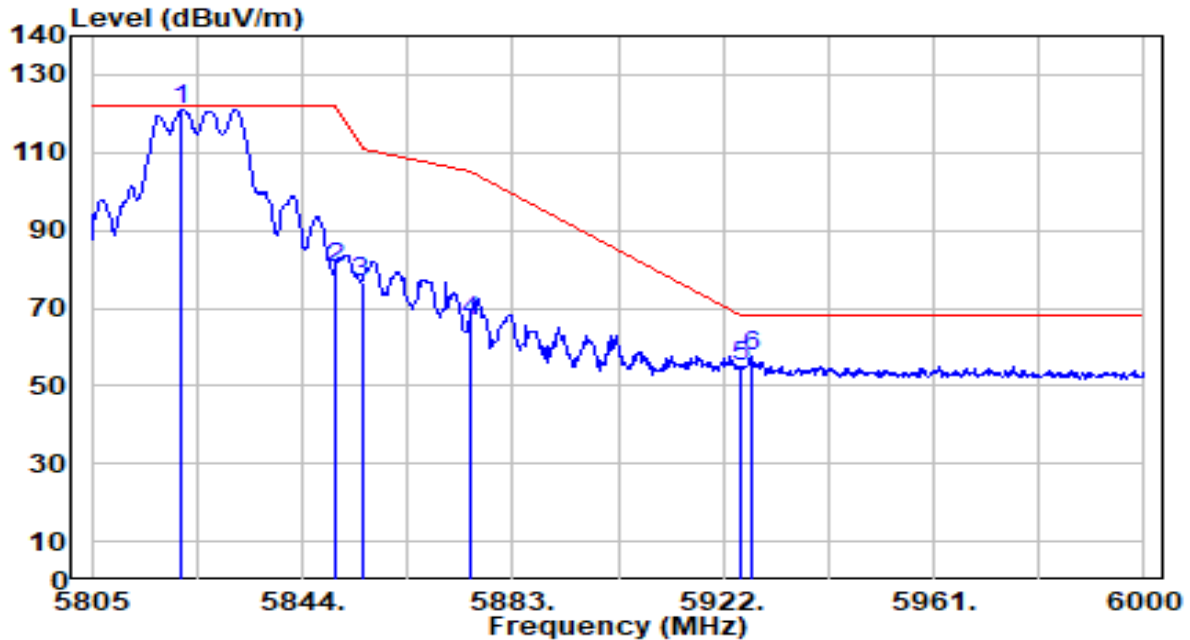

No	Frequency (MHz)	Reading (dBUV)	C.F (dB/m)	Measurement (dBUV/m)	Margin (dB)	Limit (dBUV/m)	Height (cm)	Angle (deg)	Remark (QP/PK/AV)
1	5821.770	120.47	0.61	121.07	N/A	N/A	200	353	Peak
2	5850.000	79.91	0.58	80.50	-41.70	122.20	200	353	Peak
3	5855.000	75.95	0.58	76.53	-34.27	110.80	200	353	Peak
4	5875.000	66.20	0.57	66.76	-38.44	105.20	200	353	Peak
5	5925.000	54.36	0.53	54.89	-13.31	68.20	200	353	Peak
6	* 5927.460	56.93	0.53	57.46	-10.74	68.20	200	353	Peak

Note:

1. " *", means this data is the worst emission level.
2. C.F (Correction Factor) = Antenna Factor (dB/m)+ Cable Loss (dB) – Preamplifier(dB) + 10dB Attenuation.
3. Measurement (dBUV/m) = Reading(dBUV) + C.F (Correction Factor).
4. The emission levels of other frequencies are very lower than the limit and not show in test report.

EUT	AX1800 Indoor/Outdoor Wi-Fi 6 Access Point	Date of Test	2023-09-21
Factor	DRH18-E	Temp. / Humidity	20°C /60%
Polarity	Horizontal	Site / Test Engineer	AC2 / Marvin
Test Mode	802.11ac-20MHz_Band1_TX_CH 36_ANT 0+1	Test Voltage	AC120V/60Hz

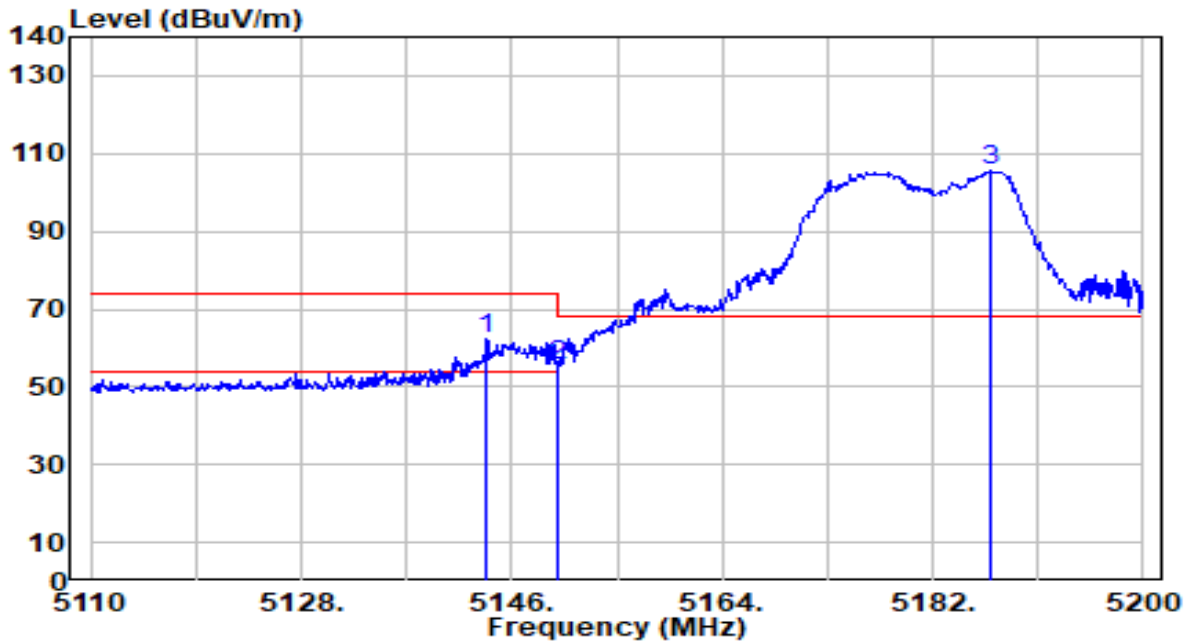

No	Frequency (MHz)	Reading (dBuV)	C.F (dB/m)	Measurement (dBuV/m)	Margin (dB)	Limit (dBuV/m)	Height (cm)	Angle (deg)	Remark (QP/PK/AV)	
1	*	5143.840	63.08	-0.71	62.36	-11.64	74.00	106	336	Peak
2		5150.000	56.10	-0.72	55.38	-18.62	74.00	106	336	Peak
3		5187.040	106.53	-0.74	105.79	N/A	N/A	106	336	Peak

Note:

1. " *", means this data is the worst emission level.
2. C.F (Correction Factor) = Antenna Factor (dB/m)+ Cable Loss (dB) – Preamplifier(dB) + 10dB Attenuation.
3. Measurement (dBuV/m) = Reading(dBuV) + C.F (Correction Factor).
4. The emission levels of other frequencies are very lower than the limit and not show in test report.

EUT	AX1800 Indoor/Outdoor Wi-Fi 6 Access Point	Date of Test	2023-09-21
Factor	DRH18-E	Temp. / Humidity	20°C /60%
Polarity	Horizontal	Site / Test Engineer	AC2 / Marvin
Test Mode	802.11ac-20MHz_Band1_TX_CH 36_ANT 0+1	Test Voltage	AC120V/60Hz

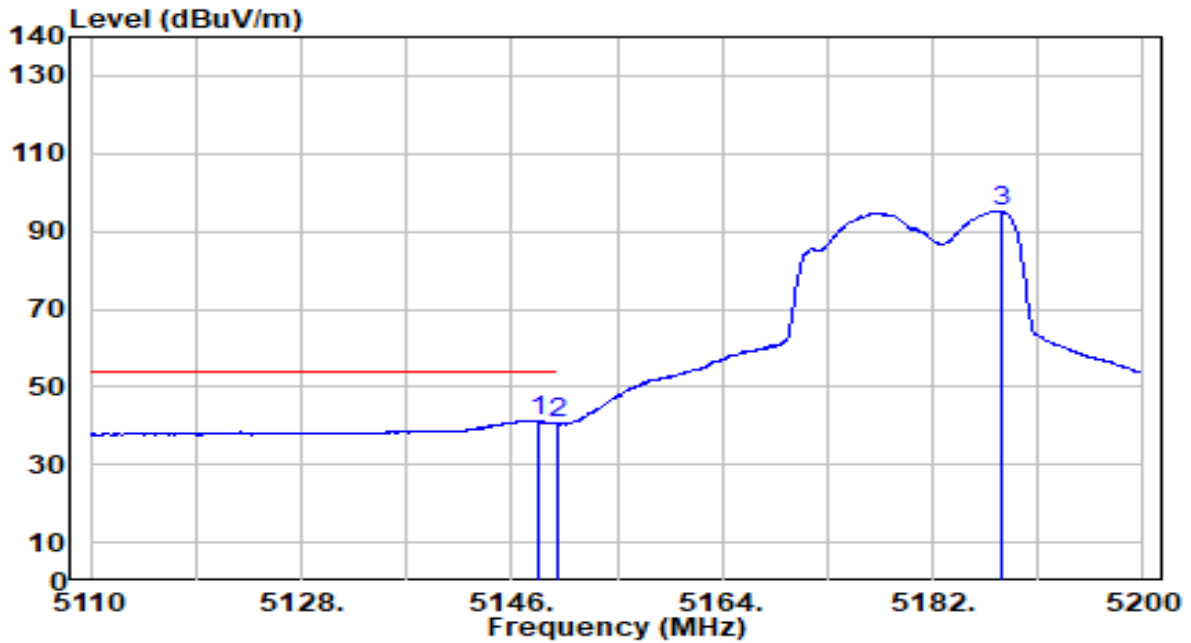

No	Frequency (MHz)	Reading (dBuV)	C.F (dB/m)	Measurement (dBuV/m)	Margin (dB)	Limit (dBuV/m)	Height (cm)	Angle (deg)	Remark (QP/PK/AV)	
1	*	5148.250	41.94	-0.72	41.22	-12.78	54.00	106	336	Average
2		5150.000	41.27	-0.72	40.55	-13.45	54.00	106	336	Average
3		5187.850	95.88	-0.74	95.15	N/A	N/A	106	336	Average

Note:

1. " *", means this data is the worst emission level.
2. C.F (Correction Factor) = Antenna Factor (dB/m)+ Cable Loss (dB) – Preamplifier(dB) + 10dB Attenuation.
3. Measurement (dBuV/m) = Reading(dBuV) + C.F (Correction Factor).
4. The emission levels of other frequencies are very lower than the limit and not show in test report.

EUT	AX1800 Indoor/Outdoor Wi-Fi 6 Access Point	Date of Test	2023-09-21
Factor	DRH18-E	Temp. / Humidity	20°C /60%
Polarity	Vertical	Site / Test Engineer	AC2 / Marvin
Test Mode	802.11ac-20MHz_Band1_TX_CH 36_ANT 0+1	Test Voltage	AC120V/60Hz

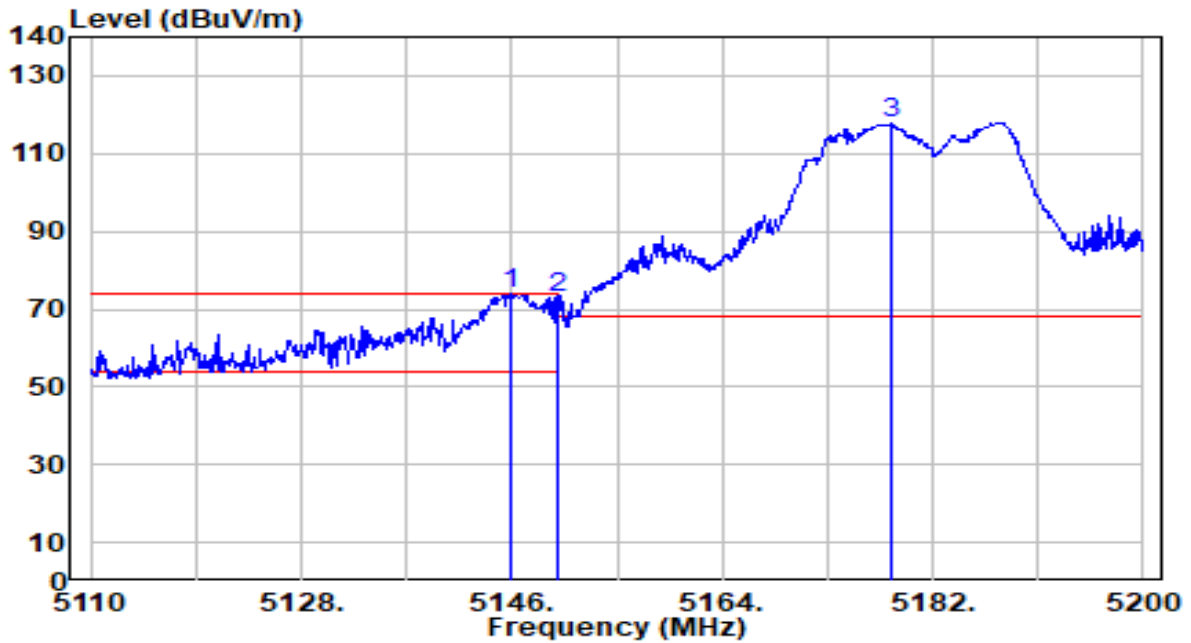

No	Frequency (MHz)	Reading (dBuV)	C.F (dB/m)	Measurement (dBuV/m)	Margin (dB)	Limit (dBuV/m)	Height (cm)	Angle (deg)	Remark (QP/PK/AV)	
1	*	5146.000	74.52	-0.72	73.81	-0.19	74.00	174	200	Peak
2		5150.000	73.51	-0.72	72.80	-1.20	74.00	174	200	Peak
3		5178.400	118.70	-0.73	117.96	N/A	N/A	174	200	Peak

Note:

1. " *", means this data is the worst emission level.
2. C.F (Correction Factor) = Antenna Factor (dB/m)+ Cable Loss (dB) – Preamplifier(dB) + 10dB Attenuation.
3. Measurement (dBuV/m) = Reading(dBuV) + C.F (Correction Factor).
4. The emission levels of other frequencies are very lower than the limit and not show in test report.

EUT	AX1800 Indoor/Outdoor Wi-Fi 6 Access Point	Date of Test	2023-09-21
Factor	DRH18-E	Temp. / Humidity	20°C /60%
Polarity	Vertical	Site / Test Engineer	AC2 / Marvin
Test Mode	802.11ac-20MHz_Band1_TX_CH 36_ANT 0+1	Test Voltage	AC120V/60Hz

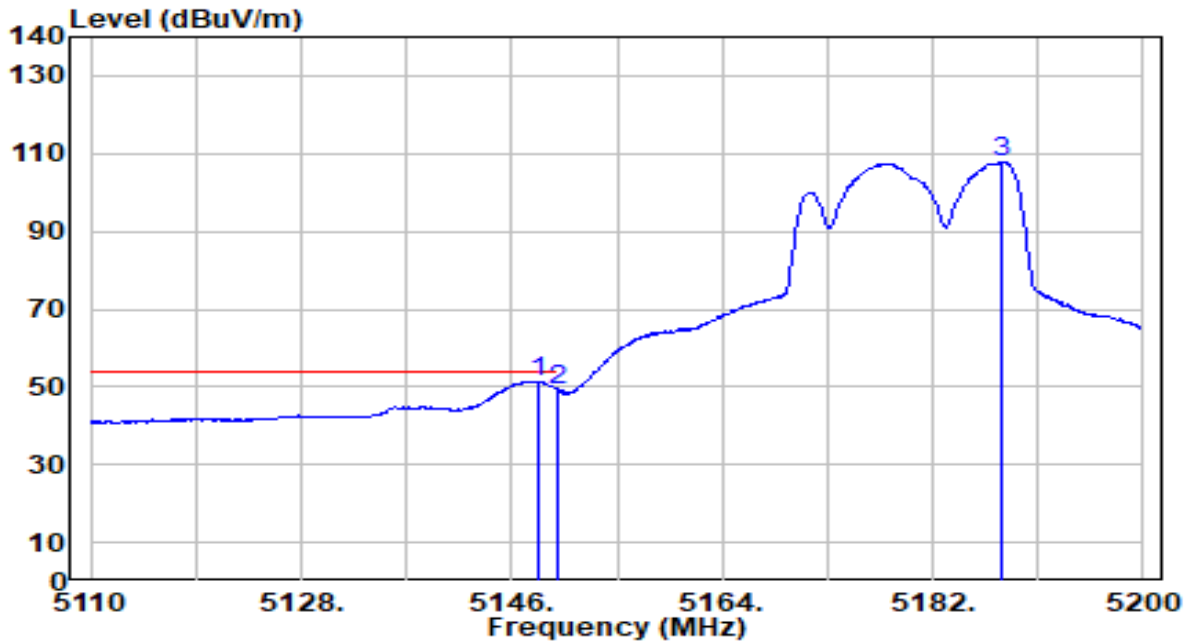

No	Frequency (MHz)	Reading (dBuV)	C.F (dB/m)	Measurement (dBuV/m)	Margin (dB)	Limit (dBuV/m)	Height (cm)	Angle (deg)	Remark (QP/PK/AV)	
1	*	5148.340	52.21	-0.72	51.49	-2.51	54.00	174	200	Average
2		5150.000	50.04	-0.72	49.32	-4.68	54.00	174	200	Average
3		5187.850	108.65	-0.74	107.91	N/A	N/A	174	200	Average

Note:

1. " *", means this data is the worst emission level.
2. C.F (Correction Factor) = Antenna Factor (dB/m)+ Cable Loss (dB) – Preamplifier(dB) + 10dB Attenuation.
3. Measurement (dBuV/m) = Reading(dBuV) + C.F (Correction Factor).
4. The emission levels of other frequencies are very lower than the limit and not show in test report.

EUT	AX1800 Indoor/Outdoor Wi-Fi 6 Access Point	Date of Test	2023-09-21
Factor	DRH18-E	Temp. / Humidity	20°C /60%
Polarity	Horizontal	Site / Test Engineer	AC2 / Marvin
Test Mode	802.11ac-20MHz_Band2_TX_CH 64_ANT 0+1	Test Voltage	AC120V/60Hz

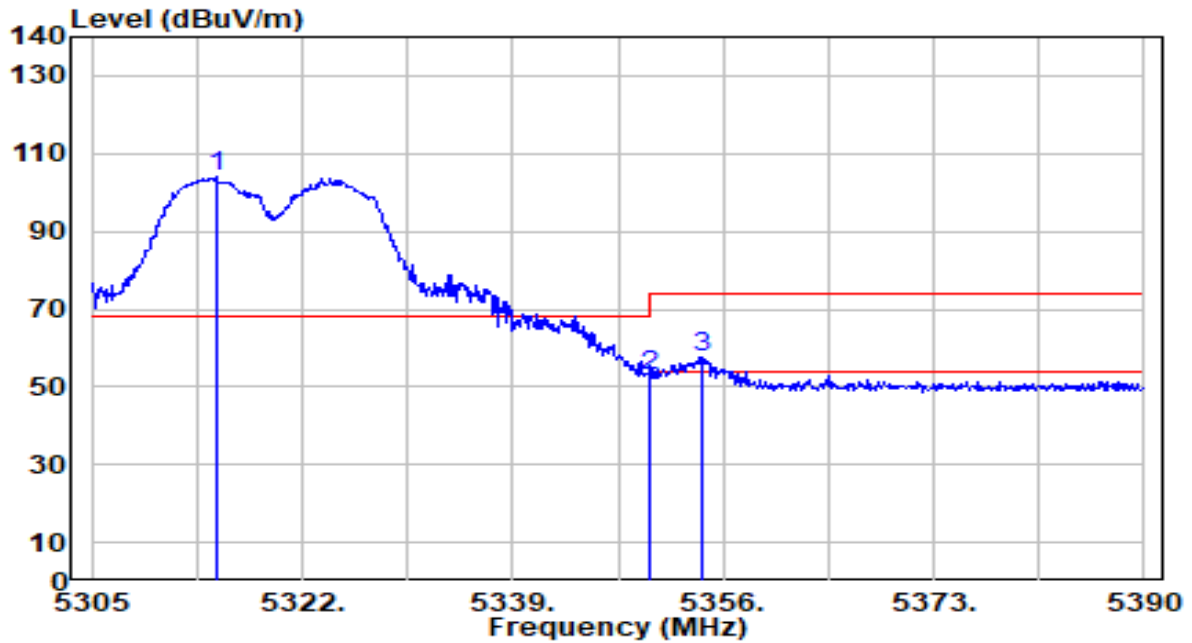

No	Frequency (MHz)	Reading (dBuV)	C.F (dB/m)	Measurement (dBuV/m)	Margin (dB)	Limit (dBuV/m)	Height (cm)	Angle (deg)	Remark (QP/PK/AV)
1	5315.030	105.00	-0.92	104.09	N/A	N/A	202	58	Peak
2	5350.000	54.06	-0.97	53.08	-20.92	74.00	202	58	Peak
3	* 5354.385	58.52	-0.98	57.54	-16.46	74.00	202	58	Peak

Note:

1. " *", means this data is the worst emission level.
2. C.F (Correction Factor) = Antenna Factor (dB/m)+ Cable Loss (dB) – Preamplifier(dB) + 10dB Attenuation.
3. Measurement (dBuV/m) = Reading(dBuV) + C.F (Correction Factor).
4. The emission levels of other frequencies are very lower than the limit and not show in test report.

EUT	AX1800 Indoor/Outdoor Wi-Fi 6 Access Point	Date of Test	2023-09-21
Factor	DRH18-E	Temp. / Humidity	20°C /60%
Polarity	Horizontal	Site / Test Engineer	AC2 / Marvin
Test Mode	802.11ac-20MHz_Band2_TX_CH 64_ANT 0+1	Test Voltage	AC120V/60Hz

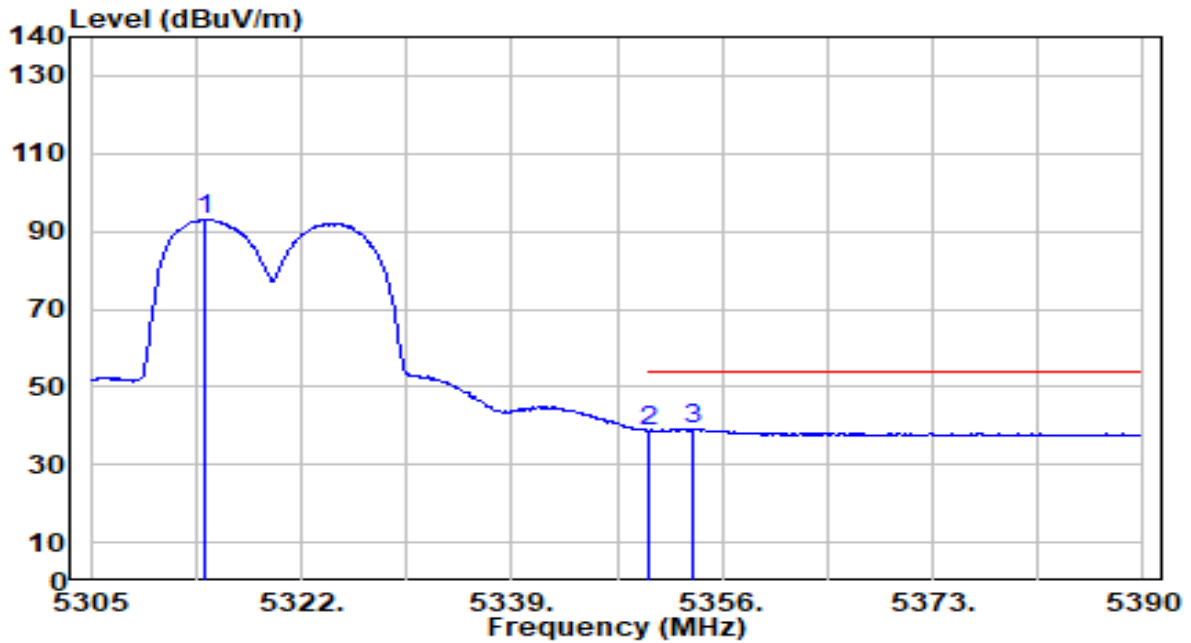

No	Frequency (MHz)	Reading (dBuV)	C.F (dB/m)	Measurement (dBuV/m)	Margin (dB)	Limit (dBuV/m)	Height (cm)	Angle (deg)	Remark (QP/PK/AV)
1	5314.180	94.04	-0.92	93.12	N/A	N/A	202	58	Average
2	5350.000	39.77	-0.97	38.80	-15.20	54.00	202	58	Average
3	* 5353.535	40.10	-0.98	39.12	-14.88	54.00	202	58	Average

Note:

1. " *", means this data is the worst emission level.
2. C.F (Correction Factor) = Antenna Factor (dB/m)+ Cable Loss (dB) – Preamplifier(dB) + 10dB Attenuation.
3. Measurement (dBuV/m) = Reading(dBuV) + C.F (Correction Factor).
4. The emission levels of other frequencies are very lower than the limit and not show in test report.

EUT	AX1800 Indoor/Outdoor Wi-Fi 6 Access Point	Date of Test	2023-09-23
Factor	DRH18-E	Temp. / Humidity	20°C /60%
Polarity	Vertical	Site / Test Engineer	AC2 / Marvin
Test Mode	802.11ac-20MHz_Band2_TX_CH 64_ANT 0+1	Test Voltage	AC 120V/60Hz

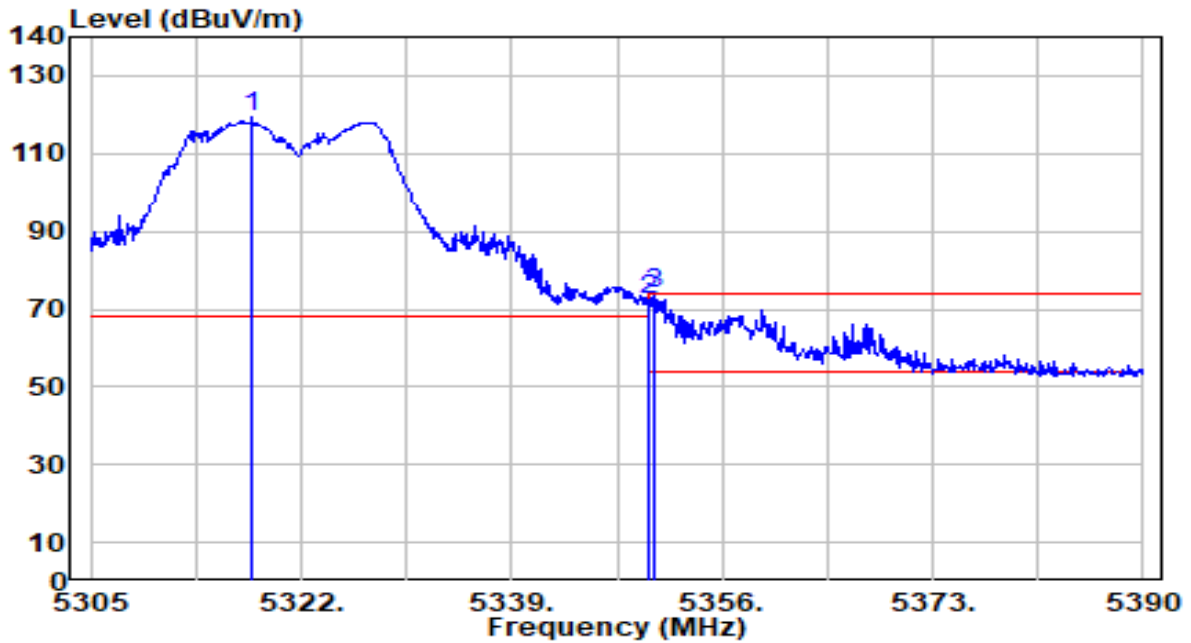

No	Frequency (MHz)	Reading (dBuV)	C.F (dB/m)	Measurement (dBuV/m)	Margin (dB)	Limit (dBuV/m)	Height (cm)	Angle (deg)	Remark (QP/PK/AV)
1	5318.005	120.12	-0.92	119.19	N/A	N/A	180	158	Peak
2	5350.000	73.12	-0.97	72.15	-1.85	74.00	180	158	Peak
3	* 5350.560	74.73	-0.97	73.75	-0.25	74.00	180	158	Peak

Note:

1. " *", means this data is the worst emission level.
2. C.F (Correction Factor) = Antenna Factor (dB/m) + Cable Loss (dB) – Preamplifier(dB) + 10dB Attenuation.
3. Measurement (dBuV/m) = Reading(dBuV) + C.F (Correction Factor).
4. The emission levels of other frequencies are very lower than the limit and not show in test report.

EUT	AX1800 Indoor/Outdoor Wi-Fi 6 Access Point	Date of Test	2023-09-21
Factor	DRH18-E	Temp. / Humidity	20°C /60%
Polarity	Vertical	Site / Test Engineer	AC2 / Marvin
Test Mode	802.11ac-20MHz_Band2_TX_CH 64_ANT 0+1	Test Voltage	AC120V/60Hz

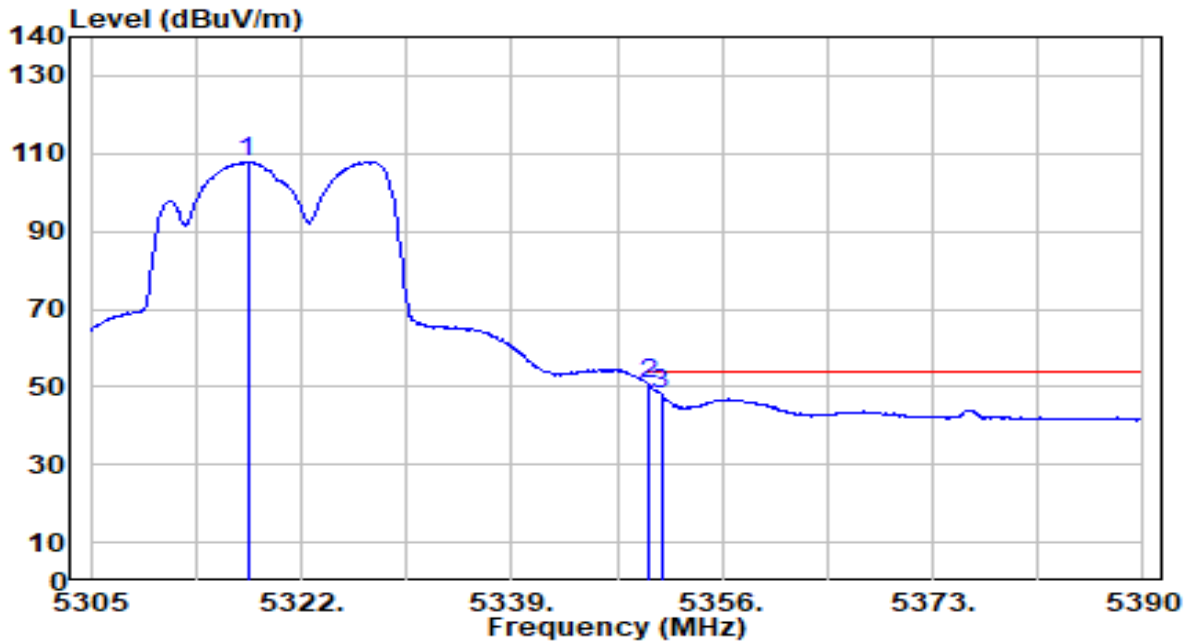

No	Frequency (MHz)	Reading (dBuV)	C.F (dB/m)	Measurement (dBuV/m)	Margin (dB)	Limit (dBuV/m)	Height (cm)	Angle (deg)	Remark (QP/PK/AV)
1	5317.665	108.68	-0.92	107.76	N/A	N/A	180	158	Average
2	* 5350.000	51.78	-0.97	50.81	-3.19	54.00	180	158	Average
3	5351.070	49.03	-0.97	48.05	-5.95	54.00	180	158	Average

Note:

1. " *", means this data is the worst emission level.
2. C.F (Correction Factor) = Antenna Factor (dB/m)+ Cable Loss (dB) – Preamplifier(dB) + 10dB Attenuation.
3. Measurement (dBuV/m) = Reading(dBuV) + C.F (Correction Factor).
4. The emission levels of other frequencies are very lower than the limit and not show in test report.

EUT	AX1800 Indoor/Outdoor Wi-Fi 6 Access Point	Date of Test	2023-09-21
Factor	DRH18-E	Temp. / Humidity	20°C /60%
Polarity	Horizontal	Site / Test Engineer	AC2 / Marvin
Test Mode	802.11ac-20MHz_Band3_TX_CH 100_ANT 0+1	Test Voltage	AC120V/60Hz

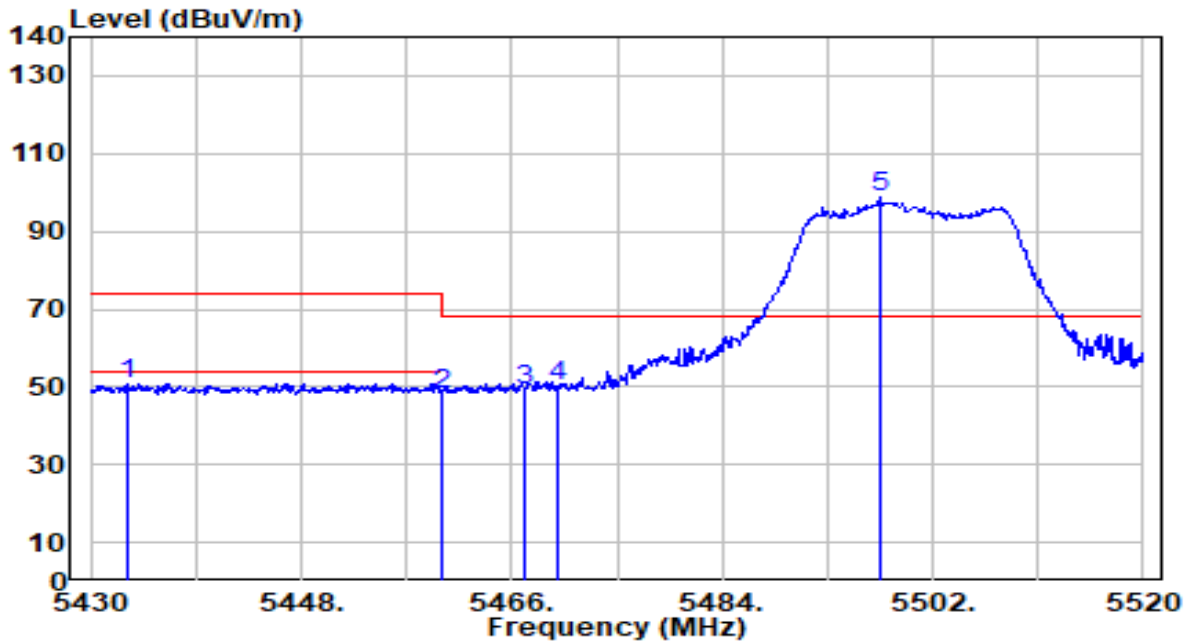

No	Frequency (MHz)	Reading (dBuV)	C.F (dB/m)	Measurement (dBuV/m)	Margin (dB)	Limit (dBuV/m)	Height (cm)	Angle (deg)	Remark (QP/PK/AV)
1	5433.150	51.82	-0.95	50.87	-23.13	74.00	208	65	Peak
2	5460.000	48.94	-0.87	48.08	-25.92	74.00	208	65	Peak
3	5467.080	49.92	-0.85	49.07	-19.13	68.20	208	65	Peak
4	* 5470.000	50.94	-0.84	50.10	-18.10	68.20	208	65	Peak
5	5497.500	99.46	-0.76	98.71	N/A	N/A	208	65	Peak

Note:

1. " *", means this data is the worst emission level.
2. C.F (Correction Factor) = Antenna Factor (dB/m)+ Cable Loss (dB) – Preamplifier(dB) + 10dB Attenuation.
3. Measurement (dBuV/m) = Reading(dBuV) + C.F (Correction Factor).
4. The emission levels of other frequencies are very lower than the limit and not show in test report.

EUT	AX1800 Indoor/Outdoor Wi-Fi 6 Access Point	Date of Test	2023-09-21
Factor	DRH18-E	Temp. / Humidity	20°C /60%
Polarity	Horizontal	Site / Test Engineer	AC2 / Marvin
Test Mode	802.11ac-20MHz_Band3_TX_CH 100_ANT 0+1	Test Voltage	AC120V/60Hz

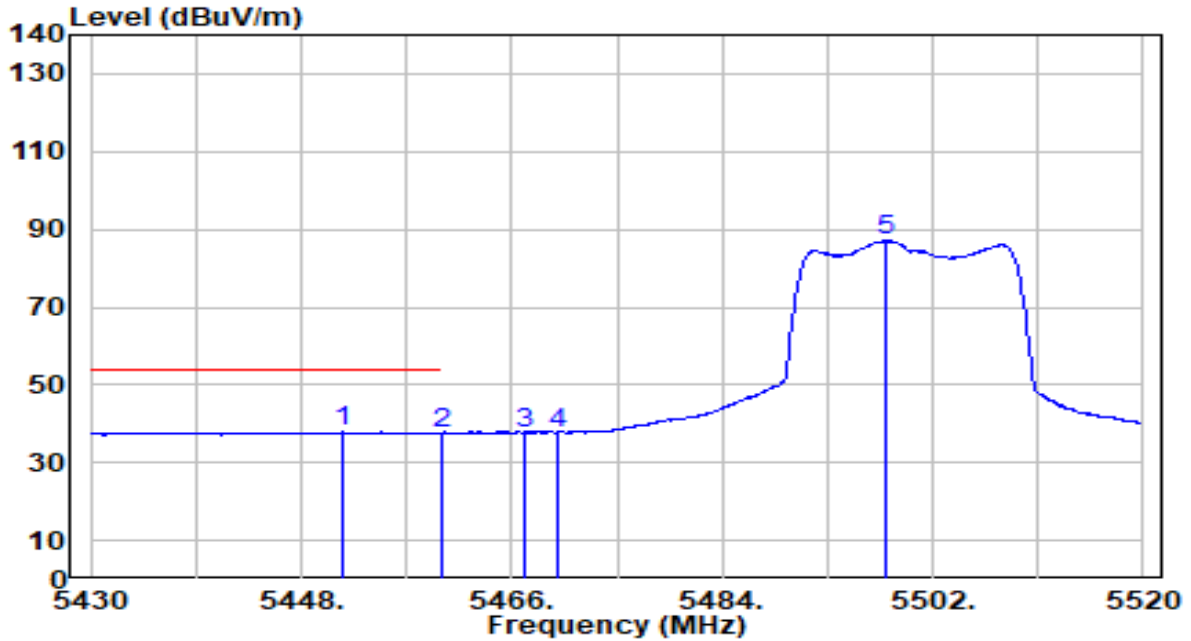

No	Frequency (MHz)	Reading (dBuV)	C.F (dB/m)	Measurement (dBuV/m)	Margin (dB)	Limit (dBuV/m)	Height (cm)	Angle (deg)	Remark (QP/PK/AV)
1	* 5451.510	38.69	-0.89	37.79	-16.21	54.00	208	65	Average
2	5460.000	38.49	-0.87	37.62	-16.38	54.00	208	65	Average
3	5467.080	38.48	-0.85	37.63	N/A	N/A	208	65	Average
4	5470.000	38.60	-0.84	37.76	N/A	N/A	208	65	Average
5	5497.950	87.77	-0.76	87.01	N/A	N/A	208	65	Average

Note:

1. " *", means this data is the worst emission level.
2. C.F (Correction Factor) = Antenna Factor (dB/m)+ Cable Loss (dB) – Preamplifier(dB) + 10dB Attenuation.
3. Measurement (dBuV/m) = Reading(dBuV) + C.F (Correction Factor).
4. The emission levels of other frequencies are very lower than the limit and not show in test report.

EUT	AX1800 Indoor/Outdoor Wi-Fi 6 Access Point	Date of Test	2023-09-21
Factor	DRH18-E	Temp. / Humidity	20°C /60%
Polarity	Vertical	Site / Test Engineer	AC2 / Marvin
Test Mode	802.11ac-20MHz_Band3_TX_CH 100_ANT 0+1	Test Voltage	AC120V/60Hz

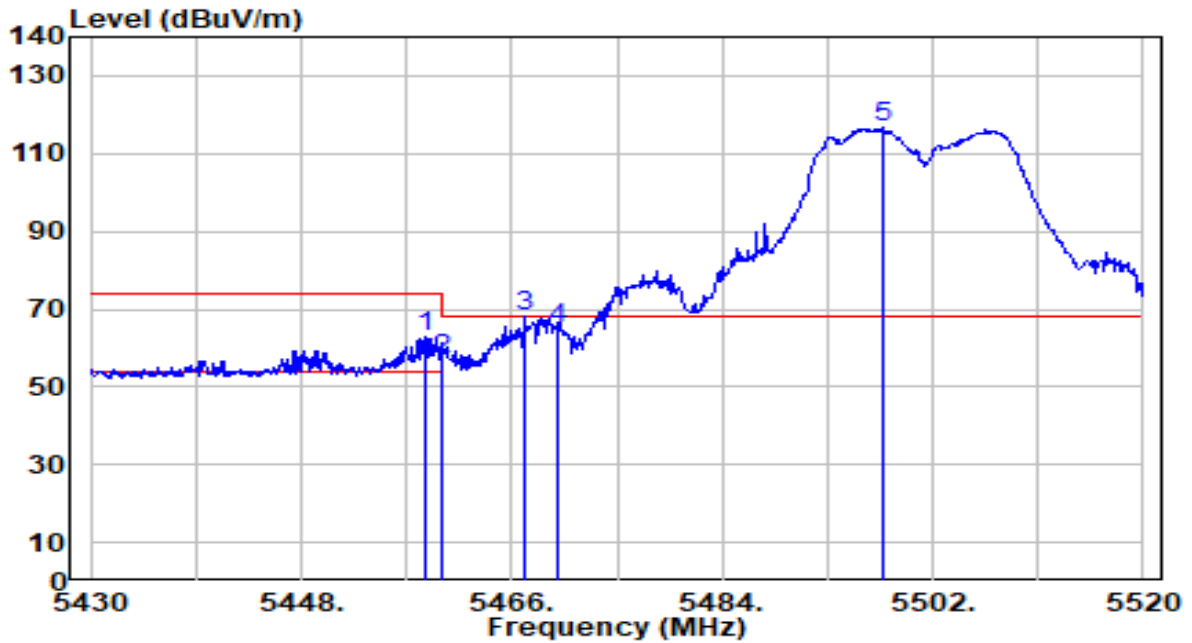

No	Frequency (MHz)	Reading (dBuV)	C.F (dB/m)	Measurement (dBuV/m)	Margin (dB)	Limit (dBuV/m)	Height (cm)	Angle (deg)	Remark (QP/PK/AV)
1	5458.710	63.95	-0.87	63.08	-10.92	74.00	178	146	Peak
2	5460.000	57.70	-0.87	56.83	-17.17	74.00	178	146	Peak
3	* 5467.080	68.89	-0.85	68.04	-0.16	68.20	178	146	Peak
4	5470.000	65.71	-0.84	64.87	-3.33	68.20	178	146	Peak
5	5497.770	117.62	-0.76	116.86	N/A	N/A	178	146	Peak

Note:

1. " *", means this data is the worst emission level.
2. C.F (Correction Factor) = Antenna Factor (dB/m)+ Cable Loss (dB) – Preamplifier(dB) + 10dB Attenuation.
3. Measurement (dBuV/m) = Reading(dBuV) + C.F (Correction Factor).
4. The emission levels of other frequencies are very lower than the limit and not show in test report.

EUT	AX1800 Indoor/Outdoor Wi-Fi 6 Access Point	Date of Test	2023-09-21
Factor	DRH18-E	Temp. / Humidity	20°C /60%
Polarity	Vertical	Site / Test Engineer	AC2 / Marvin
Test Mode	802.11ac-20MHz_Band3_TX_CH 100_ANT 0+1	Test Voltage	AC120V/60Hz

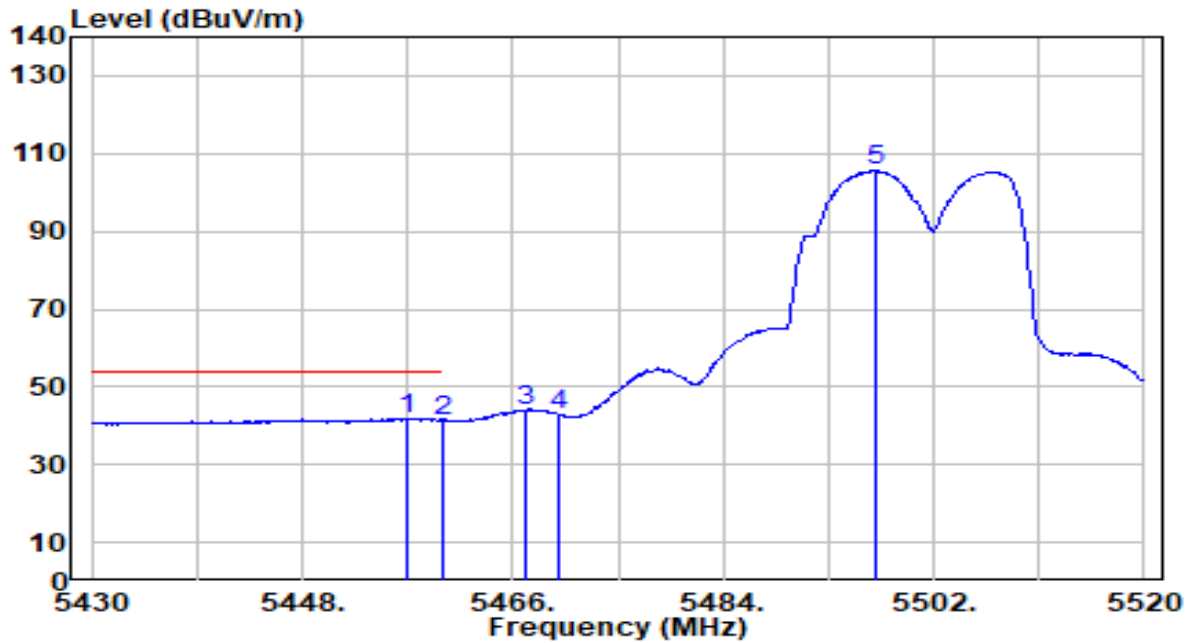

No	Frequency (MHz)	Reading (dBuV)	C.F (dB/m)	Measurement (dBuV/m)	Margin (dB)	Limit (dBuV/m)	Height (cm)	Angle (deg)	Remark (QP/PK/AV)
1	* 5457.000	42.79	-0.88	41.91	-12.09	54.00	178	146	Average
2	5460.000	42.34	-0.87	41.47	-12.53	54.00	178	146	Average
3	5467.080	44.80	-0.85	43.95	N/A	N/A	178	146	Average
4	5470.000	43.74	-0.84	42.90	N/A	N/A	178	146	Average
5	5497.050	106.51	-0.76	105.75	N/A	N/A	178	146	Average

Note:

1. " *", means this data is the worst emission level.
2. C.F (Correction Factor) = Antenna Factor (dB/m)+ Cable Loss (dB) – Preamplifier(dB) + 10dB Attenuation.
3. Measurement (dBuV/m) = Reading(dBuV) + C.F (Correction Factor).
4. The emission levels of other frequencies are very lower than the limit and not show in test report.

EUT	AX1800 Indoor/Outdoor Wi-Fi 6 Access Point	Date of Test	2023-09-21
Factor	DRH18-E	Temp. / Humidity	20°C /60%
Polarity	Horizontal	Site / Test Engineer	AC2 / Marvin
Test Mode	802.11ac-20MHz_Band3_TX_CH 140_ANT 0+1	Test Voltage	AC120V/60Hz

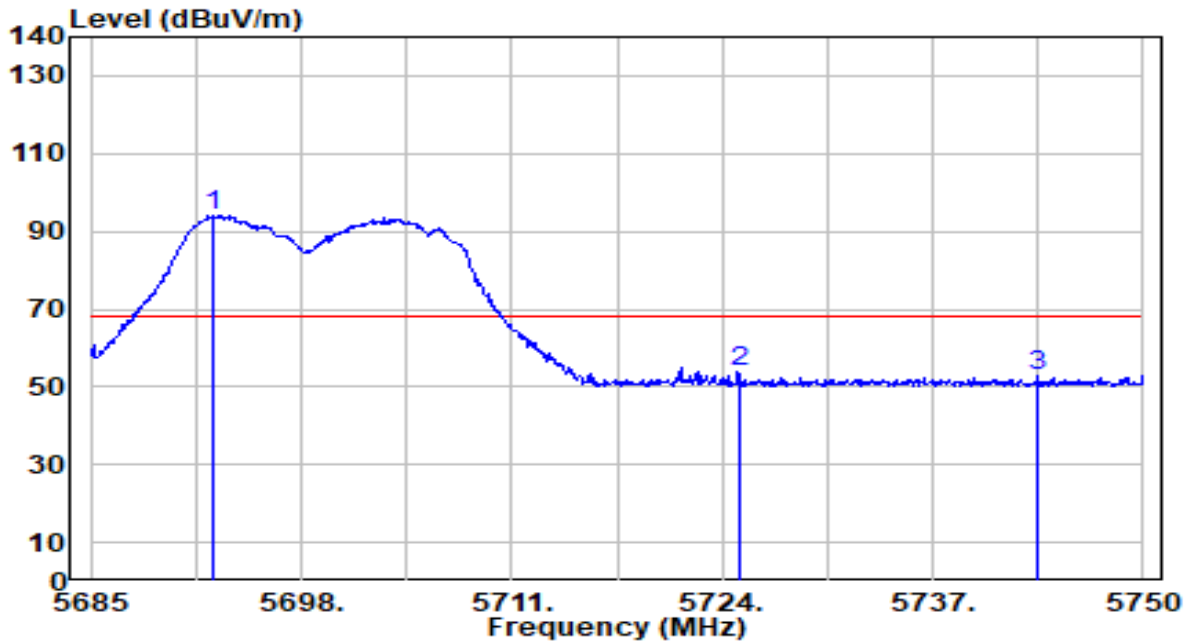

No	Frequency (MHz)	Reading (dBuV)	C.F (dB/m)	Measurement (dBuV/m)	Margin (dB)	Limit (dBuV/m)	Height (cm)	Angle (deg)	Remark (QP/PK/AV)
1	5692.540	93.90	0.06	93.96	N/A	N/A	119	2	Peak
2	* 5725.000	53.44	0.23	53.67	-14.53	68.20	119	2	Peak
3	5743.500	52.51	0.33	52.83	-15.37	68.20	119	2	Peak

Note:

1. " *", means this data is the worst emission level.
2. C.F (Correction Factor) = Antenna Factor (dB/m)+ Cable Loss (dB) – Preamplifier(dB) + 10dB Attenuation.
3. Measurement (dBuV/m) = Reading(dBuV) + C.F (Correction Factor).
4. The emission levels of other frequencies are very lower than the limit and not show in test report.

EUT	AX1800 Indoor/Outdoor Wi-Fi 6 Access Point	Date of Test	2023-09-21
Factor	DRH18-E	Temp. / Humidity	20°C /60%
Polarity	Vertical	Site / Test Engineer	AC2 / Marvin
Test Mode	802.11ac-20MHz_Band3_TX_CH 140_ANT 0+1	Test Voltage	AC120V/60Hz

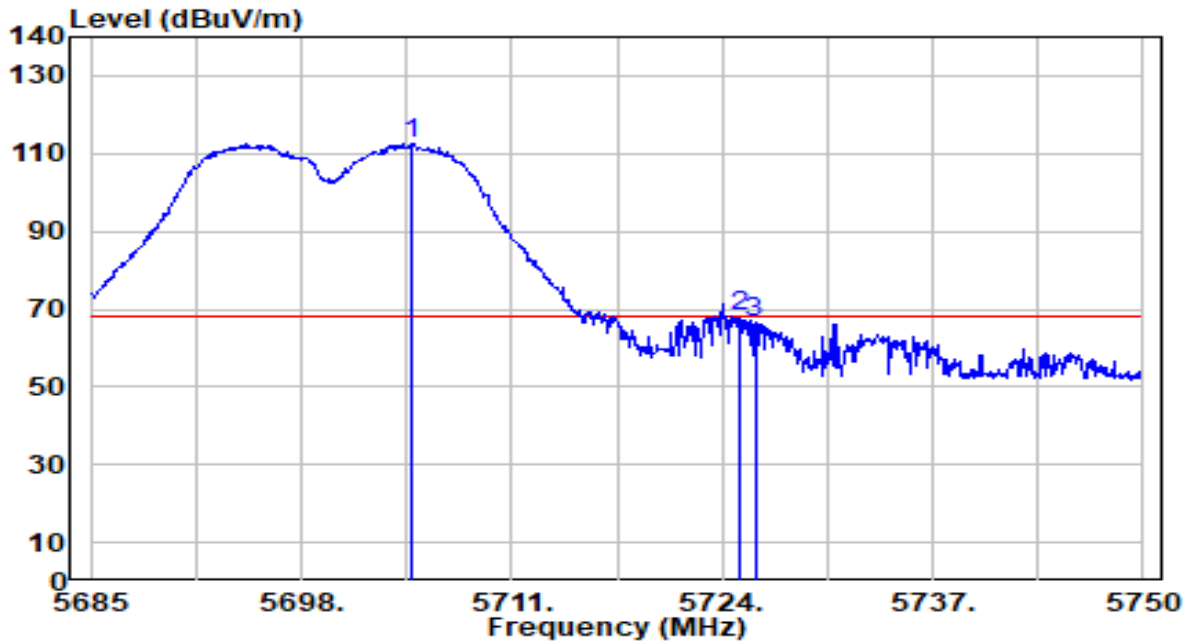

No	Frequency (MHz)	Reading (dBuV)	C.F (dB/m)	Measurement (dBuV/m)	Margin (dB)	Limit (dBuV/m)	Height (cm)	Angle (deg)	Remark (QP/PK/AV)
1	5704.890	112.28	0.12	112.40	N/A	N/A	200	236	Peak
2	* 5725.000	67.79	0.23	68.02	-0.18	68.20	200	236	Peak
3	5726.015	66.21	0.23	66.44	-1.76	68.20	200	236	Peak

Note:

1. " *", means this data is the worst emission level.
2. C.F (Correction Factor) = Antenna Factor (dB/m)+ Cable Loss (dB) – Preamplifier(dB) + 10dB Attenuation.
3. Measurement (dBuV/m) = Reading(dBuV) + C.F (Correction Factor).
4. The emission levels of other frequencies are very lower than the limit and not show in test report.

EUT	AX1800 Indoor/Outdoor Wi-Fi 6 Access Point	Date of Test	2023-09-21
Factor	DRH18-E	Temp. / Humidity	20°C /60%
Polarity	Horizontal	Site / Test Engineer	AC2 / Marvin
Test Mode	802.11ac-20MHz_Band4_TX_CH 149_ANT 0+1	Test Voltage	AC120V/60Hz

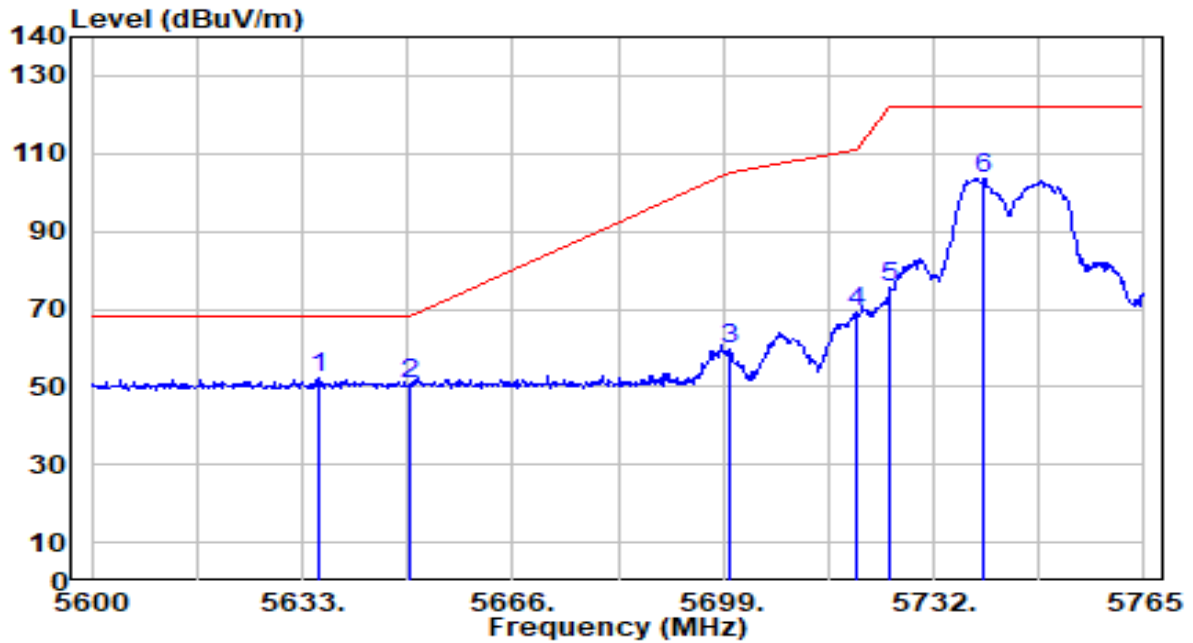

No	Frequency (MHz)	Reading (dBUV)	C.F (dB/m)	Measurement (dBUV/m)	Margin (dB)	Limit (dBUV/m)	Height (cm)	Angle (deg)	Remark (QP/PK/AV)
1	* 5635.805	52.38	-0.24	52.14	-16.06	68.20	115	2	Peak
2	5650.000	50.66	-0.16	50.50	-17.70	68.20	115	2	Peak
3	5700.000	59.41	0.10	59.51	-45.69	105.20	115	2	Peak
4	5720.000	68.78	0.20	68.98	-41.82	110.80	115	2	Peak
5	5725.000	75.45	0.23	75.68	-46.52	122.20	115	2	Peak
6	5739.920	103.22	0.31	103.52	N/A	N/A	115	2	Peak

Note:

1. " *", means this data is the worst emission level.
2. C.F (Correction Factor) = Antenna Factor (dB/m)+ Cable Loss (dB) – Preamplifier(dB) + 10dB Attenuation.
3. Measurement (dBUV/m) = Reading(dBUV) + C.F (Correction Factor).
4. The emission levels of other frequencies are very lower than the limit and not show in test report.

EUT	AX1800 Indoor/Outdoor Wi-Fi 6 Access Point	Date of Test	2023-09-21
Factor	DRH18-E	Temp. / Humidity	20°C /60%
Polarity	Vertical	Site / Test Engineer	AC2 / Marvin
Test Mode	802.11ac-20MHz_Band4_TX_CH 149_ANT 0+1	Test Voltage	AC120V/60Hz

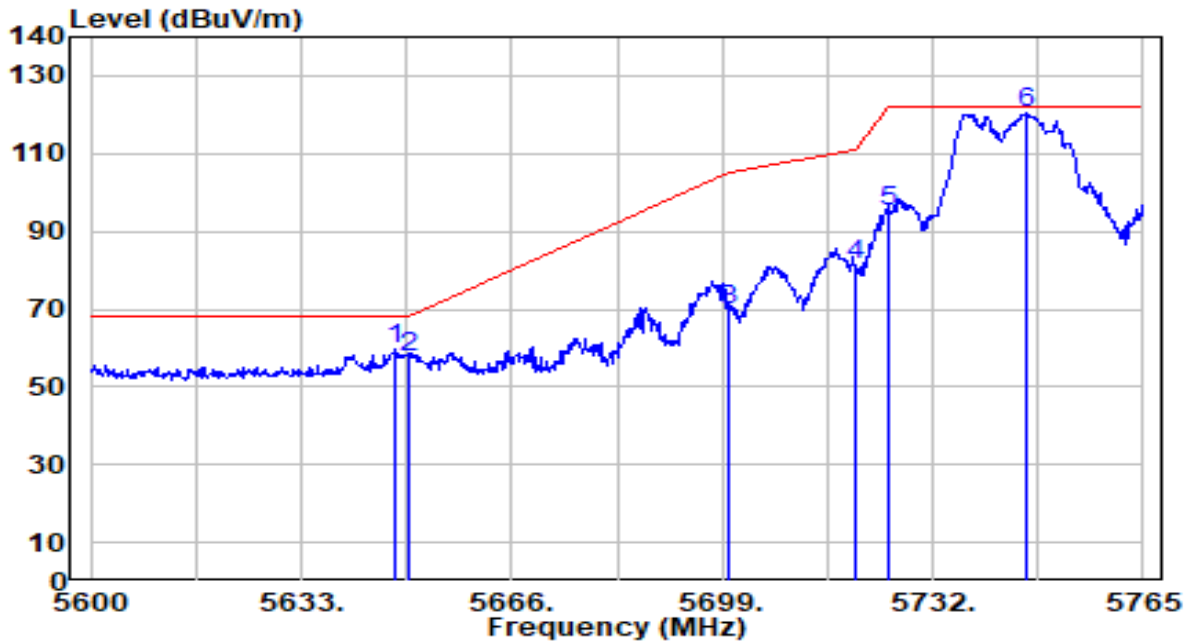

No	Frequency (MHz)	Reading (dBUV)	C.F (dB/m)	Measurement (dBUV/m)	Margin (dB)	Limit (dBUV/m)	Height (cm)	Angle (deg)	Remark (QP/PK/AV)	
1	*	5647.685	59.73	-0.18	59.55	-8.65	68.20	200	327	Peak
2		5650.000	57.73	-0.16	57.56	-10.64	68.20	200	327	Peak
3		5700.000	69.43	0.10	69.53	-35.67	105.20	200	327	Peak
4		5720.000	81.35	0.20	81.56	-29.24	110.80	200	327	Peak
5		5725.000	94.73	0.23	94.96	-27.24	122.20	200	327	Peak
6		5746.520	119.92	0.34	120.27	N/A	N/A	200	327	Peak

Note:

1. " *", means this data is the worst emission level.
2. C.F (Correction Factor) = Antenna Factor (dB/m)+ Cable Loss (dB) – Preamplifier(dB) + 10dB Attenuation.
3. Measurement (dBUV/m) = Reading(dBUV) + C.F (Correction Factor).
4. The emission levels of other frequencies are very lower than the limit and not show in test report.

EUT	AX1800 Indoor/Outdoor Wi-Fi 6 Access Point	Date of Test	2023-09-21
Factor	DRH18-E	Temp. / Humidity	20°C /60%
Polarity	Horizontal	Site / Test Engineer	AC2 / Marvin
Test Mode	802.11ac-20MHz_Band4_TX_CH 165_ANT 0+1	Test Voltage	AC120V/60Hz

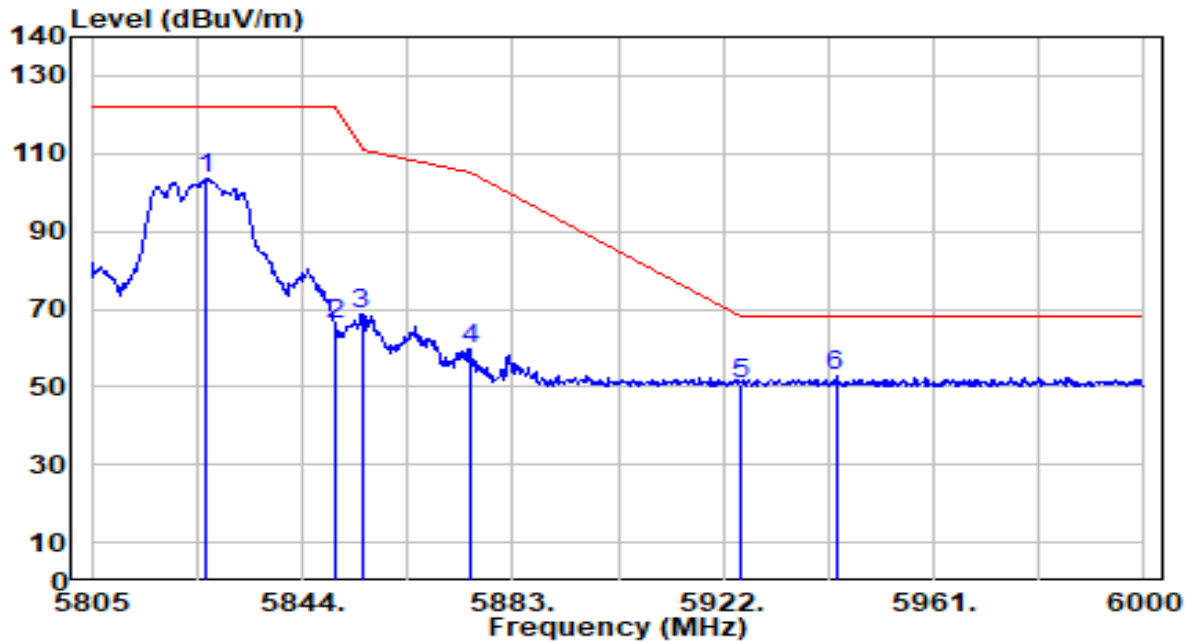

No	Frequency (MHz)	Reading (dBUV)	C.F (dB/m)	Measurement (dBUV/m)	Margin (dB)	Limit (dBUV/m)	Height (cm)	Angle (deg)	Remark (QP/PK/AV)
1	5826.255	103.13	0.60	103.73	N/A	N/A	200	30	Peak
2	5850.000	65.39	0.58	65.98	-56.22	122.20	200	30	Peak
3	5855.000	68.25	0.58	68.83	-41.97	110.80	200	30	Peak
4	5875.000	59.02	0.57	59.58	-45.62	105.20	200	30	Peak
5	5925.000	50.25	0.53	50.78	-17.42	68.20	200	30	Peak
6	* 5942.865	52.15	0.51	52.67	-15.53	68.20	200	30	Peak

Note:

1. " *", means this data is the worst emission level.
2. C.F (Correction Factor) = Antenna Factor (dB/m)+ Cable Loss (dB) – Preamplifier(dB) + 10dB Attenuation.
3. Measurement (dBUV/m) = Reading(dBUV) + C.F (Correction Factor).
4. The emission levels of other frequencies are very lower than the limit and not show in test report.

EUT	AX1800 Indoor/Outdoor Wi-Fi 6 Access Point	Date of Test	2023-09-21
Factor	DRH18-E	Temp. / Humidity	20°C /60%
Polarity	Vertical	Site / Test Engineer	AC2 / Marvin
Test Mode	802.11ac-20MHz_Band4_TX_CH 165_ANT 0+1	Test Voltage	AC120V/60Hz

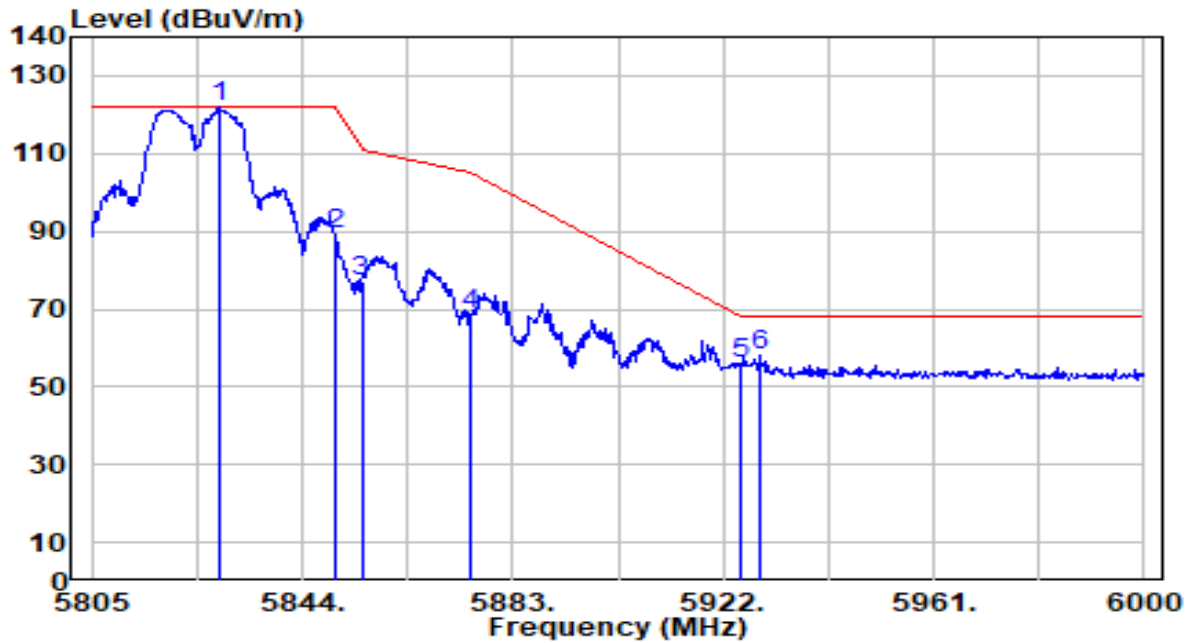

No	Frequency (MHz)	Reading (dBUV)	C.F (dB/m)	Measurement (dBUV/m)	Margin (dB)	Limit (dBUV/m)	Height (cm)	Angle (deg)	Remark (QP/PK/AV)
1	5828.595	121.56	0.60	122.16	N/A	N/A	200	352	Peak
2	5850.000	88.86	0.58	89.44	-32.76	122.20	200	352	Peak
3	5855.000	76.42	0.58	77.00	-33.80	110.80	200	352	Peak
4	5875.000	67.98	0.57	68.55	-36.65	105.20	200	352	Peak
5	5925.000	55.50	0.53	56.02	-12.18	68.20	200	352	Peak
6	* 5928.825	57.39	0.52	57.91	-10.29	68.20	200	352	Peak

Note:

1. " *", means this data is the worst emission level.
2. C.F (Correction Factor) = Antenna Factor (dB/m)+ Cable Loss (dB) – Preamplifier(dB) + 10dB Attenuation.
3. Measurement (dBUV/m) = Reading(dBUV) + C.F (Correction Factor).
4. The emission levels of other frequencies are very lower than the limit and not show in test report.

EUT	AX1800 Indoor/Outdoor Wi-Fi 6 Access Point	Date of Test	2023-09-21
Factor	DRH18-E	Temp. / Humidity	20°C /60%
Polarity	Horizontal	Site / Test Engineer	AC2 / Marvin
Test Mode	802.11ac-40MHz_Band1_TX_CH 38_ANT 0+1	Test Voltage	AC120V/60Hz

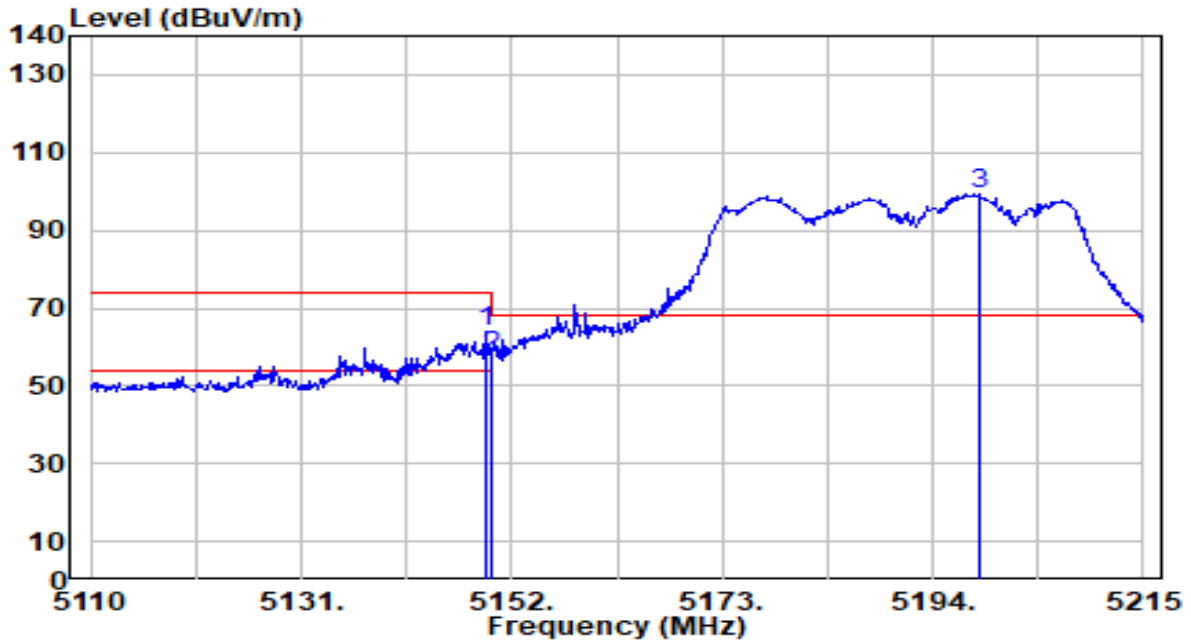

No	Frequency (MHz)	Reading (dBuV)	C.F (dB/m)	Measurement (dBuV/m)	Margin (dB)	Limit (dBuV/m)	Height (cm)	Angle (deg)	Remark (QP/PK/AV)	
1	*	5149.375	64.61	-0.72	63.89	-10.11	74.00	121	336	Peak
2		5150.000	58.54	-0.72	57.82	-16.18	74.00	121	336	Peak
3		5198.620	100.24	-0.74	99.50	N/A	N/A	121	336	Peak

Note:

1. " *", means this data is the worst emission level.
2. C.F (Correction Factor) = Antenna Factor (dB/m)+ Cable Loss (dB) – Preamplifier(dB) + 10dB Attenuation.
3. Measurement (dBuV/m) = Reading(dBuV) + C.F (Correction Factor).
4. The emission levels of other frequencies are very lower than the limit and not show in test report.

EUT	AX1800 Indoor/Outdoor Wi-Fi 6 Access Point	Date of Test	2023-09-21
Factor	DRH18-E	Temp. / Humidity	20°C /60%
Polarity	Horizontal	Site / Test Engineer	AC2 / Marvin
Test Mode	802.11ac-40MHz_Band1_TX_CH 38_ANT 0+1	Test Voltage	AC120V/60Hz

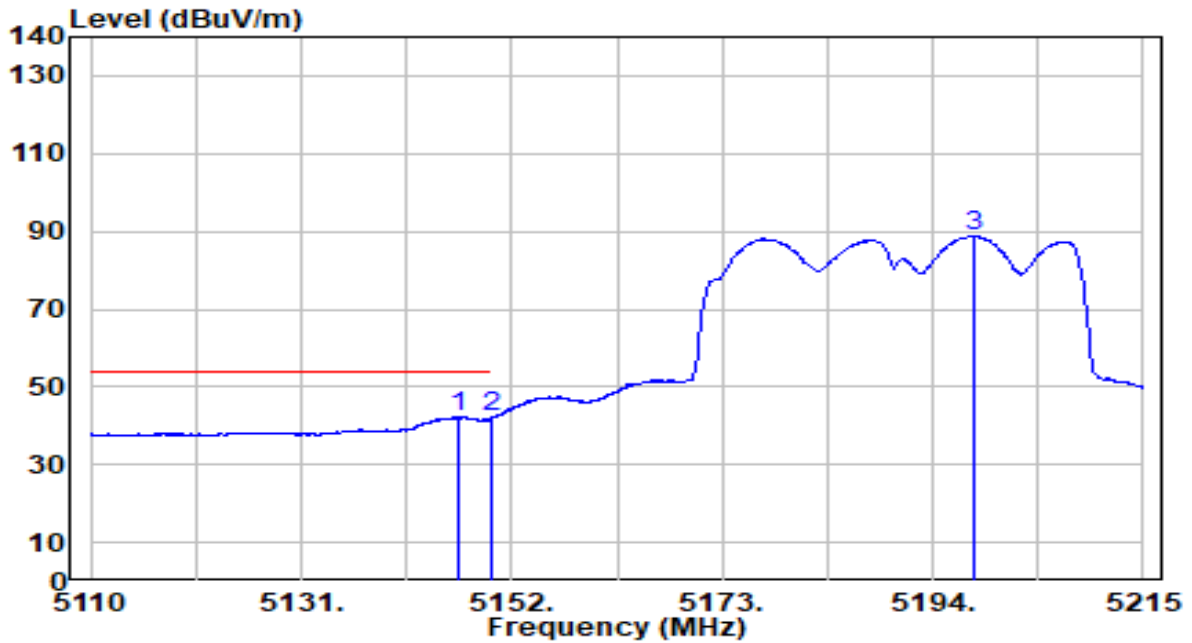

No	Frequency (MHz)	Reading (dBuV)	C.F (dB/m)	Measurement (dBuV/m)	Margin (dB)	Limit (dBuV/m)	Height (cm)	Angle (deg)	Remark (QP/PK/AV)	
1	*	5146.645	42.94	-0.72	42.22	-11.78	54.00	121	336	Average
2		5150.000	42.72	-0.72	42.00	-12.00	54.00	121	336	Average
3		5198.095	89.54	-0.74	88.80	N/A	N/A	121	336	Average

Note:

1. " *", means this data is the worst emission level.
2. C.F (Correction Factor) = Antenna Factor (dB/m)+ Cable Loss (dB) – Preamplifier(dB) + 10dB Attenuation.
3. Measurement (dBuV/m) = Reading(dBuV) + C.F (Correction Factor).
4. The emission levels of other frequencies are very lower than the limit and not show in test report.

EUT	AX1800 Indoor/Outdoor Wi-Fi 6 Access Point	Date of Test	2023-09-21
Factor	DRH18-E	Temp. / Humidity	20°C /60%
Polarity	Vertical	Site / Test Engineer	AC2 / Marvin
Test Mode	802.11ac-40MHz_Band1_TX_CH 38_ANT 0+1	Test Voltage	AC120V/60Hz

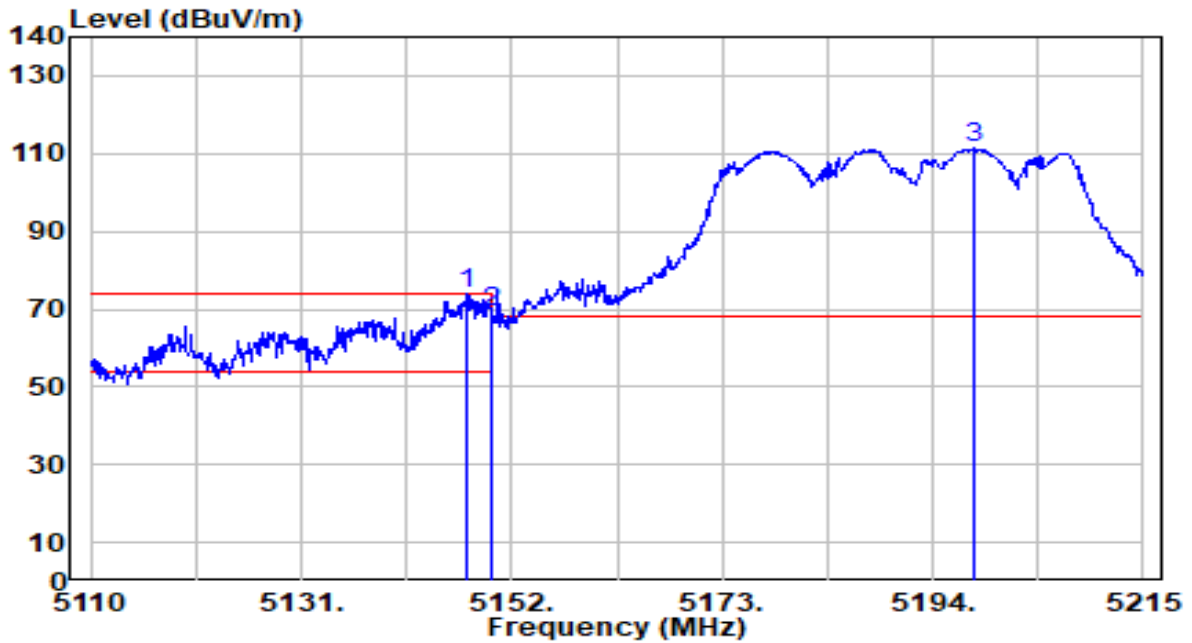

No	Frequency (MHz)	Reading (dBuV)	C.F (dB/m)	Measurement (dBuV/m)	Margin (dB)	Limit (dBuV/m)	Height (cm)	Angle (deg)	Remark (QP/PK/AV)	
1	*	5147.590	74.61	-0.72	73.90	-0.10	74.00	177	200	Peak
2		5150.000	69.87	-0.72	69.15	-4.85	74.00	177	200	Peak
3		5198.200	111.99	-0.74	111.24	N/A	N/A	177	200	Peak

Note:

1. " *", means this data is the worst emission level.
2. C.F (Correction Factor) = Antenna Factor (dB/m)+ Cable Loss (dB) – Preamplifier(dB) + 10dB Attenuation.
3. Measurement (dBuV/m) = Reading(dBuV) + C.F (Correction Factor).
4. The emission levels of other frequencies are very lower than the limit and not show in test report.

EUT	AX1800 Indoor/Outdoor Wi-Fi 6 Access Point	Date of Test	2023-09-21
Factor	DRH18-E	Temp. / Humidity	20°C /60%
Polarity	Vertical	Site / Test Engineer	AC2 / Marvin
Test Mode	802.11ac-40MHz_Band1_TX_CH 38_ANT 0+1	Test Voltage	AC120V/60Hz

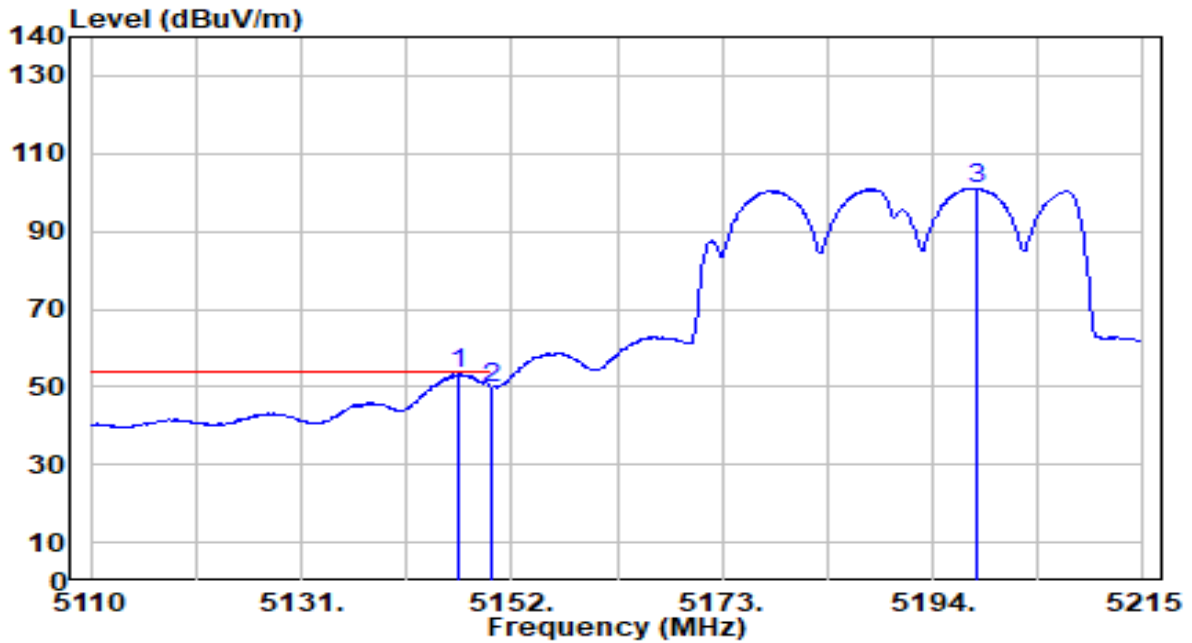

No	Frequency (MHz)	Reading (dBuV)	C.F (dB/m)	Measurement (dBuV/m)	Margin (dB)	Limit (dBuV/m)	Height (cm)	Angle (deg)	Remark (QP/PK/AV)
1	*	54.04	-0.72	53.33	-0.67	54.00	177	200	Average
2		50.62	-0.72	49.90	-4.10	54.00	177	200	Average
3		101.88	-0.74	101.13	N/A	N/A	177	200	Average

Note:

1. " *", means this data is the worst emission level.
2. C.F (Correction Factor) = Antenna Factor (dB/m)+ Cable Loss (dB) – Preamplifier(dB) + 10dB Attenuation.
3. Measurement (dBuV/m) = Reading(dBuV) + C.F (Correction Factor).
4. The emission levels of other frequencies are very lower than the limit and not show in test report.

EUT	AX1800 Indoor/Outdoor Wi-Fi 6 Access Point	Date of Test	2023-09-21
Factor	DRH18-E	Temp. / Humidity	20°C /60%
Polarity	Horizontal	Site / Test Engineer	AC2 / Marvin
Test Mode	802.11ac-40MHz_Band2_TX_CH 62_ANT 0+1	Test Voltage	AC120V/60Hz

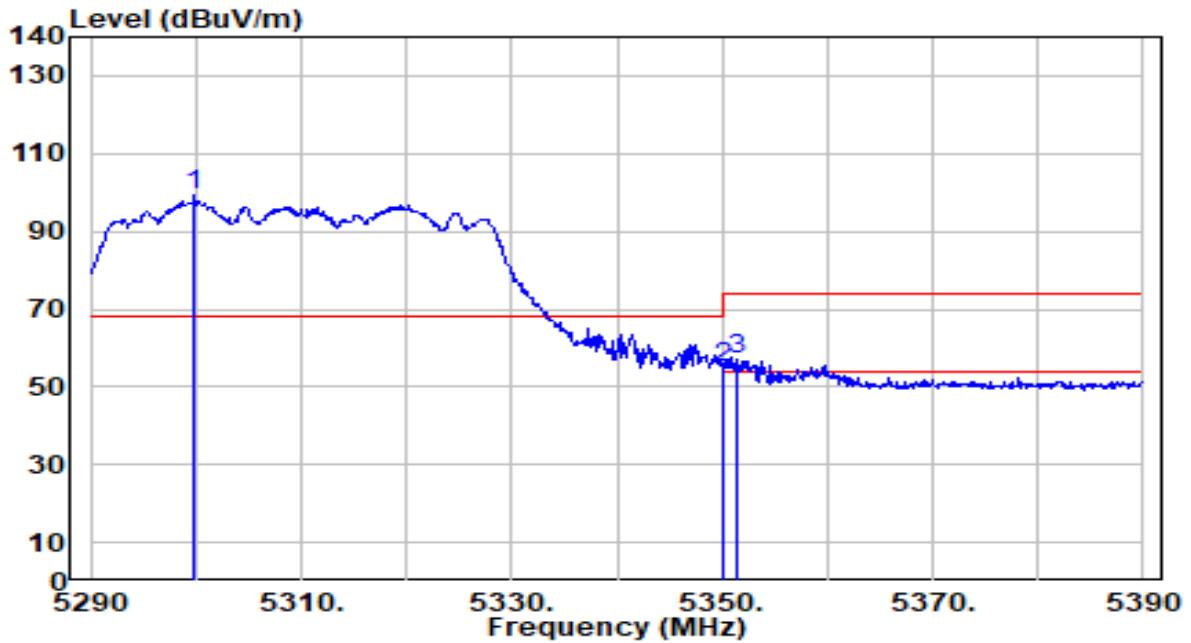

No	Frequency (MHz)	Reading (dBuV)	C.F (dB/m)	Measurement (dBuV/m)	Margin (dB)	Limit (dBuV/m)	Height (cm)	Angle (deg)	Remark (QP/PK/AV)
1	5299.800	99.97	-0.90	99.07	N/A	N/A	203	58	Peak
2	5350.000	55.86	-0.97	54.89	-19.11	74.00	203	58	Peak
3	* 5351.400	57.91	-0.97	56.94	-17.06	74.00	203	58	Peak

Note:

1. " *", means this data is the worst emission level.
2. C.F (Correction Factor) = Antenna Factor (dB/m)+ Cable Loss (dB) – Preamplifier(dB) + 10dB Attenuation.
3. Measurement (dBuV/m) = Reading(dBuV) + C.F (Correction Factor).
4. The emission levels of other frequencies are very lower than the limit and not show in test report.

EUT	AX1800 Indoor/Outdoor Wi-Fi 6 Access Point	Date of Test	2023-09-21
Factor	DRH18-E	Temp. / Humidity	20°C /60%
Polarity	Horizontal	Site / Test Engineer	AC2 / Marvin
Test Mode	802.11ac-40MHz_Band2_TX_CH 62_ANT 0+1	Test Voltage	AC120V/60Hz

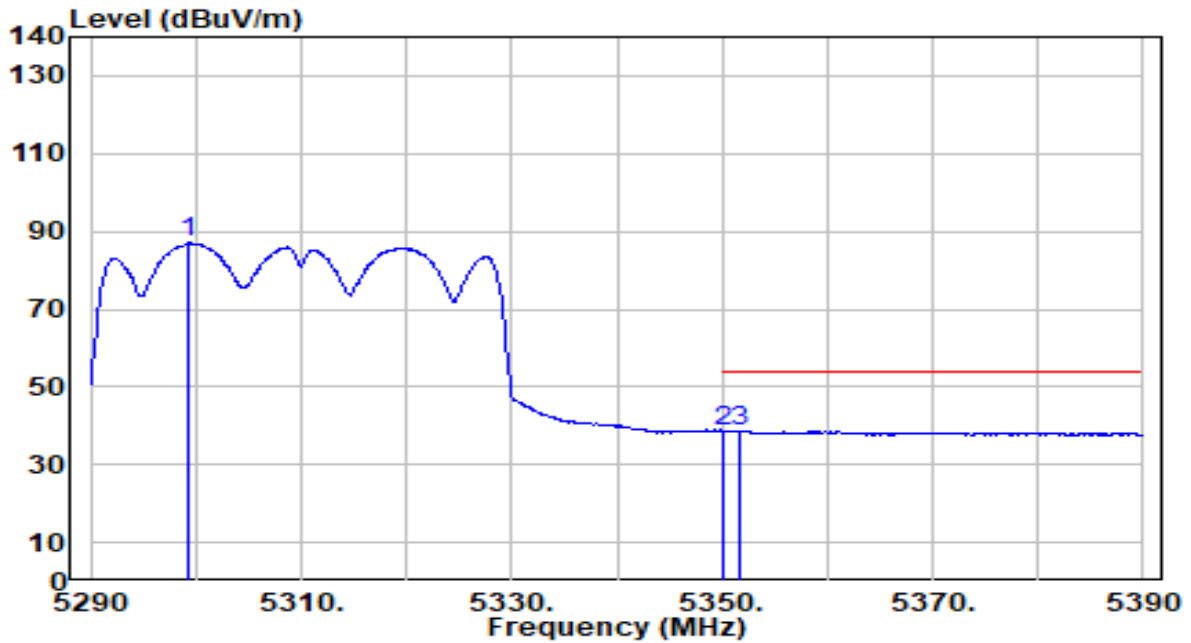

No	Frequency (MHz)	Reading (dBuV)	C.F (dB/m)	Measurement (dBuV/m)	Margin (dB)	Limit (dBuV/m)	Height (cm)	Angle (deg)	Remark (QP/PK/AV)
1	5299.300	87.91	-0.89	87.02	N/A	N/A	203	58	Average
2	* 5350.000	39.76	-0.97	38.78	-15.22	54.00	203	58	Average
3	5351.700	39.65	-0.97	38.68	-15.32	54.00	203	58	Average

Note:

1. " *", means this data is the worst emission level.
2. C.F (Correction Factor) = Antenna Factor (dB/m)+ Cable Loss (dB) – Preamplifier(dB) + 10dB Attenuation.
3. Measurement (dBuV/m) = Reading(dBuV) + C.F (Correction Factor).
4. The emission levels of other frequencies are very lower than the limit and not show in test report.

EUT	AX1800 Indoor/Outdoor Wi-Fi 6 Access Point	Date of Test	2023-09-21
Factor	DRH18-E	Temp. / Humidity	20°C /60%
Polarity	Vertical	Site / Test Engineer	AC2 / Marvin
Test Mode	802.11ac-40MHz_Band2_TX_CH 62_ANT 0+1	Test Voltage	AC120V/60Hz

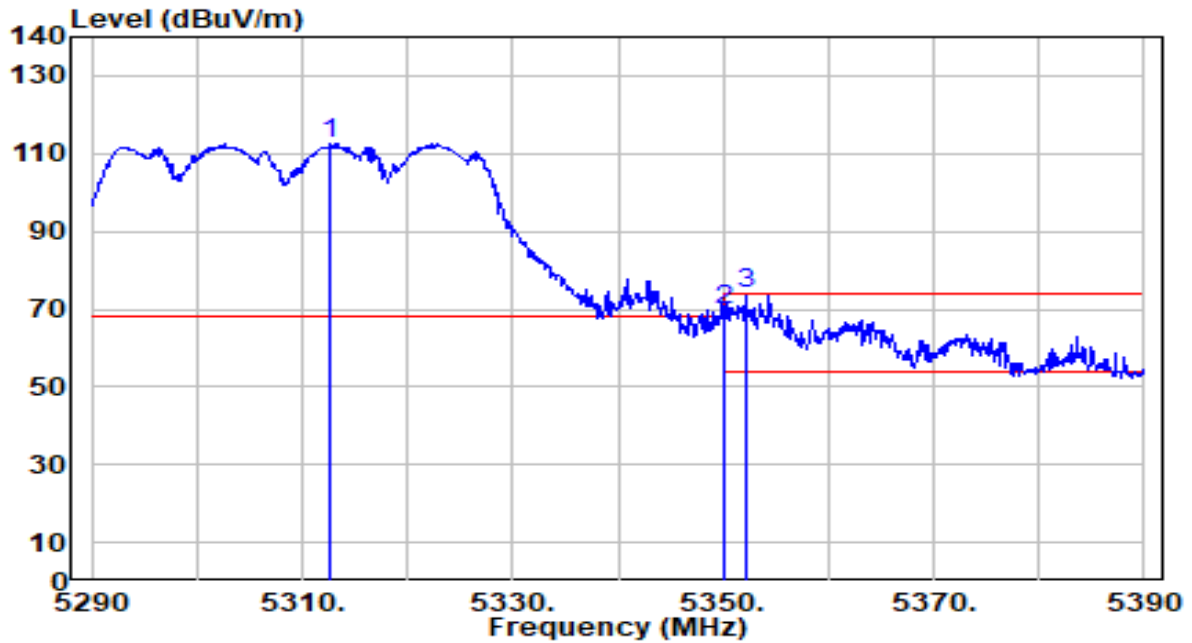

No	Frequency (MHz)	Reading (dBuV)	C.F (dB/m)	Measurement (dBuV/m)	Margin (dB)	Limit (dBuV/m)	Height (cm)	Angle (deg)	Remark (QP/PK/AV)
1	5312.700	113.57	-0.92	112.65	N/A	N/A	180	158	Peak
2	5350.000	70.86	-0.97	69.89	-4.11	74.00	180	158	Peak
3	* 5352.100	74.84	-0.98	73.87	-0.13	74.00	180	158	Peak

Note:

1. " *", means this data is the worst emission level.
2. C.F (Correction Factor) = Antenna Factor (dB/m)+ Cable Loss (dB) – Preamplifier(dB) + 10dB Attenuation.
3. Measurement (dBuV/m) = Reading(dBuV) + C.F (Correction Factor).
4. The emission levels of other frequencies are very lower than the limit and not show in test report.

EUT	AX1800 Indoor/Outdoor Wi-Fi 6 Access Point	Date of Test	2023-09-21
Factor	DRH18-E	Temp. / Humidity	20°C /60%
Polarity	Vertical	Site / Test Engineer	AC2 / Marvin
Test Mode	802.11ac-40MHz_Band2_TX_CH 62_ANT 0+1	Test Voltage	AC120V/60Hz

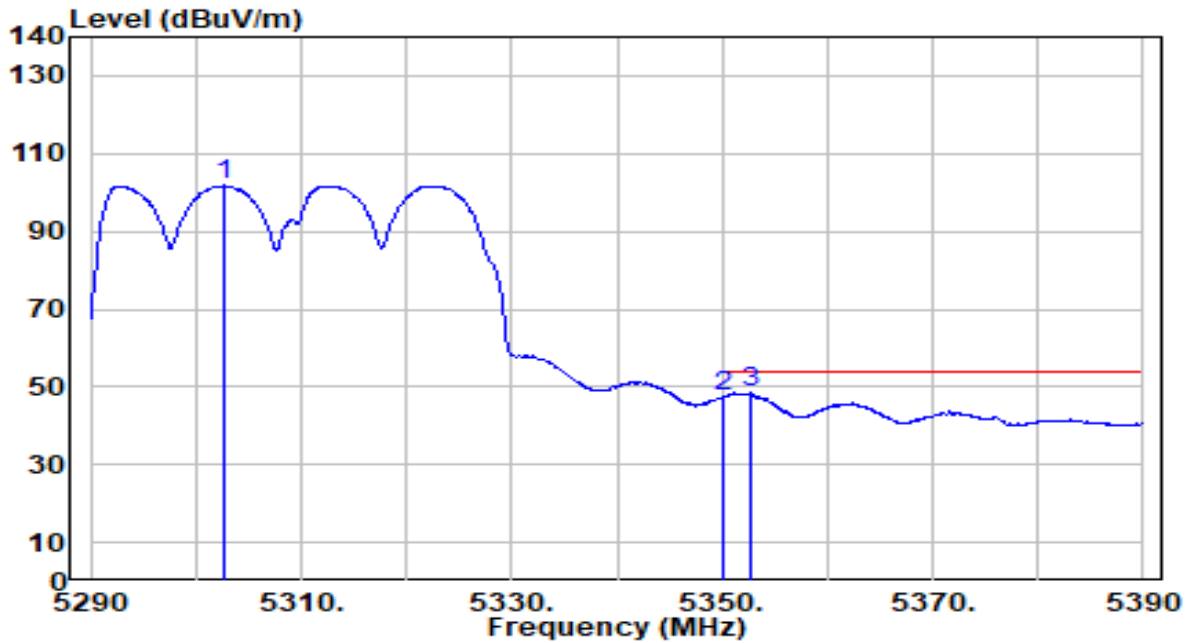

No	Frequency (MHz)	Reading (dBuV)	C.F (dB/m)	Measurement (dBuV/m)	Margin (dB)	Limit (dBuV/m)	Height (cm)	Angle (deg)	Remark (QP/PK/AV)
1	5302.700	102.62	-0.90	101.72	N/A	N/A	180	158	Average
2	5350.000	48.41	-0.97	47.44	-6.56	54.00	180	158	Average
3	* 5352.700	49.44	-0.98	48.46	-5.54	54.00	180	158	Average

Note:

1. " *", means this data is the worst emission level.
2. C.F (Correction Factor) = Antenna Factor (dB/m)+ Cable Loss (dB) – Preamplifier(dB) + 10dB Attenuation.
3. Measurement (dBuV/m) = Reading(dBuV) + C.F (Correction Factor).
4. The emission levels of other frequencies are very lower than the limit and not show in test report.

EUT	AX1800 Indoor/Outdoor Wi-Fi 6 Access Point	Date of Test	2023-09-21
Factor	DRH18-E	Temp. / Humidity	20°C /60%
Polarity	Horizontal	Site / Test Engineer	AC2 / Marvin
Test Mode	802.11ac-40MHz_Band3_TX_CH 102_ANT 0+1	Test Voltage	AC120V/60Hz

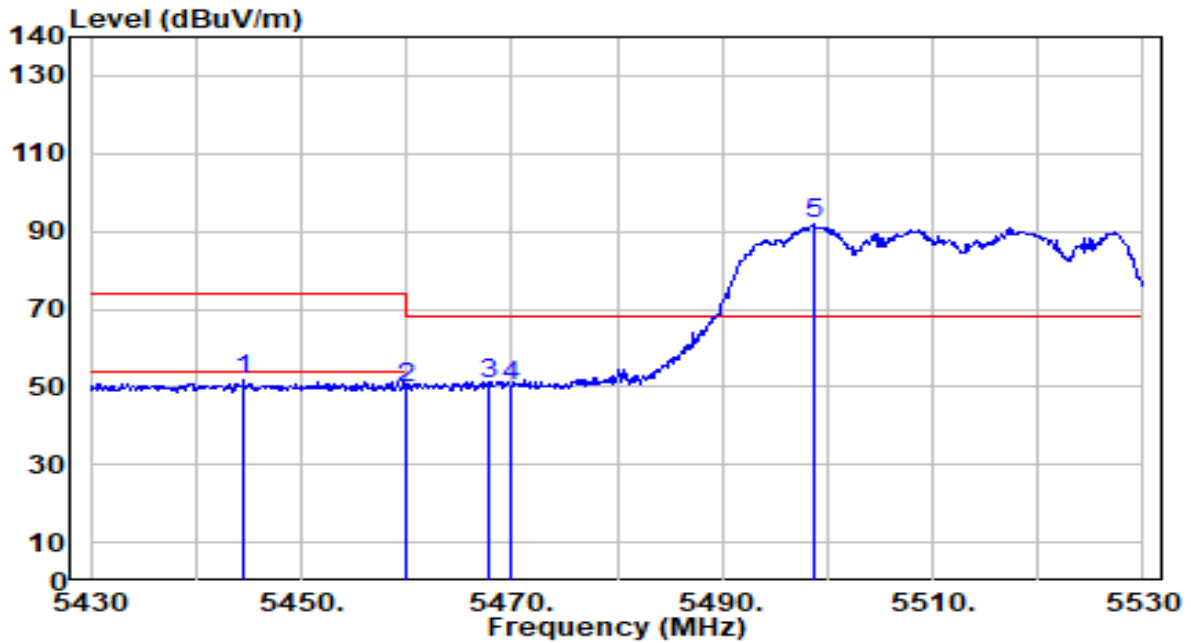

No	Frequency (MHz)	Reading (dBuV)	C.F (dB/m)	Measurement (dBuV/m)	Margin (dB)	Limit (dBuV/m)	Height (cm)	Angle (deg)	Remark (QP/PK/AV)
1	5444.500	52.47	-0.92	51.55	-22.45	74.00	219	66	Peak
2	5460.000	50.61	-0.87	49.74	-24.26	74.00	219	66	Peak
3	* 5467.700	51.40	-0.85	50.56	-17.64	68.20	219	66	Peak
4	5470.000	51.25	-0.84	50.41	-17.79	68.20	219	66	Peak
5	5498.800	92.88	-0.75	92.13	N/A	N/A	219	66	Peak

Note:

1. " *", means this data is the worst emission level.
2. C.F (Correction Factor) = Antenna Factor (dB/m)+ Cable Loss (dB) – Preamplifier(dB) + 10dB Attenuation.
3. Measurement (dBuV/m) = Reading(dBuV) + C.F (Correction Factor).
4. The emission levels of other frequencies are very lower than the limit and not show in test report.

EUT	AX1800 Indoor/Outdoor Wi-Fi 6 Access Point	Date of Test	2023-09-21
Factor	DRH18-E	Temp. / Humidity	20°C /60%
Polarity	Horizontal	Site / Test Engineer	AC2 / Marvin
Test Mode	802.11ac-40MHz_Band3_TX_CH 102_ANT 0+1	Test Voltage	AC120V/60Hz

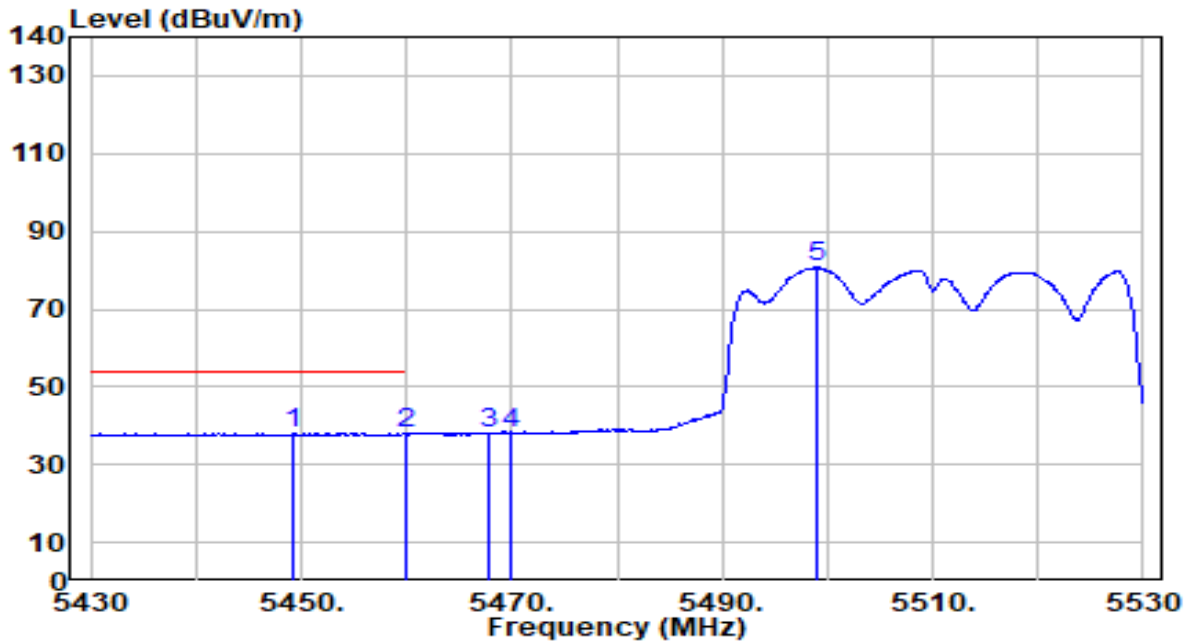

No	Frequency (MHz)	Reading (dBuV)	C.F (dB/m)	Measurement (dBuV/m)	Margin (dB)	Limit (dBuV/m)	Height (cm)	Angle (deg)	Remark (QP/PK/AV)
1	*	38.97	-0.90	38.07	-15.93	54.00	219	66	Average
2		38.71	-0.87	37.84	-16.16	54.00	219	66	Average
3		38.74	-0.85	37.89	N/A	N/A	219	66	Average
4		39.07	-0.84	38.23	N/A	N/A	219	66	Average
5		81.50	-0.75	80.75	N/A	N/A	219	66	Average

Note:

1. " *", means this data is the worst emission level.
2. C.F (Correction Factor) = Antenna Factor (dB/m)+ Cable Loss (dB) – Preamplifier(dB) + 10dB Attenuation.
3. Measurement (dBuV/m) = Reading(dBuV) + C.F (Correction Factor).
4. The emission levels of other frequencies are very lower than the limit and not show in test report.

EUT	AX1800 Indoor/Outdoor Wi-Fi 6 Access Point	Date of Test	2023-09-21
Factor	DRH18-E	Temp. / Humidity	20°C /60%
Polarity	Vertical	Site / Test Engineer	AC2 / Marvin
Test Mode	802.11ac-40MHz_Band3_TX_CH 102_ANT 0+1	Test Voltage	AC120V/60Hz

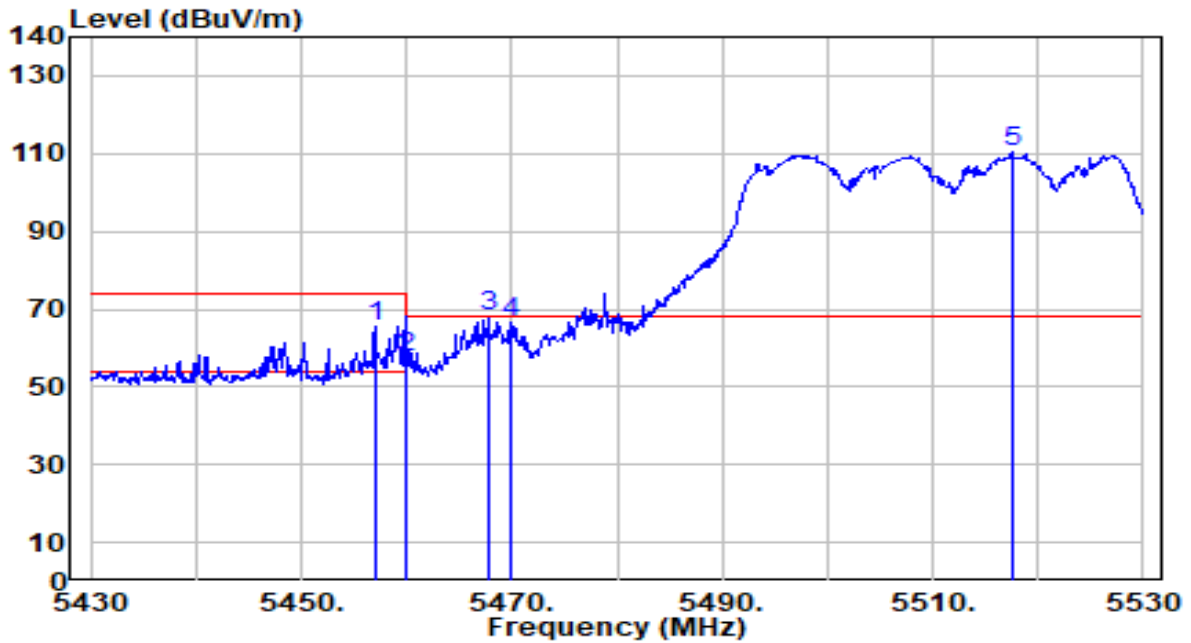

No	Frequency (MHz)	Reading (dBuV)	C.F (dB/m)	Measurement (dBuV/m)	Margin (dB)	Limit (dBuV/m)	Height (cm)	Angle (deg)	Remark (QP/PK/AV)
1	5457.000	66.46	-0.88	65.58	-8.42	74.00	178	148	Peak
2	5460.000	58.49	-0.87	57.62	-16.38	74.00	178	148	Peak
3	* 5467.700	68.92	-0.85	68.08	-0.12	68.20	178	148	Peak
4	5470.000	67.50	-0.84	66.66	-1.54	68.20	178	148	Peak
5	5517.500	110.86	-0.69	110.17	N/A	N/A	178	148	Peak

Note:

1. " *", means this data is the worst emission level.
2. C.F (Correction Factor) = Antenna Factor (dB/m)+ Cable Loss (dB) – Preamplifier(dB) + 10dB Attenuation.
3. Measurement (dBuV/m) = Reading(dBuV) + C.F (Correction Factor).
4. The emission levels of other frequencies are very lower than the limit and not show in test report.

EUT	AX1800 Indoor/Outdoor Wi-Fi 6 Access Point	Date of Test	2023-09-21
Factor	DRH18-E	Temp. / Humidity	20°C /60%
Polarity	Vertical	Site / Test Engineer	AC2 / Marvin
Test Mode	802.11ac-40MHz_Band3_TX_CH 102_ANT 0+1	Test Voltage	AC120V/60Hz

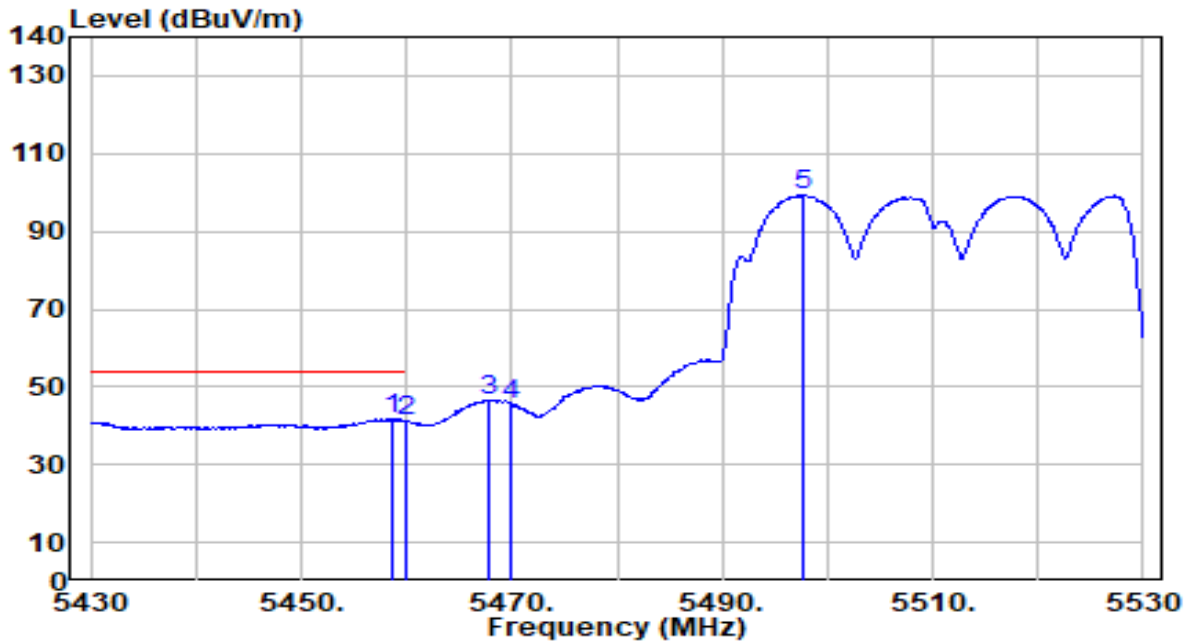

No	Frequency (MHz)	Reading (dBuV)	C.F (dB/m)	Measurement (dBuV/m)	Margin (dB)	Limit (dBuV/m)	Height (cm)	Angle (deg)	Remark (QP/PK/AV)
1	* 5458.700	42.52	-0.87	41.65	-12.35	54.00	178	148	Average
2	5460.000	42.06	-0.87	41.19	-12.81	54.00	178	148	Average
3	5467.700	47.10	-0.85	46.25	N/A	N/A	178	148	Average
4	5470.000	46.46	-0.84	45.62	N/A	N/A	178	148	Average
5	5497.800	99.99	-0.76	99.24	N/A	N/A	178	148	Average

Note:

1. " *", means this data is the worst emission level.
2. C.F (Correction Factor) = Antenna Factor (dB/m)+ Cable Loss (dB) – Preamplifier(dB) + 10dB Attenuation.
3. Measurement (dBuV/m) = Reading(dBuV) + C.F (Correction Factor).
4. The emission levels of other frequencies are very lower than the limit and not show in test report.

EUT	AX1800 Indoor/Outdoor Wi-Fi 6 Access Point	Date of Test	2023-09-21
Factor	DRH18-E	Temp. / Humidity	20°C /60%
Polarity	Horizontal	Site / Test Engineer	AC2 / Marvin
Test Mode	802.11ac-40MHz_Band3_TX_CH 134_ANT 0+1	Test Voltage	AC120V/60Hz

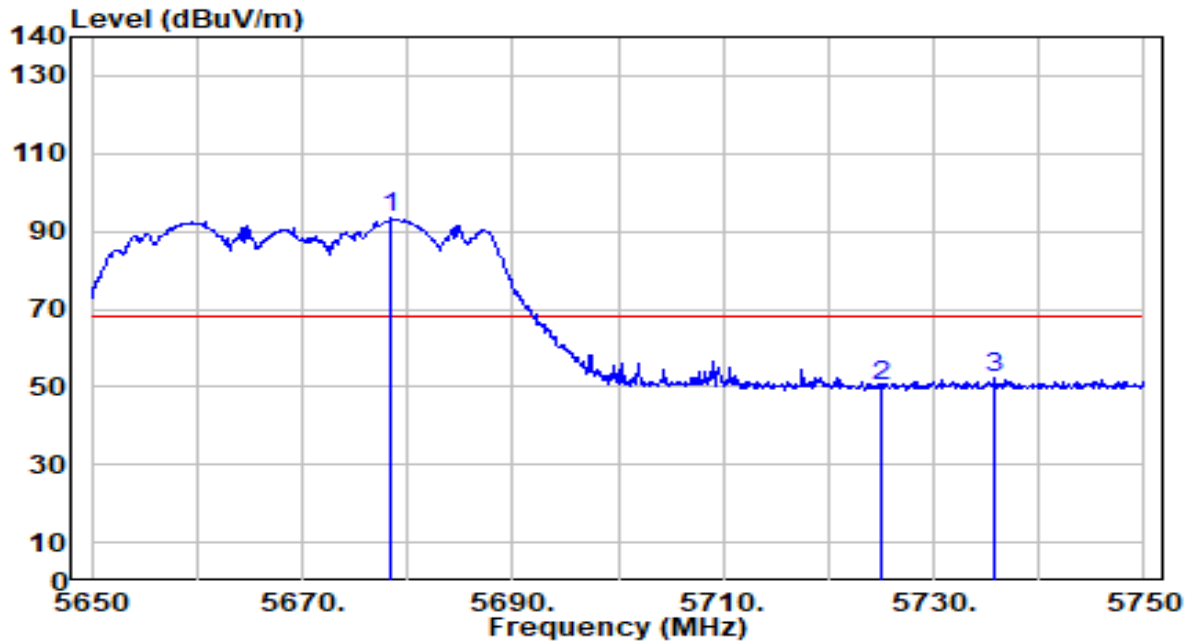

No	Frequency (MHz)	Reading (dBuV)	C.F (dB/m)	Measurement (dBuV/m)	Margin (dB)	Limit (dBuV/m)	Height (cm)	Angle (deg)	Remark (QP/PK/AV)
1	5678.500	93.46	-0.01	93.44	N/A	N/A	111	0	Peak
2	5725.000	49.97	0.23	50.20	-18.00	68.20	111	0	Peak
3	* 5735.800	51.86	0.29	52.14	-16.06	68.20	111	0	Peak

Note:

1. " *", means this data is the worst emission level.
2. C.F (Correction Factor) = Antenna Factor (dB/m)+ Cable Loss (dB) – Preamplifier(dB) + 10dB Attenuation.
3. Measurement (dBuV/m) = Reading(dBuV) + C.F (Correction Factor).
4. The emission levels of other frequencies are very lower than the limit and not show in test report.

EUT	AX1800 Indoor/Outdoor Wi-Fi 6 Access Point	Date of Test	2023-09-21
Factor	DRH18-E	Temp. / Humidity	20°C /60%
Polarity	Vertical	Site / Test Engineer	AC2 / Marvin
Test Mode	802.11ac-40MHz_Band3_TX_CH 134_ANT 0+1	Test Voltage	AC120V/60Hz

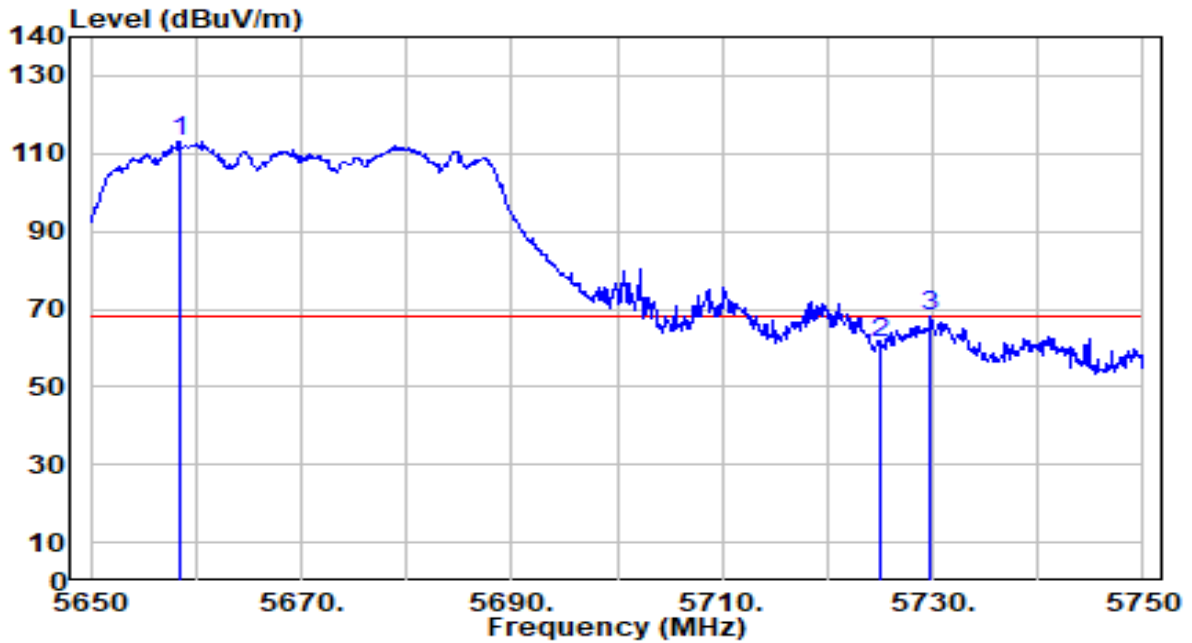

No	Frequency (MHz)	Reading (dBuV)	C.F (dB/m)	Measurement (dBuV/m)	Margin (dB)	Limit (dBuV/m)	Height (cm)	Angle (deg)	Remark (QP/PK/AV)
1	5658.400	112.98	-0.12	112.86	N/A	N/A	200	236	Peak
2	5725.000	61.31	0.23	61.54	-6.66	68.20	200	236	Peak
3	* 5729.800	67.83	0.25	68.08	-0.12	68.20	200	236	Peak

Note:

1. " *", means this data is the worst emission level.
2. C.F (Correction Factor) = Antenna Factor (dB/m)+ Cable Loss (dB) – Preamplifier(dB) + 10dB Attenuation.
3. Measurement (dBuV/m) = Reading(dBuV) + C.F (Correction Factor).
4. The emission levels of other frequencies are very lower than the limit and not show in test report.

EUT	AX1800 Indoor/Outdoor Wi-Fi 6 Access Point	Date of Test	2023-09-21
Factor	DRH18-E	Temp. / Humidity	20°C /60%
Polarity	Horizontal	Site / Test Engineer	AC2 / Marvin
Test Mode	802.11ac-40MHz_Band4_TX_CH 151_ANT 0+1	Test Voltage	AC120V/60Hz

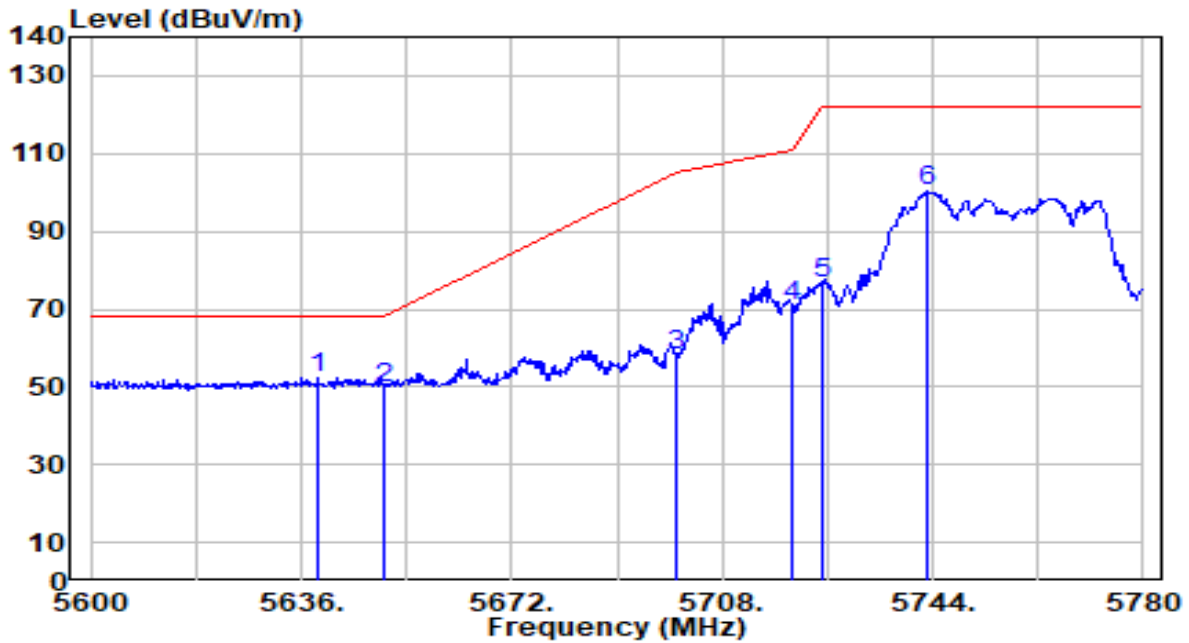

No	Frequency (MHz)	Reading (dBuV)	C.F (dB/m)	Measurement (dBuV/m)	Margin (dB)	Limit (dBuV/m)	Height (cm)	Angle (deg)	Remark (QP/PK/AV)	
1	*	5638.880	52.65	-0.22	52.42	-15.78	68.20	100	22	Peak
2		5650.000	50.05	-0.16	49.88	-18.32	68.20	100	22	Peak
3		5700.000	57.82	0.10	57.92	-47.28	105.20	100	22	Peak
4		5720.000	70.76	0.20	70.96	-39.84	110.80	100	22	Peak
5		5725.000	76.62	0.23	76.85	-45.35	122.20	100	22	Peak
6		5743.100	99.89	0.32	100.21	N/A	N/A	100	22	Peak

Note:

1. " *", means this data is the worst emission level.
2. C.F (Correction Factor) = Antenna Factor (dB/m)+ Cable Loss (dB) – Preamplifier(dB) + 10dB Attenuation.
3. Measurement (dBuV/m) = Reading(dBuV) + C.F (Correction Factor).
4. The emission levels of other frequencies are very lower than the limit and not show in test report.

EUT	AX1800 Indoor/Outdoor Wi-Fi 6 Access Point	Date of Test	2023-09-21
Factor	DRH18-E	Temp. / Humidity	20°C /60%
Polarity	Vertical	Site / Test Engineer	AC2 / Marvin
Test Mode	802.11ac-40MHz_Band4_TX_CH 151_ANT 0+1	Test Voltage	AC120V/60Hz

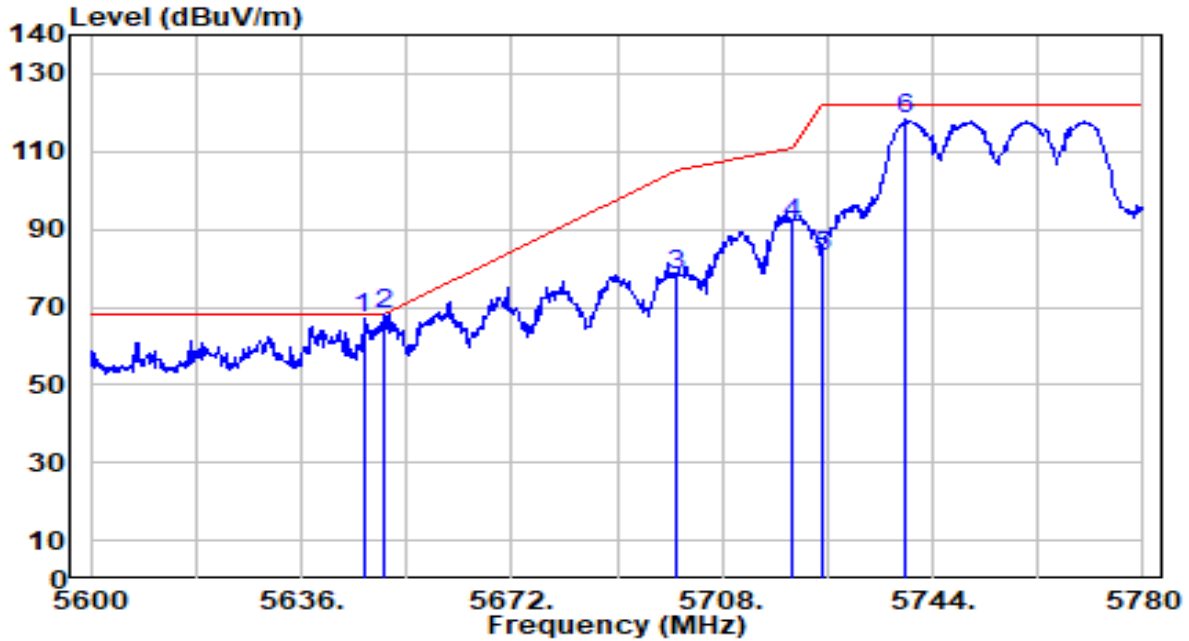

No	Frequency (MHz)	Reading (dBuV)	C.F (dB/m)	Measurement (dBuV/m)	Margin (dB)	Limit (dBuV/m)	Height (cm)	Angle (deg)	Remark (QP/PK/AV)
1	5646.620	67.04	-0.18	66.85	-1.35	68.20	184	350	Peak
2	* 5650.000	68.21	-0.16	68.04	-0.16	68.20	184	350	Peak
3	5700.000	78.14	0.10	78.24	-26.96	105.20	184	350	Peak
4	5720.000	91.30	0.20	91.50	-19.30	110.80	184	350	Peak
5	5725.000	82.63	0.23	82.86	-39.34	122.20	184	350	Peak
6	5739.320	118.02	0.30	118.32	N/A	N/A	184	350	Peak

Note:

1. " *", means this data is the worst emission level.
2. C.F (Correction Factor) = Antenna Factor (dB/m)+ Cable Loss (dB) – Preamplifier(dB) + 10dB Attenuation.
3. Measurement (dBuV/m) = Reading(dBuV) + C.F (Correction Factor).
4. The emission levels of other frequencies are very lower than the limit and not show in test report.

EUT	AX1800 Indoor/Outdoor Wi-Fi 6 Access Point	Date of Test	2023-09-21
Factor	DRH18-E	Temp. / Humidity	20°C /60%
Polarity	Horizontal	Site / Test Engineer	AC2 / Marvin
Test Mode	802.11ac-40MHz_Band4_TX_CH 159_ANT 0+1	Test Voltage	AC120V/60Hz

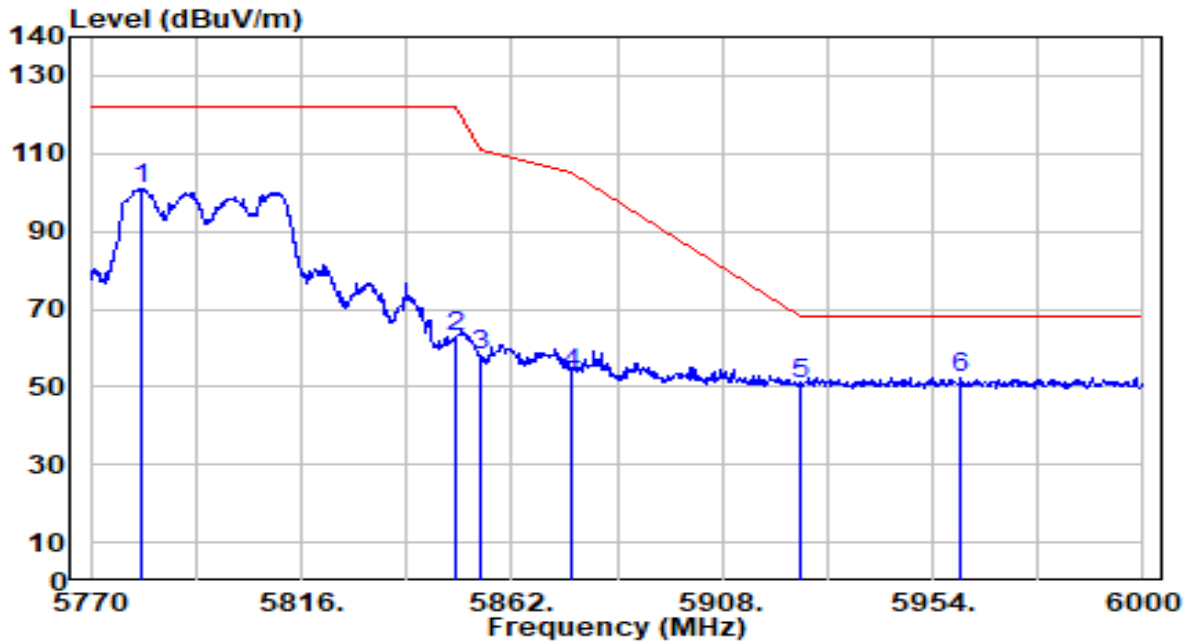

No	Frequency (MHz)	Reading (dBuV)	C.F (dB/m)	Measurement (dBuV/m)	Margin (dB)	Limit (dBuV/m)	Height (cm)	Angle (deg)	Remark (QP/PK/AV)
1	5781.040	100.39	0.52	100.91	N/A	N/A	200	30	Peak
2	5850.000	62.16	0.58	62.75	-59.45	122.20	200	30	Peak
3	5855.000	57.77	0.58	58.35	-52.45	110.80	200	30	Peak
4	5875.000	52.72	0.57	53.28	-51.92	105.20	200	30	Peak
5	5925.000	50.20	0.53	50.73	-17.47	68.20	200	30	Peak
6	* 5959.980	52.02	0.50	52.52	-15.68	68.20	200	30	Peak

Note:

1. " *", means this data is the worst emission level.
2. C.F (Correction Factor) = Antenna Factor (dB/m)+ Cable Loss (dB) – Preamplifier(dB) + 10dB Attenuation.
3. Measurement (dBuV/m) = Reading(dBuV) + C.F (Correction Factor).
4. The emission levels of other frequencies are very lower than the limit and not show in test report.

EUT	AX1800 Indoor/Outdoor Wi-Fi 6 Access Point	Date of Test	2023-09-21
Factor	DRH18-E	Temp. / Humidity	20°C /60%
Polarity	Vertical	Site / Test Engineer	AC2 / Marvin
Test Mode	802.11ac-40MHz_Band4_TX_CH 159_ANT 0+1	Test Voltage	AC120V/60Hz

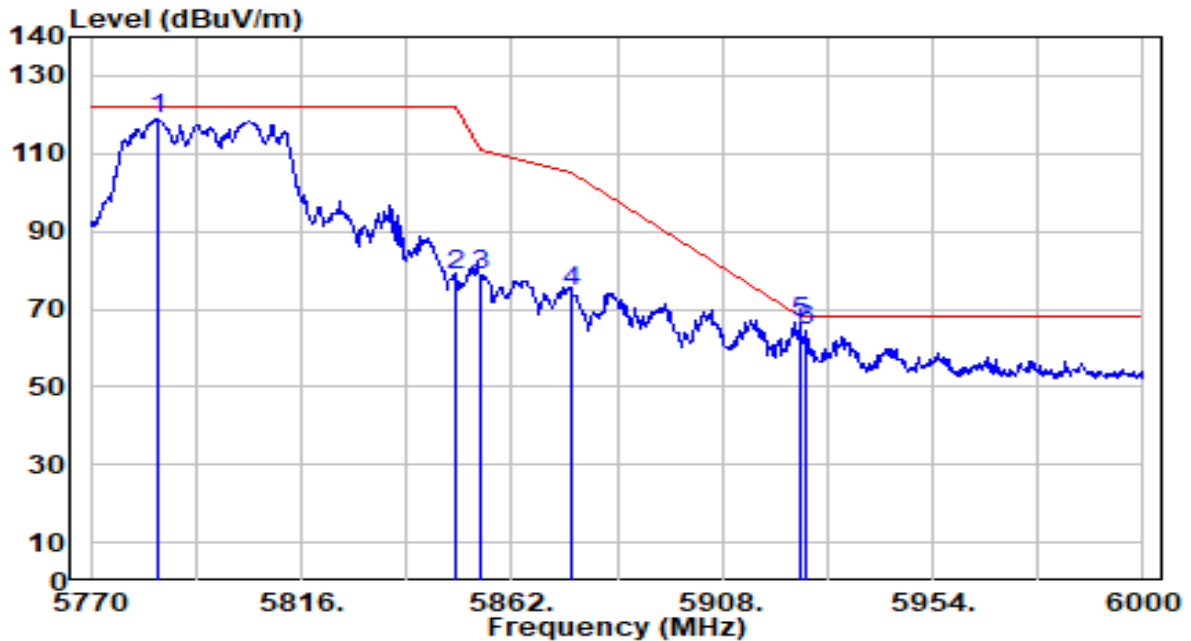

No	Frequency (MHz)	Reading (dBuV)	C.F (dB/m)	Measurement (dBuV/m)	Margin (dB)	Limit (dBuV/m)	Height (cm)	Angle (deg)	Remark (QP/PK/AV)
1	5784.720	118.36	0.54	118.90	N/A	N/A	186	352	Peak
2	5850.000	77.91	0.58	78.49	-43.71	122.20	186	352	Peak
3	5855.000	78.22	0.58	78.80	-32.00	110.80	186	352	Peak
4	5875.000	74.17	0.57	74.74	-30.46	105.20	186	352	Peak
5	* 5925.000	66.05	0.53	66.58	-1.62	68.20	186	352	Peak
6	5926.400	63.81	0.53	64.34	-3.86	68.20	186	352	Peak

Note:

1. " *", means this data is the worst emission level.
2. C.F (Correction Factor) = Antenna Factor (dB/m)+ Cable Loss (dB) – Preamplifier(dB) + 10dB Attenuation.
3. Measurement (dBuV/m) = Reading(dBuV) + C.F (Correction Factor).
4. The emission levels of other frequencies are very lower than the limit and not show in test report.

EUT	AX1800 Indoor/Outdoor Wi-Fi 6 Access Point	Date of Test	2023-09-21
Factor	DRH18-E	Temp. / Humidity	20°C /60%
Polarity	Horizontal	Site / Test Engineer	AC2 / Marvin
Test Mode	802.11ac-80MHz_Band1_TX_CH 42_ANT 0+1	Test Voltage	AC120V/60Hz

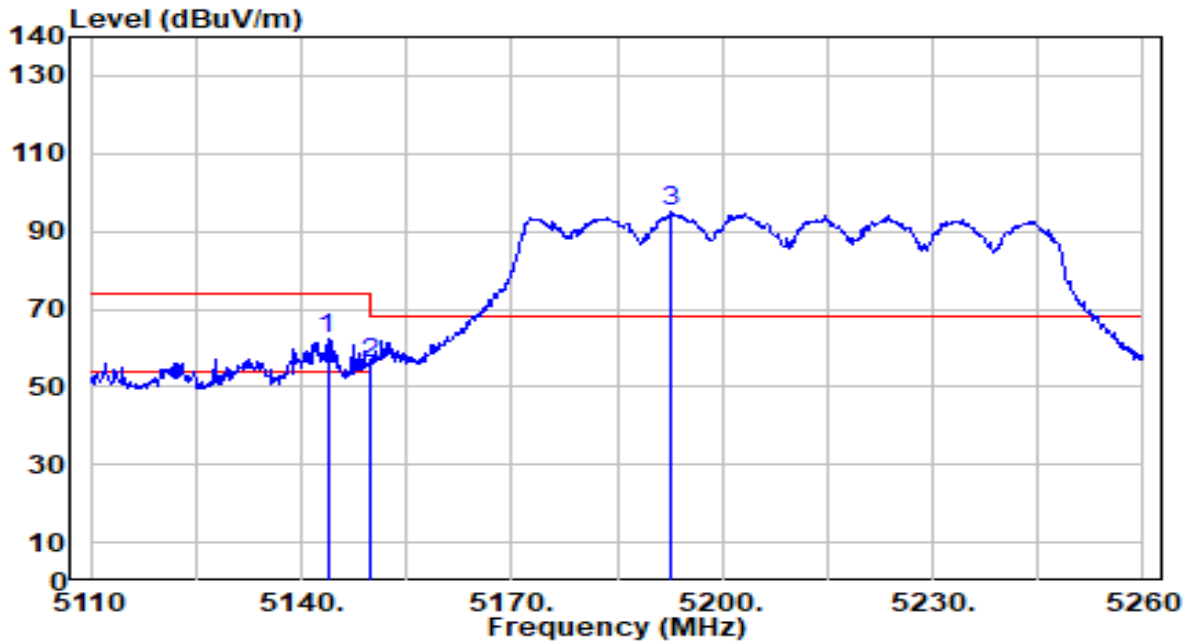

No	Frequency (MHz)	Reading (dBuV)	C.F (dB/m)	Measurement (dBuV/m)	Margin (dB)	Limit (dBuV/m)	Height (cm)	Angle (deg)	Remark (QP/PK/AV)	
1	*	5143.750	62.95	-0.71	62.23	-11.77	74.00	110	335	Peak
2		5150.000	56.75	-0.72	56.03	-17.97	74.00	110	335	Peak
3		5192.800	95.75	-0.74	95.01	N/A	N/A	110	335	Peak

Note:

1. " *", means this data is the worst emission level.
2. C.F (Correction Factor) = Antenna Factor (dB/m)+ Cable Loss (dB) – Preamplifier(dB) + 10dB Attenuation.
3. Measurement (dBuV/m) = Reading(dBuV) + C.F (Correction Factor).
4. The emission levels of other frequencies are very lower than the limit and not show in test report.

EUT	AX1800 Indoor/Outdoor Wi-Fi 6 Access Point	Date of Test	2023-09-21
Factor	DRH18-E	Temp. / Humidity	20°C /60%
Polarity	Horizontal	Site / Test Engineer	AC2 / Marvin
Test Mode	802.11ac-80MHz_Band1_TX_CH 42_ANT 0+1	Test Voltage	AC120V/60Hz

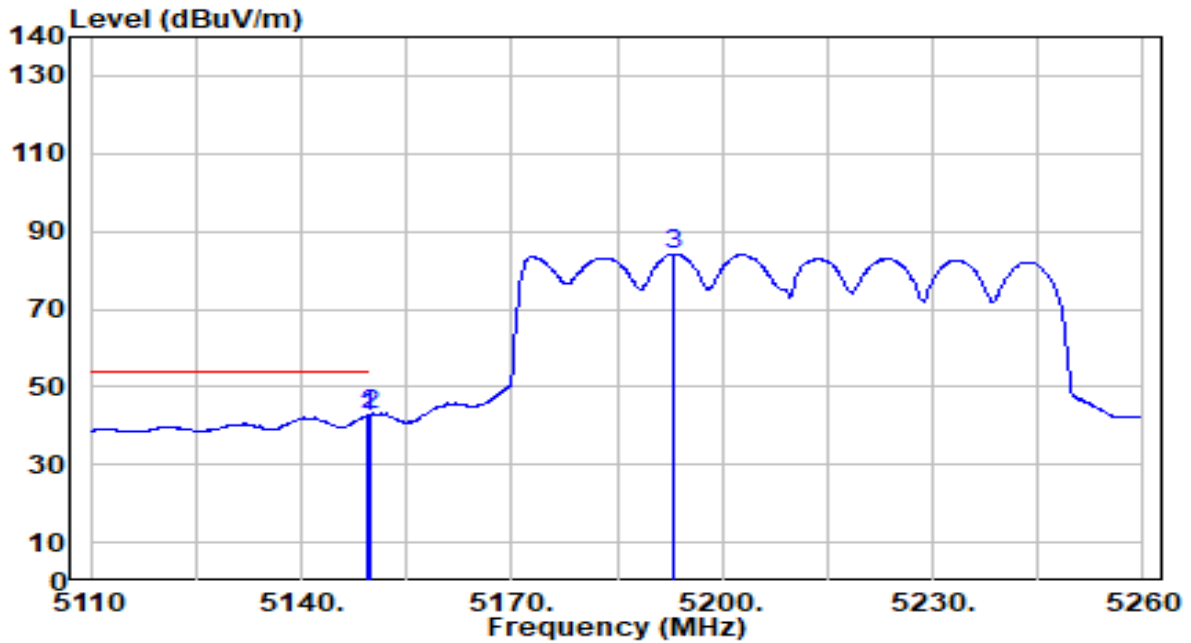

No	Frequency (MHz)	Reading (dBuV)	C.F (dB/m)	Measurement (dBuV/m)	Margin (dB)	Limit (dBuV/m)	Height (cm)	Angle (deg)	Remark (QP/PK/AV)
1	5149.450	43.14	-0.72	42.42	-11.58	54.00	110	335	Average
2	* 5150.000	43.56	-0.72	42.84	-11.16	54.00	110	335	Average
3	5193.100	84.99	-0.74	84.25	N/A	N/A	110	335	Average

Note:

1. " *", means this data is the worst emission level.
2. C.F (Correction Factor) = Antenna Factor (dB/m)+ Cable Loss (dB) – Preamplifier(dB) + 10dB Attenuation.
3. Measurement (dBuV/m) = Reading(dBuV) + C.F (Correction Factor).
4. The emission levels of other frequencies are very lower than the limit and not show in test report.

EUT	AX1800 Indoor/Outdoor Wi-Fi 6 Access Point	Date of Test	2023-09-21
Factor	DRH18-E	Temp. / Humidity	20°C /60%
Polarity	Vertical	Site / Test Engineer	AC2 / Marvin
Test Mode	802.11ac-80MHz_Band1_TX_CH 42_ANT 0+1	Test Voltage	AC120V/60Hz

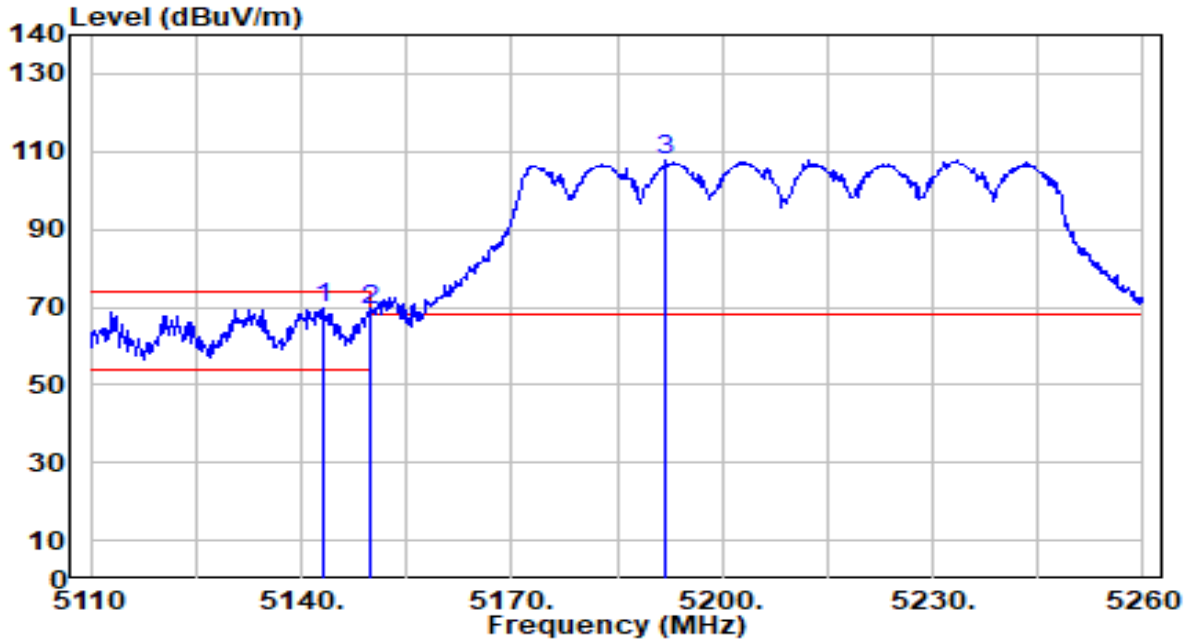

No	Frequency (MHz)	Reading (dBuV)	C.F (dB/m)	Measurement (dBuV/m)	Margin (dB)	Limit (dBuV/m)	Height (cm)	Angle (deg)	Remark (QP/PK/AV)	
1	*	5143.000	70.23	-0.71	69.52	-4.48	74.00	172	200	Peak
2		5150.000	69.80	-0.72	69.09	-4.91	74.00	172	200	Peak
3		5192.050	108.50	-0.74	107.76	N/A	N/A	172	200	Peak

Note:

1. " *", means this data is the worst emission level.
2. C.F (Correction Factor) = Antenna Factor (dB/m)+ Cable Loss (dB) – Preamplifier(dB) + 10dB Attenuation.
3. Measurement (dBuV/m) = Reading(dBuV) + C.F (Correction Factor).
4. The emission levels of other frequencies are very lower than the limit and not show in test report.

EUT	AX1800 Indoor/Outdoor Wi-Fi 6 Access Point	Date of Test	2023-09-21
Factor	DRH18-E	Temp. / Humidity	20°C /60%
Polarity	Vertical	Site / Test Engineer	AC2 / Marvin
Test Mode	802.11ac-80MHz_Band1_TX_CH 42_ANT 0+1	Test Voltage	AC120V/60Hz

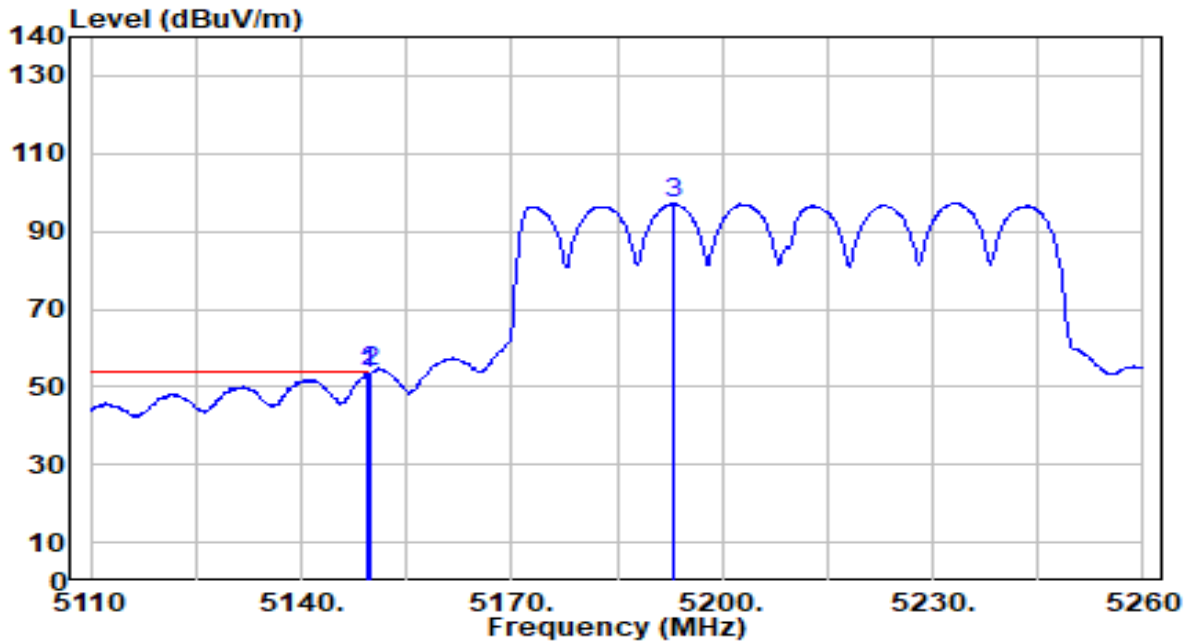

No	Frequency (MHz)	Reading (dBuV)	C.F (dB/m)	Measurement (dBuV/m)	Margin (dB)	Limit (dBuV/m)	Height (cm)	Angle (deg)	Remark (QP/PK/AV)
1	5149.450	53.86	-0.72	53.14	-0.86	54.00	172	200	Average
2	* 5150.000	54.56	-0.72	53.85	-0.15	54.00	172	200	Average
3	5192.950	97.96	-0.74	97.22	N/A	N/A	172	200	Average

Note:

1. " *", means this data is the worst emission level.
2. C.F (Correction Factor) = Antenna Factor (dB/m)+ Cable Loss (dB) – Preamplifier(dB) + 10dB Attenuation.
3. Measurement (dBuV/m) = Reading(dBuV) + C.F (Correction Factor).
4. The emission levels of other frequencies are very lower than the limit and not show in test report.

EUT	AX1800 Indoor/Outdoor Wi-Fi 6 Access Point	Date of Test	2023-09-21
Factor	DRH18-E	Temp. / Humidity	20°C /60%
Polarity	Horizontal	Site / Test Engineer	AC2 / Marvin
Test Mode	802.11ac-80MHz_Band2_TX_CH 58_ANT 0+1	Test Voltage	AC120V/60Hz

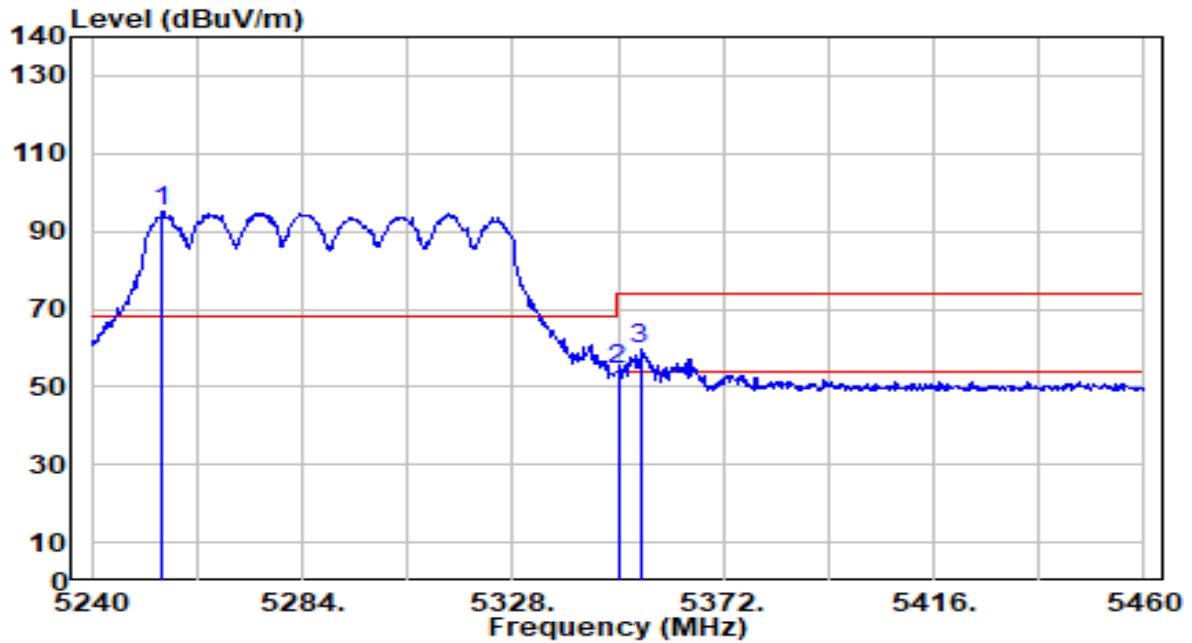

No	Frequency (MHz)	Reading (dBuV)	C.F (dB/m)	Measurement (dBuV/m)	Margin (dB)	Limit (dBuV/m)	Height (cm)	Angle (deg)	Remark (QP/PK/AV)
1	5254.740	95.82	-0.83	94.99	N/A	N/A	211	58	Peak
2	5350.000	55.44	-0.97	54.47	-19.53	74.00	211	58	Peak
3	* 5354.620	60.57	-0.98	59.59	-14.41	74.00	211	58	Peak

Note:

1. " *", means this data is the worst emission level.
2. C.F (Correction Factor) = Antenna Factor (dB/m)+ Cable Loss (dB) – Preamplifier(dB) + 10dB Attenuation.
3. Measurement (dBuV/m) = Reading(dBuV) + C.F (Correction Factor).
4. The emission levels of other frequencies are very lower than the limit and not show in test report.

EUT	AX1800 Indoor/Outdoor Wi-Fi 6 Access Point	Date of Test	2023-09-21
Factor	DRH18-E	Temp. / Humidity	20°C /60%
Polarity	Horizontal	Site / Test Engineer	AC2 / Marvin
Test Mode	802.11ac-80MHz_Band2_TX_CH 58_ANT 0+1	Test Voltage	AC120V/60Hz

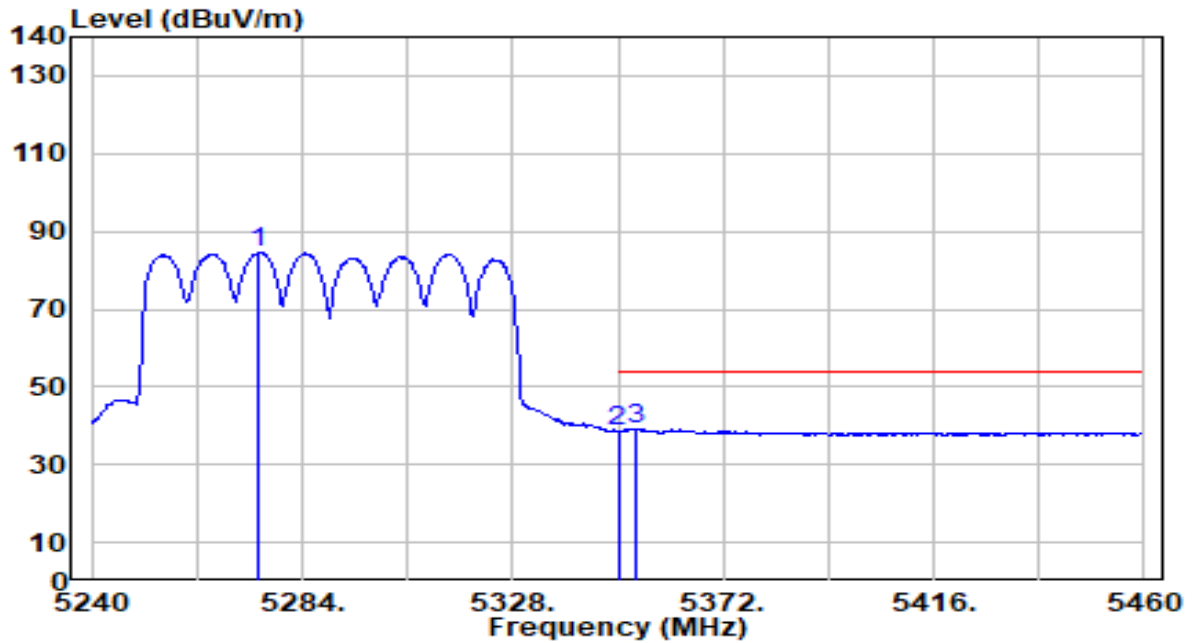

No	Frequency (MHz)	Reading (dBuV)	C.F (dB/m)	Measurement (dBuV/m)	Margin (dB)	Limit (dBuV/m)	Height (cm)	Angle (deg)	Remark (QP/PK/AV)
1	5274.980	85.30	-0.86	84.44	N/A	N/A	211	58	Average
2	5350.000	39.60	-0.97	38.62	-15.38	54.00	211	58	Average
3	* 5353.740	40.18	-0.98	39.20	-14.80	54.00	211	58	Average

Note:

1. " *", means this data is the worst emission level.
2. C.F (Correction Factor) = Antenna Factor (dB/m)+ Cable Loss (dB) – Preamplifier(dB) + 10dB Attenuation.
3. Measurement (dBuV/m) = Reading(dBuV) + C.F (Correction Factor).
4. The emission levels of other frequencies are very lower than the limit and not show in test report.

EUT	AX1800 Indoor/Outdoor Wi-Fi 6 Access Point	Date of Test	2023-09-21
Factor	DRH18-E	Temp. / Humidity	20°C /60%
Polarity	Vertical	Site / Test Engineer	AC2 / Marvin
Test Mode	802.11ac-80MHz_Band2_TX_CH 58_ANT 0+1	Test Voltage	AC120V/60Hz

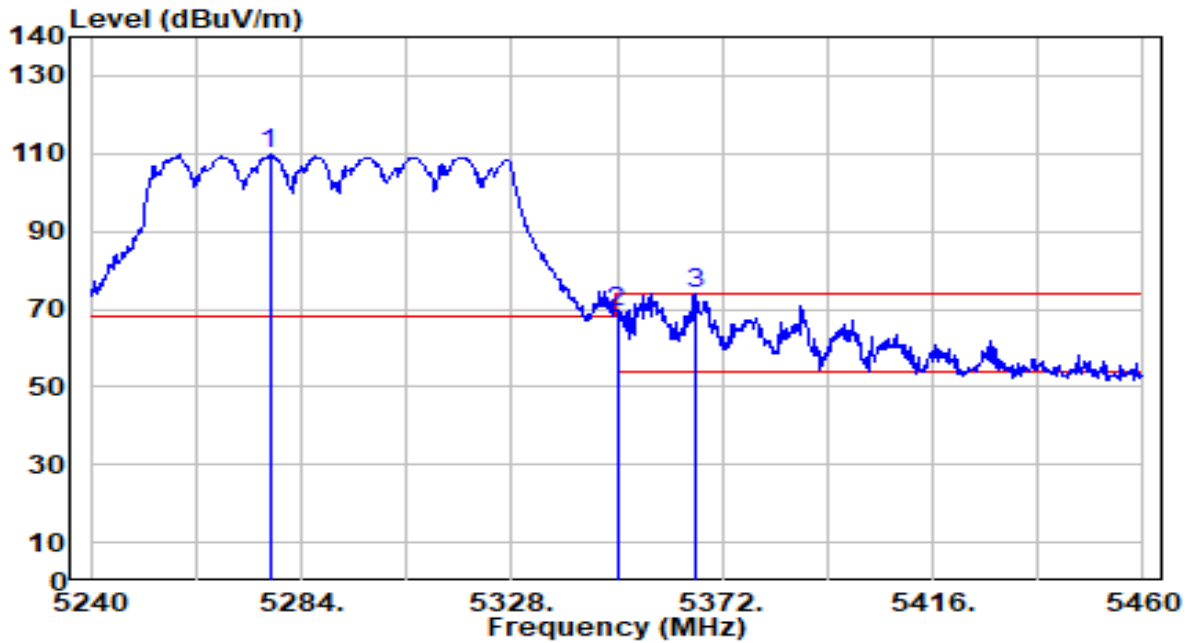

No	Frequency (MHz)	Reading (dBuV)	C.F (dB/m)	Measurement (dBuV/m)	Margin (dB)	Limit (dBuV/m)	Height (cm)	Angle (deg)	Remark (QP/PK/AV)
1	5277.400	110.75	-0.86	109.89	N/A	N/A	180	158	Peak
2	5350.000	70.05	-0.97	69.08	-4.92	74.00	180	158	Peak
3	* 5366.280	74.87	-1.00	73.87	-0.13	74.00	180	158	Peak

Note:

1. " *", means this data is the worst emission level.
2. C.F (Correction Factor) = Antenna Factor (dB/m)+ Cable Loss (dB) – Preamplifier(dB) + 10dB Attenuation.
3. Measurement (dBuV/m) = Reading(dBuV) + C.F (Correction Factor).
4. The emission levels of other frequencies are very lower than the limit and not show in test report.

EUT	AX1800 Indoor/Outdoor Wi-Fi 6 Access Point	Date of Test	2023-09-21
Factor	DRH18-E	Temp. / Humidity	20°C /60%
Polarity	Vertical	Site / Test Engineer	AC2 / Marvin
Test Mode	802.11ac-80MHz_Band2_TX_CH 58_ANT 0+1	Test Voltage	AC120V/60Hz

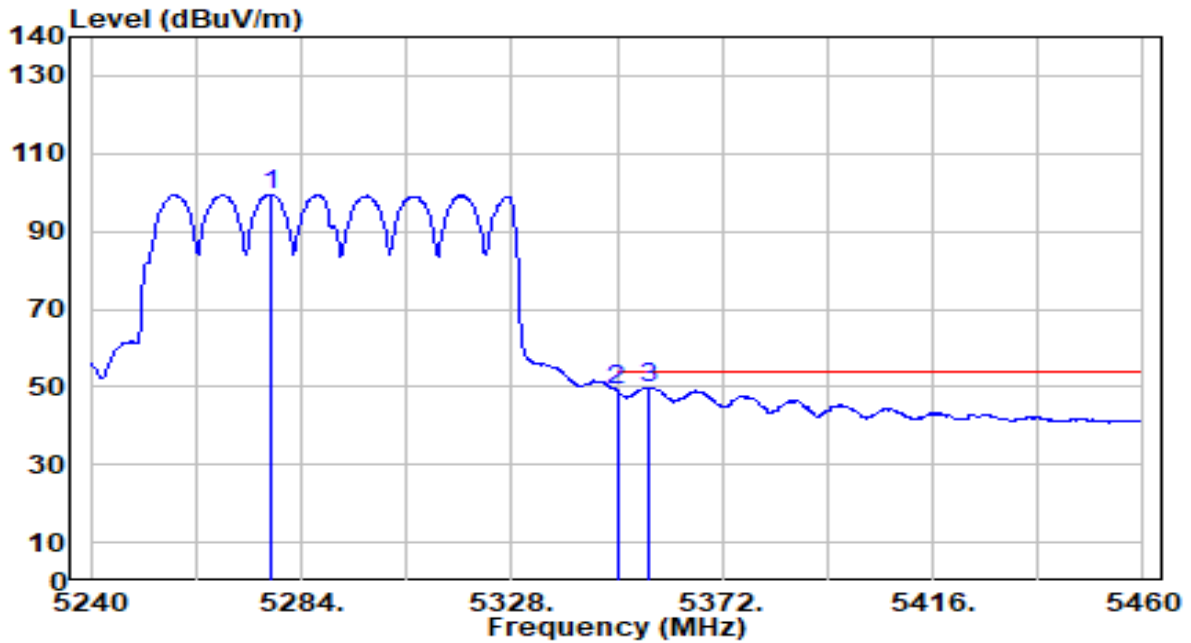

No	Frequency (MHz)	Reading (dBuV)	C.F (dB/m)	Measurement (dBuV/m)	Margin (dB)	Limit (dBuV/m)	Height (cm)	Angle (deg)	Remark (QP/PK/AV)
1	5277.620	100.40	-0.86	99.54	N/A	N/A	180	158	Average
2	5350.000	49.95	-0.97	48.98	-5.02	54.00	180	158	Average
3	* 5356.600	50.89	-0.98	49.91	-4.09	54.00	180	158	Average

Note:

1. " *", means this data is the worst emission level.
2. C.F (Correction Factor) = Antenna Factor (dB/m)+ Cable Loss (dB) – Preamplifier(dB) + 10dB Attenuation.
3. Measurement (dBuV/m) = Reading(dBuV) + C.F (Correction Factor).
4. The emission levels of other frequencies are very lower than the limit and not show in test report.

EUT	AX1800 Indoor/Outdoor Wi-Fi 6 Access Point	Date of Test	2023-09-21
Factor	DRH18-E	Temp. / Humidity	20°C /60%
Polarity	Horizontal	Site / Test Engineer	AC2 / Marvin
Test Mode	802.11ac-80MHz_Band3_TX_CH 106_ANT 0+1	Test Voltage	AC120V/60Hz

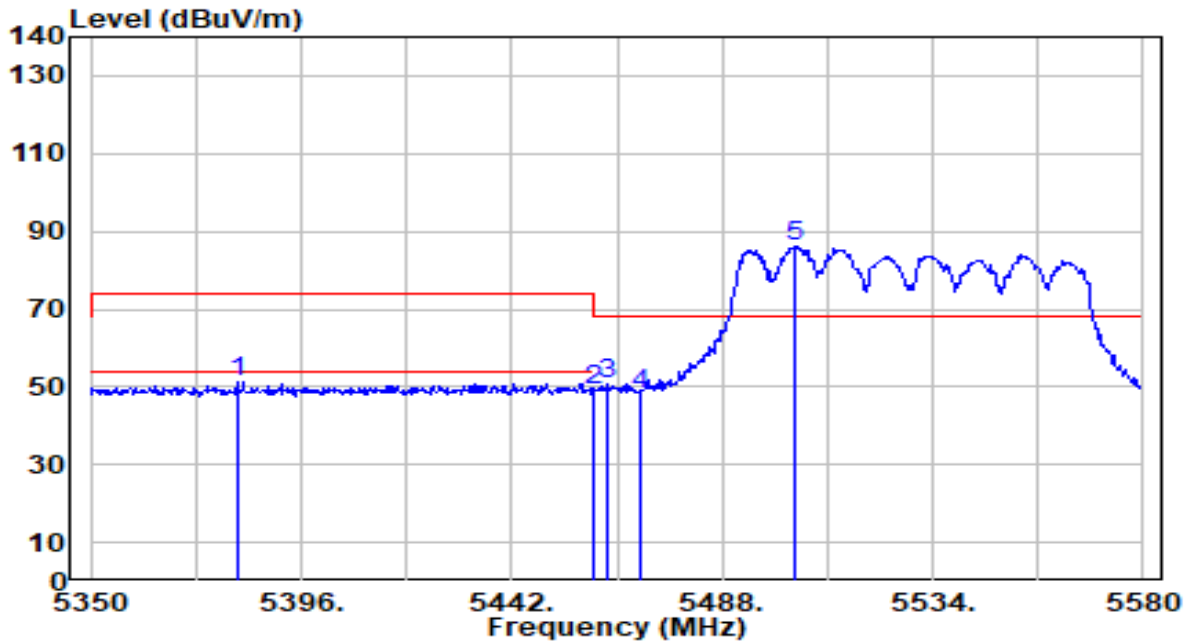

No	Frequency (MHz)	Reading (dBuV)	C.F (dB/m)	Measurement (dBuV/m)	Margin (dB)	Limit (dBuV/m)	Height (cm)	Angle (deg)	Remark (QP/PK/AV)
1	5382.200	52.50	-1.02	51.48	-22.52	74.00	225	66	Peak
2	5460.000	50.21	-0.87	49.34	-24.66	74.00	225	66	Peak
3	* 5462.930	51.67	-0.86	50.81	-17.39	68.20	225	66	Peak
4	5470.000	49.04	-0.84	48.20	-20.00	68.20	225	66	Peak
5	5503.640	86.83	-0.74	86.10	N/A	N/A	225	66	Peak

Note:

1. " *", means this data is the worst emission level.
2. C.F (Correction Factor) = Antenna Factor (dB/m)+ Cable Loss (dB) – Preamplifier(dB) + 10dB Attenuation.
3. Measurement (dBuV/m) = Reading(dBuV) + C.F (Correction Factor).
4. The emission levels of other frequencies are very lower than the limit and not show in test report.

EUT	AX1800 Indoor/Outdoor Wi-Fi 6 Access Point	Date of Test	2023-09-21
Factor	DRH18-E	Temp. / Humidity	20°C /60%
Polarity	Horizontal	Site / Test Engineer	AC2 / Marvin
Test Mode	802.11ac-80MHz_Band3_TX_CH 106_ANT 0+1	Test Voltage	AC120V/60Hz

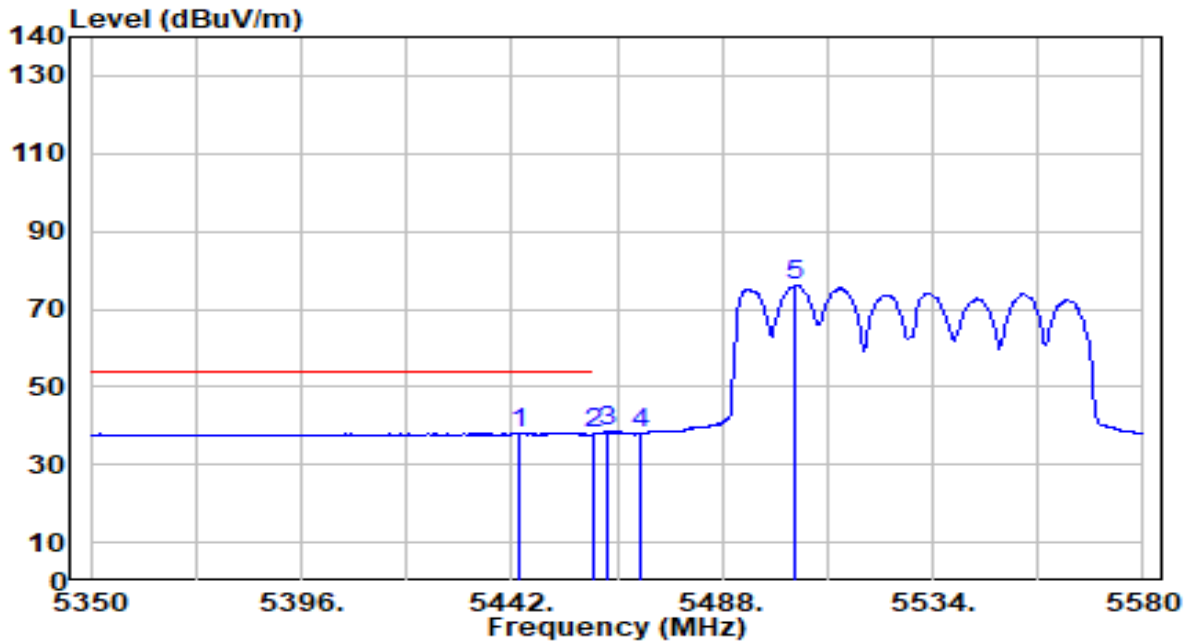

No	Frequency (MHz)	Reading (dBuV)	C.F (dB/m)	Measurement (dBuV/m)	Margin (dB)	Limit (dBuV/m)	Height (cm)	Angle (deg)	Remark (QP/PK/AV)
1	* 5443.840	39.07	-0.92	38.15	-15.85	54.00	225	66	Average
2	5460.000	38.77	-0.87	37.90	-16.10	54.00	225	66	Average
3	5462.930	39.21	-0.86	38.35	N/A	N/A	225	66	Average
4	5470.000	38.88	-0.84	38.04	N/A	N/A	225	66	Average
5	5503.870	76.78	-0.74	76.04	N/A	N/A	225	66	Average

Note:

1. " *", means this data is the worst emission level.
2. C.F (Correction Factor) = Antenna Factor (dB/m)+ Cable Loss (dB) – Preamplifier(dB) + 10dB Attenuation.
3. Measurement (dBuV/m) = Reading(dBuV) + C.F (Correction Factor).
4. The emission levels of other frequencies are very lower than the limit and not show in test report.

EUT	AX1800 Indoor/Outdoor Wi-Fi 6 Access Point	Date of Test	2023-09-21
Factor	DRH18-E	Temp. / Humidity	20°C /60%
Polarity	Vertical	Site / Test Engineer	AC2 / Marvin
Test Mode	802.11ac-80MHz_Band3_TX_CH 106_ANT 0+1	Test Voltage	AC120V/60Hz

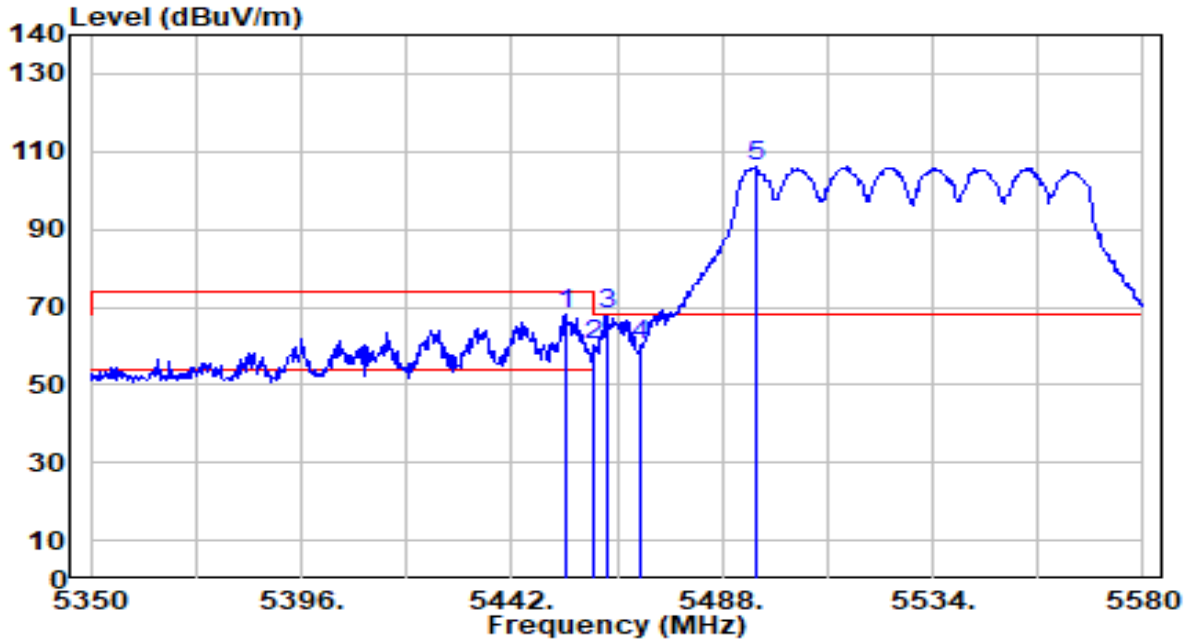

No	Frequency (MHz)	Reading (dBuV)	C.F (dB/m)	Measurement (dBuV/m)	Margin (dB)	Limit (dBuV/m)	Height (cm)	Angle (deg)	Remark (QP/PK/AV)
1	5453.730	69.14	-0.89	68.26	-5.74	74.00	180	152	Peak
2	5460.000	60.84	-0.87	59.97	-14.03	74.00	180	152	Peak
3	* 5462.930	68.87	-0.86	68.01	-0.19	68.20	180	152	Peak
4	5470.000	61.09	-0.84	60.25	-7.95	68.20	180	152	Peak
5	5495.590	106.86	-0.76	106.09	N/A	N/A	180	152	Peak

Note:

- " *", means this data is the worst emission level.
- C.F (Correction Factor) = Antenna Factor (dB/m)+ Cable Loss (dB) – Preamplifier(dB) + 10dB Attenuation.
- Measurement (dBuV/m) = Reading(dBuV) + C.F (Correction Factor).
- The emission levels of other frequencies are very lower than the limit and not show in test report.

EUT	AX1800 Indoor/Outdoor Wi-Fi 6 Access Point	Date of Test	2023-09-21
Factor	DRH18-E	Temp. / Humidity	20°C /60%
Polarity	Vertical	Site / Test Engineer	AC2 / Marvin
Test Mode	802.11ac-80MHz_Band3_TX_CH 106_ANT 0+1	Test Voltage	AC120V/60Hz

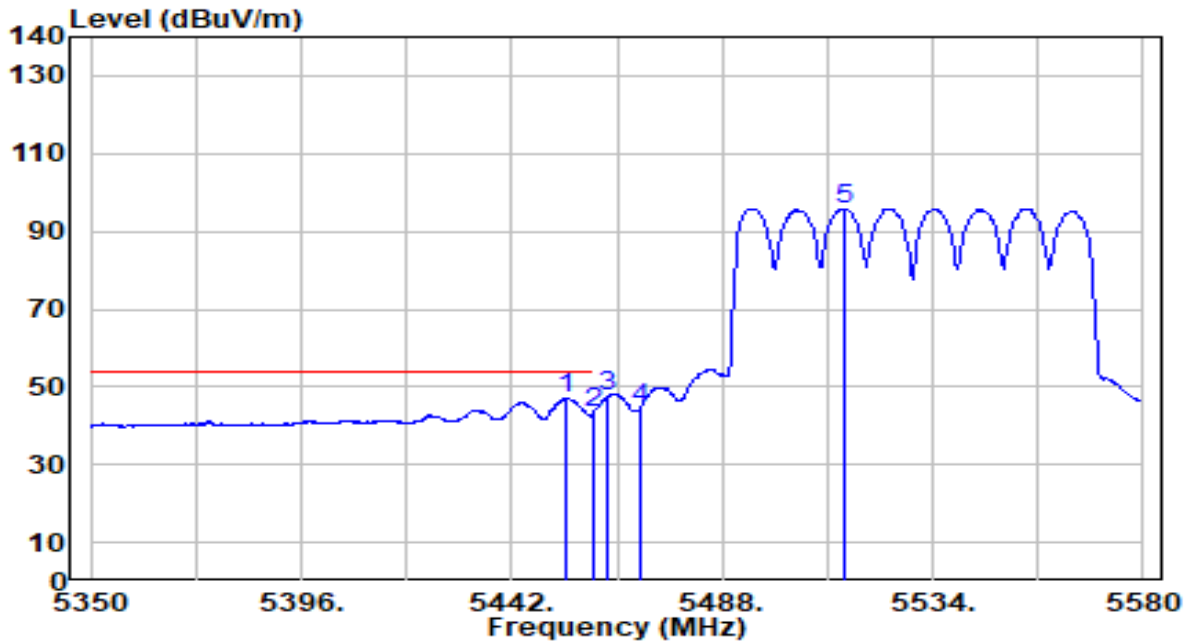

No	Frequency (MHz)	Reading (dBuV)	C.F (dB/m)	Measurement (dBuV/m)	Margin (dB)	Limit (dBuV/m)	Height (cm)	Angle (deg)	Remark (QP/PK/AV)	
1	*	5453.960	48.02	-0.89	47.13	-6.87	54.00	180	152	Average
2		5460.000	44.08	-0.87	43.21	-10.79	54.00	180	152	Average
3		5462.930	48.43	-0.86	47.57	N/A	N/A	180	152	Average
4		5470.000	45.40	-0.84	44.56	N/A	N/A	180	152	Average
5		5514.450	96.55	-0.70	95.85	N/A	N/A	180	152	Average

Note:

- "*" means this data is the worst emission level.
- C.F (Correction Factor) = Antenna Factor (dB/m)+ Cable Loss (dB) – Preamplifier(dB) + 10dB Attenuation.
- Measurement (dBuV/m) = Reading(dBuV) + C.F (Correction Factor).
- The emission levels of other frequencies are very lower than the limit and not show in test report.

EUT	AX1800 Indoor/Outdoor Wi-Fi 6 Access Point	Date of Test	2023-09-21
Factor	DRH18-E	Temp. / Humidity	20°C /60%

Polarity	Horizontal	Site / Test Engineer	AC2 / Marvin
Test Mode	802.11ac-80MHz_Band4_TX_CH 155_ANT 0+1	Test Voltage	AC120V/60Hz

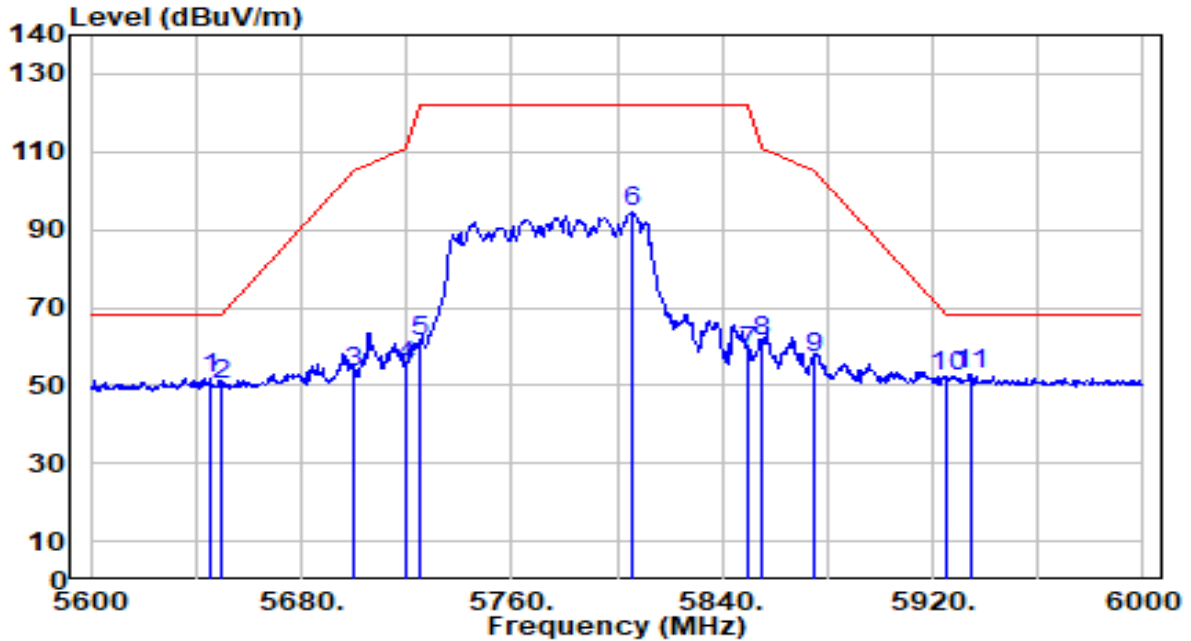

No	Frequency (MHz)	Reading (dBuV)	C.F (dB/m)	Measurement (dBuV/m)	Margin (dB)	Limit (dBuV/m)	Height (cm)	Angle (deg)	Remark (QP/PK/AV)
1	5645.600	51.98	-0.19	51.79	-16.41	68.20	200	28	Peak
2	5650.000	50.16	-0.16	50.00	-18.20	68.20	200	28	Peak
3	5700.000	53.07	0.10	53.17	-52.03	105.20	200	28	Peak
4	5720.000	54.95	0.20	55.15	-55.65	110.80	200	28	Peak
5	5725.000	61.13	0.23	61.35	-60.85	122.20	200	28	Peak
6	5806.000	94.00	0.62	94.62	N/A	N/A	200	28	Peak
7	5850.000	58.04	0.58	58.62	-63.58	122.20	200	28	Peak
8	5855.000	60.52	0.58	61.10	-49.70	110.80	200	28	Peak
9	5875.000	56.42	0.57	56.99	-48.21	105.20	200	28	Peak
10	5925.000	51.74	0.53	52.27	-15.93	68.20	200	28	Peak
11	* 5934.400	52.31	0.52	52.83	-15.37	68.20	200	28	Peak

Note:

1. "*", means this data is the worst emission level.
2. C.F (Correction Factor) = Antenna Factor (dB/m)+ Cable Loss (dB) – Pre-amplifier(dB) + 10dB Attenuation.
3. Measurement (dBuV/m) = Reading(dBuV) + C.F (Correction Factor).
4. The emission levels of other frequencies are very lower than the limit and not show in test report.

EUT	AX1800 Indoor/Outdoor Wi-Fi 6 Access Point	Date of Test	2023-09-21
Factor	DRH18-E	Temp. / Humidity	20°C /60%
Polarity	Vertical	Site / Test Engineer	AC2 / Marvin
Test Mode	802.11ac-80MHz_Band4_TX_CH 155_ANT 0+1	Test Voltage	AC120V/60Hz

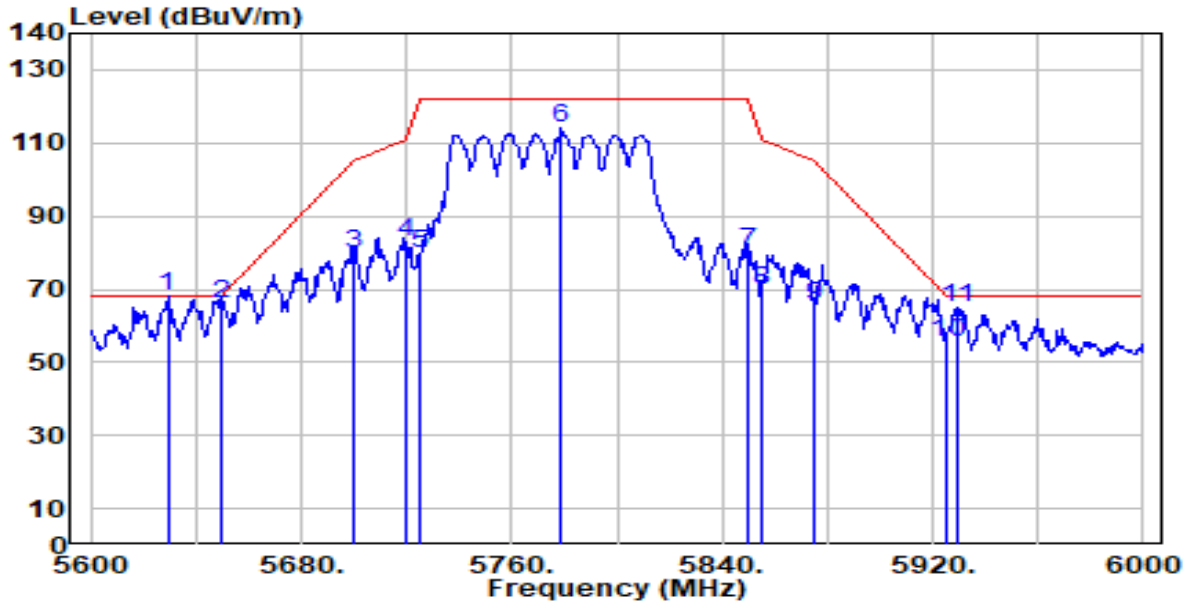

No	Frequency (MHz)	Reading (dBuV)	C.F (dB/m)	Measurement (dBuV/m)	Margin (dB)	Limit (dBuV/m)	Height (cm)	Angle (deg)	Remark (QP/PK/AV)
1	* 5629.200	68.29	-0.27	68.01	-0.19	68.20	200	352	Peak
2	5650.000	66.39	-0.16	66.22	-1.98	68.20	200	352	Peak
3	5700.000	79.88	0.10	79.97	-25.23	105.20	200	352	Peak
4	5720.000	82.67	0.20	82.88	-27.92	110.80	200	352	Peak
5	5725.000	79.41	0.23	79.64	-42.56	122.20	200	352	Peak
6	5778.800	113.36	0.51	113.87	N/A	N/A	200	352	Peak
7	5850.000	79.86	0.58	80.45	-41.75	122.20	200	352	Peak
8	5855.000	68.98	0.58	69.56	-41.24	110.80	200	352	Peak
9	5875.000	64.98	0.57	65.54	-39.66	105.20	200	352	Peak
10	5925.000	55.18	0.53	55.71	-12.49	68.20	200	352	Peak
11	5929.200	64.48	0.52	65.01	-3.19	68.20	200	352	Peak

Note:

1. " *", means this data is the worst emission level.
2. C.F (Correction Factor) = Antenna Factor (dB/m)+ Cable Loss (dB) – Preamplifier(dB) + 10dB Attenuation.
3. Measurement (dBuV/m) = Reading(dBuV) + C.F (Correction Factor).
4. The emission levels of other frequencies are very lower than the limit and not show in test report.

EUT	AX1800 Indoor/Outdoor Wi-Fi 6 Access Point	Date of Test	2023-09-21
Factor	DRH18-E	Temp. / Humidity	20°C /60%
Polarity	Horizontal	Site / Test Engineer	AC2 / Marvin
Test Mode	802.11ax-20MHz_Band1_TX_CH 36_ANT 0+1	Test Voltage	AC120V/60Hz

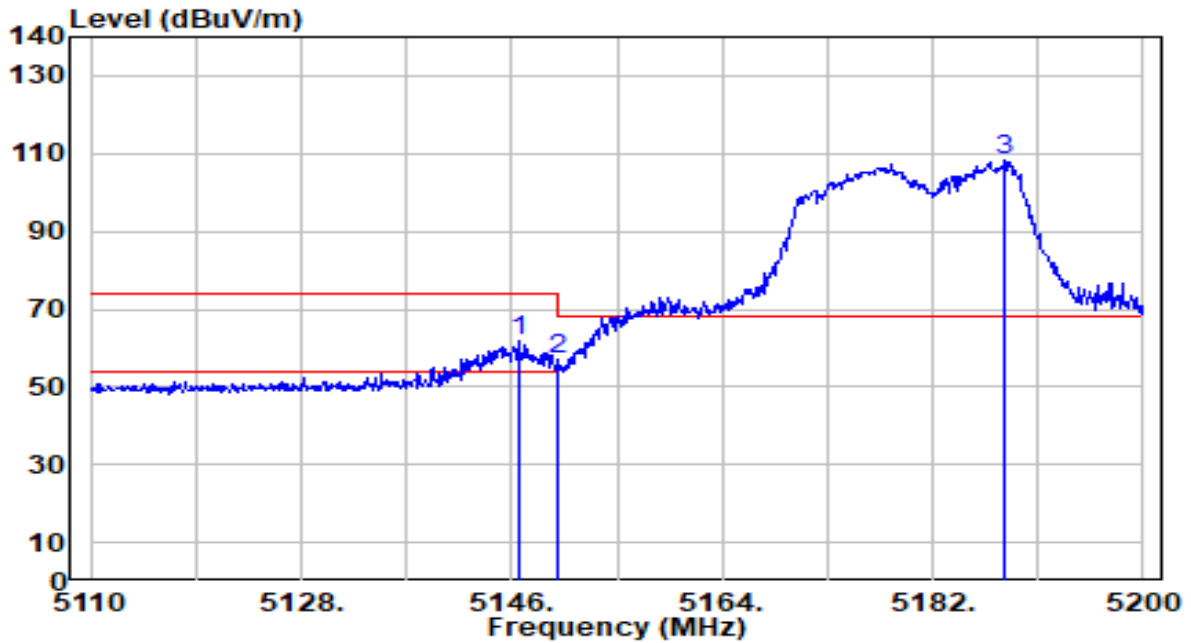

No	Frequency (MHz)	Reading (dBuV)	C.F (dB/m)	Measurement (dBuV/m)	Margin (dB)	Limit (dBuV/m)	Height (cm)	Angle (deg)	Remark (QP/PK/AV)	
1	*	5146.540	62.74	-0.72	62.03	-11.97	74.00	105	336	Peak
2		5150.000	57.58	-0.72	56.86	-17.14	74.00	105	336	Peak
3		5188.210	109.04	-0.74	108.31	N/A	N/A	105	336	Peak

Note:

1. " *", means this data is the worst emission level.
2. C.F (Correction Factor) = Antenna Factor (dB/m)+ Cable Loss (dB) – Preamplifier(dB) + 10dB Attenuation.
3. Measurement (dBuV/m) = Reading(dBuV) + C.F (Correction Factor).
4. The emission levels of other frequencies are very lower than the limit and not show in test report.

EUT	AX1800 Indoor/Outdoor Wi-Fi 6 Access Point	Date of Test	2023-09-21
Factor	DRH18-E	Temp. / Humidity	20°C /60%
Polarity	Horizontal	Site / Test Engineer	AC2 / Marvin
Test Mode	802.11ax-20MHz_Band1_TX_CH 36_ANT 0+1	Test Voltage	AC120V/60Hz

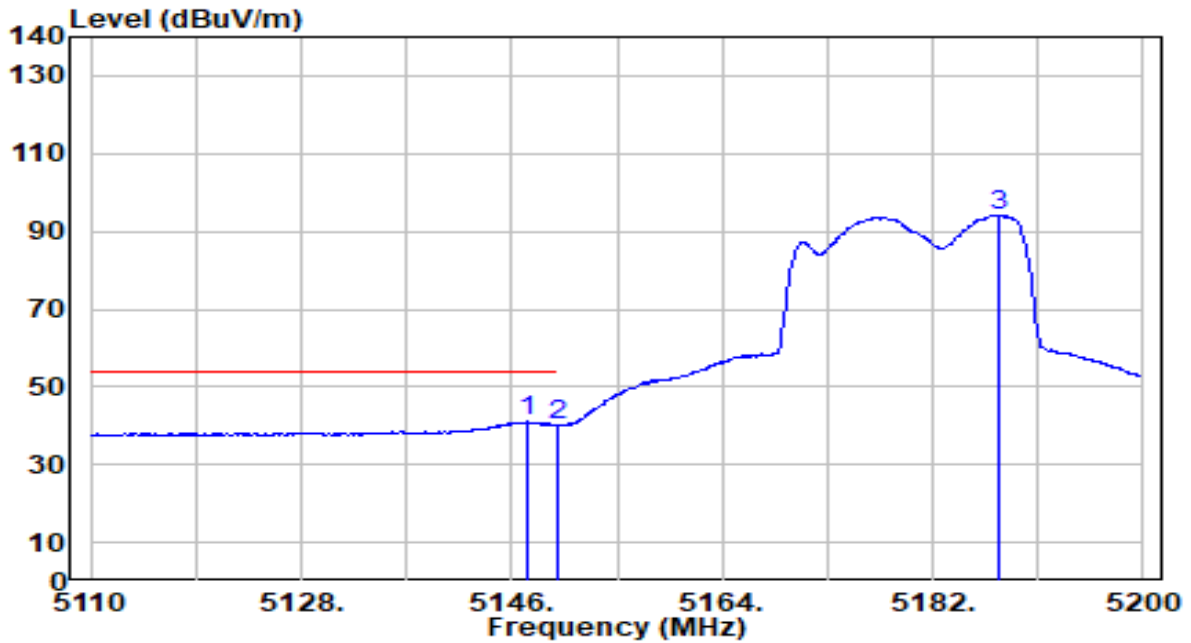

No	Frequency (MHz)	Reading (dBuV)	C.F (dB/m)	Measurement (dBuV/m)	Margin (dB)	Limit (dBuV/m)	Height (cm)	Angle (deg)	Remark (QP/PK/AV)	
1	*	5147.260	41.84	-0.72	41.12	-12.88	54.00	105	336	Average
2		5150.000	40.69	-0.72	39.97	-14.03	54.00	105	336	Average
3		5187.580	94.77	-0.74	94.03	N/A	N/A	105	336	Average

Note:

1. " *", means this data is the worst emission level.
2. C.F (Correction Factor) = Antenna Factor (dB/m)+ Cable Loss (dB) – Preamplifier(dB) + 10dB Attenuation.
3. Measurement (dBuV/m) = Reading(dBuV) + C.F (Correction Factor).
4. The emission levels of other frequencies are very lower than the limit and not show in test report.

EUT	AX1800 Indoor/Outdoor Wi-Fi 6 Access Point	Date of Test	2023-09-21
Factor	DRH18-E	Temp. / Humidity	20°C /60%
Polarity	Vertical	Site / Test Engineer	AC2 / Marvin
Test Mode	802.11ax-20MHz_Band1_TX_CH 36_ANT 0+1	Test Voltage	AC120V/60Hz

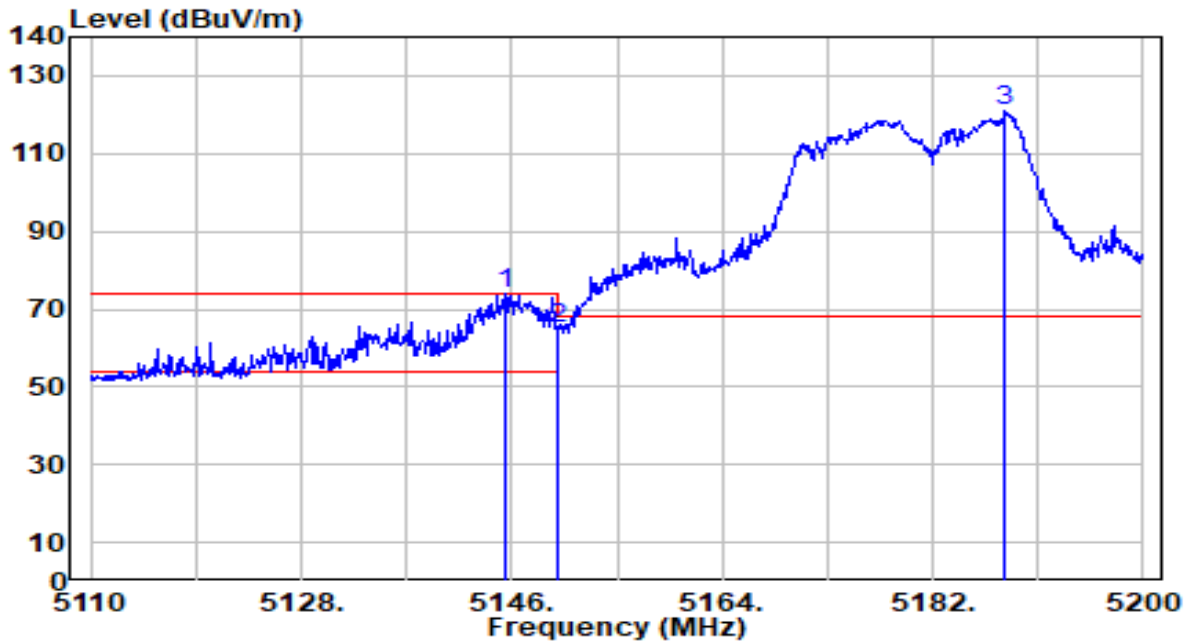

No	Frequency (MHz)	Reading (dBuV)	C.F (dB/m)	Measurement (dBuV/m)	Margin (dB)	Limit (dBuV/m)	Height (cm)	Angle (deg)	Remark (QP/PK/AV)	
1	*	5145.460	74.59	-0.72	73.87	-0.13	74.00	174	200	Peak
2		5150.000	65.83	-0.72	65.11	-8.89	74.00	174	200	Peak
3		5188.120	121.55	-0.74	120.81	N/A	N/A	174	200	Peak

Note:

1. " *", means this data is the worst emission level.
2. C.F (Correction Factor) = Antenna Factor (dB/m)+ Cable Loss (dB) – Preamplifier(dB) + 10dB Attenuation.
3. Measurement (dBuV/m) = Reading(dBuV) + C.F (Correction Factor).
4. The emission levels of other frequencies are very lower than the limit and not show in test report.

EUT	AX1800 Indoor/Outdoor Wi-Fi 6 Access Point	Date of Test	2023-09-21
Factor	DRH18-E	Temp. / Humidity	20°C /60%
Polarity	Vertical	Site / Test Engineer	AC2 / Marvin
Test Mode	802.11ax-20MHz_Band1_TX_CH 36_ANT 0+1	Test Voltage	AC120V/60Hz

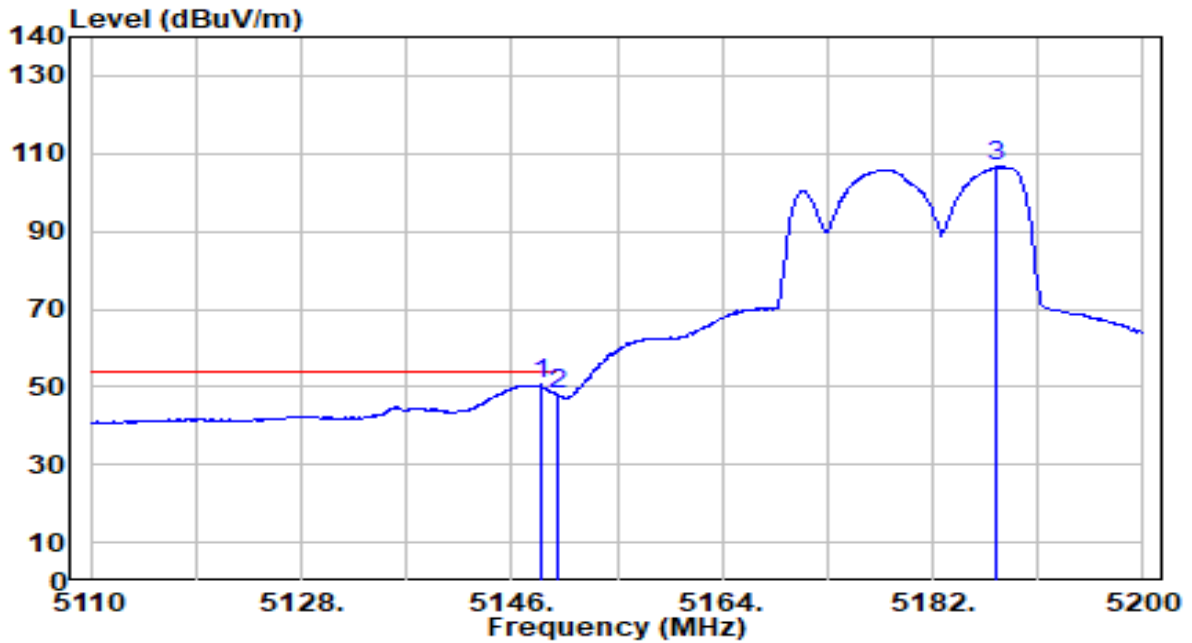

No	Frequency (MHz)	Reading (dBuV)	C.F (dB/m)	Measurement (dBuV/m)	Margin (dB)	Limit (dBuV/m)	Height (cm)	Angle (deg)	Remark (QP/PK/AV)
1	*	51.26	-0.72	50.54	-3.46	54.00	174	200	Average
2		48.58	-0.72	47.86	-6.14	54.00	174	200	Average
3		107.29	-0.74	106.56	N/A	N/A	174	200	Average

Note:

1. " *", means this data is the worst emission level.
2. C.F (Correction Factor) = Antenna Factor (dB/m)+ Cable Loss (dB) – Preamplifier(dB) + 10dB Attenuation.
3. Measurement (dBuV/m) = Reading(dBuV) + C.F (Correction Factor).
4. The emission levels of other frequencies are very lower than the limit and not show in test report.

EUT	AX1800 Indoor/Outdoor Wi-Fi 6 Access Point	Date of Test	2023-09-21
Factor	DRH18-E	Temp. / Humidity	20°C /60%
Polarity	Horizontal	Site / Test Engineer	AC2 / Marvin
Test Mode	802.11ax-20MHz_Band2_TX_CH 64_ANT 0+1	Test Voltage	AC120V/60Hz

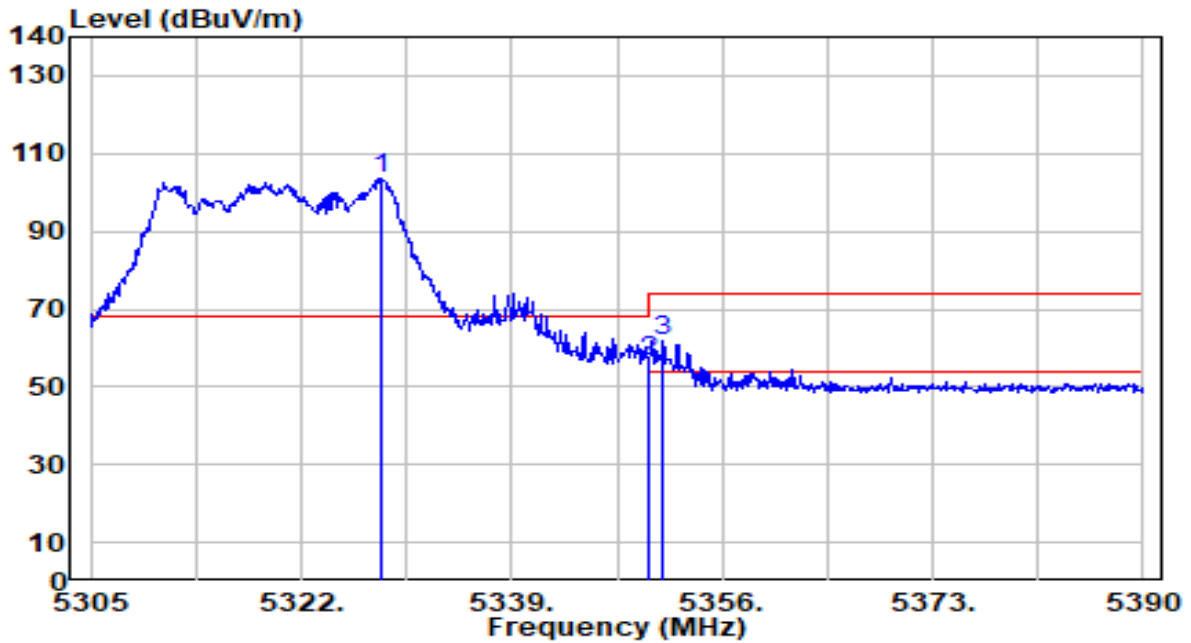

No	Frequency (MHz)	Reading (dBuV)	C.F (dB/m)	Measurement (dBuV/m)	Margin (dB)	Limit (dBuV/m)	Height (cm)	Angle (deg)	Remark (QP/PK/AV)
1	5328.375	104.47	-0.94	103.53	N/A	N/A	200	58	Peak
2	5350.000	57.63	-0.97	56.66	-17.34	74.00	200	58	Peak
3	* 5351.240	62.61	-0.97	61.63	-12.37	74.00	200	58	Peak

Note:

1. " *", means this data is the worst emission level.
2. C.F (Correction Factor) = Antenna Factor (dB/m)+ Cable Loss (dB) – Preamplifier(dB) + 10dB Attenuation.
3. Measurement (dBuV/m) = Reading(dBuV) + C.F (Correction Factor).
4. The emission levels of other frequencies are very lower than the limit and not show in test report.

EUT	AX1800 Indoor/Outdoor Wi-Fi 6 Access Point	Date of Test	2023-09-21
Factor	DRH18-E	Temp. / Humidity	20°C /60%
Polarity	Horizontal	Site / Test Engineer	AC2 / Marvin
Test Mode	802.11ax-20MHz_Band2_TX_CH 64_ANT 0+1	Test Voltage	AC120V/60Hz

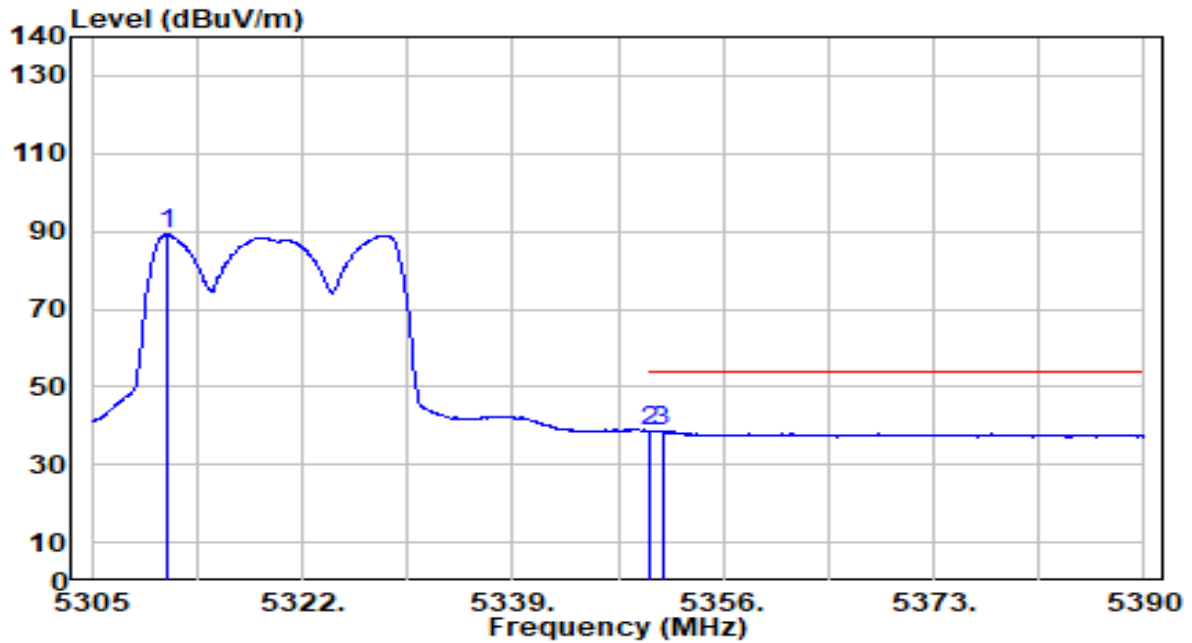

No	Frequency (MHz)	Reading (dBuV)	C.F (dB/m)	Measurement (dBuV/m)	Margin (dB)	Limit (dBuV/m)	Height (cm)	Angle (deg)	Remark (QP/PK/AV)
1	5311.120	90.11	-0.91	89.20	N/A	N/A	200	58	Average
2	* 5350.000	39.70	-0.97	38.73	-15.27	54.00	200	58	Average
3	5351.070	39.50	-0.97	38.52	-15.48	54.00	200	58	Average

Note:

1. " *", means this data is the worst emission level.
2. C.F (Correction Factor) = Antenna Factor (dB/m)+ Cable Loss (dB) – Preamplifier(dB) + 10dB Attenuation.
3. Measurement (dBuV/m) = Reading(dBuV) + C.F (Correction Factor).
4. The emission levels of other frequencies are very lower than the limit and not show in test report.

EUT	AX1800 Indoor/Outdoor Wi-Fi 6 Access Point	Date of Test	2023-09-21
Factor	DRH18-E	Temp. / Humidity	20°C /60%
Polarity	Vertical	Site / Test Engineer	AC2 / Marvin
Test Mode	802.11ax-20MHz_Band2_TX_CH 64_ANT 0+1	Test Voltage	AC120V/60Hz

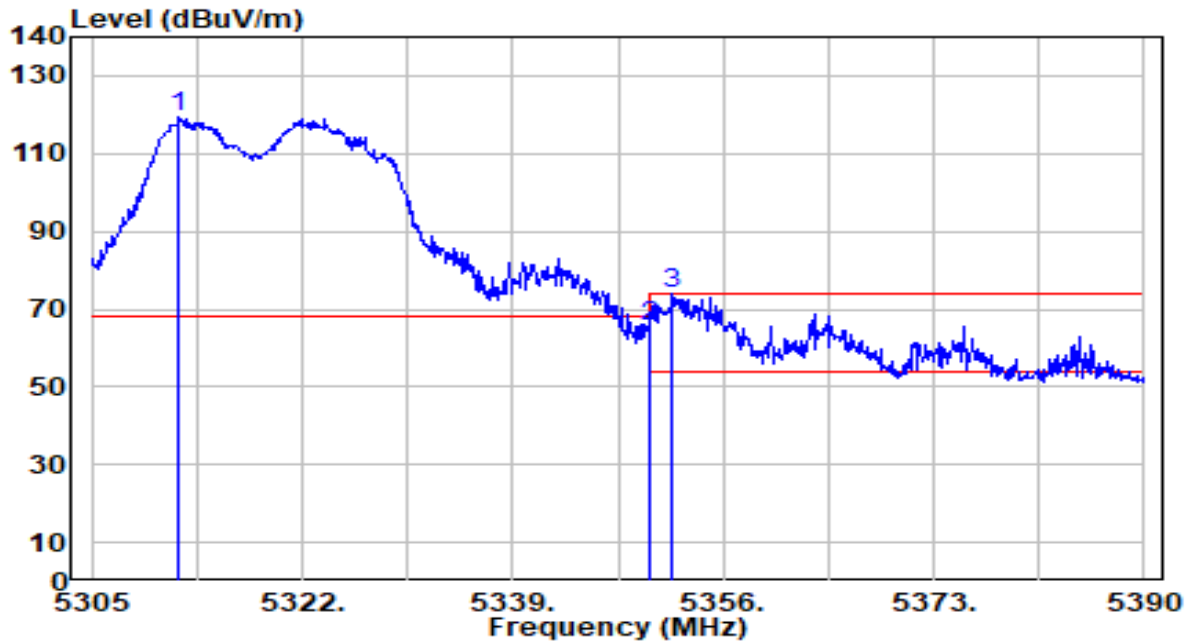

No	Frequency (MHz)	Reading (dBuV)	C.F (dB/m)	Measurement (dBuV/m)	Margin (dB)	Limit (dBuV/m)	Height (cm)	Angle (deg)	Remark (QP/PK/AV)
1	5312.055	120.30	-0.91	119.38	N/A	N/A	180	158	Peak
2	5350.000	66.57	-0.97	65.60	-8.40	74.00	180	158	Peak
3	* 5351.835	74.87	-0.97	73.90	-0.10	74.00	180	158	Peak

Note:

1. " *", means this data is the worst emission level.
2. C.F (Correction Factor) = Antenna Factor (dB/m)+ Cable Loss (dB) – Preamplifier(dB) + 10dB Attenuation.
3. Measurement (dBuV/m) = Reading(dBuV) + C.F (Correction Factor).
4. The emission levels of other frequencies are very lower than the limit and not show in test report.

EUT	AX1800 Indoor/Outdoor Wi-Fi 6 Access Point	Date of Test	2023-09-21
Factor	DRH18-E	Temp. / Humidity	20°C /60%
Polarity	Vertical	Site / Test Engineer	AC2 / Marvin
Test Mode	802.11ax-20MHz_Band2_TX_CH 64_ANT 0+1	Test Voltage	AC120V/60Hz

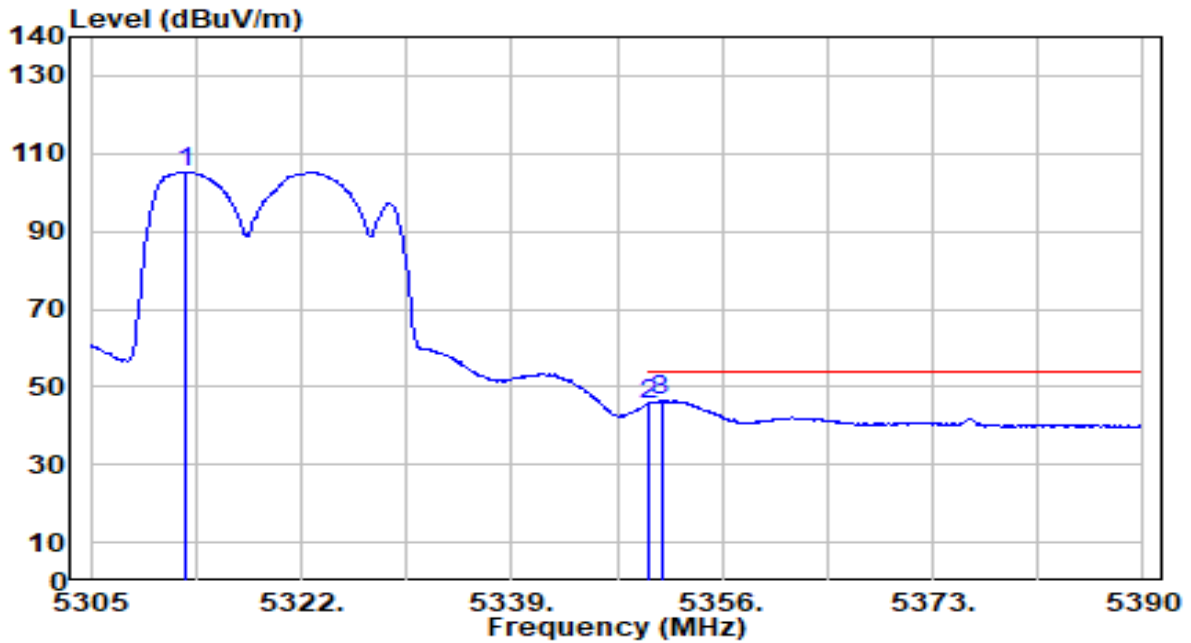

No	Frequency (MHz)	Reading (dBuV)	C.F (dB/m)	Measurement (dBuV/m)	Margin (dB)	Limit (dBuV/m)	Height (cm)	Angle (deg)	Remark (QP/PK/AV)
1	5312.735	106.18	-0.92	105.27	N/A	N/A	180	158	Average
2	5350.000	46.30	-0.97	45.33	-8.67	54.00	180	158	Average
3	* 5351.070	47.57	-0.97	46.59	-7.41	54.00	180	158	Average

Note:

1. " *", means this data is the worst emission level.
2. C.F (Correction Factor) = Antenna Factor (dB/m)+ Cable Loss (dB) – Preamplifier(dB) + 10dB Attenuation.
3. Measurement (dBuV/m) = Reading(dBuV) + C.F (Correction Factor).
4. The emission levels of other frequencies are very lower than the limit and not show in test report.

EUT	AX1800 Indoor/Outdoor Wi-Fi 6 Access Point	Date of Test	2023-09-21
Factor	DRH18-E	Temp. / Humidity	20°C /60%
Polarity	Horizontal	Site / Test Engineer	AC2 / Marvin
Test Mode	802.11ax-20MHz_Band3_TX_CH 100_ANT 0+1	Test Voltage	AC120V/60Hz

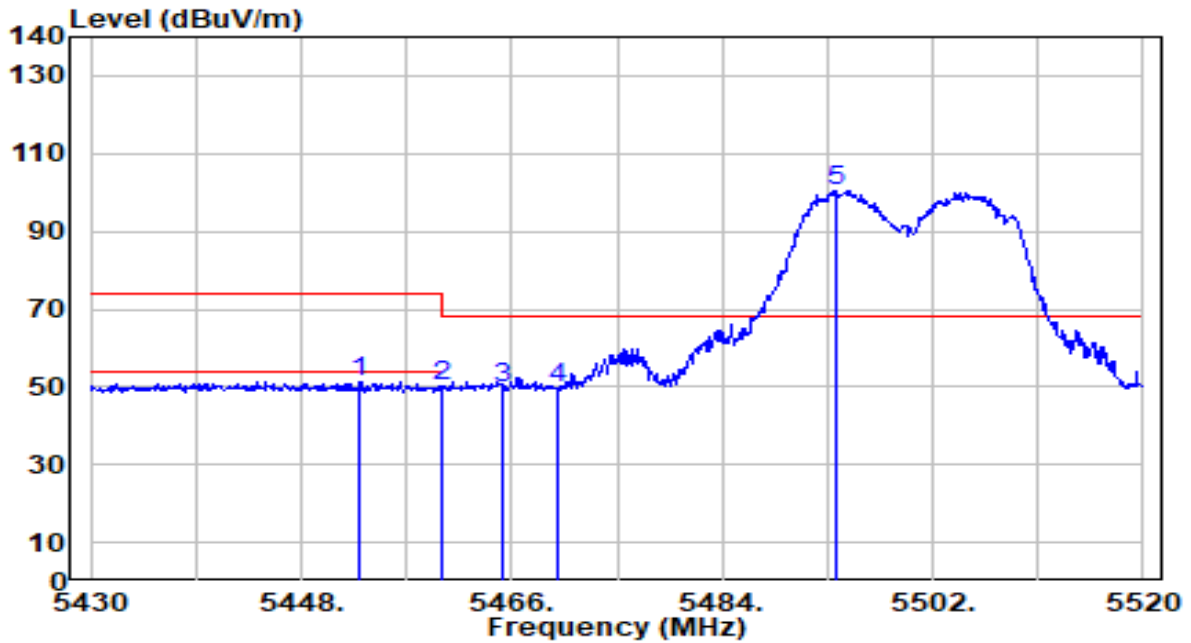

No	Frequency (MHz)	Reading (dBuV)	C.F (dB/m)	Measurement (dBuV/m)	Margin (dB)	Limit (dBuV/m)	Height (cm)	Angle (deg)	Remark (QP/PK/AV)
1	5453.040	52.31	-0.89	51.42	-22.58	74.00	200	56	Peak
2	5460.000	50.84	-0.87	49.97	-24.03	74.00	200	56	Peak
3	* 5465.190	50.57	-0.85	49.72	-18.48	68.20	200	56	Peak
4	5470.000	50.42	-0.84	49.58	-18.62	68.20	200	56	Peak
5	5493.720	101.34	-0.77	100.57	N/A	N/A	200	56	Peak

Note:

1. " *", means this data is the worst emission level.
2. C.F (Correction Factor) = Antenna Factor (dB/m)+ Cable Loss (dB) – Preamplifier(dB) + 10dB Attenuation.
3. Measurement (dBuV/m) = Reading(dBuV) + C.F (Correction Factor).
4. The emission levels of other frequencies are very lower than the limit and not show in test report.

EUT	AX1800 Indoor/Outdoor Wi-Fi 6 Access Point	Date of Test	2023-09-21
Factor	DRH18-E	Temp. / Humidity	20°C /60%
Polarity	Horizontal	Site / Test Engineer	AC2 / Marvin
Test Mode	802.11ax-20MHz_Band3_TX_CH 100_ANT 0+1	Test Voltage	AC120V/60Hz

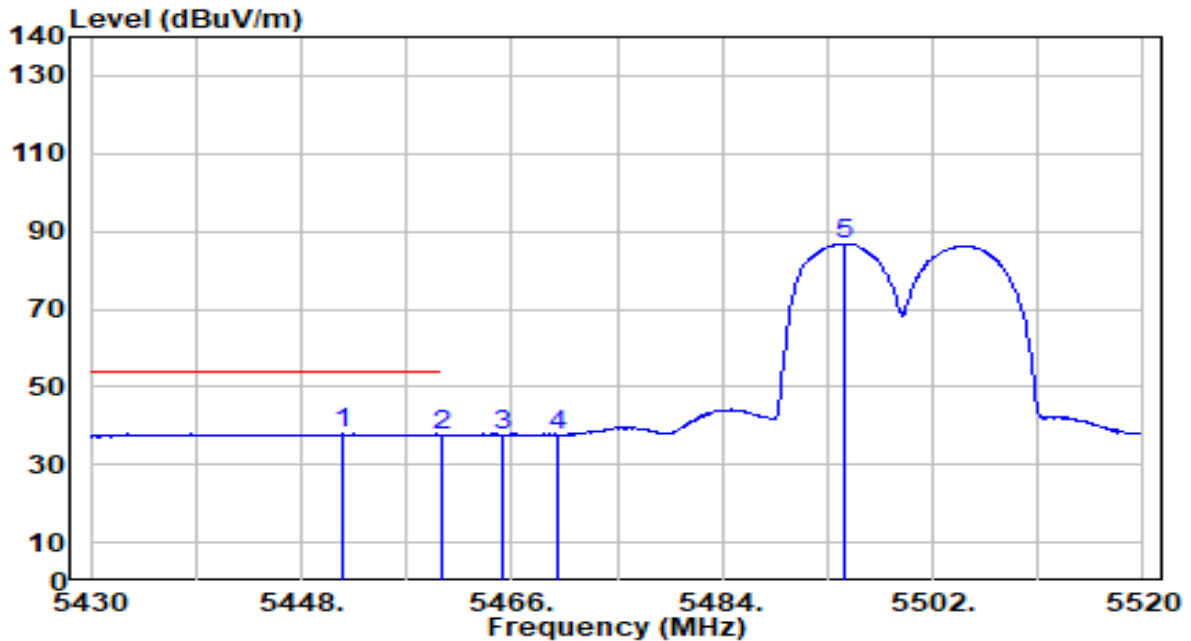

No	Frequency (MHz)	Reading (dBuV)	C.F (dB/m)	Measurement (dBuV/m)	Margin (dB)	Limit (dBuV/m)	Height (cm)	Angle (deg)	Remark (QP/PK/AV)
1	* 5451.510	38.78	-0.89	37.89	-16.11	54.00	200	56	Average
2	5460.000	38.40	-0.87	37.53	-16.47	54.00	200	56	Average
3	5465.190	38.44	-0.85	37.58	N/A	N/A	200	56	Average
4	5470.000	38.28	-0.84	37.44	N/A	N/A	200	56	Average
5	5494.440	87.64	-0.77	86.87	N/A	N/A	200	56	Average

Note:

1. " *", means this data is the worst emission level.
2. C.F (Correction Factor) = Antenna Factor (dB/m)+ Cable Loss (dB) – Preamplifier(dB) + 10dB Attenuation.
3. Measurement (dBuV/m) = Reading(dBuV) + C.F (Correction Factor).
4. The emission levels of other frequencies are very lower than the limit and not show in test report.

EUT	AX1800 Indoor/Outdoor Wi-Fi 6 Access Point	Date of Test	2023-09-21
Factor	DRH18-E	Temp. / Humidity	20°C /60%
Polarity	Vertical	Site / Test Engineer	AC2 / Marvin
Test Mode	802.11ax-20MHz_Band3_TX_CH 100_ANT 0+1	Test Voltage	AC120V/60Hz

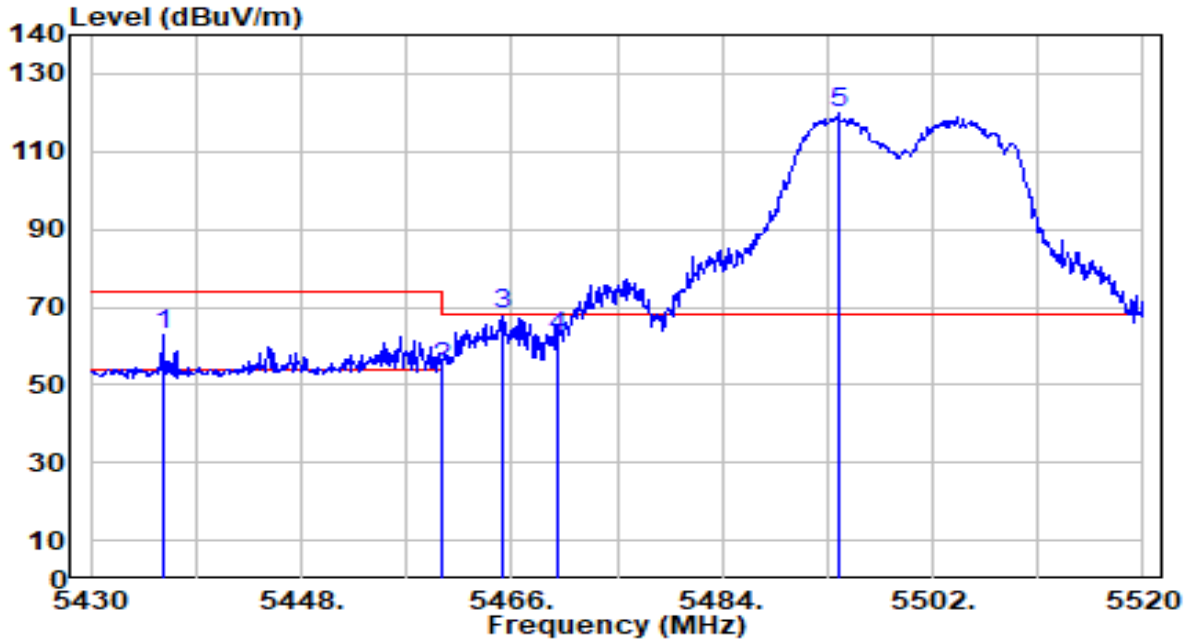

No	Frequency (MHz)	Reading (dBuV)	C.F (dB/m)	Measurement (dBuV/m)	Margin (dB)	Limit (dBuV/m)	Height (cm)	Angle (deg)	Remark (QP/PK/AV)
1	5436.120	64.05	-0.94	63.11	-10.89	74.00	178	150	Peak
2	5460.000	55.46	-0.87	54.59	-19.41	74.00	178	150	Peak
3	* 5465.190	68.88	-0.85	68.03	-0.17	68.20	178	150	Peak
4	5470.000	62.97	-0.84	62.13	-6.07	68.20	178	150	Peak
5	5493.900	120.59	-0.77	119.82	N/A	N/A	178	150	Peak

Note:

1. " *", means this data is the worst emission level.
2. C.F (Correction Factor) = Antenna Factor (dB/m)+ Cable Loss (dB) – Preamplifier(dB) + 10dB Attenuation.
3. Measurement (dBuV/m) = Reading(dBuV) + C.F (Correction Factor).
4. The emission levels of other frequencies are very lower than the limit and not show in test report.

EUT	AX1800 Indoor/Outdoor Wi-Fi 6 Access Point	Date of Test	2023-09-21
Factor	DRH18-E	Temp. / Humidity	20°C /60%
Polarity	Vertical	Site / Test Engineer	AC2 / Marvin
Test Mode	802.11ax-20MHz_Band3_TX_CH 100_ANT 0+1	Test Voltage	AC120V/60Hz

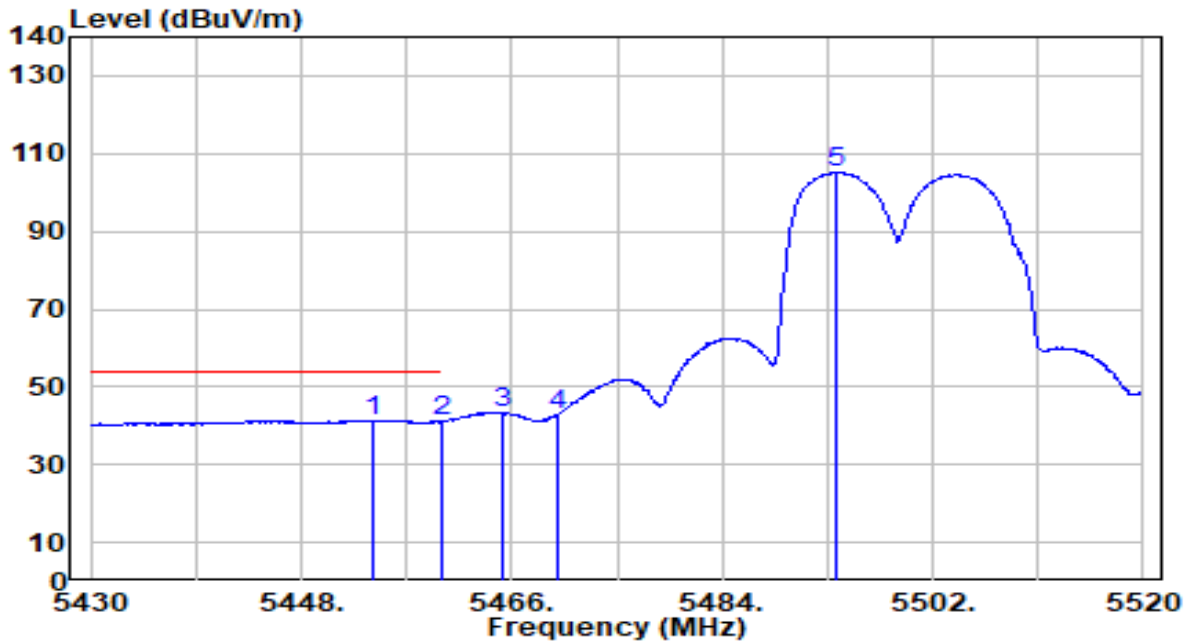

No	Frequency (MHz)	Reading (dBuV)	C.F (dB/m)	Measurement (dBuV/m)	Margin (dB)	Limit (dBuV/m)	Height (cm)	Angle (deg)	Remark (QP/PK/AV)
1	* 5454.120	42.33	-0.89	41.44	-12.56	54.00	178	150	Average
2	5460.000	41.88	-0.87	41.01	-12.99	54.00	178	150	Average
3	5465.190	44.05	-0.85	43.19	N/A	N/A	178	150	Average
4	5470.000	43.84	-0.84	43.00	N/A	N/A	178	150	Average
5	5493.720	105.90	-0.77	105.13	N/A	N/A	178	150	Average

Note:

1. " *", means this data is the worst emission level.
2. C.F (Correction Factor) = Antenna Factor (dB/m)+ Cable Loss (dB) – Preamplifier(dB) + 10dB Attenuation.
3. Measurement (dBuV/m) = Reading(dBuV) + C.F (Correction Factor).
4. The emission levels of other frequencies are very lower than the limit and not show in test report.

EUT	AX1800 Indoor/Outdoor Wi-Fi 6 Access Point	Date of Test	2023-09-21
Factor	DRH18-E	Temp. / Humidity	20°C /60%
Polarity	Horizontal	Site / Test Engineer	AC2 / Marvin
Test Mode	802.11ax-20MHz_Band3_TX_CH 140_ANT 0+1	Test Voltage	AC120V/60Hz

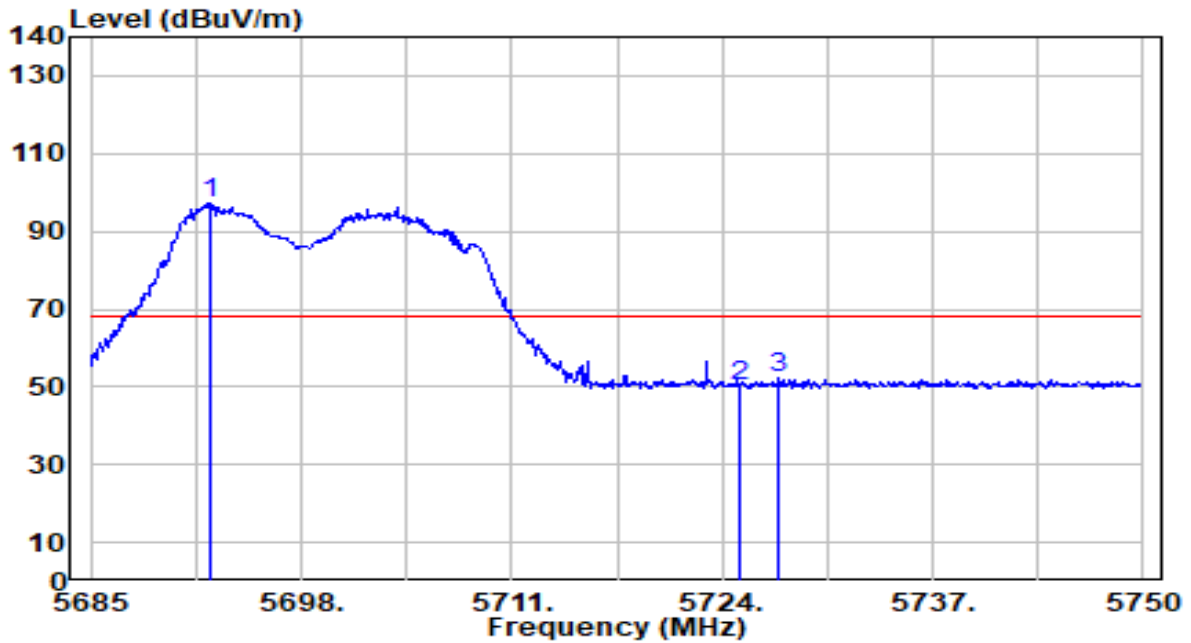

No	Frequency (MHz)	Reading (dBuV)	C.F (dB/m)	Measurement (dBuV/m)	Margin (dB)	Limit (dBuV/m)	Height (cm)	Angle (deg)	Remark (QP/PK/AV)
1	5692.410	97.20	0.06	97.26	N/A	N/A	120	2	Peak
2	5725.000	50.10	0.23	50.33	-17.87	68.20	120	2	Peak
3	* 5727.510	52.30	0.24	52.54	-15.66	68.20	120	2	Peak

Note:

1. " *", means this data is the worst emission level.
2. C.F (Correction Factor) = Antenna Factor (dB/m)+ Cable Loss (dB) – Preamplifier(dB) + 10dB Attenuation.
3. Measurement (dBuV/m) = Reading(dBuV) + C.F (Correction Factor).
4. The emission levels of other frequencies are very lower than the limit and not show in test report.

EUT	AX1800 Indoor/Outdoor Wi-Fi 6 Access Point	Date of Test	2023-09-21
Factor	DRH18-E	Temp. / Humidity	20°C /60%
Polarity	Vertical	Site / Test Engineer	AC2 / Marvin
Test Mode	802.11ax-20MHz_Band3_TX_CH 140_ANT 0+1	Test Voltage	AC120V/60Hz

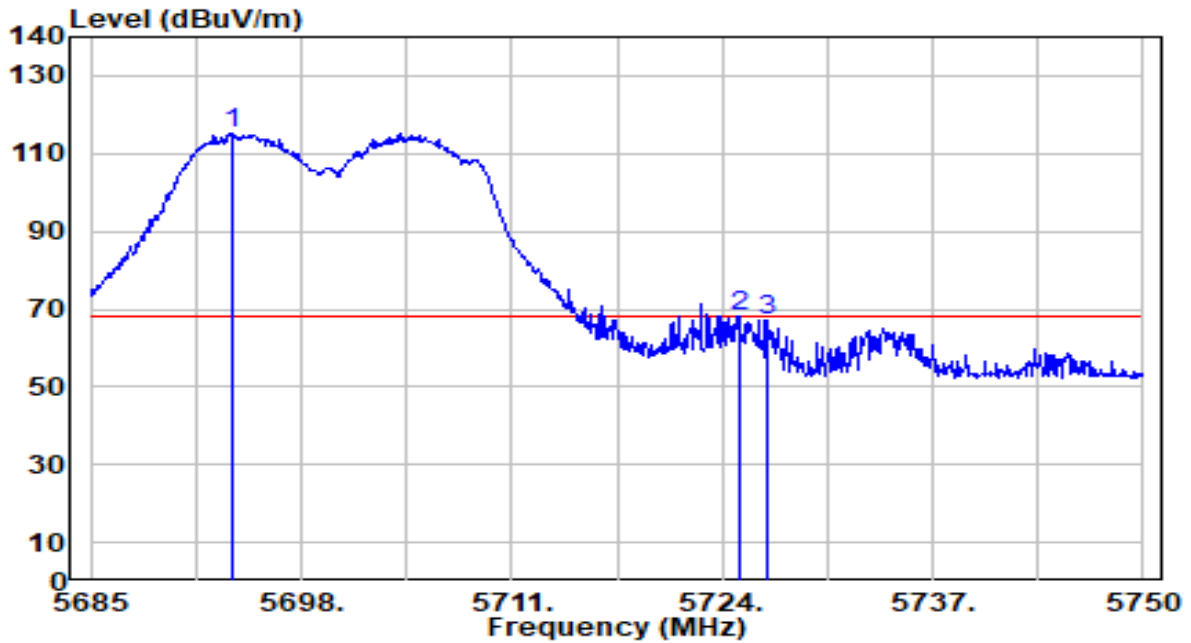

No	Frequency (MHz)	Reading (dBuV)	C.F (dB/m)	Measurement (dBuV/m)	Margin (dB)	Limit (dBuV/m)	Height (cm)	Angle (deg)	Remark (QP/PK/AV)
1	5693.775	115.18	0.07	115.25	N/A	N/A	200	235	Peak
2	* 5725.000	67.87	0.23	68.10	-0.10	68.20	200	235	Peak
3	5726.730	67.02	0.24	67.25	-0.95	68.20	200	235	Peak

Note:

- "*" means this data is the worst emission level.
- C.F (Correction Factor) = Antenna Factor (dB/m)+ Cable Loss (dB) – Preamplifier(dB) + 10dB Attenuation.
- Measurement (dBuV/m) = Reading(dBuV) + C.F (Correction Factor).
- The emission levels of other frequencies are very lower than the limit and not show in test report.

EUT	AX1800 Indoor/Outdoor Wi-Fi 6 Access Point	Date of Test	2023-09-21
Factor	DRH18-E	Temp. / Humidity	20°C /60%
Polarity	Horizontal	Site / Test Engineer	AC2 / Marvin
Test Mode	802.11ax-20MHz_Band4_TX_CH 149_ANT 0+1	Test Voltage	AC120V/60Hz

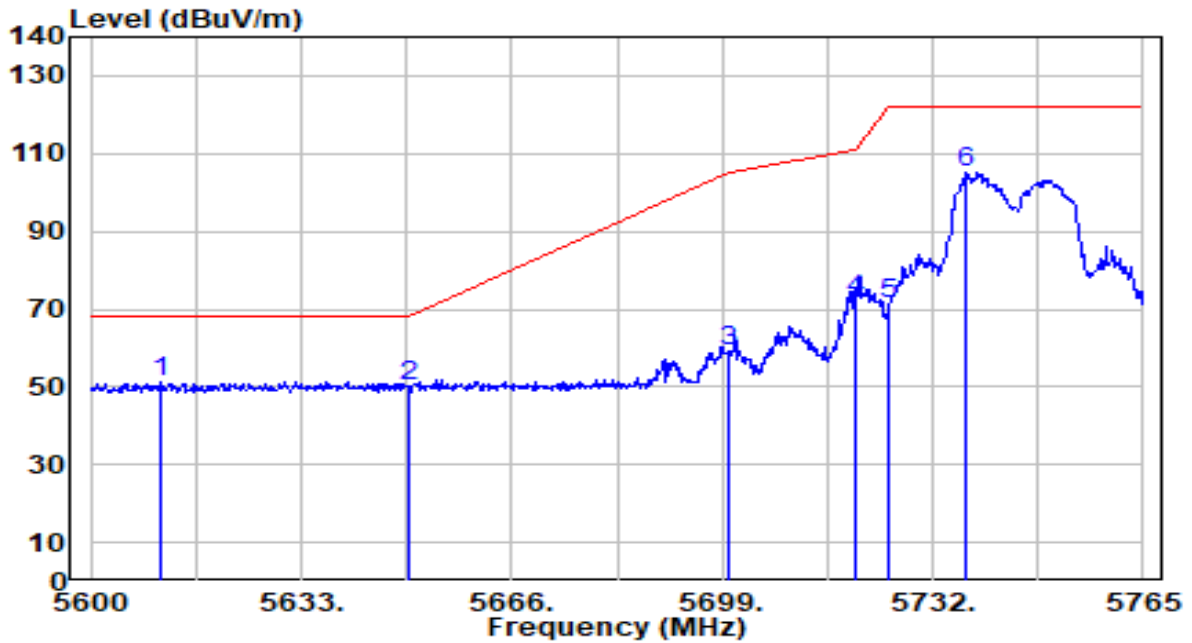

No	Frequency (MHz)	Reading (dBuV)	C.F (dB/m)	Measurement (dBuV/m)	Margin (dB)	Limit (dBuV/m)	Height (cm)	Angle (deg)	Remark (QP/PK/AV)	
1	*	5610.890	51.88	-0.37	51.51	-16.69	68.20	107	19	Peak
2		5650.000	50.38	-0.16	50.22	-17.98	68.20	107	19	Peak
3		5700.000	59.24	0.10	59.34	-45.86	105.20	107	19	Peak
4		5720.000	72.18	0.20	72.38	-38.42	110.80	107	19	Peak
5		5725.000	71.02	0.23	71.25	-50.95	122.20	107	19	Peak
6		5737.280	104.79	0.29	105.08	N/A	N/A	107	19	Peak

Note:

1. " *", means this data is the worst emission level.
2. C.F (Correction Factor) = Antenna Factor (dB/m)+ Cable Loss (dB) – Preamplifier(dB) + 10dB Attenuation.
3. Measurement (dBuV/m) = Reading(dBuV) + C.F (Correction Factor).
4. The emission levels of other frequencies are very lower than the limit and not show in test report.

EUT	AX1800 Indoor/Outdoor Wi-Fi 6 Access Point	Date of Test	2023-09-21
Factor	DRH18-E	Temp. / Humidity	20°C /60%
Polarity	Vertical	Site / Test Engineer	AC2 / Marvin
Test Mode	802.11ax-20MHz_Band4_TX_CH 149_ANT 0+1	Test Voltage	AC120V/60Hz

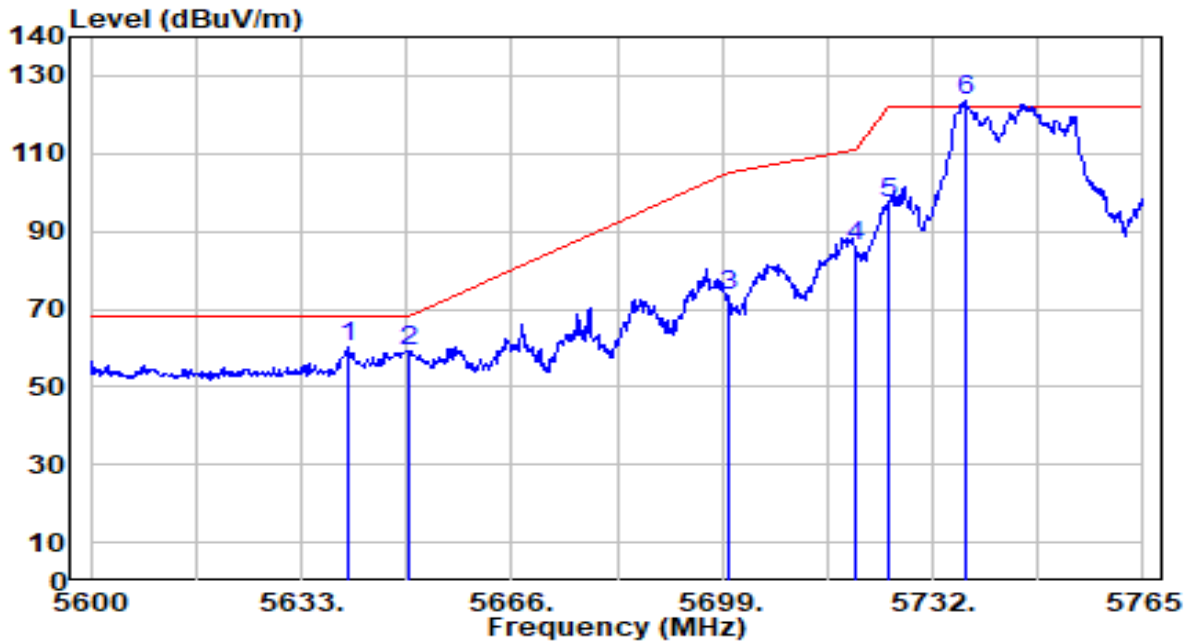

No	Frequency (MHz)	Reading (dBUV)	C.F (dB/m)	Measurement (dBUV/m)	Margin (dB)	Limit (dBUV/m)	Height (cm)	Angle (deg)	Remark (QP/PK/AV)
1	* 5640.260	60.31	-0.22	60.10	-8.10	68.20	200	327	Peak
2	5650.000	59.37	-0.16	59.20	-9.00	68.20	200	327	Peak
3	5700.000	73.11	0.10	73.21	-31.99	105.20	200	327	Peak
4	5720.000	85.85	0.20	86.05	-24.75	110.80	200	327	Peak
5	5725.000	96.92	0.23	97.15	-25.05	122.20	200	327	Peak
6	5737.115	123.28	0.29	123.57	N/A	N/A	200	327	Peak

Note:

1. " *", means this data is the worst emission level.
2. C.F (Correction Factor) = Antenna Factor (dB/m)+ Cable Loss (dB) – Preamplifier(dB) + 10dB Attenuation.
3. Measurement (dBUV/m) = Reading(dBUV) + C.F (Correction Factor).
4. The emission levels of other frequencies are very lower than the limit and not show in test report.

EUT	AX1800 Indoor/Outdoor Wi-Fi 6 Access Point	Date of Test	2023-09-21
Factor	DRH18-E	Temp. / Humidity	20°C /60%
Polarity	Horizontal	Site / Test Engineer	AC2 / Marvin
Test Mode	802.11ax-20MHz_Band4_TX_CH 165_ANT 0+1	Test Voltage	AC120V/60Hz

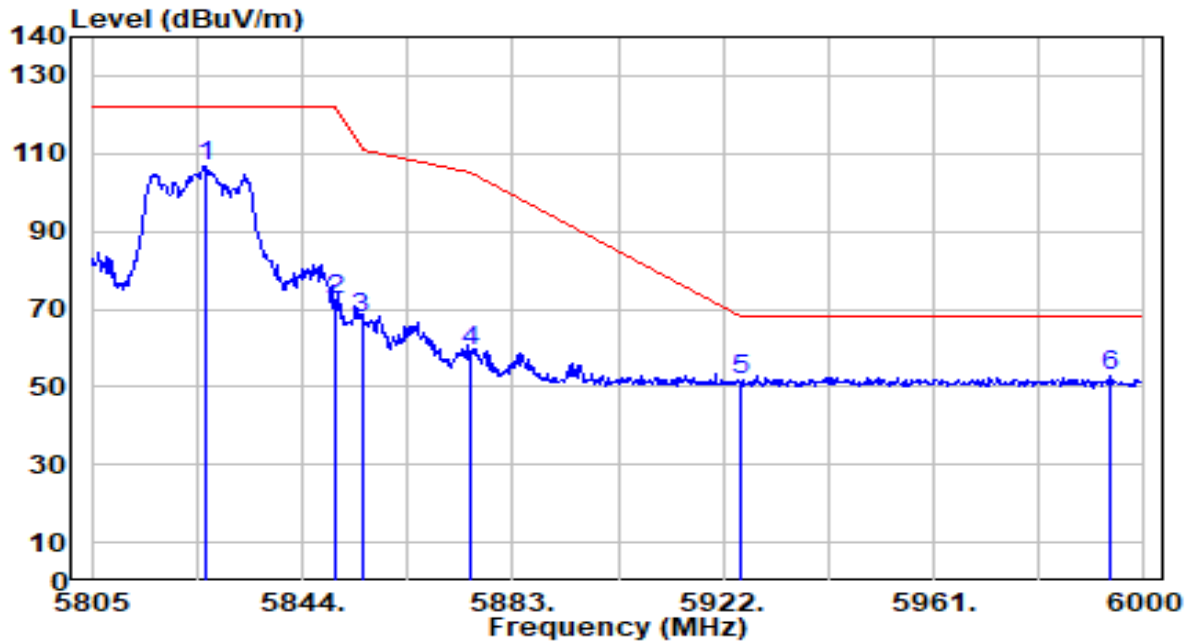

No	Frequency (MHz)	Reading (dBUV)	C.F (dB/m)	Measurement (dBUV/m)	Margin (dB)	Limit (dBUV/m)	Height (cm)	Angle (deg)	Remark (QP/PK/AV)
1	5826.255	106.19	0.60	106.79	N/A	N/A	200	30	Peak
2	5850.000	71.91	0.58	72.49	-49.71	122.20	200	30	Peak
3	5855.000	67.27	0.58	67.85	-42.95	110.80	200	30	Peak
4	5875.000	58.74	0.57	59.30	-45.90	105.20	200	30	Peak
5	5925.000	51.16	0.53	51.69	-16.51	68.20	200	30	Peak
6	* 5993.565	52.44	0.47	52.92	-15.28	68.20	200	30	Peak

Note:

1. " *", means this data is the worst emission level.
2. C.F (Correction Factor) = Antenna Factor (dB/m)+ Cable Loss (dB) – Preamplifier(dB) + 10dB Attenuation.
3. Measurement (dBUV/m) = Reading(dBUV) + C.F (Correction Factor).
4. The emission levels of other frequencies are very lower than the limit and not show in test report.

EUT	AX1800 Indoor/Outdoor Wi-Fi 6 Access Point	Date of Test	2023-09-21
Factor	DRH18-E	Temp. / Humidity	20°C /60%
Polarity	Vertical	Site / Test Engineer	AC2 / Marvin
Test Mode	802.11ax-20MHz_Band4_TX_CH 165_ANT 0+1	Test Voltage	AC120V/60Hz

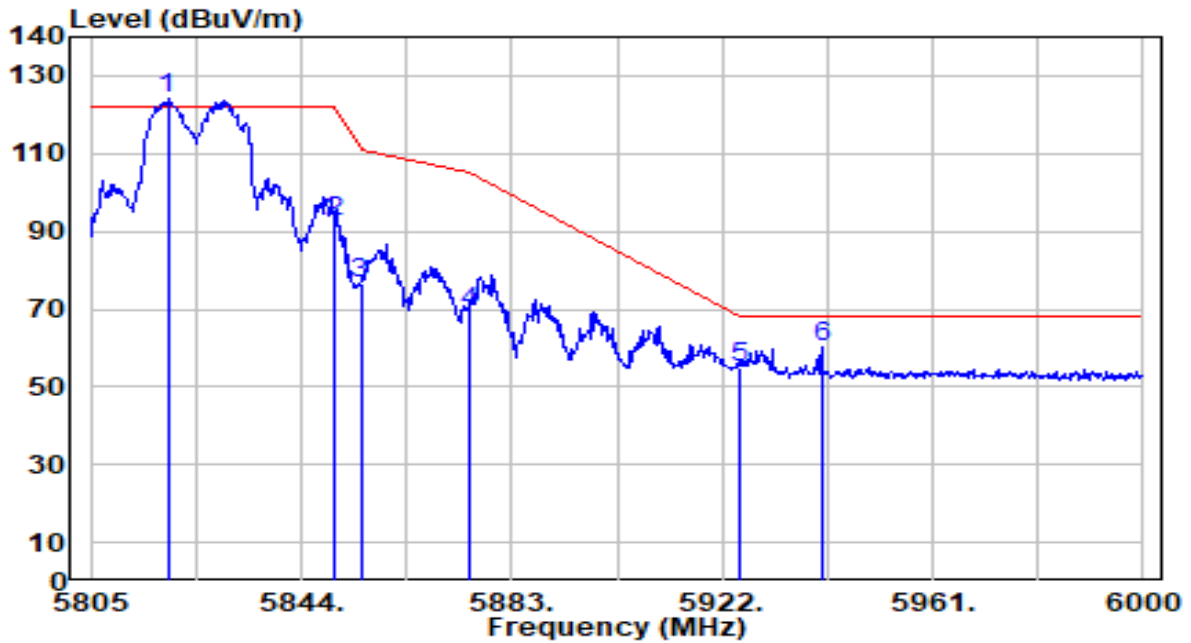

No	Frequency (MHz)	Reading (dBUV)	C.F (dB/m)	Measurement (dBUV/m)	Margin (dB)	Limit (dBUV/m)	Height (cm)	Angle (deg)	Remark (QP/PK/AV)
1	5819.235	123.61	0.61	124.22	N/A	N/A	200	352	Peak
2	5850.000	91.74	0.58	92.32	-29.88	122.20	200	352	Peak
3	5855.000	76.22	0.58	76.80	-34.00	110.80	200	352	Peak
4	5875.000	68.46	0.57	69.02	-36.18	105.20	200	352	Peak
5	5925.000	54.31	0.53	54.83	-13.37	68.20	200	352	Peak
6	* 5940.525	59.55	0.52	60.07	-8.13	68.20	200	352	Peak

Note:

1. " *", means this data is the worst emission level.
2. C.F (Correction Factor) = Antenna Factor (dB/m)+ Cable Loss (dB) – Preamplifier(dB) + 10dB Attenuation.
3. Measurement (dBUV/m) = Reading(dBUV) + C.F (Correction Factor).
4. The emission levels of other frequencies are very lower than the limit and not show in test report.

EUT	AX1800 Indoor/Outdoor Wi-Fi 6 Access Point	Date of Test	2023-09-21
Factor	DRH18-E	Temp. / Humidity	20°C /60%
Polarity	Horizontal	Site / Test Engineer	AC2 / Marvin
Test Mode	802.11ax-40MHz_Band1_TX_CH 38_ANT 0+1	Test Voltage	AC120V/60Hz

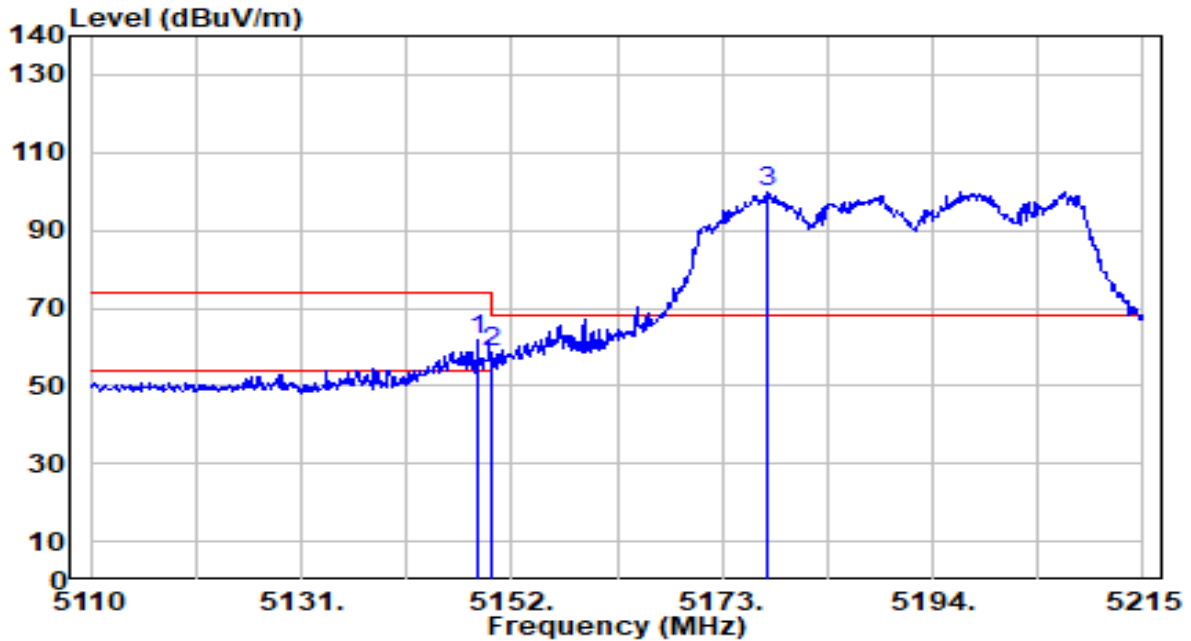

No	Frequency (MHz)	Reading (dBuV)	C.F (dB/m)	Measurement (dBuV/m)	Margin (dB)	Limit (dBuV/m)	Height (cm)	Angle (deg)	Remark (QP/PK/AV)
1	* 5148.640	62.49	-0.72	61.77	-12.23	74.00	121	336	Peak
2	5150.000	59.31	-0.72	58.59	-15.41	74.00	121	336	Peak
3	5177.515	100.62	-0.73	99.89	N/A	N/A	121	336	Peak

Note:

1. " *", means this data is the worst emission level.
2. C.F (Correction Factor) = Antenna Factor (dB/m)+ Cable Loss (dB) – Preamplifier(dB) + 10dB Attenuation.
3. Measurement (dBuV/m) = Reading(dBuV) + C.F (Correction Factor).
4. The emission levels of other frequencies are very lower than the limit and not show in test report.

EUT	AX1800 Indoor/Outdoor Wi-Fi 6 Access Point	Date of Test	2023-09-21
Factor	DRH18-E	Temp. / Humidity	20°C /60%
Polarity	Horizontal	Site / Test Engineer	AC2 / Marvin
Test Mode	802.11ax-40MHz_Band1_TX_CH 38_ANT 0+1	Test Voltage	AC120V/60Hz

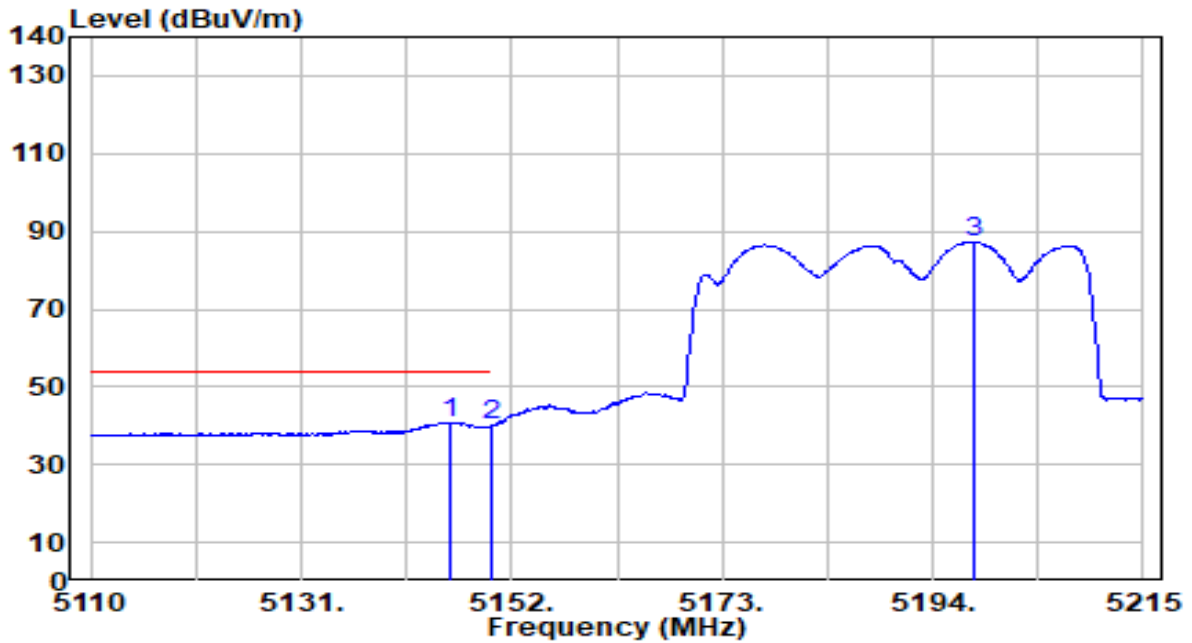

No	Frequency (MHz)	Reading (dBuV)	C.F (dB/m)	Measurement (dBuV/m)	Margin (dB)	Limit (dBuV/m)	Height (cm)	Angle (deg)	Remark (QP/PK/AV)	
1	*	5145.805	41.52	-0.72	40.80	-13.20	54.00	121	336	Average
2		5150.000	40.63	-0.72	39.91	-14.09	54.00	121	336	Average
3		5198.200	88.14	-0.74	87.39	N/A	N/A	121	336	Average

Note:

1. " *", means this data is the worst emission level.
2. C.F (Correction Factor) = Antenna Factor (dB/m)+ Cable Loss (dB) – Preamplifier(dB) + 10dB Attenuation.
3. Measurement (dBuV/m) = Reading(dBuV) + C.F (Correction Factor).
4. The emission levels of other frequencies are very lower than the limit and not show in test report.

EUT	AX1800 Indoor/Outdoor Wi-Fi 6 Access Point	Date of Test	2023-09-21
Factor	DRH18-E	Temp. / Humidity	20°C /60%
Polarity	Vertical	Site / Test Engineer	AC2 / Marvin
Test Mode	802.11ax-40MHz_Band1_TX_CH 38_ANT 0+1	Test Voltage	AC120V/60Hz

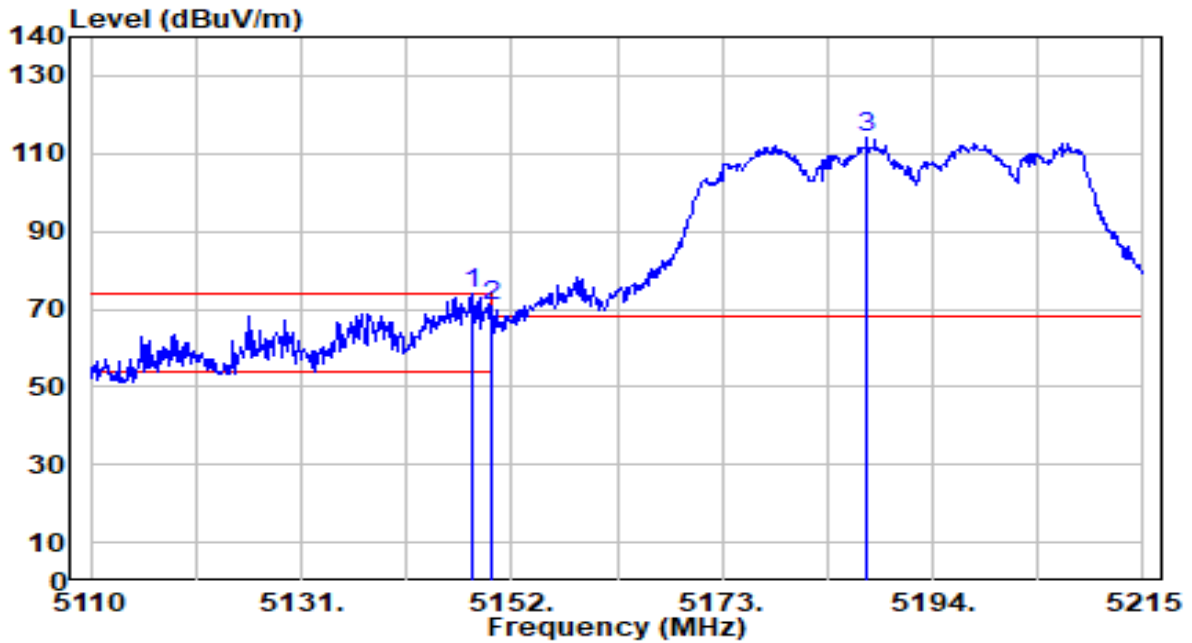

No	Frequency (MHz)	Reading (dBuV)	C.F (dB/m)	Measurement (dBuV/m)	Margin (dB)	Limit (dBuV/m)	Height (cm)	Angle (deg)	Remark (QP/PK/AV)	
1	*	5148.010	74.55	-0.72	73.83	-0.17	74.00	176	200	Peak
2		5150.000	71.48	-0.72	70.77	-3.23	74.00	176	200	Peak
3		5187.385	114.98	-0.74	114.25	N/A	N/A	176	200	Peak

Note:

1. " *", means this data is the worst emission level.
2. C.F (Correction Factor) = Antenna Factor (dB/m)+ Cable Loss (dB) – Preamplifier(dB) + 10dB Attenuation.
3. Measurement (dBuV/m) = Reading(dBuV) + C.F (Correction Factor).
4. The emission levels of other frequencies are very lower than the limit and not show in test report.

EUT	AX1800 Indoor/Outdoor Wi-Fi 6 Access Point	Date of Test	2023-09-21
Factor	DRH18-E	Temp. / Humidity	20°C /60%
Polarity	Vertical	Site / Test Engineer	AC2 / Marvin
Test Mode	802.11ax-40MHz_Band1_TX_CH 38_ANT 0+1	Test Voltage	AC120V/60Hz

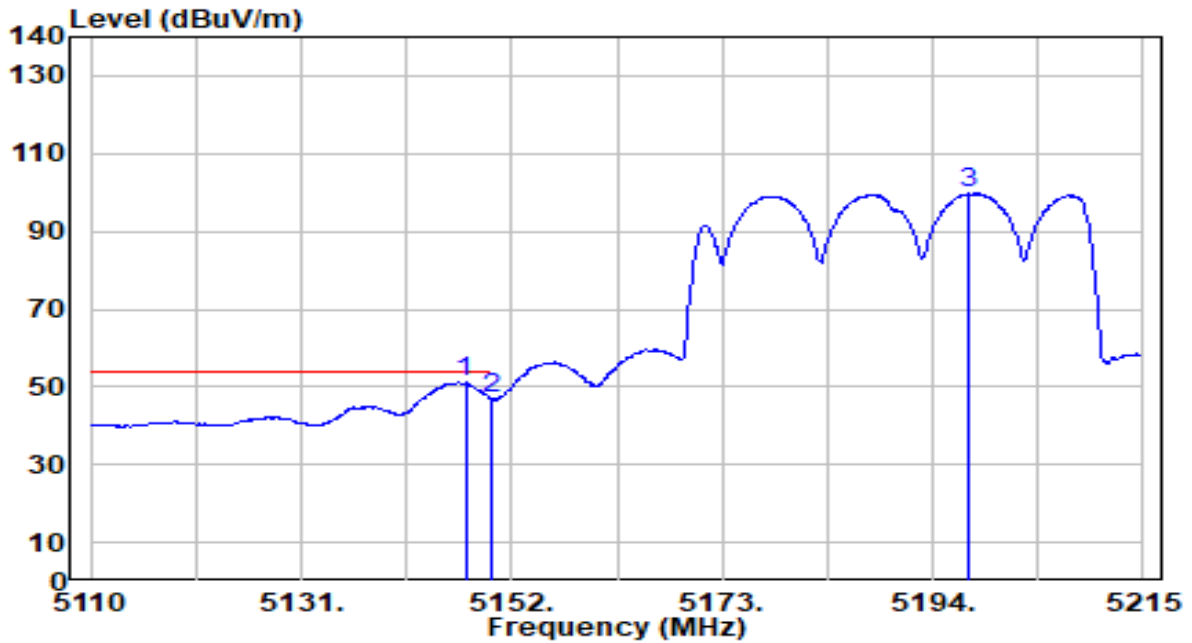

No	Frequency (MHz)	Reading (dBuV)	C.F (dB/m)	Measurement (dBuV/m)	Margin (dB)	Limit (dBuV/m)	Height (cm)	Angle (deg)	Remark (QP/PK/AV)
1	*	51.78	-0.72	51.06	-2.94	54.00	176	200	Average
2		47.86	-0.72	47.14	-6.86	54.00	176	200	Average
3		100.37	-0.74	99.63	N/A	N/A	176	200	Average

Note:

1. " *", means this data is the worst emission level.
2. C.F (Correction Factor) = Antenna Factor (dB/m)+ Cable Loss (dB) – Preamplifier(dB) + 10dB Attenuation.
3. Measurement (dBuV/m) = Reading(dBuV) + C.F (Correction Factor).
4. The emission levels of other frequencies are very lower than the limit and not show in test report.

EUT	AX1800 Indoor/Outdoor Wi-Fi 6 Access Point	Date of Test	2023-09-21
Factor	DRH18-E	Temp. / Humidity	20°C /60%
Polarity	Horizontal	Site / Test Engineer	AC2 / Marvin
Test Mode	802.11ax-40MHz_Band2_TX_CH 62_ANT 0+1	Test Voltage	AC120V/60Hz

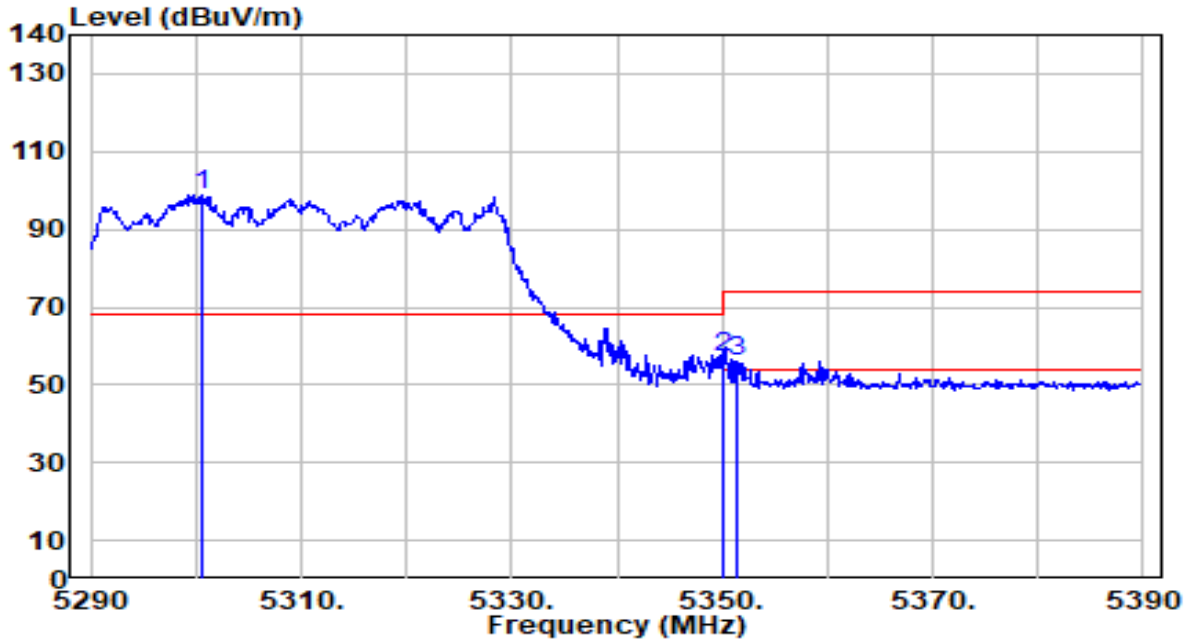

No	Frequency (MHz)	Reading (dBuV)	C.F (dB/m)	Measurement (dBuV/m)	Margin (dB)	Limit (dBuV/m)	Height (cm)	Angle (deg)	Remark (QP/PK/AV)
1	5300.600	99.77	-0.90	98.88	N/A	N/A	202	58	Peak
2	* 5350.000	58.03	-0.97	57.06	-16.94	74.00	202	58	Peak
3	5351.500	57.03	-0.97	56.06	-17.94	74.00	202	58	Peak

Note:

1. " *", means this data is the worst emission level.
2. C.F (Correction Factor) = Antenna Factor (dB/m)+ Cable Loss (dB) – Preamplifier(dB) + 10dB Attenuation.
3. Measurement (dBuV/m) = Reading(dBuV) + C.F (Correction Factor).
4. The emission levels of other frequencies are very lower than the limit and not show in test report.

EUT	AX1800 Indoor/Outdoor Wi-Fi 6 Access Point	Date of Test	2023-09-21
Factor	DRH18-E	Temp. / Humidity	20°C /60%
Polarity	Horizontal	Site / Test Engineer	AC2 / Marvin
Test Mode	802.11ax-40MHz_Band2_TX_CH 62_ANT 0+1	Test Voltage	AC120V/60Hz

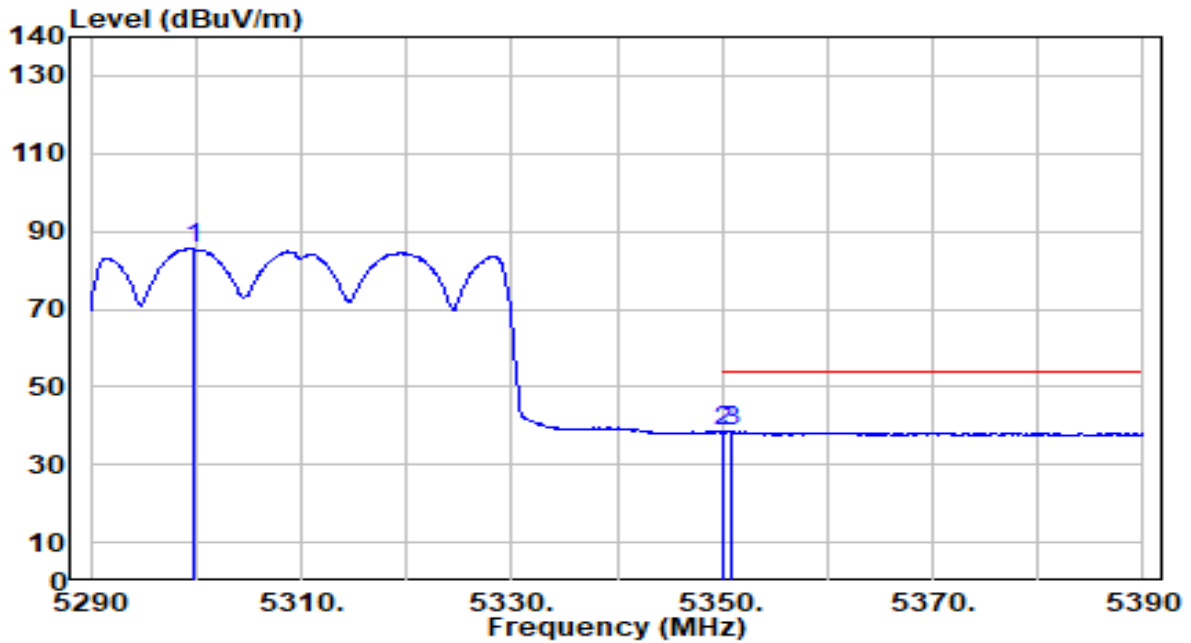

No	Frequency (MHz)	Reading (dBuV)	C.F (dB/m)	Measurement (dBuV/m)	Margin (dB)	Limit (dBuV/m)	Height (cm)	Angle (deg)	Remark (QP/PK/AV)
1	5299.900	86.40	-0.90	85.50	N/A	N/A	202	58	Average
2	5350.000	39.29	-0.97	38.32	-15.68	54.00	202	58	Average
3	* 5351.000	39.48	-0.97	38.50	-15.50	54.00	202	58	Average

Note:

1. " *", means this data is the worst emission level.
2. C.F (Correction Factor) = Antenna Factor (dB/m)+ Cable Loss (dB) – Preamplifier(dB) + 10dB Attenuation.
3. Measurement (dBuV/m) = Reading(dBuV) + C.F (Correction Factor).
4. The emission levels of other frequencies are very lower than the limit and not show in test report.

EUT	AX1800 Indoor/Outdoor Wi-Fi 6 Access Point	Date of Test	2023-09-21
Factor	DRH18-E	Temp. / Humidity	20°C /60%
Polarity	Vertical	Site / Test Engineer	AC2 / Marvin
Test Mode	802.11ax-40MHz_Band2_TX_CH 62_ANT 0+1	Test Voltage	AC120V/60Hz

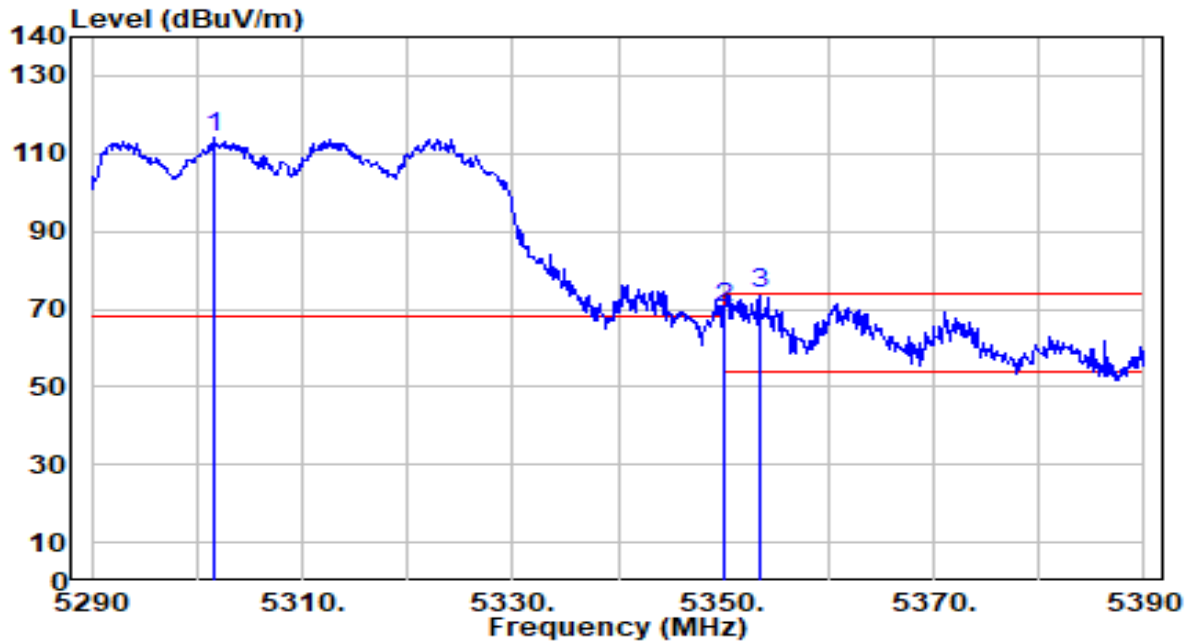

No	Frequency (MHz)	Reading (dBuV)	C.F (dB/m)	Measurement (dBuV/m)	Margin (dB)	Limit (dBuV/m)	Height (cm)	Angle (deg)	Remark (QP/PK/AV)
1	5301.600	114.83	-0.90	113.93	N/A	N/A	180	158	Peak
2	5350.000	71.40	-0.97	70.43	-3.57	74.00	180	158	Peak
3	* 5353.500	74.82	-0.98	73.84	-0.16	74.00	180	158	Peak

Note:

1. " *", means this data is the worst emission level.
2. C.F (Correction Factor) = Antenna Factor (dB/m)+ Cable Loss (dB) – Preamplifier(dB) + 10dB Attenuation.
3. Measurement (dBuV/m) = Reading(dBuV) + C.F (Correction Factor).
4. The emission levels of other frequencies are very lower than the limit and not show in test report.

EUT	AX1800 Indoor/Outdoor Wi-Fi 6 Access Point	Date of Test	2023-09-21
Factor	DRH18-E	Temp. / Humidity	20°C /60%
Polarity	Vertical	Site / Test Engineer	AC2 / Marvin
Test Mode	802.11ax-40MHz_Band2_TX_CH 62_ANT 0+1	Test Voltage	AC120V/60Hz

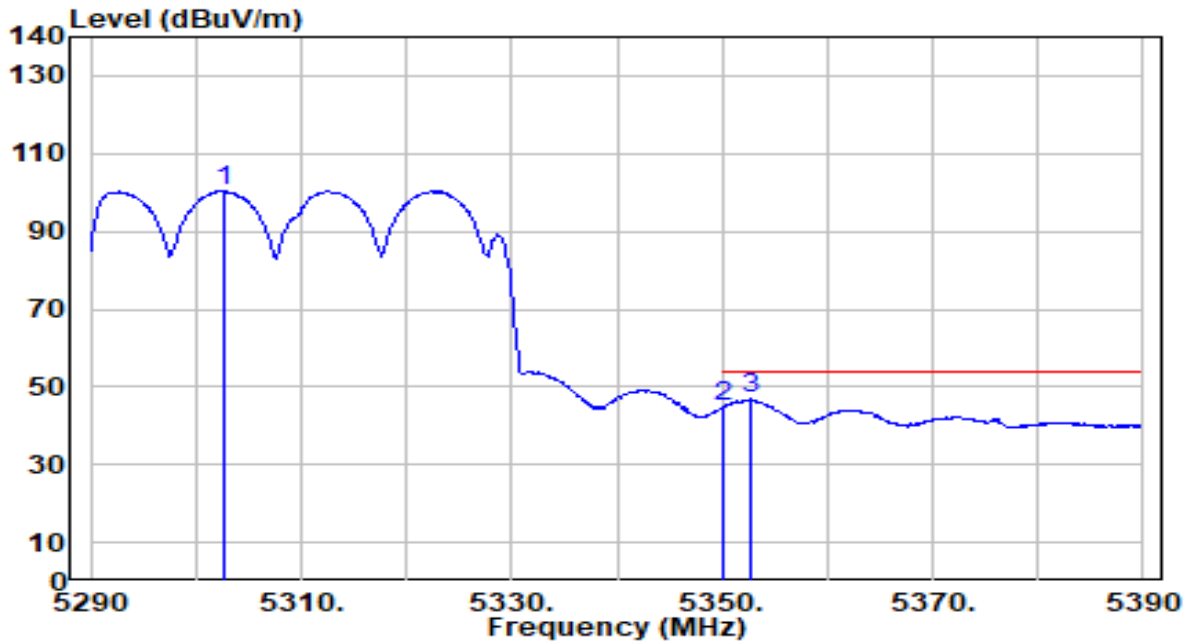

No	Frequency (MHz)	Reading (dBuV)	C.F (dB/m)	Measurement (dBuV/m)	Margin (dB)	Limit (dBuV/m)	Height (cm)	Angle (deg)	Remark (QP/PK/AV)
1	5302.700	101.23	-0.90	100.33	N/A	N/A	180	158	Average
2	5350.000	45.64	-0.97	44.67	-9.33	54.00	180	158	Average
3	* 5352.700	47.79	-0.98	46.81	-7.19	54.00	180	158	Average

Note:

1. " *", means this data is the worst emission level.
2. C.F (Correction Factor) = Antenna Factor (dB/m)+ Cable Loss (dB) – Preamplifier(dB) + 10dB Attenuation.
3. Measurement (dBuV/m) = Reading(dBuV) + C.F (Correction Factor).
4. The emission levels of other frequencies are very lower than the limit and not show in test report.

EUT	AX1800 Indoor/Outdoor Wi-Fi 6 Access Point	Date of Test	2023-09-21
Factor	DRH18-E	Temp. / Humidity	20°C /60%
Polarity	Horizontal	Site / Test Engineer	AC2 / Marvin
Test Mode	802.11ax-40MHz_Band3_TX_CH 102_ANT 0+1	Test Voltage	AC120V/60Hz

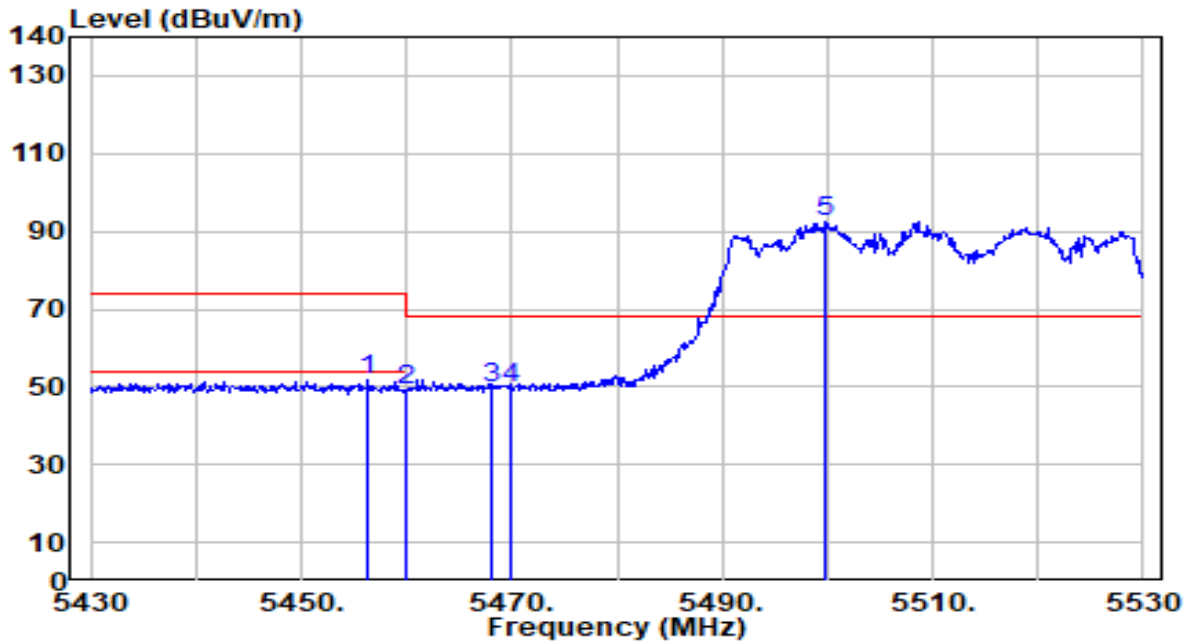

No	Frequency (MHz)	Reading (dBuV)	C.F (dB/m)	Measurement (dBuV/m)	Margin (dB)	Limit (dBuV/m)	Height (cm)	Angle (deg)	Remark (QP/PK/AV)
1	5456.300	52.49	-0.88	51.61	-22.39	74.00	200	56	Peak
2	5460.000	49.99	-0.87	49.12	-24.88	74.00	200	56	Peak
3	5468.200	50.65	-0.84	49.81	-18.39	68.20	200	56	Peak
4	* 5470.000	50.71	-0.84	49.88	-18.32	68.20	200	56	Peak
5	5499.800	93.18	-0.75	92.43	N/A	N/A	200	56	Peak

Note:

1. " *", means this data is the worst emission level.
2. C.F (Correction Factor) = Antenna Factor (dB/m)+ Cable Loss (dB) – Preamplifier(dB) + 10dB Attenuation.
3. Measurement (dBuV/m) = Reading(dBuV) + C.F (Correction Factor).
4. The emission levels of other frequencies are very lower than the limit and not show in test report.

EUT	AX1800 Indoor/Outdoor Wi-Fi 6 Access Point	Date of Test	2023-09-21
Factor	DRH18-E	Temp. / Humidity	20°C /60%
Polarity	Horizontal	Site / Test Engineer	AC2 / Marvin
Test Mode	802.11ax-40MHz_Band3_TX_CH 102_ANT 0+1	Test Voltage	AC120V/60Hz

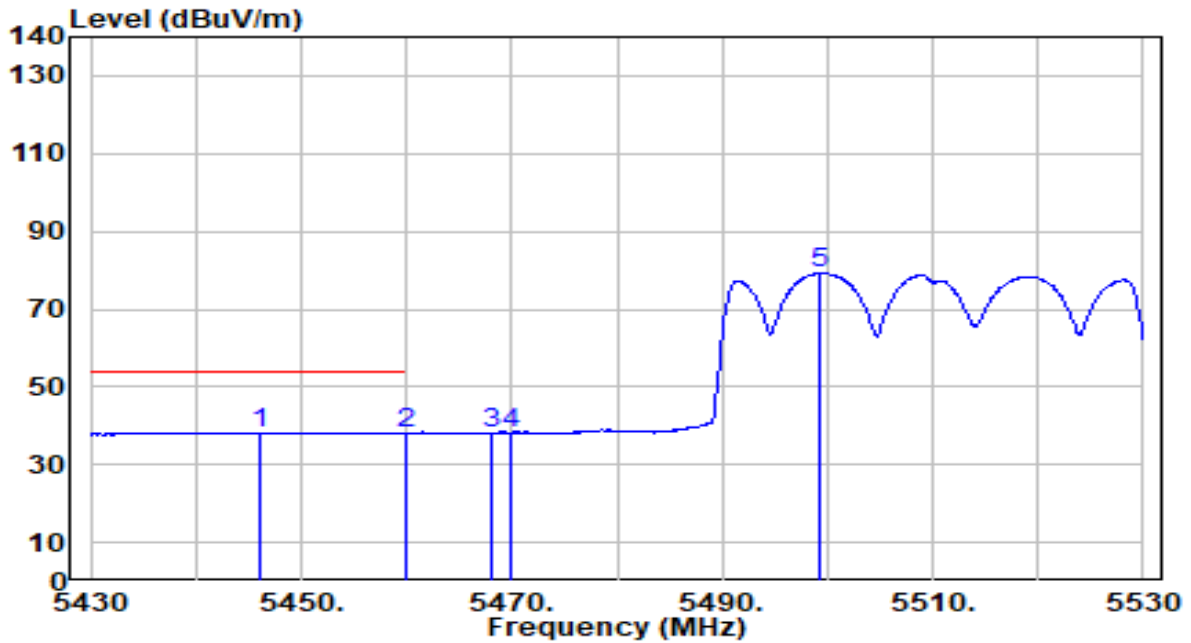

No	Frequency (MHz)	Reading (dBuV)	C.F (dB/m)	Measurement (dBuV/m)	Margin (dB)	Limit (dBuV/m)	Height (cm)	Angle (deg)	Remark (QP/PK/AV)	
1	*	5446.100	39.11	-0.91	38.20	-15.80	54.00	200	56	Average
2		5460.000	38.88	-0.87	38.01	-15.99	54.00	200	56	Average
3		5468.200	39.09	-0.84	38.24	N/A	N/A	200	56	Average
4		5470.000	39.09	-0.84	38.25	N/A	N/A	200	56	Average
5		5499.200	80.05	-0.75	79.30	N/A	N/A	200	56	Average

Note:

1. " *", means this data is the worst emission level.
2. C.F (Correction Factor) = Antenna Factor (dB/m)+ Cable Loss (dB) – Preamplifier(dB) + 10dB Attenuation.
3. Measurement (dBuV/m) = Reading(dBuV) + C.F (Correction Factor).
4. The emission levels of other frequencies are very lower than the limit and not show in test report.

EUT	AX1800 Indoor/Outdoor Wi-Fi 6 Access Point	Date of Test	2023-09-21
Factor	DRH18-E	Temp. / Humidity	20°C /60%
Polarity	Vertical	Site / Test Engineer	AC2 / Marvin
Test Mode	802.11ax-40MHz_Band3_TX_CH 102_ANT 0+1	Test Voltage	AC120V/60Hz

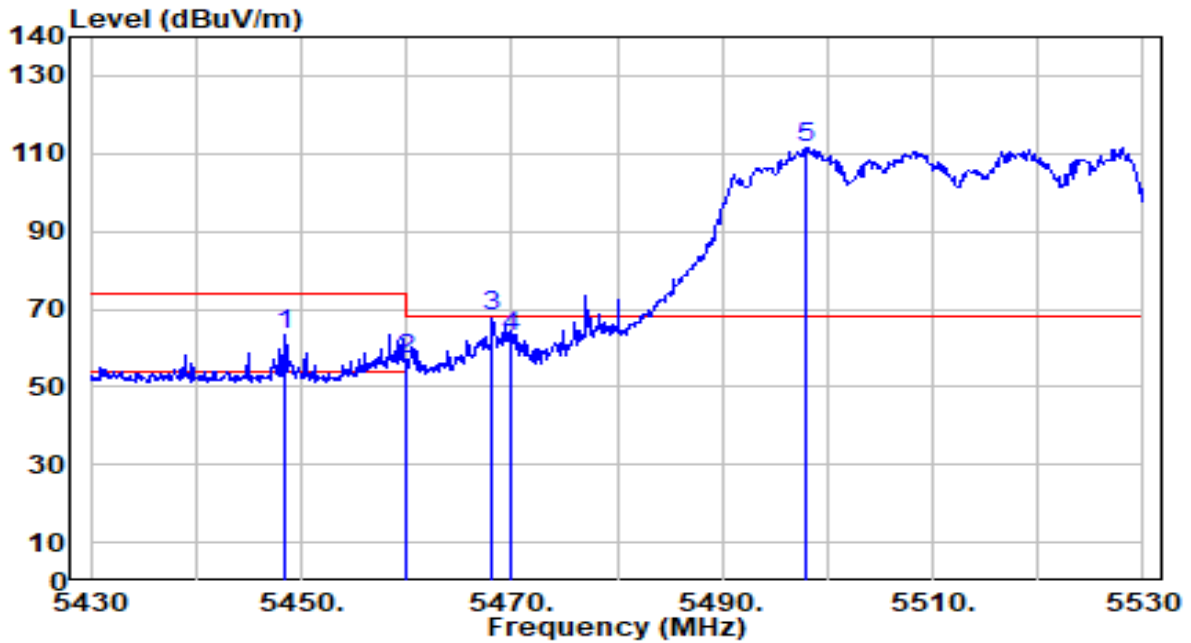

No	Frequency (MHz)	Reading (dBuV)	C.F (dB/m)	Measurement (dBuV/m)	Margin (dB)	Limit (dBuV/m)	Height (cm)	Angle (deg)	Remark (QP/PK/AV)
1	5448.500	64.48	-0.90	63.58	-10.42	74.00	178	149	Peak
2	5460.000	57.97	-0.87	57.10	-16.90	74.00	178	149	Peak
3	* 5468.200	68.87	-0.84	68.03	-0.17	68.20	178	149	Peak
4	5470.000	63.48	-0.84	62.64	-5.56	68.20	178	149	Peak
5	5498.000	112.26	-0.76	111.50	N/A	N/A	178	149	Peak

Note:

1. " *", means this data is the worst emission level.
2. C.F (Correction Factor) = Antenna Factor (dB/m)+ Cable Loss (dB) – Preamplifier(dB) + 10dB Attenuation.
3. Measurement (dBuV/m) = Reading(dBuV) + C.F (Correction Factor).
4. The emission levels of other frequencies are very lower than the limit and not show in test report.

EUT	AX1800 Indoor/Outdoor Wi-Fi 6 Access Point	Date of Test	2023-09-21
Factor	DRH18-E	Temp. / Humidity	20°C /60%
Polarity	Vertical	Site / Test Engineer	AC2 / Marvin
Test Mode	802.11ax-40MHz_Band3_TX_CH 102_ANT 0+1	Test Voltage	AC120V/60Hz

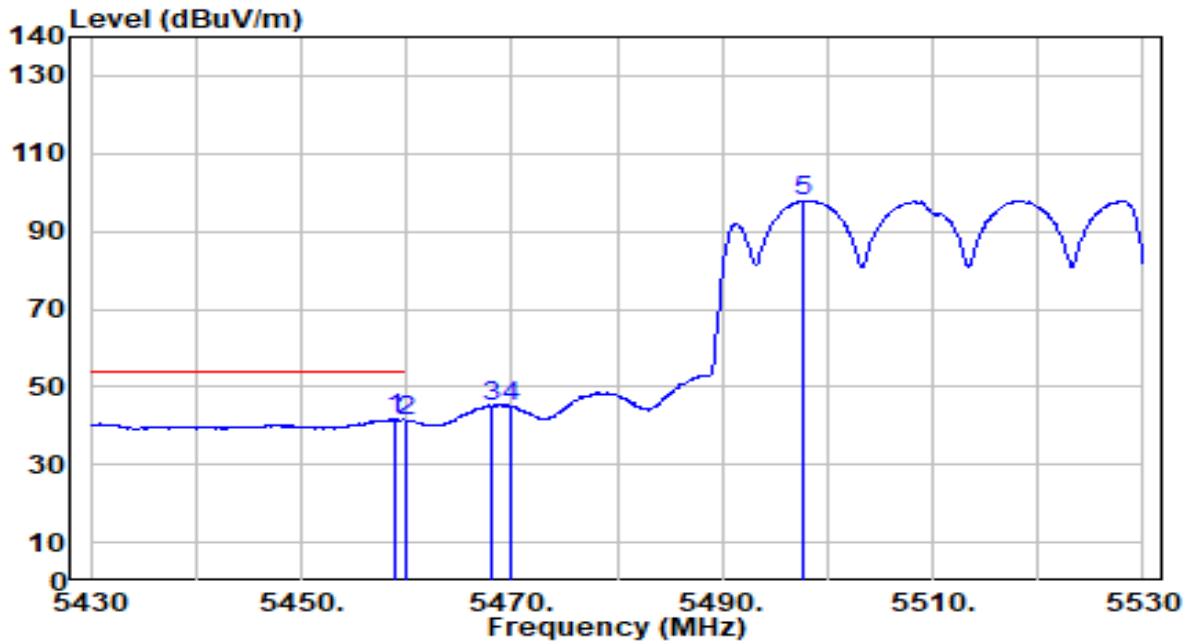

No	Frequency (MHz)	Reading (dBuV)	C.F (dB/m)	Measurement (dBuV/m)	Margin (dB)	Limit (dBuV/m)	Height (cm)	Angle (deg)	Remark (QP/PK/AV)	
1	*	5459.000	42.47	-0.87	41.60	-12.40	54.00	178	149	Average
2		5460.000	42.04	-0.87	41.17	-12.83	54.00	178	149	Average
3		5468.200	45.92	-0.84	45.08	N/A	N/A	178	149	Average
4		5470.000	45.70	-0.84	44.86	N/A	N/A	178	149	Average
5		5497.700	98.73	-0.76	97.97	N/A	N/A	178	149	Average

Note:

1. " *", means this data is the worst emission level.
2. C.F (Correction Factor) = Antenna Factor (dB/m)+ Cable Loss (dB) – Preamplifier(dB) + 10dB Attenuation.
3. Measurement (dBuV/m) = Reading(dBuV) + C.F (Correction Factor).
4. The emission levels of other frequencies are very lower than the limit and not show in test report.

EUT	AX1800 Indoor/Outdoor Wi-Fi 6 Access Point	Date of Test	2023-09-21
Factor	DRH18-E	Temp. / Humidity	20°C /60%
Polarity	Horizontal	Site / Test Engineer	AC2 / Marvin
Test Mode	802.11ax-40MHz_Band3_TX_CH 134_ANT 0+1	Test Voltage	AC120V/60Hz

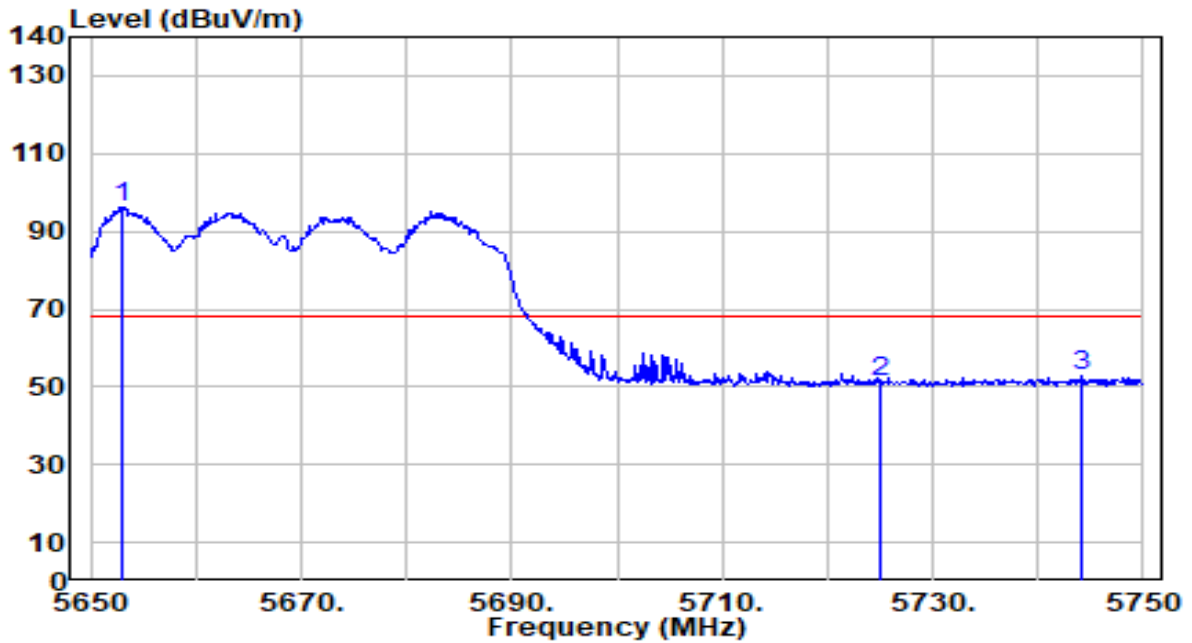

No	Frequency (MHz)	Reading (dBuV)	C.F (dB/m)	Measurement (dBuV/m)	Margin (dB)	Limit (dBuV/m)	Height (cm)	Angle (deg)	Remark (QP/PK/AV)
1	5653.100	96.39	-0.15	96.24	N/A	N/A	119	2	Peak
2	5725.000	51.22	0.23	51.45	-16.75	68.20	119	2	Peak
3	* 5744.200	52.55	0.33	52.88	-15.32	68.20	119	2	Peak

Note:

1. " *", means this data is the worst emission level.
2. C.F (Correction Factor) = Antenna Factor (dB/m)+ Cable Loss (dB) – Preamplifier(dB) + 10dB Attenuation.
3. Measurement (dBuV/m) = Reading(dBuV) + C.F (Correction Factor).
4. The emission levels of other frequencies are very lower than the limit and not show in test report.

EUT	AX1800 Indoor/Outdoor Wi-Fi 6 Access Point	Date of Test	2023-09-21
Factor	DRH18-E	Temp. / Humidity	20°C /60%
Polarity	Vertical	Site / Test Engineer	AC2 / Marvin
Test Mode	802.11ax-40MHz_Band3_TX_CH 134_ANT 0+1	Test Voltage	AC120V/60Hz

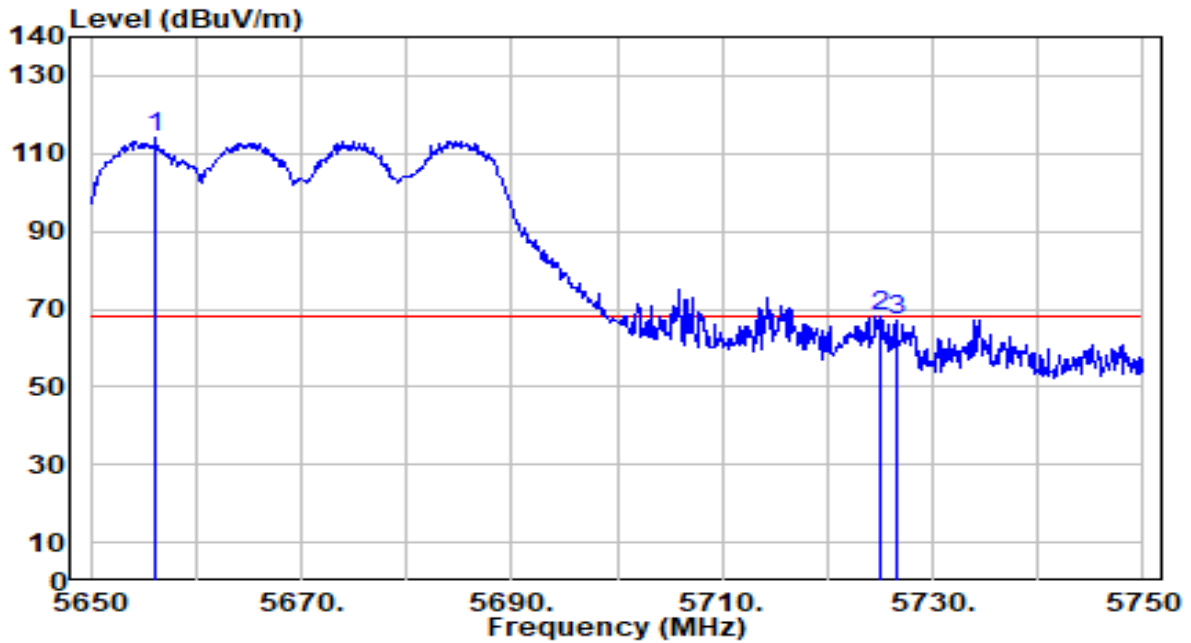

No	Frequency (MHz)	Reading (dBuV)	C.F (dB/m)	Measurement (dBuV/m)	Margin (dB)	Limit (dBuV/m)	Height (cm)	Angle (deg)	Remark (QP/PK/AV)
1	5656.100	114.38	-0.13	114.25	N/A	N/A	200	237	Peak
2	* 5725.000	67.86	0.23	68.09	-0.11	68.20	200	237	Peak
3	5726.500	66.75	0.24	66.99	-1.21	68.20	200	237	Peak

Note:

1. " *", means this data is the worst emission level.
2. C.F (Correction Factor) = Antenna Factor (dB/m)+ Cable Loss (dB) – Preamplifier(dB) + 10dB Attenuation.
3. Measurement (dBuV/m) = Reading(dBuV) + C.F (Correction Factor).
4. The emission levels of other frequencies are very lower than the limit and not show in test report.

EUT	AX1800 Indoor/Outdoor Wi-Fi 6 Access Point	Date of Test	2023-09-21
Factor	DRH18-E	Temp. / Humidity	20°C /60%
Polarity	Horizontal	Site / Test Engineer	AC2 / Marvin
Test Mode	802.11ax-40MHz_Band4_TX_CH 151_ANT 0+1	Test Voltage	AC120V/60Hz

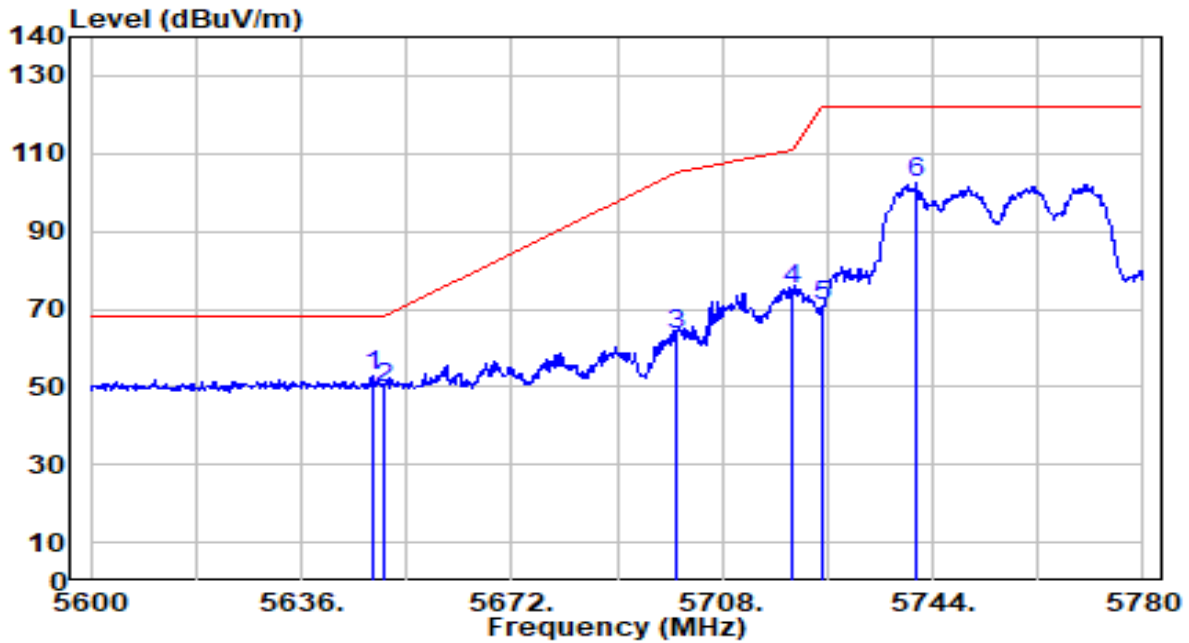

No	Frequency (MHz)	Reading (dBuV)	C.F (dB/m)	Measurement (dBuV/m)	Margin (dB)	Limit (dBuV/m)	Height (cm)	Angle (deg)	Remark (QP/PK/AV)	
1	*	5648.060	52.81	-0.17	52.63	-15.57	68.20	100	20	Peak
2		5650.000	49.87	-0.16	49.70	-18.50	68.20	100	20	Peak
3		5700.000	63.19	0.10	63.28	-41.92	105.20	100	20	Peak
4		5720.000	74.78	0.20	74.98	-35.82	110.80	100	20	Peak
5		5725.000	70.66	0.23	70.89	-51.31	122.20	100	20	Peak
6		5741.300	102.05	0.31	102.36	N/A	N/A	100	20	Peak

Note:

1. " *", means this data is the worst emission level.
2. C.F (Correction Factor) = Antenna Factor (dB/m)+ Cable Loss (dB) – Preamplifier(dB) + 10dB Attenuation.
3. Measurement (dBuV/m) = Reading(dBuV) + C.F (Correction Factor).
4. The emission levels of other frequencies are very lower than the limit and not show in test report.

EUT	AX1800 Indoor/Outdoor Wi-Fi 6 Access Point	Date of Test	2023-09-21
Factor	DRH18-E	Temp. / Humidity	20°C /60%
Polarity	Vertical	Site / Test Engineer	AC2 / Marvin
Test Mode	802.11ax-40MHz_Band4_TX_CH 151_ANT 0+1	Test Voltage	AC120V/60Hz

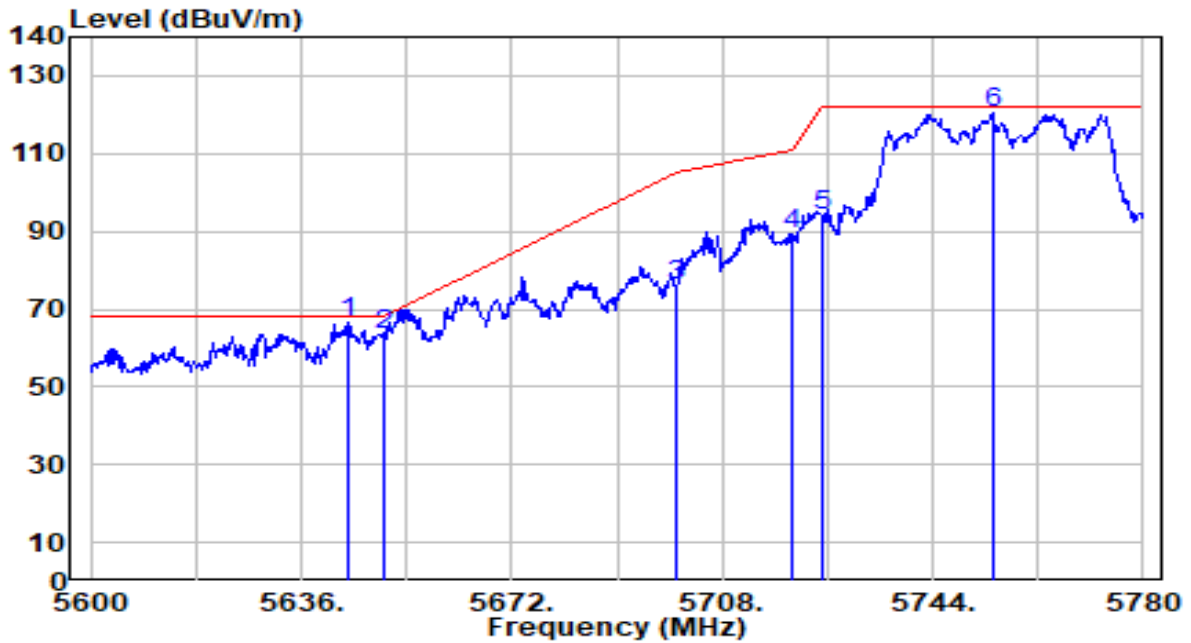

No	Frequency (MHz)	Reading (dBUV)	C.F (dB/m)	Measurement (dBUV/m)	Margin (dB)	Limit (dBUV/m)	Height (cm)	Angle (deg)	Remark (QP/PK/AV)
1	*	66.66	-0.19	66.46	-1.74	68.20	200	352	Peak
2		63.71	-0.16	63.55	-4.65	68.20	200	352	Peak
3		76.18	0.10	76.28	-28.92	105.20	200	352	Peak
4		88.99	0.20	89.19	-21.61	110.80	200	352	Peak
5		93.65	0.23	93.88	-28.32	122.20	200	352	Peak
6		119.92	0.38	120.30	N/A	N/A	200	352	Peak

Note:

1. " *", means this data is the worst emission level.
2. C.F (Correction Factor) = Antenna Factor (dB/m)+ Cable Loss (dB) – Preamplifier(dB) + 10dB Attenuation.
3. Measurement (dBUV/m) = Reading(dBUV) + C.F (Correction Factor).
4. The emission levels of other frequencies are very lower than the limit and not show in test report.

EUT	AX1800 Indoor/Outdoor Wi-Fi 6 Access Point	Date of Test	2023-09-21
Factor	DRH18-E	Temp. / Humidity	20°C /60%
Polarity	Horizontal	Site / Test Engineer	AC2 / Marvin
Test Mode	802.11ax-40MHz_Band4_TX_CH 159_ANT 0+1	Test Voltage	AC120V/60Hz

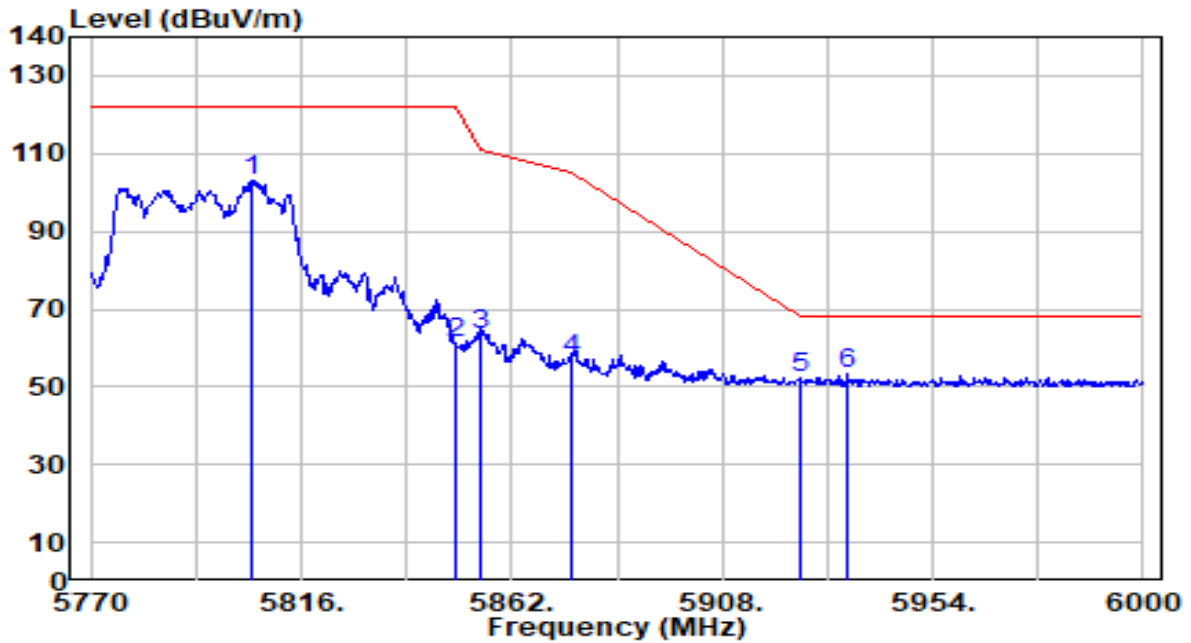

No	Frequency (MHz)	Reading (dBuV)	C.F (dB/m)	Measurement (dBuV/m)	Margin (dB)	Limit (dBuV/m)	Height (cm)	Angle (deg)	Remark (QP/PK/AV)
1	5804.960	102.45	0.62	103.07	N/A	N/A	200	28	Peak
2	5850.000	60.66	0.58	61.25	-60.95	122.20	200	28	Peak
3	5855.000	62.94	0.58	63.52	-47.28	110.80	200	28	Peak
4	5875.000	56.57	0.57	57.13	-48.07	105.20	200	28	Peak
5	5925.000	51.57	0.53	52.09	-16.11	68.20	200	28	Peak
6	* 5935.600	52.76	0.52	53.28	-14.92	68.20	200	28	Peak

Note:

1. " *", means this data is the worst emission level.
2. C.F (Correction Factor) = Antenna Factor (dB/m)+ Cable Loss (dB) – Preamplifier(dB) + 10dB Attenuation.
3. Measurement (dBuV/m) = Reading(dBuV) + C.F (Correction Factor).
4. The emission levels of other frequencies are very lower than the limit and not show in test report.

EUT	AX1800 Indoor/Outdoor Wi-Fi 6 Access Point	Date of Test	2023-09-21
Factor	DRH18-E	Temp. / Humidity	20°C /60%
Polarity	Vertical	Site / Test Engineer	AC2 / Marvin
Test Mode	802.11ax-40MHz_Band4_TX_CH 159_ANT 0+1	Test Voltage	AC120V/60Hz

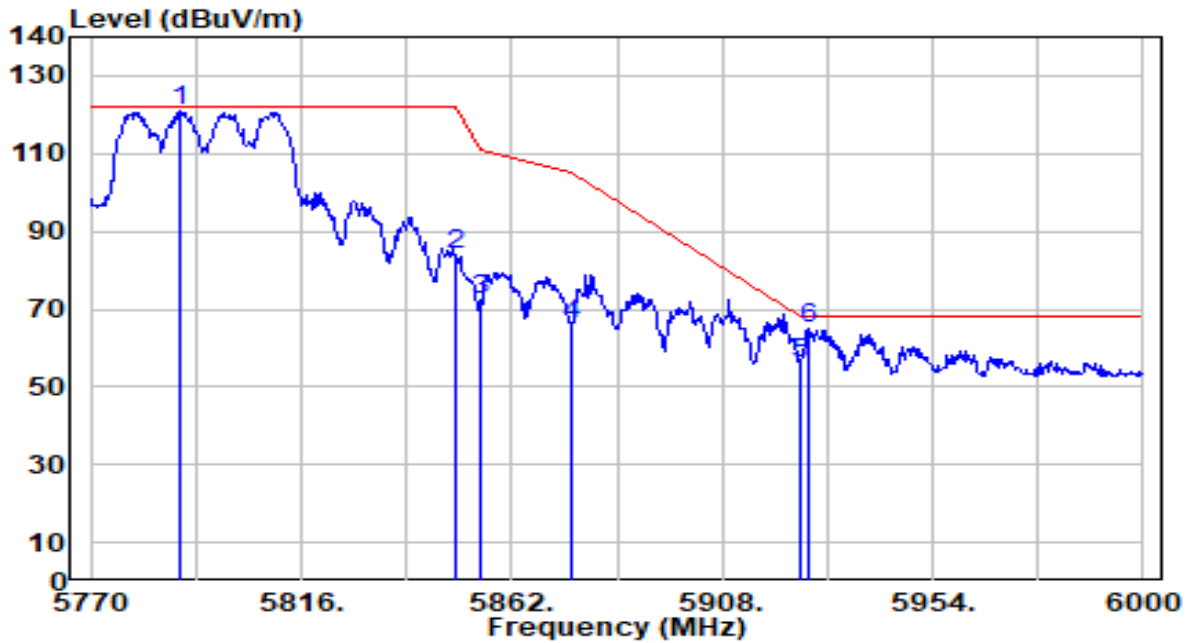

No	Frequency (MHz)	Reading (dBuV)	C.F (dB/m)	Measurement (dBuV/m)	Margin (dB)	Limit (dBuV/m)	Height (cm)	Angle (deg)	Remark (QP/PK/AV)
1	5789.780	120.26	0.57	120.83	N/A	N/A	192	350	Peak
2	5850.000	83.32	0.58	83.90	-38.30	122.20	192	350	Peak
3	5855.000	71.56	0.58	72.14	-38.66	110.80	192	350	Peak
4	5875.000	65.60	0.57	66.16	-39.04	105.20	192	350	Peak
5	5925.000	55.60	0.53	56.13	-12.07	68.20	192	350	Peak
6	* 5926.860	64.50	0.53	65.02	-3.18	68.20	192	350	Peak

Note:

1. " *", means this data is the worst emission level.
2. C.F (Correction Factor) = Antenna Factor (dB/m)+ Cable Loss (dB) – Preamplifier(dB) + 10dB Attenuation.
3. Measurement (dBuV/m) = Reading(dBuV) + C.F (Correction Factor).
4. The emission levels of other frequencies are very lower than the limit and not show in test report.

EUT	AX1800 Indoor/Outdoor Wi-Fi 6 Access Point	Date of Test	2023-09-21
Factor	DRH18-E	Temp. / Humidity	20°C /60%
Polarity	Horizontal	Site / Test Engineer	AC2 / Marvin
Test Mode	802.11ax-80MHz_Band1_TX_CH 42_ANT 0+1	Test Voltage	AC120V/60Hz

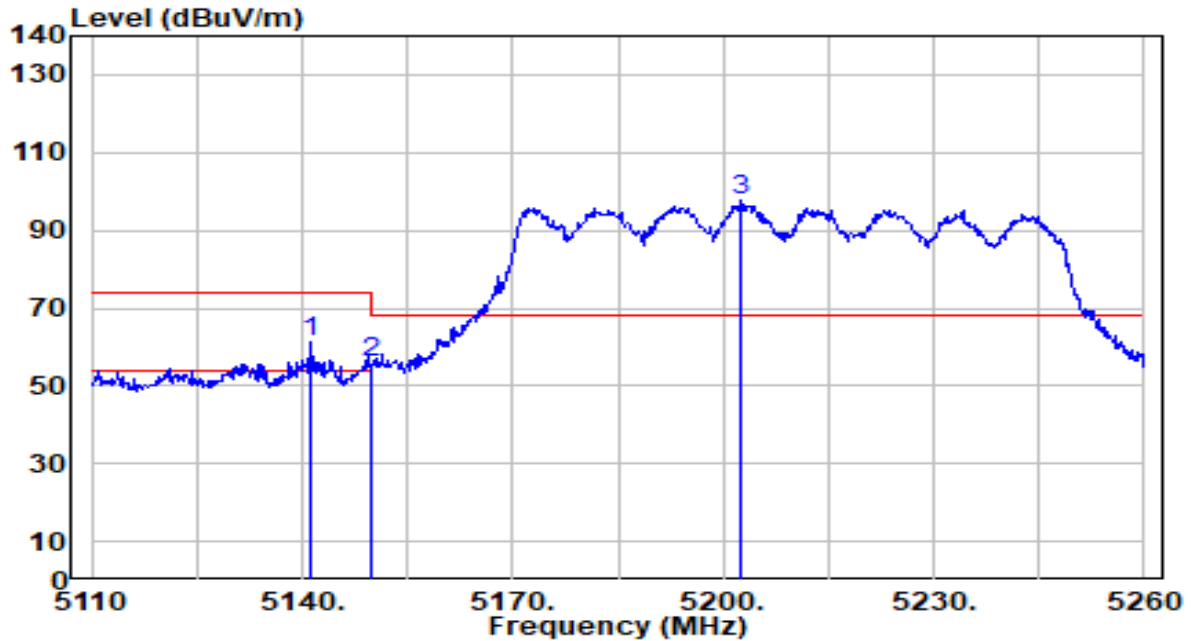

No	Frequency (MHz)	Reading (dBUV)	C.F (dB/m)	Measurement (dBUV/m)	Margin (dB)	Limit (dBUV/m)	Height (cm)	Angle (deg)	Remark (QP/PK/AV)
1	* 5141.050	61.92	-0.71	61.21	-12.79	74.00	120	335	Peak
2	5150.000	56.84	-0.72	56.12	-17.88	74.00	120	335	Peak
3	5202.400	98.46	-0.75	97.71	N/A	N/A	120	335	Peak

Note:

1. " *", means this data is the worst emission level.
2. C.F (Correction Factor) = Antenna Factor (dB/m)+ Cable Loss (dB) – Preamplifier(dB) + 10dB Attenuation.
3. Measurement (dBUV/m) = Reading(dBUV) + C.F (Correction Factor).
4. The emission levels of other frequencies are very lower than the limit and not show in test report.

EUT	AX1800 Indoor/Outdoor Wi-Fi 6 Access Point	Date of Test	2023-09-21
Factor	DRH18-E	Temp. / Humidity	20°C /60%
Polarity	Horizontal	Site / Test Engineer	AC2 / Marvin
Test Mode	802.11ax-80MHz_Band1_TX_CH 42_ANT 0+1	Test Voltage	AC120V/60Hz

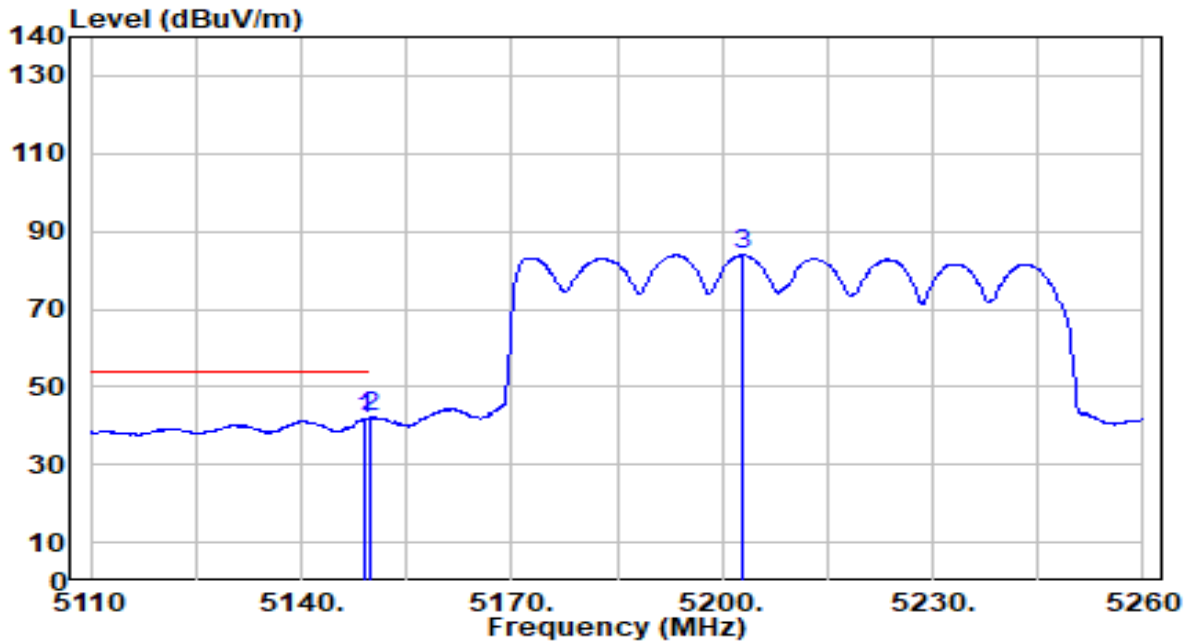

No	Frequency (MHz)	Reading (dBuV)	C.F (dB/m)	Measurement (dBuV/m)	Margin (dB)	Limit (dBuV/m)	Height (cm)	Angle (deg)	Remark (QP/PK/AV)
1	5149.150	42.61	-0.72	41.90	-12.10	54.00	120	335	Average
2	* 5150.000	42.82	-0.72	42.10	-11.90	54.00	120	335	Average
3	5203.000	84.71	-0.75	83.96	N/A	N/A	120	335	Average

Note:

1. " *", means this data is the worst emission level.
2. C.F (Correction Factor) = Antenna Factor (dB/m)+ Cable Loss (dB) – Preamplifier(dB) + 10dB Attenuation.
3. Measurement (dBuV/m) = Reading(dBuV) + C.F (Correction Factor).
4. The emission levels of other frequencies are very lower than the limit and not show in test report.

EUT	AX1800 Indoor/Outdoor Wi-Fi 6 Access Point	Date of Test	2023-09-21
Factor	DRH18-E	Temp. / Humidity	20°C /60%
Polarity	Vertical	Site / Test Engineer	AC2 / Marvin
Test Mode	802.11ax-80MHz_Band1_TX_CH 42_ANT 0+1	Test Voltage	AC120V/60Hz

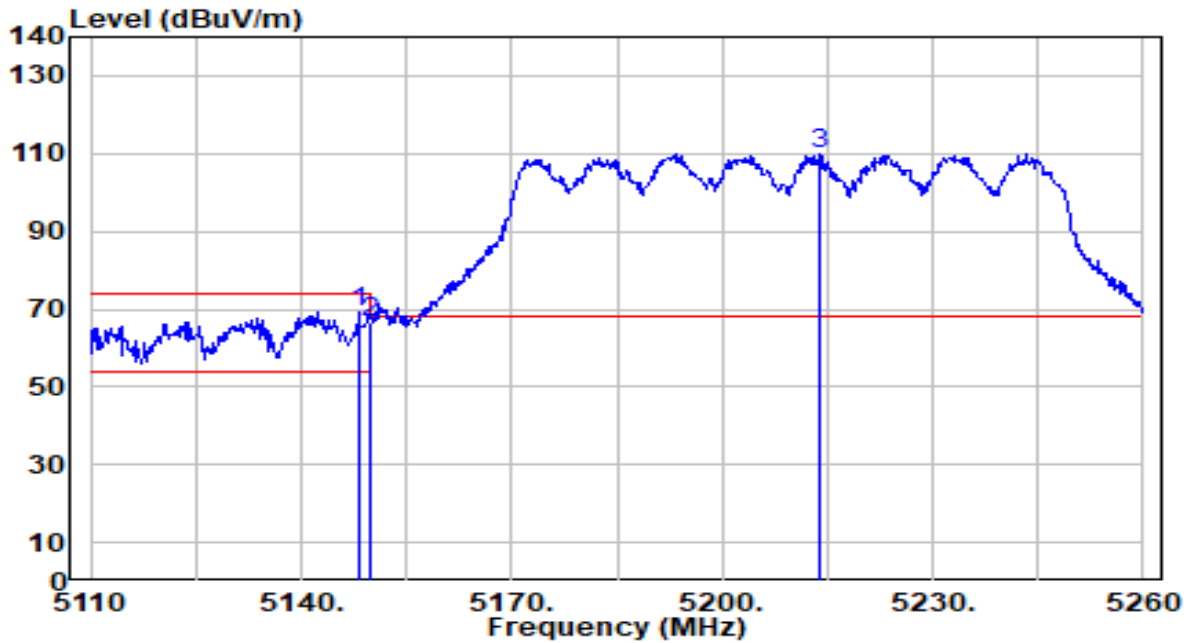

No	Frequency (MHz)	Reading (dBuV)	C.F (dB/m)	Measurement (dBuV/m)	Margin (dB)	Limit (dBuV/m)	Height (cm)	Angle (deg)	Remark (QP/PK/AV)	
1	*	5148.100	69.77	-0.72	69.05	-4.95	74.00	174	200	Peak
2		5150.000	67.48	-0.72	66.76	-7.24	74.00	174	200	Peak
3		5213.800	110.53	-0.76	109.77	N/A	N/A	174	200	Peak

Note:

1. " *", means this data is the worst emission level.
2. C.F (Correction Factor) = Antenna Factor (dB/m)+ Cable Loss (dB) – Preamplifier(dB) + 10dB Attenuation.
3. Measurement (dBuV/m) = Reading(dBuV) + C.F (Correction Factor).
4. The emission levels of other frequencies are very lower than the limit and not show in test report.

EUT	AX1800 Indoor/Outdoor Wi-Fi 6 Access Point	Date of Test	2023-09-21
Factor	DRH18-E	Temp. / Humidity	20°C /60%
Polarity	Vertical	Site / Test Engineer	AC2 / Marvin
Test Mode	802.11ax-80MHz_Band1_TX_CH 42_ANT 0+1	Test Voltage	AC120V/60Hz

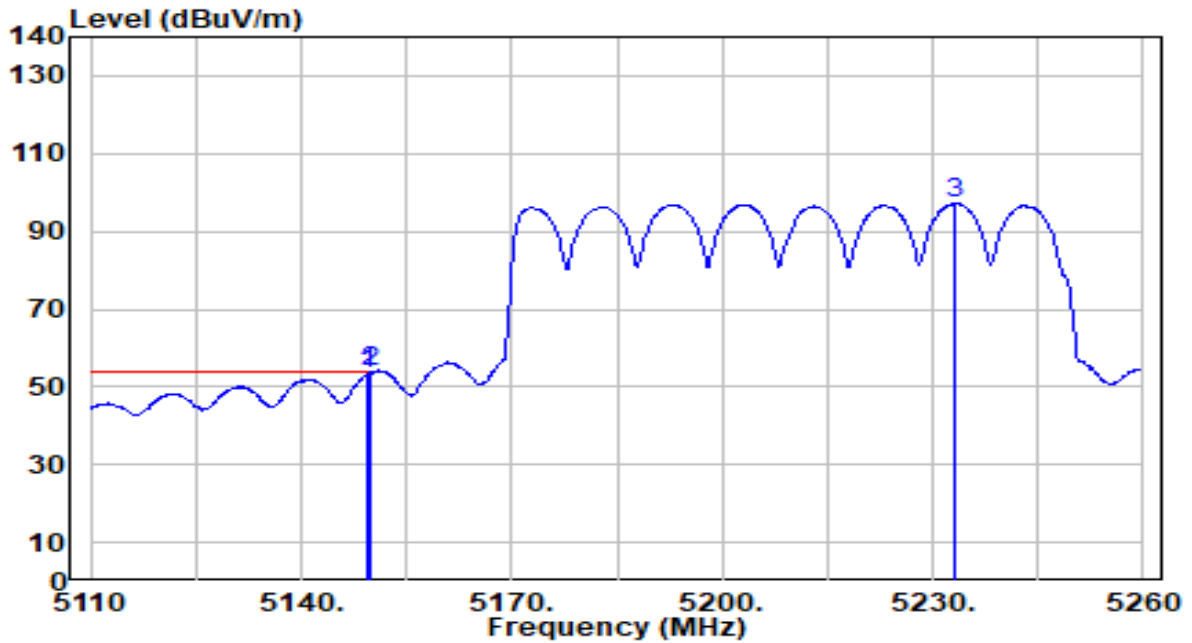

No	Frequency (MHz)	Reading (dBuV)	C.F (dB/m)	Measurement (dBuV/m)	Margin (dB)	Limit (dBuV/m)	Height (cm)	Angle (deg)	Remark (QP/PK/AV)
1	5149.450	53.89	-0.72	53.17	-0.83	54.00	174	200	Average
2	* 5150.000	54.59	-0.72	53.88	-0.12	54.00	174	200	Average
3	5233.300	97.87	-0.79	97.08	N/A	N/A	174	200	Average

Note:

1. " *", means this data is the worst emission level.
2. C.F (Correction Factor) = Antenna Factor (dB/m)+ Cable Loss (dB) – Preamplifier(dB) + 10dB Attenuation.
3. Measurement (dBuV/m) = Reading(dBuV) + C.F (Correction Factor).
4. The emission levels of other frequencies are very lower than the limit and not show in test report.

EUT	AX1800 Indoor/Outdoor Wi-Fi 6 Access Point	Date of Test	2023-09-21
Factor	DRH18-E	Temp. / Humidity	20°C /60%
Polarity	Horizontal	Site / Test Engineer	AC2 / Marvin
Test Mode	802.11ax-80MHz_Band2_TX_CH 58_ANT 0+1	Test Voltage	AC120V/60Hz

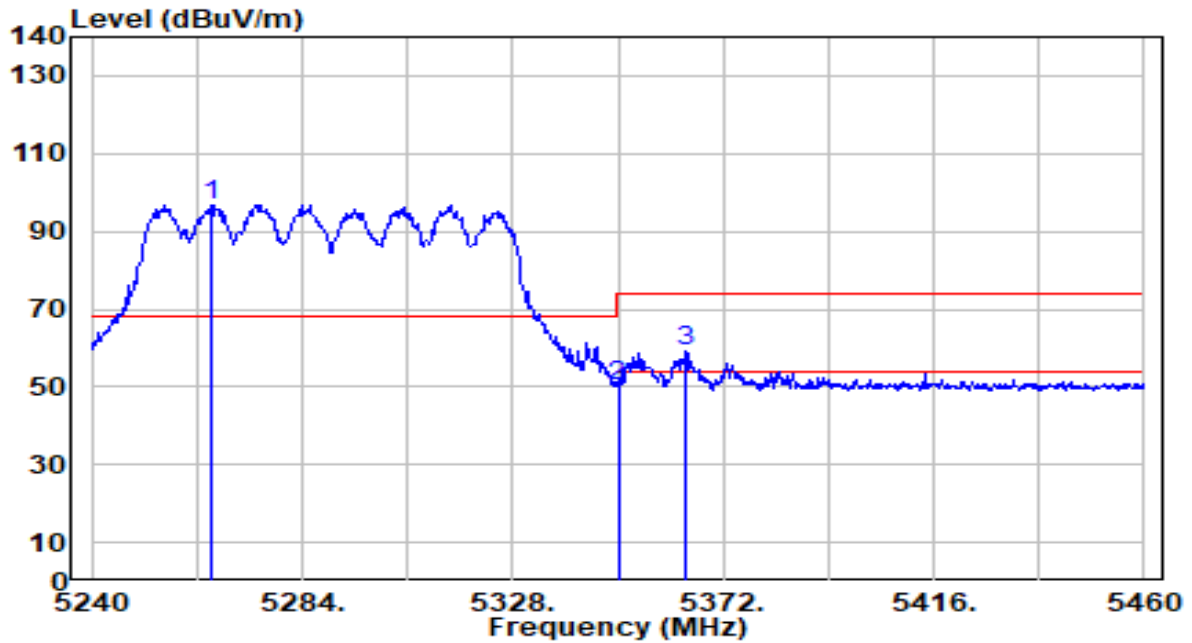

No	Frequency (MHz)	Reading (dBuV)	C.F (dB/m)	Measurement (dBuV/m)	Margin (dB)	Limit (dBuV/m)	Height (cm)	Angle (deg)	Remark (QP/PK/AV)
1	5265.080	97.69	-0.84	96.85	N/A	N/A	211	58	Peak
2	5350.000	51.22	-0.97	50.25	-23.75	74.00	211	58	Peak
3	* 5364.300	60.35	-0.99	59.36	-14.64	74.00	211	58	Peak

Note:

1. " *", means this data is the worst emission level.
2. C.F (Correction Factor) = Antenna Factor (dB/m)+ Cable Loss (dB) – Preamplifier(dB) + 10dB Attenuation.
3. Measurement (dBuV/m) = Reading(dBuV) + C.F (Correction Factor).
4. The emission levels of other frequencies are very lower than the limit and not show in test report.

EUT	AX1800 Indoor/Outdoor Wi-Fi 6 Access Point	Date of Test	2023-09-21
Factor	DRH18-E	Temp. / Humidity	20°C /60%
Polarity	Horizontal	Site / Test Engineer	AC2 / Marvin
Test Mode	802.11ax-80MHz_Band2_TX_CH 58_ANT 0+1	Test Voltage	AC120V/60Hz

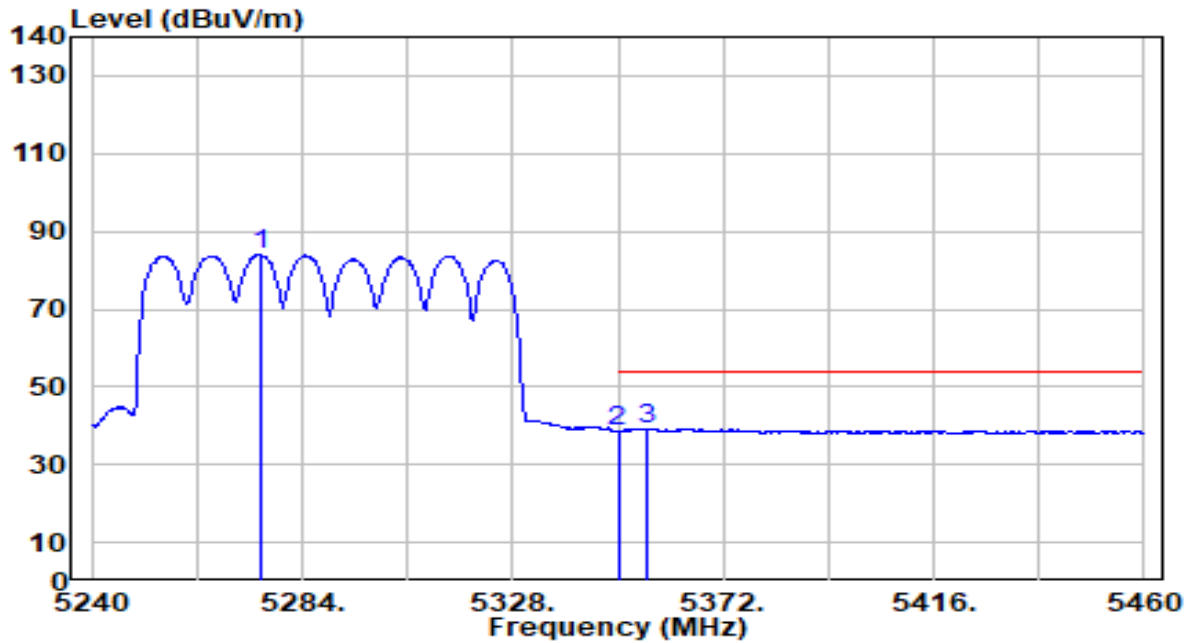

No	Frequency (MHz)	Reading (dBuV)	C.F (dB/m)	Measurement (dBuV/m)	Margin (dB)	Limit (dBuV/m)	Height (cm)	Angle (deg)	Remark (QP/PK/AV)
1	5275.420	85.03	-0.86	84.17	N/A	N/A	211	58	Average
2	5350.000	39.53	-0.97	38.56	-15.44	54.00	211	58	Average
3	* 5355.940	40.34	-0.98	39.36	-14.64	54.00	211	58	Average

Note:

1. " *", means this data is the worst emission level.
2. C.F (Correction Factor) = Antenna Factor (dB/m)+ Cable Loss (dB) – Preamplifier(dB) + 10dB Attenuation.
3. Measurement (dBuV/m) = Reading(dBuV) + C.F (Correction Factor).
4. The emission levels of other frequencies are very lower than the limit and not show in test report.

EUT	AX1800 Indoor/Outdoor Wi-Fi 6 Access Point	Date of Test	2023-09-21
Factor	DRH18-E	Temp. / Humidity	20°C /60%
Polarity	Vertical	Site / Test Engineer	AC2 / Marvin
Test Mode	802.11ax-80MHz_Band2_TX_CH 58_ANT 0+1	Test Voltage	AC120V/60Hz

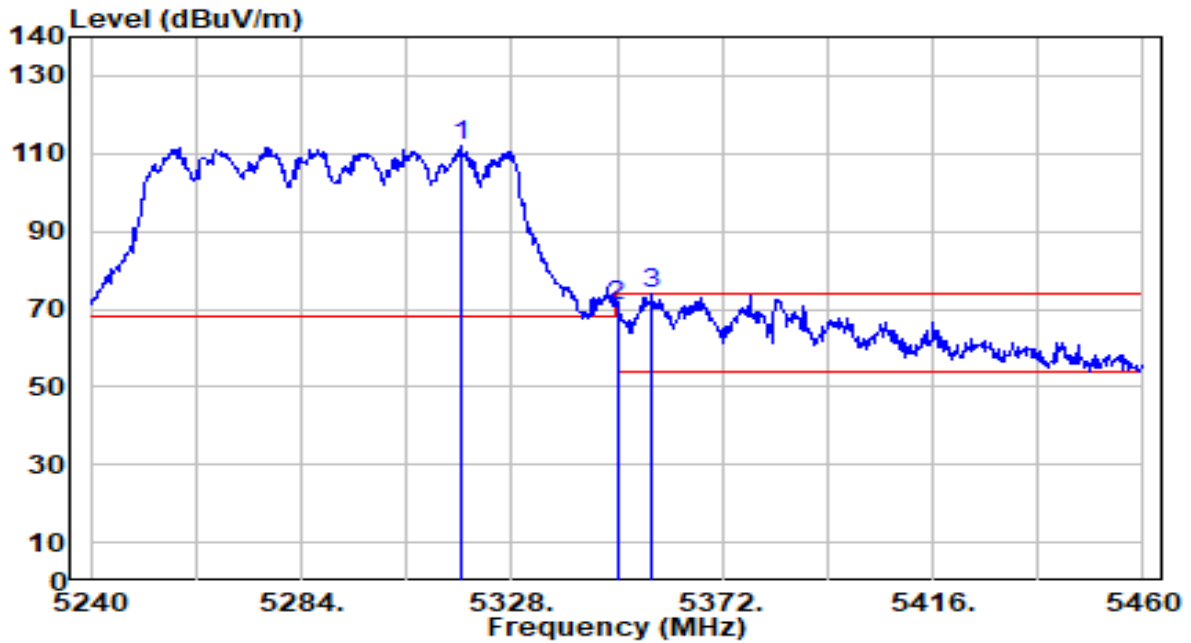

No	Frequency (MHz)	Reading (dBuV)	C.F (dB/m)	Measurement (dBuV/m)	Margin (dB)	Limit (dBuV/m)	Height (cm)	Angle (deg)	Remark (QP/PK/AV)
1	5317.440	112.68	-0.92	111.76	N/A	N/A	180	158	Peak
2	5350.000	72.00	-0.97	71.03	-2.97	74.00	180	158	Peak
3	* 5357.480	74.85	-0.98	73.87	-0.13	74.00	180	158	Peak

Note:

1. " *", means this data is the worst emission level.
2. C.F (Correction Factor) = Antenna Factor (dB/m)+ Cable Loss (dB) – Preamplifier(dB) + 10dB Attenuation.
3. Measurement (dBuV/m) = Reading(dBuV) + C.F (Correction Factor).
4. The emission levels of other frequencies are very lower than the limit and not show in test report.

EUT	AX1800 Indoor/Outdoor Wi-Fi 6 Access Point	Date of Test	2023-09-21
Factor	DRH18-E	Temp. / Humidity	20°C /60%
Polarity	Vertical	Site / Test Engineer	AC2 / Marvin
Test Mode	802.11ax-80MHz_Band2_TX_CH 58_ANT 0+1	Test Voltage	AC120V/60Hz

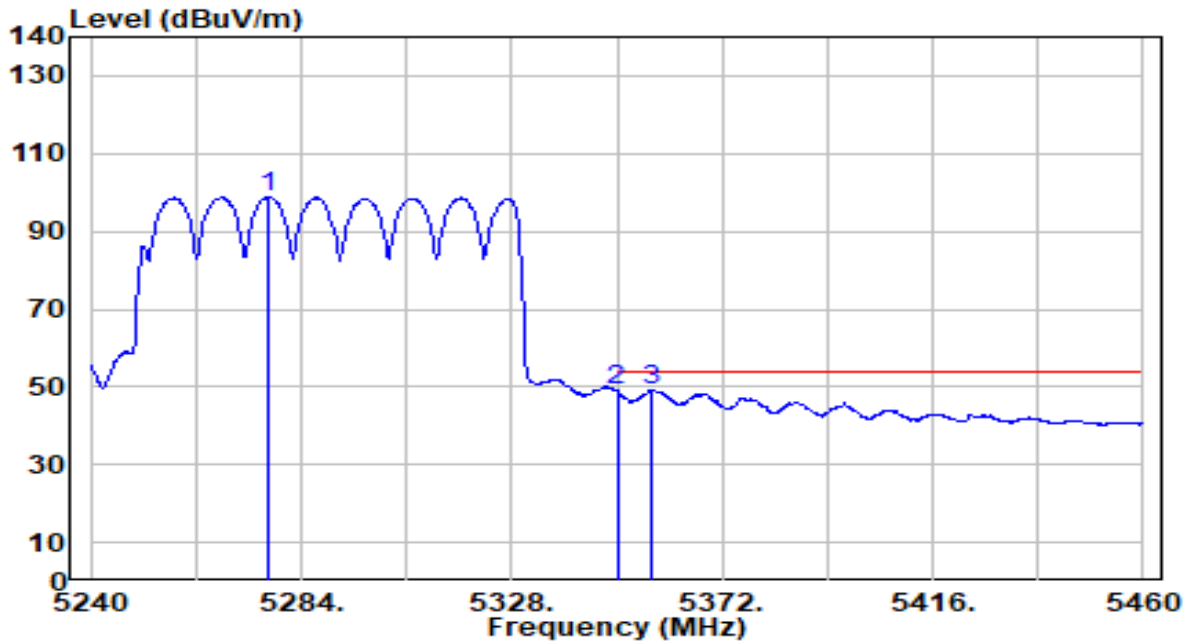

No	Frequency (MHz)	Reading (dBuV)	C.F (dB/m)	Measurement (dBuV/m)	Margin (dB)	Limit (dBuV/m)	Height (cm)	Angle (deg)	Remark (QP/PK/AV)
1	5276.960	99.72	-0.86	98.86	N/A	N/A	180	158	Average
2	5350.000	49.85	-0.97	48.88	-5.12	54.00	180	158	Average
3	* 5357.260	50.17	-0.98	49.19	-4.81	54.00	180	158	Average

Note:

1. " *", means this data is the worst emission level.
2. C.F (Correction Factor) = Antenna Factor (dB/m)+ Cable Loss (dB) – Preamplifier(dB) + 10dB Attenuation.
3. Measurement (dBuV/m) = Reading(dBuV) + C.F (Correction Factor).
4. The emission levels of other frequencies are very lower than the limit and not show in test report.

EUT	AX1800 Indoor/Outdoor Wi-Fi 6 Access Point	Date of Test	2023-09-21
Factor	DRH18-E	Temp. / Humidity	20°C /60%
Polarity	Horizontal	Site / Test Engineer	AC2 / Marvin
Test Mode	802.11ax-80MHz_Band3_TX_CH 106_ANT 0+1	Test Voltage	AC120V/60Hz

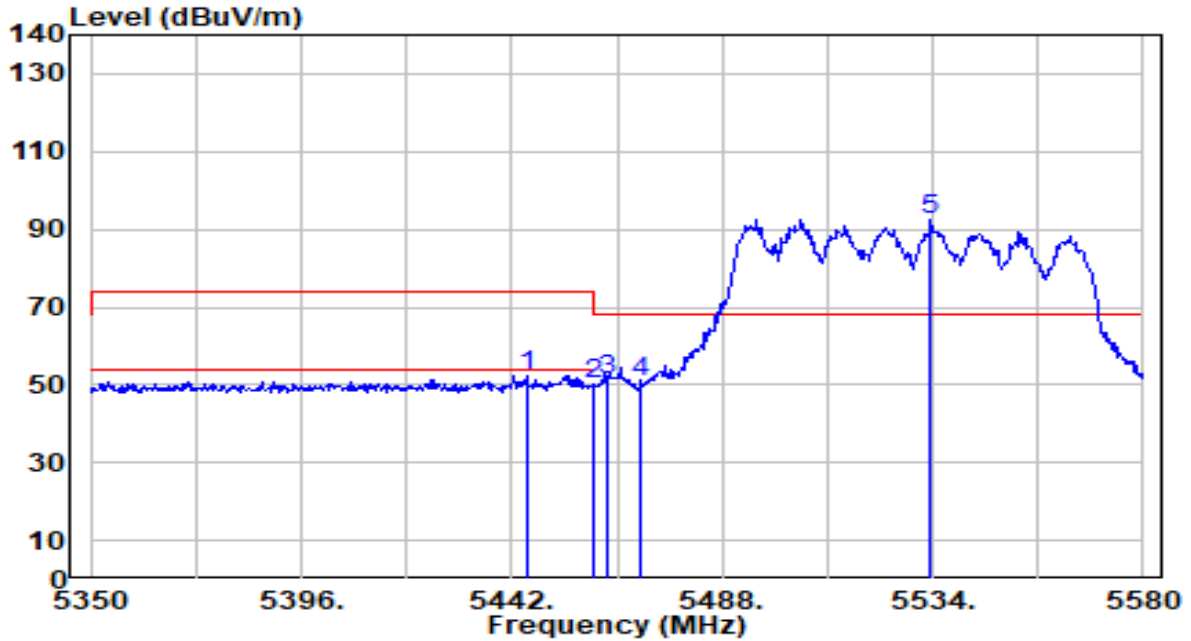

No	Frequency (MHz)	Reading (dBuV)	C.F (dB/m)	Measurement (dBuV/m)	Margin (dB)	Limit (dBuV/m)	Height (cm)	Angle (deg)	Remark (QP/PK/AV)
1	5445.450	53.47	-0.91	52.55	-21.45	74.00	200	56	Peak
2	5460.000	51.05	-0.87	50.18	-23.82	74.00	200	56	Peak
3	* 5462.930	52.11	-0.86	51.25	-16.95	68.20	200	56	Peak
4	5470.000	51.59	-0.84	50.75	-17.45	68.20	200	56	Peak
5	5533.540	92.93	-0.64	92.29	N/A	N/A	200	56	Peak

Note:

1. " *", means this data is the worst emission level.
2. C.F (Correction Factor) = Antenna Factor (dB/m)+ Cable Loss (dB) – Preamplifier(dB) + 10dB Attenuation.
3. Measurement (dBuV/m) = Reading(dBuV) + C.F (Correction Factor).
4. The emission levels of other frequencies are very lower than the limit and not show in test report.

EUT	AX1800 Indoor/Outdoor Wi-Fi 6 Access Point	Date of Test	2023-09-21
Factor	DRH18-E	Temp. / Humidity	20°C /60%
Polarity	Horizontal	Site / Test Engineer	AC2 / Marvin
Test Mode	802.11ax-80MHz_Band3_TX_CH 106_ANT 0+1	Test Voltage	AC120V/60Hz

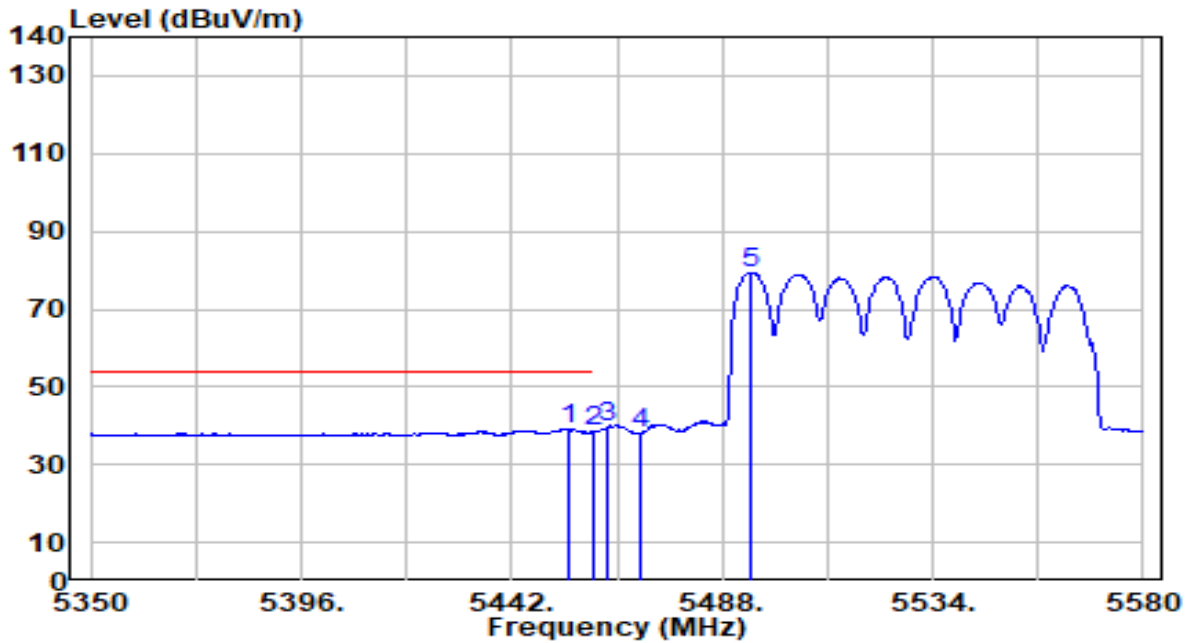

No	Frequency (MHz)	Reading (dBuV)	C.F (dB/m)	Measurement (dBuV/m)	Margin (dB)	Limit (dBuV/m)	Height (cm)	Angle (deg)	Remark (QP/PK/AV)	
1	*	5454.650	40.24	-0.89	39.36	-14.64	54.00	200	56	Average
2		5460.000	39.27	-0.87	38.40	-15.60	54.00	200	56	Average
3		5462.930	40.51	-0.86	39.65	N/A	N/A	200	56	Average
4		5470.000	38.91	-0.84	38.07	N/A	N/A	200	56	Average
5		5494.440	80.26	-0.77	79.50	N/A	N/A	200	56	Average

Note:

1. " *", means this data is the worst emission level.
2. C.F (Correction Factor) = Antenna Factor (dB/m)+ Cable Loss (dB) – Preamplifier(dB) + 10dB Attenuation.
3. Measurement (dBuV/m) = Reading(dBuV) + C.F (Correction Factor).
4. The emission levels of other frequencies are very lower than the limit and not show in test report.

EUT	AX1800 Indoor/Outdoor Wi-Fi 6 Access Point	Date of Test	2023-09-21
Factor	DRH18-E	Temp. / Humidity	20°C /60%
Polarity	Vertical	Site / Test Engineer	AC2 / Marvin
Test Mode	802.11ax-80MHz_Band3_TX_CH 106_ANT 0+1	Test Voltage	AC120V/60Hz

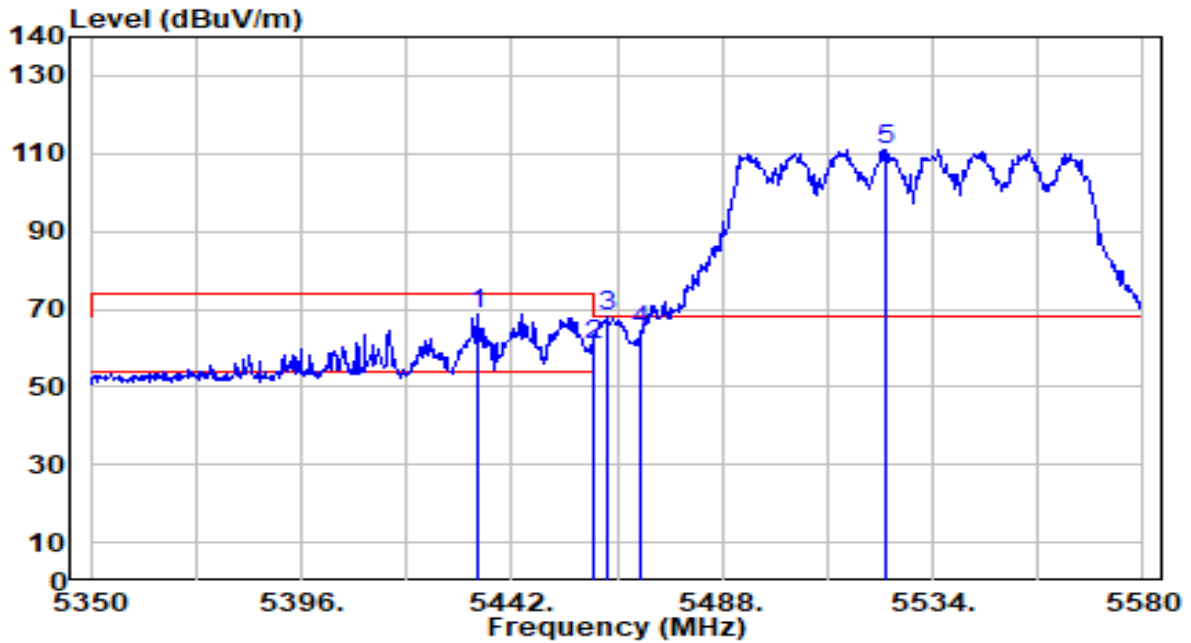

No	Frequency (MHz)	Reading (dBuV)	C.F (dB/m)	Measurement (dBuV/m)	Margin (dB)	Limit (dBuV/m)	Height (cm)	Angle (deg)	Remark (QP/PK/AV)
1	5434.870	69.76	-0.94	68.82	-5.18	74.00	180	150	Peak
2	5460.000	61.78	-0.87	60.92	-13.08	74.00	180	150	Peak
3	* 5462.930	68.93	-0.86	68.07	-0.13	68.20	180	150	Peak
4	5470.000	65.08	-0.84	64.24	-3.96	68.20	180	150	Peak
5	5523.650	111.79	-0.67	111.11	N/A	N/A	180	150	Peak

Note:

1. " *", means this data is the worst emission level.
2. C.F (Correction Factor) = Antenna Factor (dB/m)+ Cable Loss (dB) – Preamplifier(dB) + 10dB Attenuation.
3. Measurement (dBuV/m) = Reading(dBuV) + C.F (Correction Factor).
4. The emission levels of other frequencies are very lower than the limit and not show in test report.

EUT	AX1800 Indoor/Outdoor Wi-Fi 6 Access Point	Date of Test	2023-09-21
Factor	DRH18-E	Temp. / Humidity	20°C /60%
Polarity	Vertical	Site / Test Engineer	AC2 / Marvin
Test Mode	802.11ax-80MHz_Band3_TX_CH 106_ANT 0+1	Test Voltage	AC120V/60Hz

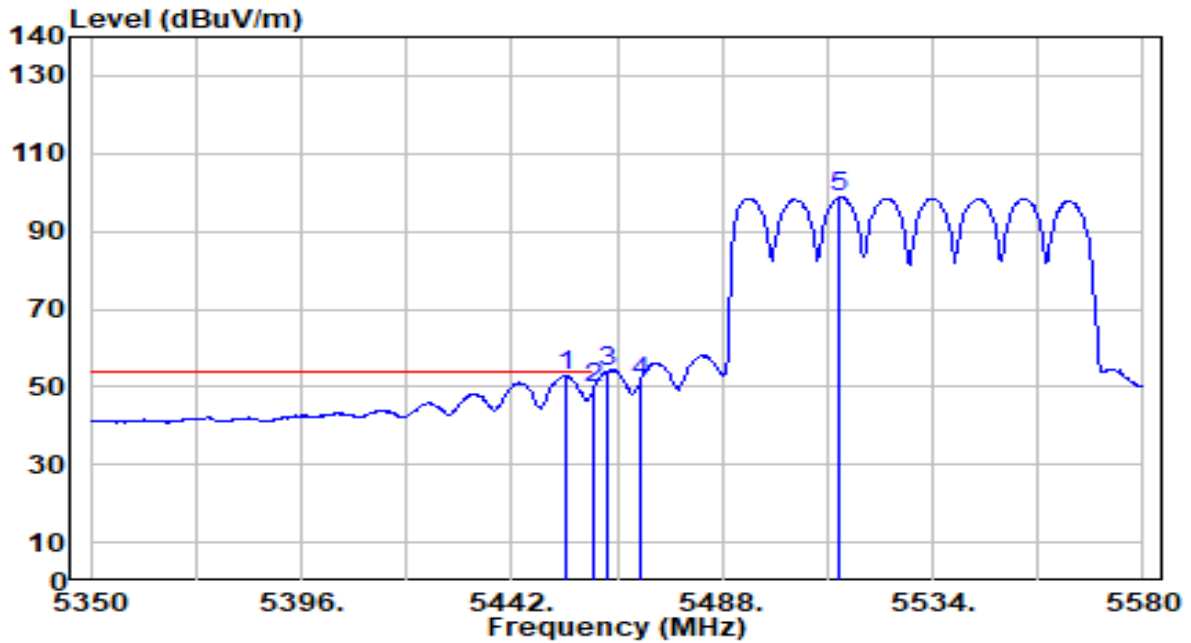

No	Frequency (MHz)	Reading (dBuV)	C.F (dB/m)	Measurement (dBuV/m)	Margin (dB)	Limit (dBuV/m)	Height (cm)	Angle (deg)	Remark (QP/PK/AV)	
1	*	5453.730	53.84	-0.89	52.95	-1.05	54.00	180	150	Average
2		5460.000	50.32	-0.87	49.45	-4.55	54.00	180	150	Average
3		5462.930	54.69	-0.86	53.83	N/A	N/A	180	150	Average
4		5470.000	52.04	-0.84	51.20	N/A	N/A	180	150	Average
5		5513.760	99.33	-0.71	98.62	N/A	N/A	180	150	Average

Note:

1. " *", means this data is the worst emission level.
2. C.F (Correction Factor) = Antenna Factor (dB/m)+ Cable Loss (dB) – Preamplifier(dB) + 10dB Attenuation.
3. Measurement (dBuV/m) = Reading(dBuV) + C.F (Correction Factor).
4. The emission levels of other frequencies are very lower than the limit and not show in test report.

EUT	AX1800 Indoor/Outdoor Wi-Fi 6 Access Point	Date of Test	2023-09-21
Factor	DRH18-E	Temp. / Humidity	20°C /60%
Polarity	Horizontal	Site / Test Engineer	AC2 / Marvin
Test Mode	802.11ax-80MHz_Band4_TX_CH 155_ANT 0+1	Test Voltage	AC120V/60Hz

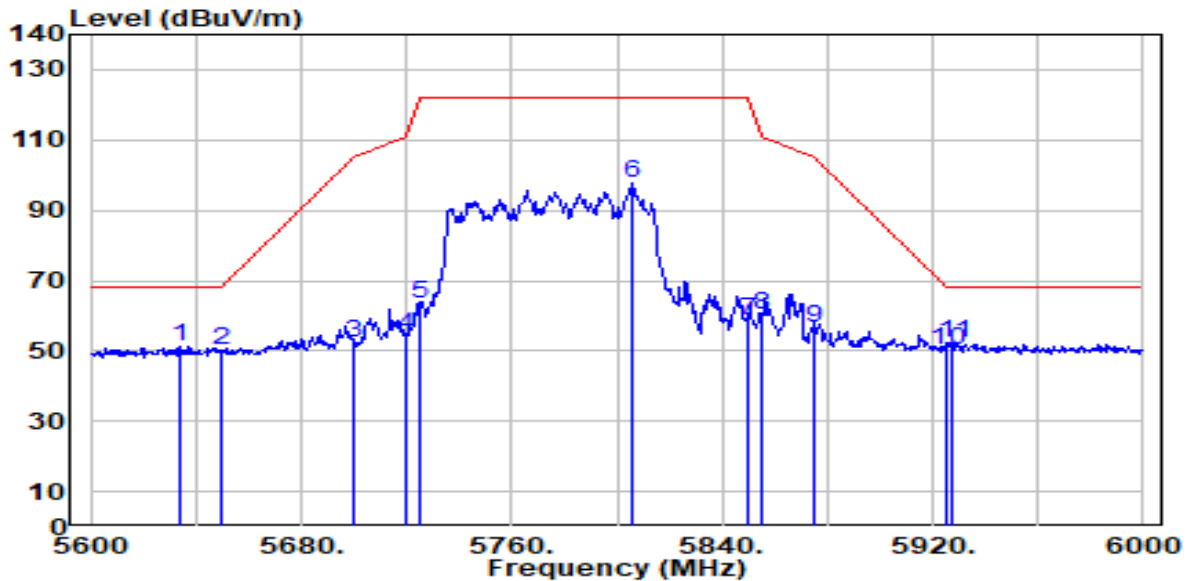

No	Frequency (MHz)	Reading (dBuV)	C.F (dB/m)	Measurement (dBuV/m)	Margin (dB)	Limit (dBuV/m)	Height (cm)	Angle (deg)	Remark (QP/PK/AV)
1	5634.400	51.37	-0.25	51.13	-17.07	68.20	200	28	Peak
2	5650.000	50.23	-0.16	50.07	-18.13	68.20	200	28	Peak
3	5700.000	52.33	0.10	52.43	-52.77	105.20	200	28	Peak
4	5720.000	54.43	0.20	54.63	-56.17	110.80	200	28	Peak
5	5725.000	63.14	0.23	63.37	-58.83	122.20	200	28	Peak
6	5806.000	97.06	0.62	97.67	N/A	N/A	200	28	Peak
7	5850.000	57.97	0.58	58.55	-63.65	122.20	200	28	Peak
8	5855.000	59.45	0.58	60.03	-50.77	110.80	200	28	Peak
9	5875.000	55.88	0.57	56.44	-48.76	105.20	200	28	Peak
10	5925.000	49.79	0.53	50.32	-17.88	68.20	200	28	Peak
11 *	5927.600	51.98	0.53	52.51	-15.69	68.20	200	28	Peak

Note:

1. " *", means this data is the worst emission level.
2. C.F (Correction Factor) = Antenna Factor (dB/m)+ Cable Loss (dB) – Preamplifier(dB) + 10dB Attenuation.
3. Measurement (dBuV/m) = Reading(dBuV) + C.F (Correction Factor).
4. The emission levels of other frequencies are very lower than the limit and not show in test report.

EUT	AX1800 Indoor/Outdoor Wi-Fi 6 Access Point	Date of Test	2023-09-21
Factor	DRH18-E	Temp. / Humidity	20°C /60%
Polarity	Vertical	Site / Test Engineer	AC2 / Marvin
Test Mode	802.11ax-80MHz_Band4_TX_CH 155_ANT 0+1	Test Voltage	AC120V/60Hz

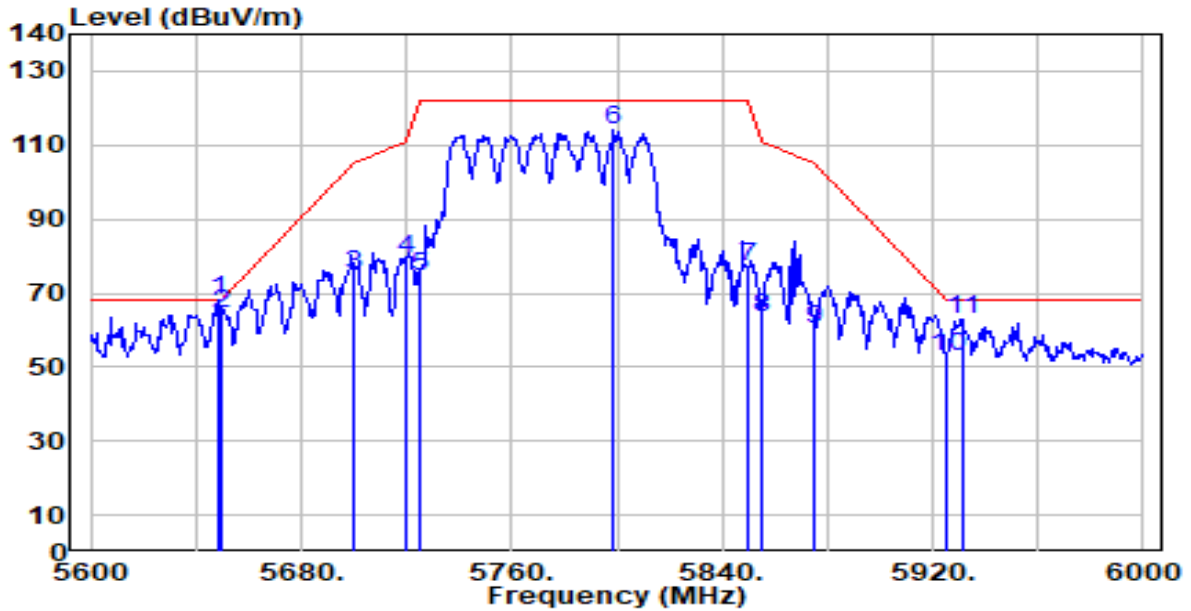

No	Frequency (MHz)	Reading (dBuV)	C.F (dB/m)	Measurement (dBuV/m)	Margin (dB)	Limit (dBuV/m)	Height (cm)	Angle (deg)	Remark (QP/PK/AV)
1	* 5648.400	68.25	-0.17	68.07	-0.13	68.20	200	351	Peak
2	5650.000	64.41	-0.16	64.25	-3.95	68.20	200	351	Peak
3	5700.000	74.67	0.10	74.77	-30.43	105.20	200	351	Peak
4	5720.000	78.97	0.20	79.17	-31.63	110.80	200	351	Peak
5	5725.000	74.04	0.23	74.26	-47.94	122.20	200	351	Peak
6	5798.400	113.47	0.61	114.08	N/A	N/A	200	351	Peak
7	5850.000	76.41	0.58	76.99	-45.21	122.20	200	351	Peak
8	5855.000	62.57	0.58	63.15	-47.65	110.80	200	351	Peak
9	5875.000	59.71	0.57	60.28	-44.92	105.20	200	351	Peak
10	5925.000	52.53	0.53	53.06	-15.14	68.20	200	351	Peak
11	5931.200	62.31	0.52	62.83	-5.37	68.20	200	351	Peak

Note:

1. " *", means this data is the worst emission level.
2. C.F (Correction Factor) = Antenna Factor (dB/m)+ Cable Loss (dB) – Preamplifier(dB) + 10dB Attenuation.
3. Measurement (dBuV/m) = Reading(dBuV) + C.F (Correction Factor).
4. The emission levels of other frequencies are very lower than the limit and not show in test report.

7.10.AC Conducted Emissions Measurement

7.10.1.Test Limit

FCC Part 15.207 Limits		
Frequency (MHz)	QP (dB μ V)	AV (dB μ V)
0.15 - 0.50	66 - 56	56 - 46
0.50 - 5.0	56	46
5.0 - 30	60	50

Note 1: The lower limit shall apply at the transition frequencies.

Note 2: The limit decreases linearly with the logarithm of the frequency in the range 0.15MHz to 0.5MHz.

7.10.2.Test Setup

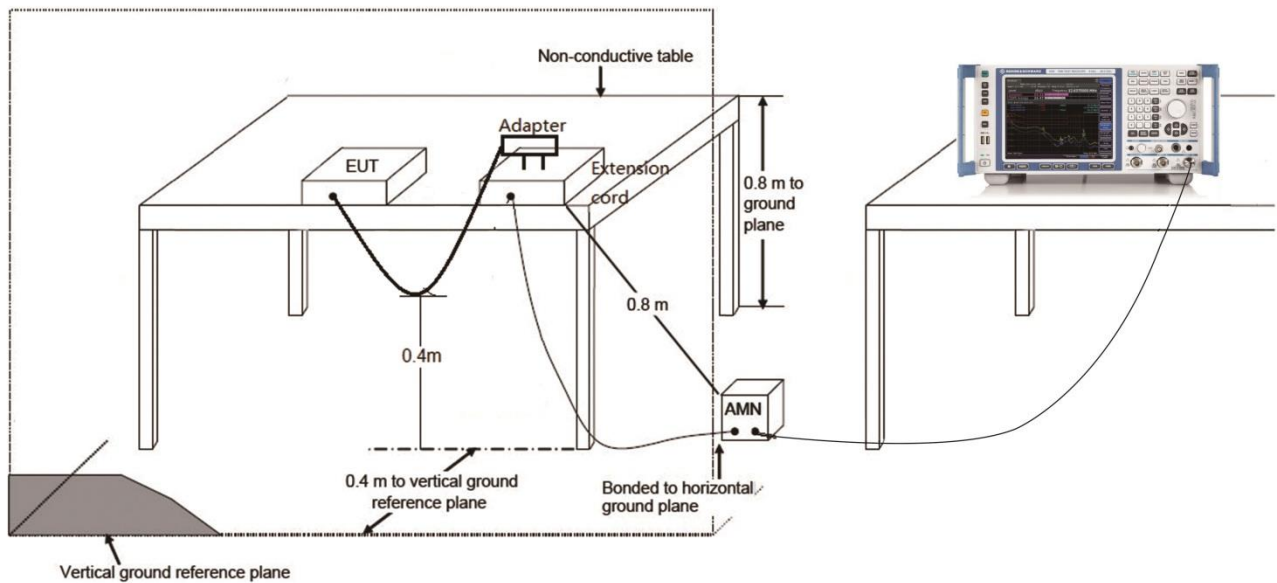

7.10.3. Test Result

EUT	AX1800 Indoor/Outdoor Wi-Fi Access Point	Date of Test	2023-09-22
Factor	CE_ENV216-L1 (Filter ON)	Temp. / Humidity	25.8°C / 48%
Polarity	Line1	Site / Test Engineer	SR2 / Bob
Test Mode	802.11ac-20MHz_TX_Band1_CH 44_ANT 0+1	Test Voltage	AC 120V/60Hz

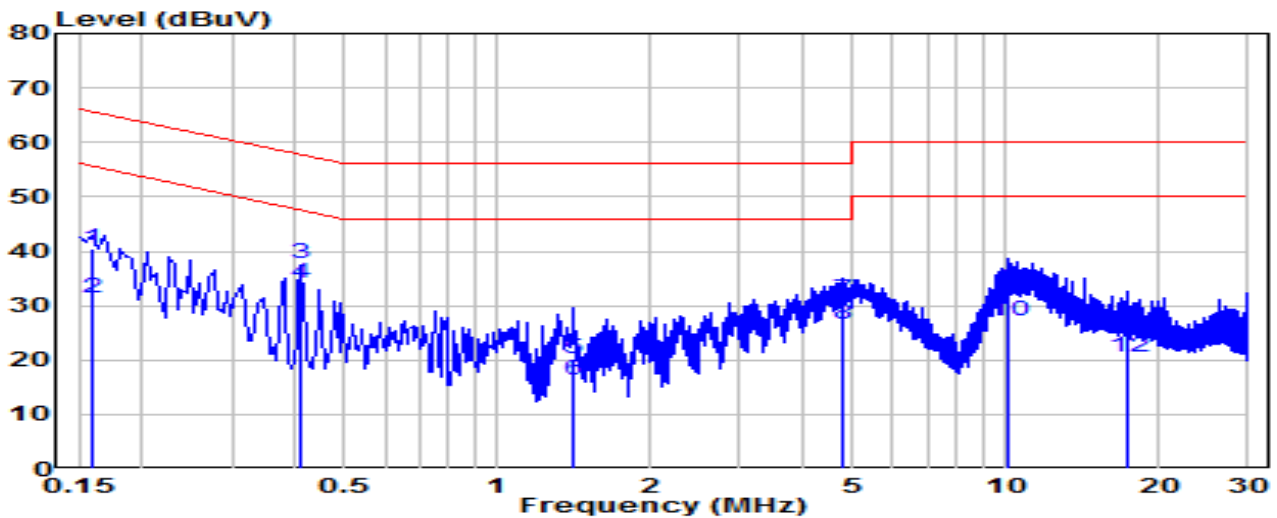

No	Frequency (MHz)	Reading (dBUV)	C.F (dB)	Measurement (dBUV)	Margin (dB)	Limit (dBUV)	Remark (QP/PK/AV)
1	0.159	30.70	9.62	40.32	-25.20	65.52	QP
2	0.159	21.85	9.62	31.47	-24.04	55.52	Average
3	* 0.411	28.00	9.64	37.63	-19.99	57.63	QP
4	* 0.411	24.62	9.64	34.26	-13.37	47.63	Average
5	1.414	10.70	9.68	20.37	-35.63	56.00	QP
6	1.414	6.67	9.68	16.35	-29.65	46.00	Average
7	4.758	21.21	9.74	30.96	-25.04	56.00	QP
8	4.758	16.77	9.74	26.52	-19.48	46.00	Average
9	10.166	23.09	9.86	32.95	-27.05	60.00	QP
10	10.166	17.38	9.86	27.24	-22.76	50.00	Average
11	17.298	15.26	9.91	25.17	-34.83	60.00	QP
12	17.298	10.68	9.91	20.59	-29.41	50.00	Average

Note:

1. " *", means this data is the worst emission level.
2. C.F (Correction Factor) = LISN Factor (dB)+ Cable Loss (dB).
3. Measurement (dBUV) = Reading(dBUV) + C.F (Correction Factor).

EUT	AX1800 Indoor/Outdoor Wi-Fi Access Point	Date of Test	2023-09-22
Factor	CE_ENV216-N (Filter ON)	Temp. / Humidity	25.8°C /48%
Polarity	Neutral	Site / Test Engineer	SR2 / Bob
Test Mode	802.11ac-20MHz_TX_Band1_CH 44_ANT 0+1	Test Voltage	AC 120V/60Hz

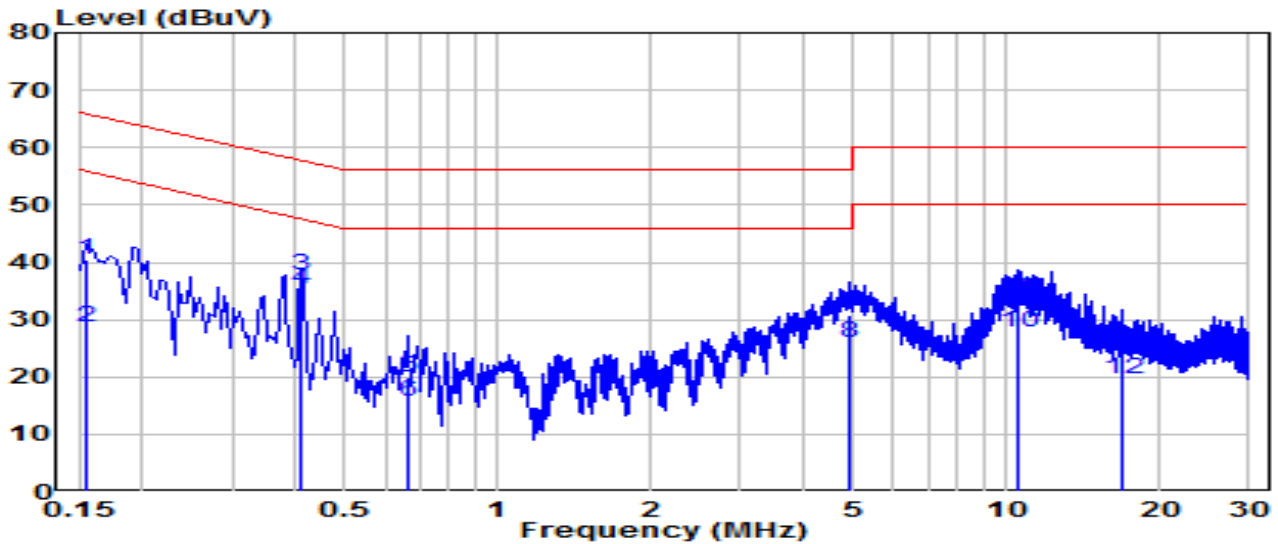

No	Frequency (MHz)	Reading (dBuV)	C.F (dB)	Measurement (dBuV)	Margin (dB)	Limit (dBuV)	Remark (QP/PK/AV)
1	0.154	30.92	9.62	40.54	-25.21	65.75	QP
2	0.154	19.16	9.62	28.78	-26.98	55.75	Average
3	* 0.411	28.02	9.64	37.65	-19.98	57.63	QP
4	* 0.411	25.60	9.64	35.23	-12.39	47.63	Average
5	0.663	10.17	9.65	19.82	-36.18	56.00	QP
6	0.663	5.92	9.65	15.57	-30.43	46.00	Average
7	4.947	20.95	9.75	30.70	-25.30	56.00	QP
8	4.947	16.21	9.75	25.95	-20.05	46.00	Average
9	10.566	23.84	9.88	33.71	-26.29	60.00	QP
10	10.566	17.94	9.88	27.82	-22.18	50.00	Average
11	17.005	14.58	9.96	24.54	-35.46	60.00	QP
12	17.005	9.67	9.96	19.63	-30.37	50.00	Average

Note:

1. " *", means this data is the worst emission level.
2. C.F (Correction Factor) = LISN Factor (dB)+ Cable Loss (dB).
3. Measurement (dBuV) = Reading(dBuV) + C.F (Correction Factor).

EUT	AX1800 Indoor/Outdoor Wi-Fi Access Point	Date of Test	2023-09-22
Factor	CE_ENV216-L1 (Filter ON)	Temp. / Humidity	25.8°C /48%
Polarity	Line1	Site / Test Engineer	SR2 / Bob
Test Mode	802.11ac-20MHz_TX_Band1_CH 44_ANT 0+1	Test Voltage	AC 240V/60Hz

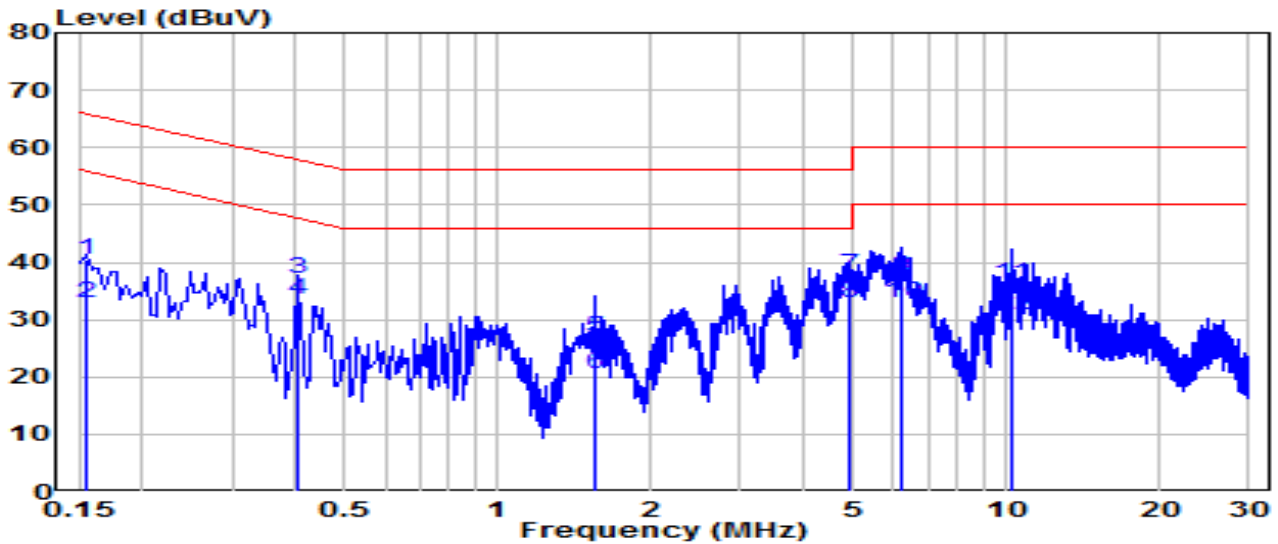

No	Frequency (MHz)	Reading (dBuV)	C.F (dB)	Measurement (dBuV)	Margin (dB)	Limit (dBuV)	Remark (QP/PK/AV)
1	0.154	30.89	9.62	40.51	-25.24	65.75	QP
2	0.154	23.18	9.62	32.80	-22.96	55.75	Average
3	0.402	27.59	9.63	37.23	-20.59	57.81	QP
4	0.402	23.73	9.63	33.37	-14.44	47.81	Average
5	1.549	17.26	9.68	26.94	-29.06	56.00	QP
6	1.549	10.91	9.68	20.59	-25.41	46.00	Average
7	* 4.893	27.97	9.74	37.71	-18.29	56.00	QP
8	* 4.893	23.12	9.74	32.87	-13.13	46.00	Average
9	6.188	27.53	9.77	37.31	-22.69	60.00	QP
10	6.188	23.12	9.77	32.89	-17.11	50.00	Average
11	10.265	26.27	9.86	36.13	-23.87	60.00	QP
12	10.265	21.03	9.86	30.90	-19.10	50.00	Average

Note:

1. "*", means this data is the worst emission level.
2. C.F (Correction Factor) = LISN Factor (dB)+ Cable Loss (dB).
3. Measurement (dBuV) = Reading(dBuV) + C.F (Correction Factor).

EUT	AX1800 Indoor/Outdoor Wi-Fi Access Point	Date of Test	2023-09-22
Factor	CE_ENV216-N (Filter ON)	Temp. / Humidity	25.8°C /48%
Polarity	Neutral	Site / Test Engineer	SR2 / Bob
Test Mode	802.11ac-20MHz_TX_Band1_CH 44_ANT 0+1	Test Voltage	AC 240V/60Hz

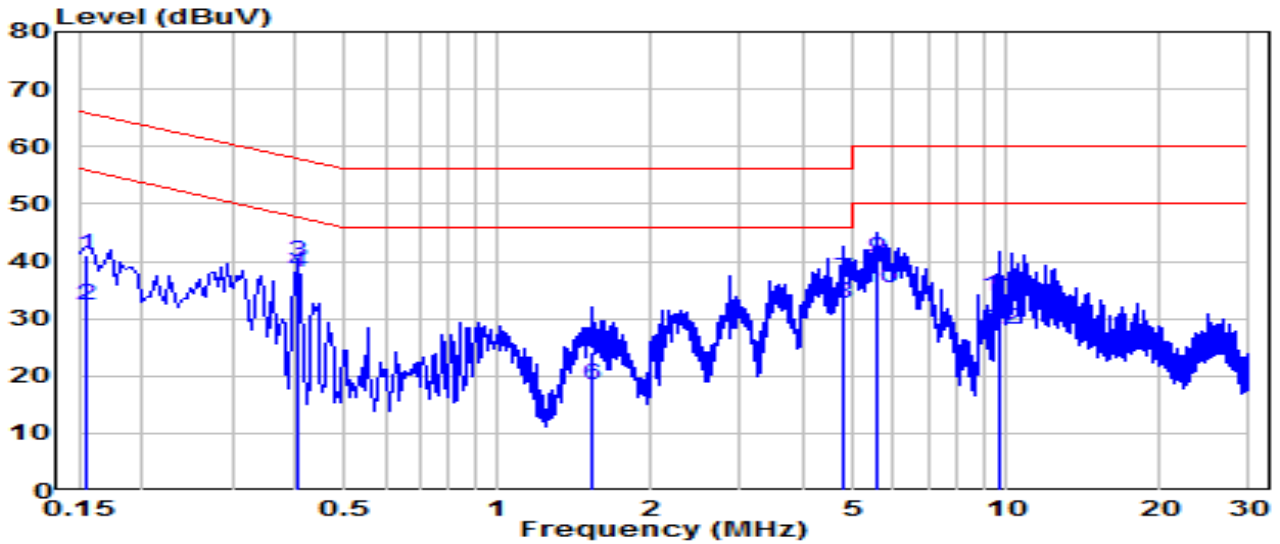

No	Frequency (MHz)	Reading (dBUV)	C.F (dB)	Measurement (dBUV)	Margin (dB)	Limit (dBUV)	Remark (QP/PK/AV)
1	0.154	31.35	9.62	40.97	-24.78	65.75	QP
2	0.154	22.81	9.62	32.43	-23.33	55.75	Average
3	* 0.406	30.17	9.63	39.80	-17.92	57.72	QP
4	* 0.406	28.55	9.63	38.19	-9.53	47.72	Average
5	1.540	14.51	9.68	24.19	-31.81	56.00	QP
6	1.540	8.81	9.68	18.49	-27.51	46.00	Average
7	4.767	27.23	9.74	36.98	-19.02	56.00	QP
8	4.767	22.81	9.74	32.55	-13.45	46.00	Average
9	5.581	30.65	9.76	40.41	-19.59	60.00	QP
10	5.581	25.59	9.76	35.35	-14.65	50.00	Average
11	9.653	24.10	9.86	33.96	-26.04	60.00	QP
12	9.653	18.31	9.86	28.17	-21.83	50.00	Average

Note:

1. " *", means this data is the worst emission level.
2. C.F (Correction Factor) = LISN Factor (dB)+ Cable Loss (dB).
3. Measurement (dBUV) = Reading(dBUV) + C.F (Correction Factor).

8. CONCLUSION

The data collected relate only the item(s) tested and show that the device is in compliance with Part 15E of the FCC Rules.

Appendix A : Test Setup Photograph

Refer to “2308TW0118-UT” file.

Appendix B : EUT Photograph

Refer to “2308TW0118-UE” file.

Appendix C : Internal Photograph

Refer to “2308TW0118-UI” file.

————— The End —————