

Product specification

Quick Reference Date

| | | |
|----------------------------|------------------------------------|--|
| | Antenna module on the system board | |
| Frequenc Range | 2400 ~ 2500MHz | |
| Ant. Port Input Pwr. (dBm) | 0 (Typ. BT class 2 output power) | |
| Tot. Rad. Pwr. (dBm) | -1.2 (Input pwr – loss pwr) | |
| Peak EIRP(dBm) | 1.2 | |
| Directivity (dBi) | 1 (all direction antenna) | |
| Efficiency (dB) | 6 0.2 % | |
| Gain (dBi) | 1.2 (Avg Gain XY-plane) | |
| Maximum Power (dBm) | 1.7 (XY-plane) | |
| Minimum Power (dBm) | -4(XY-plane) | |
| Avg. Power (dBm) | -0.5(XY-plane) | |
| Input Impendence(ohm) | 50 | |
| Polarization Type | V ertical & Horizontal | |
| V . S .W .R | < 1.4 | |

All the technical data and information contained herein are subject to change without prior notice

Antenna Layout & module on the system board

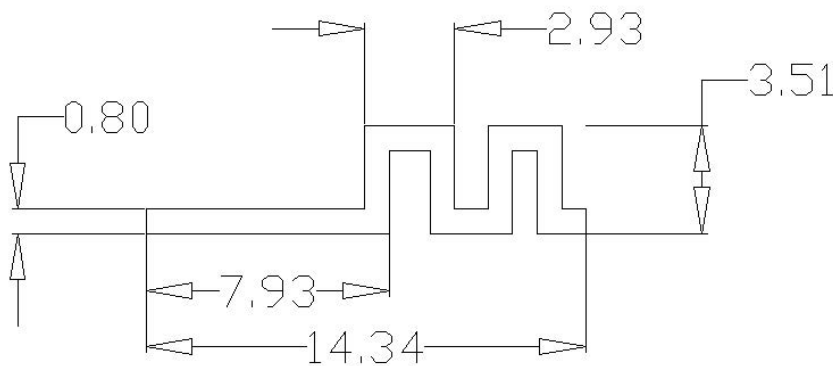

Antenna Gain

Gain Table

| Unit in dBi @2.44GHz | XY-plane | | XZ-plane | | YZ-plane | | Efficiency |
|----------------------|----------|------|----------|------|----------|------|------------|
| | Peak | Avg. | Peak | Avg. | Peak | Avg. | |
| Module Board | 1.35 | -0.5 | 1.68 | -3.6 | 1.11 | -3.0 | 6 0.2 % |

Return Loss

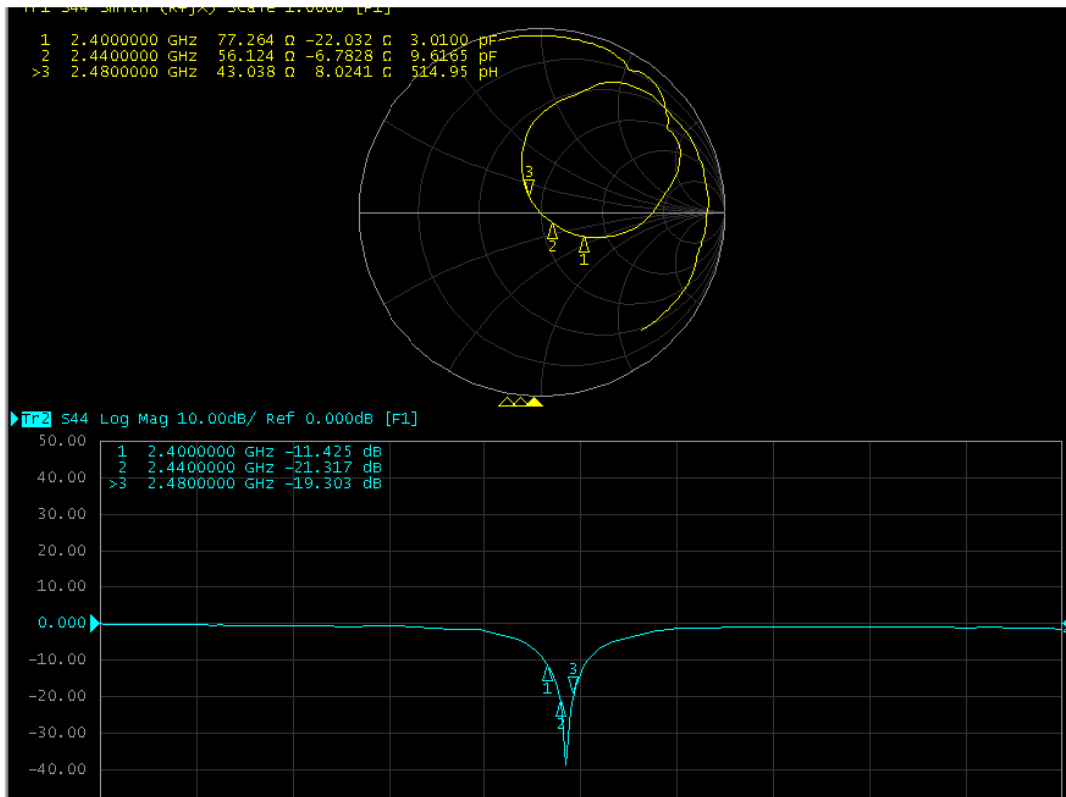

The Environment of Antenna Radiation Pattern

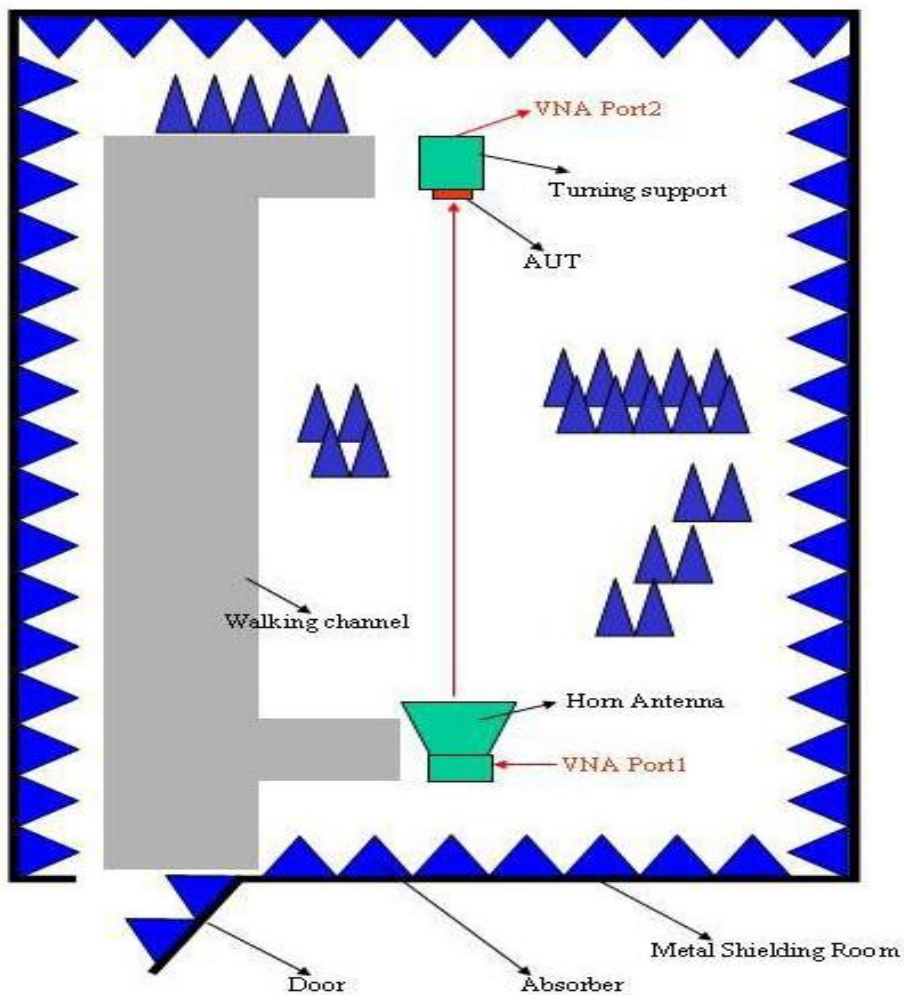

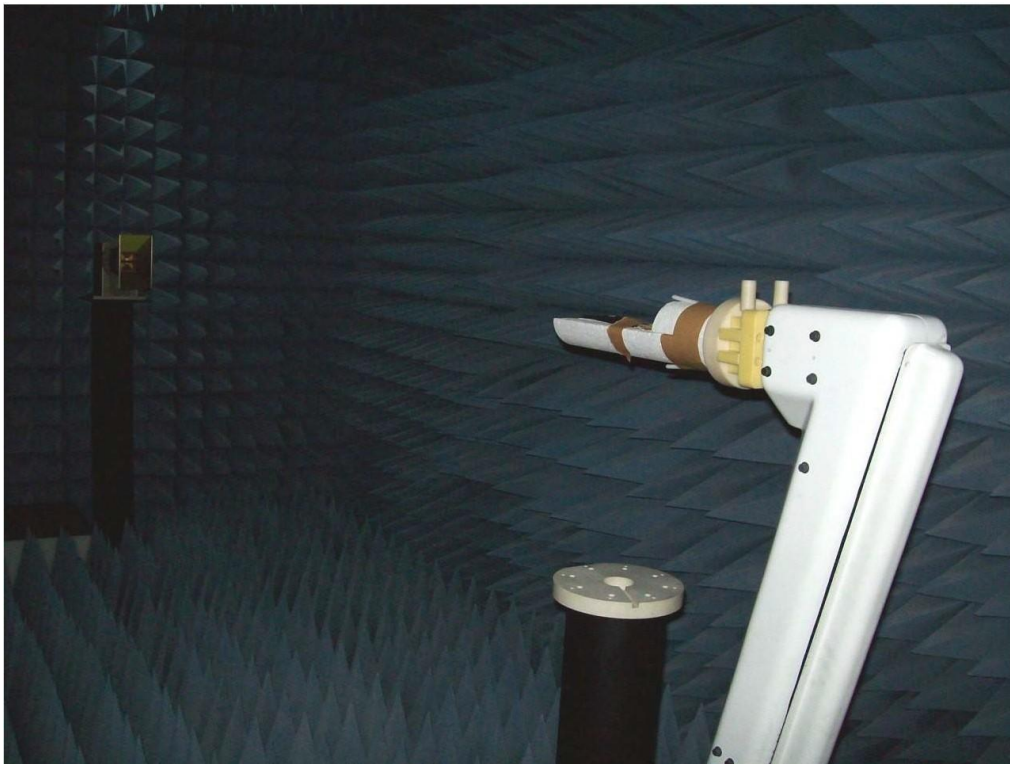

3D radiation pattern diagram

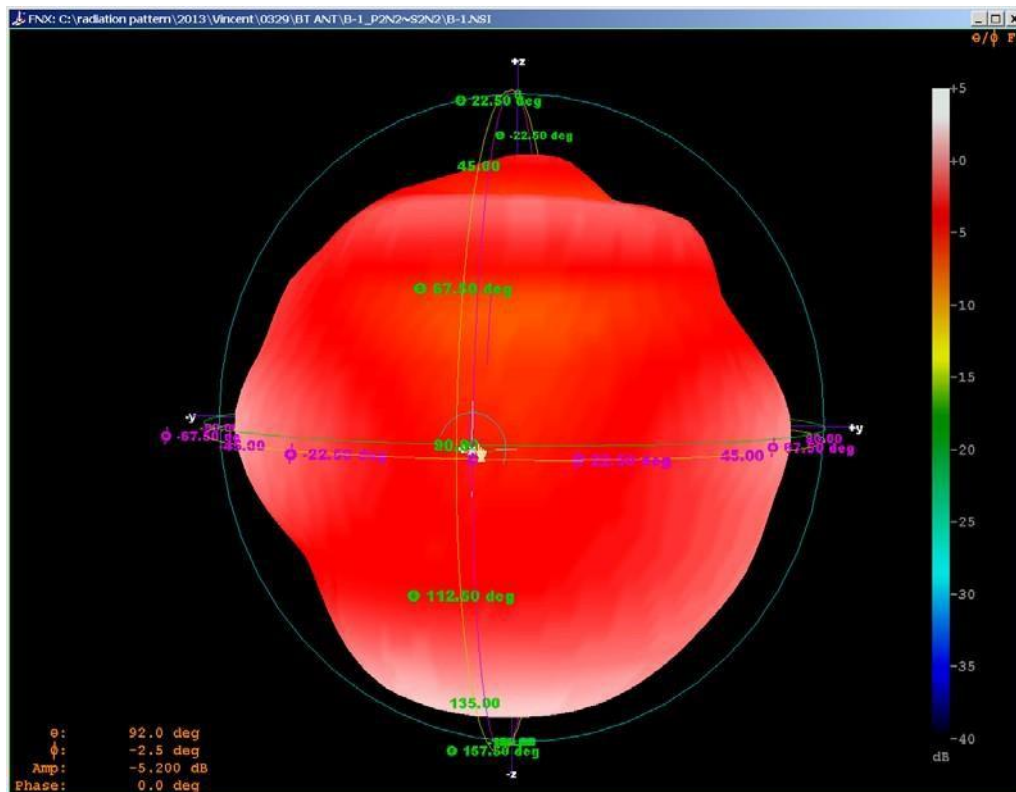

XY-plane

Far-field Power Distribution(H+V) on X-Y Plane
Plot Peak Gain(H+V)= 1.35 dB; Plot AvgGain(H+V)= -0.48dB @ 2.44000 GHz

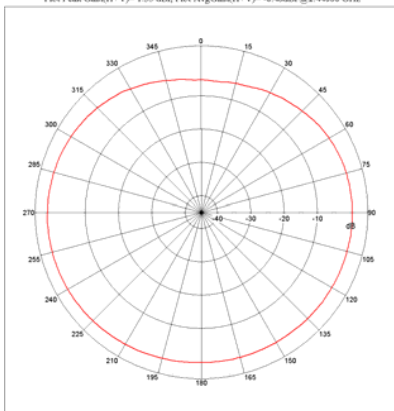

XZ-plane

Far-field Power Distribution(H+V) on X-Z Plane
Plot Peak Gain(H+V)= 1.68 dB; Plot AvgGain(H+V)= -3.83dB @ 2.44000 GHz

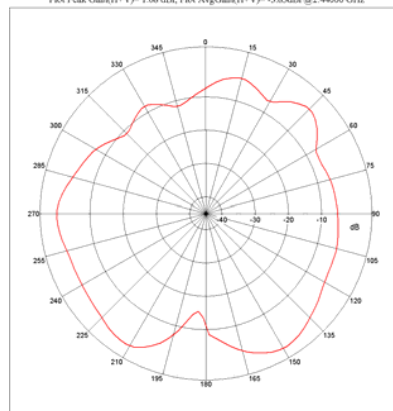

YZ-plane

Far-field Power Distribution(H+V) on Y-Z Plane
Plot Peak Gain(H+V)= 1.11 dB; Plot AvgGain(H+V)= -2.99dB @ 2.44000 GHz

