

11AX20MIMO\_Ant3\_5785



11AX20MIMO\_Ant4\_5785



11AX20MIMO\_Ant1\_5825



11AX20MIMO\_Ant2\_5825



11AX20MIMO\_Ant3\_5825



11AX20MIMO\_Ant4\_5825



11AX40MIMO\_Ant1\_5755



11AX40MIMO\_Ant2\_5755





11AX40MIMO\_Ant3\_5755



11AX40MIMO\_Ant4\_5755



11AX40MIMO\_Ant1\_5795

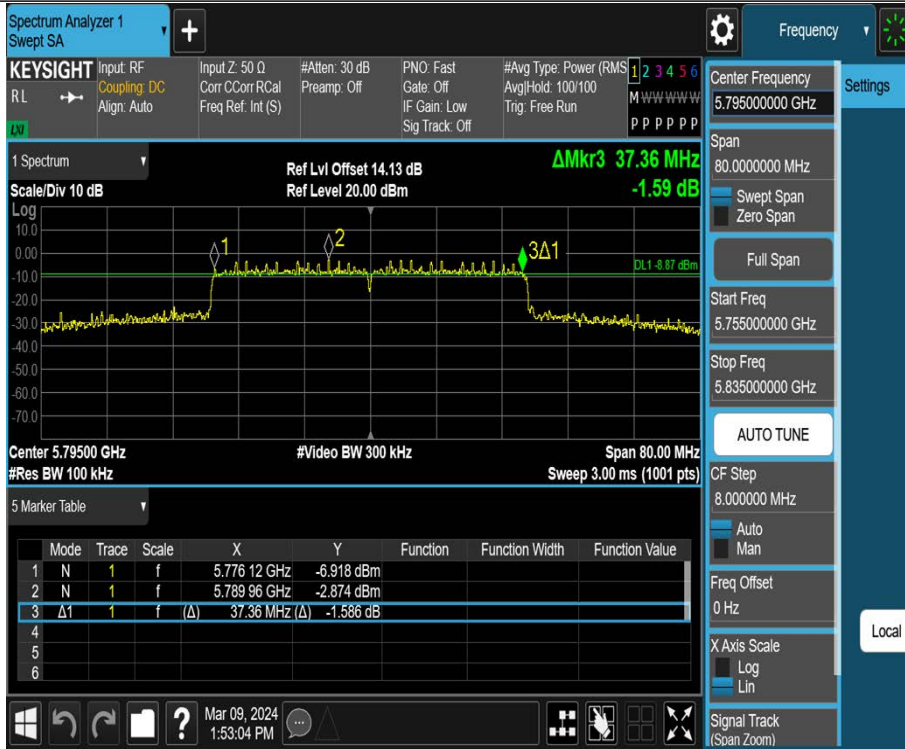

11AX40MIMO\_Ant2\_5795



11AX40MIMO\_Ant3\_5795



11AX40MIMO\_Ant4\_5795



11AX80MIMO\_Ant1\_5775



11AX80MIMO\_Ant2\_5775





11AX80MIMO\_Ant3\_5775



11AX80MIMO\_Ant4\_5775



### 3.4 Conducted Output Power

#### 3.4.1 Limit

FCC Part15, Subpart E (15.407)			
Section	Test Item	Limit	Frequency Range (MHz)
15.407(a)	Conducted Output Power	Master device: 1 Watt (30 dBm) Client device: 250 mW (23.98 dBm)	5150-5250
		250 mW (23.98 dBm)	5250-5350
		250 mW (23.98 dBm)	5470-5725
		1 Watt (30dBm)	5725-5850

Note:

- For an indoor access point operating in the band 5.15-5.25 GHz, the maximum conducted output power over the frequency band of operation shall not exceed 1 W provided the maximum antenna gain does not exceed 6 dBi. In addition, the maximum power spectral density shall not exceed 17 dBm in any 1 megahertz band. If transmitting antennas of directional gain greater than 6 dBi are used, both the maximum conducted output power and the maximum power spectral density shall be reduced by the amount in dB that the directional gain of the antenna exceeds 6 dBi.
- For the 5.25-5.35 GHz and 5.47-5.725 GHz bands, the maximum conducted output power over the frequency bands of operation shall not exceed the lesser of 250 mW or 11 dBm + 10log B, where B is the 26dB Bandwidth in megahertz.

#### 3.4.2 Test Procedure

Test Method	
<input checked="" type="radio"/> Conducted Measurement	<input type="radio"/> Radiated Measurement
Test Channels	
<input checked="" type="radio"/> Lowest, Middle and Highest Channel	<input type="radio"/> Lowest and Highest Channel
Environmental conditions	
<input checked="" type="radio"/> Normal	<input type="radio"/> Normal and Extreme
Note: ●:Test    ○:No Test	

- The EUT was directly connected to the power meter and antenna output port as show in the block diagram below.
- Test was performed in accordance with method of FCC KDB 789033 D02 General UNII Test Procedures New Rules v02r01.

#### 3.4.3 Test Setup



### 3.4.4 Table of Parameters of Text Software Setting

No beamforming

UNII-1			
Test Software Version	accessMTool_REL_3_3_0_2		
Frequency (MHz)	5180	5200	5240
IEEE 802.11a	70	84	84
IEEE 802.11n(HT20)	70	88	88
IEEE 802.11ac(VHT20)	70	88	88
IEEE 802.11ax(HE20)	70	88	88
Frequency (MHz)	5190	5230	
IEEE 802.11n(HT40)	66	94	
IEEE 802.11ac(VHT40)	66	94	
IEEE 802.11ax(HE40)	64	94	
Frequency (MHz)	5210		
IEEE 802.11ac(VHT80)	62		
IEEE 802.11ax(HE80)	60		

UNII-2A						
Test Software Version	accessMTool_REL_3_3_0_2					
Frequency (MHz)	5260		5300		5320	
TPC	H	L	H	L	H	L
IEEE 802.11a	66	42	66	42	66	42
IEEE 802.11n(HT20)	67	42	67	42	67	42
IEEE 802.11ac(VHT20)	66	42	66	42	66	42
IEEE 802.11ax(HE20)	66	42	66	42	66	42
Frequency (MHz)	5270		5310			
IEEE 802.11n(HT40)	70	46	66	42		
IEEE 802.11ac(VHT40)	70	46	66	42		
IEEE 802.11ax(HE40)	70	46	64	40		
Frequency (MHz)	5290					
IEEE 802.11ac(VHT80)	62	36				
IEEE 802.11ax(HE80)	62	36				
Frequency (MHz)	5250					
IEEE 802.11ac(VHT160)	62	36				
IEEE 802.11ax(HE160)	62	36				

UNII-2C						
Test Software Version	accessMTool_REL_3_3_0_2					
Frequency (MHz)	5500		5580		5700	
TPC	H	L	H	L	H	L
IEEE 802.11a	66	42	66	42	66	42
IEEE 802.11n(HT20)	67	42	67	42	67	42
IEEE 802.11ac(VHT20)	66	42	66	42	66	42
IEEE 802.11ax(HE20)	66	42	66	42	66	42
Frequency (MHz)	5510		5550		5670	
IEEE 802.11n(HT40)	66	42	70	46	70	46
IEEE 802.11ac(VHT40)	66	42	70	46	70	46
IEEE 802.11ax(HE40)	64	40	70	46	70	46
Frequency (MHz)	5530		5610		/	
IEEE 802.11ac(VHT80)	62	36	74	48	/	
IEEE 802.11ax(HE80)	60	36	74	48	/	
Frequency (MHz)	5570		/		/	
IEEE 802.11ac(VHT160)	64	40	/		/	
IEEE 802.11ax(HE160)	64	40	/		/	

UNII-3			
Test Software Version	accessMTool_REL_3_3_0_2		
Frequency (MHz)	5745	5785	5825
IEEE 802.11a	82	94	82
IEEE 802.11n(HT20)	82	94	82
IEEE 802.11ac(VHT20)	82	94	82
IEEE 802.11ax(HE20)	82	94	82
Frequency (MHz)	5755	5795	/
IEEE 802.11n(HT40)	94	94	/
IEEE 802.11ac(VHT40)	94	94	/
IEEE 802.11ax(HE40)	94	94	/
Frequency (MHz)	5775	/	
IEEE 802.11ac(VHT80)	94	/	
IEEE 802.11ax(HE80)	94	/	



Beamforming

UNII-1			
Test Software Version	accessMTool_REL_3_3_0_2		
Frequency (MHz)	5180	5200	5240
IEEE 802.11n(HT20)	63	81	81
IEEE 802.11ac(VHT20)	63	81	81
IEEE 802.11ax(HE20)	63	81	81
Frequency (MHz)	5190	5230	
IEEE 802.11n(HT40)	59	87	
IEEE 802.11ac(VHT40)	59	87	
IEEE 802.11ax(HE40)	57	87	
Frequency (MHz)	5210		
IEEE 802.11ac(VHT80)	55		
IEEE 802.11ax(HE80)	53		

UNII-2A						
Test Software Version	accessMTool_REL_3_3_0_2					
Frequency (MHz)	5260		5300		5320	
TPC	H	L	H	L	H	L
IEEE 802.11n(HT20)	60	35	60	35	60	35
IEEE 802.11ac(VHT20)	59	35	59	35	59	35
IEEE 802.11ax(HE20)	59	35	59	35	59	35
Frequency (MHz)	5270		5310			
IEEE 802.11n(HT40)	63	39	59	35		
IEEE 802.11ac(VHT40)	63	39	59	35		
IEEE 802.11ax(HE40)	63	39	57	33		
Frequency (MHz)	5290					
IEEE 802.11ac(VHT80)	55	30				
IEEE 802.11ax(HE80)	55	30				
Frequency (MHz)	5250					
IEEE 802.11ac(VHT160)	55	30				
IEEE 802.11ax(HE160)	55	30				

UNII-2C						
Test Software Version	accessMTool_REL_3_3_0_2					
Frequency (MHz)	5500		5580		5700	
TPC	H	L	H	L	H	L
IEEE 802.11n(HT20)	60	35	60	35	60	35
IEEE 802.11ac(VHT20)	59	35	59	35	59	35
IEEE 802.11ax(HE20)	59	35	59	35	59	35
Frequency (MHz)	5510		5550		5670	
IEEE 802.11n(HT40)	59	35	63	39	63	39
IEEE 802.11ac(VHT40)	59	35	63	39	63	39
IEEE 802.11ax(HE40)	57	33	63	39	63	39
Frequency (MHz)	5530		5610		/	
IEEE 802.11ac(VHT80)	55	30	67	41	/	
IEEE 802.11ax(HE80)	53	28	67	41	/	
Frequency (MHz)	5570		/		/	
IEEE 802.11ac(VHT160)	57	33	/		/	
IEEE 802.11ax(HE160)	57	33	/		/	

UNII-3			
Test Software Version	accessMTool_REL_3_3_0_2		
Frequency (MHz)	5745	5785	5825
IEEE 802.11n(HT20)	75	87	75
IEEE 802.11ac(VHT20)	75	87	75
IEEE 802.11ax(HE20)	75	87	75
Frequency (MHz)	5755	5795	/
IEEE 802.11n(HT40)	87	87	/
IEEE 802.11ac(VHT40)	87	87	/
IEEE 802.11ax(HE40)	87	87	/
Frequency (MHz)	5775	/	
IEEE 802.11ac(VHT80)	87	/	
IEEE 802.11ax(HE80)	87	/	

### 3.4.5 The Result

No Beamforming

Test Mode	Antenna	Freq(MHz)	TPC Mode	Result [dBm]	Limit [dBm]	Verdict
11A-CDD	Ant1	5180	NA	16.88	≤30.00	PASS
	Ant2	5180	NA	16.54	≤30.00	PASS
	Ant3	5180	NA	16.37	≤30.00	PASS
	Ant4	5180	NA	16.63	≤30.00	PASS
	total	5180	NA	22.63	≤30.00	PASS
	Ant1	5200	NA	20.05	≤30.00	PASS
	Ant2	5200	NA	19.99	≤30.00	PASS
	Ant3	5200	NA	19.57	≤30.00	PASS
	Ant4	5200	NA	19.53	≤30.00	PASS
	total	5200	NA	25.81	≤30.00	PASS
	Ant1	5240	NA	20.31	≤30.00	PASS
	Ant2	5240	NA	19.67	≤30.00	PASS
	Ant3	5240	NA	19.76	≤30.00	PASS
	Ant4	5240	NA	19.75	≤30.00	PASS
	total	5240	NA	25.90	≤30.00	PASS
	Ant1	5260	TPC_L	8.80	≤23.98	PASS
			TPC_H	15.24	≤23.98	PASS
	Ant2	5260	TPC_L	8.61	≤23.98	PASS
			TPC_H	15.21	≤23.98	PASS
	Ant3	5260	TPC_L	8.50	≤23.98	PASS
			TPC_H	15.27	≤23.98	PASS
	Ant4	5260	TPC_L	8.17	≤23.98	PASS
			TPC_H	14.39	≤23.98	PASS
	total	5260	TPC_L	14.55	≤23.98	PASS
			TPC_H	21.06	≤23.98	PASS
	Ant1	5280	TPC_L	8.44	≤23.98	PASS
			TPC_H	15.30	≤23.98	PASS
	Ant2	5280	TPC_L	8.60	≤23.98	PASS
			TPC_H	15.44	≤23.98	PASS
	Ant3	5280	TPC_L	8.54	≤23.98	PASS
			TPC_H	15.08	≤23.98	PASS
	Ant4	5280	TPC_L	7.78	≤23.98	PASS
			TPC_H	14.73	≤23.98	PASS
	total	5280	TPC_L	14.37	≤23.98	PASS
			TPC_H	21.17	≤23.98	PASS
	Ant1	5320	TPC_L	8.67	≤23.98	PASS
			TPC_H	15.45	≤23.98	PASS
	Ant2	5320	TPC_L	9.21	≤23.98	PASS
			TPC_H	15.27	≤23.98	PASS

Ant3	5320	TPC_L	8.76	≤23.98	PASS
		TPC_H	15.19	≤23.98	PASS
Ant4	5320	TPC_L	7.87	≤23.98	PASS
		TPC_H	15.16	≤23.98	PASS
total	5320	TPC_L	14.67	≤23.98	PASS
		TPC_H	21.29	≤23.98	PASS
Ant1	5500	TPC_L	8.66	≤23.98	PASS
		TPC_H	15.11	≤23.98	PASS
Ant2	5500	TPC_L	8.35	≤23.98	PASS
		TPC_H	15.24	≤23.98	PASS
Ant3	5500	TPC_L	8.86	≤23.98	PASS
		TPC_H	15.16	≤23.98	PASS
Ant4	5500	TPC_L	8.42	≤23.98	PASS
		TPC_H	15.37	≤23.98	PASS
total	5500	TPC_L	14.60	≤23.98	PASS
		TPC_H	21.24	≤23.98	PASS
Ant1	5580	TPC_L	7.98	≤23.98	PASS
		TPC_H	14.89	≤23.98	PASS
Ant2	5580	TPC_L	8.25	≤23.98	PASS
		TPC_H	15.05	≤23.98	PASS
Ant3	5580	TPC_L	8.85	≤23.98	PASS
		TPC_H	14.98	≤23.98	PASS
Ant4	5580	TPC_L	8.43	≤23.98	PASS
		TPC_H	15.21	≤23.98	PASS
total	5580	TPC_L	14.41	≤23.98	PASS
		TPC_H	21.05	≤23.98	PASS
Ant1	5700	TPC_L	8.53	≤23.98	PASS
		TPC_H	14.97	≤23.98	PASS
Ant2	5700	TPC_L	8.44	≤23.98	PASS
		TPC_H	15.04	≤23.98	PASS
Ant3	5700	TPC_L	8.66	≤23.98	PASS
		TPC_H	15.07	≤23.98	PASS
Ant4	5700	TPC_L	8.10	≤23.98	PASS
		TPC_H	15.18	≤23.98	PASS
total	5700	TPC_L	14.46	≤23.98	PASS
		TPC_H	21.09	≤23.98	PASS
Ant1	5745	NA	19.45	≤30.00	PASS
Ant2	5745	NA	19.69	≤30.00	PASS
Ant3	5745	NA	19.31	≤30.00	PASS
Ant4	5745	NA	19.22	≤30.00	PASS
total	5745	NA	25.44	≤30.00	PASS
Ant1	5785	NA	22.93	≤30.00	PASS



	Ant2	5785	NA	22.84	≤30.00	PASS
	Ant3	5785	NA	22.58	≤30.00	PASS
	Ant4	5785	NA	22.78	≤30.00	PASS
	total	5785	NA	28.80	≤30.00	PASS
	Ant1	5825	NA	19.32	≤30.00	PASS
	Ant2	5825	NA	19.26	≤30.00	PASS
	Ant3	5825	NA	19.19	≤30.00	PASS
	Ant4	5825	NA	19.25	≤30.00	PASS
	total	5825	NA	25.28	≤30.00	PASS
11N20MIMO	Ant1	5180	NA	16.85	≤30.00	PASS
	Ant2	5180	NA	16.73	≤30.00	PASS
	Ant3	5180	NA	16.17	≤30.00	PASS
	Ant4	5180	NA	16.58	≤30.00	PASS
	total	5180	NA	22.61	≤30.00	PASS
	Ant1	5200	NA	20.93	≤30.00	PASS
	Ant2	5200	NA	20.82	≤30.00	PASS
	Ant3	5200	NA	20.62	≤30.00	PASS
	Ant4	5200	NA	20.67	≤30.00	PASS
	total	5200	NA	26.78	≤30.00	PASS
	Ant1	5240	NA	20.85	≤30.00	PASS
	Ant2	5240	NA	20.92	≤30.00	PASS
	Ant3	5240	NA	20.48	≤30.00	PASS
	Ant4	5240	NA	20.73	≤30.00	PASS
	total	5240	NA	26.77	≤30.00	PASS
	Ant1	5260	TPC_L	9.56	≤23.98	PASS
			TPC_H	15.67	≤23.98	PASS
	Ant2	5260	TPC_L	9.54	≤23.98	PASS
			TPC_H	15.34	≤23.98	PASS
	Ant3	5260	TPC_L	9.32	≤23.98	PASS
			TPC_H	15.22	≤23.98	PASS
	Ant4	5260	TPC_L	8.65	≤23.98	PASS
			TPC_H	15.23	≤23.98	PASS
	total	5260	TPC_L	15.30	≤23.98	PASS
			TPC_H	21.39	≤23.98	PASS
	Ant1	5280	TPC_L	9.80	≤23.98	PASS
			TPC_H	15.63	≤23.98	PASS
	Ant2	5280	TPC_L	9.58	≤23.98	PASS
			TPC_H	15.56	≤23.98	PASS
	Ant3	5280	TPC_L	9.39	≤23.98	PASS
			TPC_H	15.32	≤23.98	PASS
	Ant4	5280	TPC_L	8.63	≤23.98	PASS
			TPC_H	15.17	≤23.98	PASS

	total	5280	TPC_L	15.39	≤23.98	PASS
			TPC_H	21.44	≤23.98	PASS
	Ant1	5320	TPC_L	9.77	≤23.98	PASS
			TPC_H	15.32	≤23.98	PASS
	Ant2	5320	TPC_L	10.43	≤23.98	PASS
			TPC_H	15.48	≤23.98	PASS
	Ant3	5320	TPC_L	9.84	≤23.98	PASS
			TPC_H	15.18	≤23.98	PASS
	Ant4	5320	TPC_L	8.49	≤23.98	PASS
			TPC_H	15.17	≤23.98	PASS
	total	5320	TPC_L	15.71	≤23.98	PASS
			TPC_H	21.32	≤23.98	PASS
	Ant1	5500	TPC_L	9.44	≤23.98	PASS
			TPC_H	15.05	≤23.98	PASS
	Ant2	5500	TPC_L	8.88	≤23.98	PASS
			TPC_H	15.18	≤23.98	PASS
	Ant3	5500	TPC_L	9.59	≤23.98	PASS
			TPC_H	15.12	≤23.98	PASS
	Ant4	5500	TPC_L	9.36	≤23.98	PASS
			TPC_H	15.26	≤23.98	PASS
	total	5500	TPC_L	15.35	≤23.98	PASS
			TPC_H	21.17	≤23.98	PASS
	Ant1	5580	TPC_L	8.87	≤23.98	PASS
			TPC_H	15.14	≤23.98	PASS
	Ant2	5580	TPC_L	9.08	≤23.98	PASS
			TPC_H	15.27	≤23.98	PASS
	Ant3	5580	TPC_L	10.02	≤23.98	PASS
			TPC_H	15.34	≤23.98	PASS
	Ant4	5580	TPC_L	9.28	≤23.98	PASS
			TPC_H	15.33	≤23.98	PASS
total	5580	TPC_L	15.36	≤23.98	PASS	
		TPC_H	21.29	≤23.98	PASS	
Ant1	5700	TPC_L	9.00	≤23.98	PASS	
		TPC_H	15.13	≤23.98	PASS	
Ant2	5700	TPC_L	9.38	≤23.98	PASS	
		TPC_H	15.26	≤23.98	PASS	
Ant3	5700	TPC_L	10.00	≤23.98	PASS	
		TPC_H	15.48	≤23.98	PASS	
Ant4	5700	TPC_L	8.93	≤23.98	PASS	
		TPC_H	15.22	≤23.98	PASS	
total	5700	TPC_L	15.37	≤23.98	PASS	
		TPC_H	21.30	≤23.98	PASS	

	Ant1	5745	NA	19.43	≤30.00	PASS
	Ant2	5745	NA	19.98	≤30.00	PASS
	Ant3	5745	NA	19.27	≤30.00	PASS
	Ant4	5745	NA	19.53	≤30.00	PASS
	total	5745	NA	25.58	≤30.00	PASS
	Ant1	5785	NA	23.03	≤30.00	PASS
	Ant2	5785	NA	22.78	≤30.00	PASS
	Ant3	5785	NA	22.59	≤30.00	PASS
	Ant4	5785	NA	22.46	≤30.00	PASS
	total	5785	NA	28.74	≤30.00	PASS
	Ant1	5825	NA	19.22	≤30.00	PASS
	Ant2	5825	NA	19.45	≤30.00	PASS
	Ant3	5825	NA	18.94	≤30.00	PASS
	Ant4	5825	NA	19.36	≤30.00	PASS
	total	5825	NA	25.27	≤30.00	PASS
11N40MIMO	Ant1	5190	NA	15.87	≤30.00	PASS
	Ant2	5190	NA	15.81	≤30.00	PASS
	Ant3	5190	NA	15.57	≤30.00	PASS
	Ant4	5190	NA	15.63	≤30.00	PASS
	total	5190	NA	21.74	≤30.00	PASS
	Ant1	5230	NA	22.68	≤30.00	PASS
	Ant2	5230	NA	22.93	≤30.00	PASS
	Ant3	5230	NA	22.51	≤30.00	PASS
	Ant4	5230	NA	22.71	≤30.00	PASS
	total	5230	NA	28.73	≤30.00	PASS
	Ant1	5270	TPC_L	10.59	≤23.98	PASS
			TPC_H	16.64	≤23.98	PASS
	Ant2	5270	TPC_L	10.67	≤23.98	PASS
			TPC_H	16.57	≤23.98	PASS
	Ant3	5270	TPC_L	10.20	≤23.98	PASS
			TPC_H	16.27	≤23.98	PASS
	Ant4	5270	TPC_L	10.33	≤23.98	PASS
			TPC_H	16.65	≤23.98	PASS
	total	5270	TPC_L	16.47	≤23.98	PASS
			TPC_H	22.56	≤23.98	PASS
	Ant1	5310	TPC_L	9.93	≤23.98	PASS
			TPC_H	15.52	≤23.98	PASS
	Ant2	5310	TPC_L	10.29	≤23.98	PASS
			TPC_H	15.71	≤23.98	PASS
	Ant3	5310	TPC_L	9.67	≤23.98	PASS
			TPC_H	15.48	≤23.98	PASS
	Ant4	5310	TPC_L	9.44	≤23.98	PASS

			TPC_H	15.27	≤23.98	PASS
	total	5310	TPC_L	15.86	≤23.98	PASS
			TPC_H	21.52	≤23.98	PASS
	Ant1	5510	TPC_L	10.21	≤23.98	PASS
			TPC_H	15.68	≤23.98	PASS
	Ant2	5510	TPC_L	9.77	≤23.98	PASS
			TPC_H	15.79	≤23.98	PASS
	Ant3	5510	TPC_L	10.00	≤23.98	PASS
			TPC_H	15.48	≤23.98	PASS
	Ant4	5510	TPC_L	9.24	≤23.98	PASS
			TPC_H	15.22	≤23.98	PASS
	total	5510	TPC_L	15.84	≤23.98	PASS
			TPC_H	21.57	≤23.98	PASS
	Ant1	5550	TPC_L	10.92	≤23.98	PASS
			TPC_H	16.89	≤23.98	PASS
	Ant2	5550	TPC_L	10.60	≤23.98	PASS
			TPC_H	16.47	≤23.98	PASS
	Ant3	5550	TPC_L	10.89	≤23.98	PASS
			TPC_H	16.79	≤23.98	PASS
	Ant4	5550	TPC_L	10.40	≤23.98	PASS
			TPC_H	16.96	≤23.98	PASS
	total	5550	TPC_L	16.73	≤23.98	PASS
			TPC_H	22.80	≤23.98	PASS
	Ant1	5670	TPC_L	10.87	≤23.98	PASS
			TPC_H	16.59	≤23.98	PASS
	Ant2	5670	TPC_L	10.13	≤23.98	PASS
			TPC_H	16.44	≤23.98	PASS
	Ant3	5670	TPC_L	10.63	≤23.98	PASS
			TPC_H	16.52	≤23.98	PASS
	Ant4	5670	TPC_L	10.72	≤23.98	PASS
			TPC_H	16.87	≤23.98	PASS
	total	5670	TPC_L	16.62	≤23.98	PASS
			TPC_H	22.63	≤23.98	PASS
	Ant1	5755	NA	22.57	≤30.00	PASS
	Ant2	5755	NA	22.53	≤30.00	PASS
	Ant3	5755	NA	22.82	≤30.00	PASS
	Ant4	5755	NA	23.11	≤30.00	PASS
	total	5755	NA	28.78	≤30.00	PASS
	Ant1	5795	NA	22.54	≤30.00	PASS
	Ant2	5795	NA	23.02	≤30.00	PASS
	Ant3	5795	NA	22.97	≤30.00	PASS
	Ant4	5795	NA	22.87	≤30.00	PASS



	total	5795	NA	28.87	≤30.00	PASS
11AC20MIMO	Ant1	5180	NA	16.47	≤30.00	PASS
	Ant2	5180	NA	16.75	≤30.00	PASS
	Ant3	5180	NA	16.24	≤30.00	PASS
	Ant4	5180	NA	16.59	≤30.00	PASS
	total	5180	NA	22.54	≤30.00	PASS
	Ant1	5200	NA	20.66	≤30.00	PASS
	Ant2	5200	NA	20.74	≤30.00	PASS
	Ant3	5200	NA	20.36	≤30.00	PASS
	Ant4	5200	NA	20.51	≤30.00	PASS
	total	5200	NA	26.59	≤30.00	PASS
	Ant1	5240	NA	20.76	≤30.00	PASS
	Ant2	5240	NA	20.61	≤30.00	PASS
	Ant3	5240	NA	20.34	≤30.00	PASS
	Ant4	5240	NA	20.62	≤30.00	PASS
	total	5240	NA	26.61	≤30.00	PASS
	Ant1	5260	TPC_L	9.55	≤23.98	PASS
			TPC_H	15.59	≤23.98	PASS
	Ant2	5260	TPC_L	9.57	≤23.98	PASS
			TPC_H	15.01	≤23.98	PASS
	Ant3	5260	TPC_L	9.72	≤23.98	PASS
			TPC_H	15.43	≤23.98	PASS
	Ant4	5260	TPC_L	8.93	≤23.98	PASS
			TPC_H	15.78	≤23.98	PASS
	total	5260	TPC_L	15.47	≤23.98	PASS
			TPC_H	21.48	≤23.98	PASS
	Ant1	5280	TPC_L	10.03	≤23.98	PASS
			TPC_H	15.34	≤23.98	PASS
	Ant2	5280	TPC_L	9.89	≤23.98	PASS
			TPC_H	15.26	≤23.98	PASS
	Ant3	5280	TPC_L	9.66	≤23.98	PASS
			TPC_H	14.97	≤23.98	PASS
	Ant4	5280	TPC_L	8.88	≤23.98	PASS
TPC_H			15.46	≤23.98	PASS	
total	5280	TPC_L	15.66	≤23.98	PASS	
		TPC_H	21.30	≤23.98	PASS	
Ant1	5320	TPC_L	9.59	≤23.98	PASS	
		TPC_H	15.37	≤23.98	PASS	
Ant2	5320	TPC_L	10.26	≤23.98	PASS	
		TPC_H	15.32	≤23.98	PASS	
Ant3	5320	TPC_L	10.16	≤23.98	PASS	
		TPC_H	15.40	≤23.98	PASS	

	Ant4	5320	TPC_L	9.04	≤23.98	PASS
			TPC_H	15.06	≤23.98	PASS
	total	5320	TPC_L	15.81	≤23.98	PASS
			TPC_H	21.30	≤23.98	PASS
	Ant1	5500	TPC_L	10.03	≤23.98	PASS
			TPC_H	15.42	≤23.98	PASS
	Ant2	5500	TPC_L	9.22	≤23.98	PASS
			TPC_H	15.26	≤23.98	PASS
	Ant3	5500	TPC_L	10.18	≤23.98	PASS
			TPC_H	14.97	≤23.98	PASS
	Ant4	5500	TPC_L	9.57	≤23.98	PASS
			TPC_H	15.46	≤23.98	PASS
	total	5500	TPC_L	15.79	≤23.98	PASS
			TPC_H	21.60	≤23.98	PASS
	Ant1	5580	TPC_L	8.89	≤23.98	PASS
			TPC_H	15.21	≤23.98	PASS
	Ant2	5580	TPC_L	9.28	≤23.98	PASS
			TPC_H	15.35	≤23.98	PASS
	Ant3	5580	TPC_L	10.03	≤23.98	PASS
			TPC_H	15.48	≤23.98	PASS
	Ant4	5580	TPC_L	9.84	≤23.98	PASS
			TPC_H	15.29	≤23.98	PASS
	total	5580	TPC_L	15.55	≤23.98	PASS
			TPC_H	21.35	≤23.98	PASS
	Ant1	5700	TPC_L	9.52	≤23.98	PASS
			TPC_H	15.29	≤23.98	PASS
	Ant2	5700	TPC_L	9.69	≤23.98	PASS
			TPC_H	15.22	≤23.98	PASS
	Ant3	5700	TPC_L	10.19	≤23.98	PASS
			TPC_H	15.37	≤23.98	PASS
Ant4	5700	TPC_L	9.32	≤23.98	PASS	
		TPC_H	15.61	≤23.98	PASS	
total	5700	TPC_L	15.71	≤23.98	PASS	
		TPC_H	21.40	≤23.98	PASS	
Ant1	5745	NA	19.97	≤30.00	PASS	
Ant2	5745	NA	19.48	≤30.00	PASS	
Ant3	5745	NA	19.59	≤30.00	PASS	
Ant4	5745	NA	19.79	≤30.00	PASS	
total	5745	NA	25.73	≤30.00	PASS	
Ant1	5785	NA	22.93	≤30.00	PASS	
Ant2	5785	NA	22.74	≤30.00	PASS	
Ant3	5785	NA	22.88	≤30.00	PASS	

	Ant4	5785	NA	22.83	≤30.00	PASS
	total	5785	NA	28.87	≤30.00	PASS
	Ant1	5825	NA	19.63	≤30.00	PASS
	Ant2	5825	NA	19.63	≤30.00	PASS
	Ant3	5825	NA	19.53	≤30.00	PASS
	Ant4	5825	NA	19.32	≤30.00	PASS
	total	5825	NA	25.55	≤30.00	PASS
11AC40MIMO	Ant1	5190	NA	15.26	≤30.00	PASS
	Ant2	5190	NA	15.14	≤30.00	PASS
	Ant3	5190	NA	15.12	≤30.00	PASS
	Ant4	5190	NA	15.37	≤30.00	PASS
	total	5190	NA	21.24	≤30.00	PASS
	Ant1	5230	NA	22.56	≤30.00	PASS
	Ant2	5230	NA	22.63	≤30.00	PASS
	Ant3	5230	NA	22.72	≤30.00	PASS
	Ant4	5230	NA	22.78	≤30.00	PASS
	total	5230	NA	28.69	≤30.00	PASS
	Ant1	5270	TPC_L	11.17	≤23.98	PASS
			TPC_H	16.96	≤23.98	PASS
	Ant2	5270	TPC_L	11.03	≤23.98	PASS
			TPC_H	16.97	≤23.98	PASS
	Ant3	5270	TPC_L	10.61	≤23.98	PASS
			TPC_H	16.59	≤23.98	PASS
	Ant4	5270	TPC_L	10.82	≤23.98	PASS
			TPC_H	16.71	≤23.98	PASS
	total	5270	TPC_L	16.93	≤23.98	PASS
			TPC_H	22.83	≤23.98	PASS
	Ant1	5310	TPC_L	9.30	≤23.98	PASS
			TPC_H	15.15	≤23.98	PASS
	Ant2	5310	TPC_L	9.56	≤23.98	PASS
			TPC_H	15.63	≤23.98	PASS
	Ant3	5310	TPC_L	8.94	≤23.98	PASS
			TPC_H	14.93	≤23.98	PASS
	Ant4	5310	TPC_L	8.61	≤23.98	PASS
			TPC_H	14.74	≤23.98	PASS
	total	5310	TPC_L	15.14	≤23.98	PASS
			TPC_H	21.15	≤23.98	PASS
	Ant1	5510	TPC_L	9.18	≤23.98	PASS
			TPC_H	14.74	≤23.98	PASS
	Ant2	5510	TPC_L	8.59	≤23.98	PASS
			TPC_H	14.95	≤23.98	PASS
	Ant3	5510	TPC_L	8.60	≤23.98	PASS

	Ant4	5510	TPC_H	15.07	≤23.98	PASS
			TPC_L	8.38	≤23.98	PASS
			TPC_H	15.16	≤23.98	PASS
	total	5510	TPC_L	14.72	≤23.98	PASS
			TPC_H	21.00	≤23.98	PASS
	Ant1	5550	TPC_L	10.83	≤23.98	PASS
			TPC_H	16.68	≤23.98	PASS
	Ant2	5550	TPC_L	10.38	≤23.98	PASS
			TPC_H	16.76	≤23.98	PASS
	Ant3	5550	TPC_L	10.74	≤23.98	PASS
			TPC_H	16.24	≤23.98	PASS
	Ant4	5550	TPC_L	10.19	≤23.98	PASS
			TPC_H	16.47	≤23.98	PASS
	total	5550	TPC_L	16.56	≤23.98	PASS
			TPC_H	22.56	≤23.98	PASS
	Ant1	5670	TPC_L	10.68	≤23.98	PASS
			TPC_H	16.89	≤23.98	PASS
	Ant2	5670	TPC_L	10.20	≤23.98	PASS
			TPC_H	16.75	≤23.98	PASS
	Ant3	5670	TPC_L	10.38	≤23.98	PASS
			TPC_H	16.69	≤23.98	PASS
	Ant4	5670	TPC_L	10.74	≤23.98	PASS
			TPC_H	16.65	≤23.98	PASS
	total	5670	TPC_L	16.53	≤23.98	PASS
			TPC_H	22.77	≤23.98	PASS
	Ant1	5755	NA	22.67	≤30.00	PASS
	Ant2	5755	NA	22.63	≤30.00	PASS
	Ant3	5755	NA	23.10	≤30.00	PASS
	Ant4	5755	NA	22.54	≤30.00	PASS
	total	5755	NA	28.76	≤30.00	PASS
Ant1	5795	NA	22.26	≤30.00	PASS	
Ant2	5795	NA	22.99	≤30.00	PASS	
Ant3	5795	NA	22.98	≤30.00	PASS	
Ant4	5795	NA	22.52	≤30.00	PASS	
total	5795	NA	28.72	≤30.00	PASS	
11AC80MIMO	Ant1	5210	NA	14.92	≤30.00	PASS
	Ant2	5210	NA	14.78	≤30.00	PASS
	Ant3	5210	NA	14.87	≤30.00	PASS
	Ant4	5210	NA	14.46	≤30.00	PASS
	total	5210	NA	20.78	≤30.00	PASS
	Ant1	5290	TPC_L	8.64	≤23.98	PASS
TPC_H			14.75	≤23.98	PASS	

	Ant2	5290	TPC_L	9.14	≤23.98	PASS
			TPC_H	14.63	≤23.98	PASS
	Ant3	5290	TPC_L	9.15	≤23.98	PASS
			TPC_H	14.89	≤23.98	PASS
	Ant4	5290	TPC_L	8.83	≤23.98	PASS
			TPC_H	15.02	≤23.98	PASS
	total	5290	TPC_L	14.97	≤23.98	PASS
			TPC_H	20.85	≤23.98	PASS
	Ant1	5530	TPC_L	8.29	≤23.98	PASS
			TPC_H	14.62	≤23.98	PASS
	Ant2	5530	TPC_L	7.88	≤23.98	PASS
			TPC_H	14.85	≤23.98	PASS
	Ant3	5530	TPC_L	8.79	≤23.98	PASS
			TPC_H	14.68	≤23.98	PASS
	Ant4	5530	TPC_L	7.94	≤23.98	PASS
			TPC_H	14.58	≤23.98	PASS
	total	5530	TPC_L	14.26	≤23.98	PASS
			TPC_H	20.70	≤23.98	PASS
	Ant1	5610	TPC_L	10.96	≤23.98	PASS
			TPC_H	17.78	≤23.98	PASS
	Ant2	5610	TPC_L	10.80	≤23.98	PASS
			TPC_H	17.83	≤23.98	PASS
	Ant3	5610	TPC_L	11.39	≤23.98	PASS
			TPC_H	17.65	≤23.98	PASS
	Ant4	5610	TPC_L	11.53	≤23.98	PASS
			TPC_H	17.67	≤23.98	PASS
	total	5610	TPC_L	17.20	≤23.98	PASS
			TPC_H	23.75	≤23.98	PASS
	Ant1	5775	NA	22.77	≤30.00	PASS
	Ant2	5775	NA	22.72	≤30.00	PASS
Ant3	5775	NA	22.59	≤30.00	PASS	
Ant4	5775	NA	22.75	≤30.00	PASS	
total	5775	NA	28.73	≤30.00	PASS	
11AC160MIMO	Ant1	5250_UNII-1	TPC_L	6.04	≤30.00	PASS
			TPC_H	11.67	≤30.00	PASS
	Ant2	5250_UNII-1	TPC_L	5.86	≤30.00	PASS
			TPC_H	11.85	≤30.00	PASS
	Ant3	5250_UNII-1	TPC_L	5.27	≤30.00	PASS
			TPC_H	11.61	≤30.00	PASS
	Ant4	5250_UNII-1	TPC_L	4.99	≤30.00	PASS
			TPC_H	12.07	≤30.00	PASS
	total	5250_UNII-1	TPC_L	11.58	≤30.00	PASS

	Ant1	5250_UNII-2A	TPC_H	17.82	≤30.00	PASS
			TPC_L	5.04	≤23.98	PASS
			TPC_H	10.86	≤23.98	PASS
	Ant2	5250_UNII-2A	TPC_L	4.95	≤23.98	PASS
			TPC_H	11.09	≤23.98	PASS
	Ant3	5250_UNII-2A	TPC_L	4.38	≤23.98	PASS
			TPC_H	10.83	≤23.98	PASS
	Ant4	5250_UNII-2A	TPC_L	3.93	≤23.98	PASS
			TPC_H	11.12	≤23.98	PASS
	total	5250_UNII-2A	TPC_L	10.62	≤23.98	PASS
			TPC_H	17.00	≤23.98	PASS
	Ant1	5570	TPC_L	10.52	≤23.98	PASS
			TPC_H	15.15	≤23.98	PASS
	Ant2	5570	TPC_L	10.58	≤23.98	PASS
			TPC_H	15.46	≤23.98	PASS
	Ant3	5570	TPC_L	10.72	≤23.98	PASS
			TPC_H	15.68	≤23.98	PASS
	Ant4	5570	TPC_L	10.28	≤23.98	PASS
			TPC_H	15.43	≤23.98	PASS
	total	5570	TPC_L	16.55	≤23.98	PASS
TPC_H			21.45	≤23.98	PASS	
11AX20MIMO	Ant1	5180	NA	16.34	≤30.00	PASS
	Ant2	5180	NA	16.26	≤30.00	PASS
	Ant3	5180	NA	16.11	≤30.00	PASS
	Ant4	5180	NA	16.02	≤30.00	PASS
	total	5180	NA	22.20	≤30.00	PASS
	Ant1	5200	NA	21.31	≤30.00	PASS
	Ant2	5200	NA	21.32	≤30.00	PASS
	Ant3	5200	NA	21.06	≤30.00	PASS
	Ant4	5200	NA	21.35	≤30.00	PASS
	total	5200	NA	27.28	≤30.00	PASS
	Ant1	5240	NA	21.45	≤30.00	PASS
	Ant2	5240	NA	20.95	≤30.00	PASS
	Ant3	5240	NA	20.61	≤30.00	PASS
	Ant4	5240	NA	21.29	≤30.00	PASS
	total	5240	NA	27.11	≤30.00	PASS
	Ant1	5260	TPC_L	9.88	≤23.98	PASS
			TPC_H	15.44	≤23.98	PASS
	Ant2	5260	TPC_L	9.71	≤23.98	PASS
			TPC_H	15.49	≤23.98	PASS
	Ant3	5260	TPC_L	9.56	≤23.98	PASS
TPC_H			15.33	≤23.98	PASS	



	Ant4	5260	TPC_L	8.94	≤23.98	PASS
			TPC_H	15.32	≤23.98	PASS
	total	5260	TPC_L	15.56	≤23.98	PASS
			TPC_H	21.42	≤23.98	PASS
	Ant1	5280	TPC_L	9.91	≤23.98	PASS
			TPC_H	15.04	≤23.98	PASS
	Ant2	5280	TPC_L	9.75	≤23.98	PASS
			TPC_H	15.38	≤23.98	PASS
	Ant3	5280	TPC_L	9.45	≤23.98	PASS
			TPC_H	15.33	≤23.98	PASS
	Ant4	5280	TPC_L	8.88	≤23.98	PASS
			TPC_H	15.27	≤23.98	PASS
	total	5280	TPC_L	15.54	≤23.98	PASS
			TPC_H	21.28	≤23.98	PASS
	Ant1	5320	TPC_L	9.32	≤23.98	PASS
			TPC_H	14.98	≤23.98	PASS
	Ant2	5320	TPC_L	9.74	≤23.98	PASS
			TPC_H	15.24	≤23.98	PASS
	Ant3	5320	TPC_L	9.34	≤23.98	PASS
			TPC_H	15.34	≤23.98	PASS
	Ant4	5320	TPC_L	8.32	≤23.98	PASS
			TPC_H	15.13	≤23.98	PASS
	total	5320	TPC_L	15.23	≤23.98	PASS
			TPC_H	21.20	≤23.98	PASS
	Ant1	5500	TPC_L	9.93	≤23.98	PASS
			TPC_H	15.33	≤23.98	PASS
	Ant2	5500	TPC_L	9.36	≤23.98	PASS
			TPC_H	15.22	≤23.98	PASS
	Ant3	5500	TPC_L	9.97	≤23.98	PASS
			TPC_H	15.17	≤23.98	PASS
Ant4	5500	TPC_L	9.54	≤23.98	PASS	
		TPC_H	15.26	≤23.98	PASS	
total	5500	TPC_L	15.73	≤23.98	PASS	
		TPC_H	21.27	≤23.98	PASS	
Ant1	5580	TPC_L	8.56	≤23.98	PASS	
		TPC_H	15.07	≤23.98	PASS	
Ant2	5580	TPC_L	8.62	≤23.98	PASS	
		TPC_H	14.73	≤23.98	PASS	
Ant3	5580	TPC_L	9.38	≤23.98	PASS	
		TPC_H	15.56	≤23.98	PASS	
Ant4	5580	TPC_L	9.03	≤23.98	PASS	
		TPC_H	14.90	≤23.98	PASS	

	total	5580	TPC_L	14.93	≤23.98	PASS
			TPC_H	21.10	≤23.98	PASS
	Ant1	5700	TPC_L	9.54	≤23.98	PASS
			TPC_H	15.49	≤23.98	PASS
	Ant2	5700	TPC_L	9.89	≤23.98	PASS
			TPC_H	14.84	≤23.98	PASS
	Ant3	5700	TPC_L	10.08	≤23.98	PASS
			TPC_H	15.01	≤23.98	PASS
	Ant4	5700	TPC_L	9.06	≤23.98	PASS
			TPC_H	15.02	≤23.98	PASS
	total	5700	TPC_L	15.68	≤23.98	PASS
			TPC_H	21.12	≤23.98	PASS
	Ant1	5745	NA	19.96	≤30.00	PASS
	Ant2	5745	NA	19.18	≤30.00	PASS
	Ant3	5745	NA	19.22	≤30.00	PASS
	Ant4	5745	NA	19.51	≤30.00	PASS
	total	5745	NA	25.50	≤30.00	PASS
	Ant1	5785	NA	22.71	≤30.00	PASS
	Ant2	5785	NA	22.68	≤30.00	PASS
	Ant3	5785	NA	23.14	≤30.00	PASS
	Ant4	5785	NA	22.94	≤30.00	PASS
	total	5785	NA	28.89	≤30.00	PASS
	Ant1	5825	NA	19.72	≤30.00	PASS
	Ant2	5825	NA	19.57	≤30.00	PASS
	Ant3	5825	NA	19.34	≤30.00	PASS
	Ant4	5825	NA	19.76	≤30.00	PASS
	total	5825	NA	25.62	≤30.00	PASS
	11AX40MIMO	Ant1	5190	NA	15.25	≤30.00
Ant2		5190	NA	15.47	≤30.00	PASS
Ant3		5190	NA	14.96	≤30.00	PASS
Ant4		5190	NA	15.17	≤30.00	PASS
total		5190	NA	21.24	≤30.00	PASS
Ant1		5230	NA	23.02	≤30.00	PASS
Ant2		5230	NA	22.51	≤30.00	PASS
Ant3		5230	NA	23.19	≤30.00	PASS
Ant4		5230	NA	22.62	≤30.00	PASS
total		5230	NA	28.86	≤30.00	PASS
Ant1		5270	TPC_L	10.36	≤23.98	PASS
			TPC_H	16.61	≤23.98	PASS
Ant2		5270	TPC_L	10.18	≤23.98	PASS
			TPC_H	16.25	≤23.98	PASS
Ant3		5270	TPC_L	9.84	≤23.98	PASS

			TPC_H	16.71	≤23.98	PASS
	Ant4	5270	TPC_L	9.79	≤23.98	PASS
			TPC_H	16.59	≤23.98	PASS
	total	5270	TPC_L	16.07	≤23.98	PASS
			TPC_H	22.56	≤23.98	PASS
	Ant1	5310	TPC_L	9.43	≤23.98	PASS
			TPC_H	15.21	≤23.98	PASS
	Ant2	5310	TPC_L	9.93	≤23.98	PASS
			TPC_H	15.49	≤23.98	PASS
	Ant3	5310	TPC_L	9.28	≤23.98	PASS
			TPC_H	15.09	≤23.98	PASS
	Ant4	5310	TPC_L	9.07	≤23.98	PASS
			TPC_H	14.97	≤23.98	PASS
	total	5310	TPC_L	15.46	≤23.98	PASS
			TPC_H	21.21	≤23.98	PASS
	Ant1	5510	TPC_L	9.83	≤23.98	PASS
			TPC_H	15.31	≤23.98	PASS
	Ant2	5510	TPC_L	9.31	≤23.98	PASS
			TPC_H	15.14	≤23.98	PASS
	Ant3	5510	TPC_L	9.65	≤23.98	PASS
			TPC_H	15.27	≤23.98	PASS
	Ant4	5510	TPC_L	8.97	≤23.98	PASS
			TPC_H	14.88	≤23.98	PASS
	total	5510	TPC_L	15.47	≤23.98	PASS
			TPC_H	21.17	≤23.98	PASS
	Ant1	5550	TPC_L	10.62	≤23.98	PASS
			TPC_H	16.84	≤23.98	PASS
	Ant2	5550	TPC_L	10.09	≤23.98	PASS
			TPC_H	16.27	≤23.98	PASS
	Ant3	5550	TPC_L	10.50	≤23.98	PASS
			TPC_H	16.71	≤23.98	PASS
	Ant4	5550	TPC_L	10.05	≤23.98	PASS
			TPC_H	16.73	≤23.98	PASS
	total	5550	TPC_L	16.34	≤23.98	PASS
			TPC_H	22.66	≤23.98	PASS
	Ant1	5670	TPC_L	10.46	≤23.98	PASS
			TPC_H	16.86	≤23.98	PASS
	Ant2	5670	TPC_L	9.68	≤23.98	PASS
			TPC_H	16.88	≤23.98	PASS
	Ant3	5670	TPC_L	10.21	≤23.98	PASS
			TPC_H	16.69	≤23.98	PASS
	Ant4	5670	TPC_L	10.55	≤23.98	PASS

			TPC_H	16.48	≤23.98	PASS
	total	5670	TPC_L	16.26	≤23.98	PASS
			TPC_H	22.75	≤23.98	PASS
	Ant1	5755	NA	22.63	≤30.00	PASS
	Ant2	5755	NA	22.55	≤30.00	PASS
	Ant3	5755	NA	22.98	≤30.00	PASS
	Ant4	5755	NA	22.59	≤30.00	PASS
	total	5755	NA	29.00	≤30.00	PASS
	Ant1	5795	NA	22.75	≤30.00	PASS
	Ant2	5795	NA	22.87	≤30.00	PASS
	Ant3	5795	NA	22.59	≤30.00	PASS
	Ant4	5795	NA	22.67	≤30.00	PASS
total	5795	NA	28.74	≤30.00	PASS	
11AX80MIMO	Ant1	5210	NA	14.31	≤30.00	PASS
	Ant2	5210	NA	14.25	≤30.00	PASS
	Ant3	5210	NA	14.33	≤30.00	PASS
	Ant4	5210	NA	14.17	≤30.00	PASS
	total	5210	NA	20.29	≤30.00	PASS
	Ant1	5290	TPC_L	8.59	≤23.98	PASS
			TPC_H	14.61	≤23.98	PASS
	Ant2	5290	TPC_L	9.06	≤23.98	PASS
			TPC_H	14.15	≤23.98	PASS
	Ant3	5290	TPC_L	8.96	≤23.98	PASS
			TPC_H	14.24	≤23.98	PASS
	Ant4	5290	TPC_L	8.51	≤23.98	PASS
			TPC_H	14.75	≤23.98	PASS
	total	5290	TPC_L	14.81	≤23.98	PASS
			TPC_H	20.47	≤23.98	PASS
	Ant1	5530	TPC_L	8.54	≤23.98	PASS
			TPC_H	14.45	≤23.98	PASS
	Ant2	5530	TPC_L	7.99	≤23.98	PASS
			TPC_H	14.08	≤23.98	PASS
	Ant3	5530	TPC_L	9.04	≤23.98	PASS
			TPC_H	13.98	≤23.98	PASS
	Ant4	5530	TPC_L	8.05	≤23.98	PASS
			TPC_H	13.87	≤23.98	PASS
	total	5530	TPC_L	14.45	≤23.98	PASS
			TPC_H	20.12	≤23.98	PASS
	Ant1	5610	TPC_L	11.07	≤23.98	PASS
			TPC_H	17.95	≤23.98	PASS
	Ant2	5610	TPC_L	11.15	≤23.98	PASS
			TPC_H	17.89	≤23.98	PASS

	Ant3	5610	TPC_L	11.49	≤23.98	PASS
			TPC_H	17.54	≤23.98	PASS
	Ant4	5610	TPC_L	11.83	≤23.98	PASS
			TPC_H	17.88	≤23.98	PASS
	total	5610	TPC_L	17.42	≤23.98	PASS
			TPC_H	23.84	≤23.98	PASS
	Ant1	5775	NA	22.31	≤30.00	PASS
	Ant2	5775	NA	22.76	≤30.00	PASS
Ant3	5775	NA	22.49	≤30.00	PASS	
Ant4	5775	NA	22.87	≤30.00	PASS	
total	5775	NA	28.63	≤30.00	PASS	
11AX160MIMO	Ant1	5250_UNII-1	TPC_L	6.75	≤30.00	PASS
			TPC_H	11.69	≤30.00	PASS
	Ant2	5250_UNII-1	TPC_L	6.16	≤30.00	PASS
			TPC_H	12.26	≤30.00	PASS
	Ant3	5250_UNII-1	TPC_L	5.37	≤30.00	PASS
			TPC_H	11.95	≤30.00	PASS
	Ant4	5250_UNII-1	TPC_L	5.13	≤30.00	PASS
			TPC_H	12.04	≤30.00	PASS
	total	5250_UNII-1	TPC_L	11.92	≤30.00	PASS
			TPC_H	18.01	≤30.00	PASS
	Ant1	5250_UNII-2A	TPC_L	6.03	≤23.98	PASS
			TPC_H	11.08	≤23.98	PASS
	Ant2	5250_UNII-2A	TPC_L	6.06	≤23.98	PASS
			TPC_H	11.57	≤23.98	PASS
	Ant3	5250_UNII-2A	TPC_L	5.37	≤23.98	PASS
			TPC_H	11.03	≤23.98	PASS
	Ant4	5250_UNII-2A	TPC_L	4.86	≤23.98	PASS
			TPC_H	10.98	≤23.98	PASS
	total	5250_UNII-2A	TPC_L	11.63	≤23.98	PASS
			TPC_H	17.19	≤23.98	PASS
	Ant1	5570	TPC_L	9.15	≤23.98	PASS
			TPC_H	15.17	≤23.98	PASS
	Ant2	5570	TPC_L	9.12	≤23.98	PASS
			TPC_H	15.36	≤23.98	PASS
	Ant3	5570	TPC_L	9.35	≤23.98	PASS
			TPC_H	15.24	≤23.98	PASS
	Ant4	5570	TPC_L	8.54	≤23.98	PASS
			TPC_H	15.31	≤23.98	PASS
total	5570	TPC_L	15.07	≤23.98	PASS	
		TPC_H	21.29	≤23.98	PASS	

Note: The Duty Cycle Factor is compensated in the test system

Unequal antenna gains, with equal transmit powers. For antenna gains given by  $G_1, G_2, \dots, G_N$  dBi  
 If transmit signals are correlated, then Directional gain =  $10 \log[(10^{G_1 \text{ phi}/20} + 10^{G_2 \text{ phi}/20} + \dots + 10^{G_N \text{ phi}/20}) / N_{ANT} + (10^{G_1 \text{ theta}/20} + 10^{G_2 \text{ theta}/20} + \dots + 10^{G_N \text{ theta}/20})^2 / N_{ANT}]$  dBi [Note the “20”s in the denominator of each exponent and the square of the sum of terms; the object is to combine the signal levels coherently.]  
 Directional gain = 2.11dBi

### Beamforming

Test Mode	Antenna	Freq(MHz)	TPC Mode	Result [dBm]	Limit [dBm]	Verdict
11N20MIMO	Ant1	5180	NA	15.23	≤30.00	PASS
	Ant2	5180	NA	15.11	≤30.00	PASS
	Ant3	5180	NA	14.55	≤30.00	PASS
	Ant4	5180	NA	14.96	≤30.00	PASS
	total	5180	NA	20.99	≤30.00	PASS
	Ant1	5200	NA	19.35	≤30.00	PASS
	Ant2	5200	NA	19.24	≤30.00	PASS
	Ant3	5200	NA	19.04	≤30.00	PASS
	Ant4	5200	NA	19.09	≤30.00	PASS
	total	5200	NA	25.20	≤30.00	PASS
	Ant1	5240	NA	19.29	≤30.00	PASS
	Ant2	5240	NA	19.36	≤30.00	PASS
	Ant3	5240	NA	18.92	≤30.00	PASS
	Ant4	5240	NA	19.17	≤30.00	PASS
	total	5240	NA	25.21	≤30.00	PASS
	Ant1	5260	TPC_L	7.99	≤23.98	PASS
			TPC_H	14.10	≤23.98	PASS
	Ant2	5260	TPC_L	7.97	≤23.98	PASS
			TPC_H	13.77	≤23.98	PASS
	Ant3	5260	TPC_L	7.75	≤23.98	PASS
			TPC_H	13.65	≤23.98	PASS
	Ant4	5260	TPC_L	7.08	≤23.98	PASS
			TPC_H	13.66	≤23.98	PASS
	total	5260	TPC_L	13.73	≤23.98	PASS
			TPC_H	19.82	≤23.98	PASS
	Ant1	5280	TPC_L	8.18	≤23.98	PASS
			TPC_H	14.01	≤23.98	PASS
	Ant2	5280	TPC_L	7.96	≤23.98	PASS
			TPC_H	13.94	≤23.98	PASS
	Ant3	5280	TPC_L	7.77	≤23.98	PASS
			TPC_H	13.70	≤23.98	PASS
	Ant4	5280	TPC_L	7.01	≤23.98	PASS



			TPC_H	13.55	≤23.98	PASS
	total	5280	TPC_L	13.77	≤23.98	PASS
			TPC_H	19.82	≤23.98	PASS
	Ant1	5320	TPC_L	8.21	≤23.98	PASS
			TPC_H	13.76	≤23.98	PASS
	Ant2	5320	TPC_L	8.87	≤23.98	PASS
			TPC_H	13.92	≤23.98	PASS
	Ant3	5320	TPC_L	8.28	≤23.98	PASS
			TPC_H	13.62	≤23.98	PASS
	Ant4	5320	TPC_L	6.93	≤23.98	PASS
			TPC_H	13.61	≤23.98	PASS
	total	5320	TPC_L	14.15	≤23.98	PASS
			TPC_H	19.76	≤23.98	PASS
	Ant1	5500	TPC_L	7.89	≤23.98	PASS
			TPC_H	13.50	≤23.98	PASS
	Ant2	5500	TPC_L	7.33	≤23.98	PASS
			TPC_H	13.63	≤23.98	PASS
	Ant3	5500	TPC_L	8.04	≤23.98	PASS
			TPC_H	13.57	≤23.98	PASS
	Ant4	5500	TPC_L	7.81	≤23.98	PASS
			TPC_H	13.71	≤23.98	PASS
	total	5500	TPC_L	13.80	≤23.98	PASS
			TPC_H	19.62	≤23.98	PASS
	Ant1	5580	TPC_L	7.26	≤23.98	PASS
			TPC_H	13.53	≤23.98	PASS
	Ant2	5580	TPC_L	7.47	≤23.98	PASS
			TPC_H	13.66	≤23.98	PASS
	Ant3	5580	TPC_L	8.41	≤23.98	PASS
			TPC_H	13.73	≤23.98	PASS
	Ant4	5580	TPC_L	7.67	≤23.98	PASS
			TPC_H	13.72	≤23.98	PASS
	total	5580	TPC_L	13.75	≤23.98	PASS
			TPC_H	19.68	≤23.98	PASS
	Ant1	5700	TPC_L	7.45	≤23.98	PASS
			TPC_H	13.58	≤23.98	PASS
	Ant2	5700	TPC_L	7.83	≤23.98	PASS
			TPC_H	13.71	≤23.98	PASS
	Ant3	5700	TPC_L	8.45	≤23.98	PASS
			TPC_H	13.93	≤23.98	PASS
	Ant4	5700	TPC_L	7.38	≤23.98	PASS
			TPC_H	13.67	≤23.98	PASS
	total	5700	TPC_L	13.82	≤23.98	PASS

			TPC_H	19.75	≤23.98	PASS
	Ant1	5745	NA	17.88	≤30.00	PASS
	Ant2	5745	NA	18.43	≤30.00	PASS
	Ant3	5745	NA	17.72	≤30.00	PASS
	Ant4	5745	NA	17.98	≤30.00	PASS
	total	5745	NA	24.03	≤30.00	PASS
	Ant1	5785	NA	21.46	≤30.00	PASS
	Ant2	5785	NA	21.21	≤30.00	PASS
	Ant3	5785	NA	21.02	≤30.00	PASS
	Ant4	5785	NA	20.89	≤30.00	PASS
	total	5785	NA	27.17	≤30.00	PASS
	Ant1	5825	NA	17.70	≤30.00	PASS
	Ant2	5825	NA	17.93	≤30.00	PASS
	Ant3	5825	NA	17.42	≤30.00	PASS
	Ant4	5825	NA	17.84	≤30.00	PASS
total	5825	NA	23.75	≤30.00	PASS	
11N40MIMO	Ant1	5190	NA	14.25	≤30.00	PASS
	Ant2	5190	NA	14.19	≤30.00	PASS
	Ant3	5190	NA	13.95	≤30.00	PASS
	Ant4	5190	NA	14.01	≤30.00	PASS
	total	5190	NA	20.12	≤30.00	PASS
	Ant1	5230	NA	21.10	≤30.00	PASS
	Ant2	5230	NA	21.35	≤30.00	PASS
	Ant3	5230	NA	20.93	≤30.00	PASS
	Ant4	5230	NA	21.13	≤30.00	PASS
	total	5230	NA	27.15	≤30.00	PASS
	Ant1	5270	TPC_L	9.02	≤23.98	PASS
			TPC_H	15.07	≤23.98	PASS
	Ant2	5270	TPC_L	9.10	≤23.98	PASS
			TPC_H	15.00	≤23.98	PASS
	Ant3	5270	TPC_L	8.63	≤23.98	PASS
			TPC_H	14.70	≤23.98	PASS
	Ant4	5270	TPC_L	8.76	≤23.98	PASS
			TPC_H	15.08	≤23.98	PASS
	total	5270	TPC_L	14.90	≤23.98	PASS
			TPC_H	20.99	≤23.98	PASS
	Ant1	5310	TPC_L	8.31	≤23.98	PASS
			TPC_H	13.90	≤23.98	PASS
	Ant2	5310	TPC_L	8.67	≤23.98	PASS
			TPC_H	14.09	≤23.98	PASS
Ant3	5310	TPC_L	8.05	≤23.98	PASS	
		TPC_H	13.86	≤23.98	PASS	

Ant4	5310	TPC_L	7.82	≤23.98	PASS
		TPC_H	13.65	≤23.98	PASS
total	5310	TPC_L	14.24	≤23.98	PASS
		TPC_H	19.90	≤23.98	PASS
Ant1	5510	TPC_L	8.65	≤23.98	PASS
		TPC_H	14.12	≤23.98	PASS
Ant2	5510	TPC_L	8.21	≤23.98	PASS
		TPC_H	14.23	≤23.98	PASS
Ant3	5510	TPC_L	8.44	≤23.98	PASS
		TPC_H	13.92	≤23.98	PASS
Ant4	5510	TPC_L	7.68	≤23.98	PASS
		TPC_H	13.66	≤23.98	PASS
total	5510	TPC_L	14.28	≤23.98	PASS
		TPC_H	20.01	≤23.98	PASS
Ant1	5550	TPC_L	9.37	≤23.98	PASS
		TPC_H	15.34	≤23.98	PASS
Ant2	5550	TPC_L	9.05	≤23.98	PASS
		TPC_H	14.92	≤23.98	PASS
Ant3	5550	TPC_L	9.34	≤23.98	PASS
		TPC_H	15.24	≤23.98	PASS
Ant4	5550	TPC_L	8.85	≤23.98	PASS
		TPC_H	15.41	≤23.98	PASS
total	5550	TPC_L	15.18	≤23.98	PASS
		TPC_H	21.25	≤23.98	PASS
Ant1	5670	TPC_L	9.26	≤23.98	PASS
		TPC_H	14.98	≤23.98	PASS
Ant2	5670	TPC_L	8.52	≤23.98	PASS
		TPC_H	14.83	≤23.98	PASS
Ant3	5670	TPC_L	9.02	≤23.98	PASS
		TPC_H	14.91	≤23.98	PASS
Ant4	5670	TPC_L	9.11	≤23.98	PASS
		TPC_H	15.26	≤23.98	PASS
total	5670	TPC_L	15.01	≤23.98	PASS
		TPC_H	21.02	≤23.98	PASS
Ant1	5755	NA	21.02	≤30.00	PASS
Ant2	5755	NA	20.98	≤30.00	PASS
Ant3	5755	NA	21.27	≤30.00	PASS
Ant4	5755	NA	21.56	≤30.00	PASS
total	5755	NA	27.23	≤30.00	PASS
Ant1	5795	NA	20.93	≤30.00	PASS
Ant2	5795	NA	21.41	≤30.00	PASS
Ant3	5795	NA	21.36	≤30.00	PASS

	Ant4	5795	NA	21.26	≤30.00	PASS
	total	5795	NA	27.26	≤30.00	PASS
11AC20MIMO	Ant1	5180	NA	14.91	≤30.00	PASS
	Ant2	5180	NA	15.19	≤30.00	PASS
	Ant3	5180	NA	14.68	≤30.00	PASS
	Ant4	5180	NA	15.03	≤30.00	PASS
	total	5180	NA	20.98	≤30.00	PASS
	Ant1	5200	NA	19.07	≤30.00	PASS
	Ant2	5200	NA	19.15	≤30.00	PASS
	Ant3	5200	NA	18.77	≤30.00	PASS
	Ant4	5200	NA	18.92	≤30.00	PASS
	total	5200	NA	25.00	≤30.00	PASS
	Ant1	5240	NA	19.21	≤30.00	PASS
	Ant2	5240	NA	19.06	≤30.00	PASS
	Ant3	5240	NA	18.79	≤30.00	PASS
	Ant4	5240	NA	19.07	≤30.00	PASS
	total	5240	NA	25.06	≤30.00	PASS
	Ant1	5260	TPC_L	8.02	≤23.98	PASS
			TPC_H	14.06	≤23.98	PASS
	Ant2	5260	TPC_L	8.04	≤23.98	PASS
			TPC_H	13.48	≤23.98	PASS
	Ant3	5260	TPC_L	8.19	≤23.98	PASS
			TPC_H	13.86	≤23.98	PASS
	Ant4	5260	TPC_L	7.36	≤23.98	PASS
			TPC_H	14.21	≤23.98	PASS
	total	5260	TPC_L	13.90	≤23.98	PASS
			TPC_H	19.91	≤23.98	PASS
	Ant1	5280	TPC_L	8.46	≤23.98	PASS
			TPC_H	13.77	≤23.98	PASS
	Ant2	5280	TPC_L	8.32	≤23.98	PASS
			TPC_H	13.69	≤23.98	PASS
	Ant3	5280	TPC_L	8.09	≤23.98	PASS
			TPC_H	13.35	≤23.98	PASS
	Ant4	5280	TPC_L	7.26	≤23.98	PASS
TPC_H			13.84	≤23.98	PASS	
total	5280	TPC_L	14.04	≤23.98	PASS	
		TPC_H	19.68	≤23.98	PASS	
Ant1	5320	TPC_L	7.97	≤23.98	PASS	
		TPC_H	13.75	≤23.98	PASS	
Ant2	5320	TPC_L	8.64	≤23.98	PASS	
		TPC_H	13.70	≤23.98	PASS	
Ant3	5320	TPC_L	8.54	≤23.98	PASS	

			TPC_H	13.84	≤23.98	PASS
Ant4	5320		TPC_L	7.48	≤23.98	PASS
			TPC_H	13.50	≤23.98	PASS
total	5320		TPC_L	14.25	≤23.98	PASS
			TPC_H	19.74	≤23.98	PASS
Ant1	5500		TPC_L	8.47	≤23.98	PASS
			TPC_H	13.86	≤23.98	PASS
Ant2	5500		TPC_L	7.66	≤23.98	PASS
			TPC_H	13.70	≤23.98	PASS
Ant3	5500		TPC_L	8.62	≤23.98	PASS
			TPC_H	13.42	≤23.98	PASS
Ant4	5500		TPC_L	8.02	≤23.98	PASS
			TPC_H	13.91	≤23.98	PASS
total	5500		TPC_L	14.24	≤23.98	PASS
			TPC_H	20.05	≤23.98	PASS
Ant1	5580		TPC_L	7.34	≤23.98	PASS
			TPC_H	13.66	≤23.98	PASS
Ant2	5580		TPC_L	7.73	≤23.98	PASS
			TPC_H	13.80	≤23.98	PASS
Ant3	5580		TPC_L	8.48	≤23.98	PASS
			TPC_H	13.87	≤23.98	PASS
Ant4	5580		TPC_L	8.23	≤23.98	PASS
			TPC_H	13.68	≤23.98	PASS
total	5580		TPC_L	13.94	≤23.98	PASS
			TPC_H	19.74	≤23.98	PASS
Ant1	5700		TPC_L	7.97	≤23.98	PASS
			TPC_H	13.74	≤23.98	PASS
Ant2	5700		TPC_L	8.14	≤23.98	PASS
			TPC_H	13.67	≤23.98	PASS
Ant3	5700		TPC_L	8.64	≤23.98	PASS
			TPC_H	13.82	≤23.98	PASS
Ant4	5700		TPC_L	7.77	≤23.98	PASS
			TPC_H	14.06	≤23.98	PASS
total	5700		TPC_L	14.16	≤23.98	PASS
			TPC_H	19.85	≤23.98	PASS
Ant1	5745		NA	18.43	≤30.00	PASS
Ant2	5745		NA	17.94	≤30.00	PASS
Ant3	5745		NA	18.05	≤30.00	PASS
Ant4	5745		NA	18.25	≤30.00	PASS
total	5745		NA	24.19	≤30.00	PASS
Ant1	5785		NA	21.35	≤30.00	PASS
Ant2	5785		NA	21.16	≤30.00	PASS

	Ant3	5785	NA	21.30	≤30.00	PASS
	Ant4	5785	NA	21.25	≤30.00	PASS
	total	5785	NA	27.29	≤30.00	PASS
	Ant1	5825	NA	18.11	≤30.00	PASS
	Ant2	5825	NA	18.06	≤30.00	PASS
	Ant3	5825	NA	18.01	≤30.00	PASS
	Ant4	5825	NA	17.80	≤30.00	PASS
	total	5825	NA	24.02	≤30.00	PASS
11AC40MIMO	Ant1	5190	NA	13.71	≤30.00	PASS
	Ant2	5190	NA	13.59	≤30.00	PASS
	Ant3	5190	NA	13.57	≤30.00	PASS
	Ant4	5190	NA	13.82	≤30.00	PASS
	total	5190	NA	19.69	≤30.00	PASS
	Ant1	5230	NA	20.97	≤30.00	PASS
	Ant2	5230	NA	21.04	≤30.00	PASS
	Ant3	5230	NA	21.13	≤30.00	PASS
	Ant4	5230	NA	21.19	≤30.00	PASS
	total	5230	NA	27.10	≤30.00	PASS
	Ant1	5270	TPC_L	9.55	≤23.98	PASS
			TPC_H	15.34	≤23.98	PASS
	Ant2	5270	TPC_L	9.41	≤23.98	PASS
			TPC_H	15.35	≤23.98	PASS
	Ant3	5270	TPC_L	8.99	≤23.98	PASS
			TPC_H	14.97	≤23.98	PASS
	Ant4	5270	TPC_L	9.20	≤23.98	PASS
			TPC_H	15.09	≤23.98	PASS
	total	5270	TPC_L	15.31	≤23.98	PASS
			TPC_H	21.21	≤23.98	PASS
	Ant1	5310	TPC_L	7.74	≤23.98	PASS
			TPC_H	13.59	≤23.98	PASS
	Ant2	5310	TPC_L	8.00	≤23.98	PASS
			TPC_H	14.07	≤23.98	PASS
	Ant3	5310	TPC_L	7.38	≤23.98	PASS
			TPC_H	13.37	≤23.98	PASS
	Ant4	5310	TPC_L	7.05	≤23.98	PASS
			TPC_H	13.18	≤23.98	PASS
	total	5310	TPC_L	13.58	≤23.98	PASS
			TPC_H	19.59	≤23.98	PASS
	Ant1	5510	TPC_L	7.63	≤23.98	PASS
			TPC_H	13.19	≤23.98	PASS
Ant2	5510	TPC_L	7.04	≤23.98	PASS	
		TPC_H	13.40	≤23.98	PASS	



	Ant3	5510	TPC_L	7.05	≤23.98	PASS
			TPC_H	13.52	≤23.98	PASS
	Ant4	5510	TPC_L	6.83	≤23.98	PASS
			TPC_H	13.61	≤23.98	PASS
	total	5510	TPC_L	13.17	≤23.98	PASS
			TPC_H	19.45	≤23.98	PASS
	Ant1	5550	TPC_L	9.22	≤23.98	PASS
			TPC_H	15.07	≤23.98	PASS
	Ant2	5550	TPC_L	8.77	≤23.98	PASS
			TPC_H	15.15	≤23.98	PASS
	Ant3	5550	TPC_L	9.13	≤23.98	PASS
			TPC_H	14.63	≤23.98	PASS
	Ant4	5550	TPC_L	8.58	≤23.98	PASS
			TPC_H	14.86	≤23.98	PASS
	total	5550	TPC_L	14.95	≤23.98	PASS
			TPC_H	20.95	≤23.98	PASS
	Ant1	5670	TPC_L	9.13	≤23.98	PASS
			TPC_H	15.34	≤23.98	PASS
	Ant2	5670	TPC_L	8.65	≤23.98	PASS
			TPC_H	15.20	≤23.98	PASS
	Ant3	5670	TPC_L	8.83	≤23.98	PASS
			TPC_H	15.14	≤23.98	PASS
	Ant4	5670	TPC_L	9.19	≤23.98	PASS
			TPC_H	15.10	≤23.98	PASS
	total	5670	TPC_L	14.98	≤23.98	PASS
			TPC_H	21.22	≤23.98	PASS
	Ant1	5755	NA	21.09	≤30.00	PASS
	Ant2	5755	NA	21.05	≤30.00	PASS
	Ant3	5755	NA	21.52	≤30.00	PASS
	Ant4	5755	NA	20.96	≤30.00	PASS
	total	5755	NA	27.18	≤30.00	PASS
	Ant1	5795	NA	20.70	≤30.00	PASS
Ant2	5795	NA	21.43	≤30.00	PASS	
Ant3	5795	NA	21.42	≤30.00	PASS	
Ant4	5795	NA	20.96	≤30.00	PASS	
total	5795	NA	27.16	≤30.00	PASS	
11AC80MIMO	Ant1	5210	NA	13.37	≤30.00	PASS
	Ant2	5210	NA	13.23	≤30.00	PASS
	Ant3	5210	NA	13.32	≤30.00	PASS
	Ant4	5210	NA	12.91	≤30.00	PASS
	total	5210	NA	19.23	≤30.00	PASS
	Ant1	5290	TPC_L	7.08	≤23.98	PASS

	Ant2	5290	TPC_H	13.19	≤23.98	PASS
			TPC_L	7.58	≤23.98	PASS
			TPC_H	13.07	≤23.98	PASS
	Ant3	5290	TPC_L	7.59	≤23.98	PASS
			TPC_H	13.33	≤23.98	PASS
	Ant4	5290	TPC_L	7.27	≤23.98	PASS
			TPC_H	13.46	≤23.98	PASS
	total	5290	TPC_L	13.41	≤23.98	PASS
			TPC_H	19.29	≤23.98	PASS
	Ant1	5530	TPC_L	6.74	≤23.98	PASS
			TPC_H	13.07	≤23.98	PASS
	Ant2	5530	TPC_L	6.33	≤23.98	PASS
			TPC_H	13.30	≤23.98	PASS
	Ant3	5530	TPC_L	7.24	≤23.98	PASS
			TPC_H	13.13	≤23.98	PASS
	Ant4	5530	TPC_L	6.39	≤23.98	PASS
			TPC_H	13.03	≤23.98	PASS
	total	5530	TPC_L	12.71	≤23.98	PASS
			TPC_H	19.15	≤23.98	PASS
	Ant1	5610	TPC_L	9.35	≤23.98	PASS
			TPC_H	16.17	≤23.98	PASS
	Ant2	5610	TPC_L	9.19	≤23.98	PASS
			TPC_H	16.22	≤23.98	PASS
	Ant3	5610	TPC_L	9.78	≤23.98	PASS
			TPC_H	16.04	≤23.98	PASS
	Ant4	5610	TPC_L	9.92	≤23.98	PASS
			TPC_H	16.06	≤23.98	PASS
	total	5610	TPC_L	15.59	≤23.98	PASS
			TPC_H	22.14	≤23.98	PASS
	Ant1	5775	NA	21.21	≤30.00	PASS
Ant2	5775	NA	21.16	≤30.00	PASS	
Ant3	5775	NA	21.03	≤30.00	PASS	
Ant4	5775	NA	21.19	≤30.00	PASS	
total	5775	NA	27.17	≤30.00	PASS	
11AC160MIMO	Ant1	5250_UNII-1	TPC_L	4.49	≤30.00	PASS
			TPC_H	10.12	≤30.00	PASS
	Ant2	5250_UNII-1	TPC_L	4.31	≤30.00	PASS
			TPC_H	10.30	≤30.00	PASS
	Ant3	5250_UNII-1	TPC_L	3.72	≤30.00	PASS
			TPC_H	10.06	≤30.00	PASS
Ant4	5250_UNII-1	TPC_L	3.44	≤30.00	PASS	
		TPC_H	10.52	≤30.00	PASS	

	total	5250_UNII-1	TPC_L	10.03	≤30.00	PASS
			TPC_H	16.27	≤30.00	PASS
	Ant1	5250_UNII-2A	TPC_L	3.43	≤23.98	PASS
			TPC_H	9.25	≤23.98	PASS
	Ant2	5250_UNII-2A	TPC_L	3.34	≤23.98	PASS
			TPC_H	9.48	≤23.98	PASS
	Ant3	5250_UNII-2A	TPC_L	2.77	≤23.98	PASS
			TPC_H	9.22	≤23.98	PASS
	Ant4	5250_UNII-2A	TPC_L	2.32	≤23.98	PASS
			TPC_H	9.51	≤23.98	PASS
	total	5250_UNII-2A	TPC_L	9.01	≤23.98	PASS
			TPC_H	15.39	≤23.98	PASS
	Ant1	5570	TPC_L	8.97	≤23.98	PASS
			TPC_H	13.60	≤23.98	PASS
	Ant2	5570	TPC_L	9.03	≤23.98	PASS
			TPC_H	13.91	≤23.98	PASS
	Ant3	5570	TPC_L	9.17	≤23.98	PASS
			TPC_H	14.13	≤23.98	PASS
	Ant4	5570	TPC_L	8.73	≤23.98	PASS
			TPC_H	13.88	≤23.98	PASS
total	5570	TPC_L	15.00	≤23.98	PASS	
		TPC_H	19.90	≤23.98	PASS	
11AX20MIMO	Ant1	5180	NA	14.81	≤30.00	PASS
	Ant2	5180	NA	14.73	≤30.00	PASS
	Ant3	5180	NA	14.58	≤30.00	PASS
	Ant4	5180	NA	14.49	≤30.00	PASS
	total	5180	NA	20.67	≤30.00	PASS
	Ant1	5200	NA	19.76	≤30.00	PASS
	Ant2	5200	NA	19.77	≤30.00	PASS
	Ant3	5200	NA	19.51	≤30.00	PASS
	Ant4	5200	NA	19.80	≤30.00	PASS
	total	5200	NA	25.73	≤30.00	PASS
	Ant1	5240	NA	19.88	≤30.00	PASS
	Ant2	5240	NA	19.38	≤30.00	PASS
	Ant3	5240	NA	19.04	≤30.00	PASS
	Ant4	5240	NA	19.72	≤30.00	PASS
	total	5240	NA	25.54	≤30.00	PASS
	Ant1	5260	TPC_L	8.26	≤23.98	PASS
			TPC_H	13.82	≤23.98	PASS
	Ant2	5260	TPC_L	8.09	≤23.98	PASS
			TPC_H	13.87	≤23.98	PASS
	Ant3	5260	TPC_L	7.94	≤23.98	PASS

			TPC_H	13.71	≤23.98	PASS
	Ant4	5260	TPC_L	7.32	≤23.98	PASS
			TPC_H	13.70	≤23.98	PASS
	total	5260	TPC_L	13.94	≤23.98	PASS
			TPC_H	19.80	≤23.98	PASS
	Ant1	5280	TPC_L	8.35	≤23.98	PASS
			TPC_H	13.48	≤23.98	PASS
	Ant2	5280	TPC_L	8.19	≤23.98	PASS
			TPC_H	13.82	≤23.98	PASS
	Ant3	5280	TPC_L	7.89	≤23.98	PASS
			TPC_H	13.77	≤23.98	PASS
	Ant4	5280	TPC_L	7.32	≤23.98	PASS
			TPC_H	13.71	≤23.98	PASS
	total	5280	TPC_L	13.98	≤23.98	PASS
			TPC_H	19.72	≤23.98	PASS
	Ant1	5320	TPC_L	7.77	≤23.98	PASS
			TPC_H	13.43	≤23.98	PASS
	Ant2	5320	TPC_L	8.19	≤23.98	PASS
			TPC_H	13.69	≤23.98	PASS
	Ant3	5320	TPC_L	7.79	≤23.98	PASS
			TPC_H	13.79	≤23.98	PASS
	Ant4	5320	TPC_L	6.77	≤23.98	PASS
			TPC_H	13.58	≤23.98	PASS
	total	5320	TPC_L	13.68	≤23.98	PASS
			TPC_H	19.65	≤23.98	PASS
	Ant1	5500	TPC_L	8.32	≤23.98	PASS
			TPC_H	13.72	≤23.98	PASS
	Ant2	5500	TPC_L	7.75	≤23.98	PASS
			TPC_H	13.61	≤23.98	PASS
	Ant3	5500	TPC_L	8.36	≤23.98	PASS
			TPC_H	13.56	≤23.98	PASS
	Ant4	5500	TPC_L	7.93	≤23.98	PASS
			TPC_H	13.65	≤23.98	PASS
	total	5500	TPC_L	14.12	≤23.98	PASS
			TPC_H	19.66	≤23.98	PASS
	Ant1	5580	TPC_L	7.01	≤23.98	PASS
			TPC_H	13.52	≤23.98	PASS
	Ant2	5580	TPC_L	7.07	≤23.98	PASS
			TPC_H	13.18	≤23.98	PASS
	Ant3	5580	TPC_L	7.83	≤23.98	PASS
			TPC_H	14.01	≤23.98	PASS
	Ant4	5580	TPC_L	7.48	≤23.98	PASS

			TPC_H	13.35	≤23.98	PASS
	total	5580	TPC_L	13.38	≤23.98	PASS
			TPC_H	19.55	≤23.98	PASS
	Ant1	5700	TPC_L	8.01	≤23.98	PASS
			TPC_H	13.96	≤23.98	PASS
	Ant2	5700	TPC_L	8.36	≤23.98	PASS
			TPC_H	13.31	≤23.98	PASS
	Ant3	5700	TPC_L	8.55	≤23.98	PASS
			TPC_H	13.48	≤23.98	PASS
	Ant4	5700	TPC_L	7.53	≤23.98	PASS
			TPC_H	13.49	≤23.98	PASS
	total	5700	TPC_L	14.15	≤23.98	PASS
			TPC_H	19.59	≤23.98	PASS
	Ant1	5745	NA	18.44	≤30.00	PASS
	Ant2	5745	NA	17.66	≤30.00	PASS
	Ant3	5745	NA	17.70	≤30.00	PASS
	Ant4	5745	NA	17.99	≤30.00	PASS
	total	5745	NA	23.98	≤30.00	PASS
	Ant1	5785	NA	21.09	≤30.00	PASS
	Ant2	5785	NA	21.06	≤30.00	PASS
	Ant3	5785	NA	21.52	≤30.00	PASS
	Ant4	5785	NA	21.32	≤30.00	PASS
	total	5785	NA	27.27	≤30.00	PASS
	Ant1	5825	NA	18.14	≤30.00	PASS
Ant2	5825	NA	17.99	≤30.00	PASS	
Ant3	5825	NA	17.76	≤30.00	PASS	
Ant4	5825	NA	18.18	≤30.00	PASS	
total	5825	NA	24.04	≤30.00	PASS	
11AX40MIMO	Ant1	5190	NA	13.71	≤30.00	PASS
	Ant2	5190	NA	13.93	≤30.00	PASS
	Ant3	5190	NA	13.42	≤30.00	PASS
	Ant4	5190	NA	13.63	≤30.00	PASS
	total	5190	NA	19.70	≤30.00	PASS
	Ant1	5230	NA	21.44	≤30.00	PASS
	Ant2	5230	NA	20.93	≤30.00	PASS
	Ant3	5230	NA	21.61	≤30.00	PASS
	Ant4	5230	NA	21.04	≤30.00	PASS
	total	5230	NA	27.28	≤30.00	PASS
	Ant1	5270	TPC_L	8.80	≤23.98	PASS
			TPC_H	15.05	≤23.98	PASS
	Ant2	5270	TPC_L	8.62	≤23.98	PASS
			TPC_H	14.69	≤23.98	PASS

Ant3	5270	TPC_L	8.28	≤23.98	PASS
		TPC_H	15.15	≤23.98	PASS
Ant4	5270	TPC_L	8.23	≤23.98	PASS
		TPC_H	15.03	≤23.98	PASS
total	5270	TPC_L	14.51	≤23.98	PASS
		TPC_H	21.00	≤23.98	PASS
Ant1	5310	TPC_L	7.88	≤23.98	PASS
		TPC_H	13.66	≤23.98	PASS
Ant2	5310	TPC_L	8.38	≤23.98	PASS
		TPC_H	13.94	≤23.98	PASS
Ant3	5310	TPC_L	7.73	≤23.98	PASS
		TPC_H	13.54	≤23.98	PASS
Ant4	5310	TPC_L	7.52	≤23.98	PASS
		TPC_H	13.42	≤23.98	PASS
total	5310	TPC_L	13.91	≤23.98	PASS
		TPC_H	19.66	≤23.98	PASS
Ant1	5510	TPC_L	8.22	≤23.98	PASS
		TPC_H	13.70	≤23.98	PASS
Ant2	5510	TPC_L	7.70	≤23.98	PASS
		TPC_H	13.53	≤23.98	PASS
Ant3	5510	TPC_L	8.04	≤23.98	PASS
		TPC_H	13.66	≤23.98	PASS
Ant4	5510	TPC_L	7.36	≤23.98	PASS
		TPC_H	13.27	≤23.98	PASS
total	5510	TPC_L	13.86	≤23.98	PASS
		TPC_H	19.56	≤23.98	PASS
Ant1	5550	TPC_L	9.07	≤23.98	PASS
		TPC_H	15.29	≤23.98	PASS
Ant2	5550	TPC_L	8.54	≤23.98	PASS
		TPC_H	14.72	≤23.98	PASS
Ant3	5550	TPC_L	8.95	≤23.98	PASS
		TPC_H	15.16	≤23.98	PASS
Ant4	5550	TPC_L	8.50	≤23.98	PASS
		TPC_H	15.18	≤23.98	PASS
total	5550	TPC_L	14.79	≤23.98	PASS
		TPC_H	21.11	≤23.98	PASS
Ant1	5670	TPC_L	8.93	≤23.98	PASS
		TPC_H	15.33	≤23.98	PASS
Ant2	5670	TPC_L	8.15	≤23.98	PASS
		TPC_H	15.35	≤23.98	PASS
Ant3	5670	TPC_L	8.68	≤23.98	PASS
		TPC_H	15.16	≤23.98	PASS



	Ant4	5670	TPC_L	9.02	≤23.98	PASS
			TPC_H	14.95	≤23.98	PASS
	total	5670	TPC_L	14.73	≤23.98	PASS
			TPC_H	21.22	≤23.98	PASS
	Ant1	5755	NA	21.08	≤30.00	PASS
	Ant2	5755	NA	21.00	≤30.00	PASS
	Ant3	5755	NA	21.43	≤30.00	PASS
	Ant4	5755	NA	21.04	≤30.00	PASS
	total	5755	NA	27.45	≤30.00	PASS
	Ant1	5795	NA	21.14	≤30.00	PASS
	Ant2	5795	NA	21.26	≤30.00	PASS
	Ant3	5795	NA	20.98	≤30.00	PASS
	Ant4	5795	NA	21.06	≤30.00	PASS
	total	5795	NA	27.13	≤30.00	PASS
11AX80MIMO	Ant1	5210	NA	12.77	≤30.00	PASS
	Ant2	5210	NA	12.71	≤30.00	PASS
	Ant3	5210	NA	12.79	≤30.00	PASS
	Ant4	5210	NA	12.63	≤30.00	PASS
	total	5210	NA	18.75	≤30.00	PASS
	Ant1	5290	TPC_L	7.04	≤23.98	PASS
			TPC_H	13.06	≤23.98	PASS
	Ant2	5290	TPC_L	7.51	≤23.98	PASS
			TPC_H	12.60	≤23.98	PASS
	Ant3	5290	TPC_L	7.41	≤23.98	PASS
			TPC_H	12.69	≤23.98	PASS
	Ant4	5290	TPC_L	6.96	≤23.98	PASS
			TPC_H	13.20	≤23.98	PASS
	total	5290	TPC_L	13.26	≤23.98	PASS
			TPC_H	18.92	≤23.98	PASS
	Ant1	5530	TPC_L	6.93	≤23.98	PASS
			TPC_H	12.84	≤23.98	PASS
	Ant2	5530	TPC_L	6.38	≤23.98	PASS
			TPC_H	12.47	≤23.98	PASS
	Ant3	5530	TPC_L	7.43	≤23.98	PASS
			TPC_H	12.37	≤23.98	PASS
	Ant4	5530	TPC_L	6.44	≤23.98	PASS
			TPC_H	12.26	≤23.98	PASS
	total	5530	TPC_L	12.84	≤23.98	PASS
			TPC_H	18.51	≤23.98	PASS
	Ant1	5610	TPC_L	9.52	≤23.98	PASS
			TPC_H	16.40	≤23.98	PASS
	Ant2	5610	TPC_L	9.60	≤23.98	PASS

	Ant3	5610	TPC_H	16.34	≤23.98	PASS
			TPC_L	9.94	≤23.98	PASS
			TPC_H	15.99	≤23.98	PASS
	Ant4	5610	TPC_L	10.28	≤23.98	PASS
			TPC_H	16.33	≤23.98	PASS
	total	5610	TPC_L	15.87	≤23.98	PASS
			TPC_H	22.29	≤23.98	PASS
	Ant1	5775	NA	20.78	≤30.00	PASS
	Ant2	5775	NA	21.23	≤30.00	PASS
	Ant3	5775	NA	20.96	≤30.00	PASS
Ant4	5775	NA	21.34	≤30.00	PASS	
total	5775	NA	27.10	≤30.00	PASS	
11AX160MIMO	Ant1	5250_UNII-1	TPC_L	5.22	≤30.00	PASS
			TPC_H	10.16	≤30.00	PASS
	Ant2	5250_UNII-1	TPC_L	4.63	≤30.00	PASS
			TPC_H	10.73	≤30.00	PASS
	Ant3	5250_UNII-1	TPC_L	3.84	≤30.00	PASS
			TPC_H	10.38	≤30.00	PASS
	Ant4	5250_UNII-1	TPC_L	3.56	≤30.00	PASS
			TPC_H	10.47	≤30.00	PASS
	total	5250_UNII-1	TPC_L	10.35	≤30.00	PASS
			TPC_H	16.44	≤30.00	PASS
	Ant1	5250_UNII-2A	TPC_L	4.46	≤23.98	PASS
			TPC_H	9.51	≤23.98	PASS
	Ant2	5250_UNII-2A	TPC_L	4.49	≤23.98	PASS
			TPC_H	10.00	≤23.98	PASS
	Ant3	5250_UNII-2A	TPC_L	3.80	≤23.98	PASS
			TPC_H	9.41	≤23.98	PASS
	Ant4	5250_UNII-2A	TPC_L	3.24	≤23.98	PASS
			TPC_H	9.36	≤23.98	PASS
	total	5250_UNII-2A	TPC_L	10.01	≤23.98	PASS
			TPC_H	15.57	≤23.98	PASS
	Ant1	5570	TPC_L	7.53	≤23.98	PASS
			TPC_H	13.55	≤23.98	PASS
	Ant2	5570	TPC_L	7.50	≤23.98	PASS
			TPC_H	13.74	≤23.98	PASS
	Ant3	5570	TPC_L	7.73	≤23.98	PASS
			TPC_H	13.68	≤23.98	PASS
	Ant4	5570	TPC_L	6.98	≤23.98	PASS
			TPC_H	13.75	≤23.98	PASS
total	5570	TPC_L	13.51	≤23.98	PASS	
		TPC_H	19.73	≤23.98	PASS	



Note: The Duty Cycle Factor is compensated in the test system  
Correlated chains directional gain= $2.11+1.5=3.61\text{dBi}$

### 3.5 Power Spectral Density

#### 3.5.1 Limit

FCC Part15, Subpart E (15.407)			
Section	Test Item	Limit	Frequency Range (MHz)
15.407(a)	Power Spectral Density	Master device: 17 dBm/MHz Client device: 11 dBm/MHz	5150-5250
		11 dBm/MHz	5250-5350
		11 dBm/MHz	5470-5725
		30 dBm/500 kHz	5725-5850

Note:

- For UNII-3, according to KDB publication 789033 D02 General UNII Test Procedures New Rules v02r01, section II.F.5., it is acceptable to set RBW at 300kHz and VBW at 1500kHz if the spectrum analyzer does not have 500 kHz RBW. Then, add 10 log (500 kHz/300 kHz) to the measured result, i.e. 2.22 dB.
- During the test of U-NII 3 PSD, the measurement result with RBW=300kHz has been added 2.22 dB by compensating offset, offset=cable loss+duty factor+10log(500kHz/300kHz).

#### 3.5.2 Test Procedure

Test Method	
<input checked="" type="radio"/> Conducted Measurement	<input type="radio"/> Radiated Measurement
Test Channels	
<input checked="" type="radio"/> Lowest, Middle and Highest Channel	<input type="radio"/> Lowest and Highest Channel
Environmental conditions	
<input checked="" type="radio"/> Normal	<input type="radio"/> Normal and Extreme
Note: ●:Test    ○:No Test	

a) The EUT was directly connected to the tonscend test system and antenna output port as show in the block diagram below. Spectrum analyser settings as following:

Centre Frequency	The centre frequency of the channel under test
RBW	= 1 MHz (Band1/2/3); = 500kHz (Band4)
VBW	≥3 x RBW
Frequency span	2 x Nominal Channel Bandwidth
Detector Mode	RMS
Trace Mode	Max Hold
Sweep Time	Auto Couple

### 3.5.3 Test Setup

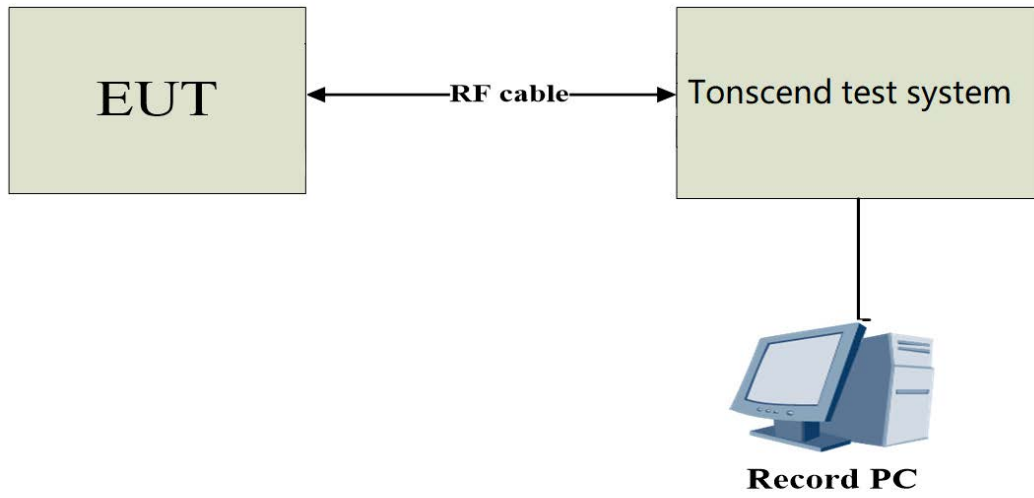

### 3.5.4 The Result

Test Mode	Antenna	Freq(MHz)	Result [dBm/MHz]	Limit[dBm/MHz]	Verdict
11A-CDD	Ant1	5180	4.50	≤17.00	PASS
	Ant2	5180	3.88	≤17.00	PASS
	Ant3	5180	3.18	≤17.00	PASS
	Ant4	5180	4.07	≤17.00	PASS
	total	5180	9.95	≤17.00	PASS
	Ant1	5200	9.43	≤17.00	PASS
	Ant2	5200	8.67	≤17.00	PASS
	Ant3	5200	8.31	≤17.00	PASS
	Ant4	5200	8.45	≤17.00	PASS
	total	5200	14.76	≤17.00	PASS
	Ant1	5240	9.37	≤17.00	PASS
	Ant2	5240	8.11	≤17.00	PASS
	Ant3	5240	8.34	≤17.00	PASS
	Ant4	5240	8.56	≤17.00	PASS
	total	5240	14.64	≤17.00	PASS
	Ant1	5260	3.81	≤11.00	PASS
	Ant2	5260	3.54	≤11.00	PASS
	Ant3	5260	3.86	≤11.00	PASS
	Ant4	5260	3.02	≤11.00	PASS
	total	5260	9.59	≤11.00	PASS
	Ant1	5280	3.88	≤11.00	PASS
	Ant2	5280	4.15	≤11.00	PASS
	Ant3	5280	4.10	≤11.00	PASS
	Ant4	5280	3.34	≤11.00	PASS
	total	5280	9.90	≤11.00	PASS
	Ant1	5320	3.37	≤11.00	PASS
	Ant2	5320	4.10	≤11.00	PASS
	Ant3	5320	3.47	≤11.00	PASS
	Ant4	5320	2.75	≤11.00	PASS
	total	5320	9.47	≤11.00	PASS
	Ant1	5500	3.25	≤11.00	PASS
	Ant2	5500	3.42	≤11.00	PASS
	Ant3	5500	3.50	≤11.00	PASS
	Ant4	5500	3.00	≤11.00	PASS
	total	5500	9.32	≤11.00	PASS
	Ant1	5580	3.54	≤11.00	PASS
	Ant2	5580	4.07	≤11.00	PASS
	Ant3	5580	3.70	≤11.00	PASS
	Ant4	5580	4.10	≤11.00	PASS
	total	5580	9.88	≤11.00	PASS

	Ant1	5700	3.79	≤11.00	PASS
	Ant2	5700	4.13	≤11.00	PASS
	Ant3	5700	3.92	≤11.00	PASS
	Ant4	5700	4.20	≤11.00	PASS
	total	5700	10.03	≤11.00	PASS
	Ant1	5745	5.70	≤30.00	PASS
	Ant2	5745	6.71	≤30.00	PASS
	Ant3	5745	5.41	≤30.00	PASS
	Ant4	5745	5.19	≤30.00	PASS
	total	5745	11.81	≤30.00	PASS
	Ant1	5785	10.02	≤30.00	PASS
	Ant2	5785	8.14	≤30.00	PASS
	Ant3	5785	8.35	≤30.00	PASS
	Ant4	5785	7.81	≤30.00	PASS
	total	5785	14.69	≤30.00	PASS
	Ant1	5825	8.57	≤30.00	PASS
	Ant2	5825	8.15	≤30.00	PASS
	Ant3	5825	7.91	≤30.00	PASS
	Ant4	5825	7.21	≤30.00	PASS
	total	5825	14.01	≤30.00	PASS
11N20MIMO	Ant1	5180	3.23	≤17.00	PASS
	Ant2	5180	3.50	≤17.00	PASS
	Ant3	5180	2.58	≤17.00	PASS
	Ant4	5180	3.36	≤17.00	PASS
	total	5180	9.20	≤17.00	PASS
	Ant1	5200	8.71	≤17.00	PASS
	Ant2	5200	9.23	≤17.00	PASS
	Ant3	5200	8.11	≤17.00	PASS
	Ant4	5200	8.66	≤17.00	PASS
	total	5200	14.72	≤17.00	PASS
	Ant1	5240	8.63	≤17.00	PASS
	Ant2	5240	8.34	≤17.00	PASS
	Ant3	5240	7.87	≤17.00	PASS
	Ant4	5240	7.69	≤17.00	PASS
	total	5240	14.17	≤17.00	PASS
	Ant1	5260	3.84	≤11.00	PASS
	Ant2	5260	3.55	≤11.00	PASS
	Ant3	5260	2.72	≤11.00	PASS
	Ant4	5260	3.31	≤11.00	PASS
	total	5260	9.39	≤11.00	PASS
Ant1	5280	3.40	≤11.00	PASS	
Ant2	5280	3.49	≤11.00	PASS	



	Ant3	5280	3.65	≤11.00	PASS
	Ant4	5280	3.35	≤11.00	PASS
	total	5280	9.49	≤11.00	PASS
	Ant1	5320	3.00	≤11.00	PASS
	Ant2	5320	3.60	≤11.00	PASS
	Ant3	5320	3.07	≤11.00	PASS
	Ant4	5320	1.60	≤11.00	PASS
	total	5320	8.90	≤11.00	PASS
	Ant1	5500	3.00	≤11.00	PASS
	Ant2	5500	2.73	≤11.00	PASS
	Ant3	5500	3.00	≤11.00	PASS
	Ant4	5500	2.85	≤11.00	PASS
	total	5500	8.92	≤11.00	PASS
	Ant1	5580	3.41	≤11.00	PASS
	Ant2	5580	2.62	≤11.00	PASS
	Ant3	5580	3.72	≤11.00	PASS
	Ant4	5580	2.92	≤11.00	PASS
	total	5580	9.21	≤11.00	PASS
	Ant1	5700	3.27	≤11.00	PASS
	Ant2	5700	3.52	≤11.00	PASS
	Ant3	5700	3.93	≤11.00	PASS
	Ant4	5700	3.50	≤11.00	PASS
	total	5700	9.58	≤11.00	PASS
	Ant1	5745	9.21	≤30.00	PASS
	Ant2	5745	8.36	≤30.00	PASS
	Ant3	5745	8.56	≤30.00	PASS
	Ant4	5745	8.51	≤30.00	PASS
	total	5745	14.69	≤30.00	PASS
	Ant1	5785	9.52	≤30.00	PASS
	Ant2	5785	8.48	≤30.00	PASS
	Ant3	5785	7.76	≤30.00	PASS
	Ant4	5785	7.83	≤30.00	PASS
total	5785	14.48	≤30.00	PASS	
Ant1	5825	8.57	≤30.00	PASS	
Ant2	5825	8.51	≤30.00	PASS	
Ant3	5825	7.34	≤30.00	PASS	
Ant4	5825	7.78	≤30.00	PASS	
total	5825	14.10	≤30.00	PASS	
11N40MIMO	Ant1	5190	6.03	≤17.00	PASS
	Ant2	5190	7.01	≤17.00	PASS
	Ant3	5190	6.13	≤17.00	PASS
	Ant4	5190	6.52	≤17.00	PASS

	total	5190	12.46	≤17.00	PASS
	Ant1	5230	6.28	≤17.00	PASS
	Ant2	5230	7.17	≤17.00	PASS
	Ant3	5230	6.95	≤17.00	PASS
	Ant4	5230	7.25	≤17.00	PASS
	total	5230	12.95	≤17.00	PASS
	Ant1	5270	1.09	≤11.00	PASS
	Ant2	5270	1.31	≤11.00	PASS
	Ant3	5270	1.17	≤11.00	PASS
	Ant4	5270	1.22	≤11.00	PASS
	total	5270	7.22	≤11.00	PASS
	Ant1	5310	-1.86	≤11.00	PASS
	Ant2	5310	-1.10	≤11.00	PASS
	Ant3	5310	-1.75	≤11.00	PASS
	Ant4	5310	-1.76	≤11.00	PASS
	total	5310	4.41	≤11.00	PASS
	Ant1	5510	-1.51	≤11.00	PASS
	Ant2	5510	-1.85	≤11.00	PASS
	Ant3	5510	-1.61	≤11.00	PASS
	Ant4	5510	-2.21	≤11.00	PASS
	total	5510	4.23	≤11.00	PASS
	Ant1	5550	1.75	≤11.00	PASS
	Ant2	5550	1.71	≤11.00	PASS
	Ant3	5550	1.98	≤11.00	PASS
	Ant4	5550	1.75	≤11.00	PASS
	total	5550	7.82	≤11.00	PASS
	Ant1	5670	1.61	≤11.00	PASS
	Ant2	5670	1.28	≤11.00	PASS
	Ant3	5670	1.54	≤11.00	PASS
	Ant4	5670	1.70	≤11.00	PASS
	total	5670	6.25	≤11.00	PASS
	Ant1	5755	6.79	≤30.00	PASS
	Ant2	5755	6.42	≤30.00	PASS
	Ant3	5755	6.79	≤30.00	PASS
	Ant4	5755	7.49	≤30.00	PASS
	total	5755	12.91	≤30.00	PASS
	Ant1	5795	6.42	≤30.00	PASS
	Ant2	5795	7.86	≤30.00	PASS
	Ant3	5795	6.03	≤30.00	PASS
	Ant4	5795	6.98	≤30.00	PASS
	total	5795	12.90	≤30.00	PASS
11AC20MIMO	Ant1	5180	3.36	≤17.00	PASS

	Ant2	5180	3.12	≤17.00	PASS
	Ant3	5180	2.48	≤17.00	PASS
	Ant4	5180	2.61	≤17.00	PASS
	total	5180	8.93	≤17.00	PASS
	Ant1	5200	8.42	≤17.00	PASS
	Ant2	5200	8.47	≤17.00	PASS
	Ant3	5200	7.88	≤17.00	PASS
	Ant4	5200	8.30	≤17.00	PASS
	total	5200	14.29	≤17.00	PASS
	Ant1	5240	8.71	≤17.00	PASS
	Ant2	5240	8.50	≤17.00	PASS
	Ant3	5240	8.11	≤17.00	PASS
	Ant4	5240	8.49	≤17.00	PASS
	total	5240	14.48	≤17.00	PASS
	Ant1	5260	3.75	≤11.00	PASS
	Ant2	5260	3.57	≤11.00	PASS
	Ant3	5260	3.73	≤11.00	PASS
	Ant4	5260	3.09	≤11.00	PASS
	total	5260	9.56	≤11.00	PASS
	Ant1	5280	4.38	≤11.00	PASS
	Ant2	5280	4.14	≤11.00	PASS
	Ant3	5280	3.85	≤11.00	PASS
	Ant4	5280	3.38	≤11.00	PASS
	total	5280	9.97	≤11.00	PASS
	Ant1	5320	4.14	≤11.00	PASS
	Ant2	5320	4.37	≤11.00	PASS
	Ant3	5320	4.31	≤11.00	PASS
	Ant4	5320	3.60	≤11.00	PASS
	total	5320	10.14	≤11.00	PASS
	Ant1	5500	3.68	≤11.00	PASS
	Ant2	5500	2.81	≤11.00	PASS
	Ant3	5500	3.07	≤11.00	PASS
	Ant4	5500	3.90	≤11.00	PASS
	total	5500	9.41	≤11.00	PASS
	Ant1	5580	3.50	≤11.00	PASS
	Ant2	5580	2.91	≤11.00	PASS
	Ant3	5580	3.79	≤11.00	PASS
	Ant4	5580	3.69	≤11.00	PASS
	total	5580	9.51	≤11.00	PASS
	Ant1	5700	3.03	≤11.00	PASS
	Ant2	5700	2.96	≤11.00	PASS
	Ant3	5700	3.70	≤11.00	PASS

	Ant4	5700	3.64	≤11.00	PASS
	total	5700	9.37	≤11.00	PASS
	Ant1	5745	7.72	≤30.00	PASS
	Ant2	5745	9.29	≤30.00	PASS
	Ant3	5745	8.70	≤30.00	PASS
	Ant4	5745	8.49	≤30.00	PASS
	total	5745	14.61	≤30.00	PASS
	Ant1	5785	9.67	≤30.00	PASS
	Ant2	5785	8.24	≤30.00	PASS
	Ant3	5785	7.84	≤30.00	PASS
	Ant4	5785	7.93	≤30.00	PASS
	total	5785	14.51	≤30.00	PASS
	Ant1	5825	8.49	≤30.00	PASS
	Ant2	5825	8.26	≤30.00	PASS
	Ant3	5825	8.42	≤30.00	PASS
	Ant4	5825	7.28	≤30.00	PASS
	total	5825	14.16	≤30.00	PASS
	11AC40MIMO	Ant1	5190	0.00	≤17.00
Ant2		5190	0.89	≤17.00	PASS
Ant3		5190	-0.73	≤17.00	PASS
Ant4		5190	-0.09	≤17.00	PASS
total		5190	6.08	≤17.00	PASS
Ant1		5230	5.78	≤17.00	PASS
Ant2		5230	6.67	≤17.00	PASS
Ant3		5230	5.86	≤17.00	PASS
Ant4		5230	6.66	≤17.00	PASS
total		5230	12.28	≤17.00	PASS
Ant1		5270	1.78	≤11.00	PASS
Ant2		5270	1.96	≤11.00	PASS
Ant3		5270	1.61	≤11.00	PASS
Ant4		5270	1.45	≤11.00	PASS
total		5270	7.72	≤11.00	PASS
Ant1		5310	0.94	≤11.00	PASS
Ant2		5310	1.62	≤11.00	PASS
Ant3		5310	0.53	≤11.00	PASS
Ant4		5310	0.61	≤11.00	PASS
total		5310	6.97	≤11.00	PASS
Ant1		5510	0.89	≤11.00	PASS
Ant2		5510	0.59	≤11.00	PASS
Ant3		5510	0.75	≤11.00	PASS
Ant4		5510	0.97	≤11.00	PASS
total		5510	6.82	≤11.00	PASS

	Ant1	5550	2.02	≤11.00	PASS
	Ant2	5550	1.88	≤11.00	PASS
	Ant3	5550	2.32	≤11.00	PASS
	Ant4	5550	2.02	≤11.00	PASS
	total	5550	8.08	≤11.00	PASS
	Ant1	5670	1.89	≤11.00	PASS
	Ant2	5670	1.36	≤11.00	PASS
	Ant3	5670	1.44	≤11.00	PASS
	Ant4	5670	1.52	≤11.00	PASS
	total	5670	7.58	≤11.00	PASS
	Ant1	5755	6.25	≤30.00	PASS
	Ant2	5755	6.15	≤30.00	PASS
	Ant3	5755	7.10	≤30.00	PASS
	Ant4	5755	6.08	≤30.00	PASS
	total	5755	12.44	≤30.00	PASS
	Ant1	5795	5.94	≤30.00	PASS
	Ant2	5795	5.64	≤30.00	PASS
	Ant3	5795	6.08	≤30.00	PASS
	Ant4	5795	5.58	≤30.00	PASS
	total	5795	11.84	≤30.00	PASS
11AC80MIMO	Ant1	5210	-4.16	≤17.00	PASS
	Ant2	5210	-4.24	≤17.00	PASS
	Ant3	5210	-5.08	≤17.00	PASS
	Ant4	5210	-5.12	≤17.00	PASS
	total	5210	1.39	≤17.00	PASS
	Ant1	5290	-4.44	≤11.00	PASS
	Ant2	5290	-3.69	≤11.00	PASS
	Ant3	5290	-3.54	≤11.00	PASS
	Ant4	5290	-4.27	≤11.00	PASS
	total	5290	2.05	≤11.00	PASS
	Ant1	5530	-1.64	≤11.00	PASS
	Ant2	5530	-2.15	≤11.00	PASS
	Ant3	5530	-1.79	≤11.00	PASS
	Ant4	5530	-2.01	≤11.00	PASS
	total	5530	4.13	≤11.00	PASS
	Ant1	5610	-1.91	≤11.00	PASS
	Ant2	5610	-2.33	≤11.00	PASS
	Ant3	5610	-0.99	≤11.00	PASS
	Ant4	5610	-1.80	≤11.00	PASS
	total	5610	4.29	≤11.00	PASS
	Ant1	5775	3.79	≤30.00	PASS
	Ant2	5775	3.53	≤30.00	PASS

	Ant3	5775	3.32	≤30.00	PASS
	Ant4	5775	3.37	≤30.00	PASS
	total	5775	8.32	≤30.00	PASS
11AC160MIMO	Ant1	5250_UNII-1	-6.51	≤17.00	PASS
	Ant2	5250_UNII-1	-6.18	≤17.00	PASS
	Ant3	5250_UNII-1	-6.99	≤17.00	PASS
	Ant4	5250_UNII-1	-8.24	≤17.00	PASS
	total	5250_UNII-1	-0.89	≤17.00	PASS
	Ant1	5250_UNII-2A	-6.37	≤11.00	PASS
	Ant2	5250_UNII-2A	-5.84	≤11.00	PASS
	Ant3	5250_UNII-2A	-7.10	≤11.00	PASS
	Ant4	5250_UNII-2A	-7.54	≤11.00	PASS
	total	5250_UNII-2A	-0.64	≤11.00	PASS
	Ant1	5570	-4.78	≤11.00	PASS
	Ant2	5570	-5.25	≤11.00	PASS
	Ant3	5570	-4.87	≤11.00	PASS
	Ant4	5570	-5.21	≤11.00	PASS
	total	5570	1.00	≤11.00	PASS
11AX20MIMO	Ant1	5180	9.38	≤17.00	PASS
	Ant2	5180	9.45	≤17.00	PASS
	Ant3	5180	8.80	≤17.00	PASS
	Ant4	5180	9.35	≤17.00	PASS
	total	5180	15.27	≤17.00	PASS
	Ant1	5200	9.33	≤17.00	PASS
	Ant2	5200	9.24	≤17.00	PASS
	Ant3	5200	8.44	≤17.00	PASS
	Ant4	5200	8.69	≤17.00	PASS
	total	5200	14.96	≤17.00	PASS
	Ant1	5240	9.79	≤17.00	PASS
	Ant2	5240	9.21	≤17.00	PASS
	Ant3	5240	8.97	≤17.00	PASS
	Ant4	5240	9.54	≤17.00	PASS
	total	5240	15.41	≤17.00	PASS
	Ant1	5260	3.42	≤11.00	PASS
	Ant2	5260	3.30	≤11.00	PASS
	Ant3	5260	3.16	≤11.00	PASS
	Ant4	5260	2.59	≤11.00	PASS
	total	5260	9.15	≤11.00	PASS
	Ant1	5280	2.82	≤11.00	PASS
	Ant2	5280	3.42	≤11.00	PASS
	Ant3	5280	3.16	≤11.00	PASS
	Ant4	5280	2.69	≤11.00	PASS

	total	5280	8.53	≤11.00	PASS
	Ant1	5320	4.26	≤11.00	PASS
	Ant2	5320	4.23	≤11.00	PASS
	Ant3	5320	2.96	≤11.00	PASS
	Ant4	5320	3.46	≤11.00	PASS
	total	5320	7.26	≤11.00	PASS
	Ant1	5500	3.41	≤11.00	PASS
	Ant2	5500	3.13	≤11.00	PASS
	Ant3	5500	3.39	≤11.00	PASS
	Ant4	5500	3.45	≤11.00	PASS
	total	5500	9.37	≤11.00	PASS
	Ant1	5580	3.53	≤11.00	PASS
	Ant2	5580	2.85	≤11.00	PASS
	Ant3	5580	3.84	≤11.00	PASS
	Ant4	5580	3.24	≤11.00	PASS
	total	5580	9.40	≤11.00	PASS
	Ant1	5700	2.82	≤11.00	PASS
	Ant2	5700	3.15	≤11.00	PASS
	Ant3	5700	3.41	≤11.00	PASS
	Ant4	5700	3.35	≤11.00	PASS
	total	5700	9.21	≤11.00	PASS
	Ant1	5745	8.62	≤30.00	PASS
	Ant2	5745	7.82	≤30.00	PASS
	Ant3	5745	7.92	≤30.00	PASS
	Ant4	5745	8.08	≤30.00	PASS
	total	5745	14.14	≤30.00	PASS
	Ant1	5785	8.44	≤30.00	PASS
	Ant2	5785	7.36	≤30.00	PASS
	Ant3	5785	7.09	≤30.00	PASS
	Ant4	5785	6.84	≤30.00	PASS
	total	5785	13.50	≤30.00	PASS
	Ant1	5825	7.77	≤30.00	PASS
	Ant2	5825	8.09	≤30.00	PASS
	Ant3	5825	7.26	≤30.00	PASS
	Ant4	5825	6.85	≤30.00	PASS
	total	5825	13.54	≤30.00	PASS
11AX40MIMO	Ant1	5190	5.10	≤17.00	PASS
	Ant2	5190	5.93	≤17.00	PASS
	Ant3	5190	5.04	≤17.00	PASS
	Ant4	5190	6.07	≤17.00	PASS
	total	5190	11.58	≤17.00	PASS
	Ant1	5230	5.40	≤17.00	PASS



	Ant2	5230	6.06	≤17.00	PASS
	Ant3	5230	5.72	≤17.00	PASS
	Ant4	5230	6.15	≤17.00	PASS
	total	5230	11.86	≤17.00	PASS
	Ant1	5270	-9.34	≤11.00	PASS
	Ant2	5270	-9.39	≤11.00	PASS
	Ant3	5270	-9.72	≤11.00	PASS
	Ant4	5270	-9.85	≤11.00	PASS
	total	5270	-3.55	≤11.00	PASS
	Ant1	5310	-12.92	≤11.00	PASS
	Ant2	5310	-12.53	≤11.00	PASS
	Ant3	5310	-13.04	≤11.00	PASS
	Ant4	5310	-13.35	≤11.00	PASS
	total	5310	-6.93	≤11.00	PASS
	Ant1	5510	-12.93	≤11.00	PASS
	Ant2	5510	-13.40	≤11.00	PASS
	Ant3	5510	-12.75	≤11.00	PASS
	Ant4	5510	-13.30	≤11.00	PASS
	total	5510	-7.07	≤11.00	PASS
	Ant1	5550	0.80	≤11.00	PASS
	Ant2	5550	0.17	≤11.00	PASS
	Ant3	5550	0.97	≤11.00	PASS
	Ant4	5550	0.80	≤11.00	PASS
	total	5550	6.72	≤11.00	PASS
	Ant1	5670	0.69	≤11.00	PASS
	Ant2	5670	0.83	≤11.00	PASS
	Ant3	5670	1.36	≤11.00	PASS
	Ant4	5670	0.48	≤11.00	PASS
	total	5670	6.87	≤11.00	PASS
	Ant1	5755	4.96	≤30.00	PASS
	Ant2	5755	5.84	≤30.00	PASS
	Ant3	5755	6.13	≤30.00	PASS
	Ant4	5755	5.57	≤30.00	PASS
	total	5755	11.67	≤30.00	PASS
	Ant1	5795	5.23	≤30.00	PASS
	Ant2	5795	5.52	≤30.00	PASS
	Ant3	5795	5.43	≤30.00	PASS
	Ant4	5795	4.69	≤30.00	PASS
	total	5795	11.25	≤30.00	PASS
11AX80MIMO	Ant1	5210	-15.11	≤17.00	PASS
	Ant2	5210	-15.26	≤17.00	PASS
	Ant3	5210	-15.73	≤17.00	PASS

	Ant4	5210	-16.45	≤17.00	PASS
	total	5210	-9.59	≤17.00	PASS
	Ant1	5290	-1.80	≤11.00	PASS
	Ant2	5290	-1.02	≤11.00	PASS
	Ant3	5290	-1.61	≤11.00	PASS
	Ant4	5290	-1.60	≤11.00	PASS
	total	5290	4.52	≤11.00	PASS
	Ant1	5530	-2.18	≤11.00	PASS
	Ant2	5530	-2.22	≤11.00	PASS
	Ant3	5530	-1.86	≤11.00	PASS
	Ant4	5530	-1.45	≤11.00	PASS
	total	5530	4.10	≤11.00	PASS
	Ant1	5610	-2.09	≤11.00	PASS
	Ant2	5610	-2.21	≤11.00	PASS
	Ant3	5610	-2.33	≤11.00	PASS
	Ant4	5610	-2.14	≤11.00	PASS
	total	5610	2.56	≤11.00	PASS
	Ant1	5775	1.98	≤30.00	PASS
	Ant2	5775	1.80	≤30.00	PASS
	Ant3	5775	2.95	≤30.00	PASS
Ant4	5775	2.26	≤30.00	PASS	
total	5775	7.04	≤27.06	PASS	
11AX160MIMO	Ant1	5250_UNII-1	-18.96	≤17.00	PASS
	Ant2	5250_UNII-1	-19.48	≤17.00	PASS
	Ant3	5250_UNII-1	-20.19	≤17.00	PASS
	Ant4	5250_UNII-1	-20.32	≤17.00	PASS
	total	5250_UNII-1	-13.68	≤17.00	PASS
	Ant1	5250_UNII-2A	-19.06	≤11.00	PASS
	Ant2	5250_UNII-2A	-19.25	≤11.00	PASS
	Ant3	5250_UNII-2A	-19.91	≤11.00	PASS
	Ant4	5250_UNII-2A	-19.97	≤11.00	PASS
	total	5250_UNII-2A	-13.51	≤11.00	PASS
	Ant1	5570	-18.14	≤11.00	PASS
	Ant2	5570	-18.20	≤11.00	PASS
	Ant3	5570	-17.85	≤11.00	PASS
	Ant4	5570	-18.83	≤11.00	PASS
	total	5570	-12.22	≤11.00	PASS

Note: The Duty Cycle Factor is compensated in the test system

Unequal antenna gains, with equal transmit powers. For antenna gains given by  $G_1, G_2, \dots, G_N$  dBi  
 If transmit signals are correlated, then Directional gain =  $10 \log\left[\frac{(10^{G_1 \theta / 20} + 10^{G_2 \theta / 20} + \dots + 10^{G_N \theta / 20})^2}{N_{ANT}}\right]$  dBi [Note the “20”s in the denominator of each exponent and the square of the sum of terms; the object is to combine the signal levels coherently.]  
 Directional gain = 2.11dBi

For UNII-3, according to KDB publication 789033 D02 General UNII Test Procedures New Rules v02r01, section II.F.5., it is acceptable to set RBW at 300kHz and VBW at 1500kHz if the spectrum analyzer does not have 500 kHz RBW. Then, add  $10 \log(500 \text{ kHz}/300 \text{ kHz})$  to the measured result, i.e. 2.22 dB.

During the test of U-NII 3 PSD, the measurement result with RBW=300kHz has been added 2.22 dB by compensating offset, offset=cable loss+duty factor+ $10\log(500\text{kHz}/300\text{kHz})$ .

Pre-scan TPC\_H PSD and TPC\_L PSD, worst case for TPC\_H PSD was recorded.

Beamforming conducted power less than no beamforming conducted power, so only no beamforming conducted power spectral density was recorded.

11A-CDD\_Ant1\_5180

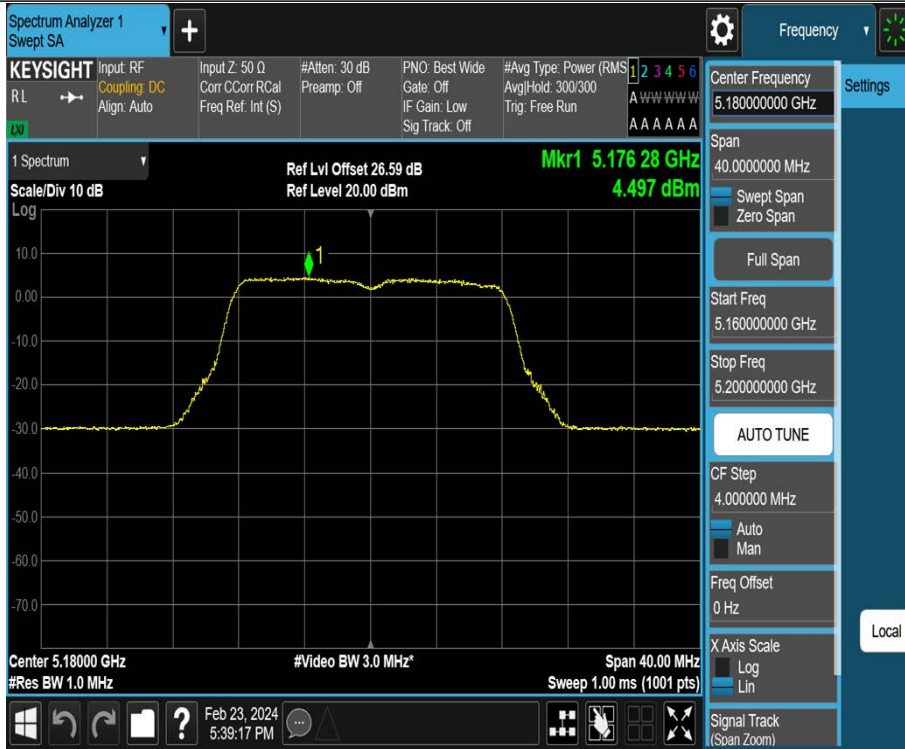

11A-CDD\_Ant2\_5180



11A-CDD\_Ant3\_5180



11A-CDD\_Ant4\_5180

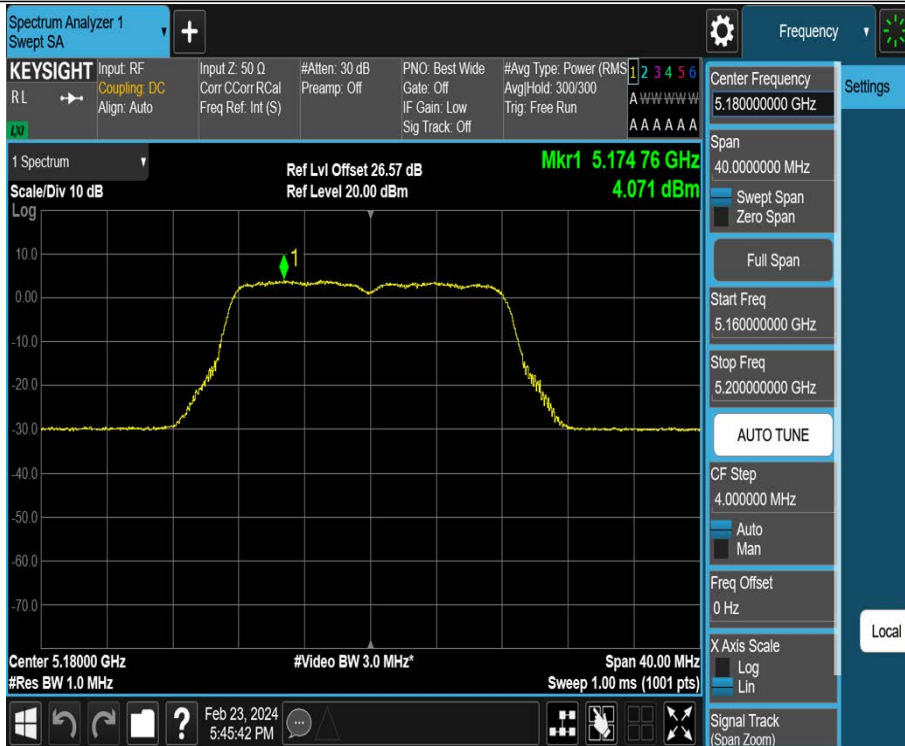

11A-CDD\_Ant1\_5200

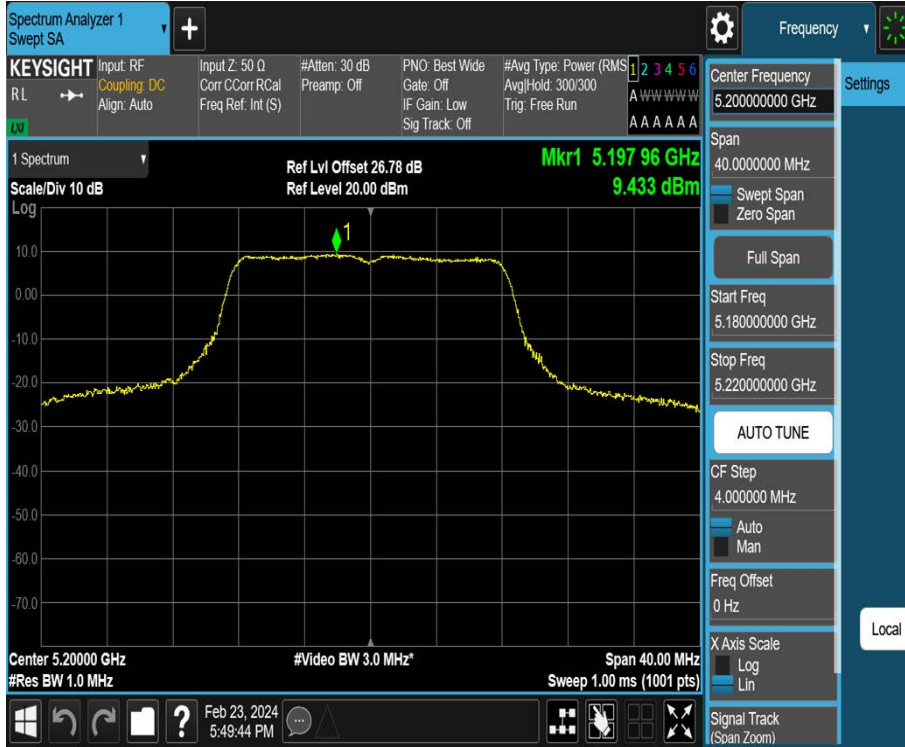

11A-CDD\_Ant2\_5200





11A-CDD\_Ant3\_5200



11A-CDD\_Ant4\_5200

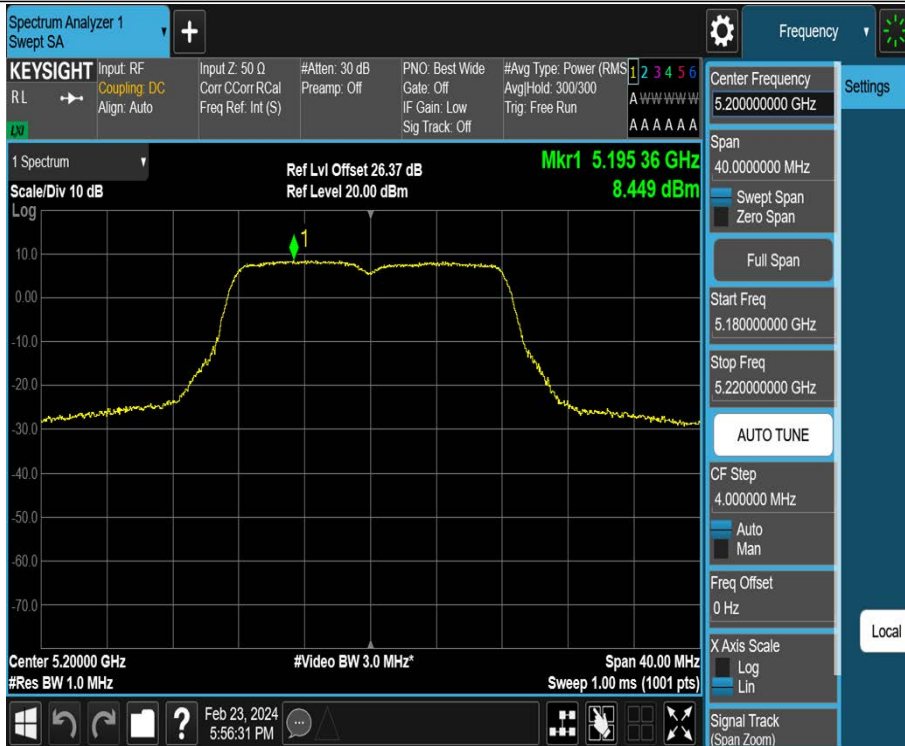



11A-CDD\_Ant1\_5240



11A-CDD\_Ant2\_5240



11A-CDD\_Ant3\_5240



11A-CDD\_Ant4\_5240



11A-CDD\_Ant1\_5260

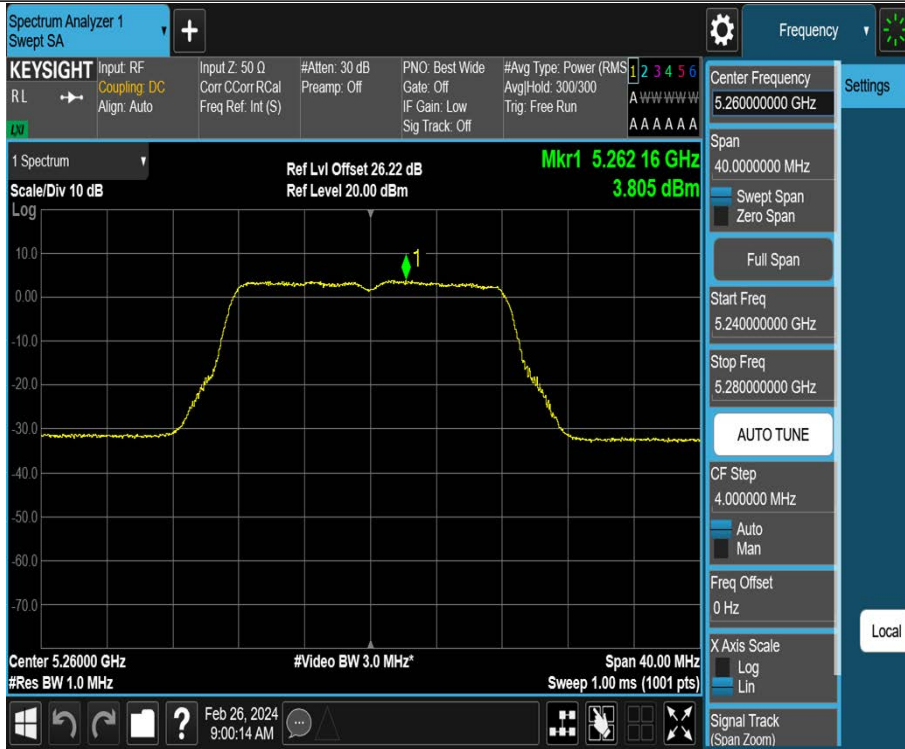

11A-CDD\_Ant2\_5260



11A-CDD\_Ant3\_5260



11A-CDD\_Ant4\_5260



11A-CDD\_Ant1\_5280

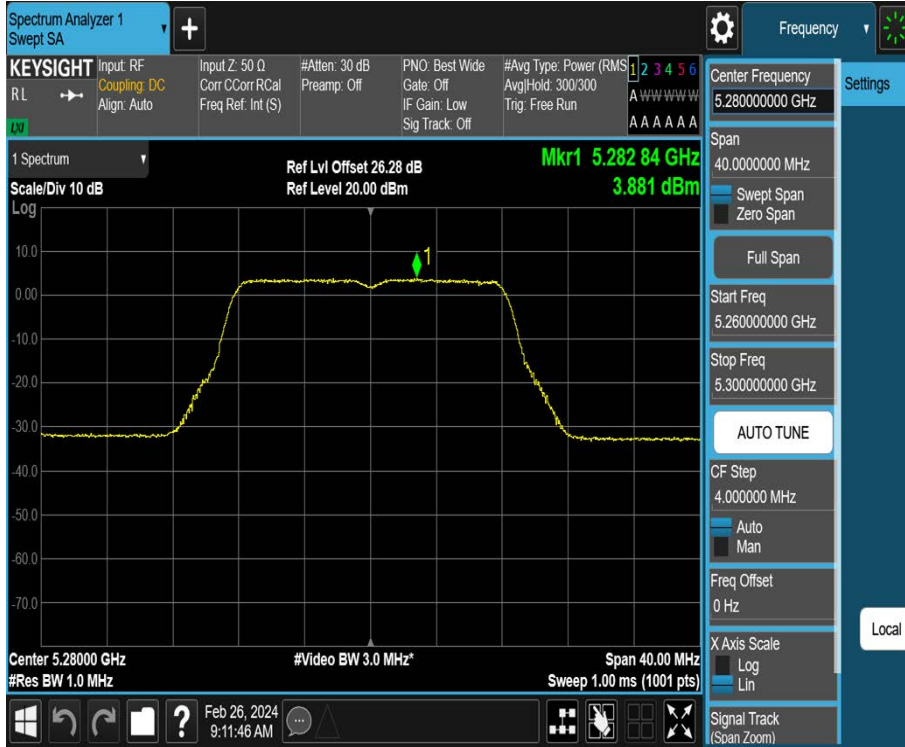

11A-CDD\_Ant2\_5280





11A-CDD\_Ant3\_5280



11A-CDD\_Ant4\_5280



11A-CDD\_Ant1\_5320



11A-CDD\_Ant2\_5320





11A-CDD\_Ant3\_5320



11A-CDD\_Ant4\_5320



11A-CDD\_Ant1\_5500



11A-CDD\_Ant2\_5500



11A-CDD\_Ant3\_5500

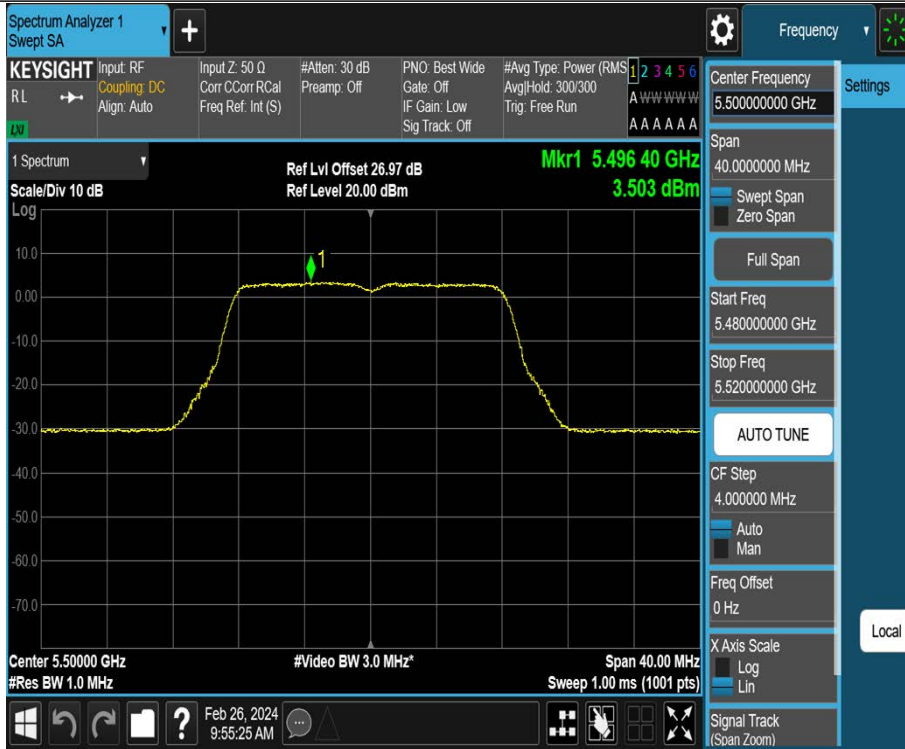

11A-CDD\_Ant4\_5500



11A-CDD\_Ant1\_5580

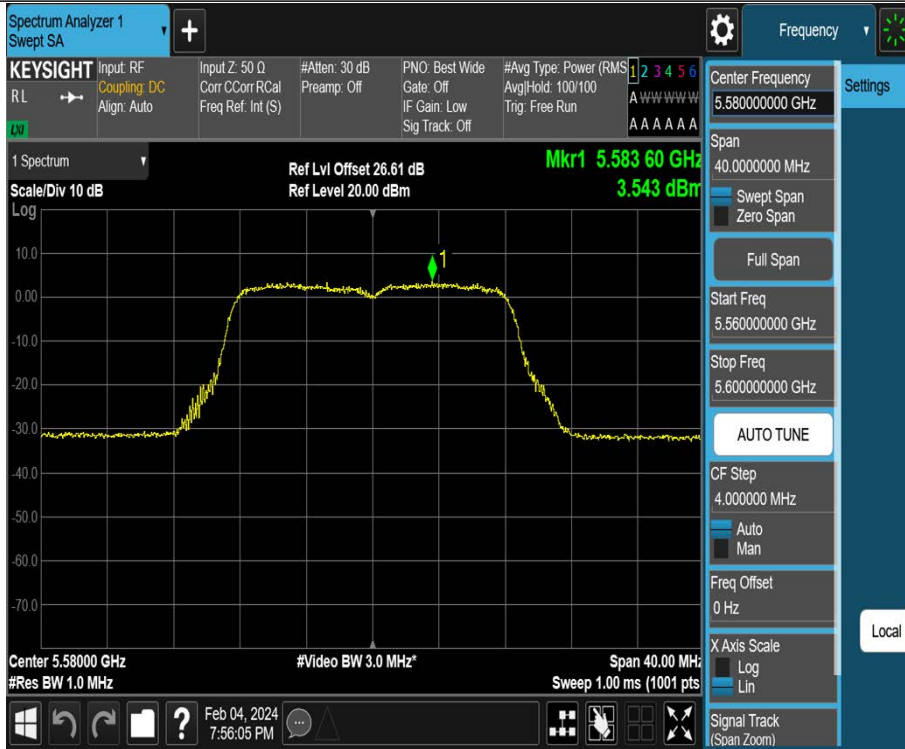

11A-CDD\_Ant2\_5580



11A-CDD\_Ant3\_5580



11A-CDD\_Ant4\_5580

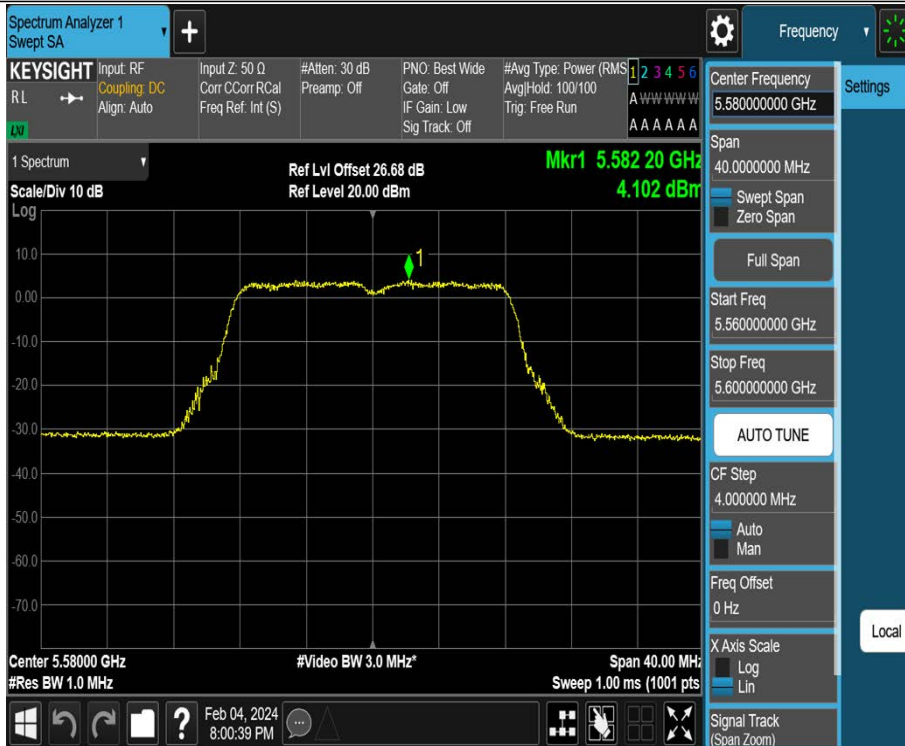



11A-CDD\_Ant1\_5700

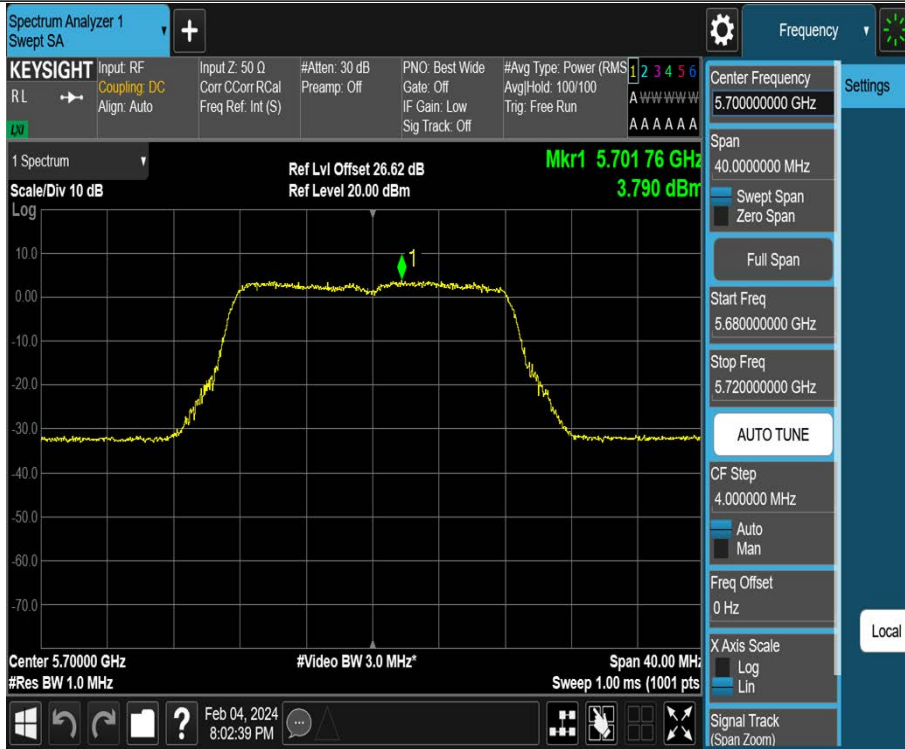

11A-CDD\_Ant2\_5700

