

RF Test Report

FCC ID: 2BCFY-HT580

Test Report No.....: RF240130006-01-005
 Product(s) Name.....: XGSPON Gateway
 Model(s).....: HT-580AXT, HT-580AET
 Trade Mark.....: HEIGHTS
 Applicant.....: Heights Telecom T LTD
 Address.....: Ha-Sakhlav 6, Irus, 7680900, Israel
 Receipt Date.....: 2024.02.01
 Test Date.....: 2024.02.02~2024.03.19
 Issued Date.....: 2024.03.22
 Standards.....: 47 CFR FCC Part 15, Subpart C(Section 15.247)
 ANSI C63.10:2013
 Testing Laboratory.....: Shenzhen Haiyun Standard Technical Co., Ltd.

Prepared By:	Checked By:	Approved By:	
Black Ding	Tim Zhang	Misue Su	
<i>Black Ding</i>	<i>Tim.zhang</i>	<i>Misue Su</i>	

Table of Contents

REPORT ISSUED HISTORY	4
1 . SUMMARY OF TEST RESULTS	5
1.1 TEST FACILITY	6
1.2 MEASUREMENT UNCERTAINTY	6
1.3 TEST ENVIRONMENT CONDITIONS	6
2 . GENERAL INFORMATION	7
2.1 GENERAL DESCRIPTION OF EUT	7
2.2 DESCRIPTION OF TEST MODES	8
2.3 PARAMETERS OF TEST SOFTWARE	9
2.4 SUPPORT UNITS	9
3 . AC POWER LINE CONDUCTED EMISSIONS	10
3.1 LIMIT	10
3.2 TEST PROCEDURE	10
3.3 DEVIATION FROM TEST STANDARD	10
3.4 TEST SETUP	11
3.5 EUT OPERATING CONDITIONS	11
3.6 TEST RESULTS	11
4 . RADIATED EMISSIONS	12
4.1 LIMIT	12
4.2 TEST PROCEDURE	13
4.3 DEVIATION FROM TEST STANDARD	14
4.4 TEST SETUP	14
4.5 EUT OPERATING CONDITIONS	15
4.6 TEST RESULT - 9 KHZ TO 30 MHZ	15
4.7 TEST RESULT - 30 MHZ TO 1000 MHZ	15
4.8 TEST RESULT - ABOVE 1000 MHZ	15
5 . BANDWIDTH	16
5.1 LIMIT	16
5.2 TEST PROCEDURE	16
5.3 DEVIATION FROM STANDARD	16
5.4 TEST SETUP	16
5.5 EUT OPERATION CONDITIONS	16
5.6 TEST RESULTS	16
6 . MAXIMUM OUTPUT POWER	17
6.1 LIMIT	17

6.2 TEST PROCEDURE	17
6.3 DEVIATION FROM STANDARD	17
6.4 TEST SETUP	17
6.5 EUT OPERATION CONDITIONS	17
6.6 TEST RESULTS	17
7 . CONDUCTED SPURIOUS EMISSION	18
7.1 LIMIT	18
7.2 TEST PROCEDURE	18
7.3 DEVIATION FROM STANDARD	18
7.4 TEST SETUP	18
7.5 EUT OPERATION CONDITIONS	18
7.6 TEST RESULTS	18
8 . POWER SPECTRAL DENSITY	19
8.1 LIMIT	19
8.2 TEST PROCEDURE	19
8.3 DEVIATION FROM STANDARD	19
8.4 TEST SETUP	19
8.5 EUT OPERATION CONDITIONS	19
8.6 TEST RESULTS	19
9 . MEASUREMENT INSTRUMENTS LIST	20
10 . ANTENNA REQUIREMENT	21
APPENDIX A - AC POWER LINE CONDUCTED EMISSIONS	22
APPENDIX B - RADIATED EMISSION - 9 KHZ TO 30 MHZ	27
APPENDIX C - RADIATED EMISSION - 30 MHZ TO 1000 MHZ	28
APPENDIX D - RADIATED EMISSION - ABOVE 1000 MHZ	33
APPENDIX E - BANDWIDTH	44
APPENDIX F - MAXIMUM OUTPUT POWER	53
APPENDIX G - CONDUCTED SPURIOUS EMISSION	58
APPENDIX H - POWER SPECTRAL DENSITY	70

REPORT ISSUED HISTORY

Original Report Issue Date: 2024.03.22

- No additional attachment
- Additional attachments were issued following record

Attachment No.	Issue Date	Description

1.. SUMMARY OF TEST RESULTS

Test procedures according to the technical standard(s):

FCC CFR Title 47, Part 15, Subpart C				
Standard(s) Section	Test Item	Test Result	Judgment	Remark
15.207	AC Power Line Conducted Emissions	APPENDIX A	PASS	-----
15.247(d) 15.205(a) 15.209(a)	Radiated Emissions	APPENDIX B APPENDIX C APPENDIX D	PASS	-----
15.247(a)(2)	Bandwidth	APPENDIX E	PASS	-----
15.247(b)(3)	Maximum Output Power	APPENDIX F	PASS	-----
15.247(d)	Conducted Spurious Emission	APPENDIX G	PASS	-----
15.247(e)	Power Spectral Density	APPENDIX H	PASS	-----
15.203	Antenna Requirement	-----	PASS	Note(2)

Note:

- (1) "N/A" denotes test is not applicable to this device.
- (2) The device what use a permanently attached antenna were considered sufficient to comply with the provisions of 15.203.

1.1. TEST FACILITY

Company:	Shenzhen Haiyun Standard Technical CO., Ltd.
Address:	No. 110-113, 115, 116, Block B, Jinyuan Business Building, Bao'an District, Shenzhen, China
CNAS Registration Number:	CNAS L18252
CAB identifier	CN0145
A2LA Certificate Number	6823.01
Telephone:	0755-26024411

1.2. MEASUREMENT UNCERTAINTY

ISO/IEC 17025 requires that an estimate of the measurement uncertainties associated with the emissions test results be included in the report. The measurement uncertainties given below are based on a 95% confidence level (based on a coverage factor (k=2))

Uncertainty	
Parameter	Uncertainty
Occupied Channel Bandwidth	±143.88kHz
Power Spectral Density	±0.743dB
Conducted Spurious Emission	±1.328dB
RF power conducted	±0.384dB
Conducted emission(9kHz~30MHz) AC main	±2.72dB
Radiated emission(9kHz~30MHz)	±2.66dB
Radiated emission (30MHz~1GHz)	±4.62dB
Radiated emission (1GHz~18GHz)	±4.86dB
Radiated emission (18GHz~40GHz)	±3.80dB

Note: Unless specifically mentioned, the uncertainty of measurement has not been taken into account to declare the compliance or non-compliance to the specification.

1.3. TEST ENVIRONMENT CONDITIONS

Test Item	Temperature	Humidity	Test Voltage	Tested By
AC Power Line Conducted Emissions	25°C	52%	AC 120V/60Hz	Albert Fan
Radiated Emissions-9 kHz to 30 MHz	24.2°C	53%	AC 120V/60Hz	Albert Fan
Radiated Emissions-30 MHz to 1000 MHz	24.2°C	53%	AC 120V/60Hz	Albert Fan
Radiated Emissions-Above 1000 MHz	24.2°C	53%	AC 120V/60Hz	Albert Fan
Bandwidth	24.5°C	54%	DC 12V	Henry Huang
Maximum Output Power	24.5°C	54%	DC 12V	Henry Huang
Conducted Spurious Emission	24.5°C	54%	DC 12V	Henry Huang
Power Spectral Density	24.5°C	54%	DC 12V	Henry Huang

Note: Adapter supply voltage AC 120V/60Hz.

2.. GENERAL INFORMATION

2.1. GENERAL DESCRIPTION OF EUT

Product No.	POC240130006-S001, POC240130006-S002
Product Name	XGSPON Gateway
Model Name	HT-580AXT, HT-580AET
Model difference	Only WAN port and optical fiber port part of the circuit is different
Trade Mark	HEIGHTS
Power Supply	DC 12V from adapter
Adapter Information	Model: SOY-1200350US-056 Input: 100-240V~ 50/60Hz 1.2A Max Output: 12V $\overline{=}$ 3.5A
Operation Frequency	2402 MHz ~ 2480 MHz
Modulation Type	GFSK
Bit Rate of Transmitter	1Mbps, 2Mbps
Max. Output Power	1.77 dBm (0.0015W)
Antenna gain	3.60dBi
Antenna type	PCB antenna

Note:

1. For a more detailed features description, please refer to the manufacturer's specifications or the user's manual.

2. Channel List:

Channel	Frequency (MHz)	Channel	Frequency (MHz)
00	2402	20	2442
01	2404	21	2444
02	2406	22	2446
03	2408	23	2448
04	2410	24	2450
05	2412	25	2452
06	2414	26	2454
07	2416	27	2456
08	2418	28	2458
09	2420	29	2460
10	2422	30	2462
11	2424	31	2464
12	2426	32	2466
13	2428	33	2468
14	2430	34	2470
15	2432	35	2472
16	2434	36	2474
17	2436	37	2476
18	2438	38	2478
19	2440	39	2480

2.2. DESCRIPTION OF TEST MODES

The test system was pre-tested based on the consideration of all possible combinations of EUT operation mode.

Pretest Mode	Description
Mode 1	TX Mode_1Mbps Channel 00/19/39
Mode 2	TX Mode_2Mbps Channel 00/19/39
Mode 3	TX Mode_1Mbps Channel 00

Following mode(s) was (were) found to be the worst case(s) and selected for the final test.

AC power line conducted emissions test	
Final Test Mode	Description
Mode 3	TX Mode_1Mbps Channel 00

Radiated emissions test – Below 1GHz	
Final Test Mode	Description
Mode 3	TX Mode_1Mbps Channel 00

Radiated emissions test – Above 1GHz	
Final Test Mode	Description
Mode 1	TX Mode_1Mbps Channel 00/19/39

Conducted test	
Final Test Mode	Description
Mode 1	TX Mode_1Mbps Channel 00/19/39
Mode 2	TX Mode_2Mbps Channel 00/19/39

Note:

- (1) For radiated emission above 1 GHz test, the spurious points of 1GHz~18GHz and 18GHz~26.5GHz have been pre-tested and in this report only recorded the worst case. The remaining spurious points are all below the limit value of 20dB.
- (2) For AC power line conducted emissions and radiated emissions below 1 GHz test, the TX Mode_1Mbps Channel 00 is found to be the worst case and recorded.

2.3. PARAMETERS OF TEST SOFTWARE

During testing channel & power controlling software provided by the customer was used to control the operating channel as well as the output power level.

Test Software Version	cmd.exe		
Frequency (MHz)	2402	2440	2480
1Mbps	default	default	default
2Mbps	default	default	default

2.4. SUPPORT UNITS

None

3.. AC POWER LINE CONDUCTED EMISSIONS

3.1. LIMIT

Frequency of Emission (MHz)	Limit (dB μ V)	
	Quasi-peak	Average
0.15 - 0.5	66 to 56*	56 to 46*
0.5 - 5.0	56	46
5.0 - 30.0	60	50

Note:

- (1) The tighter limit applies at the band edges.
- (2) The limit of " * " marked band means the limitation decreases linearly with the logarithm of the frequency in the range.

3.2. TEST PROCEDURE

- a. The EUT was placed 0.8 meters from the horizontal ground plane with EUT being connected to the power mains through a line impedance stabilization network (LISN). All other support equipment powered from additional LISN(s). The LISN provide 50 Ohm/ 50uH of coupling impedance for the measuring instrument.
- b. Interconnecting cables that hang closer than 40 cm to the ground plane shall be folded back and forth in the center forming a bundle 30 to 40 cm long.
- c. I/O cables that are not connected to a peripheral shall be bundled in the center. The end of the cable may be terminated, if required, using the correct terminating impedance. The overall length shall not exceed 1 m.
- d. LISN at least 80 cm from nearest part of EUT chassis.
- e. For the actual test configuration, please refer to the related Item –EUT Test Photos.

The following table is the setting of the receiver:

Receiver Parameters	Setting
Start Frequency	0.15 MHz
Stop Frequency	30 MHz
IF Bandwidth	9 kHz

3.3. DEVIATION FROM TEST STANDARD

No deviation.

3.4. TEST SETUP

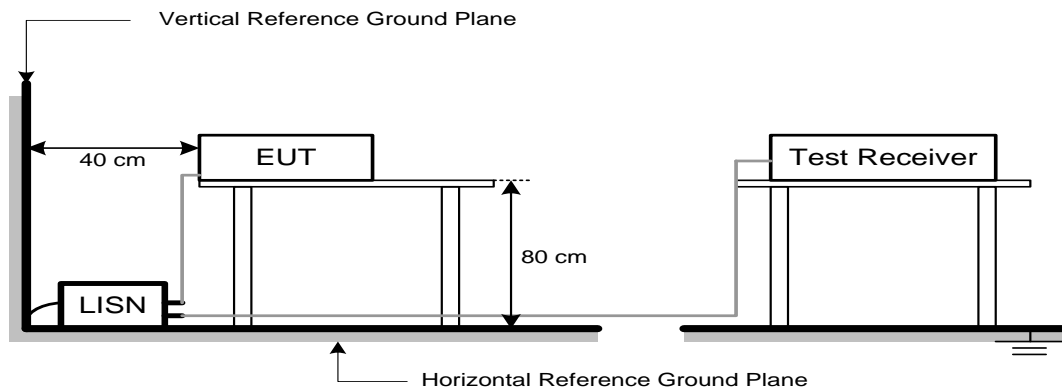

3.5. EUT OPERATING CONDITIONS

The EUT was configured for testing in a typical fashion (as a customer would normally use it). The EUT has been programmed to continuously transmit during test. This operating condition was tested and used to collect the included data.

3.6. TEST RESULTS

Please refer to the APPENDIX A.

Remark:

- (1) All readings are QP Mode value unless otherwise stated AVG in column of 『Note』 . If the QP Mode Measured value compliance with the QP Limits and lower than AVG Limits, the EUT shall be deemed to meet both QP & AVG Limits and then only QP Mode was measured, but AVG Mode didn't perform. In this case, a “*” marked in AVG Mode column of Interference Voltage Measured.
- (2) Measuring frequency range from 150 kHz to 30 MHz.

4.. RADIATED EMISSIONS

4.1. LIMIT

In case the emission fall within the restricted band specified on 15.205(a), then the 15.209(a) limit in the table below has to be followed.

LIMITS OF RADIATED EMISSION MEASUREMENT (9 kHz-1000 MHz)

Frequency (MHz)	Field Strength (microvolts/meter)	Measurement Distance (meters)
0.009-0.490	2400/F(kHz)	300
0.490-1.705	24000/F(kHz)	30
1.705-30.0	30	30
30-88	100	3
88-216	150	3
216-960	200	3
Above 960	500	3

LIMITS OF RADIATED EMISSION MEASUREMENT (Above 1000 MHz)

Frequency (MHz)	(dBuV/m at 3 m)	
	Peak	Average
Above 1000	74	54

Note:

- (1) The limit for radiated test was performed according to FCC CFR Title 47, Part 15, Subpart C.
- (2) The tighter limit applies at the band edges.
- (3) Emission level (dBuV/m)=20log Emission level (uV/m).

4.2. TEST PROCEDURE

- a. The measuring distance of 3 m shall be used for measurements. The EUT was placed on the top of a rotating table 0.8 meter above the ground at a 3 meter semi-anechoic chamber. The table was rotated 360 degrees to determine the position of the highest radiation.(below 1 GHz)
- b. The measuring distance of 3 m shall be used for measurements. The EUT was placed on the top of a rotating table 1.5 meter above the ground at a 3 meter semi-anechoic chamber. The table was rotated 360 degrees to determine the position of the highest radiation.(above 1 GHz)
- c. The height of the equipment or of the substitution antenna shall be 0.8m or 1.5m; the height of the test antenna shall vary between 1 m to 4 m. Both horizontal and vertical polarizations of the antenna are set to make the measurement.
- d. For each suspected emission, the EUT was arranged to its worst case and then the antenna was tuned to heights find the maximum reading (used Bore sight function).
- e. The receiver system was set to peak and average detect function and specified bandwidth with maximum hold mode when the test frequency is above 1 GHz.
- f. The initial step in collecting radiated emission data is a receiver peak detector mode pre-scanning the measurement frequency range. Significant peaks are then marked and then Quasi Peak detector mode re-measured.
- g. All readings are Peak unless otherwise stated QP in column of Note. Peak denotes that the Peak reading compliance with the QP Limits and then QP Mode measurement didn't perform. (below 1 GHz)
- h. All readings are Peak Mode value unless otherwise stated AVG in column of Note. If the Peak Mode Measured value compliance with the Peak Limits and lower than AVG Limits, the EUT shall be deemed to meet both Peak & AVG Limits and then only Peak Mode was measured, but AVG Mode didn't perform. (above 1 GHz)
- i. For the actual test configuration, please refer to the related Item –EUT Test Photos.

The following table is the setting of the receiver:

Spectrum Parameters	Setting
Start ~ Stop Frequency	9 kHz~150 kHz for RBW 200 Hz
Start ~ Stop Frequency	0.15 MHz~30 MHz for RBW 9 kHz
Start ~ Stop Frequency	30 MHz~1000 MHz for RBW 100 kHz

Spectrum Parameters	Setting
Start Frequency	1000 MHz
Stop Frequency	10th carrier harmonic
RBW / VBW (Emission in restricted band)	1 MHz / 3 MHz for PK value 1 MHz / 1/T Hz for AVG value

Spectrum Parameters	Setting
Start ~ Stop Frequency	9 kHz~90 kHz for PK/AVG detector
Start ~ Stop Frequency	90 kHz~110 kHz for QP detector
Start ~ Stop Frequency	110 kHz~490 kHz for PK/AVG detector
Start ~ Stop Frequency	490 kHz~30 MHz for QP detector
Start ~ Stop Frequency	30 MHz~1000 MHz for QP detector
Start ~ Stop Frequency	1 GHz~26.5 GHz for PK/AVG detector

4.3. DEVIATION FROM TEST STANDARD

No deviation.

4.4. TEST SETUP

9 kHz to 30 MHz

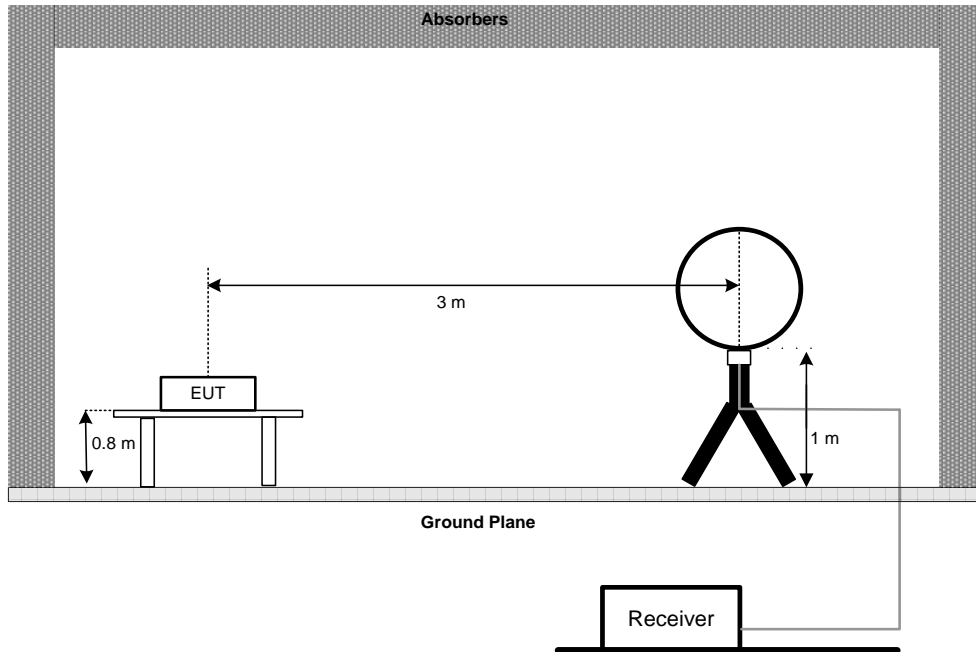

30 MHz to 1 GHz

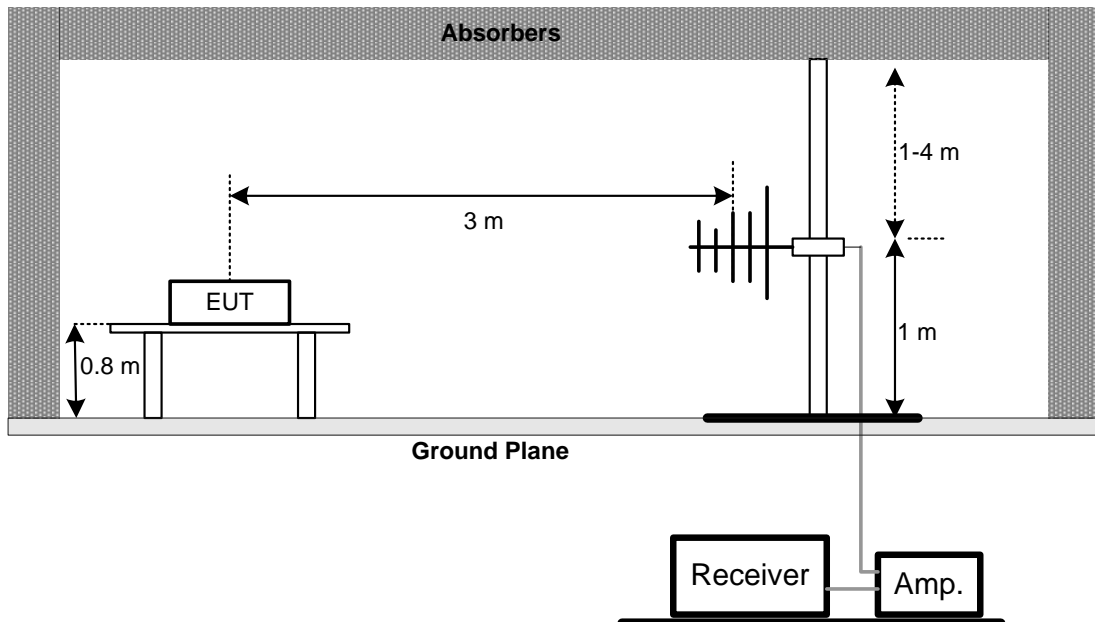

Above 1 GHz

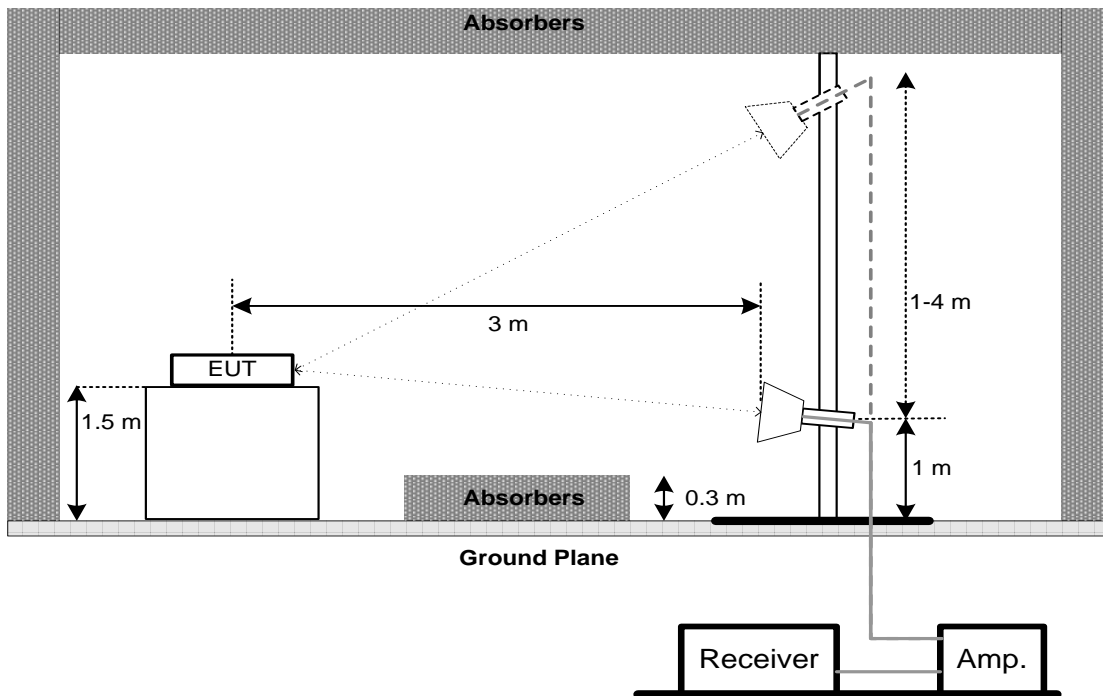

4.5. EUT OPERATING CONDITIONS

The EUT was programmed to be in continuously transmitting mode.

4.6. TEST RESULT - 9 kHz TO 30 MHz

Please refer to the APPENDIX B.

Remark:

- (1) Distance extrapolation factor = $40 \log (\text{specific distance} / \text{test distance})$ (dB).
- (2) Limit line = specific limits (dBuV) + distance extrapolation factor.

4.7. TEST RESULT - 30 MHz TO 1000 MHz

Please refer to the APPENDIX C.

4.8. TEST RESULT - ABOVE 1000 MHz

Please refer to the APPENDIX D.

Remark:

- (1) No limit: This is fundamental signal, the judgment is not applicable.
For fundamental signal judgment was referred to Peak output test.

5.. BANDWIDTH

5.1. LIMIT

Section	Test Item	Limit
FCC 15.247(a)(2)	6 dB Bandwidth	≥ 500 kHz
	99% Emission Bandwidth	-

5.2. TEST PROCEDURE

- The EUT was directly connected to the tonscend test system and antenna output port as show in the block diagram below.
- The following table is the setting of the spectrum analyzer:

For 6 dB Bandwidth:

Spectrum Parameters	Setting
Span Frequency	$>$ Measurement Bandwidth
RBW	100 kHz
VBW	300 kHz
Detector	Peak
Trace	Max Hold
Sweep Time	Auto

For 99% Emission Bandwidth:

Spectrum Parameters	Setting
Span Frequency	Between 1.5 times and 5.0 times the OBW
RBW	1% to 5% of the OBW
VBW	approximately three times RBW
Detector	Peak
Trace	Max Hold
Sweep Time	Auto

5.3. DEVIATION FROM STANDARD

No deviation.

5.4. TEST SETUP

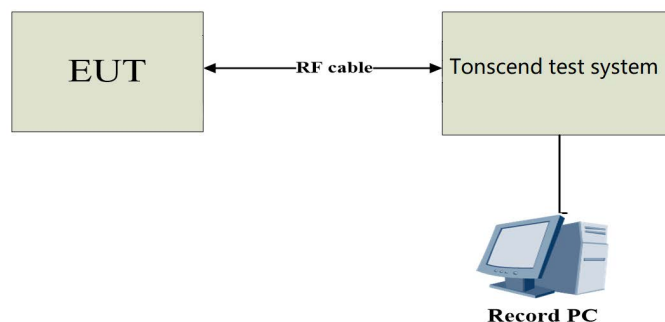

5.5. EUT OPERATION CONDITIONS

The EUT was programmed to be in continuously transmitting mode.

5.6. TEST RESULTS

Please refer to the APPENDIX E.

6.. MAXIMUM OUTPUT POWER

6.1. LIMIT

Section	Test Item	Limit
FCC 15.247(b)(3)	Maximum Output Power	1.0000 watt or 30.00 dBm

6.2. TEST PROCEDURE

- The EUT was directly connected to the tonscend test system and antenna output port as show in the block diagram below.
- The following table is the setting of the spectrum analyzer:

Spectrum Parameters	Setting
Span Frequency	$\geq 3 \times \text{RBW}$
RBW	2 MHz
VBW	6 MHz
Detector	Peak
Trace	Max Hold
Sweep Time	Auto

6.3. DEVIATION FROM STANDARD

No deviation.

6.4. TEST SETUP

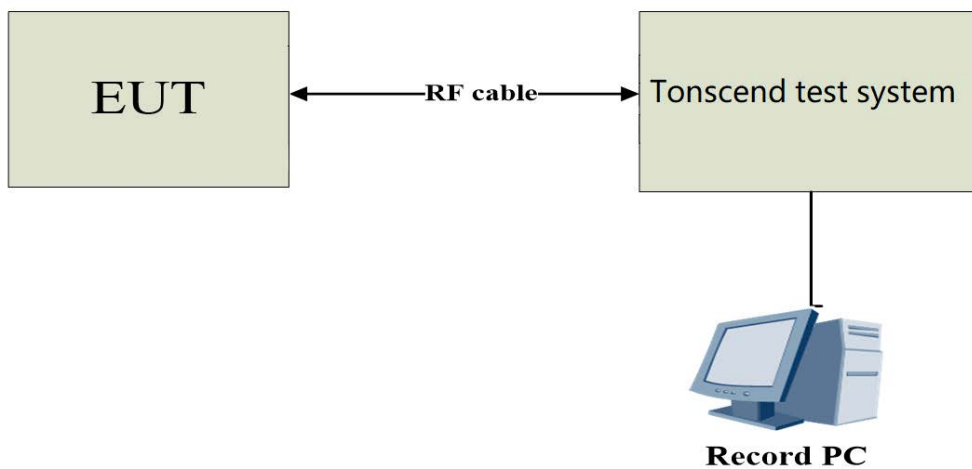

6.5. EUT OPERATION CONDITIONS

The EUT was programmed to be in continuously transmitting mode.

6.6. TEST RESULTS

Please refer to the APPENDIX F.

7.. CONDUCTED SPURIOUS EMISSION

7.1. LIMIT

In any 100 kHz bandwidth outside the frequency band in which the spread spectrum or digitally modulated intentional radiator is operating, the radio frequency power that is produced by the intentional radiator shall be at least 20 dB below that in the 100 kHz bandwidth within the band that contains the highest level of the desired power, based on either an RF conducted or a radiated measurement, provided the transmitter demonstrates compliance with the peak Output Power limits. If the transmitter complies with the Output Power limits based on the use of RMS averaging over a time interval, as permitted under paragraph (b)(3) of this section, the attenuation required under this paragraph shall be 30 dB instead of 20 dB. Attenuation below the general limits specified in Section 15.209(a) is not required.

7.2. TEST PROCEDURE

- The EUT was directly connected to the tonscend test system and antenna output port as show in the block diagram below.
- The following table is the setting of the spectrum analyzer:

Spectrum Parameters	Setting
Start Frequency	30 MHz
Stop Frequency	26.5 GHz
RBW	100 kHz
VBW	300 kHz
Detector	Peak
Trace	Max Hold
Sweep Time	Auto

7.3. DEVIATION FROM STANDARD

No deviation.

7.4. TEST SETUP

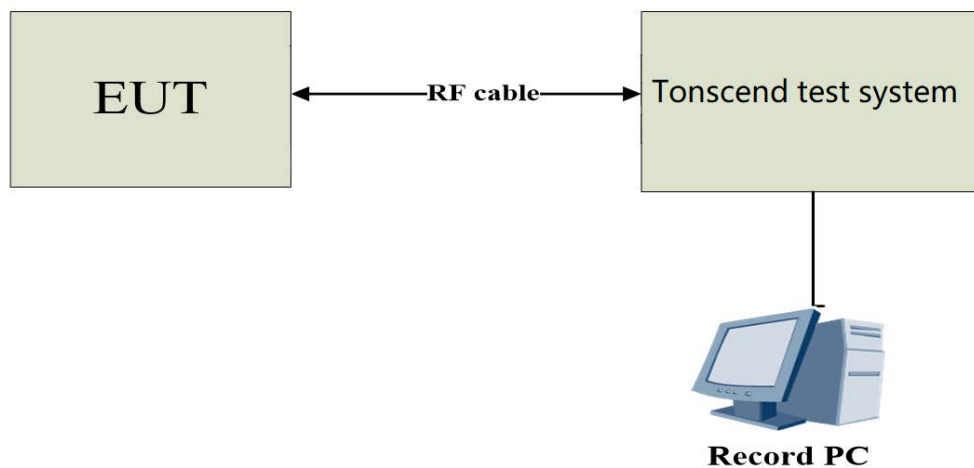

7.5. EUT OPERATION CONDITIONS

The EUT was programmed to be in continuously transmitting mode.

7.6. TEST RESULTS

Please refer to the APPENDIX G.

8.. POWER SPECTRAL DENSITY

8.1. LIMIT

Section	Test Item	Limit
FCC 15.247(e)	Power Spectral Density	8 dBm (in any 3 kHz)

8.2. TEST PROCEDURE

- The EUT was directly connected to the tonscend test system and antenna output port as show in the block diagram below.
- The following table is the setting of the spectrum analyzer:

Spectrum Parameters	Setting
Span Frequency	2 DTS Bandwidth
RBW	3 kHz
VBW	10 kHz
Detector	Peak
Trace	Max Hold
Sweep Time	Auto

8.3. DEVIATION FROM STANDARD

No deviation.

8.4. TEST SETUP

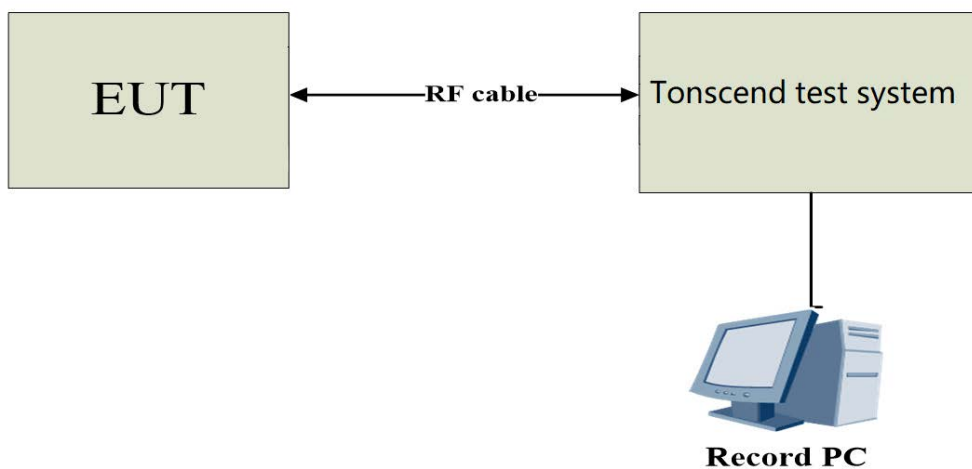

8.5. EUT OPERATION CONDITIONS

The EUT was programmed to be in continuously transmitting mode.

8.6. TEST RESULTS

Please refer to the APPENDIX H.

9.. MEASUREMENT INSTRUMENTS LIST

Radiated Emissions						
No.	Equipment	Manufacturer	Type No.	Serial No.	Cal. date (yyyy/mm/dd)	Cal. Due date (yyyy/mm/dd)
1	Test receiver	Rohde&Schwarz	ESU	100184	2023/5/3	2024/5/2
2	MXA Signal Analyzer	Keysight	N9010A	MY514401 58	2023/4/22	2024/4/21
3	Log periodic antenna	Schwarzbeck	VULB 9168	1151	2023/5/4	2024/5/3
4	Low frequency amplifier	/	LNA 0920N	2014	2023/5/3	2024/5/2
5	High frequency amplifier	Schwarzbeck	BBV 9718	284	2023/5/3	2024/5/2
6	Horn Antenna	SCHWARZBECK	BBHA 9120 D	9120D- 1273	2023/5/4	2024/5/3
7	Temp&Humidity Recorder	Meideshi	JR900	/	2023/5/3	2024/5/2
8	Horn Antenna	SCHWARZBECK	BBHA 9170	9170#685	2023/7/16	2024/7/15
9	Loop Antenna	SCHWARZBECK	FMZB1519 B	00029	2023/7/16	2024/7/15
10	Broadband preamplifier	Schwarzbeck	BBV9721	9721-019	2023/5/3	2024/5/2
13	Test software	Farad Technology Co., Ltd	EZ-EMC Ver.TW-03A2			
Conducted Emission						
1	LISN	Rohde&Schwarz	ENV216	100075	2023/5/3	2024/5/2
2	ISN	Schwarzbeck	CATE 5 8158	#171	2023/5/3	2024/5/2
3	ISN	Schwarzbeck	CAT 3 8158	00187	2023/4/1	2024/3/31
4	Test receiver	Rohde&Schwarz	ESCI	100718	2023/5/3	2024/5/2
5	Pulse limiter	Rohde&Schwarz	ESH3-Z2	102299	2023/5/3	2024/5/2
6	Temp&Humidity Recorder	Meideshi	JR900	/	2023/5/3	2024/5/2
7	Test software	Farad Technology Co., Ltd	EZ-EMC Ver.TW-03A2			
RF conducted Emissions						
1	MXA Signal Analyzer	Keysight	N9021B	MY600801 69	2023/4/23	2024/4/22
2	RF Control Unit	dsusoft	JS0806-2	21G806044 9	2023/4/23	2024/4/22
3	power supply unit	dsusoft	JS0806- 4ADC	N/A	2023/4/23	2024/4/22
4	VXG Signal Generator	Keysight	M9384B	MY612707 87	2023/4/23	2024/4/22
5	EXG Analog Signal Generator	Keysight	N5173B	MY591012 82	2023/4/23	2024/4/22
6	Wideband Radio Communication Tester	Rohde&Schwarz	CMW500	1201.0002 K50- 116064-Dt	2023/4/23	2024/4/22
6	Test software	dsusoft	JS1120-3 Ver.3.2.22.0			

10.. ANTENNA REQUIREMENT

Test standard: FCC part 15.203

According to the manufacturer declared, the EUT has PCB antenna, the antenna gain is 3.6dBi and the antenna connector is designed with permanent attachment and no consideration of replacement.

Therefore the EUT is considered sufficient to comply with the provision.

Refer to EUT Photo for further details.



APPENDIX A - AC POWER LINE CONDUCTED EMISSIONS

HT-580AXT:

Test Mode	TX Mode_1Mbps Channel 00	Phase	Line
-----------	--------------------------	-------	------

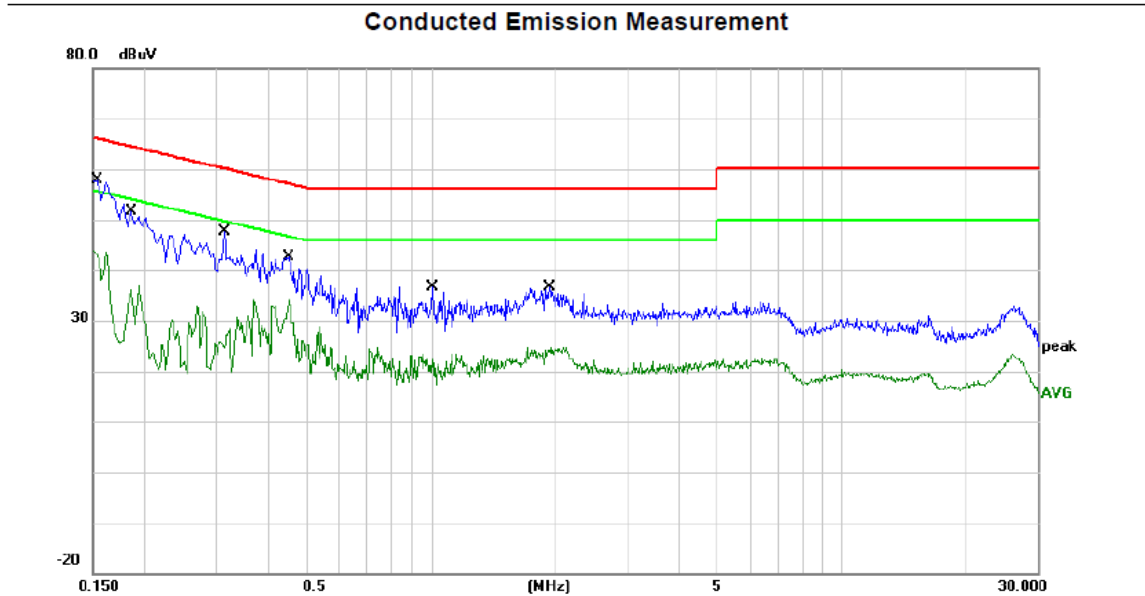

No.	Mk.	Freq.	Reading Level	Correct Factor	Measurement	Limit	Over	Detector	Comment
		MHz	dBuV	dB	dBuV	dBuV	dB		
1	*	0.1540	35.22	20.06	55.28	65.78	-10.50	QP	
2		0.1540	20.89	20.06	40.95	55.78	-14.83	AVG	
3		0.1864	28.80	20.04	48.84	64.20	-15.36	QP	
4		0.1864	12.17	20.04	32.21	54.20	-21.99	AVG	
5		0.3140	16.59	20.08	36.67	59.86	-23.19	QP	
6		0.3140	3.55	20.08	23.63	49.86	-26.23	AVG	
7		0.4500	18.09	20.29	38.38	56.88	-18.50	QP	
8		0.4500	9.64	20.29	29.93	46.88	-16.95	AVG	
9		1.0100	7.33	19.99	27.32	56.00	-28.68	QP	
10		1.0100	-0.14	19.99	19.85	46.00	-26.15	AVG	
11		1.9460	9.38	20.17	29.55	56.00	-26.45	QP	
12		1.9460	3.08	20.17	23.25	46.00	-22.75	AVG	

REMARKS:

- (1) Measurement Value = Reading Level + Correct Factor.
- (2) Margin Level = Measurement Value - Limit Value.

Test Mode	TX Mode_1Mbps Channel 00	Phase	Neutral
-----------	--------------------------	-------	---------

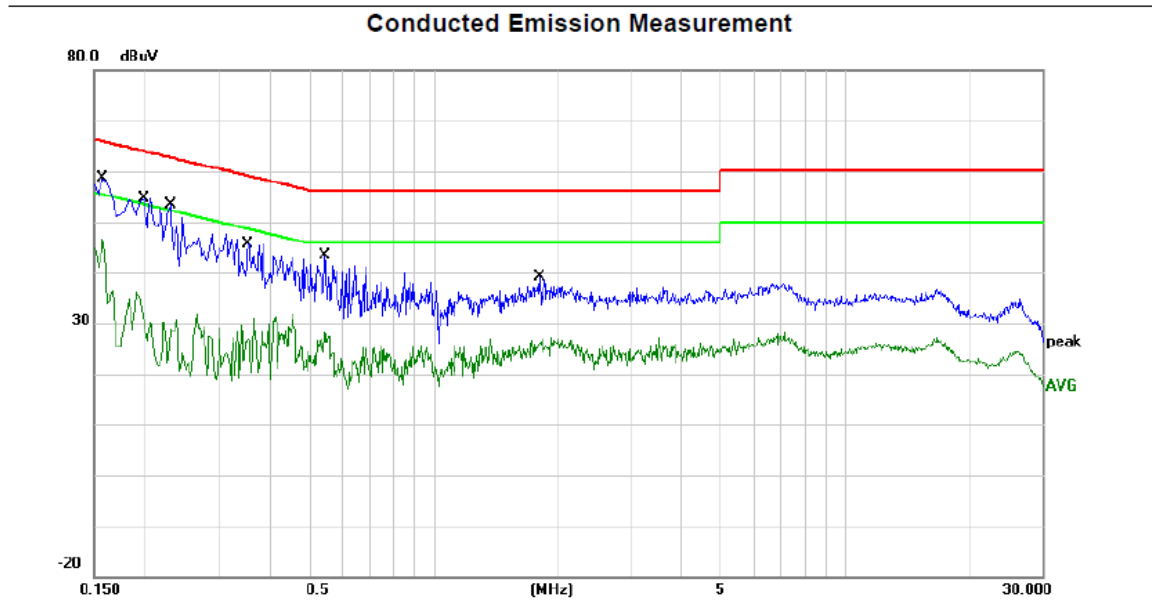

No.	Mk.	Freq. MHz	Reading Level dBuV	Correct Factor dB	Measure- ment dBuV	Limit dBuV	Over dB	Detector	Comment
1	*	0.1580	34.97	20.28	55.25	65.57	-10.32	QP	
2		0.1580	20.03	20.28	40.31	55.57	-15.26	AVG	
3		0.1955	27.71	20.34	48.05	63.80	-15.75	QP	
4		0.1955	12.31	20.34	32.65	53.80	-21.15	AVG	
5		0.2300	22.84	20.16	43.00	62.45	-19.45	QP	
6		0.2300	7.00	20.16	27.16	52.45	-25.29	AVG	
7		0.3540	15.26	19.90	35.16	58.87	-23.71	QP	
8		0.3540	5.32	19.90	25.22	48.87	-23.65	AVG	
9		0.5460	13.21	20.14	33.35	56.00	-22.65	QP	
10		0.5460	3.23	20.14	23.37	46.00	-22.63	AVG	
11		1.8140	12.01	20.34	32.35	56.00	-23.65	QP	
12		1.8140	4.29	20.34	24.63	46.00	-21.37	AVG	

REMARKS:

- (1) Measurement Value = Reading Level + Correct Factor.
- (2) Margin Level = Measurement Value - Limit Value.

HT-580AET:

Test Mode	TX Mode_1Mbps Channel 00	Phase	Line
-----------	--------------------------	-------	------

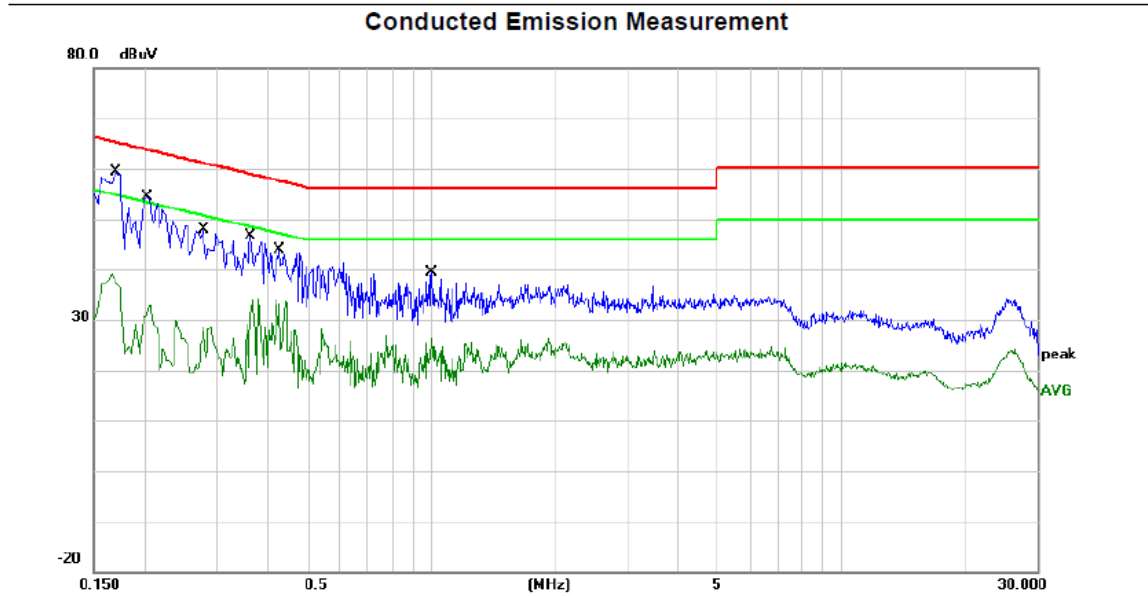

No.	Mk.	Freq.	Reading Level	Correct Factor	Measurement	Limit	Over	Detector	Comment
		MHz	dBuV	dB	dBuV	dBuV	dB		
1	*	0.1700	31.70	20.12	51.82	64.96	-13.14	QP	
2		0.1700	12.73	20.12	32.85	54.96	-22.11	AVG	
3		0.2020	26.84	19.99	46.83	63.53	-16.70	QP	
4		0.2020	9.73	19.99	29.72	53.53	-23.81	AVG	
5		0.2780	19.05	20.06	39.11	60.88	-21.77	QP	
6		0.2780	5.99	20.06	26.05	50.88	-24.83	AVG	
7		0.3620	17.88	20.10	37.98	58.68	-20.70	QP	
8		0.3620	7.02	20.10	27.12	48.68	-21.56	AVG	
9		0.4260	17.68	20.32	38.00	57.33	-19.33	QP	
10		0.4260	7.45	20.32	27.77	47.33	-19.56	AVG	
11		1.0020	10.18	19.98	30.16	56.00	-25.84	QP	
12		1.0020	2.33	19.98	22.31	46.00	-23.69	AVG	

REMARKS:

(1) Measurement Value = Reading Level + Correct Factor.

(2) Margin Level = Measurement Value - Limit Value.

Test Mode	TX Mode_1Mbps Channel 00	Phase	Neutral
-----------	--------------------------	-------	---------

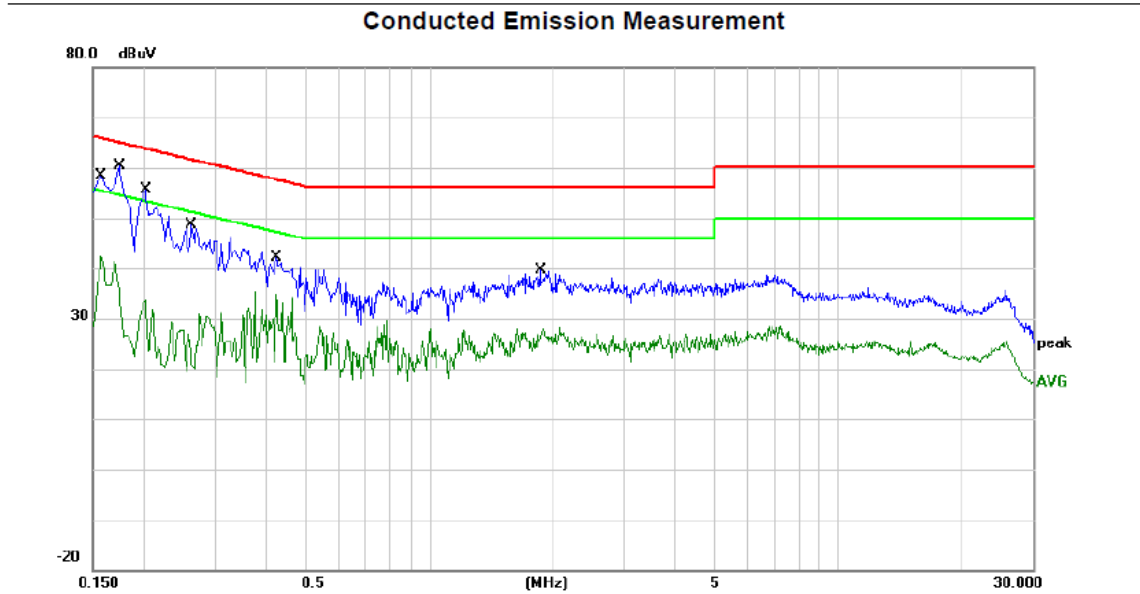

No.	Mk.	Freq.	Reading Level	Correct Factor	Measurement	Limit	Over	Detector	Comment
		MHz	dBuV	dB	dBuV	dBuV	dB		
1	*	0.1580	35.10	20.28	55.38	65.57	-10.19	QP	
2		0.1580	19.27	20.28	39.55	55.57	-16.02	AVG	
3		0.1740	28.20	20.26	48.46	64.77	-16.31	QP	
4		0.1740	9.35	20.26	29.61	54.77	-25.16	AVG	
5		0.2020	26.92	20.34	47.26	63.53	-16.27	QP	
6		0.2020	9.88	20.34	30.22	53.53	-23.31	AVG	
7		0.2620	17.70	20.06	37.76	61.37	-23.61	QP	
8		0.2620	-0.24	20.06	19.82	51.37	-31.55	AVG	
9		0.4220	17.37	20.19	37.56	57.41	-19.85	QP	
10		0.4220	6.94	20.19	27.13	47.41	-20.28	AVG	
11		1.8740	12.91	20.34	33.25	56.00	-22.75	QP	
12		1.8740	5.04	20.34	25.38	46.00	-20.62	AVG	

REMARKS:

- (1) Measurement Value = Reading Level + Correct Factor.
- (2) Margin Level = Measurement Value - Limit Value.

APPENDIX B - RADIATED EMISSION - 9 KHZ TO 30 MHZ

Radiated emission: 9KHz-30MHz

The low frequency, which started from 9 kHz to 30MHz, was pre-scanned and the result which was 20dB lower than the limit line was not reported.

There is a comparison data of both open-field test site and semi-Anechoic chamber, and the result came out very similar.



APPENDIX C - RADIATED EMISSION - 30 MHZ TO 1000 MHZ

HT-580AXT:

Test Mode	TX Mode_1Mbps Channel 00	Polarization	Vertical
-----------	--------------------------	--------------	----------

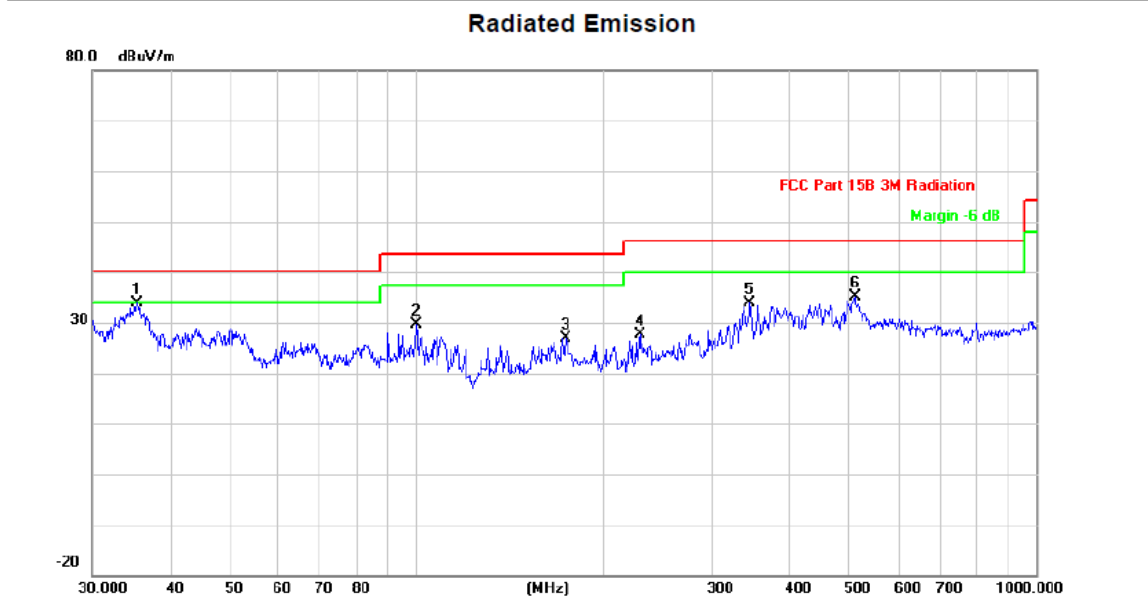

No.	Mk.	Freq.	Reading Level	Correct Factor	Measurement	Limit	Over	Antenna Height	Table Degree	
		MHz	dBuV	dB/m	dBuV/m	dBuV/m	dB	cm	degree	Comment
1	*	35.3750	44.27	-10.31	33.96	40.00	-6.04	peak		
2		99.8777	42.33	-12.71	29.62	43.50	-13.88	peak		
3		174.4240	36.75	-9.80	26.95	43.50	-16.55	peak		
4		229.2930	39.00	-11.46	27.54	46.00	-18.46	peak		
5		345.5951	41.73	-7.73	34.00	46.00	-12.00	peak		
6		510.0434	38.40	-3.35	35.05	46.00	-10.95	peak		

REMARKS:

(1) Measurement Value = Reading Level + Correct Factor.

(2) Margin Level = Measurement Value - Limit Value.

Test Mode	TX Mode_1Mbps Channel 00	Polarization	Horizontal
-----------	--------------------------	--------------	------------

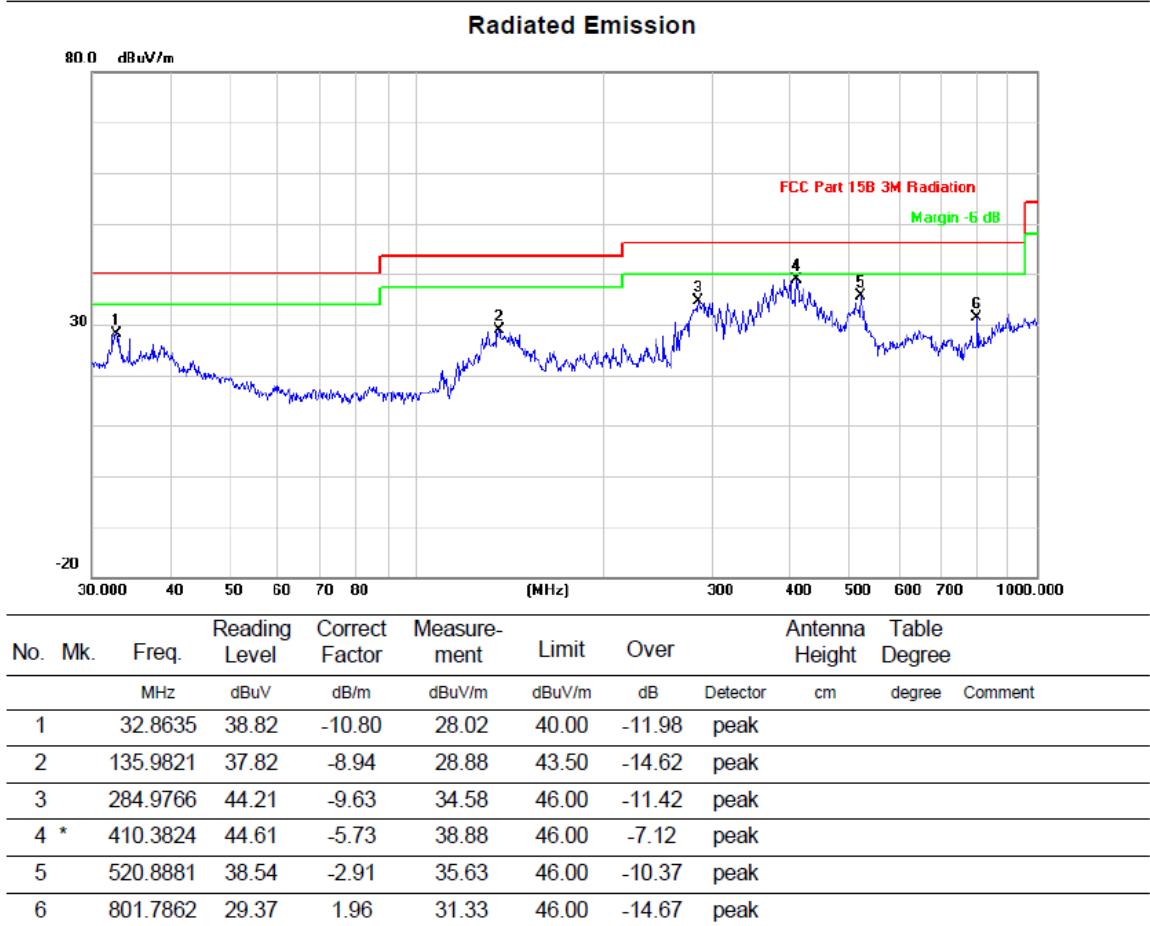

REMARKS:

- (1) Measurement Value = Reading Level + Correct Factor.
- (2) Margin Level = Measurement Value - Limit Value.

HT-580AET:

Test Mode	TX Mode_1Mbps Channel 00	Polarization	Vertical
-----------	--------------------------	--------------	----------

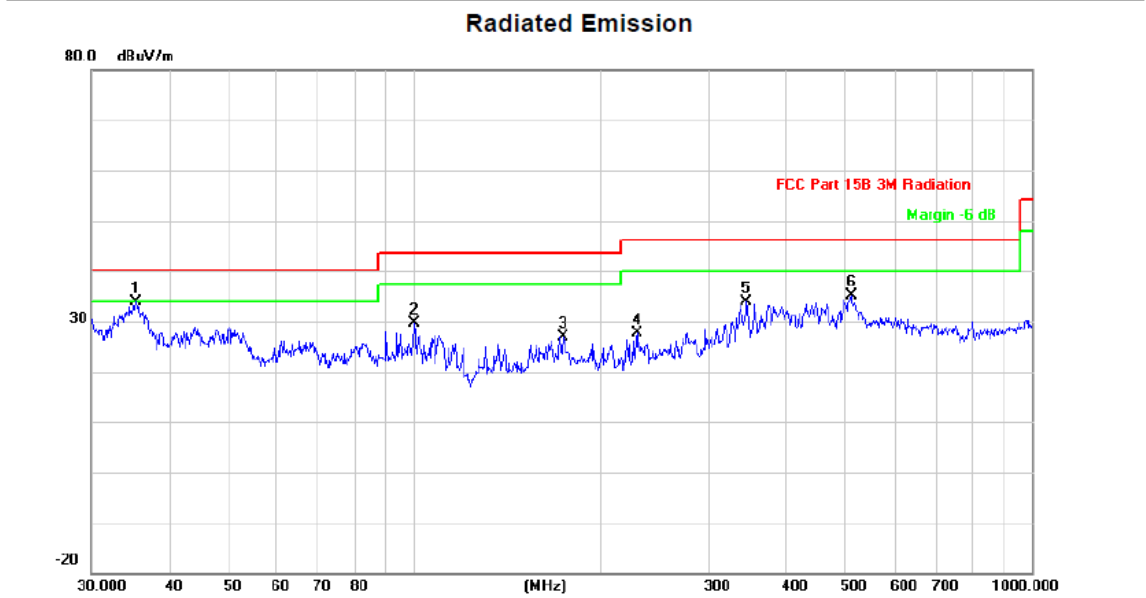

No.	Mk.	Freq.	Reading Level	Correct Factor	Measurement	Limit	Over	Antenna Height	Table Degree	
		MHz	dBuV	dB/m	dBuV/m	dBuV/m	dB	cm	degree	Comment
1	*	35.3750	44.27	-10.31	33.96	40.00	-6.04	peak		
2		99.8777	42.33	-12.71	29.62	43.50	-13.88	peak		
3		174.4240	36.75	-9.80	26.95	43.50	-16.55	peak		
4		229.2930	39.00	-11.46	27.54	46.00	-18.46	peak		
5		345.5951	41.73	-7.73	34.00	46.00	-12.00	peak		
6		510.0434	38.40	-3.35	35.05	46.00	-10.95	peak		

REMARKS:

- (1) Measurement Value = Reading Level + Correct Factor.
- (2) Margin Level = Measurement Value - Limit Value.

Test Mode	TX Mode_1Mbps Channel 00	Polarization	Horizontal
-----------	--------------------------	--------------	------------

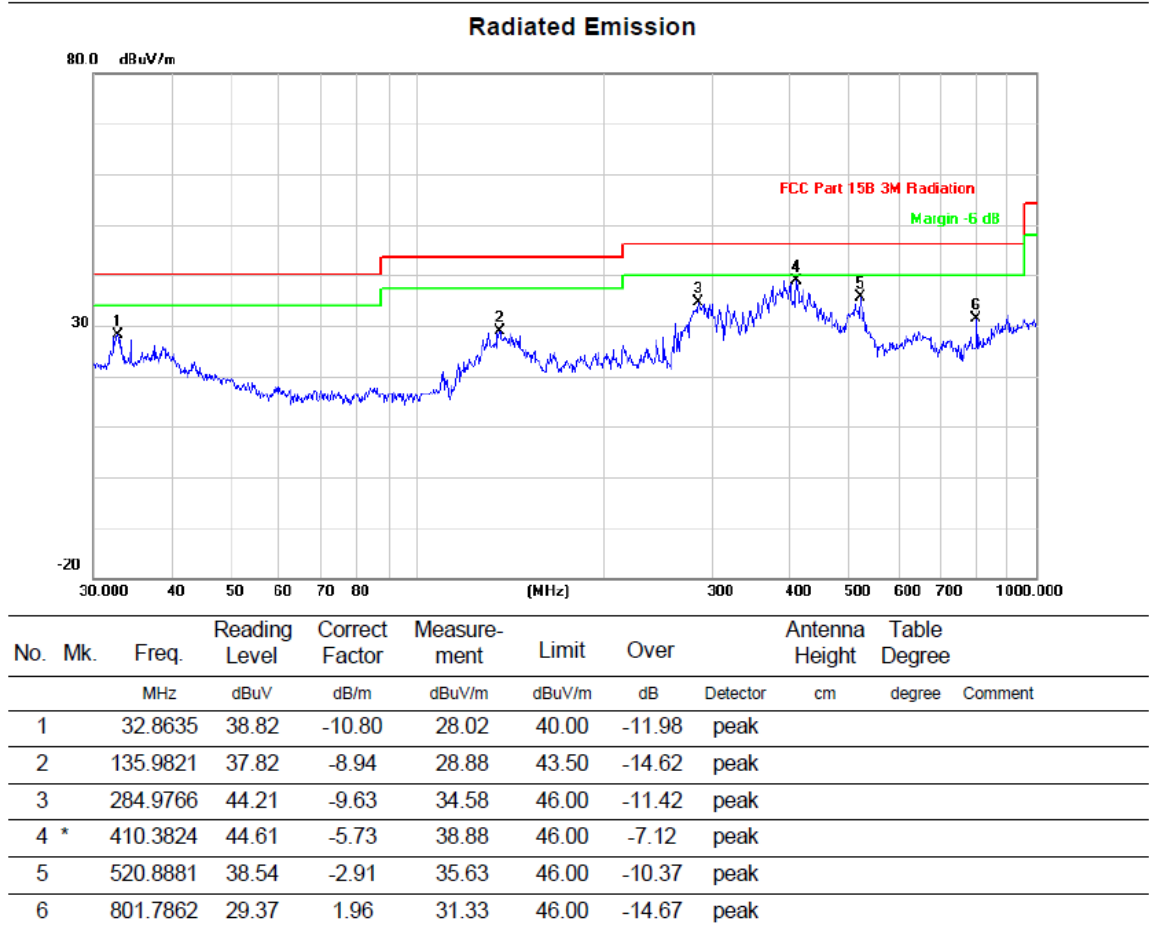

REMARKS:

- (1) Measurement Value = Reading Level + Correct Factor.
- (2) Margin Level = Measurement Value - Limit Value.



APPENDIX D - RADIATED EMISSION - ABOVE 1000 MHZ

Test Mode	TX 2402 MHz_1Mbps	Polarization	Vertical
-----------	-------------------	--------------	----------

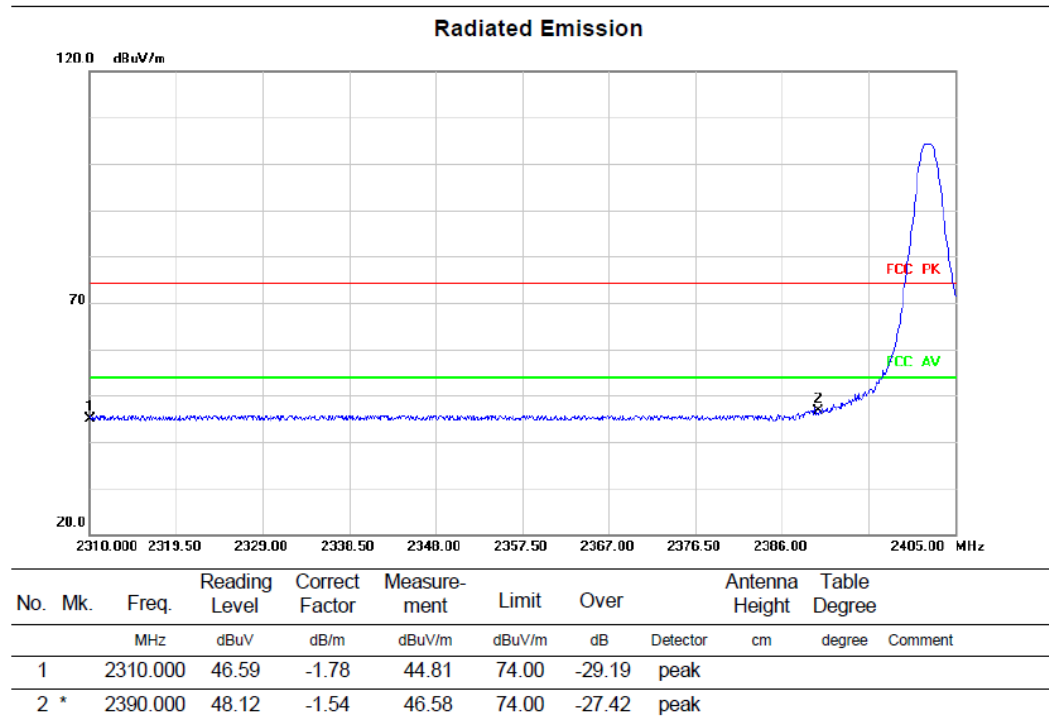
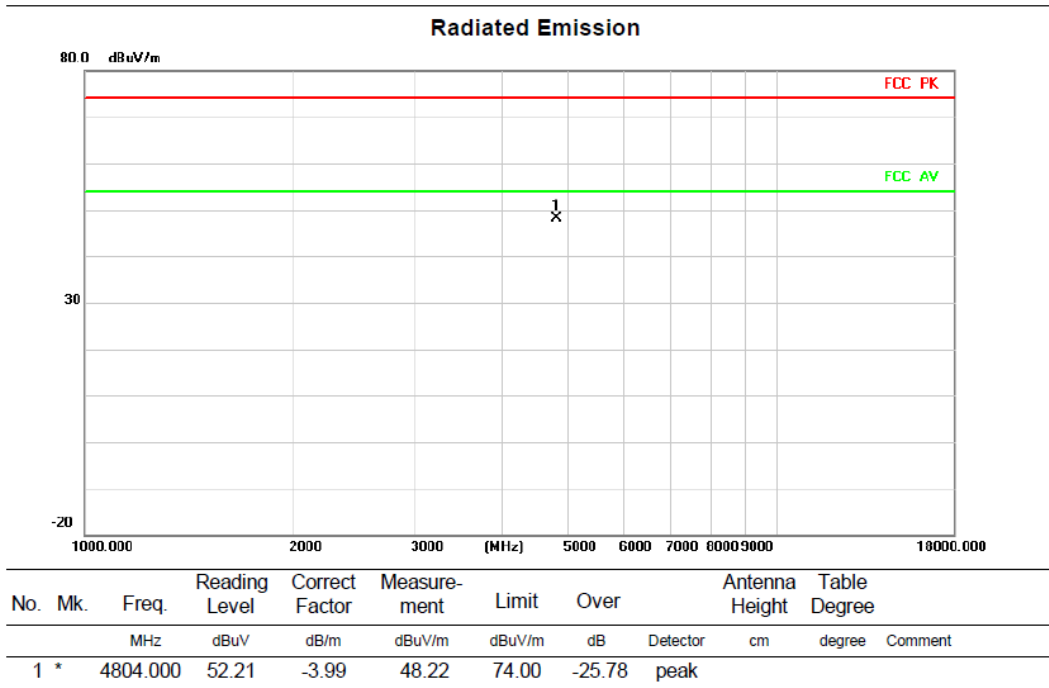

Test Mode	TX 2402 MHz_1Mbps	Polarization	Horizontal
-----------	-------------------	--------------	------------

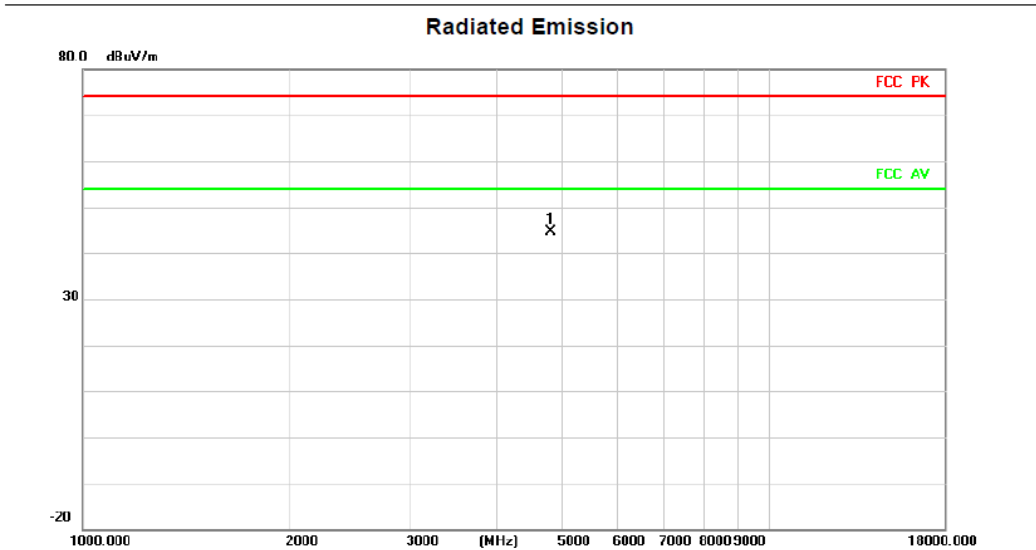

No.	Mk.	Freq.	Reading Level	Correct Factor	Measurement	Limit	Over	Antenna Height	Table Degree	
		MHz	dBuV	dB/m	dBuV/m	dBuV/m	dB	cm	degree	Comment
1	*	4804.000	48.64	-3.99	44.65	74.00	-29.35	peak		

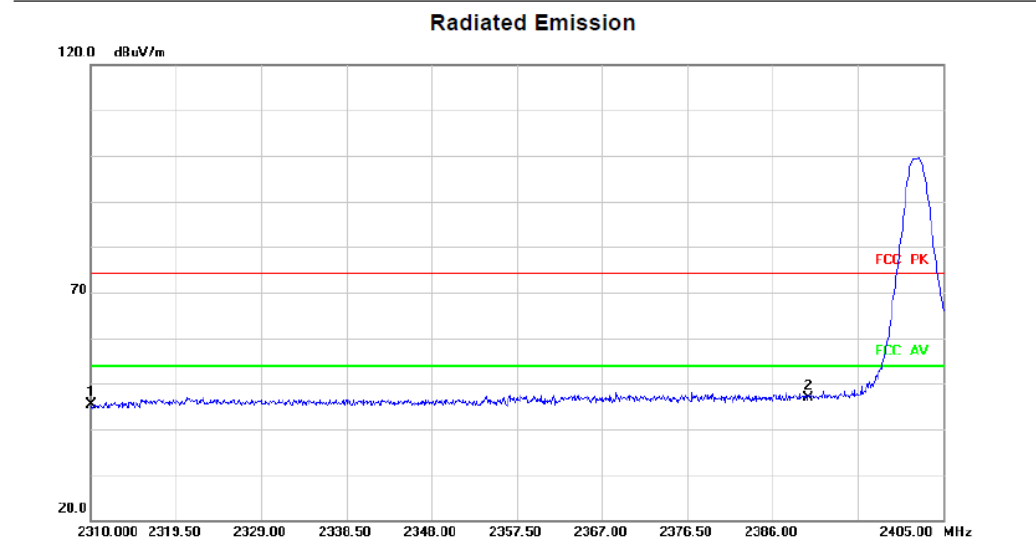

No.	Mk.	Freq.	Reading Level	Correct Factor	Measurement	Limit	Over	Antenna Height	Table Degree	
		MHz	dBuV	dB/m	dBuV/m	dBuV/m	dB	cm	degree	Comment
1		2310.000	47.15	-1.78	45.37	74.00	-28.63	peak		
2	*	2390.000	48.49	-1.54	46.95	74.00	-27.05	peak		

Test Mode	TX 2440 MHz _1Mbps	Polarization	Vertical
-----------	--------------------	--------------	----------

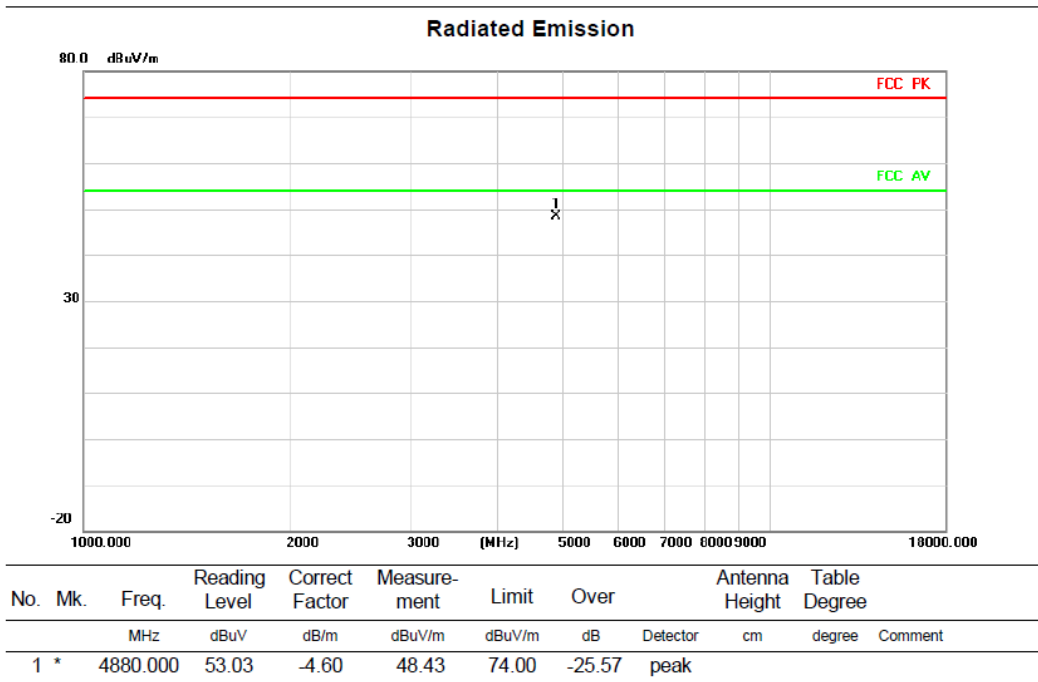

Test Mode	TX 2440 MHz _1Mbps	Polarization	Horizontal
-----------	--------------------	--------------	------------

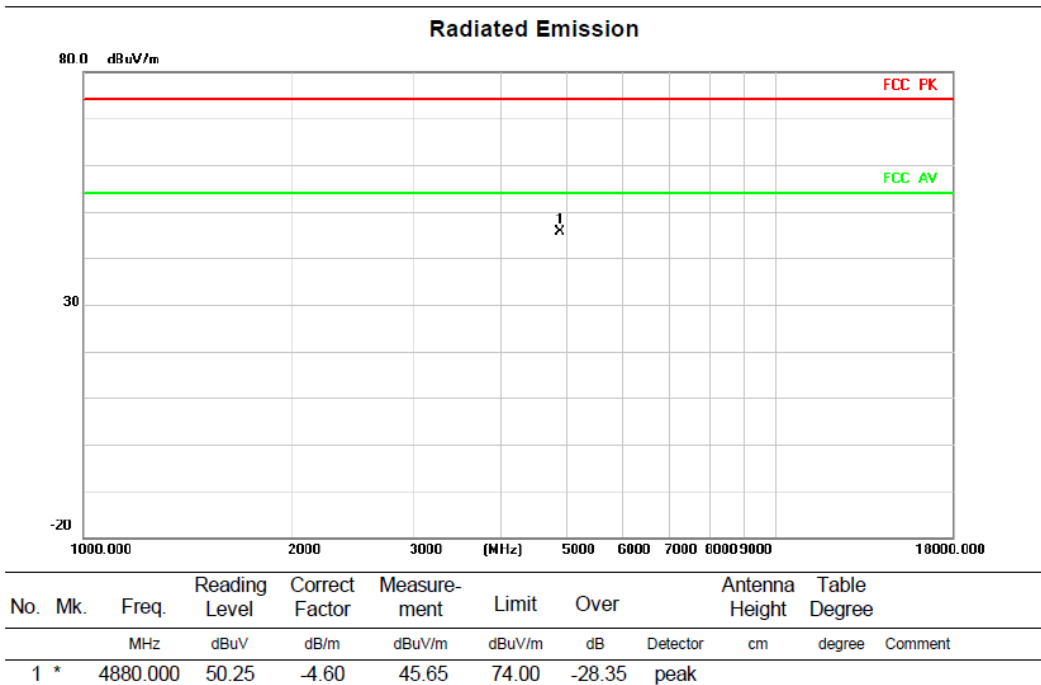

Test Mode	TX 2480 MHz_1Mbps	Polarization	Vertical
-----------	-------------------	--------------	----------

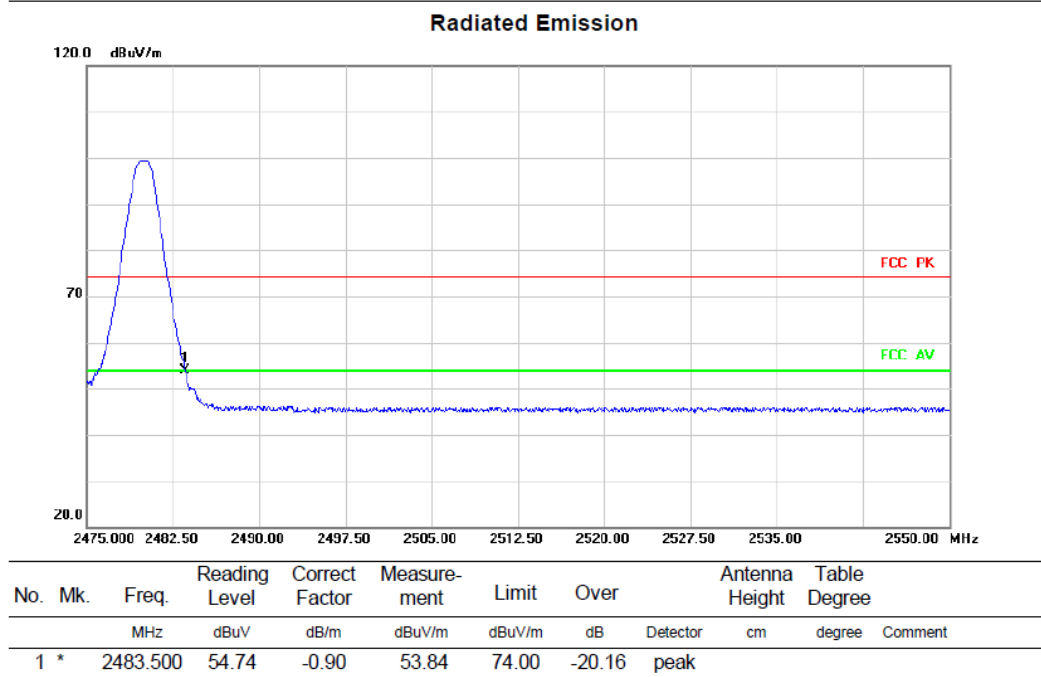
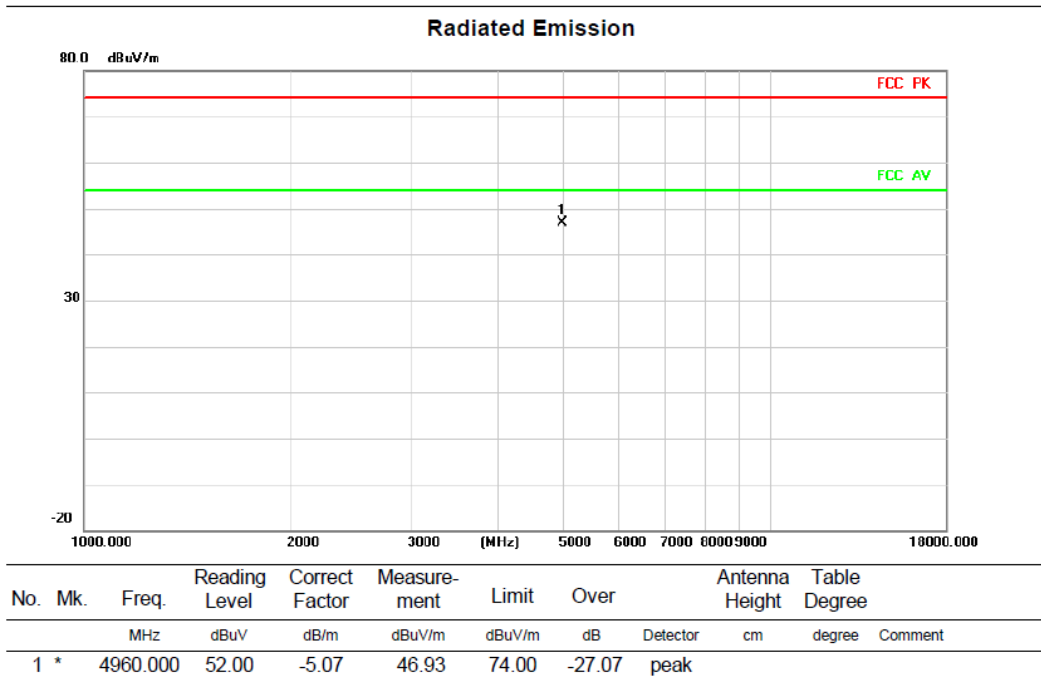

Test Mode	TX 2480 MHz_1Mbps	Polarization	Horizontal
-----------	-------------------	--------------	------------

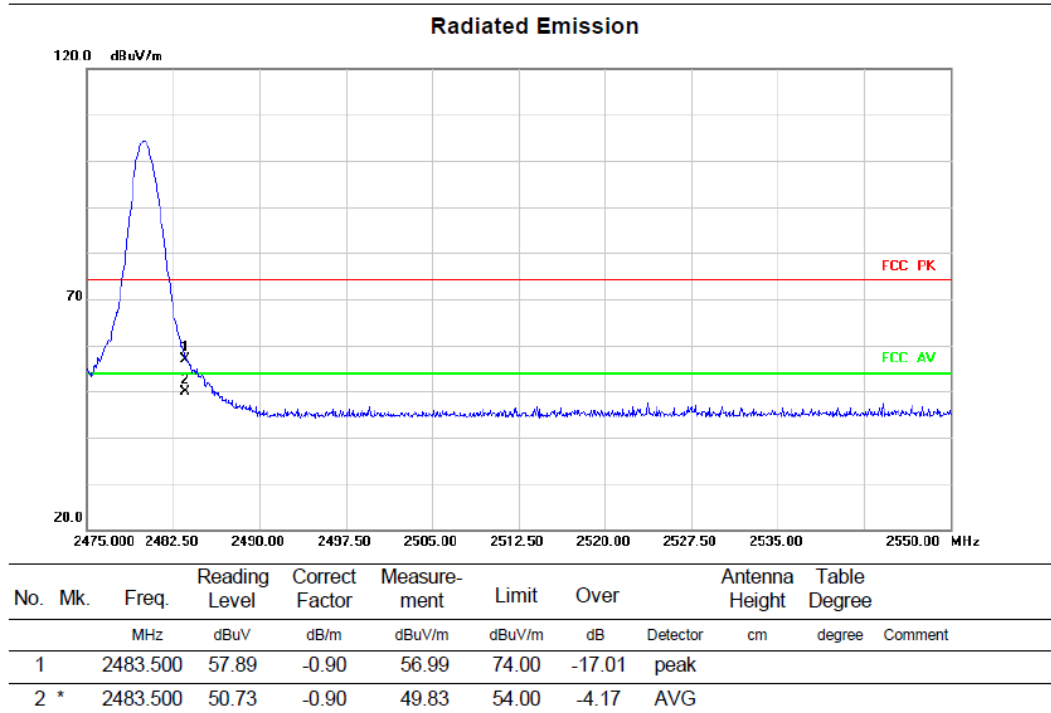
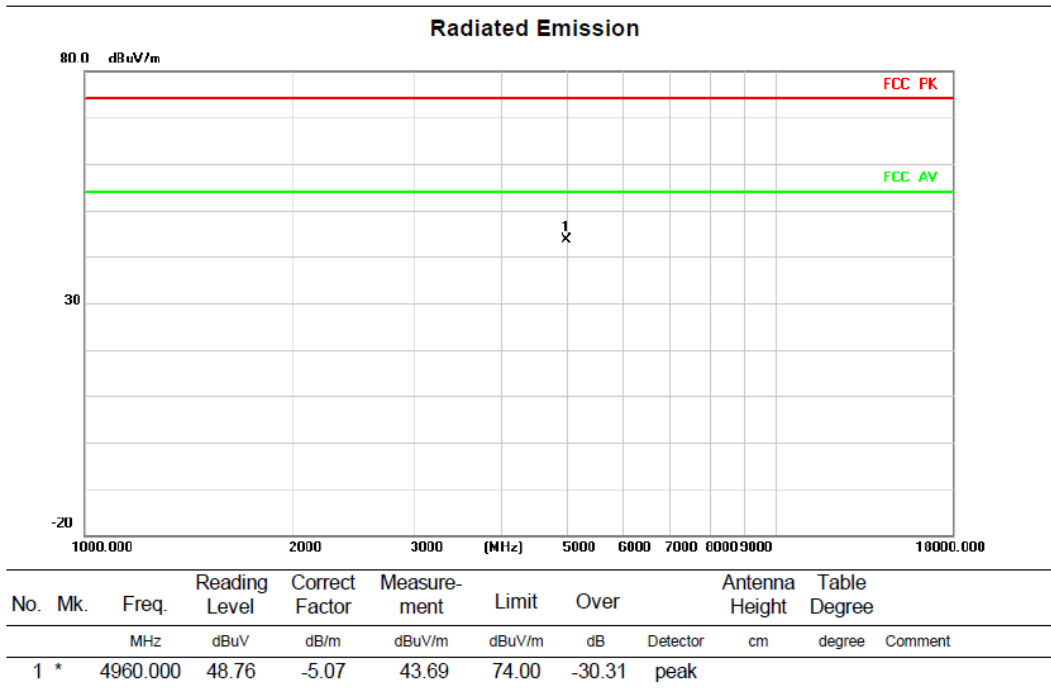

Test Mode	TX 2402 MHz_2Mbps	Polarization	Vertical
-----------	-------------------	--------------	----------

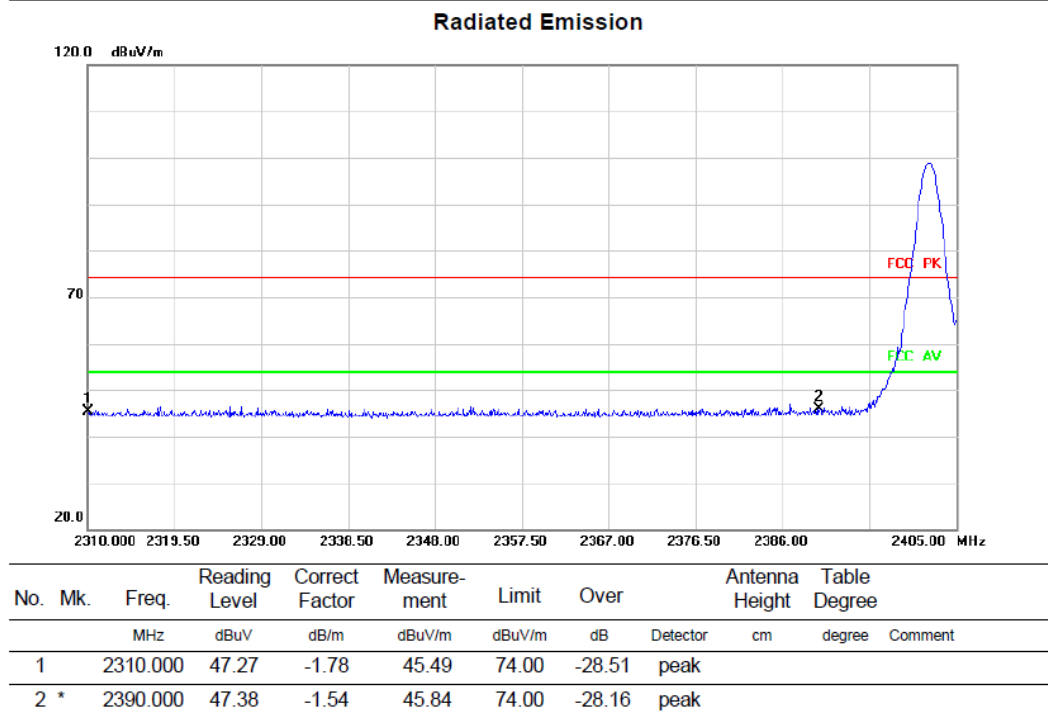
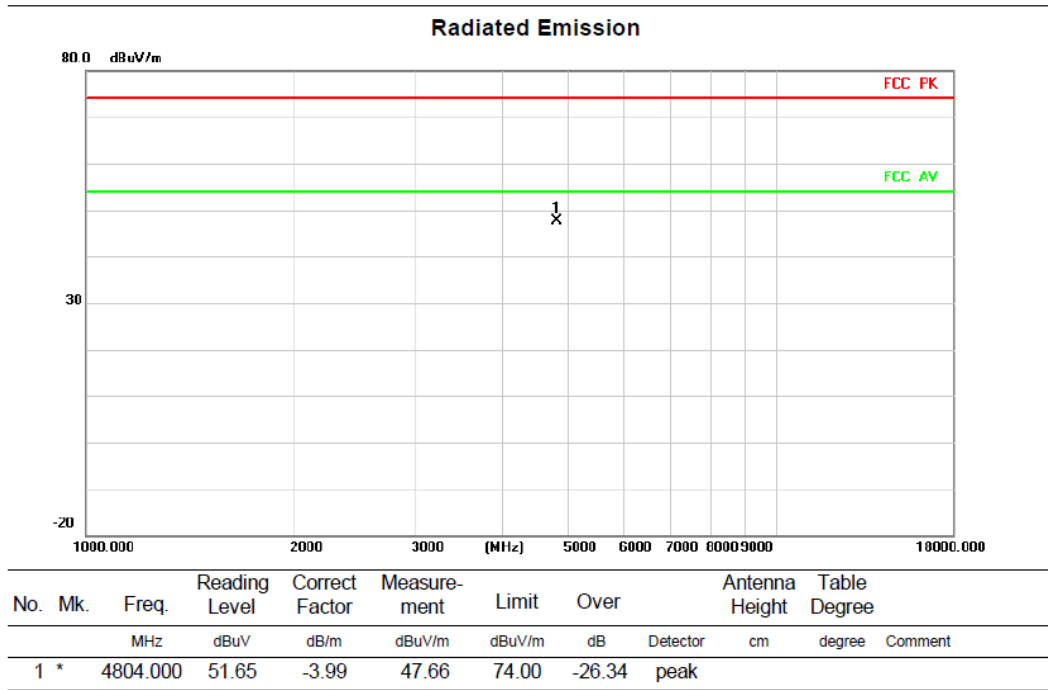

Test Mode	TX 2402 MHz_2Mbps	Polarization	Horizontal
-----------	-------------------	--------------	------------

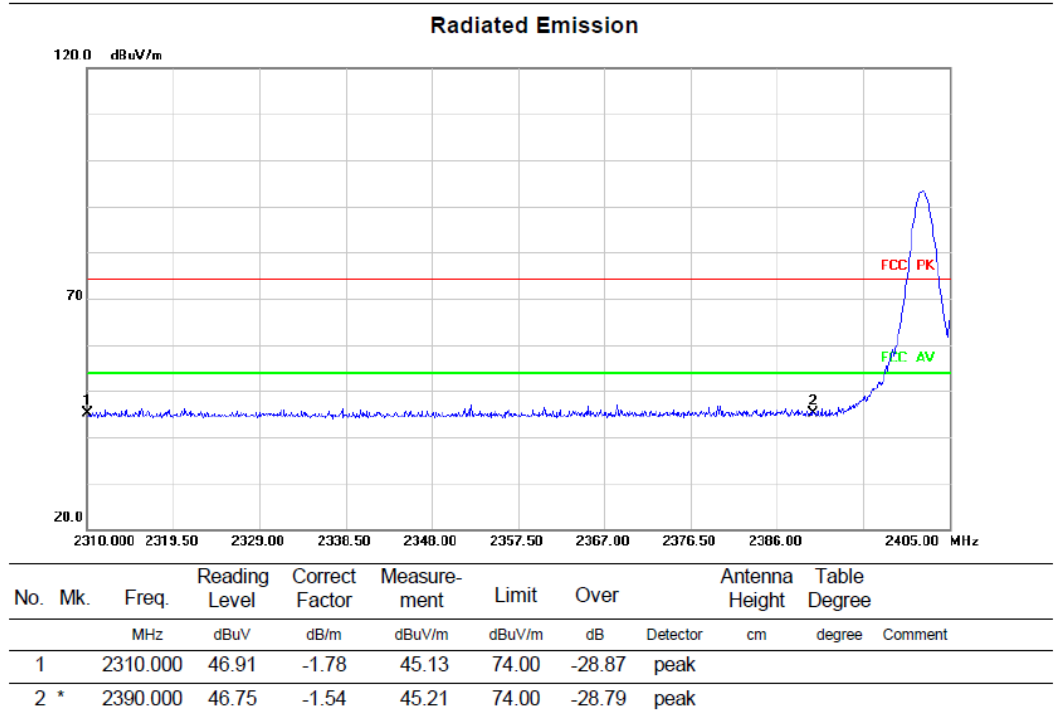
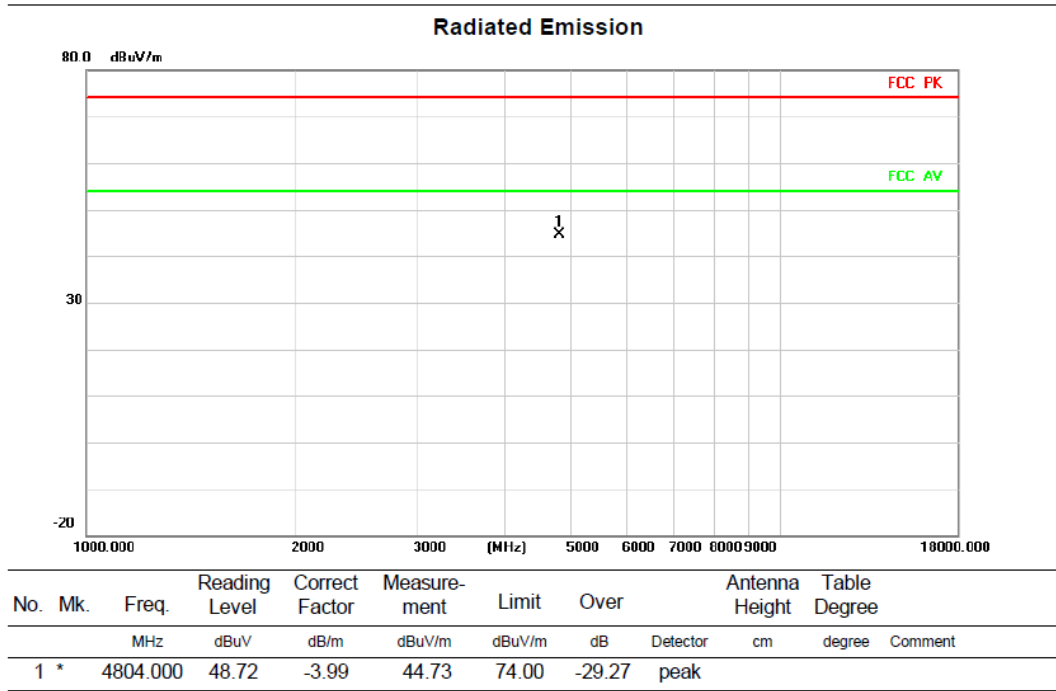

Test Mode	TX 2440 MHz _2Mbps	Polarization	Vertical
-----------	--------------------	--------------	----------

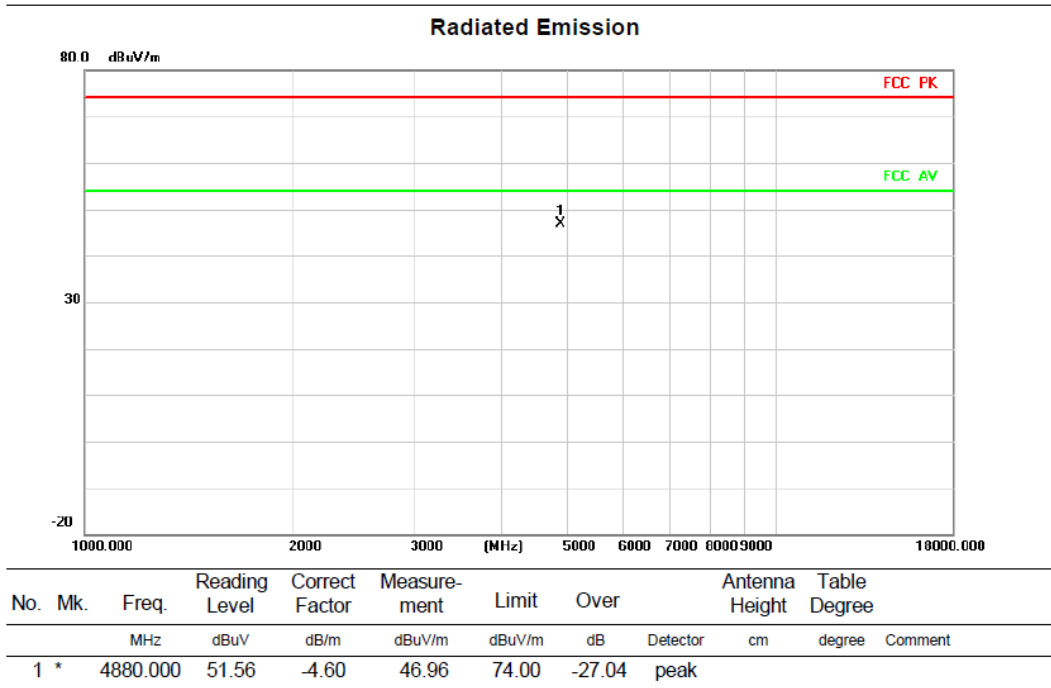

Test Mode	TX 2440 MHz _1Mbps	Polarization	Horizontal
-----------	--------------------	--------------	------------

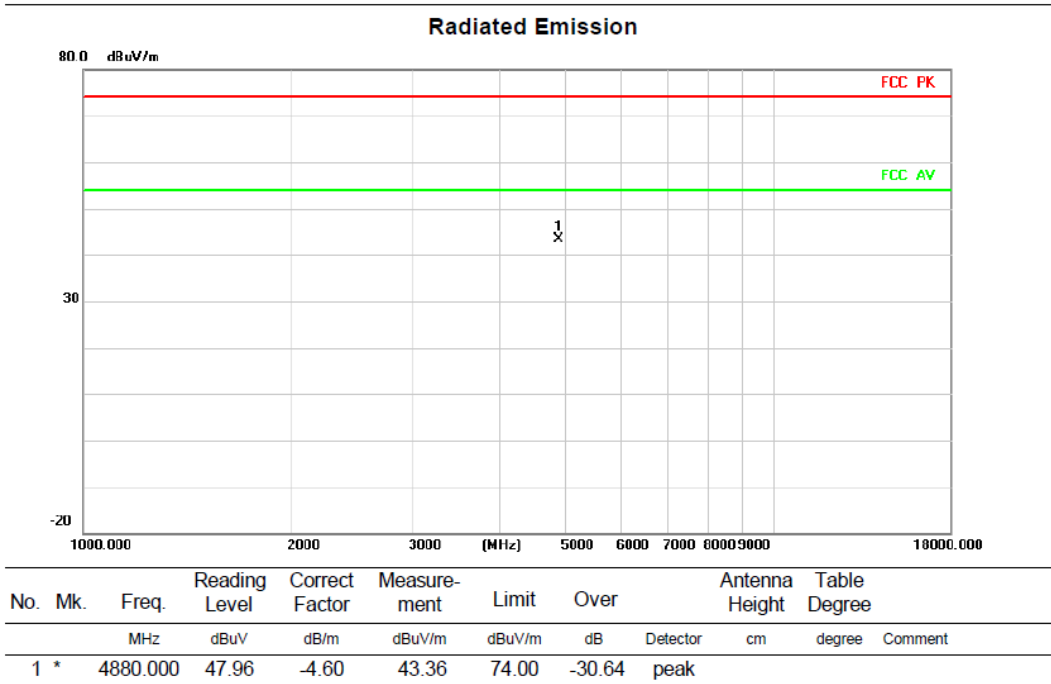

Test Mode	TX 2480 MHz_2Mbps	Polarization	Vertical
-----------	-------------------	--------------	----------

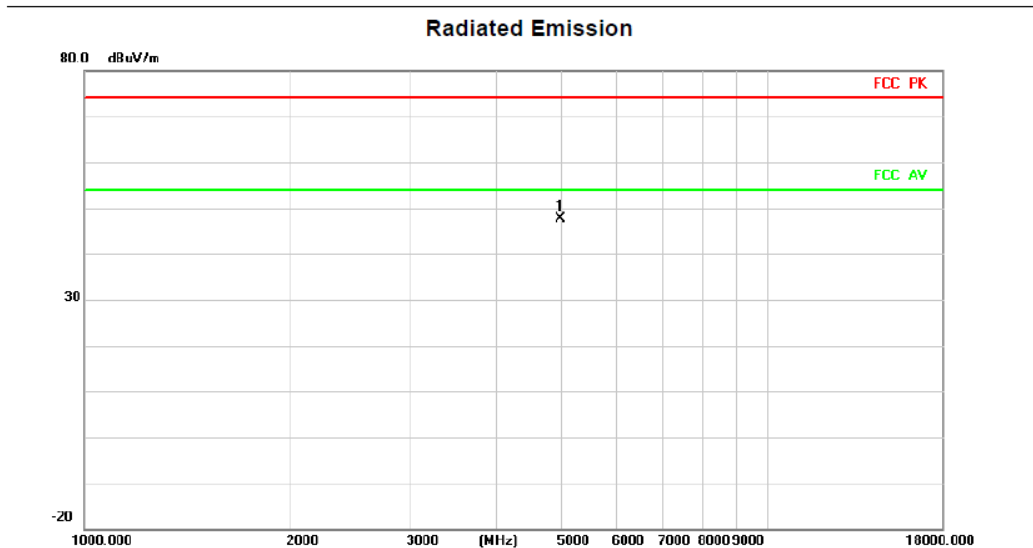

No.	Mk.	Freq.	Reading Level	Correct Factor	Measurement	Limit	Over	Antenna Height	Table Degree
		MHz	dBuV	dB/m	dBuV/m	dBuV/m	dB	cm	degree
1	*	4960.000	52.70	-5.07	47.63	74.00	-26.37	peak	

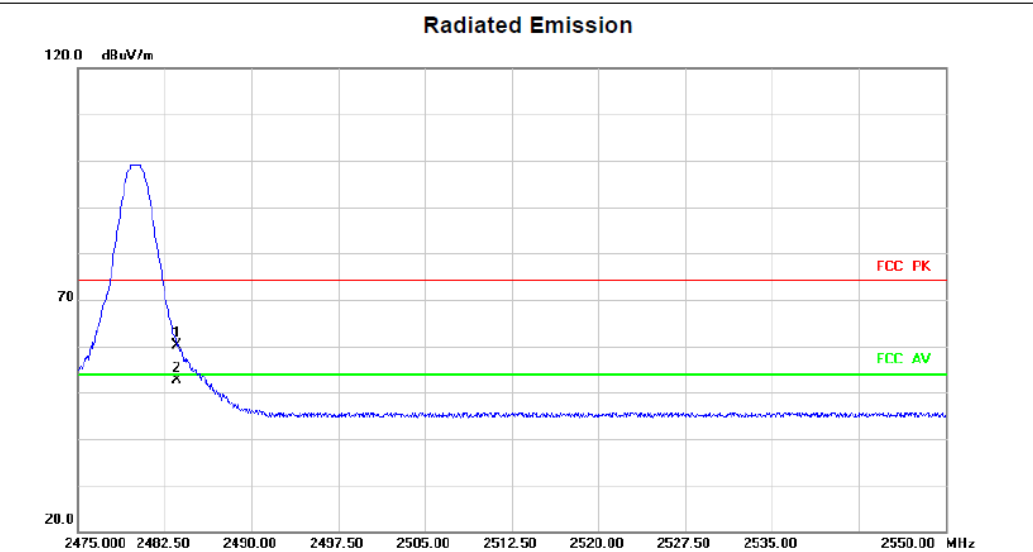

No.	Mk.	Freq.	Reading Level	Correct Factor	Measurement	Limit	Over	Antenna Height	Table Degree
		MHz	dBuV	dB/m	dBuV/m	dBuV/m	dB	cm	degree
1		2483.500	61.13	-0.90	60.23	74.00	-13.77	peak	
2	*	2483.500	53.55	-0.90	52.65	54.00	-1.35	AVG	

Test Mode	TX 2480 MHz_2Mbps	Polarization	Horizontal
-----------	-------------------	--------------	------------

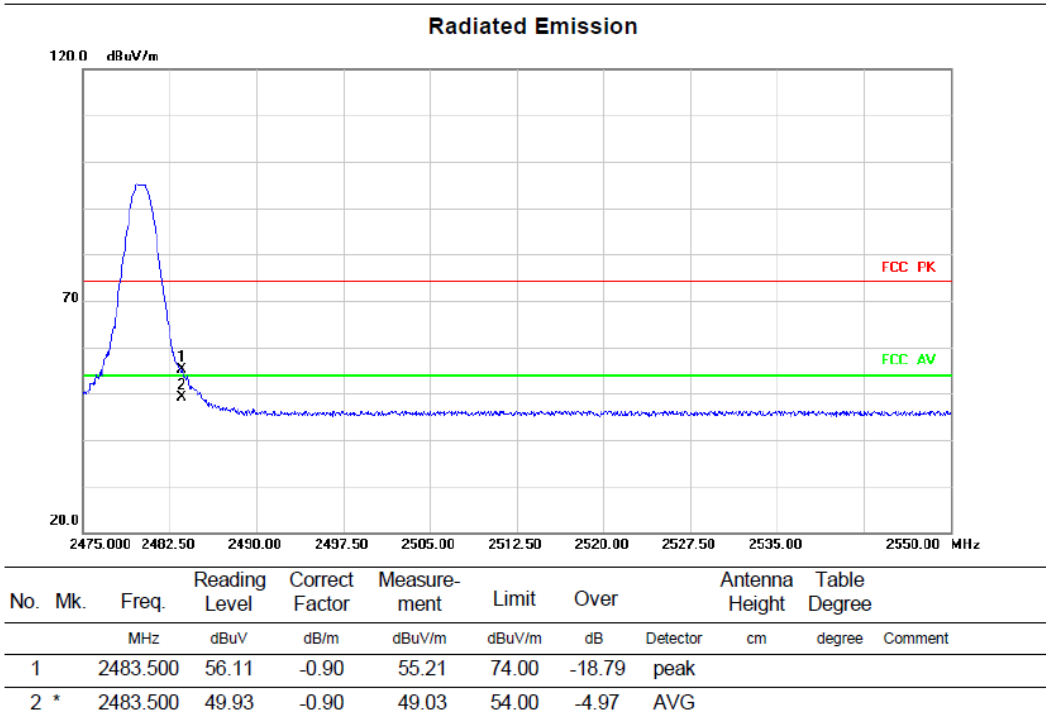
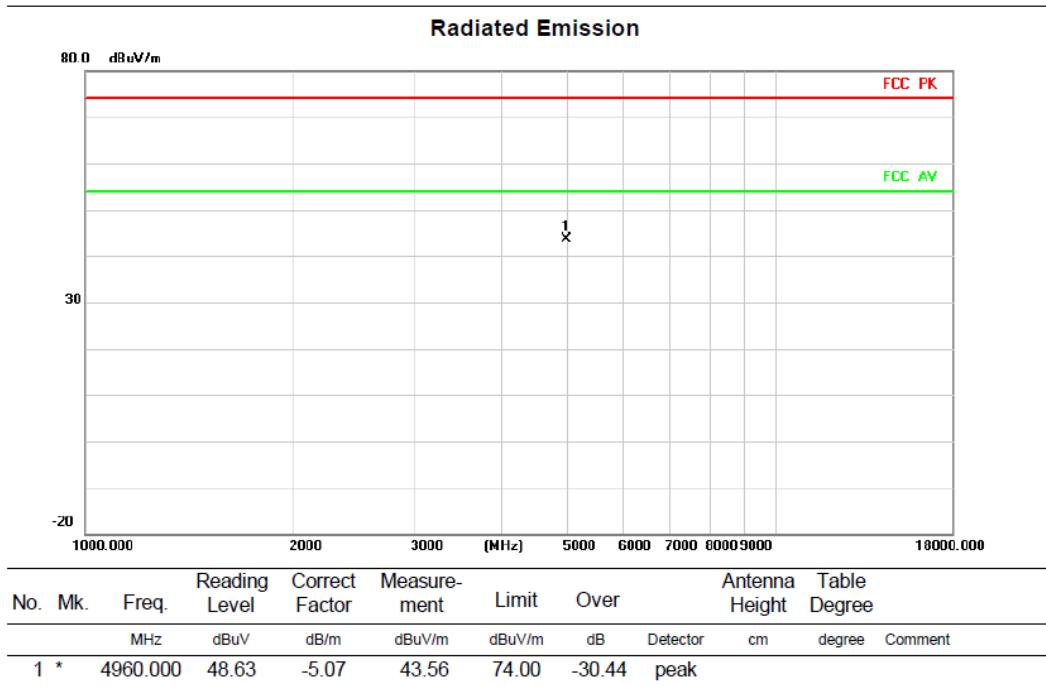

REMARKS:

(1) Measurement Value = Reading Level + Correct Factor.

(2) Margin Level = Measurement Value - Limit Value.

(3) The high frequency, which started from 18GHz to 26.5GHz, was pre-scanned and the result which was 20dB lower than the limit line was not recorded in this report.



APPENDIX E - BANDWIDTH

DTS Bandwidth

Test Mode	Antenna	Freq(MHz)	DTS BW [MHz]	FL[MHz]	FH[MHz]	Limit[MHz]	Verdict
BLE_1M	Ant1	2402	0.764	2401.612	2402.376	0.5	PASS
		2440	0.780	2439.608	2440.388	0.5	PASS
		2480	0.764	2479.604	2480.368	0.5	PASS
BLE_2M	Ant1	2402	1.340	2401.328	2402.668	0.5	PASS
		2440	1.348	2439.328	2440.676	0.5	PASS
		2480	1.348	2479.320	2480.668	0.5	PASS

Test Graphs







Occupied Channel Bandwidth

Test Mode	Antenna	Freq(MHz)	OCB [MHz]	FL[MHz]	FH[MHz]	Limit[MHz]	Verdict
BLE_1M	Ant1	2402	1.1451	2401.4195	2402.5646	---	---
		2440	1.1484	2439.4176	2440.5660	---	---
		2480	1.1526	2479.4149	2480.5675	---	---
BLE_2M	Ant1	2402	2.3047	2400.8521	2403.1568	---	---
		2440	2.3285	2438.8282	2441.1567	---	---
		2480	2.3900	2478.8103	2481.2003	---	---

Test Graphs

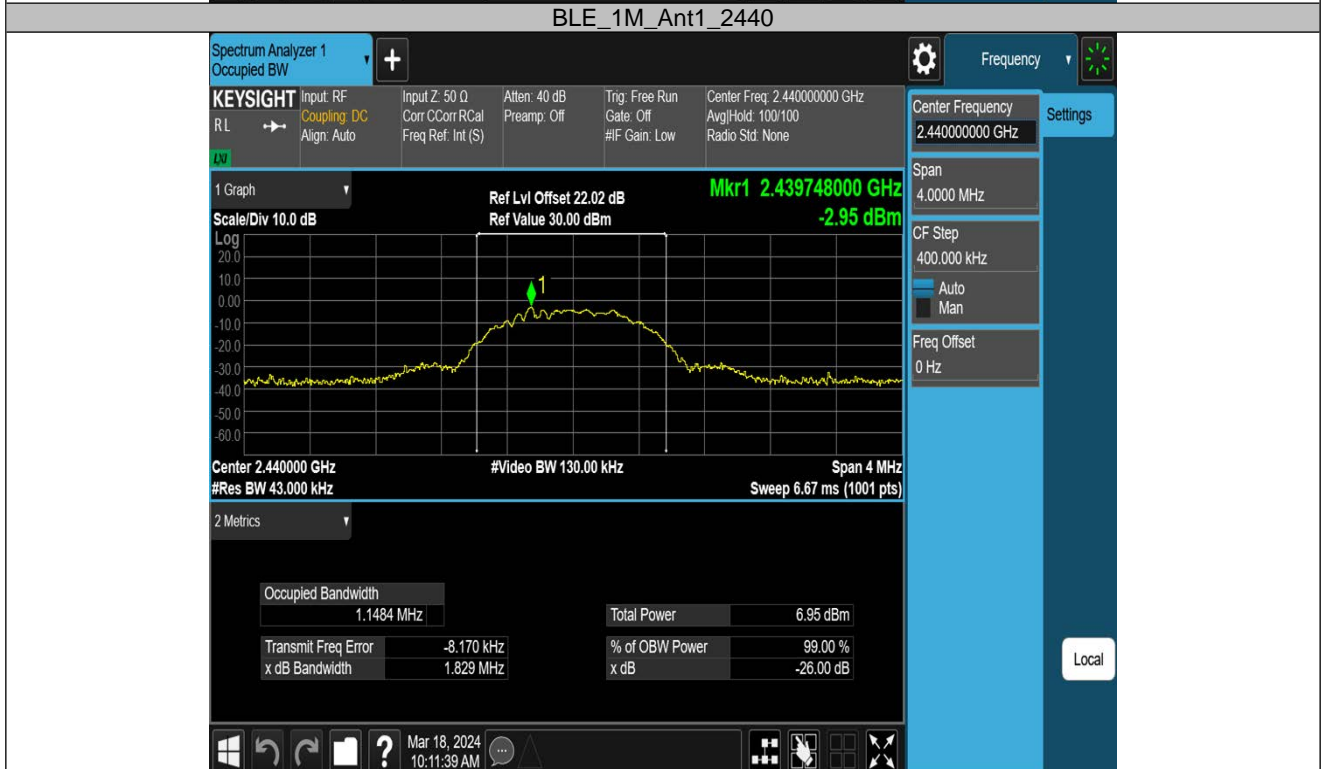







APPENDIX F - MAXIMUM OUTPUT POWER

Test Mode	Antenna	Freq(MHz)	Conducted Peak Power[dBm]	Conducted Limit[dBm]	Verdict
BLE_1M	Ant1	2402	1.77	≤30	PASS
		2440	1.42	≤30	PASS
		2480	0.13	≤30	PASS
BLE_2M	Ant1	2402	-2.52	≤30	PASS
		2440	-2.46	≤30	PASS
		2480	-3.09	≤30	PASS

Test Graphs Peak

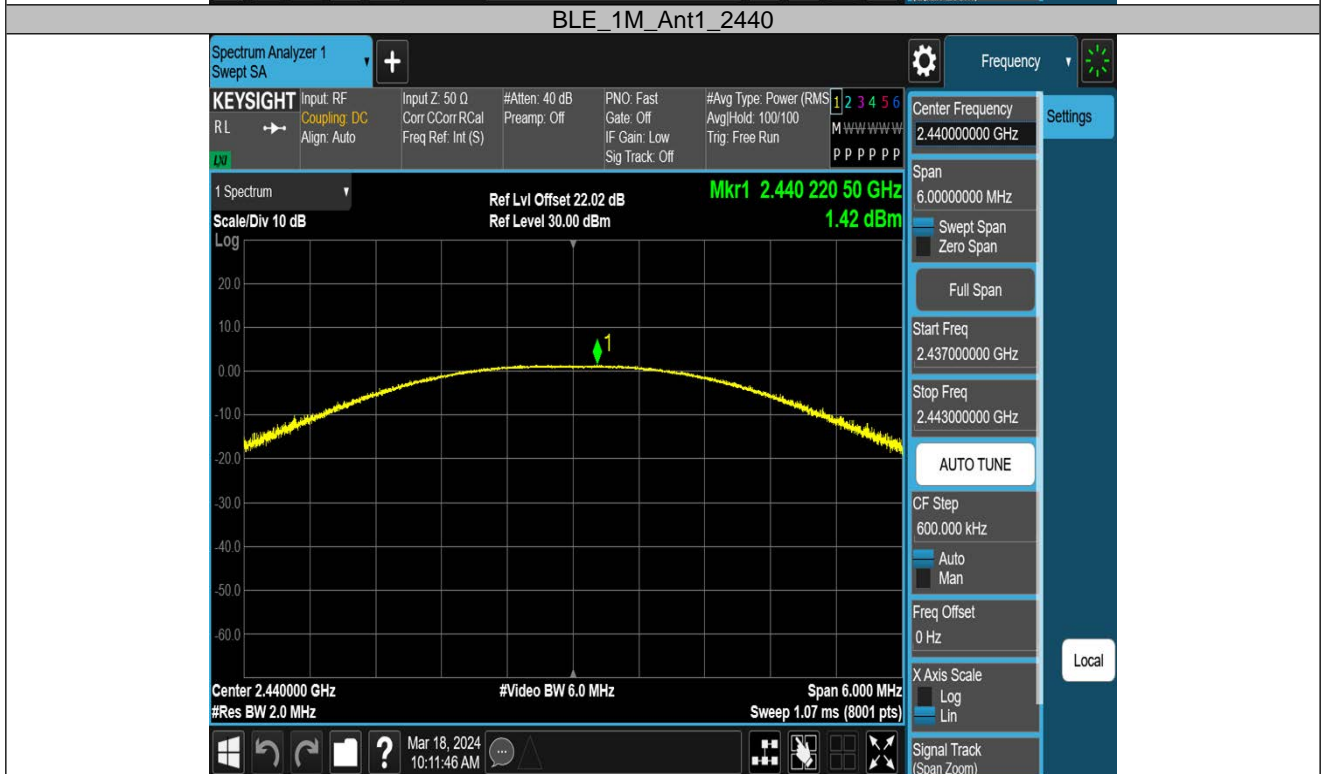

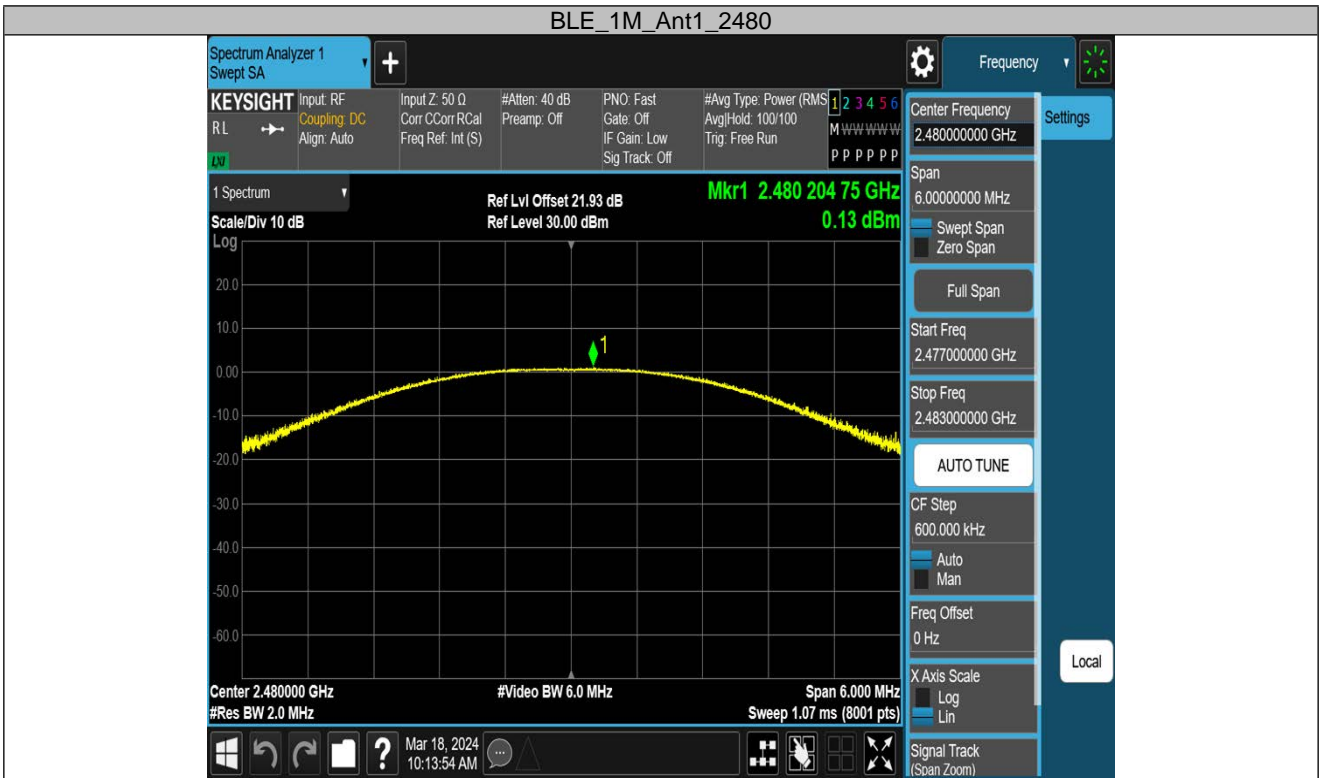

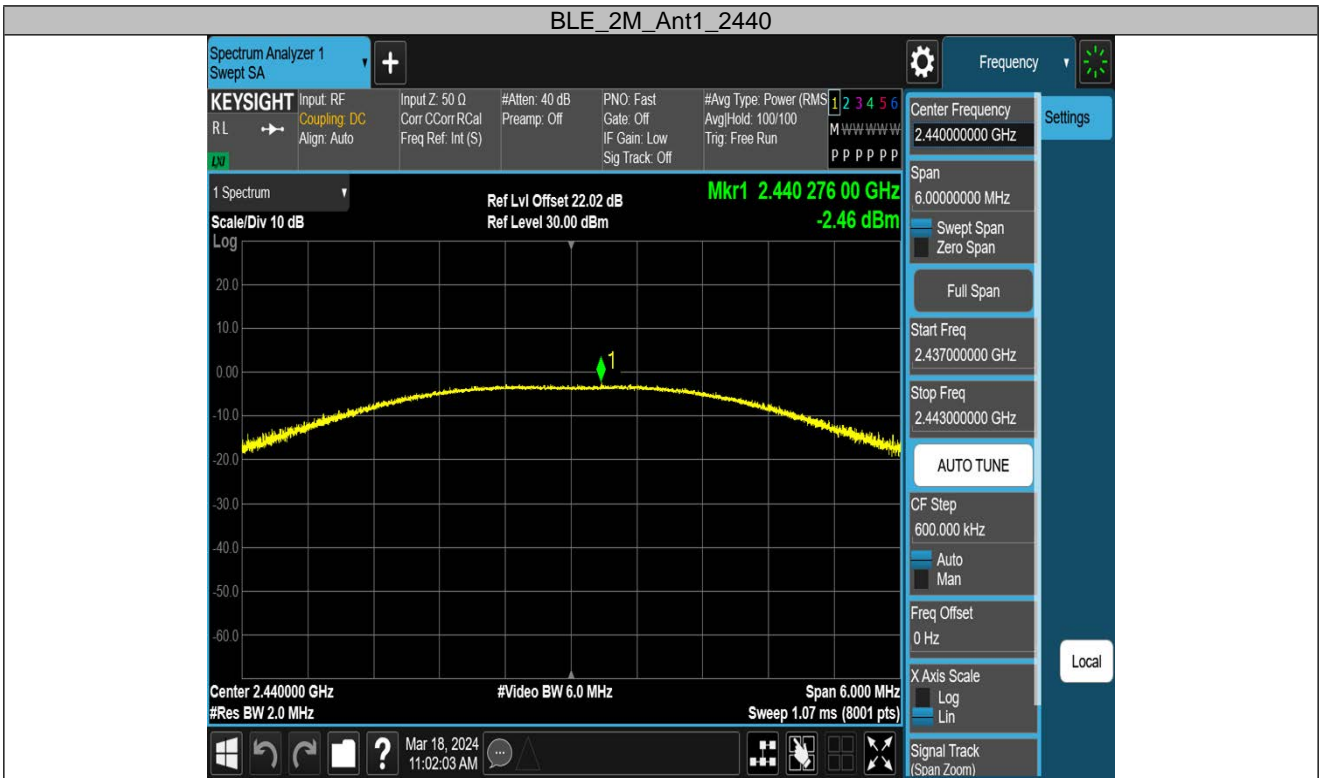



APPENDIX G - CONDUCTED SPURIOUS EMISSION

Conducted Spurious Emission

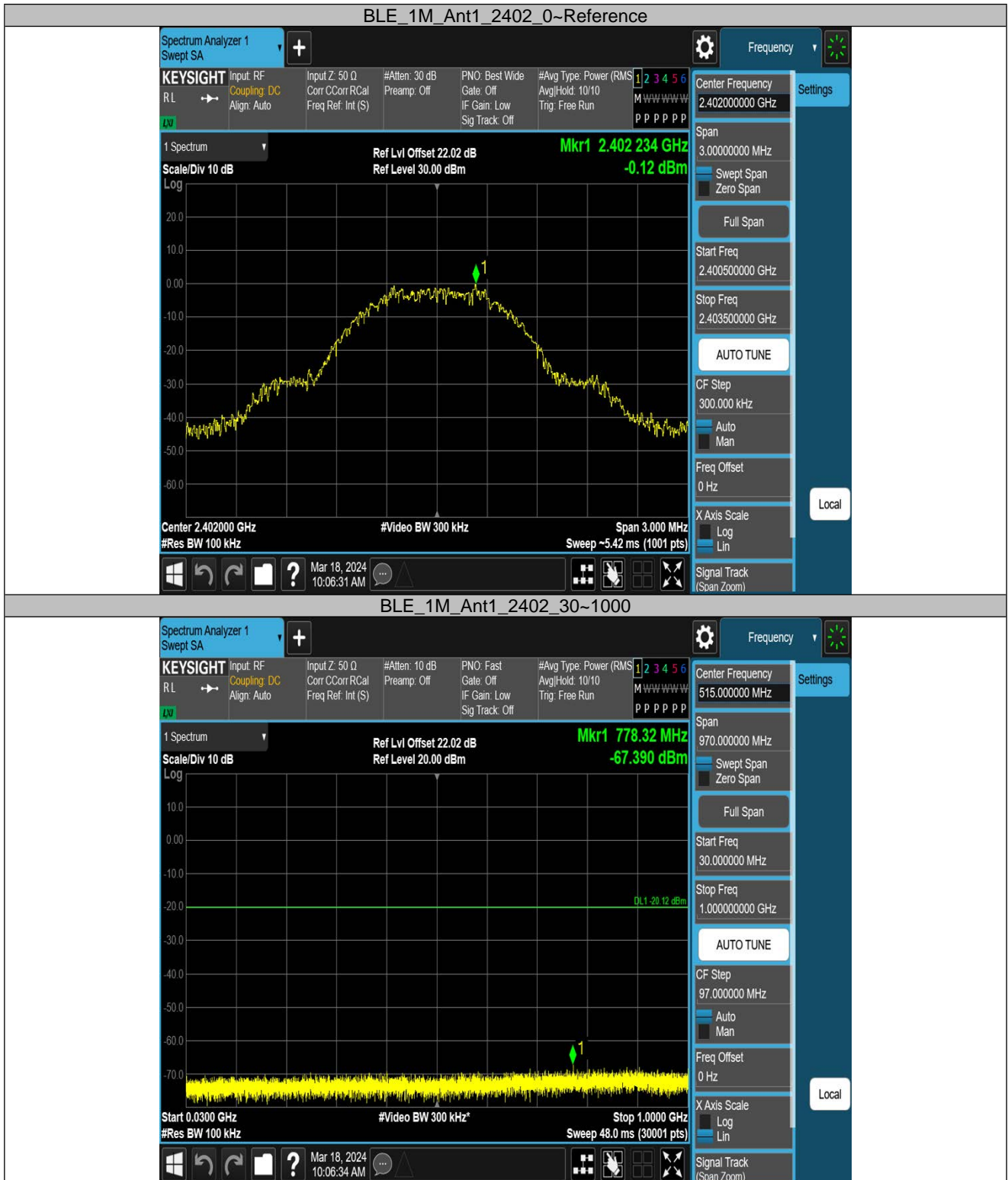

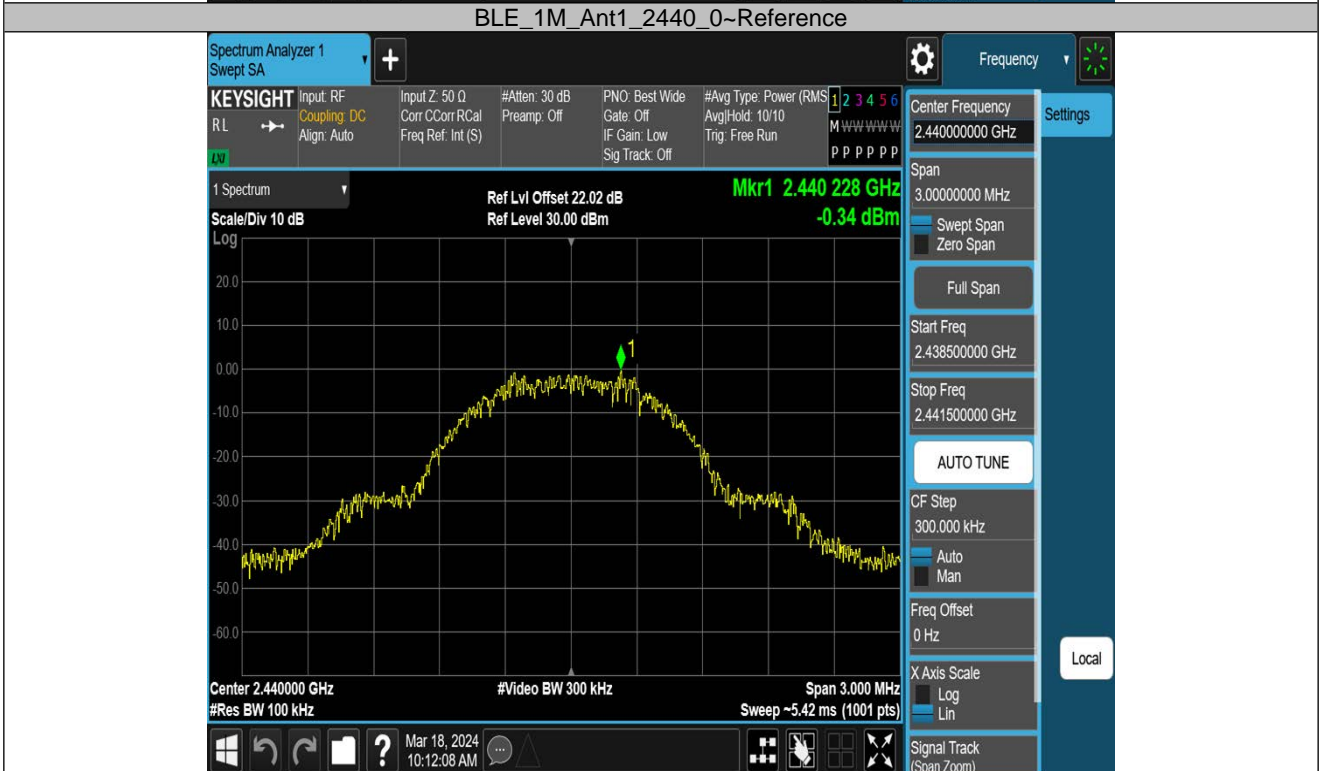
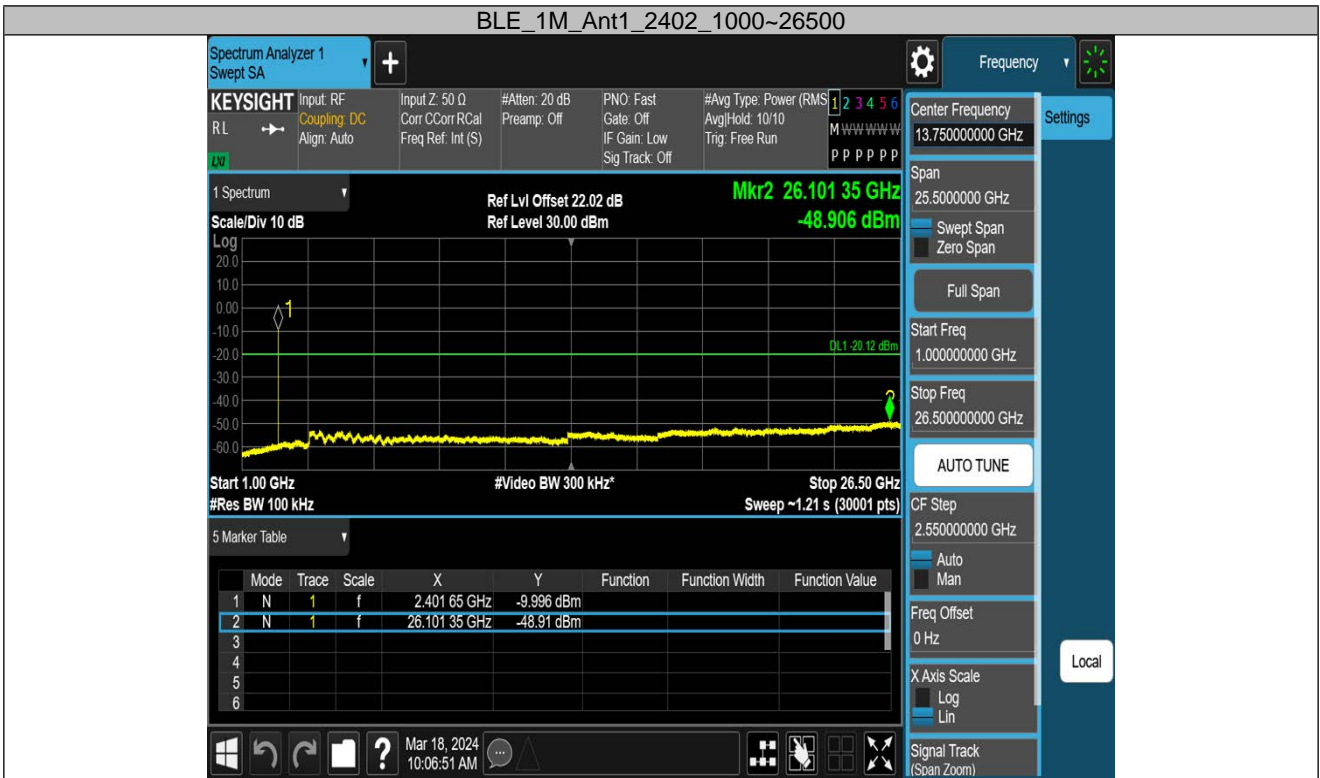

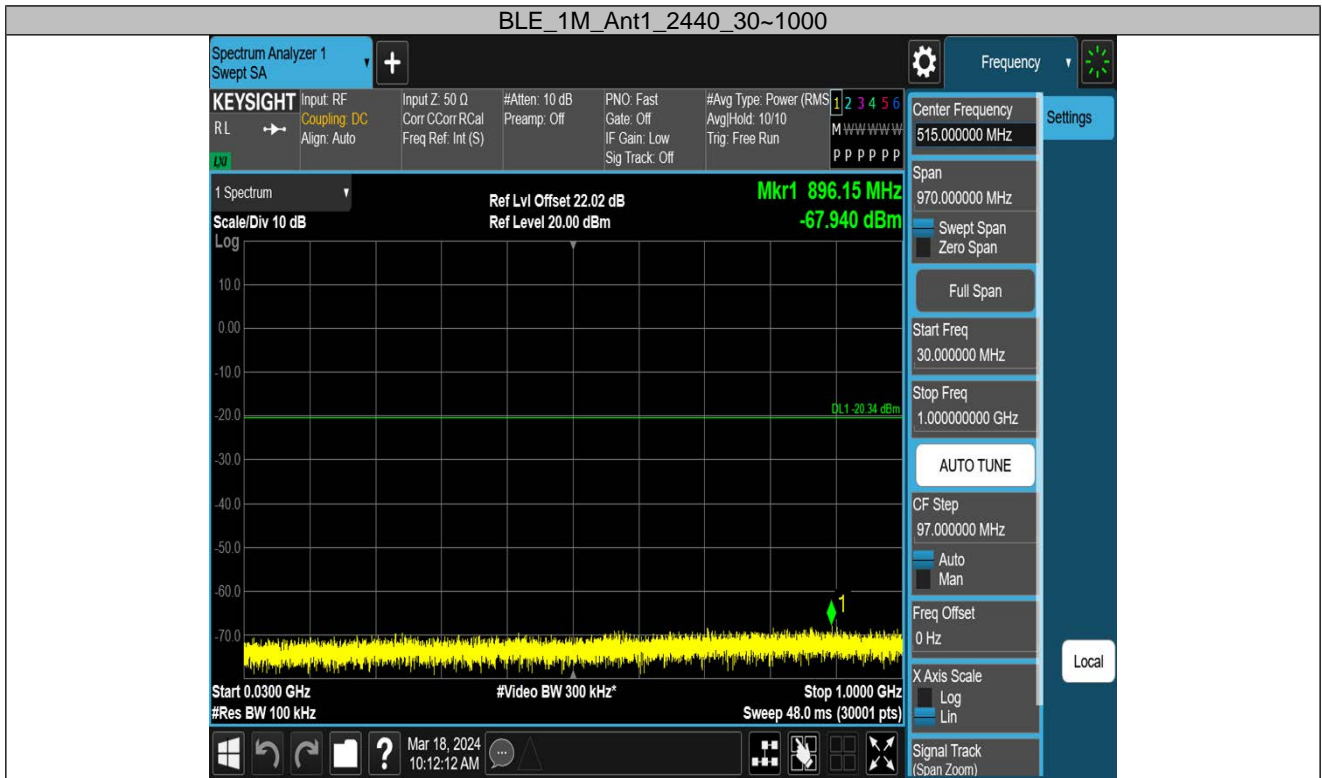

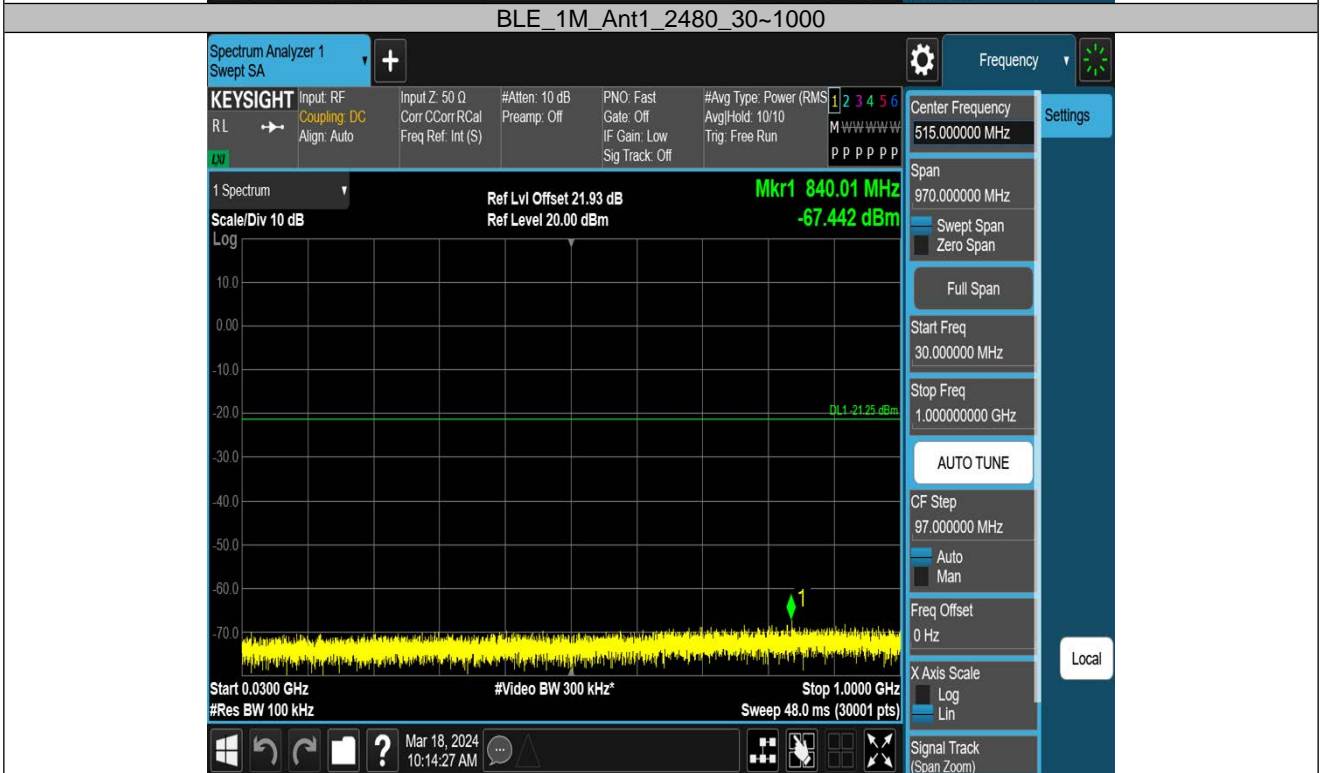
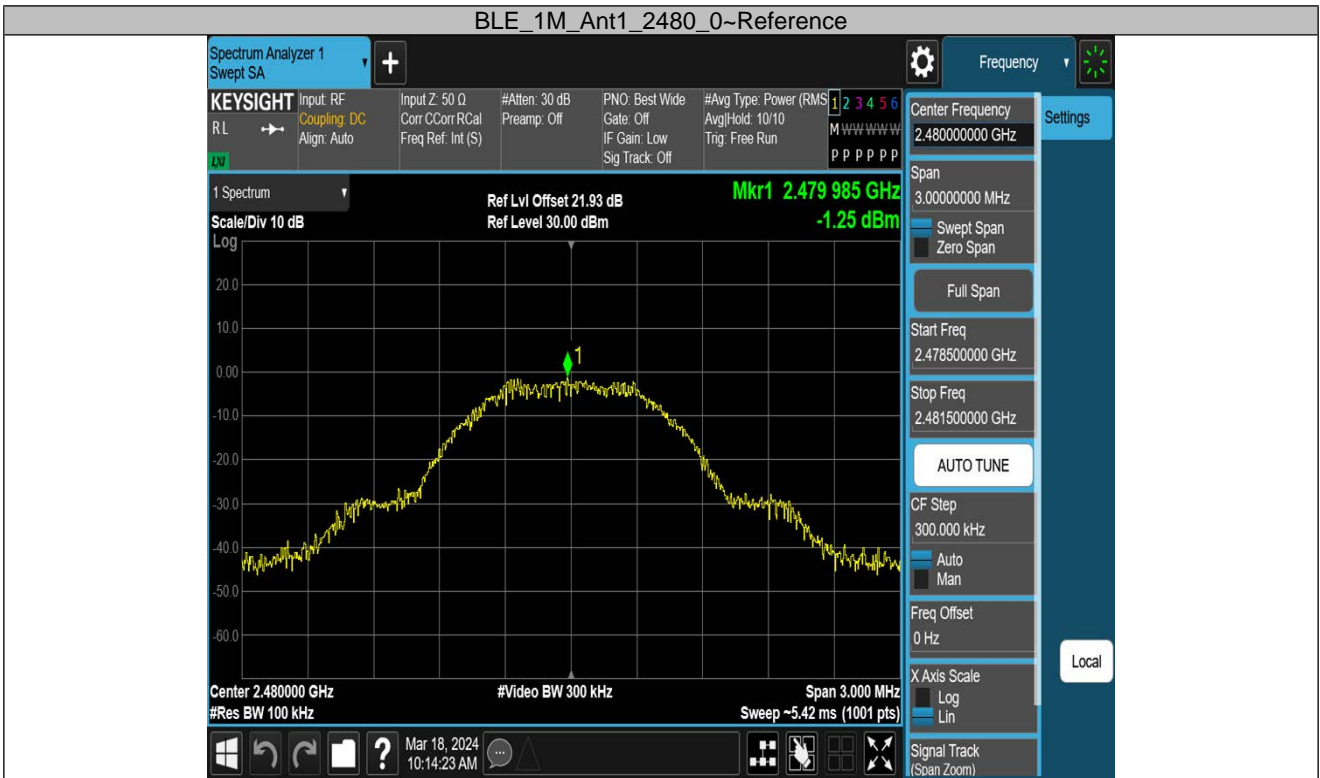

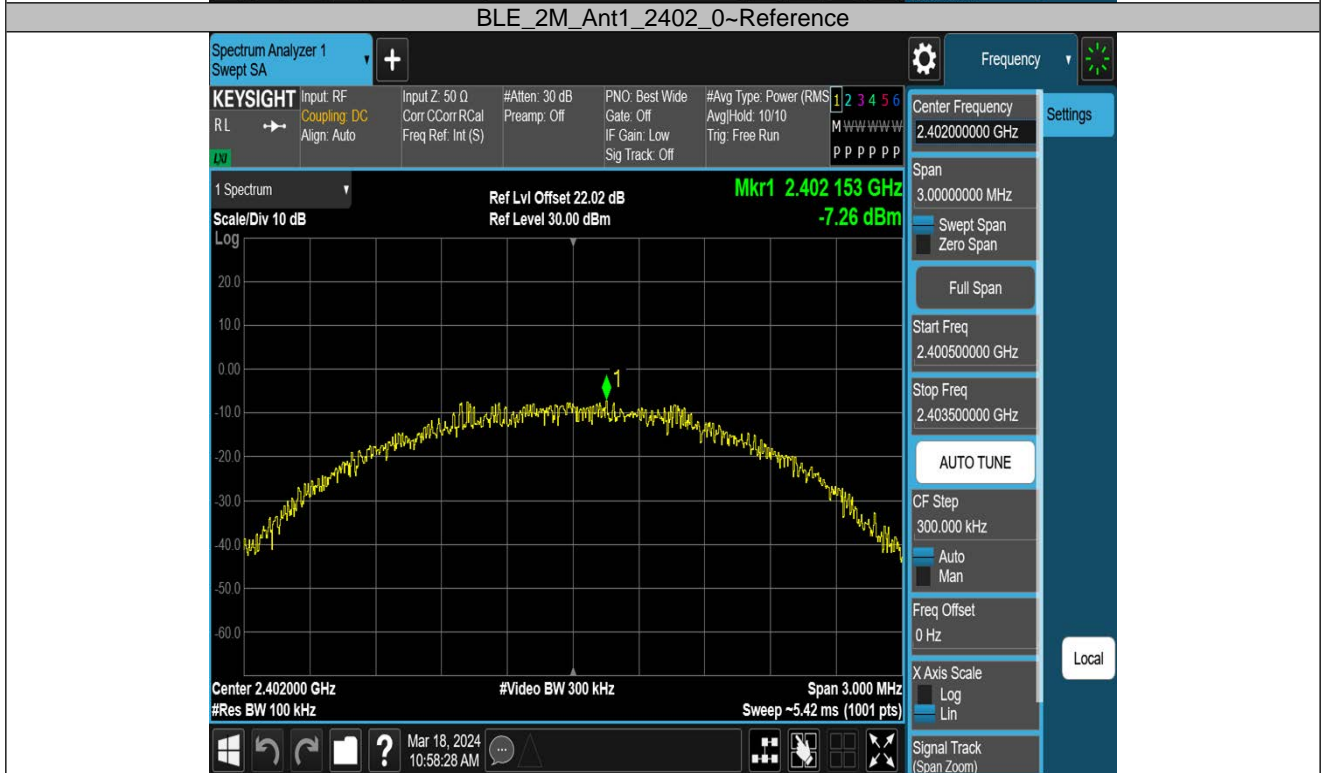

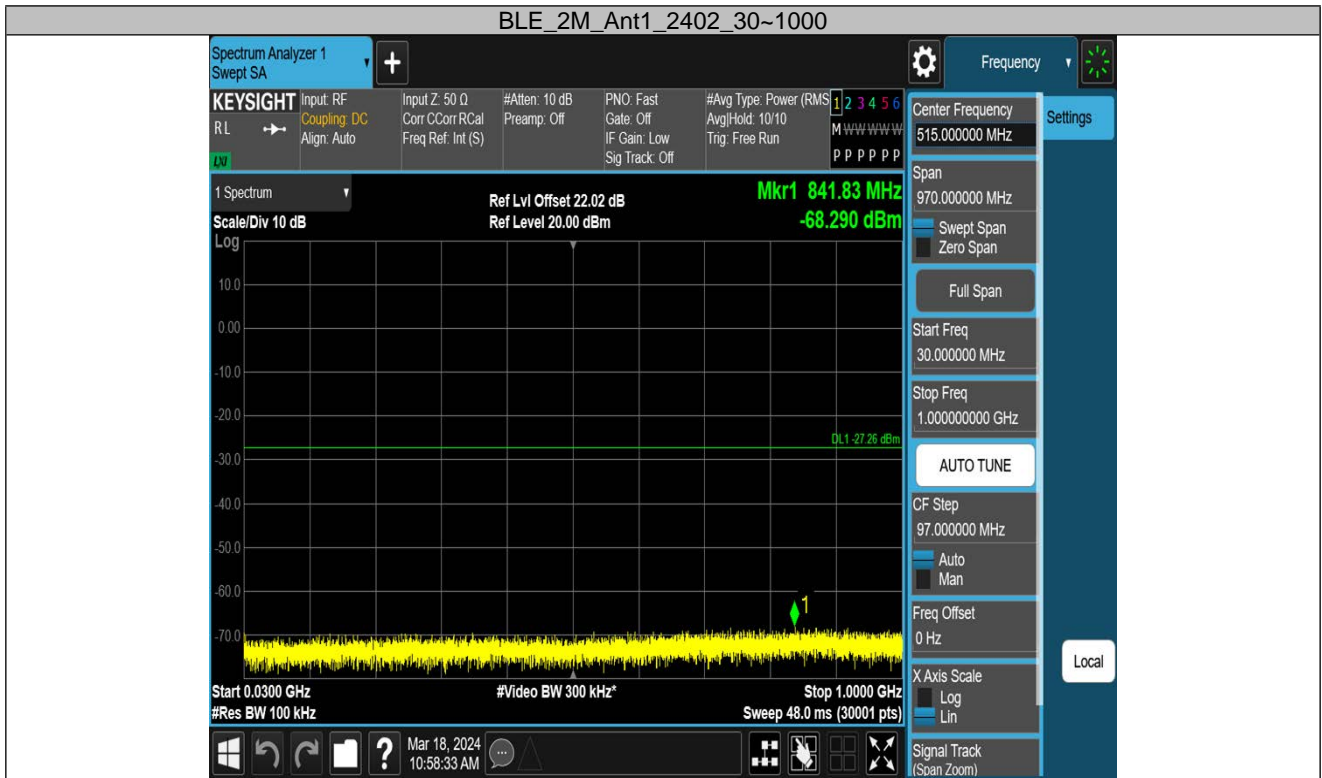

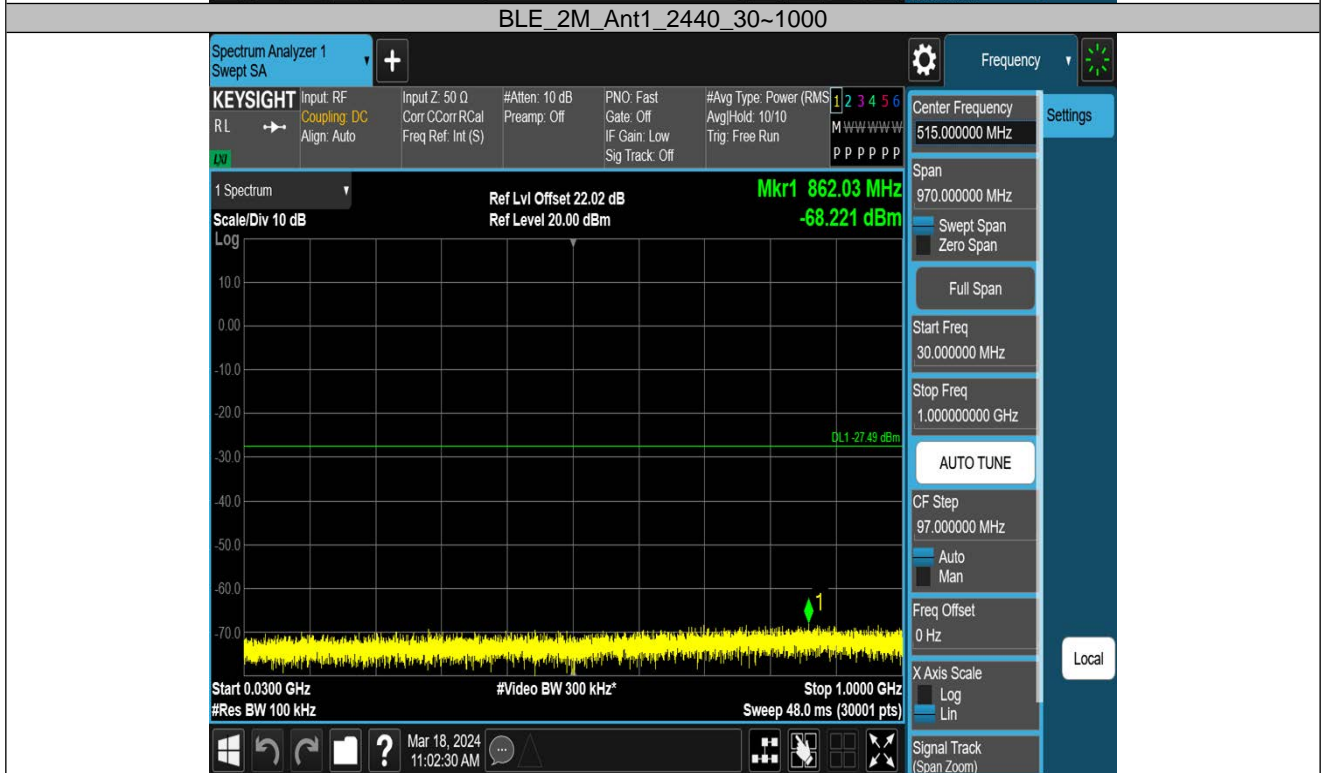
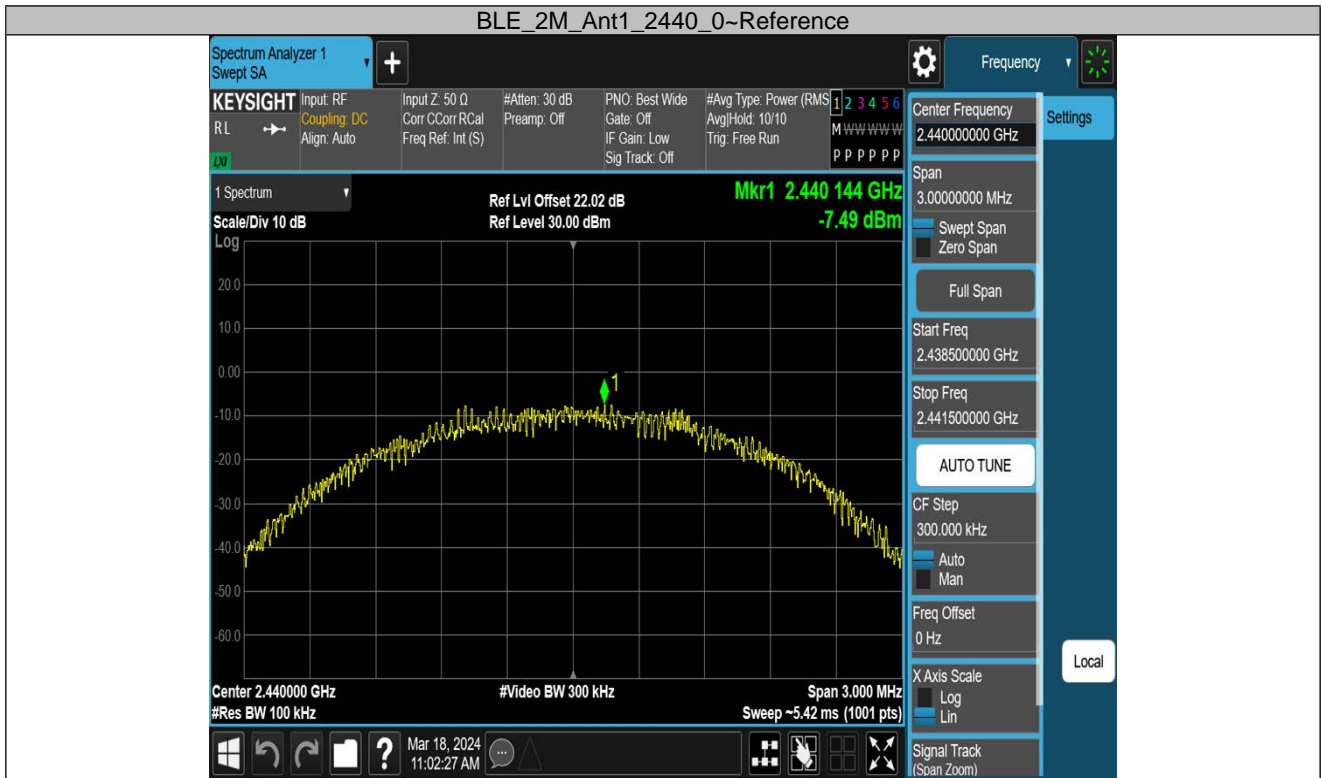

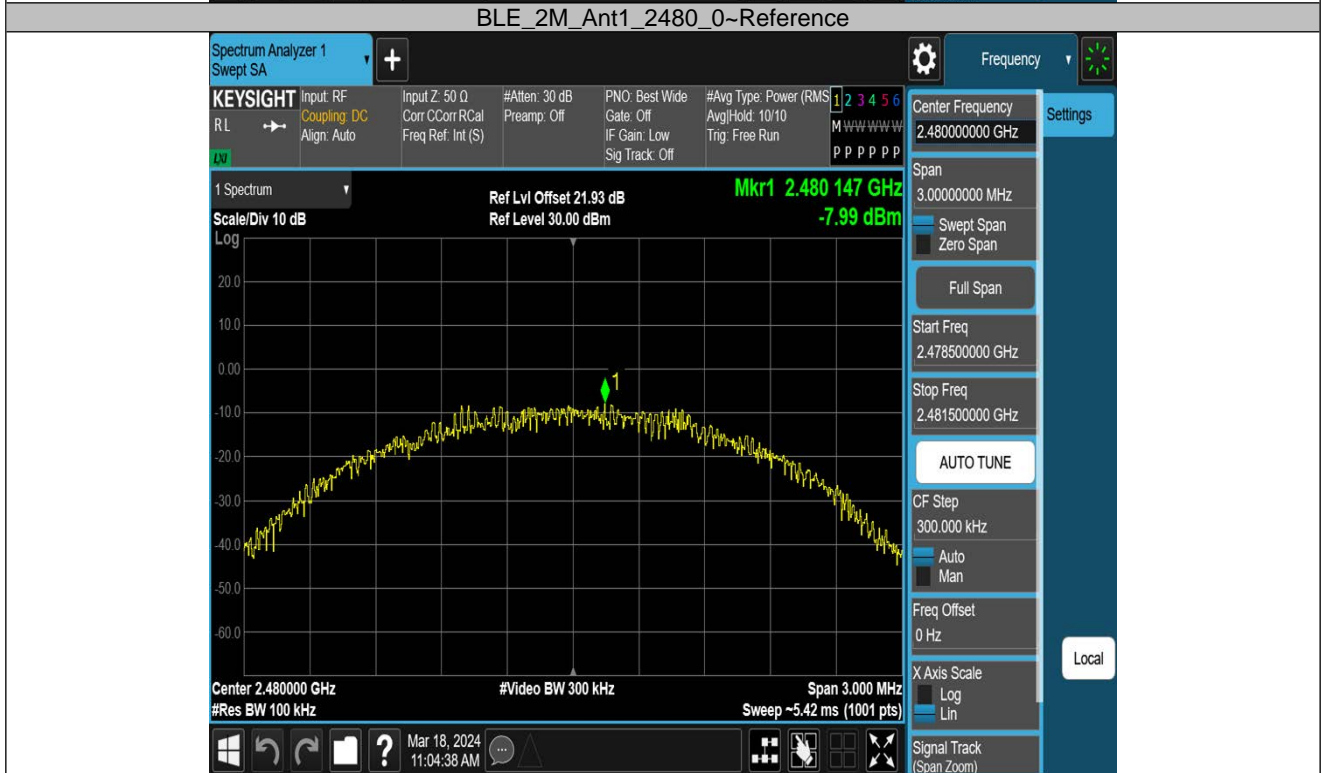
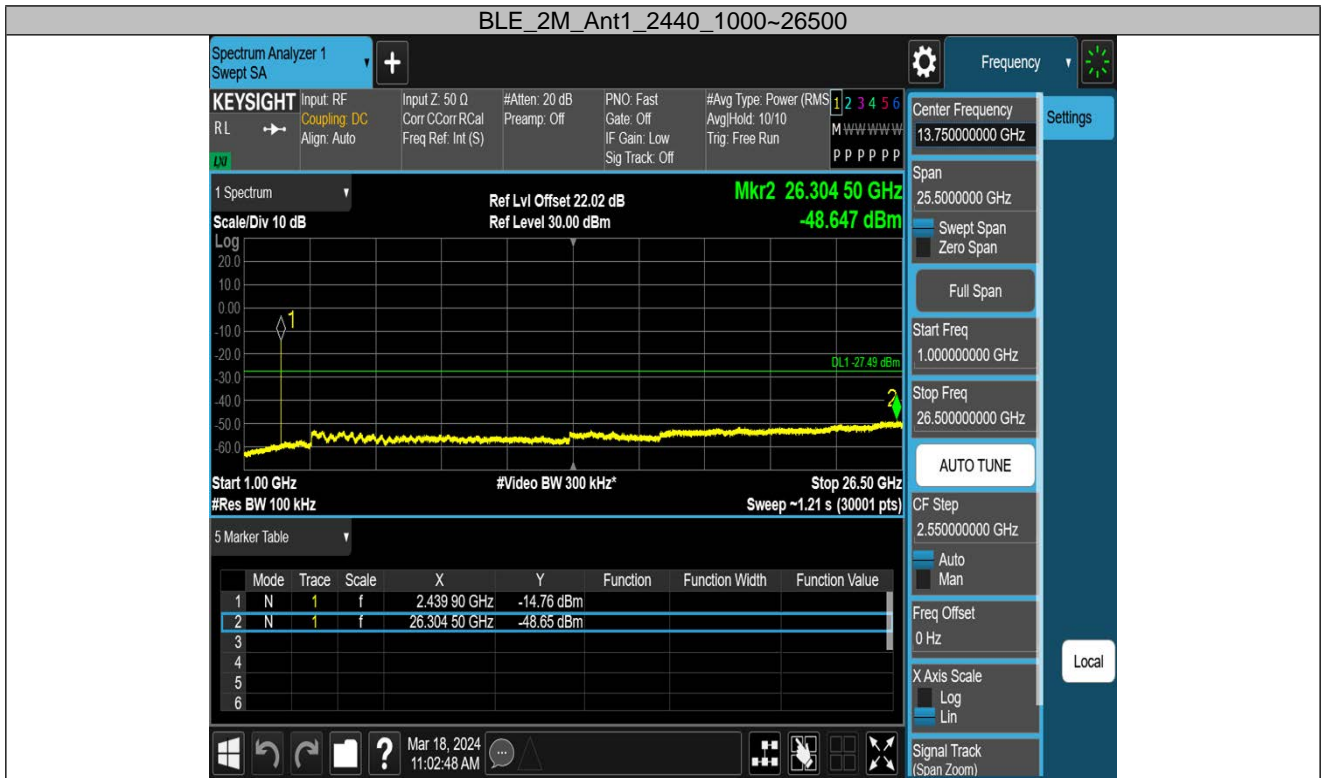

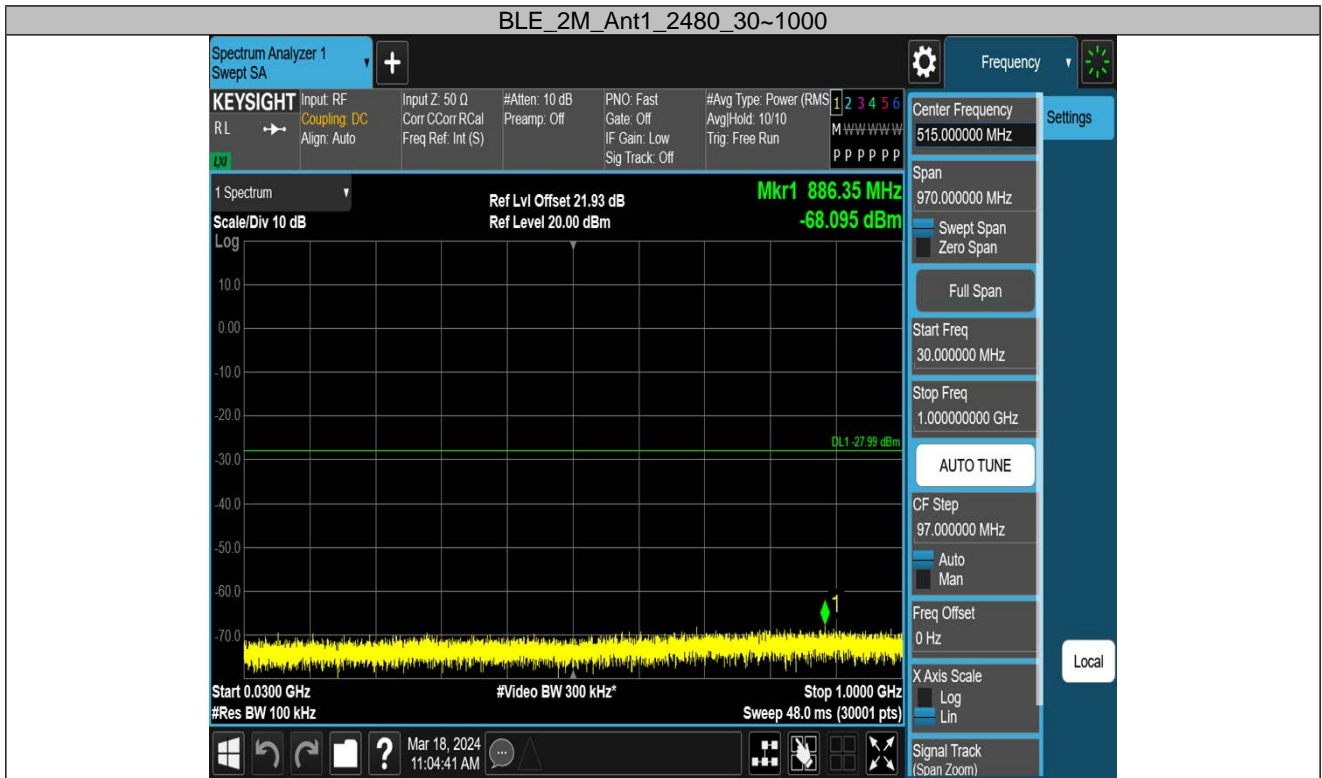

Band edge measurements

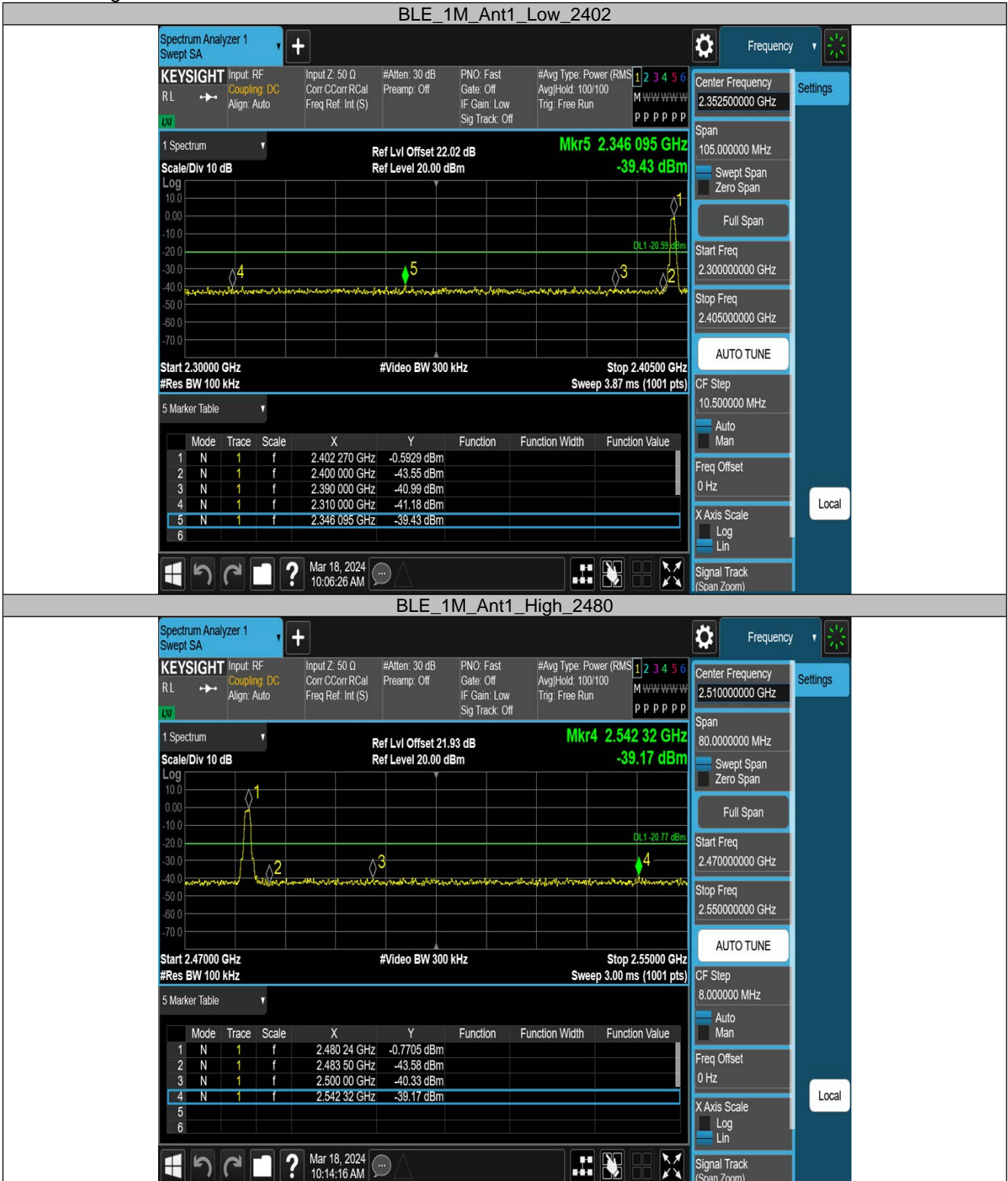

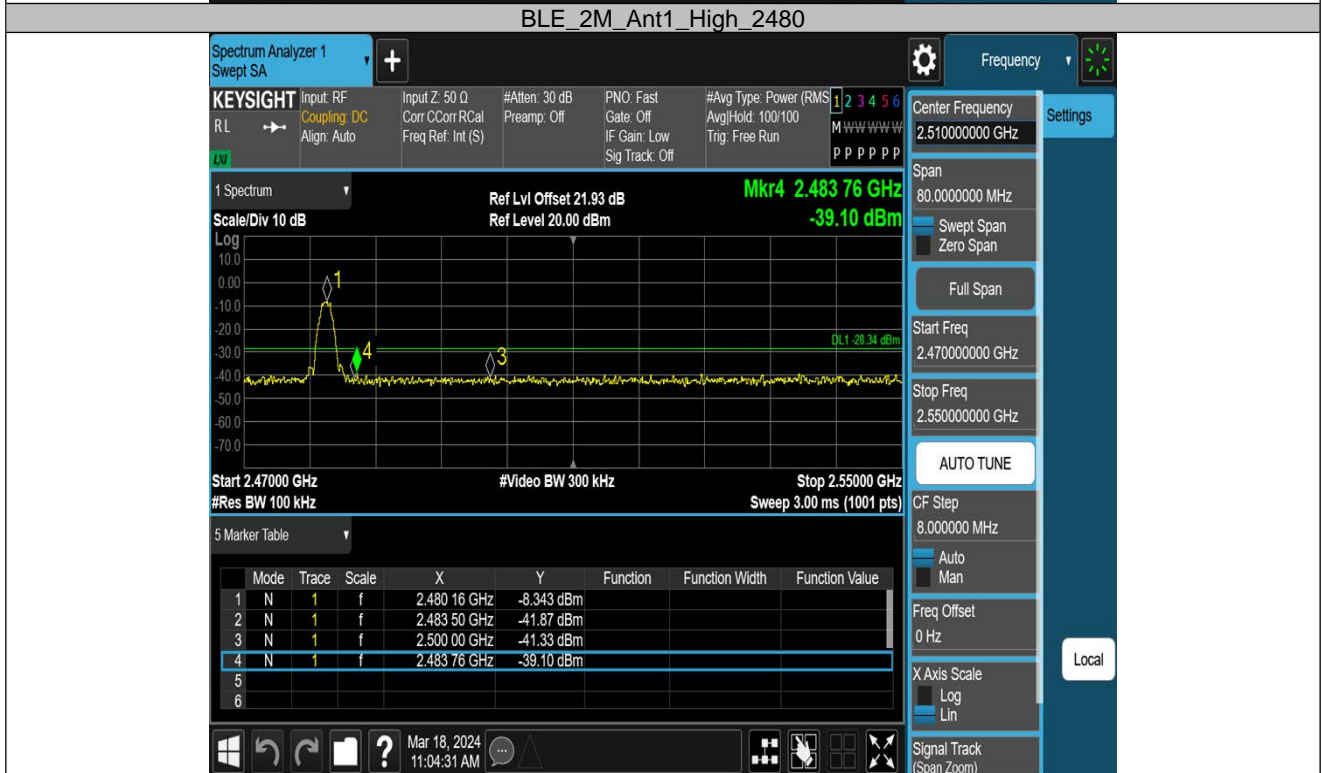
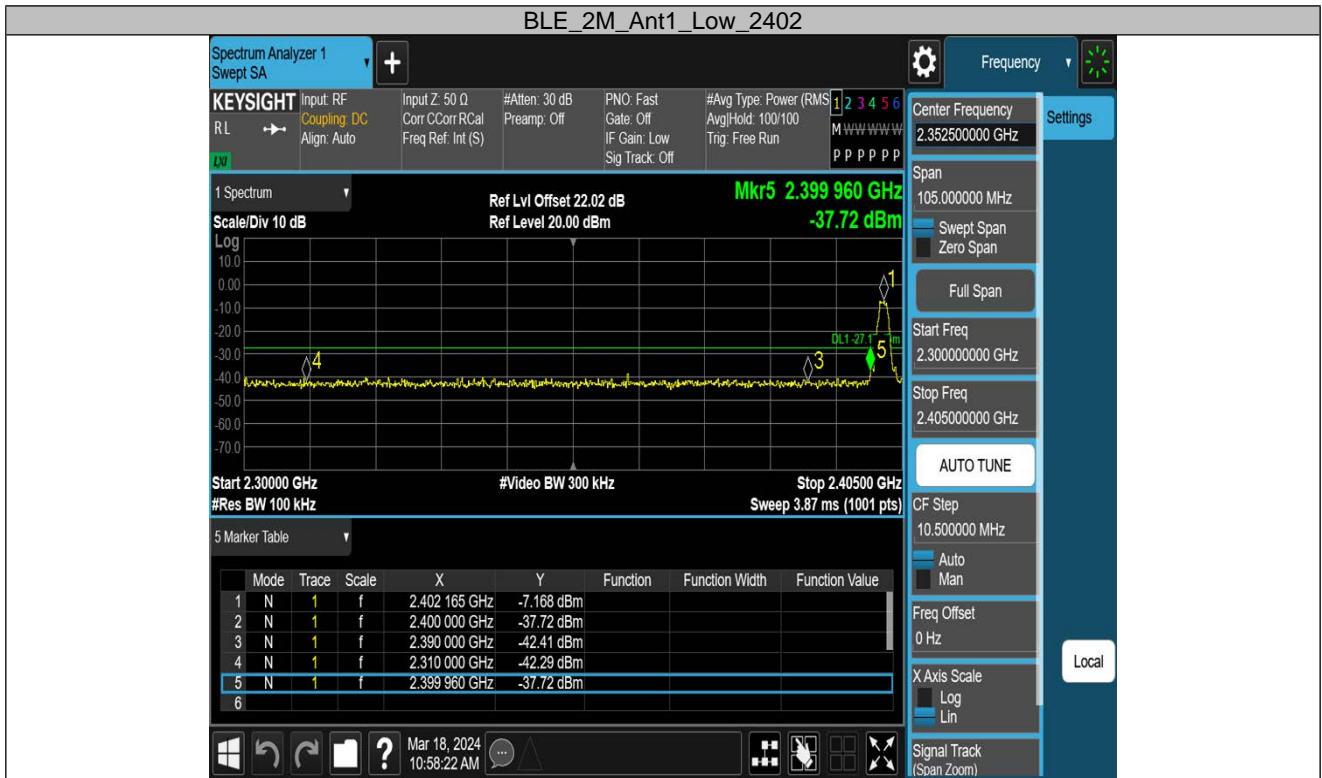



APPENDIX H - POWER SPECTRAL DENSITY

Test Mode	Antenna	Freq(MHz)	Result[dBm/3kHz]	Limit[dBm/3kHz]	Verdict
BLE_1M	Ant1	2402	-17.67	≤8.00	PASS
		2440	-17.69	≤8.00	PASS
		2480	-18.28	≤8.00	PASS
BLE_2M	Ant1	2402	-21.82	≤8.00	PASS
		2440	-22.00	≤8.00	PASS
		2480	-22.59	≤8.00	PASS

Test Graphs

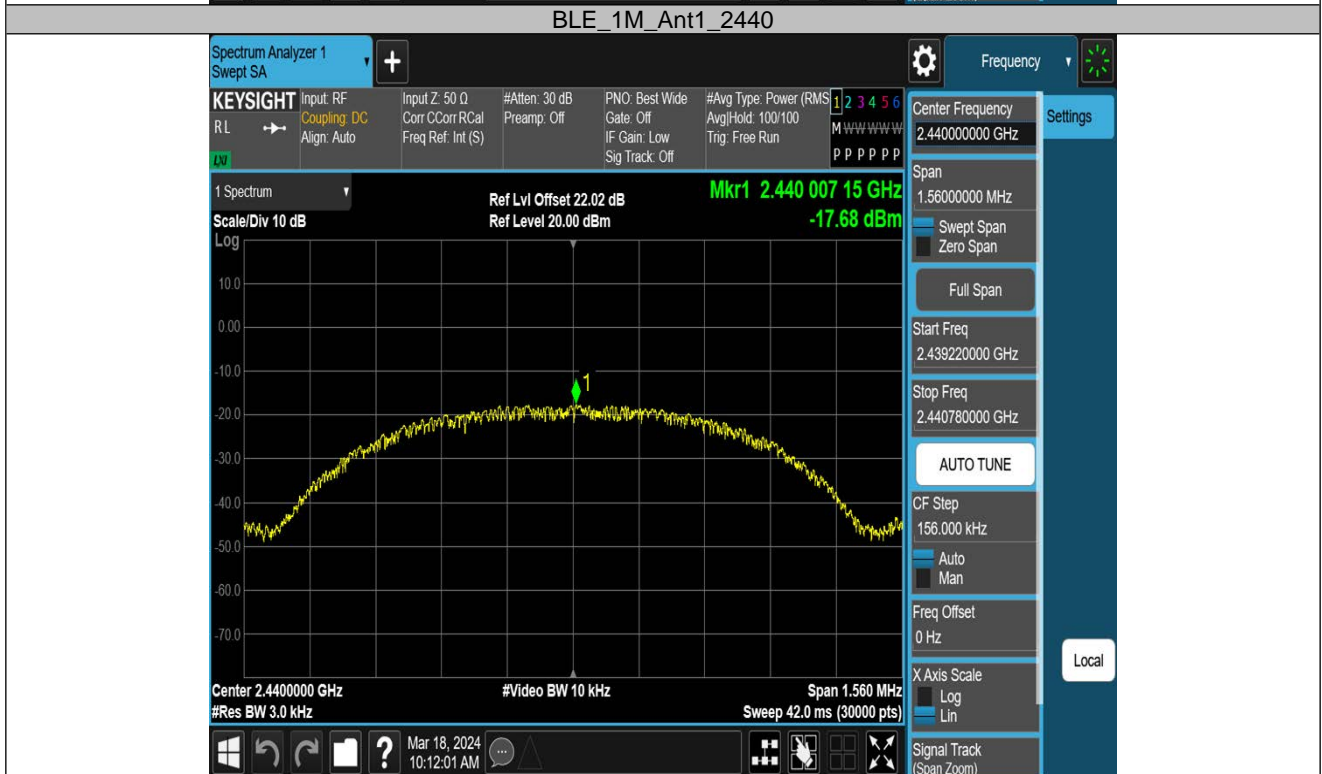
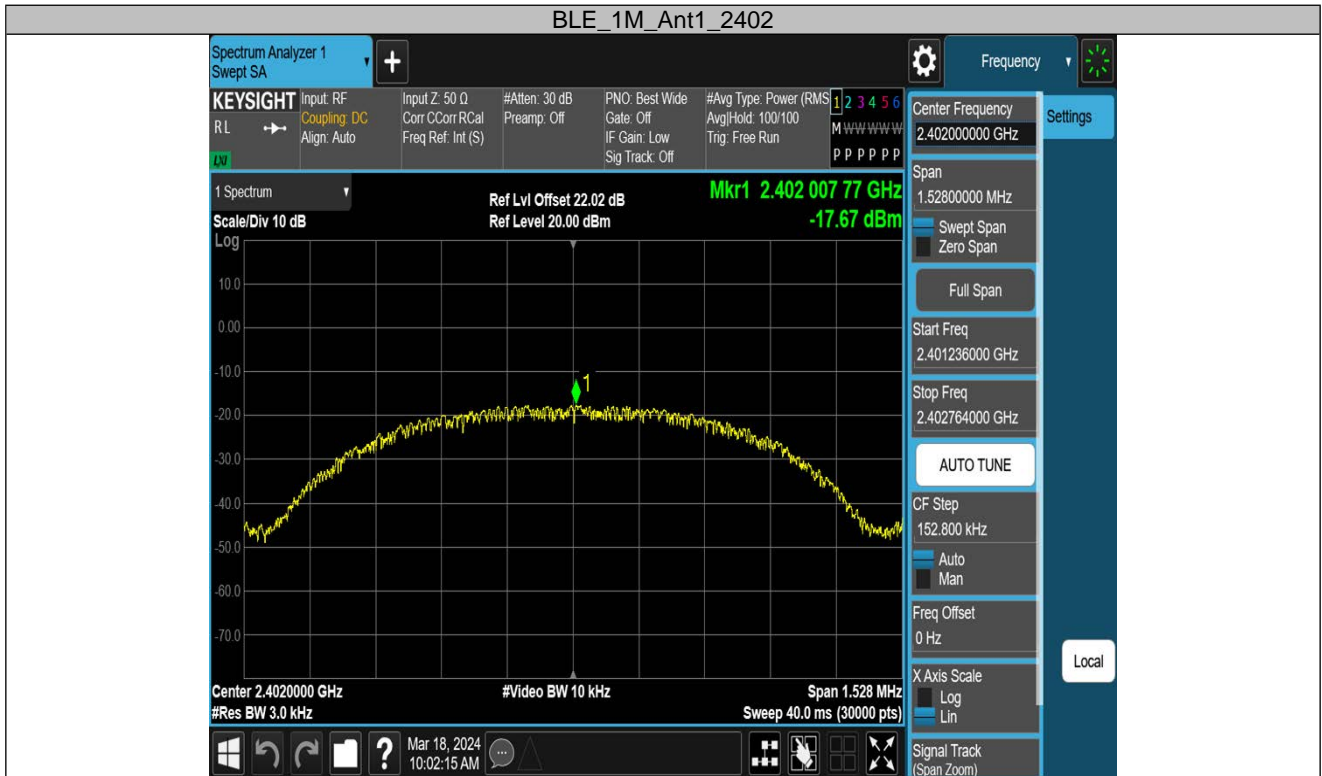

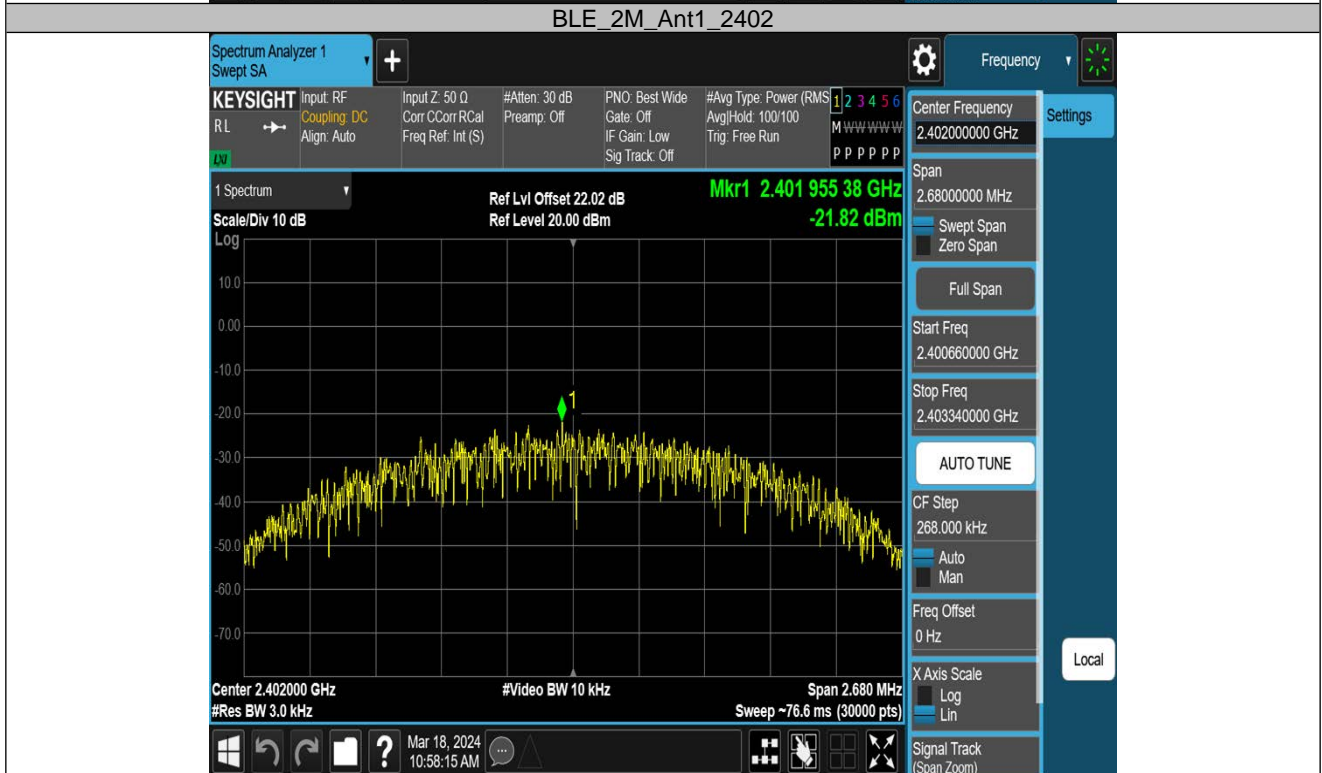

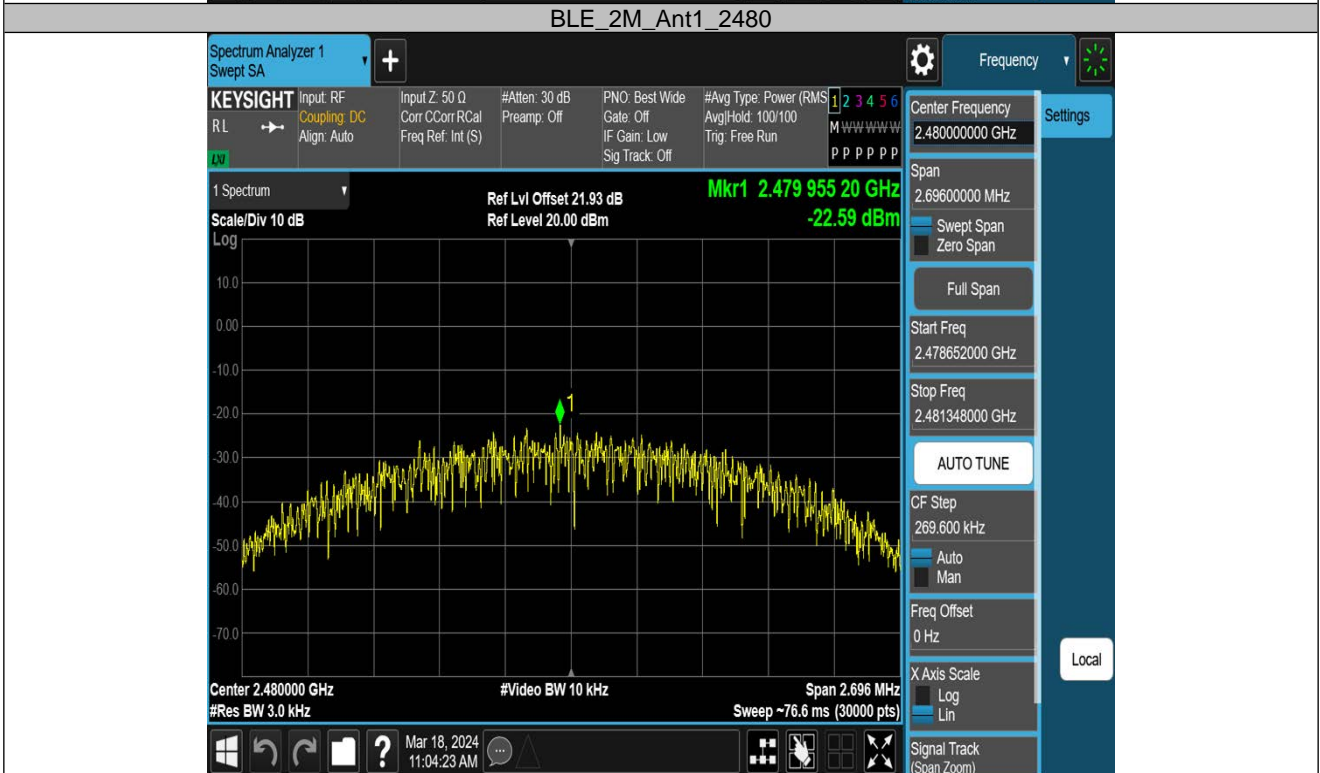
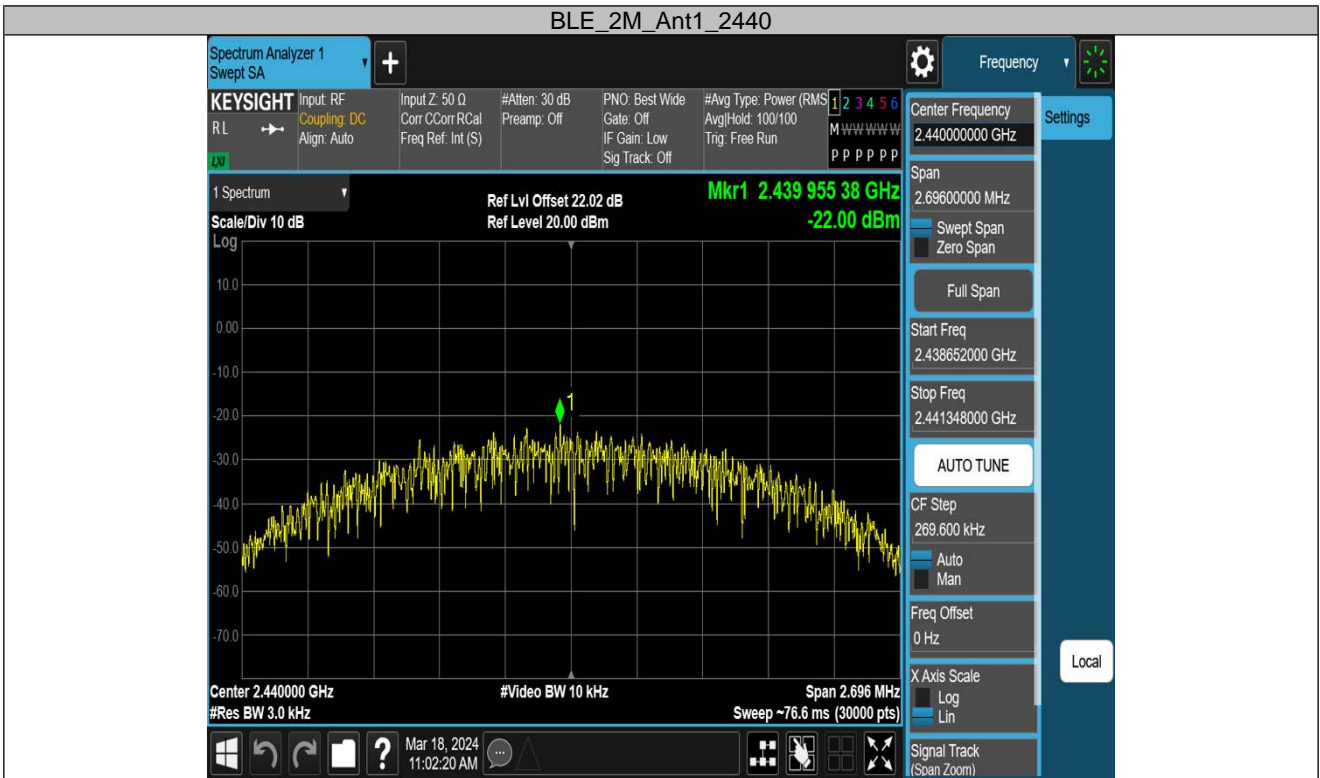

Statement

1. The report is invalid without the official seal or special seal of Shenzhen Haiyun Standard Technology Co., Ltd. (hereinafter referred to as the unit).
2. The report is invalid without the signature of the approver.
3. The report is invalid if altered arbitrarily.
4. The report shall not be partially copied without the written approval of the unit.
5. The reported test results are only valid for the tested samples.
6. If there is any objection to the test report, it shall be submitted to the test unit within 15 days from the date of receiving the report, and the overdue shall not be accepted.

Shenzhen Haiyun Standard Technology Co., Ltd.

Address: Room 110, 111, 112, 113, 115, 116, Block B, Jinyuan Business Building, No. 302, Xixiang Avenue, Labor Community, Xixiang Street, Baoan District, Shenzhen, China

Tel: 0755-26024411

Email: service@hy-lab.cn

End of Test Report