



Prüfbericht-Nr.: <i>Test report no.:</i>	CN24WWB5 001	Auftrags-Nr.: <i>Order no.:</i>	48227570	Seite 1 von 31 Page 1 of 31
Kunden-Referenz-Nr.: <i>Client reference no.:</i>	N/A	Auftragsdatum: <i>Order date:</i>	2023-09-01	
Auftraggeber: <i>Client:</i>	Daiso Industries Co., Ltd. 1-4-14 Saijoyoshiyukihigashi, Higashihiroshima-shi, Hiroshima 739-8501, Japan			
Prüfgegenstand: <i>Test item:</i>	True Wireless Earphone			
Bezeichnung / Typ-Nr.: <i>Identification / Type no.:</i>	TWS003			
Auftrags-Inhalt: <i>Order content:</i>	FCC Part 15C Test report (BT)			
Prüfgrundlage: <i>Test specification:</i>	FCC 47CFR Part 15: Subpart C Section 15.247			
Wareneingangsdatum: <i>Date of sample receipt:</i>	2023-09-15			
Prüfmuster-Nr.: <i>Test sample no.:</i>	A003563327-007,008 A003563327-009			
Prüfzeitraum: <i>Testing period:</i>	2024-01-02 - 2024-01-19			
Ort der Prüfung: <i>Place of testing:</i>	EMC/RF Taipei Testing Site			
Prüflaboratorium: <i>Testing laboratory:</i>	Taipei Testing Laboratories			
Prüfergebnis*: <i>Test result*:</i>	Pass			
überprüft von: <i>compiled by:</i>	 Ryan Chen	genehmigt von: <i>authorized by:</i>	 Brenda Chen	
Datum: <i>Date:</i>	2024-01-22	Ausstellungsdatum: <i>Issue date:</i>	2024-01-22	
Stellung / Position:	Senior Project Manager	Stellung / Position:	Senior Project Manager	
Sonstiges / Other:				
Zustand des Prüfgegenstandes bei Anlieferung: <i>Condition of the test item at delivery:</i>	Prüfmuster vollständig und unbeschädigt <i>Test item complete and undamaged</i>			
* Legende:	1 = sehr gut P(ass) = entspricht o.g. Prüfgrundlage(n)	2 = gut F(ail) = entspricht nicht o.g. Prüfgrundlage(n)	3 = befriedigend N/A = nicht anwendbar	4 = ausreichend N/T = nicht getestet
* Legend:	1 = very good P(ass) = passed a.m. test specification(s)	2 = good F(ail) = failed a.m. test specification(s)	3 = satisfactory N/A = not applicable	4 = sufficient N/T = not tested
Dieser Prüfbericht bezieht sich nur auf das o.g. Prüfmuster und darf ohne Genehmigung der Prüfstelle nicht auszugsweise vervielfältigt werden. Dieser Bericht berechtigt nicht zur Verwendung eines Prüfzeichens. <i>This test report only relates to the a. m. test sample. Without permission of the test center this test report is not permitted to be duplicated in extracts. This test report does not entitle to carry any test mark.</i>				

Prüfbericht-Nr.:
Test report no.:

CN24WWB5 001

Seite 2 von 31
Page 2 of 31

Anmerkungen
Remarks

1	<p>Alle eingesetzten Prüfmittel waren zum angegebenen Prüfzeitraum gemäß eines festgelegten Kalibrierungsprogramms unseres Prüfhauses kalibriert. Sie entsprechen den in den Prüfprogrammen hinterlegten Anforderungen. Die Rückverfolgbarkeit der eingesetzten Prüfmittel ist durch die Einhaltung der Regelungen unseres Managementsystems gegeben. Detaillierte Informationen bezüglich Prüfkonditionen, Prüfequipment und Messunsicherheiten sind im Prüflabor vorhanden und können auf Wunsch bereitgestellt werden.</p> <p><i>The equipment used during the specified testing period was calibrated according to our test laboratory calibration program. The equipment fulfils the requirements included in the relevant standards. The traceability of the test equipment used is ensured by compliance with the regulations of our management system. Detailed information regarding test conditions, equipment and measurement uncertainty is available in the test laboratory and could be provided on request.</i></p>
2	<p>Wie vertraglich vereinbart, wurde dieses Dokument nur digital unterzeichnet. Der TÜV Rheinland hat nicht überprüft, welche rechtlichen oder sonstigen diesbezüglichen Anforderungen für dieses Dokument gelten. Diese Überprüfung liegt in der Verantwortung des Benutzers dieses Dokuments. Auf Verlangen des Kunden kann der TÜV Rheinland die Gültigkeit der digitalen Signatur durch ein gesondertes Dokument bestätigen. Diese Anfrage ist an unseren Vertrieb zu richten. Eine Umweltgebühr für einen solchen zusätzlichen Service wird erhoben. Informationen zur Verifizierung der Authentizität unserer Dokumente erhalten Sie auf folgender Webseite: go.tuv.com/digital-signature</p> <p><i>As contractually agreed, this document has been signed digitally only. TUV Rheinland has not verified and unable to verify which legal or other pertaining requirements are applicable for this document. Such verification is within the responsibility of the user of this document. Upon request by its client, TUV Rheinland can confirm the validity of the digital signature by a separate document. Such request shall be addressed to our Sales department. An environmental fee for such additional service will be charged. For information on verifying the authenticity of our documents, please visit the following website: go.tuv.com/digital-signature</i></p>
3	<p>Prüfklausel mit der Note * wurden an qualifizierte Unterauftragnehmer vergeben und sind unter der jeweiligen Prüfklausel des Berichts beschrieben. Abweichungen von Prüfspezifikation(en) oder Kundenanforderungen sind in der jeweiligen Prüfklausel im Bericht aufgeführt.</p> <p><i>Test clauses with remark of * are subcontracted to qualified subcontractors and described under the respective test clause in the report. Deviations of testing specification(s) or customer requirements are listed in specific test clause in the report.</i></p>
4	<p>Die Entscheidungsregel für Konformitätserklärungen basierend auf numerischen Messergebnissen in diesem Prüfbericht basiert auf der "Null-Grenzwert-Regel" und der "Einfachen Akzeptanz" gemäß ILAC G8:2019 und IEC Guide 115:2021, es sei denn, in der auf Seite 1 dieses Berichts genannten angewandten Norm ist etwas anderes festgelegt oder vom Kunden gewünscht. Dies bedeutet, dass die Messunsicherheit nicht berücksichtigt wird und daher auch nicht im Prüfbericht angegeben wird. Zu weiteren Informationen bezüglich des Risikos durch diese Entscheidungsregel siehe ILAC G8:2019.</p> <p><i>The decision rule for statements of conformity, based on numerical measurement results, in this test report is based on the "Zero Guard Band Rule" and "Simple Acceptance" in accordance with ILAC G8:2019 and IEC Guide 115:2021, unless otherwise specified in the applied standard mentioned on Page 1 of this report or requested by the customer. This means that measurement uncertainty is not taken in account and hence also not declared in the test report. For additional information to the resulting risk based of this decision rule please refer to ILAC G8:2019.</i></p>

TEST SUMMARY

Report Section	FCC Clause	Test Item	Result
5.1.1	15.247(b) & 15.203	Antenna Requirement	Pass
5.1.2	15.247(b)(1)	Peak Output Power	Pass
5.1.3	15.247(a)(1)	20 dB Bandwidth	Note 1
5.1.3	2.1049	99% Occupied Bandwidth	Pass
5.1.4	15.247(d)	Conducted Spurious Emission and Band Edges	Pass
5.1.5	15.247(d) & 15.205 & 15.209	Radiated Spurious Emissions and Band Edges	Pass
5.1.6	15.247(a)(1)	Hopping Channel Separation	Pass
5.1.7	15.247(a)(1) (iii)	Number of Hopping Frequency Used	Pass
5.1.8	15.247(a)(1) (iii)	Dwell Time on Each Channel	Pass
5.2.1	15.207	Mains Conducted Emission	Pass

Note:

1. If the Frequency Hopping Systems operating in 2400-2483.5 MHz band and the output power less than 125 mW. The hopping channel carrier frequencies separated by a minimum of 25 kHz or two-thirds of the 20 dB bandwidth of hopping channel whichever is greater.
2. Determining compliance based on the results of the compliance measurement, not taking into account measurement instrumentation uncertainty.

Contents

HISTORY OF THIS TEST REPORT	6
1. GENERAL REMARKS	7
1.1 COMPLEMENTARY MATERIALS	7
1.2 DECISION RULE OF CONFORMITY	7
2. TEST SITES	8
2.1 TEST LABORATORY	8
2.2 TEST FACILITY	8
2.3 TRACEABILITY	9
2.4 CALIBRATION	9
2.5 MEASUREMENT UNCERTAINTY	9
3. GENERAL PRODUCT INFORMATION	10
3.1 PRODUCT FUNCTION AND INTENDED USE	10
3.2 SYSTEM DETAILS AND RATINGS	10
3.3 NOISE GENERATING AND NOISE SUPPRESSING PARTS	11
3.4 SUBMITTED DOCUMENTS	11
4. TEST SET-UP AND OPERATION MODES	12
4.1 PRINCIPLE OF CONFIGURATION SELECTION	12
4.2 CARRIER FREQUENCY AND CHANNEL	12
4.3 TEST OPERATION AND TEST SOFTWARE	13
4.4 SPECIAL ACCESSORIES AND AUXILIARY EQUIPMENT	14
4.5 TEST SETUP DIAGRAM	15
5. TEST RESULTS	16
5.1 TRANSMITTER REQUIREMENT & TEST SUITES	16
5.1.1 <i>Antenna Requirement</i>	<i>16</i>
5.1.2 <i>Peak Output Power</i>	<i>17</i>
5.1.3 <i>20 dB Bandwidth and 99% Occupied Bandwidth</i>	<i>20</i>
5.1.4 <i>Conducted Spurious Emissions and Frequency Band Edges Measured in 100kHz Bandwidth</i>	<i>21</i>
5.1.5 <i>Radiated Spurious Emissions and Band Edges</i>	<i>22</i>
5.1.6 <i>Hopping Channel Separation</i>	<i>27</i>
5.1.7 <i>Number of Hopping Frequency</i>	<i>28</i>
5.1.8 <i>Dwell Time</i>	<i>29</i>
5.2 MAINS EMISSION	30
5.2.1 <i>Mains Conducted Emission</i>	<i>30</i>

Prüfbericht - Nr.: **CN24WWB5 001**
Test Report No.

Seite 5 von 31
Page 5 of 31

APPENDIX A - TEST RESULT OF CONDUCTED for Left and Right Ears

**APPENDIX B - TEST RESULT OF RADIATED EMISSIONS & MAINS CONDUCTED EMISSION FOR
Left and Right Ears**

APPENDIX SP - PHOTOGRAPHS TEST SETUP

APPENDIX EP - PHOTOGRAPHS OF EUT

Prüfbericht - Nr.: **CN24WWB5 001**
Test Report No.

Seite 6 von 31
Page 6 of 31

HISTORY OF THIS TEST REPORT

Revision	Description	Date Issued
R01	Original Release	2024-01-22

1. General Remarks

1.1 Complementary Materials

All attachments are integral parts of this test report. This applies especially to the following appendix:

Appendix A - Test Result of Conducted for Left and Right Ears

Appendix B - Test Result of Radiated Emissions & Mains Conducted Emission for Left and Right Ears

Appendix SP - Photographs Test Setup

Appendix EP - Photographs of EUT

Applied Standard and Test Levels

Radio
FCC 47CFR Part 15: Subpart C Section 15.247
FCC 47CFR Part 2: Subpart J Section 2.1049
ANSI C63.10:2013
KDB 558074 D01 15.247 Meas Guidance v05r02

1.2 Decision Rule of Conformity

The decision rule of conformity of this test report is following the requirements of the requested standard in the quotation, and agreed among testing laboratory and manufacturer (applicant) to exclude the consideration of Measurement Uncertainty, unless it is required by the specific standard.

2. Test Sites

2.1 Test Laboratory

Taipei Testing Laboratories

11F. No.758, Sec. 4, Bade Rd., Songshan Dist.
Taipei City 105
Taiwan (R.O.C.)

2.2 Test Facility

Taipei Testing Laboratories

No.458-18, Sec. 2, Fenliao Rd., Linkou Dist.,
New Taipei City 244
Taiwan (R.O.C.)
FCC Registration No.: 180491
ISED Registration No.: 25563

2.3 Traceability

All measurement equipment calibrations are traceable to NML(Taiwan)/NIST(USA) or where calibration is performed outside Taiwan, to equivalent nationally recognized standards organizations.

2.4 Calibration

Equipment requiring calibration is calibrated periodically in a suitably accredited Calibration Lab. Additionally all equipment is verified for proper performance on a regular basis using in house standards or comparisons.

2.5 Measurement Uncertainty

All measurement uncertainty values are shown with a coverage factor of $k=2$ to indicate a 95% level of confidence.

Emission Measurement Uncertainty

Parameter	Uncertainty
Radiated Emission (9 kHz ~ 30 MHz)	± 1.15 dB
Radiated Emission (30 MHz ~ 200 MHz)	± 1.30 dB
Radiated Emission (200 MHz ~ 1 GHz)	± 1.30 dB
Radiated Emission (1 GHz ~ 18 GHz)	± 1.54 dB
Radiated Emission (18 GHz ~ 40 GHz)	± 2.52 dB
Mains Conducted Emission	± 1.65 dB

3. General Product Information

3.1 Product Function and Intended Use

The EUT is a True Wireless Earphone. It contains a Bluetooth compatible module enabling the user to communicate data through a Wireless interface.

For details refer to the User Guide, Data Sheet and Circuit Diagram.

3.2 System Details and Ratings

Basic Information of EUT

Item	EUT information
Kind of Equipment/Test Item	True Wireless Earphone
Type Identification	TWS003
FCC ID	2BCCJ-DAISOTWS003

Technical Specification of EUT

Item	EUT information
Operating Frequency	2402 MHz ~ 2480 MHz
Channel Spacing	1 MHz
Channel Number	79
Operation Voltage	3.7Vdc Battery
Modulation	GFSK, $\pi/4$ -DQPSK
Maximum Output Power (mW)	2.58
Antenna Information	Refer to 5.1.1
Accessory Device	Refer to 4.4

3.3 Noise Generating and Noise Suppressing Parts

Refer to the Circuit Diagram.

3.4 Submitted Documents

- Circuit Diagram
- Instruction Manual
- Rating Label
- Technical Description

4. Test Set-up and Operation Modes

4.1 Principle of Configuration Selection

The test modes were adapted accordingly in reference to the instructions for use.

During testing, Channel and Power Controlling Software provided by the customer was used to control the operating channel as well as the output power level. The RF output power selection is for the setting of RF output expected by the customer and is going to be fixed on the firmware of the final end product.

Table for Parameters of Test Software Setting

Frequency (MHz)	Power Setting	
	GFSK	$\pi/4$ -DQPSK
2402	4	4
2441	4	4
2480	4	4

4.2 Carrier Frequency and Channel

Channel	Freq. (MHz)	Channel	Freq. (MHz)	Channel	Freq. (MHz)	Channel	Freq. (MHz)
0	2402	20	2422	40	2442	60	2462
1	2403	21	2423	41	2443	61	2463
2	2404	22	2424	42	2444	62	2464
3	2405	23	2425	43	2445	63	2465
4	2406	24	2426	44	2446	64	2466
5	2407	25	2427	45	2447	65	2467
6	2408	26	2428	46	2448	66	2468
7	2409	27	2429	47	2449	67	2469
8	2410	28	2430	48	2450	68	2470
9	2411	29	2431	49	2451	69	2471
10	2412	30	2432	50	2452	70	2472
11	2413	31	2433	51	2453	71	2473
12	2414	32	2434	52	2454	72	2474
13	2415	33	2435	53	2455	73	2475
14	2416	34	2436	54	2456	74	2476
15	2417	35	2437	55	2457	75	2477
16	2418	36	2438	56	2458	76	2478
17	2419	37	2439	57	2459	77	2479
18	2420	38	2440	58	2460	78	2480
19	2421	39	2441	59	2461		

4.3 Test Operation and Test Software

Setup for testing: Test samples are provided with a USB interface which makes it possible to control them through a test software installed on a notebook computer.

This software was running on the laptop computer connected to the EUT. It was used to enable the operation modes listed as below.

Test Software	bt_tool_v1.1.2
---------------	----------------

The samples were used as follows:

A003563327-007,008

A003563327-009

Full test was applied on all test modes, but only worst case was shown.

EUT Configure Mode	Applicable To				Description
	Antenna Port Conducted Measurement	Radiated Spurious Emissions above 1 GHz	Radiated Spurious Emissions below 1 GHz	Mains Conducted Emission	
-	√	√	√	-	-
Charge	-	-	√	√	

Note:

1. The EUT had been pre-tested on the positioned of each 3 axis. The worst case was found when position on **Z-plane**.
2. "-" means no effect.

Antenna Port Conducted Measurement

- Pre-Scan full test was applied on all test modes, but only worst case was shown.
- Following channel(s) was (were) selected for the final test as listed below.

EUT Configure Mode	Available Frequency (MHz)	Tested Frequency (MHz)	Modulation Type	Packet Type
-	2402 to 2480	2402, 2441, 2480	GFSK	1DH5
-	2402 to 2480	2402, 2441, 2480	π/4-DQPSK	2DH5

Radiated Spurious Emissions (Above 1 GHz)

- Pre-Scan full test was applied on all test modes, but only worst case was shown.
- Following channel(s) was (were) selected for the final test as listed below.

EUT Configure Mode	Available Frequency (MHz)	Tested Frequency (MHz)	Modulation Type	Packet Type
-	2402 to 2480	2402, 2441, 2480	GFSK	1DH5
-	2402 to 2480	2402, 2441, 2480	π/4-DQPSK	2DH5

Radiated Spurious Emissions (Below 1 GHz)

- Pre-Scan full test was applied on all test modes, but only worst case was shown.
- Following channel(s) was (were) selected for the final test as listed below.

EUT Configure Mode	Available Frequency (MHz)	Tested Frequency (MHz)	Modulation Type	Packet Type
-	2402 to 2480	2402	GFSK	1DH5
Charge	2402 to 2480	2402	GFSK	1DH5

Mains Conducted Emission Test

- Pre-Scan full test was applied on all test modes, but only worst case was shown.
- Following channel(s) was (were) selected for the final test as listed below.

EUT Configure Mode	Available Frequency (MHz)	Tested Frequency (MHz)	Modulation Type	Packet Type
Charge	2402 to 2480	2402	GFSK	1DH5

Prüfbericht - Nr.: CN24WWB5 001
Test Report No.

 Seite 14 von 31
 Page 14 of 31

Test Condition

Test Item	Ambient Temperature	Relative Humidity	Tested by
Conducted Measurement	22.4-22.8 °C	56.2-61.3 %	Andy Chen
Radiated Spurious Emissions above 1 GHz	24.6-25.7 °C	54-56 %	Chuan Chu
Radiated Spurious Emissions below 1 GHz	24.6-25.7 °C	54-56 %	Chuan Chu
Mains Conducted Emission	19.1-25.9 °C	50.2-58.9 %	Roger Liao

4.4 Special Accessories and Auxiliary Equipment

The product has been tested together with the following additional accessories:

Accessory of EUT

None.

Support Unit

Support Unit								
No.	Description	Brand	Model	S/N	Shielded	Ferrite Core (Qty)	Length (cm)	Remark
Radiated Test, Charge Mode and Mains Conducted Test								
1	Adapter	OPPO	VC56JACH	-	-	-	-	-
2	USB to Type-C	TUV	TUV-01	-	N/A	NO	100	-
Conducted Test								
-	Notebook	HP	HP15S-du0007TX	CND93662WV	-	-	-	-

4.5 Test Setup Diagram

<Radiated Spurious Emissions mode>

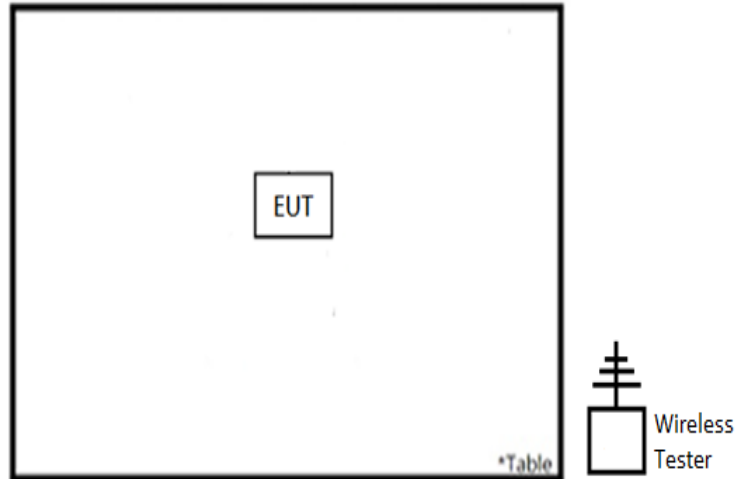

<Radiated Spurious Emissions, Charge Mode>

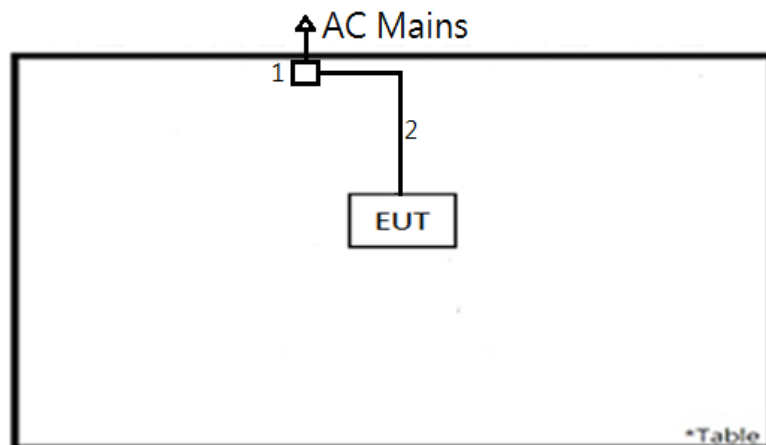

<Mains Conducted Emission mode>

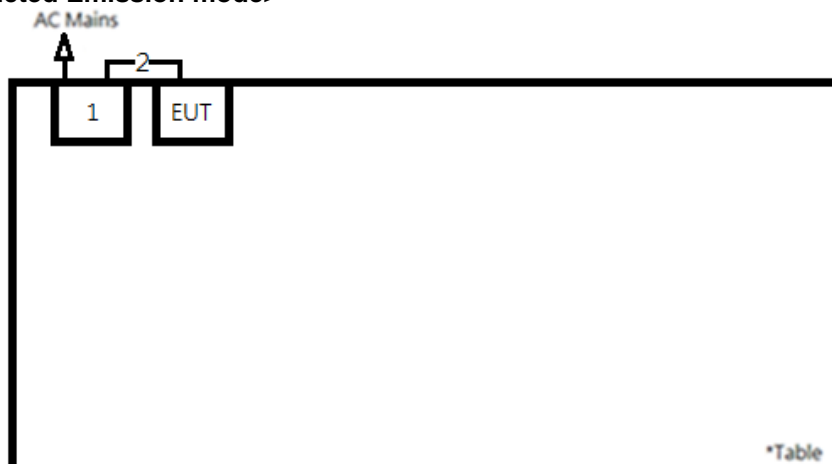

5. Test Results

5.1 Transmitter Requirement & Test Suites

5.1.1 Antenna Requirement

Requirement Use of approved antennas only

According to the manufacturer declaration, the EUT has an antenna with a directional gain of 0.02 dBi. The antenna is a PCB antenna with no possibility of replacement with a non-approved antenna by the end-user. Therefore, the EUT is considered to comply with this provision.
Refer to EUT photo for details.

5.1.2 Peak Output Power

Limit

For frequency hopping systems operating in the 2400-2483.5 MHz band employing at least 75 non-overlapping hopping channels, and all frequency hopping systems in the 5725-5850 MHz band: 1 watt. For all other frequency hopping systems in the 2400-2483.5 MHz band: 0.125 watts.

Kind of Test Site Shielded room

Test Setup



Test Instruments

Kind of Equipment	Manufacturer	Type	S/N	Calibration Date	Calibration Due Date	Test Date	
						From	Until
Power Meter	Anritsu	ML2495A	1901008	2023/03/17	2024/03/16	2024/01/02	2024/01/12
Power Sensor	Anritsu	MA2411B	1725269	2023/03/17	2024/03/16	2024/01/02	2024/01/12

Test Procedures

A peak power sensor was used on the output port of the EUT. A power meter was used to read the response of the peak power sensor. Record the power level.

Average power sensor was used to perform output power measurement, trigger and gating function of wide band power meter is enabled to measure max output power of TX on burst. Duty factor is not added to measured value.

Test Result
Peak Output Power for Left Ear
<GFSK>

Channel	Channel Frequency	Peak Output Power		Limit
	(MHz)	(dBm)	(mW)	(mW)
Low Channel	2402	1.72	1.49	125
Middle Channel	2441	1.75	1.50	125
High Channel	2480	1.43	1.39	125

< $\pi/4$ -DQPSK>

Channel	Channel Frequency	Peak Output Power		Limit
	(MHz)	(dBm)	(mW)	(mW)
Low Channel	2402	2.50	1.78	125
Middle Channel	2441	2.56	1.80	125
High Channel	2480	2.25	1.68	125

Peak Output Power for Right Ear
<GFSK>

Channel	Channel Frequency	Peak Output Power		Limit
	(MHz)	(dBm)	(mW)	(mW)
Low Channel	2402	3.31	2.14	125
Middle Channel	2441	3.22	2.10	125
High Channel	2480	2.70	1.86	125

< $\pi/4$ -DQPSK>

Channel	Channel Frequency	Peak Output Power		Limit
	(MHz)	(dBm)	(mW)	(mW)
Low Channel	2402	4.12	2.58	125
Middle Channel	2441	4.03	2.53	125
High Channel	2480	3.49	2.23	125

Average Power for Left Ear
<GFSK>

Channel	Channel Frequency	Average Power	
	(MHz)	(dBm)	(mW)
Low Channel	2402	1.33	1.36
Middle Channel	2441	1.34	1.36
High Channel	2480	1.02	1.26

< $\pi/4$ -DQPSK >

Channel	Channel Frequency	Average Power	
	(MHz)	(dBm)	(mW)
Low Channel	2402	-0.38	0.92
Middle Channel	2441	-0.35	0.92
High Channel	2480	-0.42	0.91

Average Power for Right Ear
<GFSK>

Channel	Channel Frequency	Average Power	
	(MHz)	(dBm)	(mW)
Low Channel	2402	2.88	1.94
Middle Channel	2441	2.76	1.89
High Channel	2480	2.25	1.68

< $\pi/4$ -DQPSK >

Channel	Channel Frequency	Average Power	
	(MHz)	(dBm)	(mW)
Low Channel	2402	1.24	1.33
Middle Channel	2441	1.12	1.29
High Channel	2480	0.56	1.14

5.1.3 20 dB Bandwidth and 99% Occupied Bandwidth

Kind of Test Site Shielded room

Test Setup

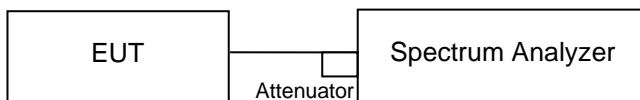

Test Instruments

Kind of Equipment	Manufacturer	Type	S/N	Calibration Date	Calibration Due Date	Test Date	
						From	Until
Spectrum Analyzer	R&S	FSV	101512	2023/02/23	2024/02/22	2024/01/02	2024/01/12
Spectrum Analyzer	Agilent	N9010A	MY52221334	2023/03/16	2024/03/15	2024/01/02	2024/01/12

Test Procedure

- a. Check the calibration of the measuring instrument using either an internal calibrator or a known signal from an external generator.
- b. Turn on the EUT and connect it to measurement instrument. Then set it to any one convenient frequency within its operating range. Set a reference level on the measuring instrument equal to the highest peak value.
- c. Measure the frequency difference of two frequencies that were attenuated 20 dB from the reference level. Record the frequency difference as the emission bandwidth.
- d. Repeat above procedures until all frequencies measured were complete.
- e. The transmitter output was connected to the spectrum analyzer through an attenuator. The bandwidth of the fundamental frequency was measured by spectrum analyzer with resolution bandwidth in the range of 1 % to 5 % of the anticipated emission bandwidth, and a video bandwidth at least 3x the resolution bandwidth and set the detector to PEAK. The width of a frequency band such that, below the lower and above the upper frequency limits, the mean powers emitted are each equal to a specified percentage 0.5 % of the total mean power of a given emission.

Test Results

Please refer to Appendix A.

Prüfbericht - Nr.: CN24WWB5 001
Test Report No.

 Seite 21 von 31
 Page 21 of 31

5.1.4 Conducted Spurious Emissions and Frequency Band Edges Measured in 100kHz Bandwidth

Limit

20dB (below that in the 100 kHz bandwidth within the band that contains the highest level of the desired power.)

Kind of Test Site Shielded room

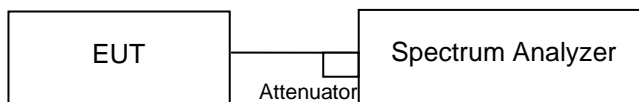
Test Setup

Test Instruments

Kind of Equipment	Manufacturer	Type	S/N	Calibration Date	Calibration Due Date	Test Date	
						From	Until
Spectrum Analyzer	R&S	FSV	101512	2023/02/23	2024/02/22	2024/01/02	2024/01/12
Spectrum Analyzer	Agilent	N9010A	MY52221334	2023/03/16	2024/03/15	2024/01/02	2024/01/12

Test Procedure

The transmitter output was connected to the spectrum analyzer via a low lose cable. Set both RBW and VBW of spectrum analyzer to 100 kHz and 300 kHz with suitable frequency span including 100 MHz bandwidth from band edge. The band edges was measured and recorded.

Test Results

Please refer to Appendix A.

5.1.5 Radiated Spurious Emissions and Band Edges

Limit

Radiated emissions which fall in the restricted bands, as defined in §15.205(a), must comply with the radiated emission limits specified in §15.209(a).

Emissions radiated outside the restricted and authorized frequency bands must either comply with the radiated emission limits specified for the restricted bands or in §15.247(d).

Kind of Test Site 3m Semi-Anechoic Chamber

Test Setup

<Radiated Emissions below 30 MHz>

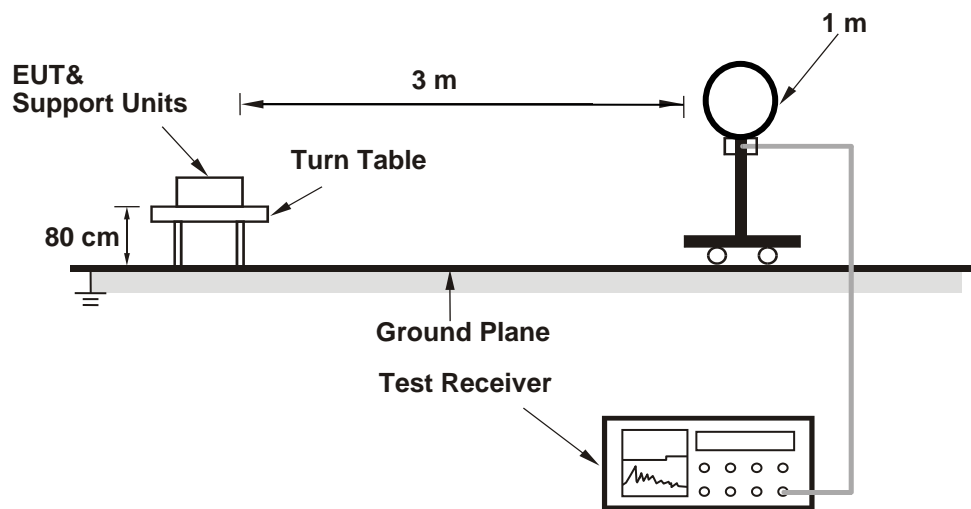

<Radiated Emissions 30 MHz to 1 GHz>

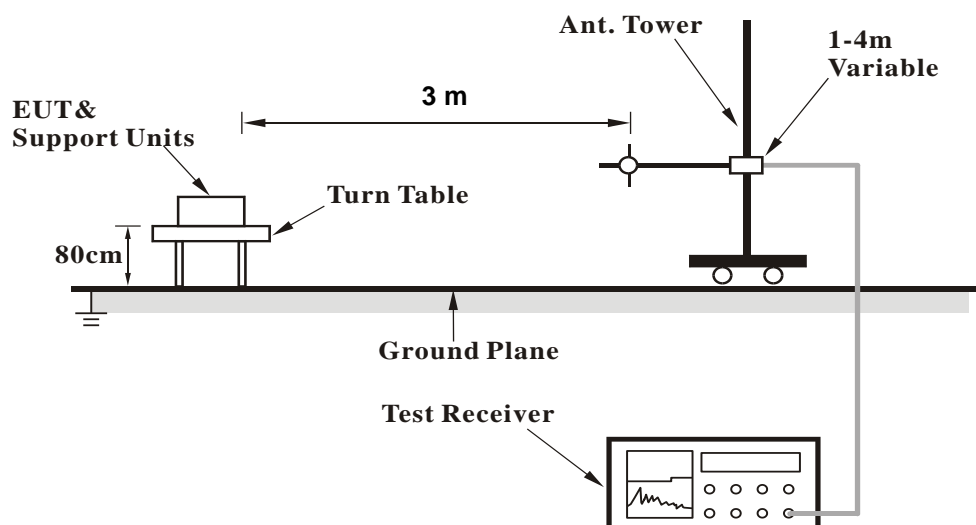

<Radiated Emissions above 1 GHz>

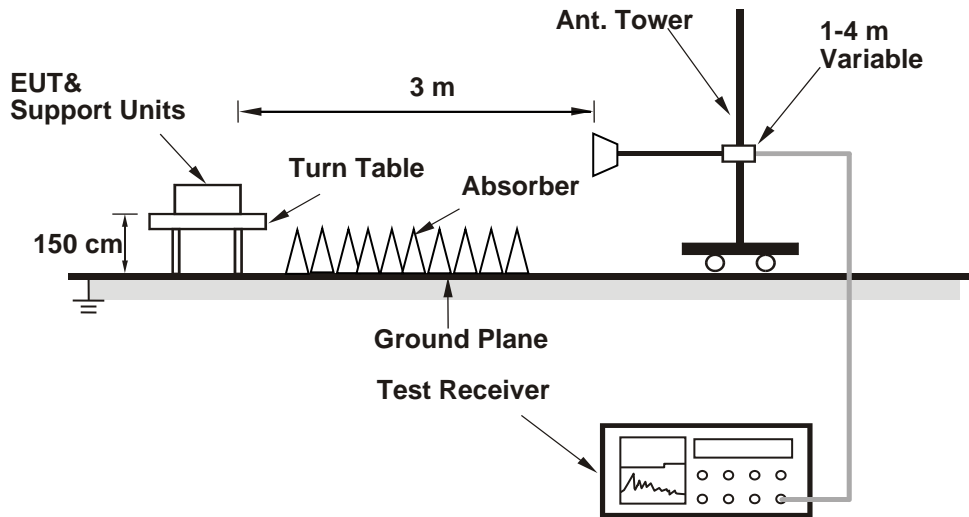

For the actual test configuration, please refer to the attached file (Test Setup Photo).

Prüfbericht - Nr.: CN24WWB5 001
Test Report No.
Test Instruments

Kind of Equipment	Manufacturer	Type	S/N	Calibration Date	Calibration Due Date
Above 1GHz					
Signal Analyzer	R&S	FSV40	101509	2023/04/26	2024/04/24
Wireless Tester	R&S	CBT	100866	2023/04/12	2024/04/10
Horn Antenna	ETS-Lindgren	3117	00218931	2023/02/24	2024/02/23
HF-AMP + AC source	EMCI	EM01G18GA	980633	2023/02/22	2024/02/21
HF-AMP + AC source	EMCI	EMC184045SE	980657	2023/02/16	2024/02/15
Horn Antenna	SCHWARZBECK	BBHA 9170	00890	2023/05/04	2024/05/02
30MHz ~ 1GHz					
Receiver	R&S	ESR7	102109	2023/02/24	2024/02/23
Wireless Tester	R&S	CBT	100866	2023/04/12	2024/04/10
Bilog Antenna	SCHWARZBECK	VULB-9168	00951	2023/03/31	2024/03/29
LF-AMP	Agilent	8447D	2944A107722	2023/03/22	2024/03/20
Below 30MHz					
Receiver	R&S	ESR7	102109	2023/02/24	2024/02/23
Wireless Tester	R&S	CBT	100866	2023/04/12	2024/04/11
Loop Antenna	SCHWARZBECK	FMZB 1519B	00215	2024/01/04	2025/01/03

Test Procedures**For Radiated Emissions below 30 MHz**

- a. The EUT was placed on the top of a rotating table 0.8 meters above the ground at a 3 meter chamber room. The table was rotated 360 degrees to determine the position of the highest radiation.
- b. The EUT was set 3 meters away from the interference-receiving antenna, which was mounted on the top of a variable-height antenna tower.
- c. Parallel (OPEN), perpendicular (CLOSE), and ground-parallel (GROUND) orientations of the antenna are set to make the measurement.
- d. For each suspected emission, the EUT was arranged to its worst case and the rotatable table was turned from 0 degrees to 360 degrees to find the maximum reading.
- e. The test-receiver system was set to Quasi-Peak Detect Function and Specified Bandwidth with Maximum Hold Mode.

Note:

1. The resolution bandwidth and video bandwidth of test receiver/spectrum analyzer is 9 kHz at frequency below 30 MHz.
2. All modes of operation were investigated and the worst-case emissions are reported.

For Radiated Emissions above 30 MHz

- a. The EUT was placed on the top of a rotating table 0.8 meters (for 30 MHz ~ 1 GHz) / 1.5 meters (for above 1 GHz) above the ground at 3 meter chamber room for test. The table was rotated 360 degrees to determine the position of the highest radiation.
- b. The EUT was set 3 meters away from the interference-receiving antenna, which was mounted on the top of a variable-height antenna tower.
- c. The height of antenna is varied from one meter to four meters above the ground to determine the maximum value of the field strength. Both horizontal and vertical polarizations of the antenna are set to make the measurement.
- d. For each suspected emission, the EUT was arranged to its worst case and then the antenna was tuned to heights from 1 meter to 4 meters and the rotatable table was turned from 0 degrees to 360 degrees to find the maximum reading.
- e. The test-receiver system was set to quasi-peak detect function and specified bandwidth with maximum hold mode when the test frequency is below 1 GHz.
- f. The test-receiver system was set to peak and average detected function and specified bandwidth with maximum hold mode when the test frequency is above 1 GHz. If the peak reading value also meets average limit, measurement with the average detector is unnecessary.

Note:

1. The resolution bandwidth and video bandwidth of test receiver/spectrum analyzer is 120 kHz for Quasi-peak detection (QP) or Peak detection (PK) at frequency below 1 GHz.
2. The resolution bandwidth of test receiver/spectrum analyzer is 1 MHz and the video bandwidth is 3 MHz for Peak detection (PK) at frequency above 1 GHz.
3. The resolution bandwidth of test receiver/spectrum analyzer is 1 MHz and the video bandwidth is $\geq 1/T$ (Duty cycle < 98 %) or 10 Hz (Duty cycle ≥ 98 %) for Average detection (AV) at frequency above 1 GHz.
4. For fundamental frequency: The average value is "Average = Peak value + 20log(Duty cycle)
Where the duty factor is calculated from following formula for DH5 packet type which has worst duty factor:
 $20\log(\text{Duty cycle}) = 20\log(\text{dwell time} / 100\text{ms}) = 20\log(3.125 / 100) = -30.1 \text{ dB}$
5. All modes of operation were investigated and the worst-case emissions are reported.
6. The Radiated Emissions testing was performed in the X(E1), Y(H) and Z(E2) axis orientation. The

Prüfbericht - Nr.: **CN24WWB5 001**
Test Report No.

Seite 26 von 31
Page 26 of 31

worst-case Axis orientation is recorded in this test report.

7. The emission levels of other frequencies (including the 10th harmonic of the highest fundamental frequency) are very lower than the limit and are not shown in the test report.

Test Results

Factor (dB/m) = Antenna Factor (dB/m) + Cable Loss (dB)

Level (dBuV/m) = Reading (dBuV) + Factor (dB/m)

Please refer to Appendix B.

Prüfbericht - Nr.: CN24WWB5 001
Test Report No.

 Seite 27 von 31
 Page 27 of 31

5.1.6 Hopping Channel Separation

Limit ≥ 25 kHz or 2/3 of 20 dB bandwidth, whichever is greater

Kind of Test Site Shielded room

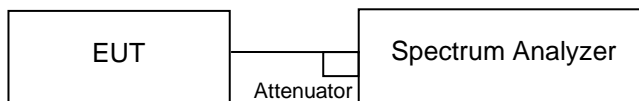
Test Setup

Test Instruments

Kind of Equipment	Manufacturer	Type	S/N	Calibration Date	Calibration Due Date	Test Date	
						From	Until
Spectrum Analyzer	R&S	FSV	101512	2023/02/23	2024/02/22	2024/01/02	2024/01/12
Spectrum Analyzer	Agilent	N9010A	MY52221334	2023/03/16	2024/03/15	2024/01/02	2024/01/12

Test Procedure

Measurement Procedure REF

- a. Check the calibration of the measuring instrument using either an internal calibrator or a known signal from an external generator.
- b. Turn on the EUT and connect it to measurement instrument. Then set it to any one convenient frequency within its operating range.
- c. By using the MaxHold function record the separation of two adjacent channels.
- d. Measure the frequency difference of these two adjacent channels by SA MARK function. And then plot the result on SA screen.
- e. Repeat above procedures until all frequencies measured were complete.

Test Results

Please refer to Appendix A.

Prüfbericht - Nr.: **CN24WWB5 001**
Test Report No.

 Seite 28 von 31
 Page 28 of 31

5.1.7 Number of Hopping Frequency

Limit ≥ 15 non-overlapping channels

Kind of Test Site Shielded room

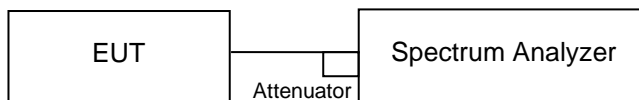
Test Setup

Test Instruments

Kind of Equipment	Manufacturer	Type	S/N	Calibration Date	Calibration Due Date	Test Date	
						From	Until
Spectrum Analyzer	R&S	FSV	101512	2023/02/23	2024/02/22	2024/01/02	2024/01/12
Spectrum Analyzer	Agilent	N9010A	MY52221334	2023/03/16	2024/03/15	2024/01/02	2024/01/12

Test Procedure

- Check the calibration of the measuring instrument (SA) using either an internal calibrator or a known signal from an external generator.
- Turn on the EUT and connect its antenna terminal to measurement via a low loss cable. Then set it to any one measured frequency within its operating range and make sure the instrument is operated in its linear range.
- Set the SA on MaxHold Mode, and then keep the EUT in hopping mode. Record all the signals from each channel until each one has been recorded.
- Set the SA on View mode and then plot the result on SA screen.
- Repeat above procedures until all frequencies measured were complete.

Test Results

Please refer to Appendix A.

Prüfbericht - Nr.: CN24WWB5 001
Test Report No.

 Seite 29 von 31
 Page 29 of 31

5.1.8 Dwell Time

Limit 0.4s

Kind of Test Site Shielded room

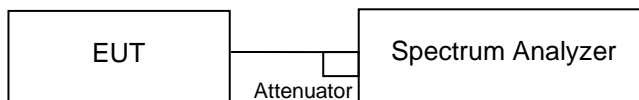
Test Setup

Test Instruments

Kind of Equipment	Manufacturer	Type	S/N	Calibration Date	Calibration Due Date	Test Date	
						From	Until
Spectrum Analyzer	R&S	FSV	101512	2023/02/23	2024/02/22	2024/01/02	2024/01/12
Spectrum Analyzer	Agilent	N9010A	MY52221334	2023/03/16	2024/03/15	2024/01/02	2024/01/12

Test Procedures

- Check the calibration of the measuring instrument (SA) using either an internal calibrator or a known signal from an external generator.
- Turn on the EUT and connect its antenna terminal to measurement via a low loss cable. Then set it to any one measured frequency within its operating range and make sure the instrument is operated in its linear range.
- Adjust the center frequency of SA on any frequency be measured and set SA to zero span mode. And then, set RBW and VBW of spectrum analyzer to proper value.
- Measure the time duration of one transmission on the measured frequency. And then plot the result with time difference of this time duration.
- Repeat above procedures until all different time-slot modes have been completed.

Test Results

Please refer to Appendix A.

5.2 Mains Emission

5.2.1 Mains Conducted Emission

Limit

Mains Conducted Emission as defined in §15.207 must comply with the mains conducted emission limits.

Kind of Test Site Shielded room

Test Setup

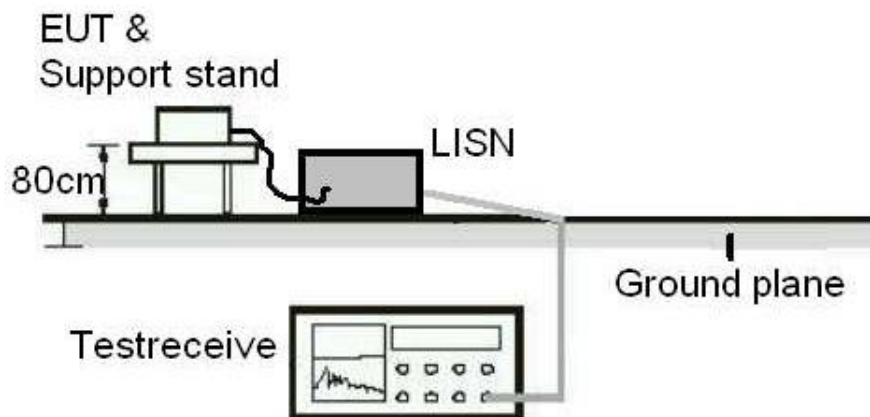

Test Instruments

Kind of Equipment	Manufacturer	Type	S/N	Calibration Date	Calibration Due Date
Two-Line V-Network	Rohde & Schwarz	ENV216	101938	2023/10/23	2024/10/21
EMI Test Receiver	R&S	ESCI	100797	2023/07/21	2024/07/19

Prüfbericht - Nr.: **CN24WWB5 001**
Test Report No.

Seite 31 von 31
Page 31 of 31

Test Procedures

- a. The EUT was placed 0.4 meters from the conducting wall of the shielded room with EUT being connected to the power mains through a line impedance stabilization network (LISN). Other support units were connected to the power mains through another LISN. The two LISNs provide 50 ohm/50 uH of coupling impedance for the measuring instrument.
- b. Both lines of the power mains connected to the EUT were checked for maximum conducted interference.
- c. The frequency range from 150 kHz to 30 MHz was searched. Emission levels under (Limit – 20 dB) was not recorded.

Note: The resolution bandwidth and video bandwidth of test receiver is 9 kHz for quasi-peak detection (QP) and average detection (AV) at frequency 0.15 MHz – 30 MHz.

Test Results

Please refer to Appendix B.