

Test Report

Report No.: MTi230722002-01E1
Date of issue: 2023-10-08
Applicant: Shenzhen QM Smart Panlee Technology Co., Ltd
Product: PANLEE BC02
Model(s): ZX3D95CE01S-TR-4848
FCC ID: 2BCBK-TR4848

Shenzhen Microtest Co., Ltd.

<http://www.mtitest.com>

The test report is only used for customer scientific research, teaching, internal quality control and other purposes, and is for internal reference only.





Instructions

1. This test report shall not be partially reproduced without the written consent of the laboratory.
2. The test results in this test report are only responsible for the samples submitted
3. This test report is invalid without the seal and signature of the laboratory.
4. This test report is invalid if transferred, altered, or tampered with in any form without authorization.
5. Any objection to this test report shall be submitted to the laboratory within 15 days from the date of receipt of the report.

Table of contents

1	General Description	5
1.1	Description of the EUT	5
1.2	Description of test modes	5
1.3	Environmental Conditions	7
1.4	Description of support units	7
1.5	Measurement uncertainty	7
2	Summary of Test Result	8
3	Test Facilities and accreditations	9
3.1	Test laboratory	9
4	List of test equipment.....	10
5	Evaluation Results (Evaluation).....	11
5.1	Antenna requirement	11
6	Radio Spectrum Matter Test Results (RF)	11
6.1	Conducted Emission at AC power line	11
6.2	Occupied Bandwidth	14
6.3	Maximum Conducted Output Power.....	15
6.4	Power Spectral Density	16
6.5	Emissions in frequency bands.....	17
6.6	Band edge emissions (Radiated)	18
6.7	Radiated emissions (below 1GHz)	23
6.8	Radiated emissions (above 1GHz).....	27
	Photographs of the test setup	34
	Photographs of the EUT.....	35
	Appendix A: DTS Bandwidth	36
	Appendix B: Maximum conducted output power.....	39
	Appendix C: Maximum power spectral density.....	42
	Appendix D: Band edge measurements	45
	Appendix E: Conducted Spurious Emission	47
	Appendix F: Duty Cycle	53

Test Result Certification	
Applicant:	Shenzhen QM Smart Panlee Technology Co., Ltd
Address:	Room 805, Block A, Building 6, Shenzhen International Innovation Valley, Xili Community, Nanshan District, Shenzhen
Manufacturer:	Shenzhen QM Smart Panlee Technology Co., Ltd
Address:	Room 805, Block A, Building 6, Shenzhen International Innovation Valley, Xili Community, Nanshan District, Shenzhen
Product description	
Product name:	PANLEE BC02
Trade mark:	N/A
Model name:	ZX3D95CE01S-TR-4848
Series Model:	N/A
Standards:	47 CFR Part 15.247
Test Method:	ANSI C63.10-2013 KDB 558074 D01 15.247 Meas Guidance v05r02
Date of Test	
Date of test:	2023-08-10 to 2023-10-08
Test result:	Pass

Test Engineer	:	
		(Maleah Deng)
Reviewed By	:	
		(Leon Chen)
Approved By	:	
		(Tom Xue)

1 General Description

1.1 Description of the EUT

Product name:	PANLEE BC02
Model name:	ZX3D95CE01S-TR-4848
Series Model:	N/A
Model difference:	N/A
Electrical rating:	Input: DC 5V
Accessories:	N/A
Hardware version:	ZX3D95CE01S-TR-4848 V1.0
Software version:	QMSD SDK V2.2
Test sample(s) number:	MTi230722002-01S1001
RF specification	
Bluetooth version:	V5.0
Operating frequency range:	2402MHz to 2480MHz
Channel number:	40
Modulation type:	GFSK
Antenna(s) type:	PCB Antenna
Antenna(s) gain:	-0.47dBi

1.2 Description of test modes

No.	Emission test modes
Mode1	TX-GFSK-1M
Mode2	TX-GFSK-2M

1.2.1 Operation channel list

Channel	Frequency (MHz)	Channel	Frequency (MHz)	Channel	Frequency (MHz)	Channel	Frequency (MHz)
0	2402	10	2422	20	2442	30	2462
1	2404	11	2424	21	2444	31	2464
2	2406	12	2426	22	2446	32	2466
3	2408	13	2428	23	2448	33	2468
4	2410	14	2430	24	2450	34	2470
5	2412	15	2432	25	2452	35	2472
6	2414	16	2434	26	2454	36	2474
7	2416	17	2436	27	2456	37	2476
8	2418	18	2438	28	2458	38	2478
9	2420	19	2440	29	2460	39	2480

Note: The test software provided by manufacturer is used to control EUT for working in engineering mode, that enables selectable channel, and capable of continuous transmitting mode.

Test Software:

For power setting, refer to below table.

Test Software:	EspRFTestTool		
Mode	2402MHz	2440MHz	2480MHz
1M	10	10	10
2M	10	10	10

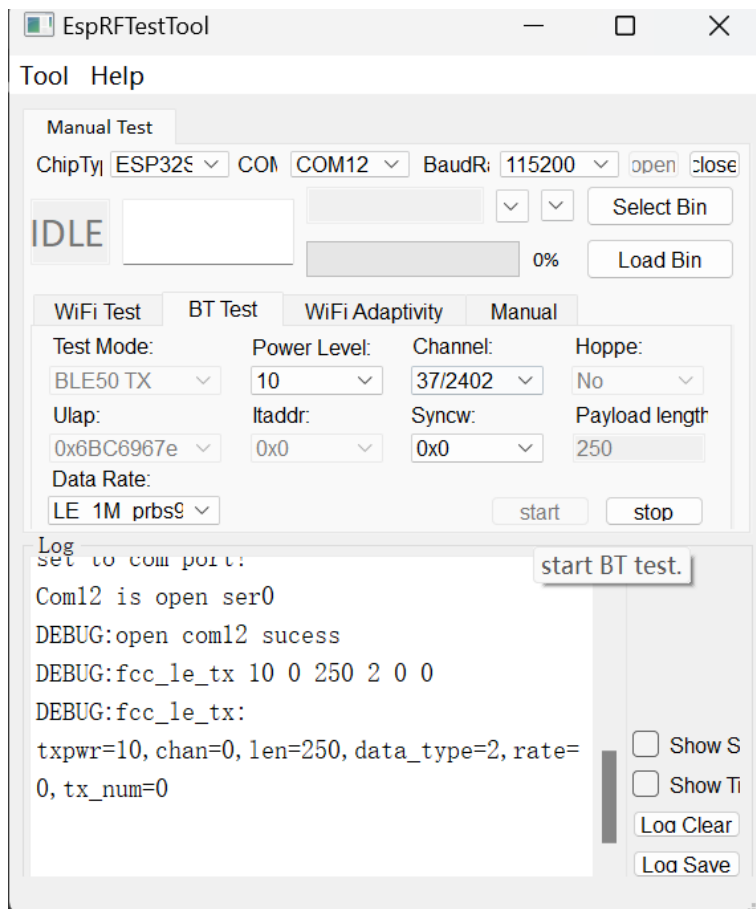

1.3 Environmental Conditions

During the measurement the environmental conditions were within the listed ranges:

Temperature:	15°C ~ 35°C
Humidity:	20% RH ~ 75% RH
Atmospheric pressure:	98 kPa ~ 101 kPa

1.4 Description of support units

The EUT has been tested as an independent unit together with other necessary accessories or support units. The following support units or accessories were used to form a representative test configuration during the tests.

Support equipment list			
Description	Model	Serial No.	Manufacturer
HUAWEI CHARGE (10W)	HW-050200C02	K95212KA103561	HUAWEI
Support cable list			
Description	Length (m)	From	To
/	/	/	/

1.5 Measurement uncertainty

Measurement	Uncertainty
Conducted emissions (AMN 150kHz~30MHz)	3.1dB
Occupied channel bandwidth	±3 %
RF output power, conducted	±1 dB
Power Spectral Density, conducted	±1 dB
Unwanted Emissions, conducted	±1 dB
Radiated spurious emissions (1GHz~25GHz)	5.3dB
Radiated spurious emissions (9kHz~30MHz)	4.3dB
Radiated spurious emissions (30MHz~1GHz)	4.7dB
Temperature	±1 °C
Humidity	± 5 %

This uncertainty represents an expanded uncertainty expressed at approximately the 95% confidence level using a coverage factor of k=2.

2 Summary of Test Result

No.	Item	Standard	Requirement	Result
1	Antenna requirement	47 CFR Part 15.247	47 CFR 15.203	Pass
2	Conducted Emission at AC power line	47 CFR Part 15.247	47 CFR 15.207(a)	Pass
3	Occupied Bandwidth	47 CFR Part 15.247	47 CFR 15.247(a)(2)	Pass
4	Maximum Conducted Output Power	47 CFR Part 15.247	47 CFR 15.247(b)(3)	Pass
5	Power Spectral Density	47 CFR Part 15.247	47 CFR 15.247(e)	Pass
6	Emissions in frequency bands	47 CFR Part 15.247	47 CFR 15.247(d)	Pass
7	Band edge emissions (Radiated)	47 CFR Part 15.247	47 CFR 15.247(d)	Pass
8	Radiated emissions (below 1GHz)	47 CFR Part 15.247	47 CFR 15.247(d)	Pass
9	Radiated emissions (above 1GHz)	47 CFR Part 15.247	47 CFR 15.247(d)	Pass

3 Test Facilities and accreditations

3.1 Test laboratory

Test laboratory:	Shenzhen Microtest Co., Ltd.
Test site location:	101, No.7, Zone 2, Xinxing Industrial Park, Fuhai Avenue, Xinhe Community, Fuhai Street, Bao'an District, Shenzhen, Guangdong, China
Telephone:	(86-755)88850135
Fax:	(86-755)88850136
CNAS Registration No.:	CNAS L5868
FCC Registration No.:	448573
IC Registration No.:	21760
CABID:	CN0093

4 List of test equipment

No.	Equipment	Manufacturer	Model	Serial No.	Cal. date	Cal. Due
Conducted Emission at AC power line						
1	EMI Test Receiver	Rohde&schwarz	ESCI3	101368	2023-04-26	2024-04-25
2	Artificial mains network	Schwarzbeck	NSLK 8127	183	2023-05-05	2024-05-04
3	Artificial Mains Network	Rohde & Schwarz	ESH2-Z5	100263	2023-06-03	2024-06-02
Occupied Bandwidth Maximum Conducted Output Power Power Spectral Density Emissions in non-restricted frequency bands						
1	Wideband Radio Communication Tester	Rohde&schwarz	CMW500	149155	2023-04-26	2024-04-25
2	ESG Series Analog Signal Generator	Agilent	E4421B	GB40051240	2023-04-25	2024-04-24
3	PXA Signal Analyzer	Agilent	N9030A	MY51350296	2023-04-25	2024-04-24
4	Synthesized Sweeper	Agilent	83752A	3610A01957	2023-04-25	2024-04-24
5	MXA Signal Analyzer	Agilent	N9020A	MY50143483	2023-04-26	2024-04-25
6	RF Control Unit	Tonscend	JS0806-1	19D8060152	2023-04-26	2024-04-25
7	Band Reject Filter Group	Tonscend	JS0806-F	19D8060160	2023-05-05	2024-05-04
8	ESG Vector Signal Generator	Agilent	N5182A	MY50143762	2023-04-25	2024-04-24
9	DC Power Supply	Agilent	E3632A	MY40027695	2023-05-05	2024-05-04
Band edge emissions (Radiated) Emissions in frequency bands (above 1GHz)						
1	EMI Test Receiver	Rohde&schwarz	ESCI7	101166	2023-04-26	2024-04-25
2	Double Ridged Broadband Horn Antenna	schwarabeck	BBHA 9120 D	2278	2023-05-26	2024-05-25
3	Amplifier	Agilent	8449B	3008A01120	2023-06-26	2024-06-25
4	Multi-device Controller	TuoPu	TPMDC	/	2023-05-04	2024-05-03
5	MXA signal analyzer	Agilent	N9020A	MY54440859	2023-05-05	2024-05-04
Emissions in frequency bands (below 1GHz)						
1	EMI Test Receiver	Rohde&schwarz	ESCI7	101166	2023-04-26	2024-04-25
2	TRILOG Broadband Antenna	schwarabeck	VULB 9163	9163-1338	2023-06-11	2025-06-10
3	Amplifier	Hewlett-Packard	8447F	3113A06184	2023-06-26	2024-06-25
4	Multi-device Controller	TuoPu	TPMDC	/	2023-05-04	2024-05-03
5	Active Loop Antenna	Schwarzbeck	FMZB 1519 B	00066	2023-06-11	2025-06-10

6.1.3 Test Data:

Mode1 / Line: Line / Band: 2400-2483.5 MHz / BW: 2 / CH: 39

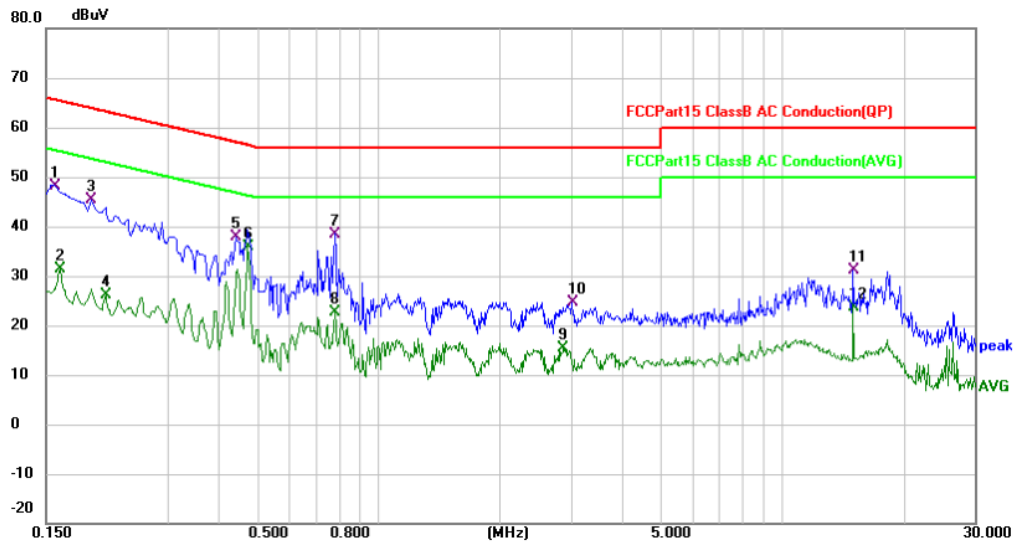

No. Mk.	Freq. MHz	Reading Level dBuV	Correct Factor dB	Measure- ment dBuV	Limit dBuV	Over dB	Detector	Comment
1	0.1580	38.06	10.18	48.24	65.57	-17.33	QP	
2	0.1620	21.13	10.18	31.31	55.36	-24.05	AVG	
3	0.1940	35.28	10.16	45.44	63.86	-18.42	QP	
4	0.2100	15.91	10.16	26.07	53.21	-27.14	AVG	
5	0.4420	27.58	10.21	37.79	57.02	-19.23	QP	
6 *	0.4740	25.76	10.23	35.99	46.44	-10.45	AVG	
7	0.7820	28.36	10.14	38.50	56.00	-17.50	QP	
8	0.7820	12.52	10.14	22.66	46.00	-23.34	AVG	
9	2.8820	4.92	10.40	15.32	46.00	-30.68	AVG	
10	3.0140	14.19	10.41	24.60	56.00	-31.40	QP	
11	15.0020	20.51	10.61	31.12	60.00	-28.88	QP	
12	15.0020	13.11	10.61	23.72	50.00	-26.28	AVG	

Mode1 / Line: Neutral / Band: 2400-2483.5 MHz / BW: 2 / CH: 39

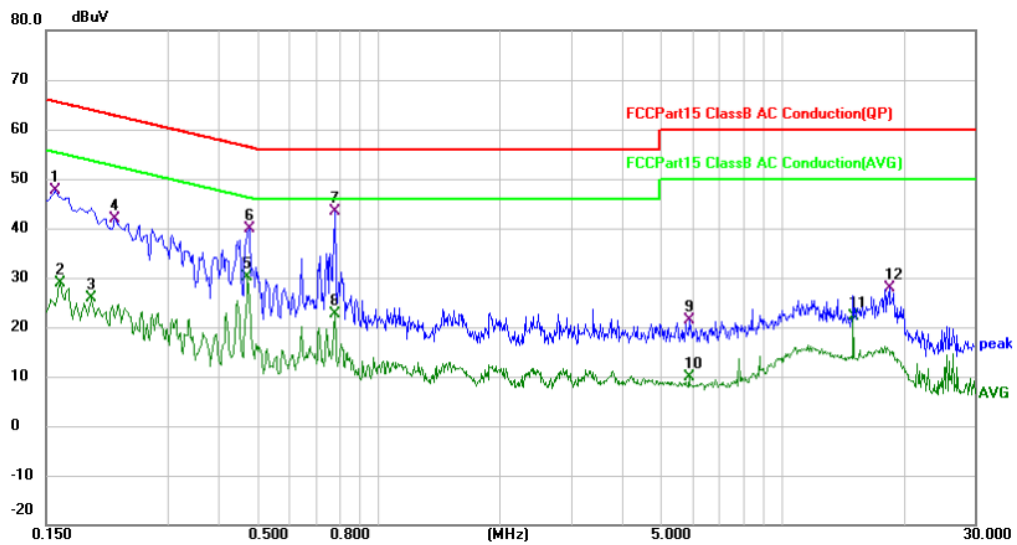

No.	Mk.	Freq. MHz	Reading Level dBuV	Correct Factor dB	Measure- ment dBuV	Limit dBuV	Over dB	Detector	Comment
1		0.1580	37.39	10.13	47.52	65.57	-18.05	QP	
2		0.1620	18.83	10.13	28.96	55.36	-26.40	AVG	
3		0.1940	15.84	10.09	25.93	53.86	-27.93	AVG	
4		0.2220	31.81	10.07	41.88	62.74	-20.86	QP	
5		0.4740	20.09	10.05	30.14	46.44	-16.30	AVG	
6		0.4780	29.75	10.05	39.80	56.37	-16.57	QP	
7	*	0.7820	33.32	10.11	43.43	56.00	-12.57	QP	
8		0.7820	12.49	10.11	22.60	46.00	-23.40	AVG	
9		5.8780	10.72	10.63	21.35	60.00	-38.65	QP	
10		5.8780	-0.81	10.63	9.82	50.00	-40.18	AVG	
11		14.9980	11.58	10.62	22.20	50.00	-27.80	AVG	
12		18.4860	17.34	10.60	27.94	60.00	-32.06	QP	

6.2 Occupied Bandwidth

Test Requirement:	47 CFR 15.247(a)(2)
Test Limit:	Refer to 47 CFR 15.247(a)(2), Systems using digital modulation techniques may operate in the 902-928 MHz, and 2400-2483.5 MHz bands. The minimum 6 dB bandwidth shall be at least 500 kHz.
Test Method:	ANSI C63.10-2013, section 11.8 KDB 558074 D01 15.247 Meas Guidance v05r02
Procedure:	a) Set RBW = 100 kHz. b) Set the VBW \geq [3 × RBW]. c) Detector = peak. d) Trace mode = max hold. e) Sweep = auto couple. f) Allow the trace to stabilize. g) Measure the maximum width of the emission that is constrained by the frequencies associated with the two outermost amplitude points (upper and lower frequencies) that are attenuated by 6 dB relative to the maximum level measured in the fundamental emission.

6.2.1 E.U.T. Operation:

Operating Environment:					
Temperature:	20.3 °C	Humidity:	58 %	Atmospheric Pressure:	98 kPa
Test mode:	Mode1, Mode2				

6.2.2 Test Setup Diagram:

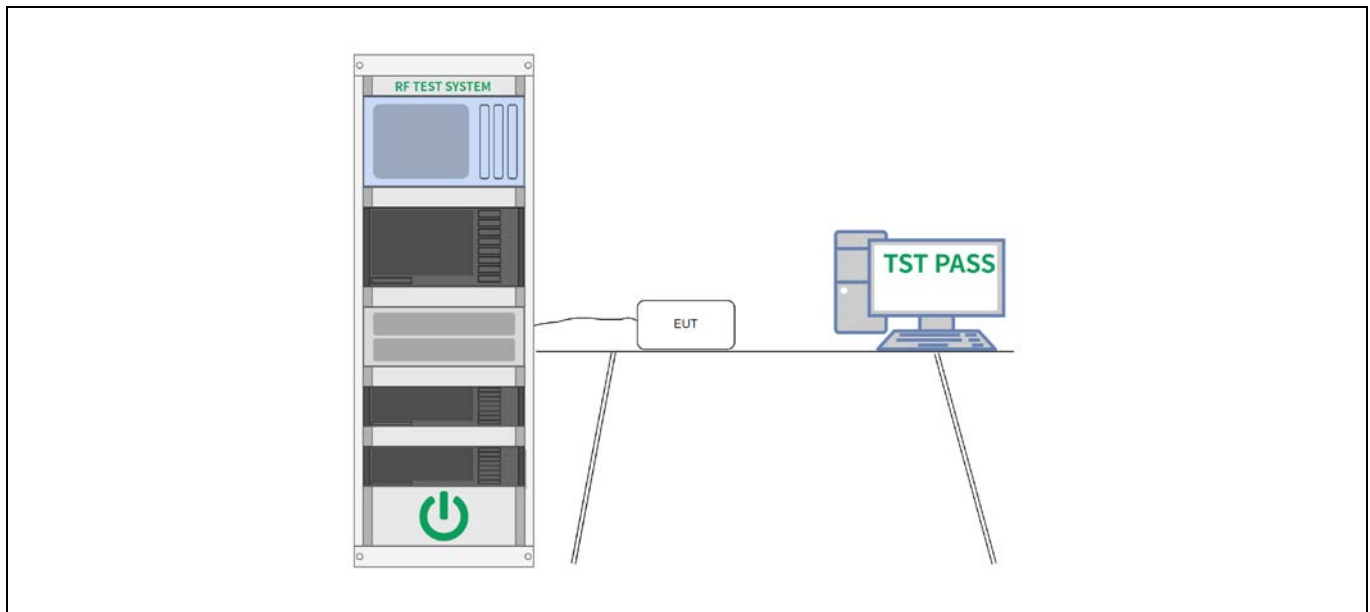

6.2.3 Test Data:

Please Refer to Appendix for Details.

6.3 Maximum Conducted Output Power

Test Requirement:	47 CFR 15.247(b)(3)
Test Limit:	Refer to 47 CFR 15.247(b)(3), For systems using digital modulation in the 902-928 MHz, 2400-2483.5 MHz, and 5725-5850 MHz bands: 1 Watt. As an alternative to a peak power measurement, compliance with the one Watt limit can be based on a measurement of the maximum conducted output power. Maximum Conducted Output Power is defined as the total transmit power delivered to all antennas and antenna elements averaged across all symbols in the signaling alphabet when the transmitter is operating at its maximum power control level. Power must be summed across all antennas and antenna elements. The average must not include any time intervals during which the transmitter is off or is transmitting at a reduced power level. If multiple modes of operation are possible (e.g., alternative modulation methods), the maximum conducted output power is the highest total transmit power occurring in any mode.
Test Method:	ANSI C63.10-2013, section 11.9.1 KDB 558074 D01 15.247 Meas Guidance v05r02
Procedure:	ANSI C63.10-2013, section 11.9.1 Maximum peak conducted output power

6.3.1 E.U.T. Operation:

Operating Environment:					
Temperature:	20.3 °C	Humidity:	58 %	Atmospheric Pressure:	98 kPa
Test mode:	Mode1, Mode2				

6.3.2 Test Setup Diagram:

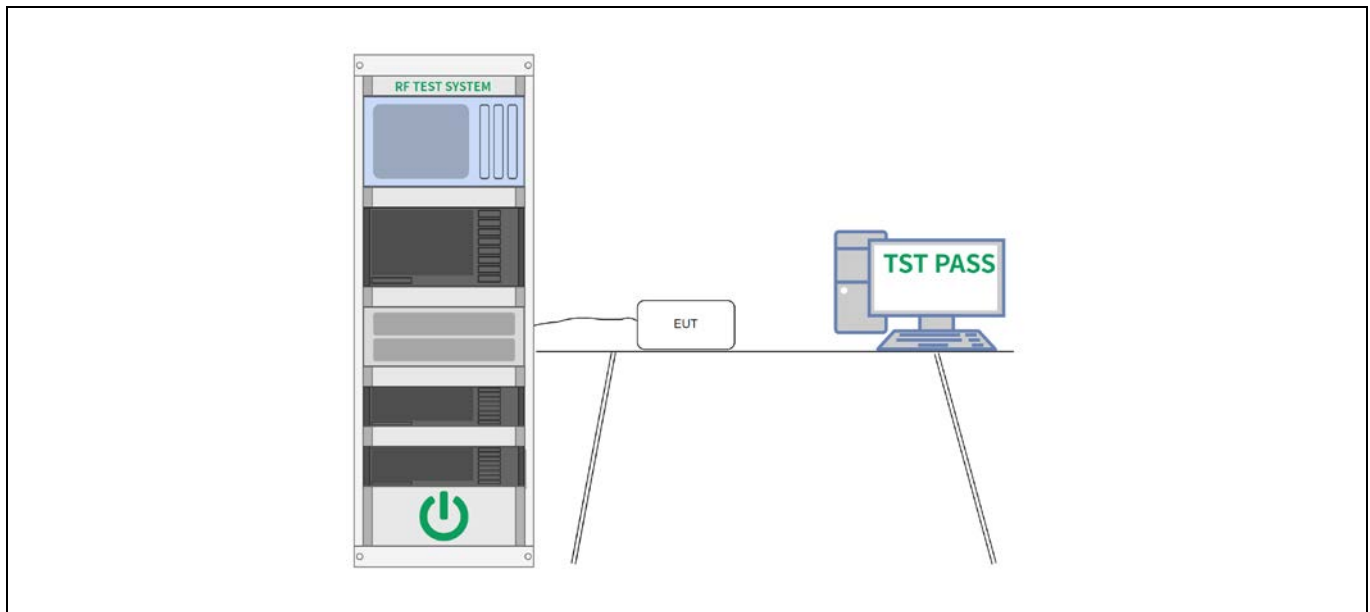

6.3.3 Test Data:

Please Refer to Appendix for Details.

6.4 Power Spectral Density

Test Requirement:	47 CFR 15.247(e)
Test Limit:	Refer to 47 CFR 15.247(e), For digitally modulated systems, the power spectral density conducted from the intentional radiator to the antenna shall not be greater than 8 dBm in any 3 kHz band during any time interval of continuous transmission. This power spectral density shall be determined in accordance with the provisions of paragraph (b) of this section. The same method of determining the conducted output power shall be used to determine the power spectral density.
Test Method:	ANSI C63.10-2013, section 11.10 KDB 558074 D01 15.247 Meas Guidance v05r02
Procedure:	ANSI C63.10-2013, section 11.10, Maximum power spectral density level in the fundamental emission

6.4.1 E.U.T. Operation:

Operating Environment:					
Temperature:	20.3 °C	Humidity:	58 %	Atmospheric Pressure:	98 kPa
Test mode:	Mode1, Mode2				

6.4.2 Test Setup Diagram:

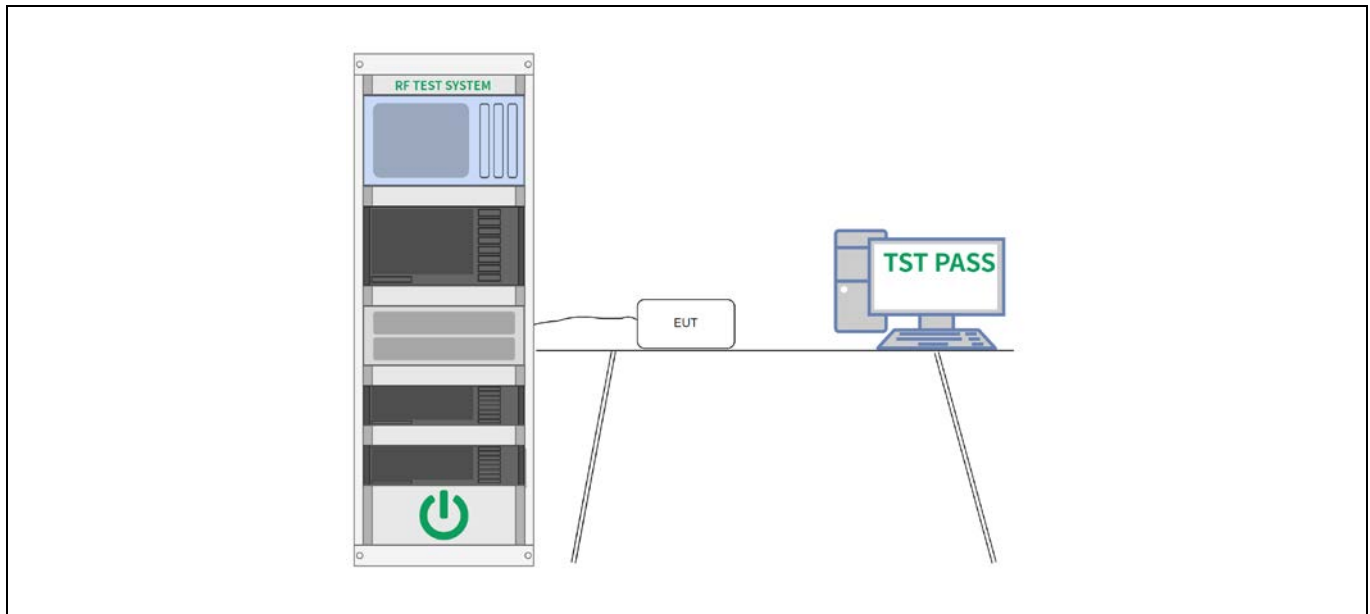

6.4.3 Test Data:

Please Refer to Appendix for Details.

6.5 Emissions in frequency bands

Test Requirement:	47 CFR 15.247(d)
Test Limit:	Refer to 47 CFR 15.247(d), In any 100 kHz bandwidth outside the frequency band in which the spread spectrum or digitally modulated intentional radiator is operating, the radio frequency power that is produced by the intentional radiator shall be at least 20 dB below that in the 100 kHz bandwidth within the band that contains the highest level of the desired power, based on either an RF conducted or a radiated measurement, provided the transmitter demonstrates compliance with the peak conducted power limits. If the transmitter complies with the conducted power limits based on the use of RMS averaging over a time interval, as permitted under paragraph (b)(3) of this section, the attenuation required under this paragraph shall be 30 dB instead of 20 dB. Attenuation below the general limits specified in § 15.209(a) is not required.
Test Method:	ANSI C63.10-2013 section 11.11 KDB 558074 D01 15.247 Meas Guidance v05r02
Procedure:	ANSI C63.10-2013 Section 11.11.1, Section 11.11.2, Section 11.11.3

6.5.1 E.U.T. Operation:

Operating Environment:					
Temperature:	20.3 °C	Humidity:	58 %	Atmospheric Pressure:	98 kPa
Test mode:	Mode1, Mode2				

6.5.2 Test Setup Diagram:

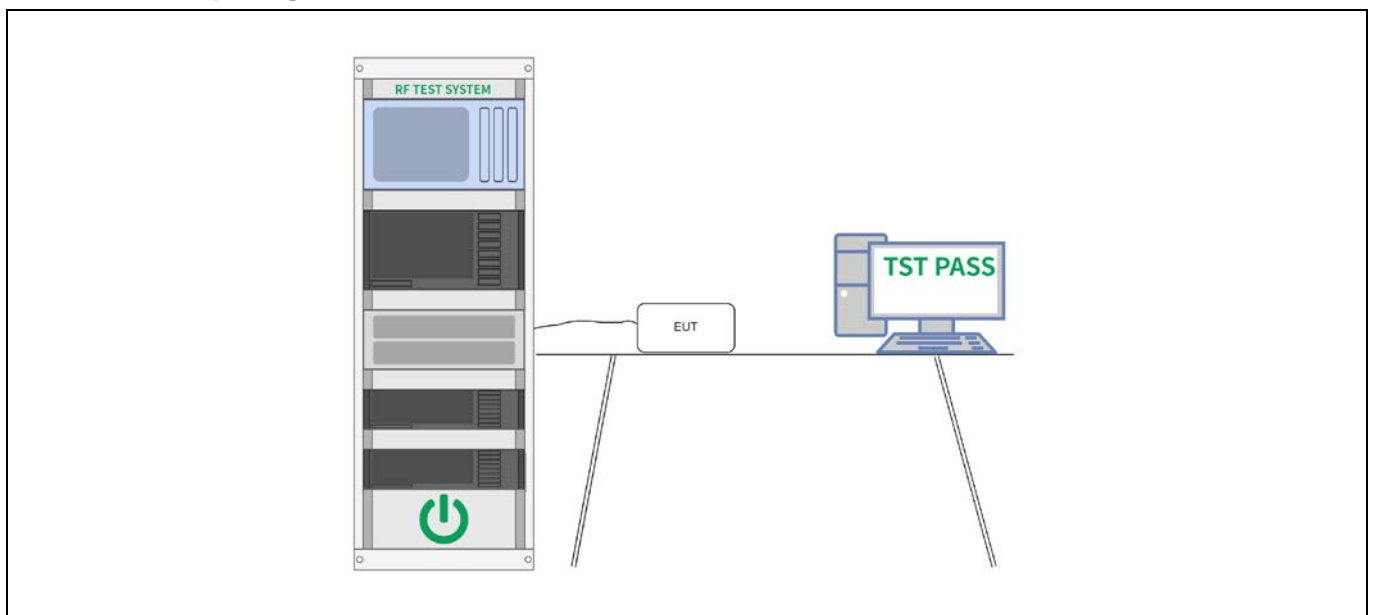

6.5.3 Test Data:

Please Refer to Appendix for Details.

6.6 Band edge emissions (Radiated)

Test Requirement:	Refer to 47 CFR 15.247(d), In addition, radiated emissions which fall in the restricted bands, as defined in § 15.205(a), must also comply with the radiated emission limits specified in § 15.209(a)(see § 15.205(c)).`		
Test Limit:	Frequency (MHz)	Field strength (microvolts/meter)	Measurement distance (meters)
	0.009-0.490	2400/F(kHz)	300
	0.490-1.705	24000/F(kHz)	30
	1.705-30.0	30	30
	30-88	100 **	3
	88-216	150 **	3
	216-960	200 **	3
	Above 960	500	3
	** Except as provided in paragraph (g), fundamental emissions from intentional radiators operating under this section shall not be located in the frequency bands 54-72 MHz, 76-88 MHz, 174-216 MHz or 470-806 MHz. However, operation within these frequency bands is permitted under other sections of this part, e.g., §§ 15.231 and 15.241.		
Test Method:	ANSI C63.10-2013 section 6.10 KDB 558074 D01 15.247 Meas Guidance v05r02		
Procedure:	ANSI C63.10-2013 section 6.10.5.2		

6.6.1 E.U.T. Operation:

Operating Environment:			
Temperature:	29.2 °C	Humidity:	63.6 %
		Atmospheric Pressure:	98 kPa
Test mode:	Mode1, Mode2		
Note:	The amplitude of spurious emissions which are attenuated more than 20 dB below the limits are not reported.		

6.6.2 Test Setup Diagram:

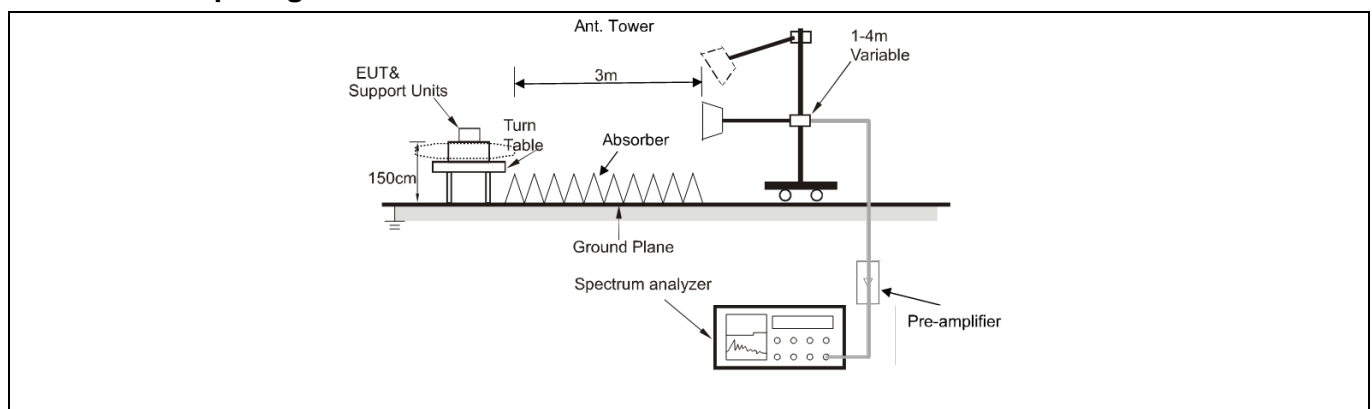

6.6.3 Test Data:

Mode1 / Polarization: Horizontal / Band: 2400-2483.5 MHz / BW: 2 / CH: 00

No.	Mk.	Freq. MHz	Reading Level dBuV	Correct Factor dB	Measure- ment dBuV/m	Limit dBuV/m	Over dB	Detector
1		2310.000	47.26	-2.66	44.60	74.00	-29.40	peak
2		2310.000	37.05	-2.66	34.39	54.00	-19.61	AVG
3		2390.000	47.07	-2.03	45.04	74.00	-28.96	peak
4	*	2390.000	37.32	-2.03	35.29	54.00	-18.71	AVG

Mode1 / Polarization: Vertical / Band: 2400-2483.5 MHz / BW: 2 / CH: 00

No.	Mk.	Freq.	Reading Level	Correct Factor	Measurement	Limit	Over	Detector
		MHz	dBuV	dB	dBuV/m	dBuV/m	dB	
1		2310.000	48.35	-2.66	45.69	74.00	-28.31	peak
2		2310.000	37.14	-2.66	34.48	54.00	-19.52	AVG
3		2390.000	46.74	-2.03	44.71	74.00	-29.29	peak
4	*	2390.000	37.56	-2.03	35.53	54.00	-18.47	AVG

Mode1 / Polarization: Horizontal / Band: 2400-2483.5 MHz / BW: 2 / CH: 39

No.	Mk.	Freq. MHz	Reading Level dBuV	Correct Factor dB	Measure- ment dBuV/m	Limit dBuV/m	Over dB	Detector
1		2483.500	49.24	-1.91	47.33	74.00	-26.67	peak
2	*	2483.500	39.28	-1.91	37.37	54.00	-16.63	AVG
3		2500.000	47.29	-1.80	45.49	74.00	-28.51	peak
4		2500.000	37.89	-1.80	36.09	54.00	-17.91	AVG

Mode1 / Polarization: Vertical / Band: 2400-2483.5 MHz / BW: 2 / CH: 39

No.	Mk.	Freq. MHz	Reading Level dBuV	Correct Factor dB	Measure- ment dBuV/m	Limit dBuV/m	Over dB	Detector
1		2483.500	47.11	-1.91	45.20	74.00	-28.80	peak
2	*	2483.500	38.31	-1.91	36.40	54.00	-17.60	AVG
3		2500.000	46.59	-1.80	44.79	74.00	-29.21	peak
4		2500.000	37.89	-1.80	36.09	54.00	-17.91	AVG

6.7 Radiated emissions (below 1GHz)

Test Requirement:	Refer to 47 CFR 15.247(d), In addition, radiated emissions which fall in the restricted bands, as defined in § 15.205(a), must also comply with the radiated emission limits specified in § 15.209(a)(see § 15.205(c)).`		
Test Limit:	Frequency (MHz)	Field strength (microvolts/meter)	Measurement distance (meters)
	0.009-0.490	2400/F(kHz)	300
	0.490-1.705	24000/F(kHz)	30
	1.705-30.0	30	30
	30-88	100 **	3
	88-216	150 **	3
	216-960	200 **	3
	Above 960	500	3
	** Except as provided in paragraph (g), fundamental emissions from intentional radiators operating under this section shall not be located in the frequency bands 54-72 MHz, 76-88 MHz, 174-216 MHz or 470-806 MHz. However, operation within these frequency bands is permitted under other sections of this part, e.g., §§ 15.231 and 15.241.		
Test Method:	ANSI C63.10-2013 section 6.6.4 KDB 558074 D01 15.247 Meas Guidance v05r02		
Procedure:	ANSI C63.10-2013 section 6.6.4		

6.7.1 E.U.T. Operation:

Operating Environment:					
Temperature:	29.2 °C	Humidity:	63.6 %	Atmospheric Pressure:	98 kPa
Test mode:	Mode1, Mode2				
Note:	The amplitude of spurious emissions which are attenuated more than 20 dB below the limits are not reported. All modes of operation of the EUT were investigated, and only the worst-case results are reported. There were no emissions found below 30MHz within 20dB of the limit.				

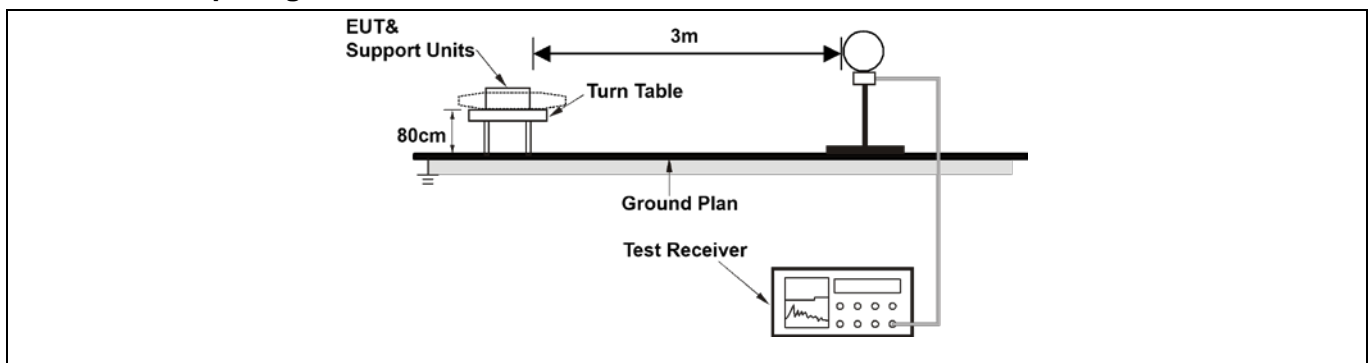
6.7.2 Test Setup Diagram:

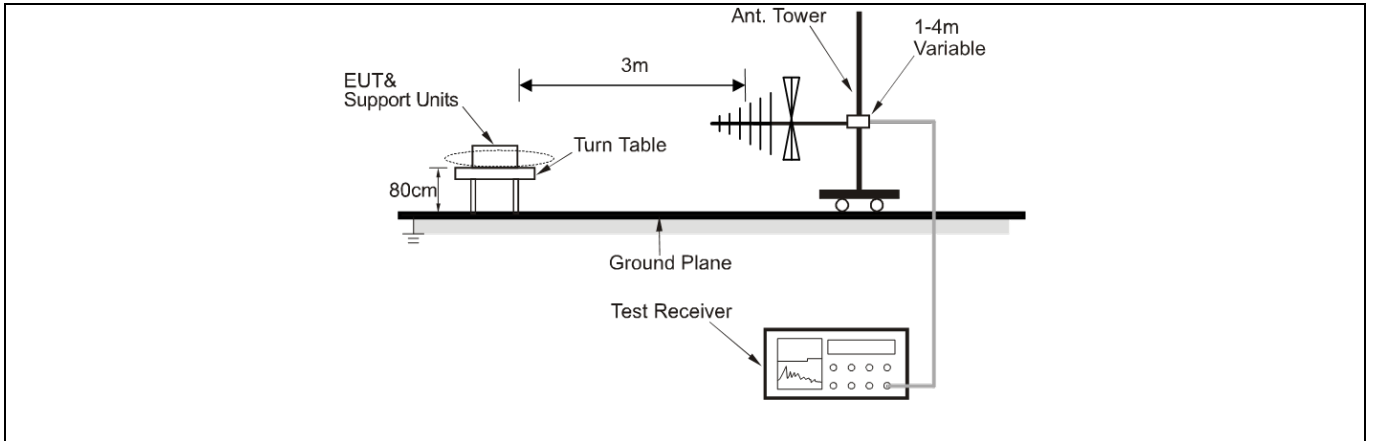

6.7.3 Test Data:

Mode1 / Polarization: Horizontal / Band: 2400-2483.5 MHz / BW: 2 / CH: 39

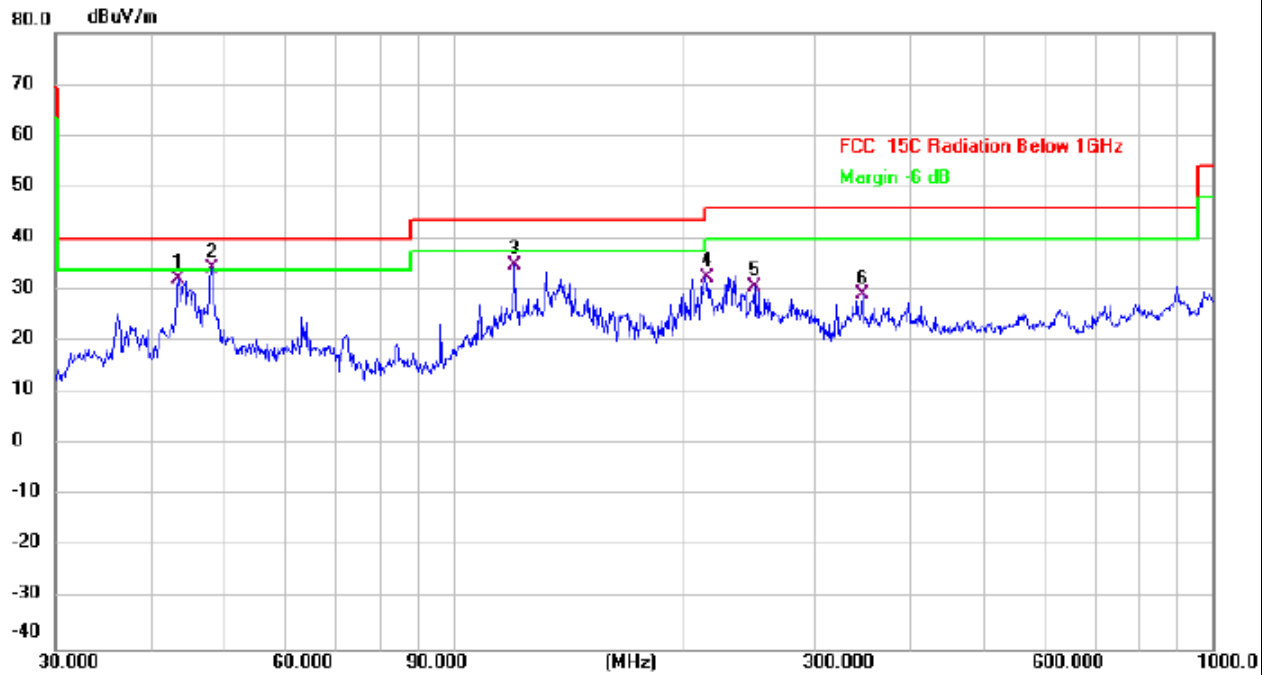

No.	Mk.	Freq. MHz	Reading Level dBuV	Correct Factor dB	Measure- ment dBuV/m	Limit dBuV/m	Over dB	Detector	Comment
1		43.5056	39.66	-7.59	32.07	40.00	-7.93	QP	
2	*	47.9939	41.80	-7.51	34.29	40.00	-5.71	QP	
3		120.6991	45.20	-10.42	34.78	43.50	-8.72	QP	
4		215.2677	41.41	-9.07	32.34	43.50	-11.16	QP	
5		249.4250	38.52	-7.74	30.78	46.00	-15.22	QP	
6		346.8091	33.20	-4.11	29.09	46.00	-16.91	QP	

Mode1 / Polarization: Vertical / Band: 2400-2483.5 MHz / BW: 2 / CH: 39

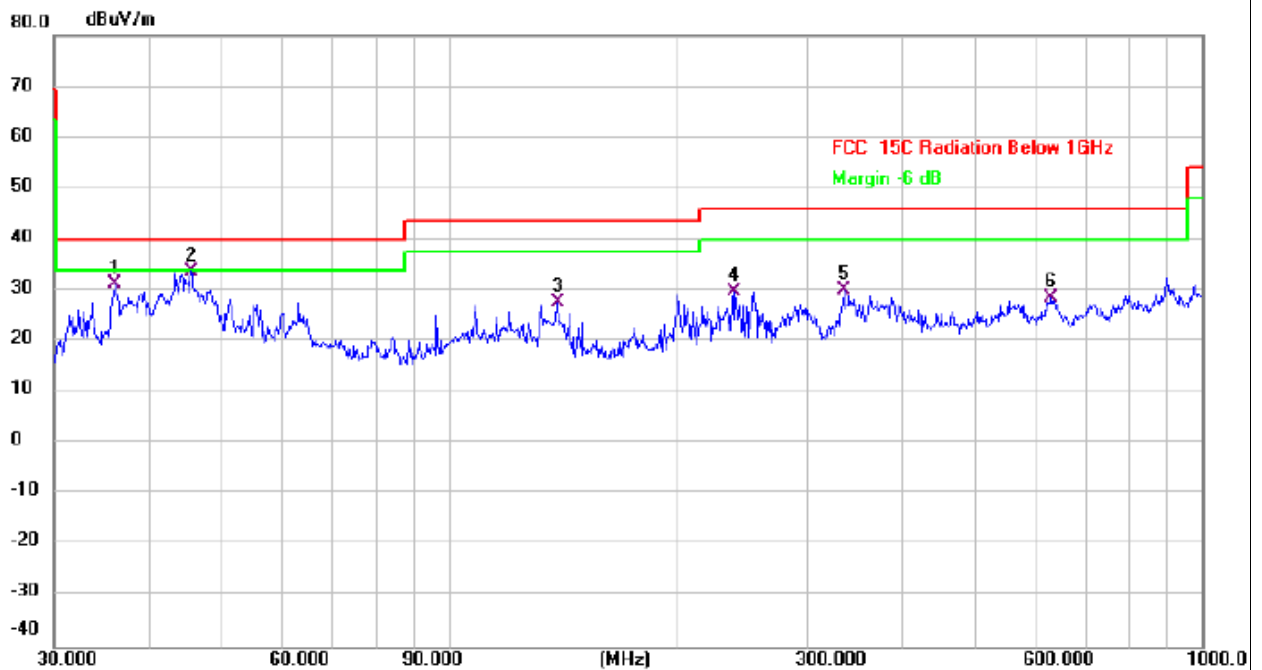

No.	Mk.	Freq. MHz	Reading Level dBuV	Correct Factor dB	Measure- ment dBuV/m	Limit dBuV/m	Over dB	Detector	Comment
1		36.1269	40.98	-9.75	31.23	40.00	-8.77	QP	
2	*	45.5347	41.12	-7.32	33.80	40.00	-6.20	QP	
3		139.3610	37.50	-9.76	27.74	43.50	-15.76	QP	
4		239.1470	36.53	-6.92	29.61	46.00	-16.39	QP	
5		334.8586	34.37	-4.24	30.13	46.00	-15.87	QP	
6		631.6883	28.20	0.27	28.47	46.00	-17.53	QP	

6.8 Radiated emissions (above 1GHz)

Test Requirement:	In addition, radiated emissions which fall in the restricted bands, as defined in § 15.205(a), must also comply with the radiated emission limits specified in § 15.209(a)(see § 15.205(c)).`		
Test Limit:	Frequency (MHz)	Field strength (microvolts/meter)	Measurement distance (meters)
	0.009-0.490	2400/F(kHz)	300
	0.490-1.705	24000/F(kHz)	30
	1.705-30.0	30	30
	30-88	100 **	3
	88-216	150 **	3
	216-960	200 **	3
	Above 960	500	3
	** Except as provided in paragraph (g), fundamental emissions from intentional radiators operating under this section shall not be located in the frequency bands 54-72 MHz, 76-88 MHz, 174-216 MHz or 470-806 MHz. However, operation within these frequency bands is permitted under other sections of this part, e.g., §§ 15.231 and 15.241.		
Test Method:	ANSI C63.10-2013 section 6.6.4 KDB 558074 D01 15.247 Meas Guidance v05r02		
Procedure:	ANSI C63.10-2013 section 6.6.4		

6.8.1 E.U.T. Operation:

Operating Environment:			
Temperature:	29.2 °C	Humidity:	63.6 %
		Atmospheric Pressure:	98 kPa
Test mode:	Mode1, Mode2		
Note: Test frequency are from 1GHz to 25GHz, the amplitude of spurious emissions which are attenuated more than 20 dB below the limits are not reported. All modes of operation of the EUT were investigated, and only the worst-case results are reported.			

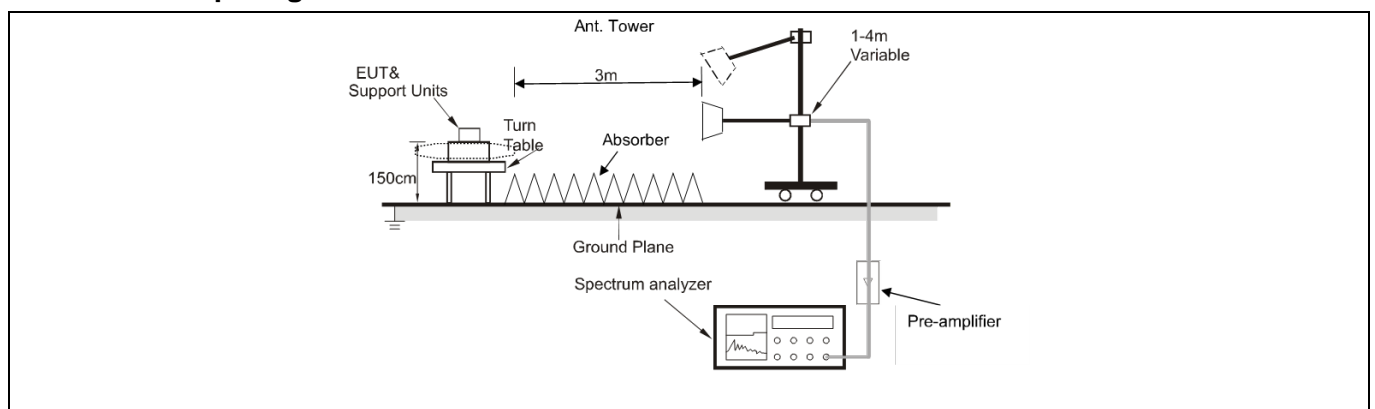
6.8.2 Test Setup Diagram:

6.8.3 Test Data:

Mode1 / Polarization: Horizontal / Band: 2400-2483.5 MHz / BW: 2 / CH: 00

No.	Mk.	Freq. MHz	Reading Level dBuV	Correct Factor dB	Measure- ment dBuV/m	Limit dBuV/m	Over dB	Detector	C
1		4804.000	39.33	2.74	42.07	74.00	-31.93	peak	
2		4804.000	31.26	2.74	34.00	54.00	-20.00	AVG	
3		7206.000	39.94	9.34	49.28	74.00	-24.72	peak	
4		7206.000	33.85	9.34	43.19	54.00	-10.81	AVG	
5		9608.000	41.46	10.49	51.95	74.00	-22.05	peak	
6	*	9608.000	34.76	10.49	45.25	54.00	-8.75	AVG	

Mode1 / Polarization: Vertical / Band: 2400-2483.5 MHz / BW: 2 / CH: 00

No. Mk.	Freq. MHz	Reading Level dBuV	Correct Factor dB	Measure- ment dBuV/m	Limit dBuV/m	Over dB	Detector
1	4804.000	40.77	2.74	43.51	74.00	-30.49	peak
2	4804.000	33.51	2.74	36.25	54.00	-17.75	AVG
3	7206.000	40.46	9.34	49.80	74.00	-24.20	peak
4	7206.000	32.81	9.34	42.15	54.00	-11.85	AVG
5	9608.000	41.78	10.49	52.27	74.00	-21.73	peak
6 *	9608.000	36.09	10.49	46.58	54.00	-7.42	AVG

Mode1 / Polarization: Horizontal / Band: 2400-2483.5 MHz / BW: 2 / CH: 19

No.	Mk.	Freq. MHz	Reading Level dBuV	Correct Factor dB	Measure- ment dBuV/m	Limit dBuV/m	Over dB	Detector
1		4880.000	41.15	3.05	44.20	74.00	-29.80	peak
2		4880.000	34.97	3.05	38.02	54.00	-15.98	AVG
3		7320.000	40.22	9.02	49.24	74.00	-24.76	peak
4		7320.000	33.72	9.02	42.74	54.00	-11.26	AVG
5		9760.000	41.87	12.01	53.88	74.00	-20.12	peak
6	*	9760.000	35.18	12.01	47.19	54.00	-6.81	AVG

Mode1 / Polarization: Vertical / Band: 2400-2483.5 MHz / BW: 2 / CH: 19

No.	Mk.	Freq. MHz	Reading Level dBuV	Correct Factor dB	Measure- ment dBuV/m	Limit dBuV/m	Over dB	Detector
1		4880.000	40.18	3.05	43.23	74.00	-30.77	peak
2		4880.000	33.20	3.05	36.25	54.00	-17.75	AVG
3		7320.000	41.21	9.02	50.23	74.00	-23.77	peak
4		7320.000	35.09	9.02	44.11	54.00	-9.89	AVG
5		9760.000	41.54	12.01	53.55	74.00	-20.45	peak
6	*	9760.000	35.04	12.01	47.05	54.00	-6.95	AVG

Mode1 / Polarization: Horizontal / Band: 2400-2483.5 MHz / BW: 2 / CH: 39

No.	Mk.	Freq. MHz	Reading Level dBuV	Correct Factor dB	Measure- ment dBuV/m	Limit dBuV/m	Over dB	Detector
1		4960.000	41.01	3.52	44.53	74.00	-29.47	peak
2		4960.000	34.80	3.52	38.32	54.00	-15.68	AVG
3		7440.000	40.03	9.16	49.19	74.00	-24.81	peak
4		7440.000	33.84	9.16	43.00	54.00	-11.00	AVG
5		9920.000	40.73	11.74	52.47	74.00	-21.53	peak
6	*	9920.000	34.45	11.74	46.19	54.00	-7.81	AVG

Mode1 / Polarization: Vertical / Band: 2400-2483.5 MHz / BW: 2 / CH: 39

No.	Mk.	Freq. MHz	Reading Level dBuV	Correct Factor dB	Measure- ment dBuV/m	Limit dBuV/m	Over dB	Detector
1		4960.000	40.57	3.52	44.09	74.00	-29.91	peak
2		4960.000	34.03	3.52	37.55	54.00	-16.45	AVG
3		7440.000	40.21	9.16	49.37	74.00	-24.63	peak
4		7440.000	34.13	9.16	43.29	54.00	-10.71	AVG
5		9920.000	40.65	11.74	52.39	74.00	-21.61	peak
6	*	9920.000	34.48	11.74	46.22	54.00	-7.78	AVG

Photographs of the test setup

Refer to Appendix - Test Setup Photos

Photographs of the EUT

Refer to Appendix - EUT Photos

Appendix

Appendix A: DTS Bandwidth

Test Result

Test Mode	Antenna	Frequency [MHz]	DTS BW [MHz]	Limit [MHz]	Verdict
BLE_1M	Ant1	2402	0.652	0.5	PASS
		2440	0.620	0.5	PASS
		2480	0.620	0.5	PASS
BLE_2M	Ant1	2402	1.088	0.5	PASS
		2440	1.040	0.5	PASS
		2480	1.080	0.5	PASS

Test Graphs

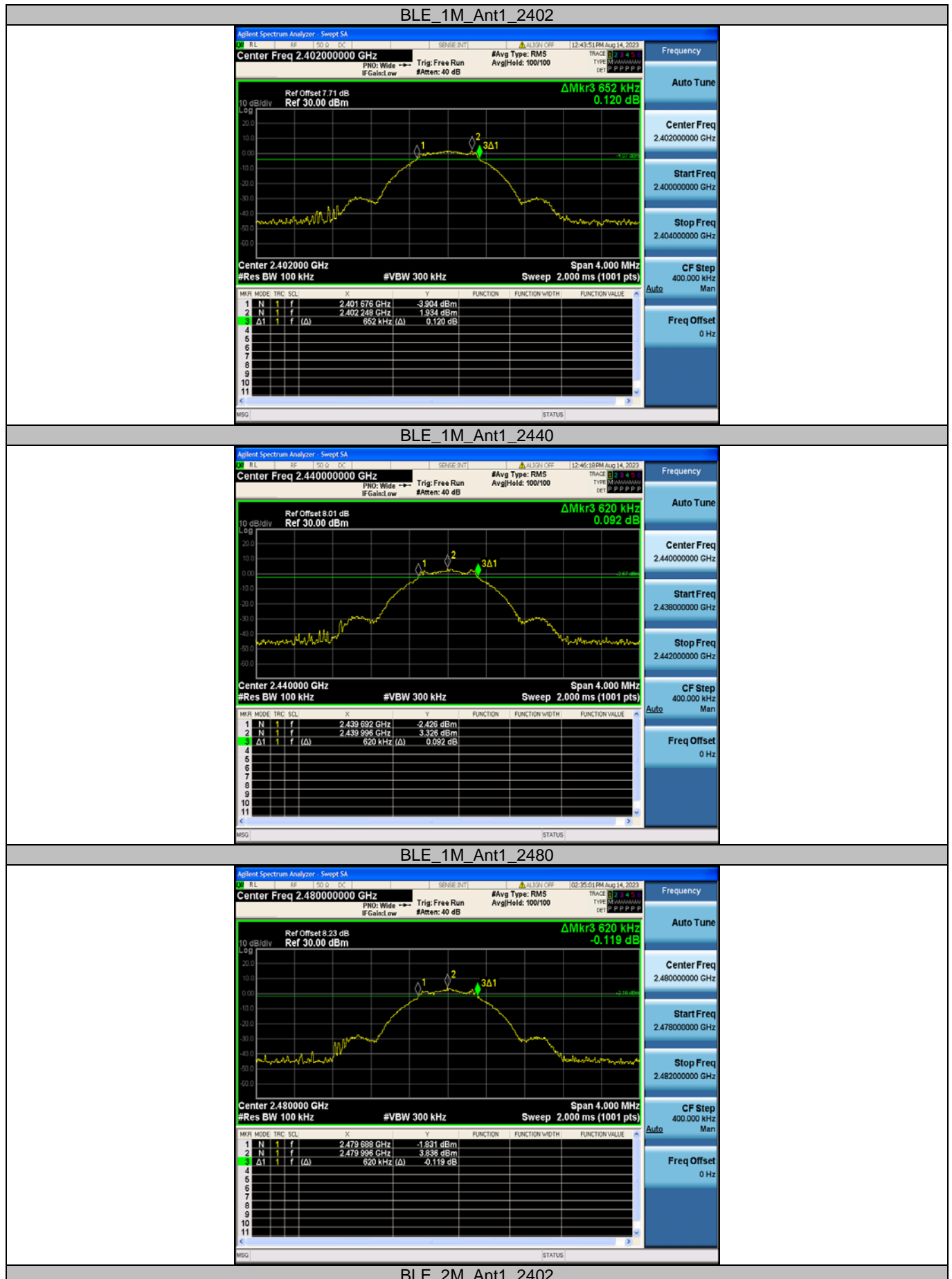



BLE_2M_Ant1_2440



BLE_2M_Ant1_2480



Appendix B: Maximum conducted output power

Test Result-Peak

Test Mode	Antenna	Frequency [MHz]	Conducted Peak Power [dBm]	Limit [dBm]	Verdict
BLE_1M	Ant1	2402	3.27	≤30	PASS
		2440	4.03	≤30	PASS
		2480	4.2	≤30	PASS
BLE_2M	Ant1	2402	3.19	≤30	PASS
		2440	4.05	≤30	PASS
		2480	4.17	≤30	PASS

Test Graphs

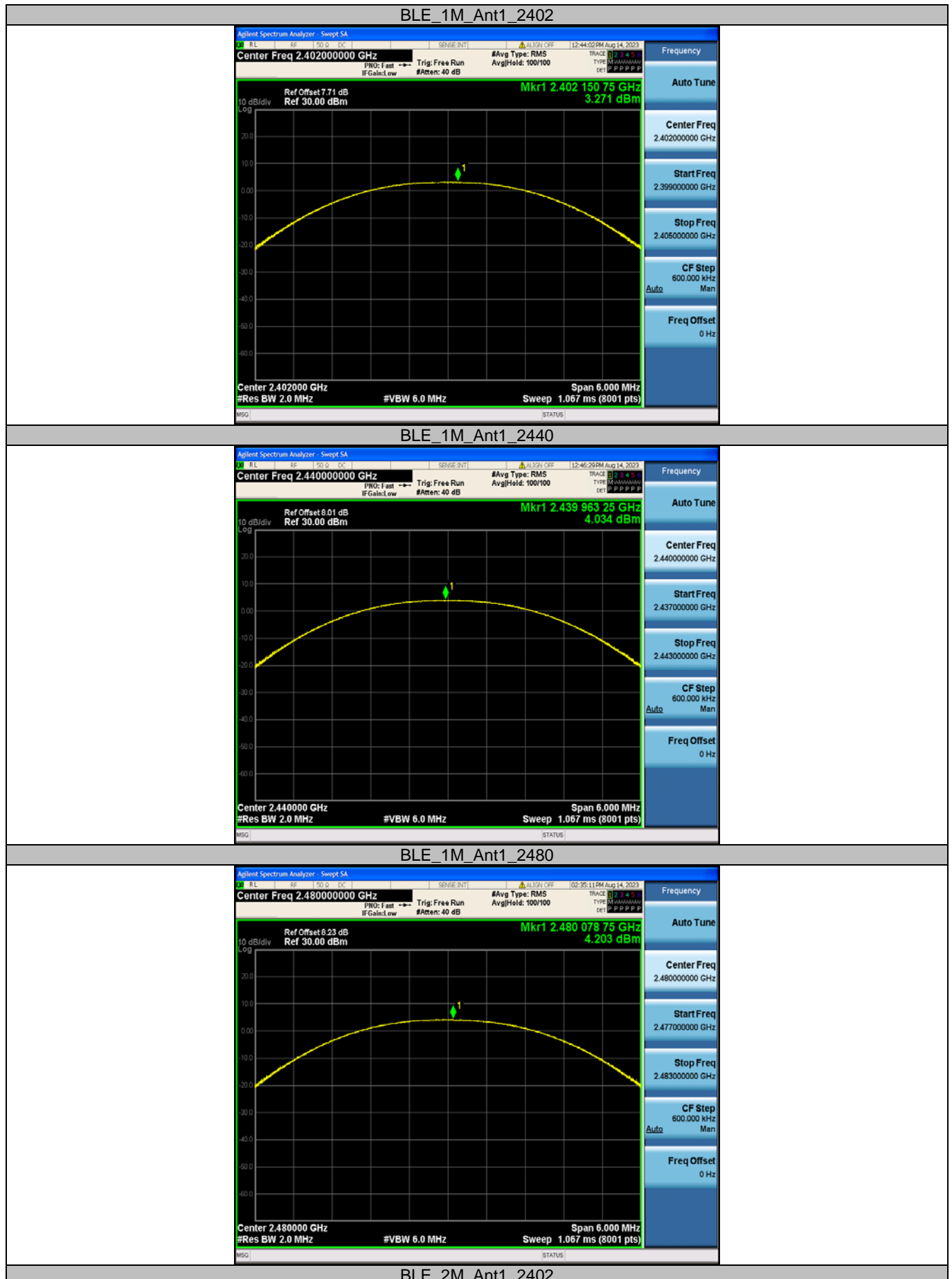

BLE_2M_Ant1_2402

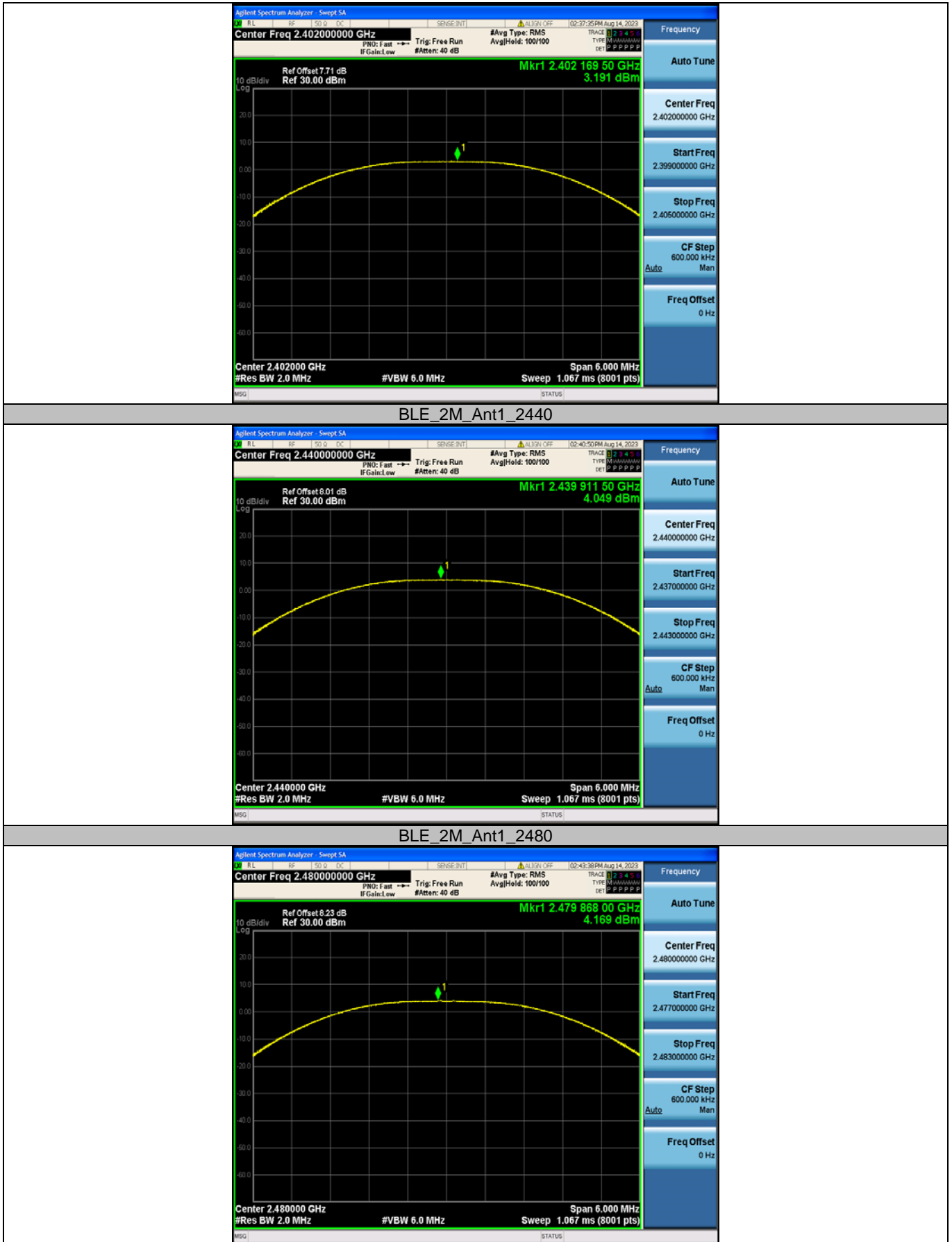

Appendix C: Maximum power spectral density

Test Result

Test Mode	Antenna	Frequency [MHz]	Result [dBm/3kHz]	Limit [dBm/3kHz]	Verdict
BLE_1M	Ant1	2402	-12.7	≤8.00	PASS
		2440	-11.87	≤8.00	PASS
		2480	-11.73	≤8.00	PASS
BLE_2M	Ant1	2402	-14.28	≤8.00	PASS
		2440	-13.49	≤8.00	PASS
		2480	-13.49	≤8.00	PASS

Test Graphs

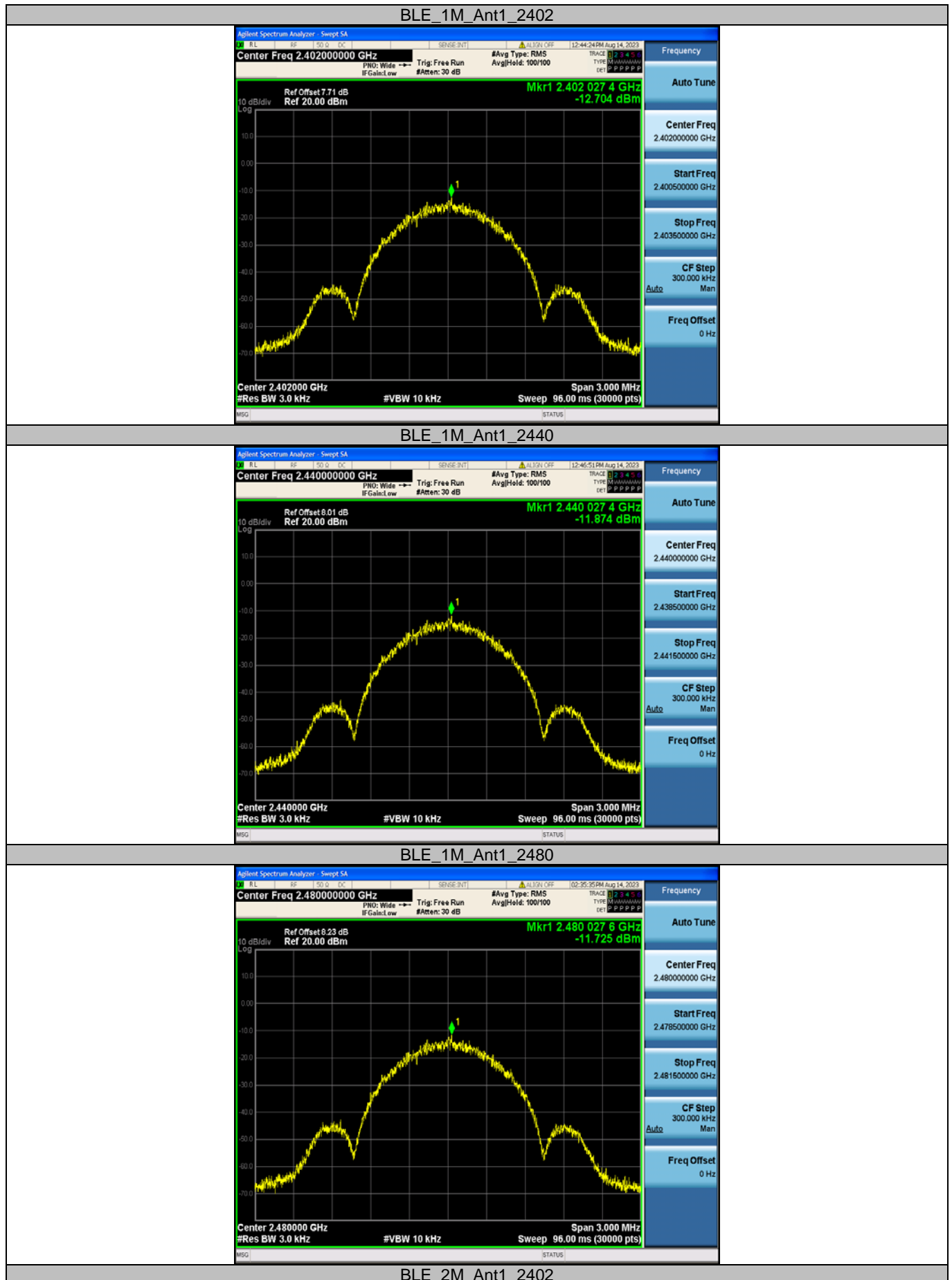

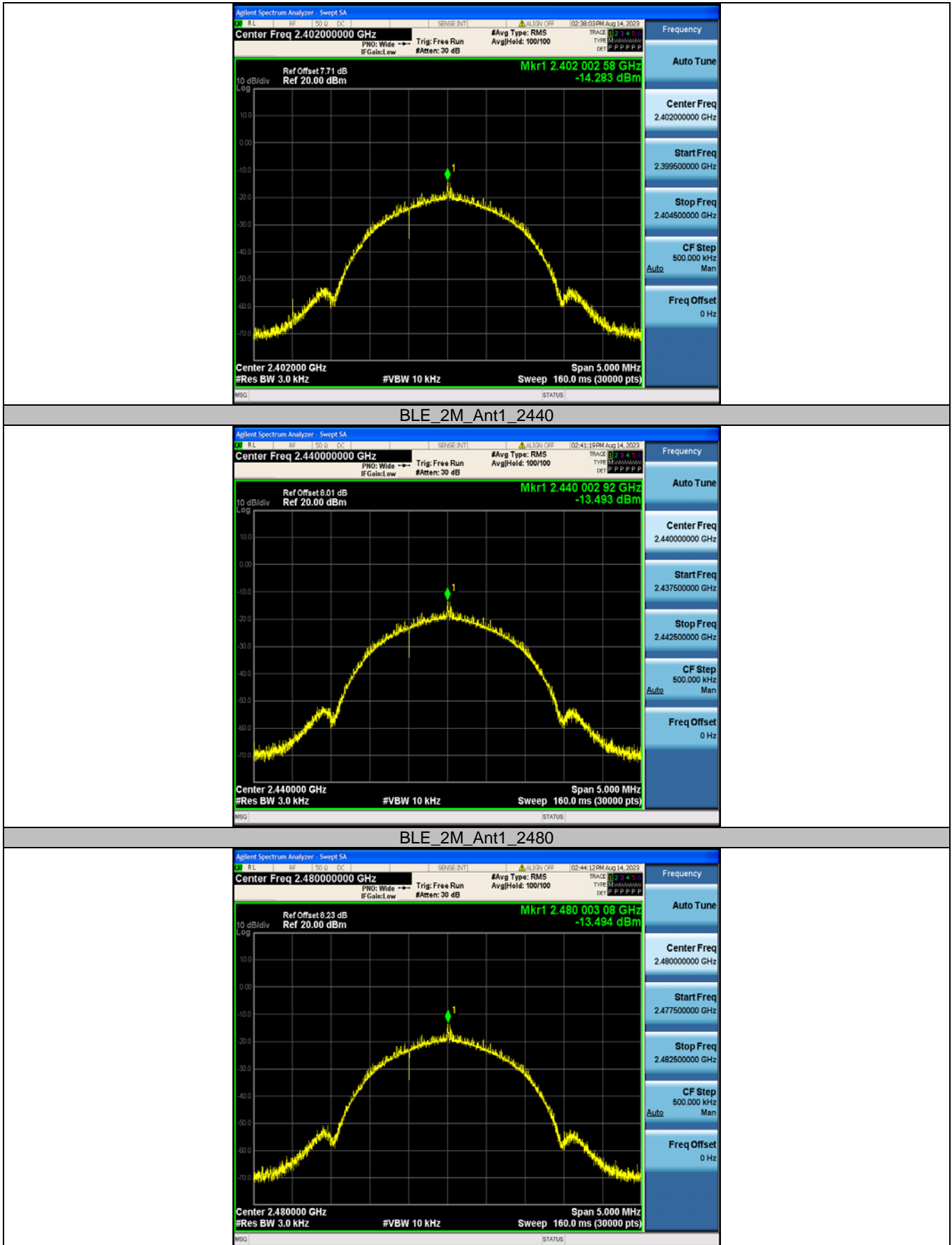

Appendix D: Band edge measurements

Test Graphs



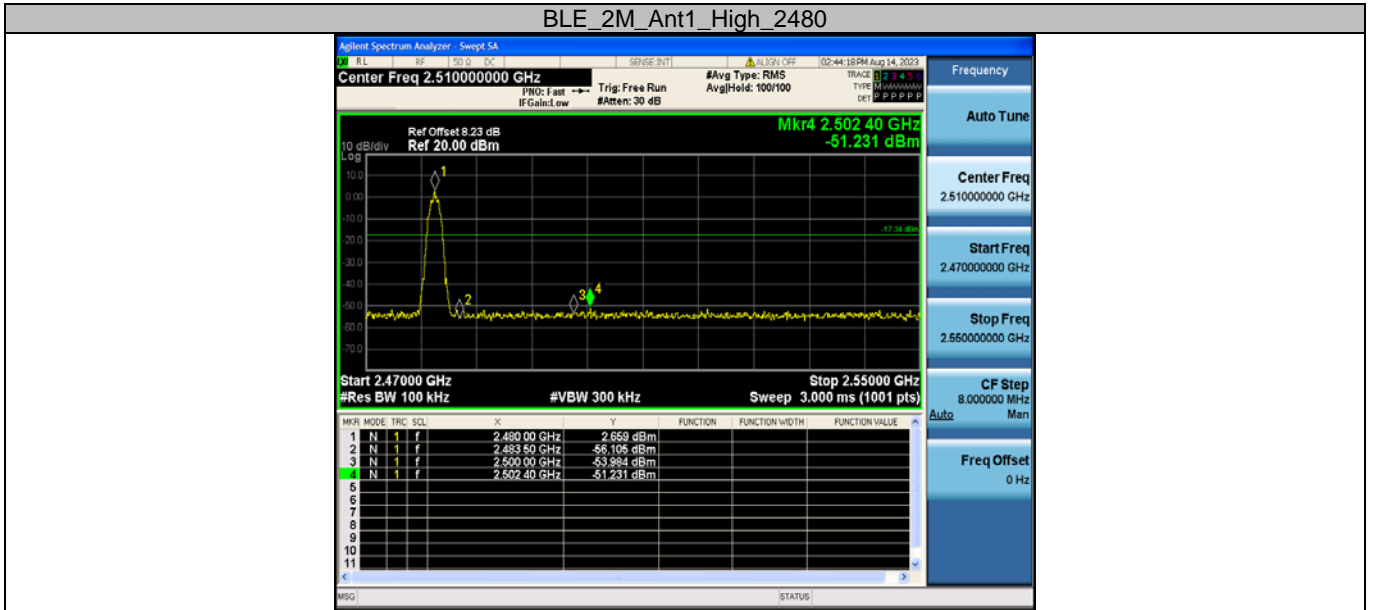

Appendix E: Conducted Spurious Emission

Test Graphs



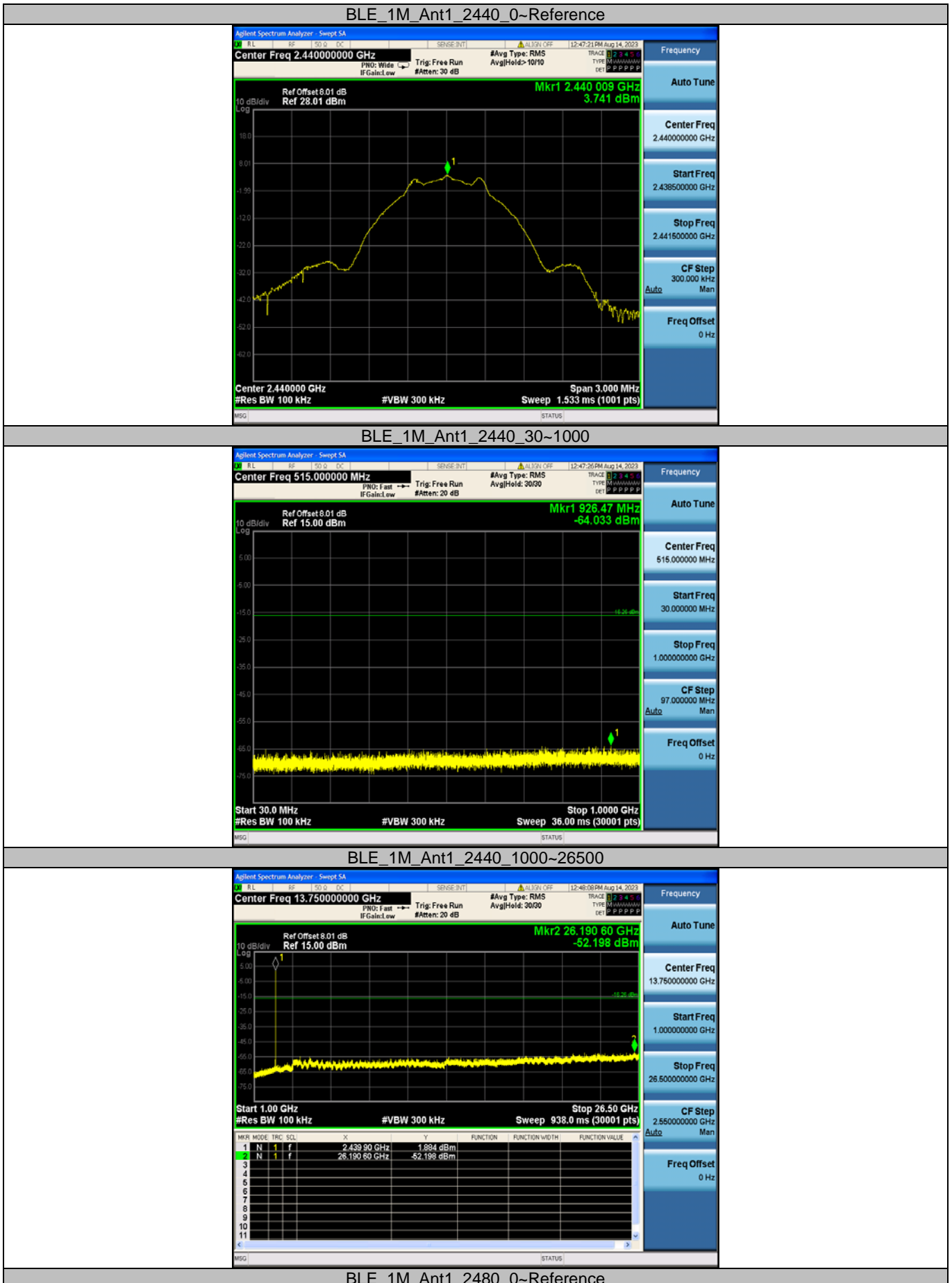



BLE_1M_Ant1_2480_30~1000

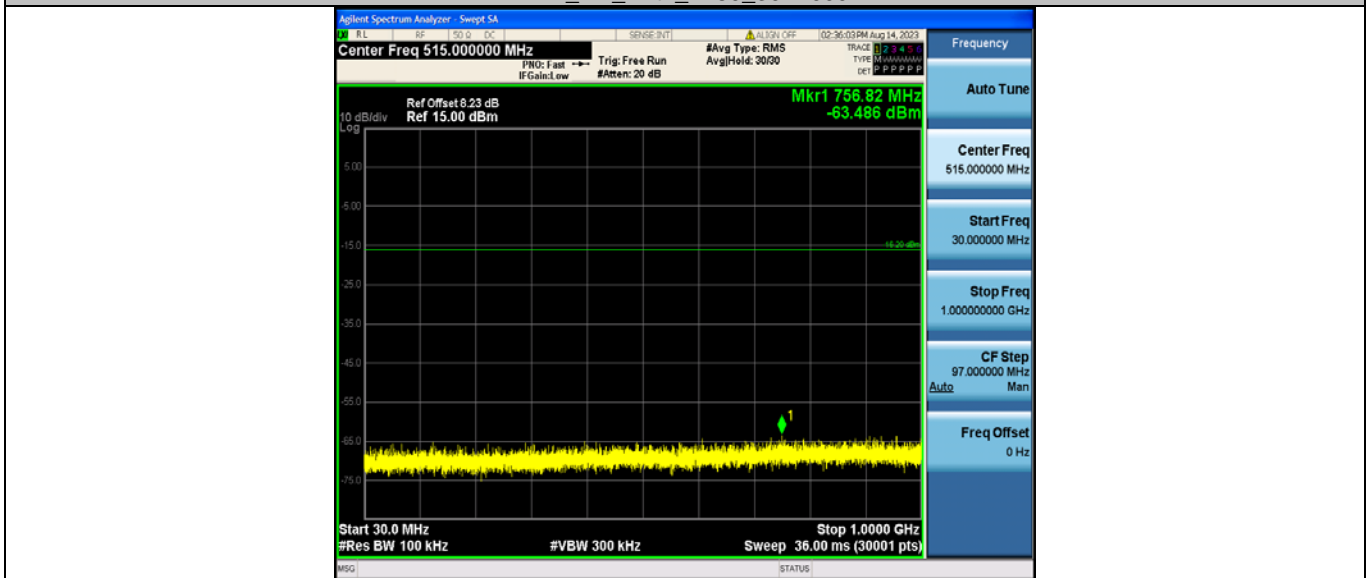

BLE_1M_Ant1_2480_1000~26500

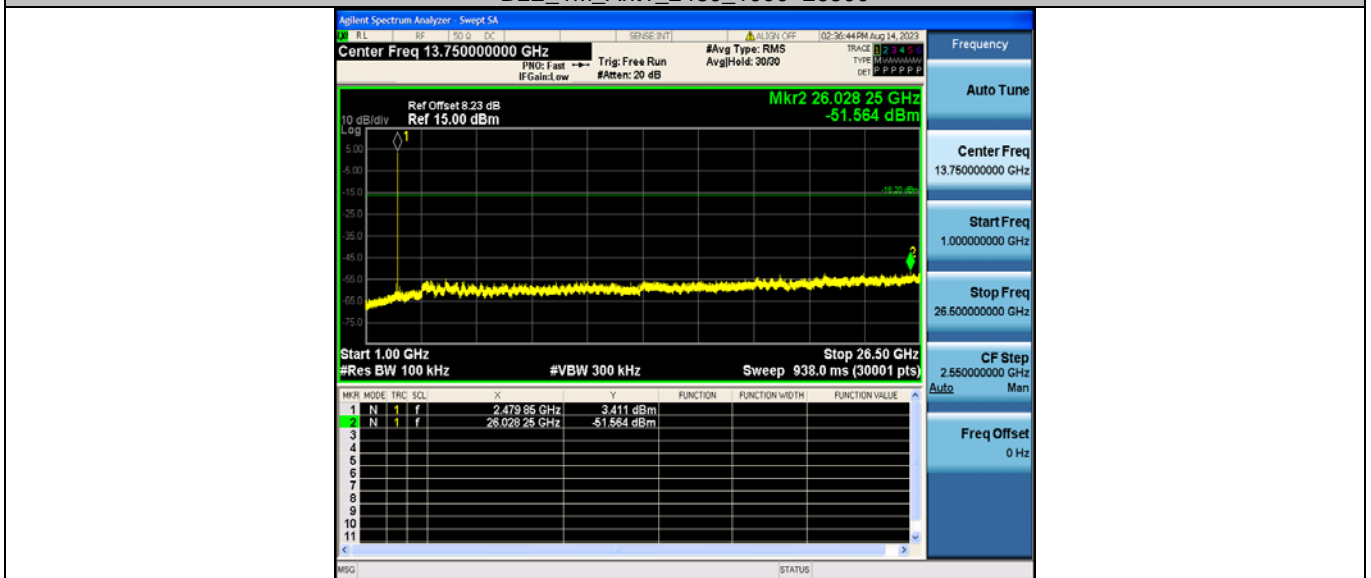

BLE_2M_Ant1_2402_0~Reference



BLE_2M_Ant1_2402_30~1000

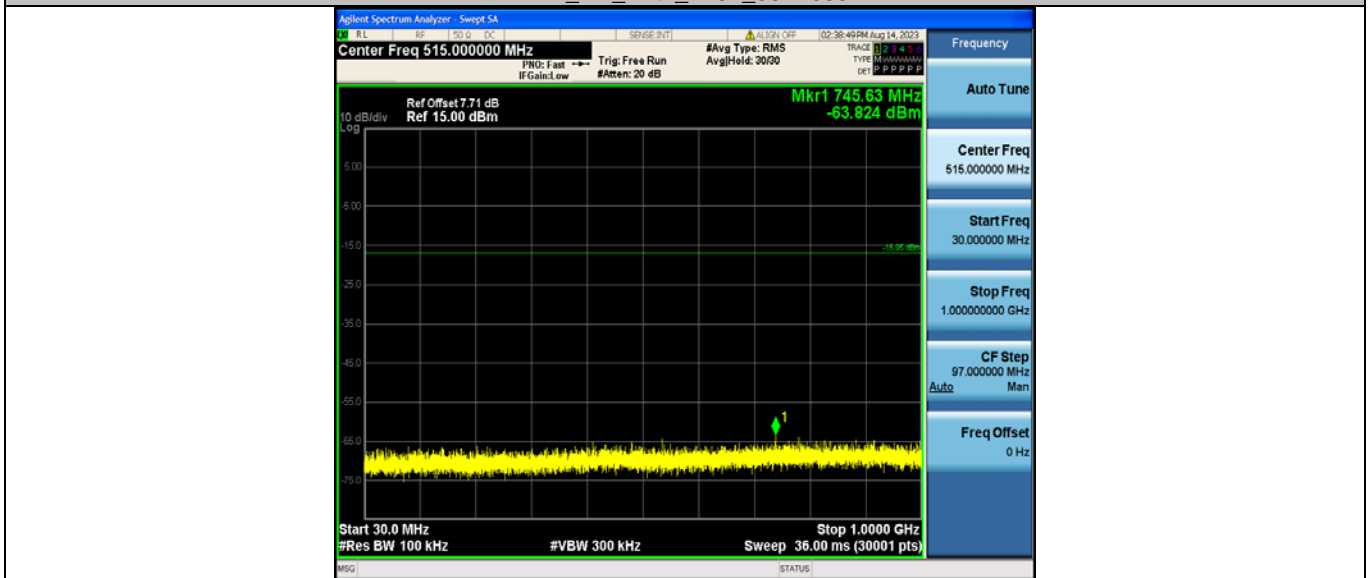

BLE_2M_Ant1_2402_1000~26500

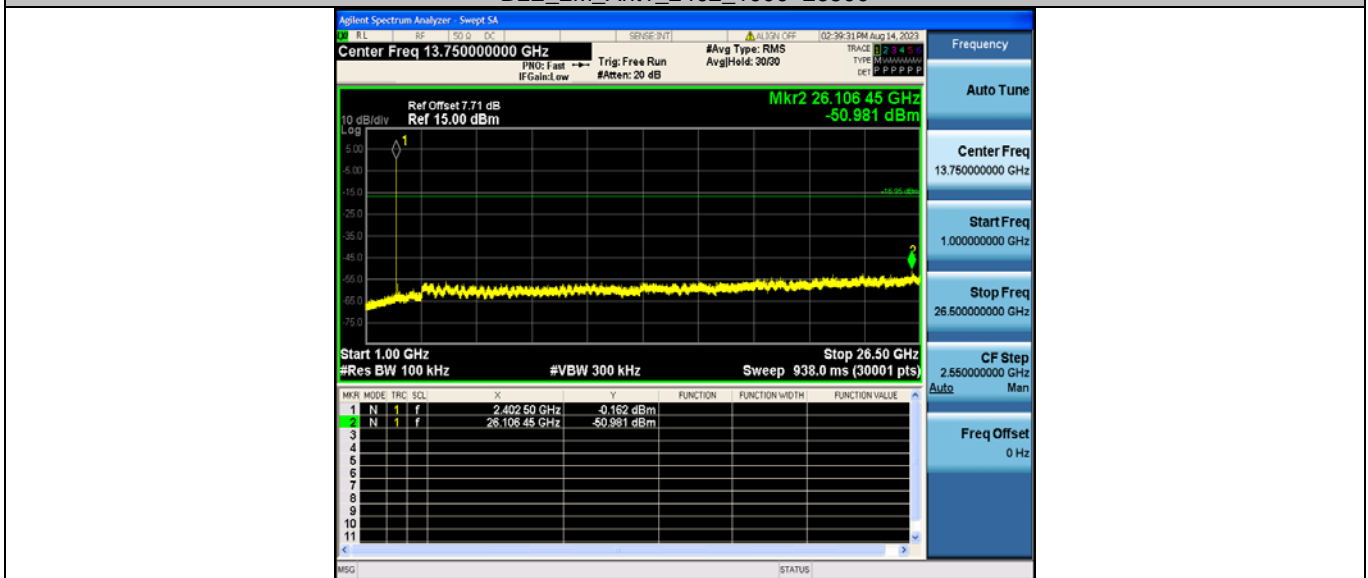

BLE_2M_Ant1_2440_0~Reference

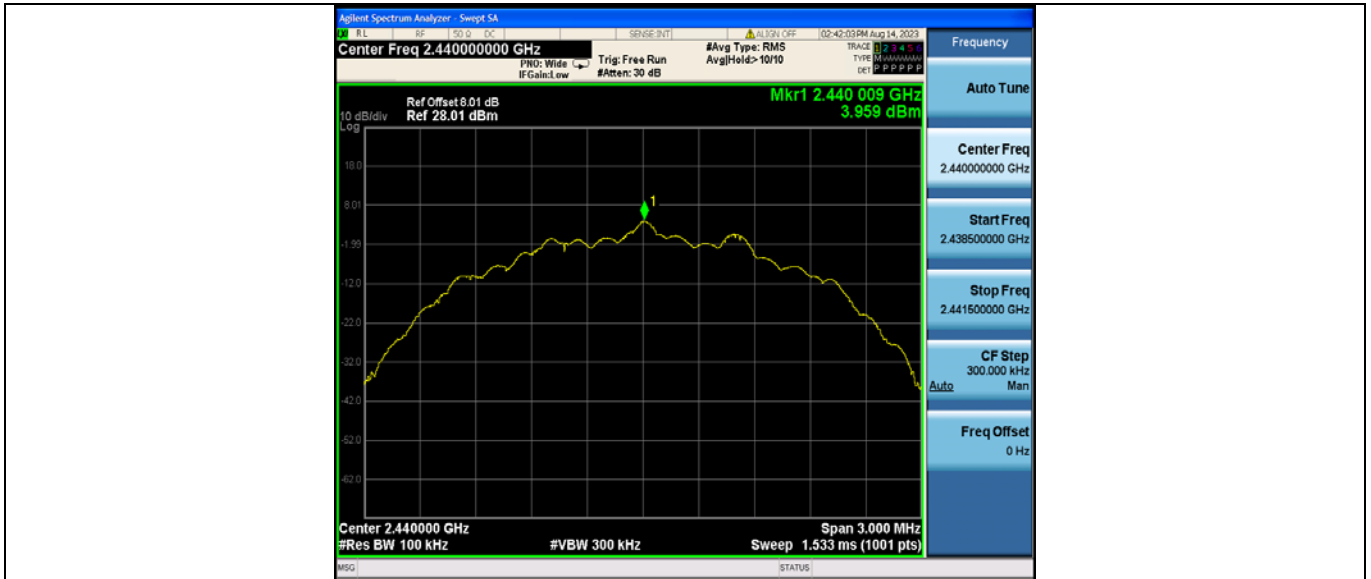

BLE_2M_Ant1_2440_30~1000

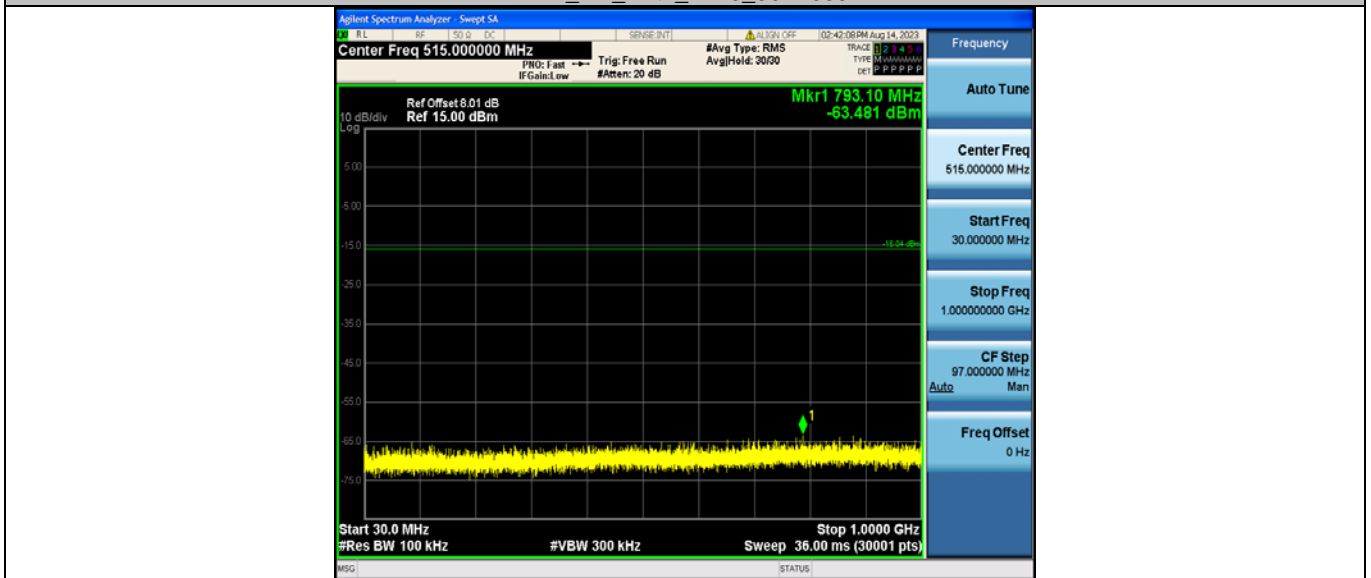

BLE_2M_Ant1_2440_1000~26500

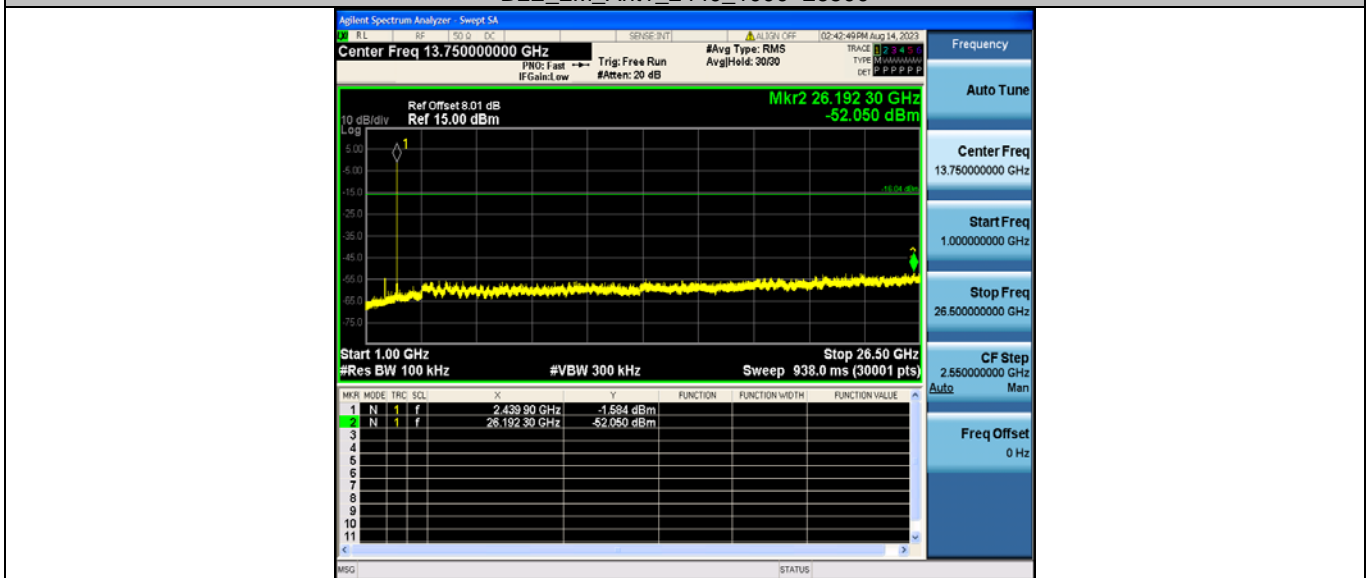

BLE_2M_Ant1_2480_0~Reference

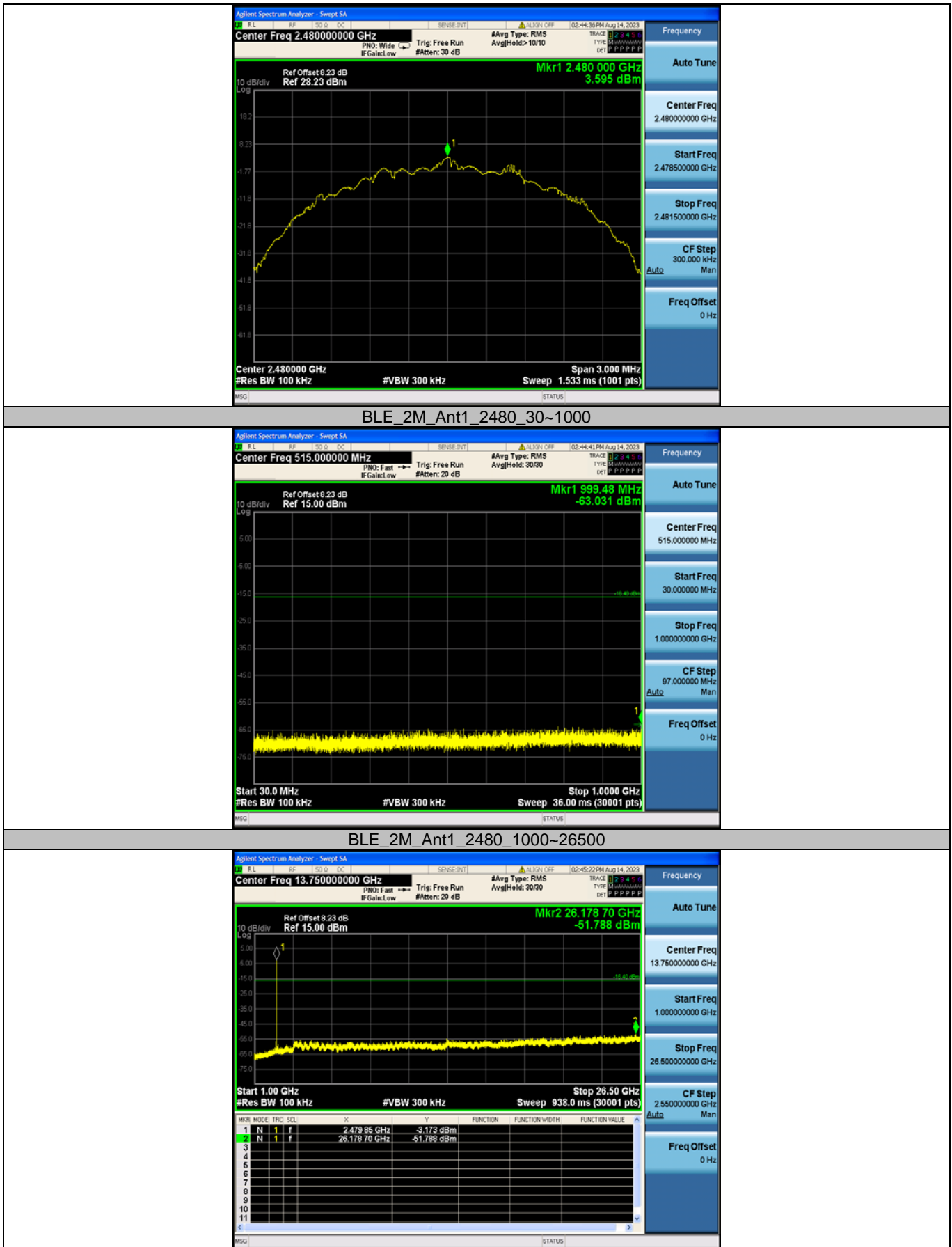

Appendix F: Duty Cycle

Test Result

Test Mode	Antenna	Frequency [MHz]	ON Time [ms]	Period [ms]	Duty Cycle [%]	Duty Cycle Factor[dB]
BLE_1M	Ant1	2402	2.10	2.50	84.00	0.76
		2440	2.10	2.50	84.00	0.76
		2480	2.10	2.50	84.00	0.76
BLE_2M	Ant1	2402	1.06	1.88	56.38	2.49
		2440	1.06	1.88	56.38	2.49
		2480	1.06	1.88	56.38	2.49

Test Graphs

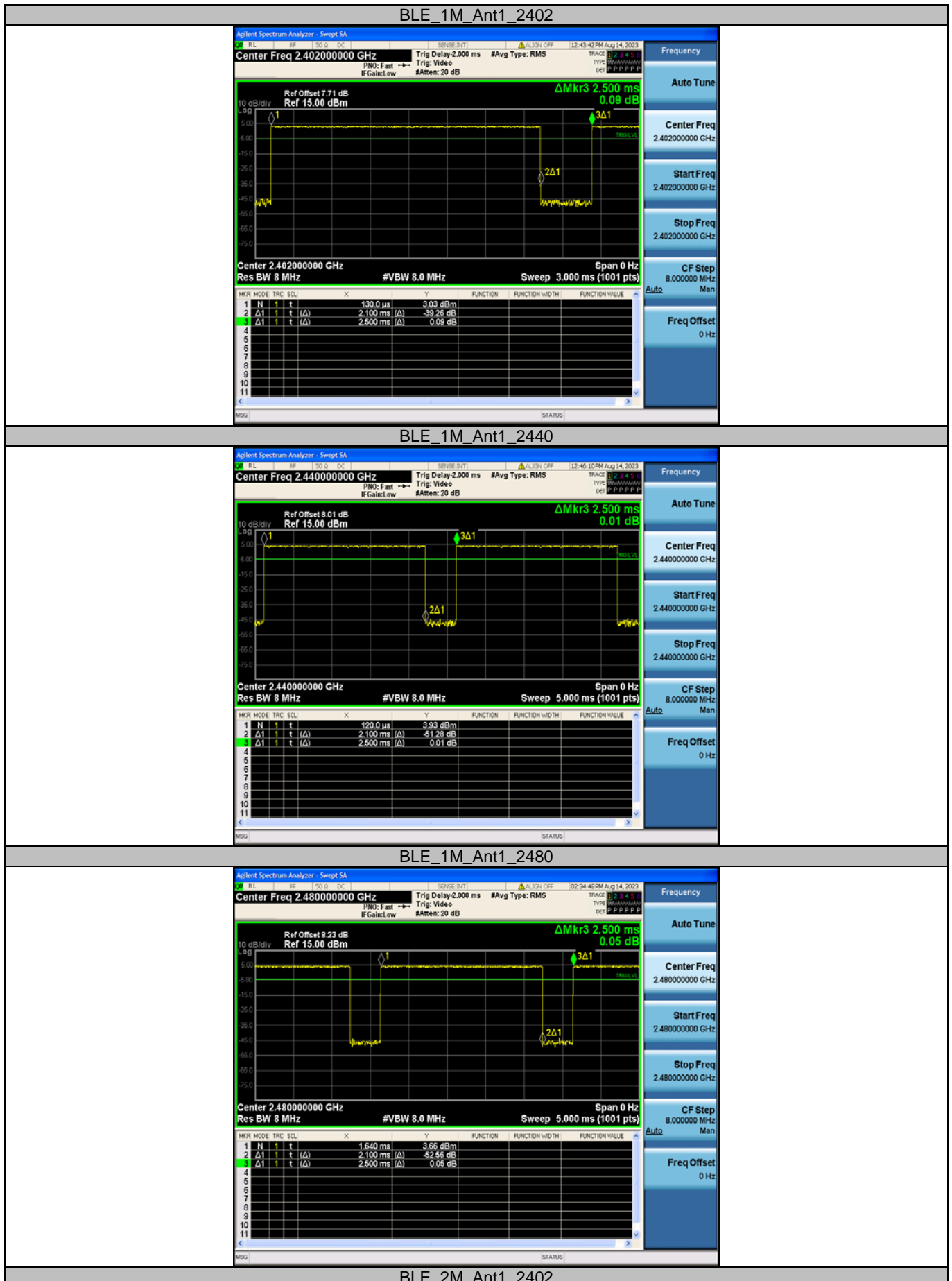

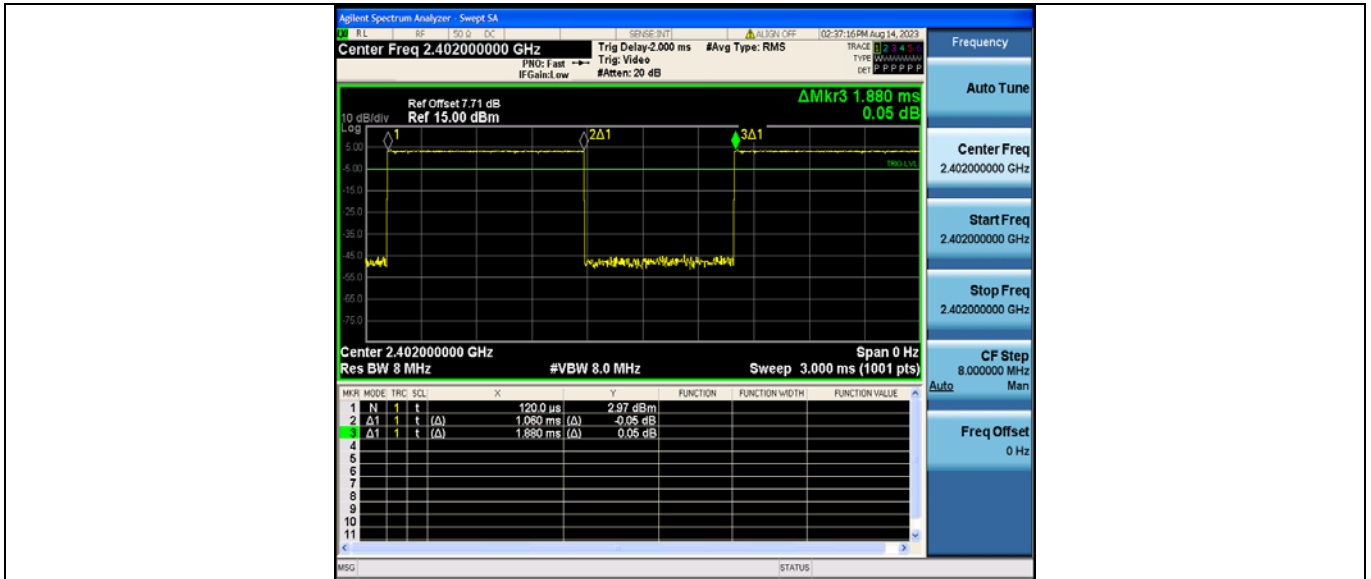

BLE_2M_Ant1_2440

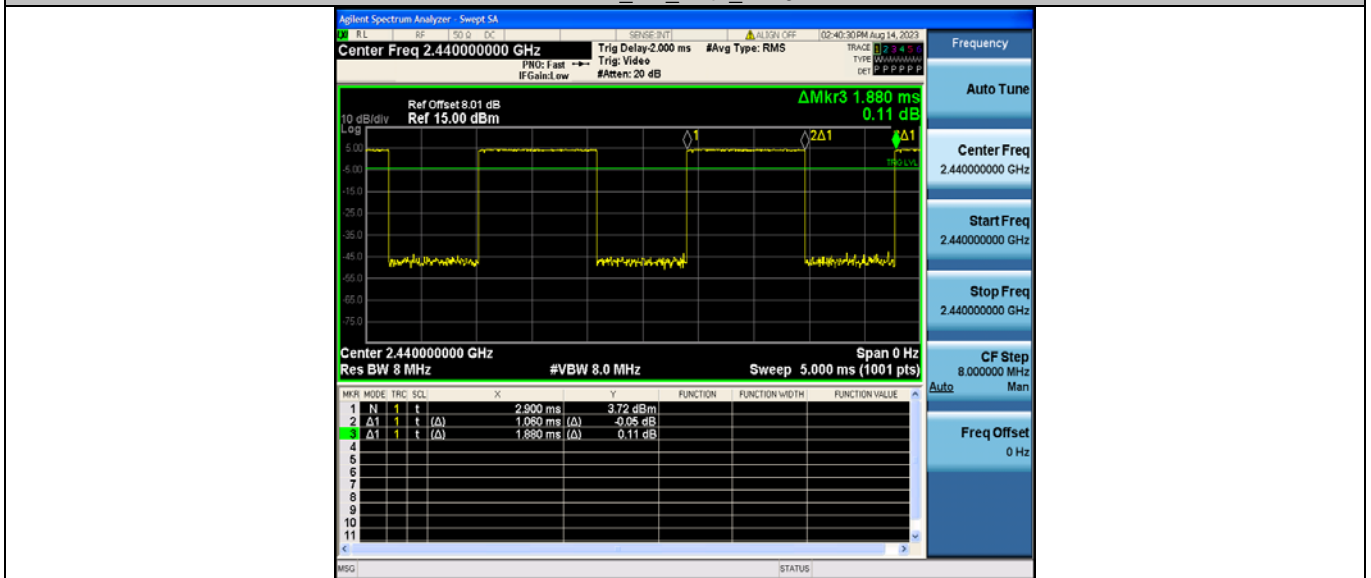

BLE_2M_Ant1_2480

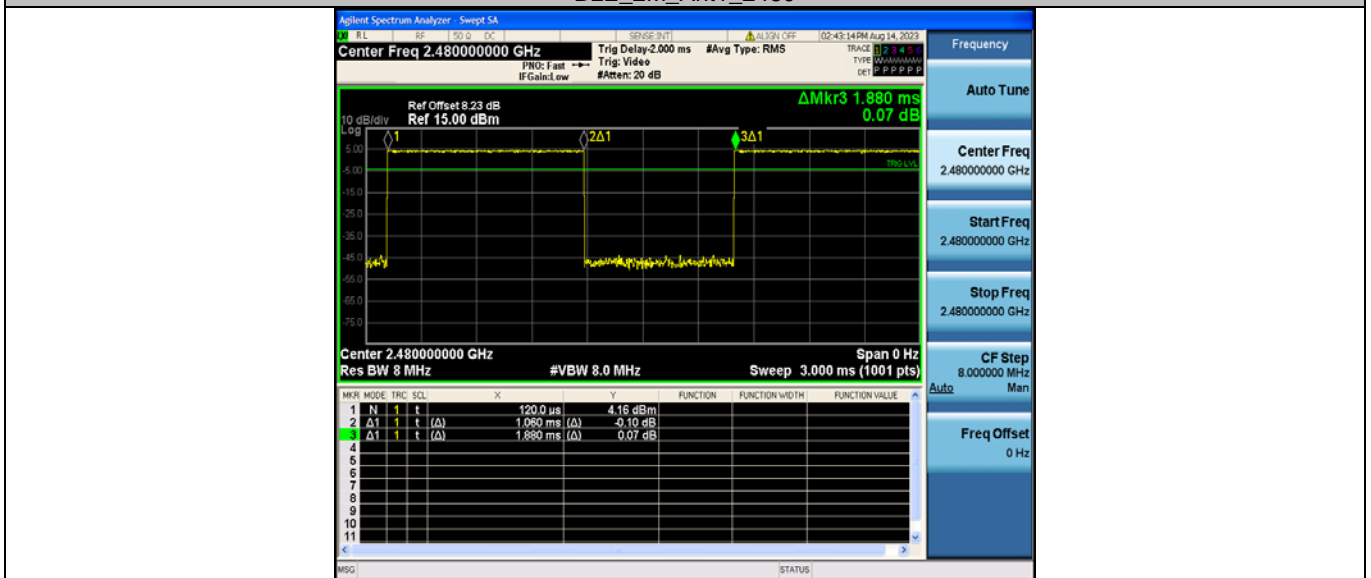

----End of Report----