



Shenzhen CTA Testing Technology Co., Ltd.

Room 106, Building 1, Yibaolai Industrial Park, Qiaotou Community, Fuhai Street, Bao'an District, Shenzhen, China

### FCC PART 15 SUBPART C TEST REPORT

#### FCC PART 15.247

Report Reference No.....: CTA23072500401

FCC ID.....: 2BCAQ-P10E

Compiled by  
( position+printed name+signature)...: File administrators Zoey Cao

*Zoey Cao*

Supervised by  
( position+printed name+signature)...: Project Engineer Amy Wen



Approved by  
( position+printed name+signature)...: RF Manager Eric Wang

*Eric Wang*

Date of issue.....: Jul. 28, 2023

Testing Laboratory Name .....: Shenzhen CTA Testing Technology Co., Ltd.

Address .....: Room 106, Building 1, Yibaolai Industrial Park, Qiaotou Community, Fuhai Street, Bao'an District, Shenzhen, China

Applicant's name .....: Shenzhen Dehong Audio Electronic Technology Co., Ltd

Address .....: 702 Factory Building in Zhu'ao Industrial Zone, Gushu Community, Xixiang Street, Bao'an District, Shenzhen, China

Test specification .....

Standard .....: FCC Part 15.247

**Shenzhen CTA Testing Technology Co., Ltd. All rights reserved.**

This publication may be reproduced in whole or in part for non-commercial purposes as long as the Shenzhen CTA Testing Technology Co., Ltd. is acknowledged as copyright owner and source of the material. Shenzhen CTA Testing Technology Co., Ltd. takes no responsibility for and will not assume liability for damages resulting from the reader's interpretation of the reproduced material due to its placement and context.

Test item description .....: Bluetooth Headset

Trade Mark .....: N/A

Manufacturer .....: Shenzhen Dehong Audio Electronic Technology Co., Ltd

Model/Type reference.....: P10E

Listed Models .....: D18, D20, D22T, D28, D30, D50, D60, D70, D80, D90, P62, P63, P65, P66, P68, P300, P500, P600, P700, P800, A32E, A33E, A35E, A36E, A37E, T11, T21, T31, T51, T61, T81, G02, G03, G05, G06, G07, G08, Q102, Q103, Q105, Q106, Q107, Q108

Modulation .....: GFSK, Π/4DQPSK

Frequency.....: From 2402MHz to 2480MHz

Rating .....: DC 3.7V From Battery and DC 5.0V From external circuit

Result.....: **PASS**

Shenzhen CTA Testing Technology Co., Ltd.

Room 106, Building 1, Yibaolai Industrial Park, Qiaotou Community, Fuhai Street, Bao'an District, Shenzhen, China  
Tel:+86-755 2322 5875 E-mail:cta@cta-test.cn Web:http://www.cta-test.cn

**TEST REPORT**

Equipment under Test : Bluetooth Headset

Model /Type : P10E

Listed Models : D18, D20, D22T, D28, D30, D50, D60, D70, D80, D90, P62, P63, P65, P66, P68, P300, P500, P600, P700, P800, A32E, A33E, A35E, A36E, A37E, T11, T21, T31, T51, T61, T81, G02, G03, G05, G06, G07, G08, Q102, Q103, Q105, Q106, Q107, Q108

**Applicant** : **Shenzhen Dehong Audio Electronic Technology Co., Ltd**

Address : 702 Factory Building in Zhu'ao Industrial Zone, Gushu Community, Xixiang Street, Bao'an District, Shenzhen, China

**Manufacturer** : **Shenzhen Dehong Audio Electronic Technology Co., Ltd**

Address : 702 Factory Building in Zhu'ao Industrial Zone, Gushu Community, Xixiang Street, Bao'an District, Shenzhen, China

|                     |             |
|---------------------|-------------|
| <b>Test Result:</b> | <b>PASS</b> |
|---------------------|-------------|

The test report merely corresponds to the test sample.  
It is not permitted to copy extracts of these test result without the written permission of the test laboratory.

## Contents

|          |   |           |
|----------|---|-----------|
| <b>1</b> | <b><u>TEST STANDARDS .....</u></b>                  | <b>4</b>  |
| <b>2</b> | <b><u>SUMMARY .....</u></b>                         | <b>5</b>  |
| 2.1      | General Remarks                                     | 5         |
| 2.2      | Product Description                                 | 5         |
| 2.3      | Equipment Under Test                                | 5         |
| 2.4      | Short description of the Equipment under Test (EUT) | 5         |
| 2.5      | EUT operation mode                                  | 6         |
| 2.6      | Block Diagram of Test Setup                         | 6         |
| 2.7      | Related Submittal(s) / Grant (s)                    | 6         |
| 2.8      | Modifications                                       | 6         |
| <b>3</b> | <b><u>TEST ENVIRONMENT .....</u></b>                | <b>7</b>  |
| 3.1      | Address of the test laboratory                      | 7         |
| 3.2      | Test Facility                                       | 7         |
| 3.3      | Environmental conditions                            | 7         |
| 3.4      | Summary of measurement results                      | 8         |
| 3.5      | Statement of the measurement uncertainty            | 8         |
| 3.6      | Equipments Used during the Test                     | 9         |
| <b>4</b> | <b><u>TEST CONDITIONS AND RESULTS .....</u></b>     | <b>10</b> |
| 4.1      | AC Power Conducted Emission                         | 10        |
| 4.2      | Radiated Emission                                   | 13        |
| 4.3      | Maximum Peak Output Power                           | 19        |
| 4.4      | 20dB Bandwidth                                      | 20        |
| 4.5      | Frequency Separation                                | 23        |
| 4.6      | Number of hopping frequency                         | 25        |
| 4.7      | Time of Occupancy (Dwell Time)                      | 27        |
| 4.8      | Out-of-band Emissions                               | 30        |
| 4.9      | Antenna Requirement                                 | 37        |
| <b>5</b> | <b><u>TEST SETUP PHOTOS OF THE EUT .....</u></b>    | <b>38</b> |
| <b>6</b> | <b><u>PHOTOS OF THE EUT .....</u></b>               | <b>39</b> |

# 1 TEST STANDARDS

The tests were performed according to following standards:

[FCC Rules Part 15.247](#): Frequency Hopping, Direct Spread Spectrum and Hybrid Systems that are in operation within the bands of 902-928 MHz, 2400-2483.5 MHz, and 5725-5850 MHz.

[ANSI C63.10-2013](#): American National Standard for Testing Unlicensed Wireless Devices

## 2 SUMMARY

### 2.1 General Remarks

|                                |   |               |
|--------------------------------|---|---------------|
| Date of receipt of test sample | : | Jul. 21, 2023 |
| Testing commenced on           | : | Jul. 21, 2023 |
| Testing concluded on           | : | Jul. 28, 2023 |

### 2.2 Product Description

|   |  |
|---|--|
| Product Name:   | Bluetooth Headset  |
| Model/Type reference:   | P10E   |
| Power supply:   | DC 3.7V From Battery and DC 5.0V From external circuit               |
| Adapter information<br>(Auxiliary test supplied by<br>test Lab) : | Model: EP-TA20CBC<br>Input: AC 100-240V 50/60Hz<br>Output: DC 5V 2A  |
| Hardware version:   | GQ_Y42-Pro_73ENC_V2.0  |
| Software version:   | CKS_5F30-3B3FE07C  |
| Testing sample ID:  | CTA230725004-1# (Engineer sample)<br>CTA230725004-2# (Normal sample) |
| <b>Bluetooth :</b>  |  |
| Supported Type:   | Bluetooth BR/EDR   |
| Modulation:   | GFSK, $\pi/4$ DQPSK  |
| Operation frequency:  | 2402MHz~2480MHz  |
| Channel number:   | 79   |
| Channel separation:   | 1MHz   |
| Antenna type:   | Chip antenna   |
| Antenna gain:   | 1.72 dBi   |

### 2.3 Equipment Under Test

#### Power supply system utilised

|                      |   |   |                                   |
|----------------------|---|---|-----------------------------------|
| Power supply voltage | : | <input type="radio"/> 230V / 50 Hz                                | <input type="radio"/> 120V / 60Hz |
|                      |   | <input type="radio"/> 12 V DC                                     | <input type="radio"/> 24 V DC     |
|                      |   | <input checked="" type="radio"/> Other (specified in blank below) |                                   |

DC 3.7V From Battery and DC 5.0V From external circuit

### 2.4 Short description of the Equipment under Test (EUT)

This is a Bluetooth Headset.

For more details, refer to the user's manual of the EUT.

## 2.5 EUT operation mode

The Applicant provides communication tools software(Engineer mode) to control the EUT for staying in continuous transmitting (Duty Cycle more than 98%) and receiving mode for testing .There are 79 channels provided to the EUT and Channel 00/39/78 were selected to test.

### Operation Frequency:

| Channel | Frequency (MHz) |
|---------|-----------------|
| 00      | 2402            |
| 01      | 2403            |
| :       | :               |
| 38      | 2440            |
| 39      | 2441            |
| 40      | 2442            |
| :       | :               |
| 77      | 2479            |
| 78      | 2480            |

## 2.6 Block Diagram of Test Setup

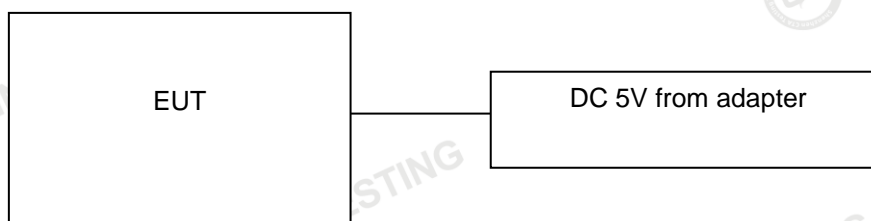

## 2.7 Related Submittal(s) / Grant (s)

This submittal(s) (test report) is intended for the device filing to comply with Section 15.247 of the FCC Part 15, Subpart C Rules.

## 2.8 Modifications

No modifications were implemented to meet testing criteria.

### 3 TEST ENVIRONMENT

#### 3.1 Address of the test laboratory

**Shenzhen CTA Testing Technology Co., Ltd.**

Room 106, Building 1, Yibaolai Industrial Park, Qiaotou Community, Fuhai Street, Bao'an District, Shenzhen, China

#### 3.2 Test Facility

The test facility is recognized, certified, or accredited by the following organizations:

**FCC-Registration No.: 517856 Designation Number: CN1318**

Shenzhen CTA Testing Technology Co., Ltd. has been listed on the US Federal Communications Commission list of test facilities recognized to perform electromagnetic emissions measurements.

**A2LA-Lab Cert. No.: 6534.01**

Shenzhen CTA Testing Technology Co., Ltd. has been listed by American Association for Laboratory Accreditation to perform electromagnetic emission measurement.

**ISED#: 27890 CAB identifier: CN0127**

Shenzhen CTA Testing Technology Co., Ltd. has been listed by Innovation, Science and Economic Development Canada to perform electromagnetic emission measurement.

The 3m-Semi anechoic test site fulfils CISPR 16-1-4 according to ANSI C63.10 and CISPR 16-1-4:2010.

#### 3.3 Environmental conditions

During the measurement the environmental conditions were within the listed ranges:

Radiated Emission:

|                       |              |
|-----------------------|--------------|
| Temperature:          | 24 ° C       |
| Humidity:             | 45 %         |
| Atmospheric pressure: | 950-1050mbar |

AC Power Conducted Emission:

|                       |              |
|-----------------------|--------------|
| Temperature:          | 25 ° C       |
| Humidity:             | 46 %         |
| Atmospheric pressure: | 950-1050mbar |

Conducted testing:

|                       |              |
|-----------------------|--------------|
| Temperature:          | 25 ° C       |
| Humidity:             | 44 %         |
| Atmospheric pressure: | 950-1050mbar |

**Shenzhen CTA Testing Technology Co., Ltd.**

Room 106, Building 1, Yibaolai Industrial Park, Qiaotou Community, Fuhai Street, Bao'an District, Shenzhen, China  
Tel:+86-755 2322 5875 E-mail:cta@cta-test.cn Web:http://www.cta-test.cn

### 3.4 Summary of measurement results

| Test Specification clause | Test case   | Test Mode        | Test Channel  | Recorded In Report |   | Test result |
|---------------------------|---|------------------|---|--------------------|---|-------------|
| §15.247(a)(1)             | Carrier Frequency separation                      | GFSK<br>Π/4DQPSK | <input checked="" type="checkbox"/> Lowest<br><input checked="" type="checkbox"/> Middle<br><input checked="" type="checkbox"/> Highest | GFSK<br>Π/4DQPSK   | <input checked="" type="checkbox"/> Middle  | Compliant   |
| §15.247(a)(1)             | Number of Hopping channels                        | GFSK<br>Π/4DQPSK | <input checked="" type="checkbox"/> Full  | GFSK               | <input checked="" type="checkbox"/> Full  | Compliant   |
| §15.247(a)(1)             | Time of Occupancy (dwell time)                    | GFSK<br>Π/4DQPSK | <input checked="" type="checkbox"/> Lowest<br><input checked="" type="checkbox"/> Middle<br><input checked="" type="checkbox"/> Highest | GFSK<br>Π/4DQPSK   | <input checked="" type="checkbox"/> Middle  | Compliant   |
| §15.247(a)(1)             | Spectrum bandwidth of aFHSS system 20dB bandwidth | GFSK<br>Π/4DQPSK | <input checked="" type="checkbox"/> Lowest<br><input checked="" type="checkbox"/> Middle<br><input checked="" type="checkbox"/> Highest | GFSK<br>Π/4DQPSK   | <input checked="" type="checkbox"/> Lowest<br><input checked="" type="checkbox"/> Middle<br><input checked="" type="checkbox"/> Highest | Compliant   |
| §15.247(b)(1)             | Maximum output peak power                         | GFSK<br>Π/4DQPSK | <input checked="" type="checkbox"/> Lowest<br><input checked="" type="checkbox"/> Middle<br><input checked="" type="checkbox"/> Highest | GFSK<br>Π/4DQPSK   | <input checked="" type="checkbox"/> Lowest<br><input checked="" type="checkbox"/> Middle<br><input checked="" type="checkbox"/> Highest | Compliant   |
| §15.247(d)                | Band edge compliance conducted                    | GFSK<br>Π/4DQPSK | <input checked="" type="checkbox"/> Lowest<br><input checked="" type="checkbox"/> Highest   | GFSK<br>Π/4DQPSK   | <input checked="" type="checkbox"/> Lowest<br><input checked="" type="checkbox"/> Highest   | Compliant   |
| §15.205                   | Band edge compliance radiated                     | GFSK<br>Π/4DQPSK | <input checked="" type="checkbox"/> Lowest<br><input checked="" type="checkbox"/> Highest   | GFSK<br>Π/4DQPSK   | <input checked="" type="checkbox"/> Lowest<br><input checked="" type="checkbox"/> Highest   | Compliant   |
| §15.247(d)                | TX spurious emissions conducted                   | GFSK<br>Π/4DQPSK | <input checked="" type="checkbox"/> Lowest<br><input checked="" type="checkbox"/> Middle<br><input checked="" type="checkbox"/> Highest | GFSK<br>Π/4DQPSK   | <input checked="" type="checkbox"/> Lowest<br><input checked="" type="checkbox"/> Middle<br><input checked="" type="checkbox"/> Highest | Compliant   |
| §15.247(d)                | TX spurious emissions radiated                    | GFSK<br>Π/4DQPSK | <input checked="" type="checkbox"/> Lowest<br><input checked="" type="checkbox"/> Middle<br><input checked="" type="checkbox"/> Highest | GFSK               | <input checked="" type="checkbox"/> Lowest<br><input checked="" type="checkbox"/> Middle<br><input checked="" type="checkbox"/> Highest | Compliant   |
| §15.209(a)                | TX spurious Emissions radiated Below 1GHz         | GFSK<br>Π/4DQPSK | <input checked="" type="checkbox"/> Lowest<br><input checked="" type="checkbox"/> Middle<br><input checked="" type="checkbox"/> Highest | GFSK               | <input checked="" type="checkbox"/> Middle  | Compliant   |
| §15.107(a)<br>§15.207     | Conducted Emissions 9KHz-30 MHz                   | GFSK<br>Π/4DQPSK | <input checked="" type="checkbox"/> Lowest<br><input checked="" type="checkbox"/> Middle<br><input checked="" type="checkbox"/> Highest | GFSK               | <input checked="" type="checkbox"/> Middle  | Compliant   |

Remark:

1. The measurement uncertainty is not included in the test result.
2. We tested all test mode and recorded worst case in report

### 3.5 Statement of the measurement uncertainty

The data and results referenced in this document are true and accurate. The reader is cautioned that there may be errors within the calibration limits of the equipment and facilities. The measurement uncertainty was calculated for all measurements listed in this test report acc. to TR-100028-01 "Electromagnetic compatibility and Radio spectrum Matters (ERM); Uncertainties in the measurement of mobile radio equipment characteristics; Part 1" and TR-100028-02 "Electromagnetic compatibility and Radio spectrum Matters (ERM); Uncertainties in the measurement of mobile radio equipment characteristics; Part 2" and is documented in the Shenzhen CTA Testing Technology Co., Ltd. quality system acc. to DIN EN ISO/IEC 17025. Furthermore, component and process variability of devices similar to that tested may result in additional deviation. The manufacturer has the sole responsibility of continued compliance of the device.

Hereafter the best measurement capability for Shenzhen CTA Testing Technology Co., Ltd. :

| Test                  | Range      | Measurement Uncertainty | Notes |
|-----------------------|------------|-------------------------|-------|
| Radiated Emission     | 30~1000MHz | 4.06 dB                 | (1)   |
| Radiated Emission     | 1~18GHz    | 5.14 dB                 | (1)   |
| Radiated Emission     | 18-40GHz   | 5.38 dB                 | (1)   |
| Conducted Disturbance | 0.15~30MHz | 2.14 dB                 | (1)   |

- (1) This uncertainty represents an expanded uncertainty expressed at approximately the 95% confidence level using a coverage factor of k=2.

Shenzhen CTA Testing Technology Co., Ltd.

Room 106, Building 1, Yibaolai Industrial Park, Qiaotou Community, Fuhai Street, Bao'an District, Shenzhen, China  
Tel:+86-755 2322 5875 E-mail:cta@cta-test.cn Web:http://www.cta-test.cn



### 3.6 Equipments Used during the Test

| Test Equipment                 | Manufacturer           | Model No.   | Equipment No. | Calibration Date | Calibration Due Date |
|--------------------------------|------------------------|-------------|---------------|------------------|----------------------|
| LISN                           | R&S                    | ENV216      | CTA-308       | 2022/08/03       | 2023/08/02           |
| LISN                           | R&S                    | ENV216      | CTA-314       | 2022/08/03       | 2023/08/02           |
| EMI Test Receiver              | R&S                    | ESPI        | CTA-307       | 2022/08/03       | 2023/08/02           |
| EMI Test Receiver              | R&S                    | ESCI        | CTA-306       | 2022/08/03       | 2023/08/02           |
| Spectrum Analyzer              | Agilent                | N9020A      | CTA-301       | 2022/08/03       | 2023/08/02           |
| Spectrum Analyzer              | R&S                    | FSP         | CTA-337       | 2022/08/03       | 2023/08/02           |
| Vector Signal generator        | Agilent                | N5182A      | CTA-305       | 2022/08/03       | 2023/08/02           |
| Analog Signal Generator        | R&S                    | SML03       | CTA-304       | 2022/08/03       | 2023/08/02           |
| Universal Radio Communication  | CMW500                 | R&S         | CTA-302       | 2022/08/03       | 2023/08/02           |
| Temperature and humidity meter | Chigo                  | ZG-7020     | CTA-326       | 2022/08/03       | 2023/08/02           |
| Ultra-Broadband Antenna        | Schwarzbeck            | VULB9163    | CTA-310       | 2021/08/07       | 2024/08/06           |
| Horn Antenna                   | Schwarzbeck            | BBHA 9120D  | CTA-309       | 2021/08/07       | 2024/08/06           |
| Loop Antenna                   | Zhinan                 | ZN30900C    | CTA-311       | 2021/08/07       | 2024/08/06           |
| Horn Antenna                   | Beijing Hangwei Dayang | OBH100400   | CTA-336       | 2021/08/07       | 2024/08/06           |
| Amplifier                      | Schwarzbeck            | BBV 9745    | CTA-312       | 2022/08/03       | 2023/08/02           |
| Amplifier                      | Taiwan chengyi         | EMC051845B  | CTA-313       | 2022/08/03       | 2023/08/02           |
| Directional coupler            | NARDA                  | 4226-10     | CTA-303       | 2022/08/03       | 2023/08/02           |
| High-Pass Filter               | XingBo                 | XBLBQ-GTA18 | CTA-402       | 2022/08/03       | 2023/08/02           |
| High-Pass Filter               | XingBo                 | XBLBQ-GTA27 | CTA-403       | 2022/08/03       | 2023/08/02           |
| Automated filter bank          | Tonscend               | JS0806-F    | CTA-404       | 2022/08/03       | 2023/08/02           |
| Power Sensor                   | Agilent                | U2021XA     | CTA-405       | 2022/08/03       | 2023/08/02           |
| Amplifier                      | Schwarzbeck            | BBV9719     | CTA-406       | 2022/08/03       | 2023/08/02           |

## 4 TEST CONDITIONS AND RESULTS

### 4.1 AC Power Conducted Emission

#### TEST CONFIGURATION

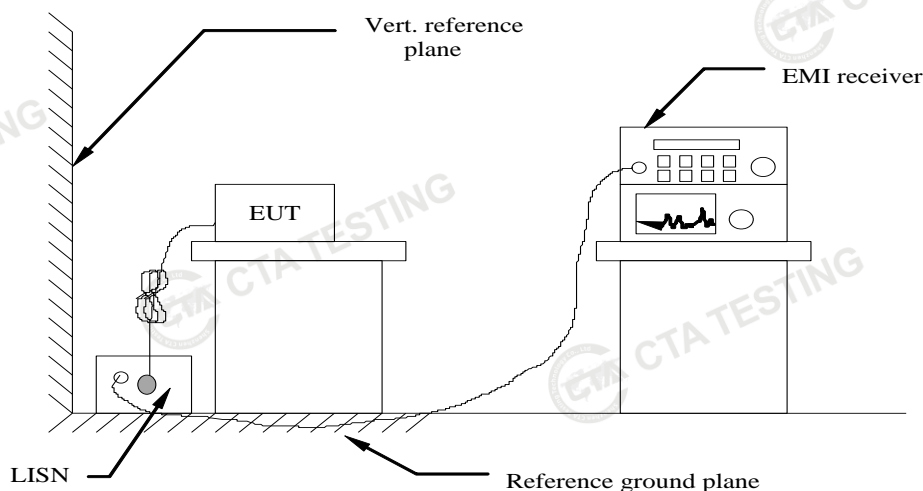

#### TEST PROCEDURE

- 1 The equipment was set up as per the test configuration to simulate typical actual usage per the user's manual. The EUT is a tabletop system, a wooden table with a height of 0.8 meters is used and is placed on the ground plane as per ANSI C63.10-2013.
- 2 Support equipment, if needed, was placed as per ANSI C63.10-2013
- 3 All I/O cables were positioned to simulate typical actual usage as per ANSI C63.10-2013
- 4 The EUT received power from adapter, the adapter received AC120V/60Hz and AC 240V/60Hz power through a Line Impedance Stabilization Network (LISN) which supplied power source and was grounded to the ground plane.
- 5 All support equipments received AC power from a second LISN, if any.
- 6 The EUT test program was started. Emissions were measured on each current carrying line of the EUT using a spectrum Analyzer / Receiver connected to the LISN powering the EUT. The LISN has two monitoring points: Line 1 (Hot Side) and Line 2 (Neutral Side). Two scans were taken: one with Line 1 connected to Analyzer / Receiver and Line 2 connected to a 50 ohm load; the second scan had Line 1 connected to a 50 ohm load and Line 2 connected to the Analyzer / Receiver.
- 7 Analyzer / Receiver scanned from 150 KHz to 30MHz for emissions in each of the test modes.
- 8 During the above scans, the emissions were maximized by cable manipulation.

#### AC Power Conducted Emission Limit

For intentional device, according to § 15.207(a) AC Power Conducted Emission Limits is as following :

| Frequency range (MHz) | Limit (dBuV) |           |
|-----------------------|--------------|-----------|
|                       | Quasi-peak   | Average   |
| 0.15-0.5              | 66 to 56*    | 56 to 46* |
| 0.5-5                 | 56           | 46        |
| 5-30                  | 60           | 50        |

\* Decreases with the logarithm of the frequency.

#### TEST RESULTS

Remark:

1. All modes of GFSK,  $\pi/4$  DQPSK were test at Low, Middle, and High channel; only the worst result of GFSK Middle Channel was reported as below:

Shenzhen CTA Testing Technology Co., Ltd.

Room 106, Building 1, Yibaolai Industrial Park, Qiaotou Community, Fuhai Street, Bao'an District, Shenzhen, China  
 Tel:+86-755 2322 5875 E-mail:cta@cta-test.cn Web:http://www.cta-test.cn

2. Both 120 VAC, 50/60 Hz and 240 VAC, 50/60 Hz power supply have been tested, only the worst result of 120 VAC, 60 Hz was reported as below:

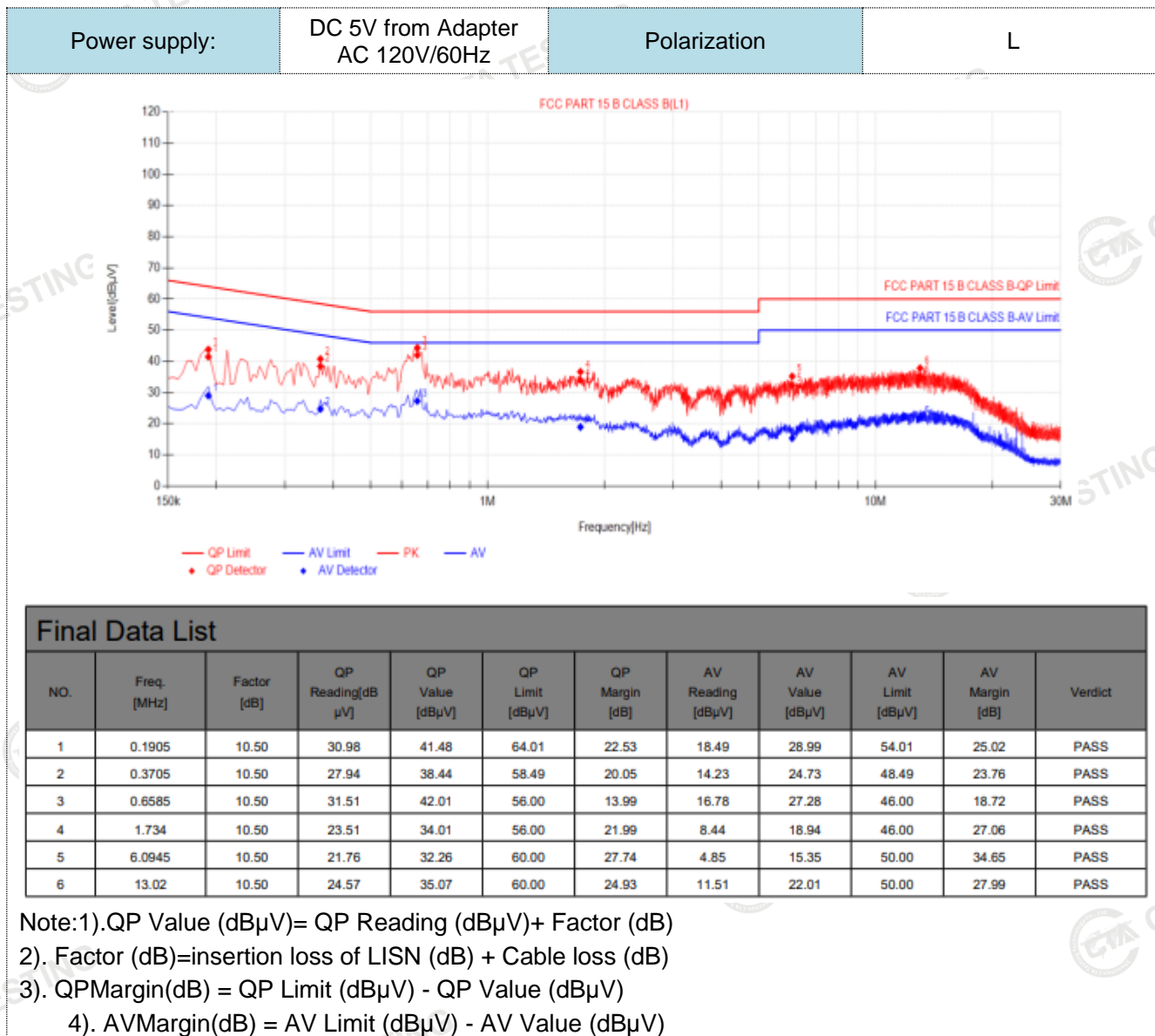

|               |                                 |              |   |
|---------------|---------------------------------|--------------|---|
| Power supply: | DC 5V from Adapter AC 120V/60Hz | Polarization | N |
|---------------|---------------------------------|--------------|---|

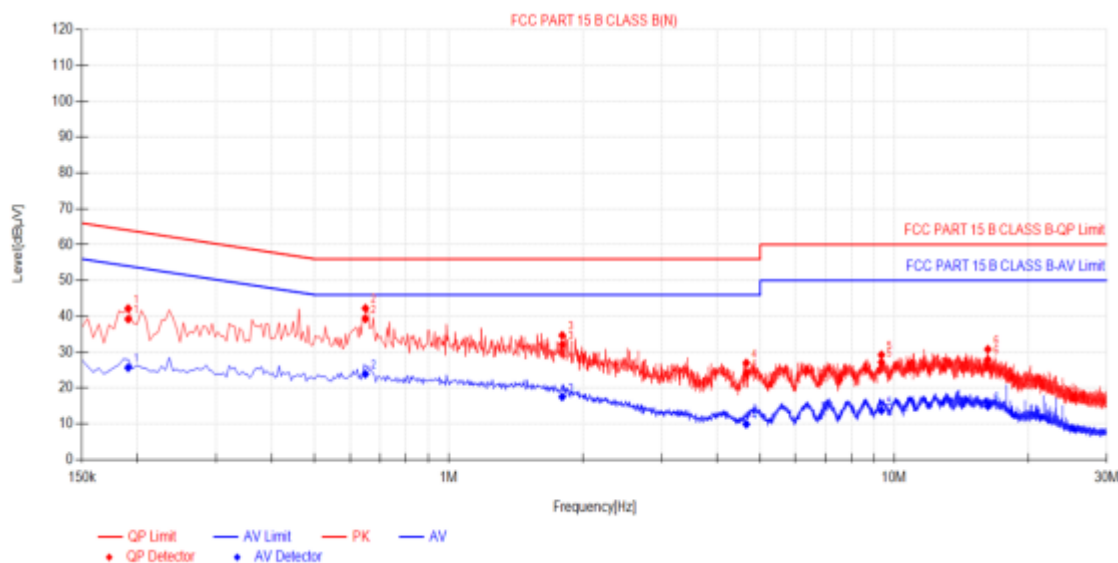

Final Data List

| NO. | Freq. [MHz] | Factor [dB] | QP Reading[dB µV] | QP Value [dBµV] | QP Limit [dBµV] | QP Margin [dB] | AV Reading [dBµV] | AV Value [dBµV] | AV Limit [dBµV] | AV Margin [dB] | Verdict |
|-----|-------------|-------------|-------------------|-----------------|-----------------|----------------|-------------------|-----------------|-----------------|----------------|---------|
| 1   | 0.1905      | 10.50       | 28.73             | 39.23           | 64.01           | 24.78          | 15.18             | 25.68           | 54.01           | 28.33          | PASS    |
| 2   | 0.6495      | 10.50       | 28.79             | 39.29           | 56.00           | 16.71          | 13.41             | 23.91           | 46.00           | 22.09          | PASS    |
| 3   | 1.797       | 10.50       | 21.63             | 32.13           | 56.00           | 23.87          | 7.04              | 17.54           | 46.00           | 28.46          | PASS    |
| 4   | 4.6545      | 10.50       | 13.64             | 24.14           | 56.00           | 31.86          | -0.59             | 9.91            | 46.00           | 36.09          | PASS    |
| 5   | 9.357       | 10.50       | 16.68             | 27.18           | 60.00           | 32.82          | 3.23              | 13.73           | 50.00           | 36.27          | PASS    |
| 6   | 16.2285     | 10.50       | 17.43             | 27.93           | 60.00           | 32.07          | 4.44              | 14.94           | 50.00           | 35.06          | PASS    |

Note:1).QP Value (dBµV)= QP Reading (dBµV)+ Factor (dB)

2). Factor (dB)=insertion loss of LISN (dB) + Cable loss (dB)

3). QPMargin(dB) = QP Limit (dBµV) - QP Value (dBµV)

4). AVMargin(dB) = AV Limit (dBµV) - AV Value (dBµV)

## 4.2 Radiated Emission

### TEST CONFIGURATION

Frequency range 9 KHz – 30MHz

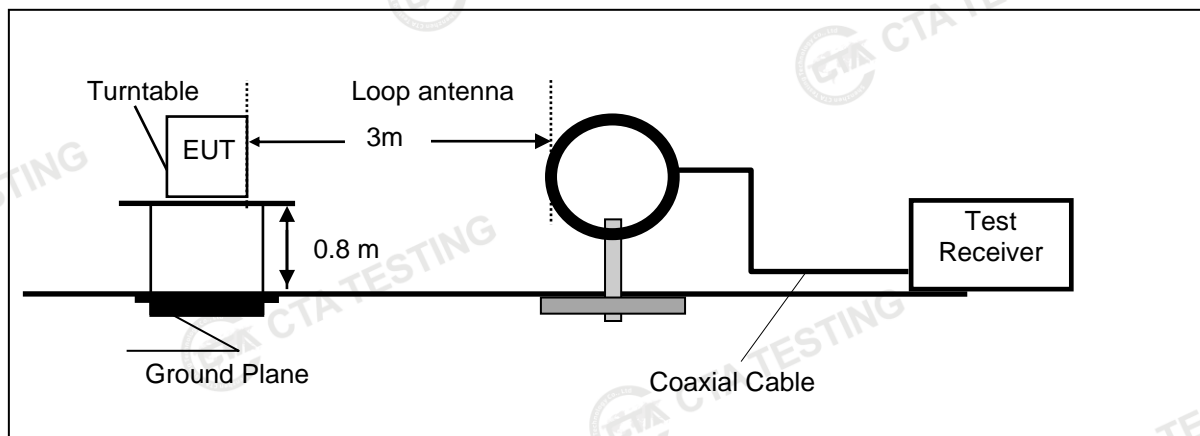

Frequency range 30MHz – 1000MHz

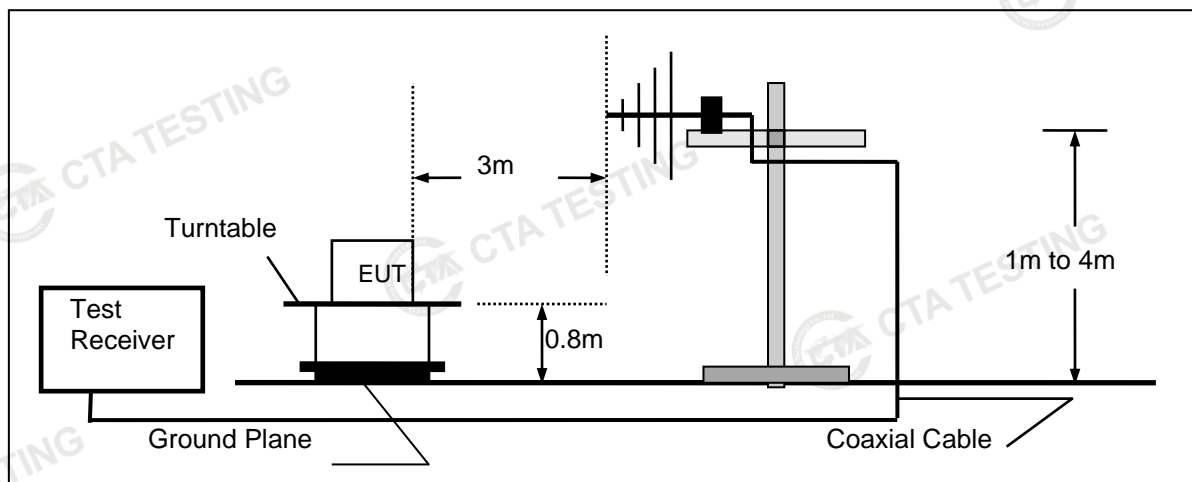

Frequency range above 1GHz-25GHz

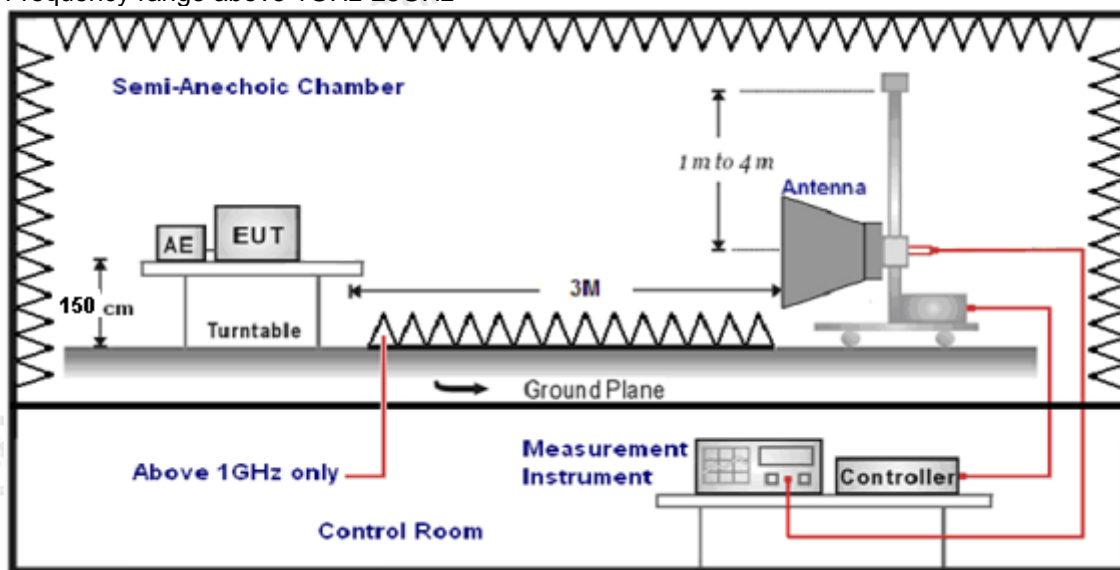

**TEST PROCEDURE**

1. The EUT was placed on a turn table which is 0.8m above ground plane when testing frequency range 9 KHz –1GHz;the EUT was placed on a turn table which is 1.5m above ground plane when testing frequency range 1GHz – 25GHz.
2. Maximum procedure was performed by raising the receiving antenna from 1m to 4m and rotating the turn table from 0° to 360° to acquire the highest emissions from EUT.
3. And also, each emission was to be maximized by changing the polarization of receiving antenna both horizontal and vertical.
4. Repeat above procedures until all frequency measurements have been completed.
5. Radiated emission test frequency band from 9KHz to 25GHz.
6. The distance between test antenna and EUT as following table states:

| Test Frequency range | Test Antenna Type          | Test Distance |
|----------------------|----------------------------|---------------|
| 9KHz-30MHz           | Active Loop Antenna        | 3             |
| 30MHz-1GHz           | Ultra-Broadband Antenna    | 3             |
| 1GHz-18GHz           | Double Ridged Horn Antenna | 3             |
| 18GHz-25GHz          | Horn Antenna               | 1             |

7. Setting test receiver/spectrum as following table states:

| Test Frequency range | Test Receiver/Spectrum Setting  | Detector |
|----------------------|---|----------|
| 9KHz-150KHz          | RBW=200Hz/VBW=3KHz, Sweep time=Auto   | QP       |
| 150KHz-30MHz         | RBW=9KHz/VBW=100KHz, Sweep time=Auto  | QP       |
| 30MHz-1GHz           | RBW=120KHz/VBW=1000KHz, Sweep time=Auto   | QP       |
| 1GHz-40GHz           | Peak Value: RBW=1MHz/VBW=3MHz,<br>Sweep time=Auto<br>Average Value: RBW=1MHz/VBW=10Hz,<br>Sweep time=Auto | Peak     |

**Field Strength Calculation**

The field strength is calculated by adding the Antenna Factor and Cable Factor and subtracting the Amplifier Gain and Duty Cycle Correction Factor(if any) from the measured reading. The basic equation with a sample calculation is as follows:

$$FS = RA + AF + CL - AG$$

|                           |  |
|---------------------------|--|
| Where FS = Field Strength | CL = Cable Attenuation Factor (Cable Loss) |
| RA = Reading Amplitude    | AG = Amplifier Gain                        |
| AF = Antenna Factor       |  |

$$Transd=AF +CL-AG$$

**RADIATION LIMIT**

For intentional device, according to § 15.209(a), the general requirement of field strength of radiated emission from intentional radiators at a distance of 3 meters shall not exceed the following table. According to § 15.247(d), in any 100kHz bandwidth outside the frequency band in which the EUT is operating, the radio frequency power that is produced by the intentional radiator shall be at least 20dB below that in the100kHz bandwidth within the band that contains the highest level of desired power.

The pre-test have done for the EUT in three axes and found the worst emission at position shown in test setup photos.

| Frequency (MHz) | Distance (Meters) | Radiated (dBµV/m)                | Radiated (µV/m) |
|-----------------|-------------------|----------------------------------|-----------------|
| 0.009-0.49      | 3                 | 20log(2400/F(KHz))+40log(300/3)  | 2400/F(KHz)     |
| 0.49-1.705      | 3                 | 20log(24000/F(KHz))+ 40log(30/3) | 24000/F(KHz)    |
| 1.705-30        | 3                 | 20log(30)+ 40log(30/3)           | 30              |
| 30-88           | 3                 | 40.0                             | 100             |
| 88-216          | 3                 | 43.5                             | 150             |
| 216-960         | 3                 | 46.0                             | 200             |
| Above 960       | 3                 | 54.0                             | 500             |

**TEST RESULTS**

Remark:

1. This test was performed with EUT in X, Y, Z position and the worse case was found when EUT in X position.
2. We measured Radiated Emission at GFSK, π/4 DQPSK mode from 9 KHz to 25GHz and recorded worst case at GFSK DH5 mode.
3. For below 1GHz testing recorded worst at GFSK DH5 middle channel.
4. Radiated emission test from 9 KHz to 10th harmonic of fundamental was verified, and no emission found except system noise floor in 9 KHz to 30MHz and not recorded in this report.

**For 30MHz-1GHz**

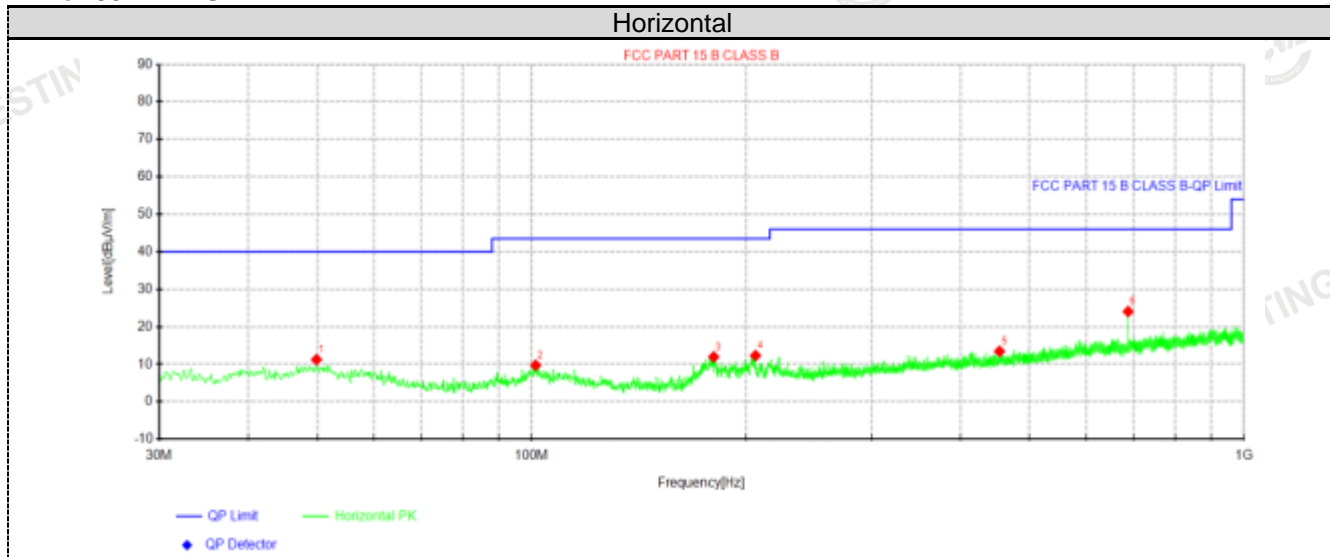

**Suspected Data List**

| NO. | Freq. [MHz] | Reading [dBµV] | Level [dBµV/m] | Factor [dB/m] | Limit [dBµV/m] | Margin [dB] | Height [cm] | Angle [°] | Polarity   |
|-----|-------------|----------------|----------------|---------------|----------------|-------------|-------------|-----------|------------|
| 1   | 49.885      | 27.31          | 11.24          | -16.07        | 40.00          | 28.76       | 100         | 360       | Horizontal |
| 2   | 101.295     | 28.14          | 9.72           | -18.42        | 43.50          | 33.78       | 100         | 207       | Horizontal |
| 3   | 180.107     | 32.47          | 11.94          | -20.53        | 43.50          | 31.56       | 100         | 104       | Horizontal |
| 4   | 206.176     | 31.48          | 12.31          | -19.17        | 43.50          | 31.19       | 100         | 97        | Horizontal |
| 5   | 453.647     | 28.48          | 13.43          | -15.05        | 46.00          | 32.57       | 100         | 190       | Horizontal |
| 6   | 687.538     | 35.80          | 24.06          | -11.74        | 46.00          | 21.94       | 100         | 28        | Horizontal |

Note:1). Level (dBµV/m)= Reading (dBµV)+ Factor (dB/m)

2). Factor(dB/m)=Antenna Factor (dB/m) + Cable loss (dB) - Pre Amplifier gain (dB)

3). Margin(dB) = Limit (dBµV/m) - Level (dBµV/m)

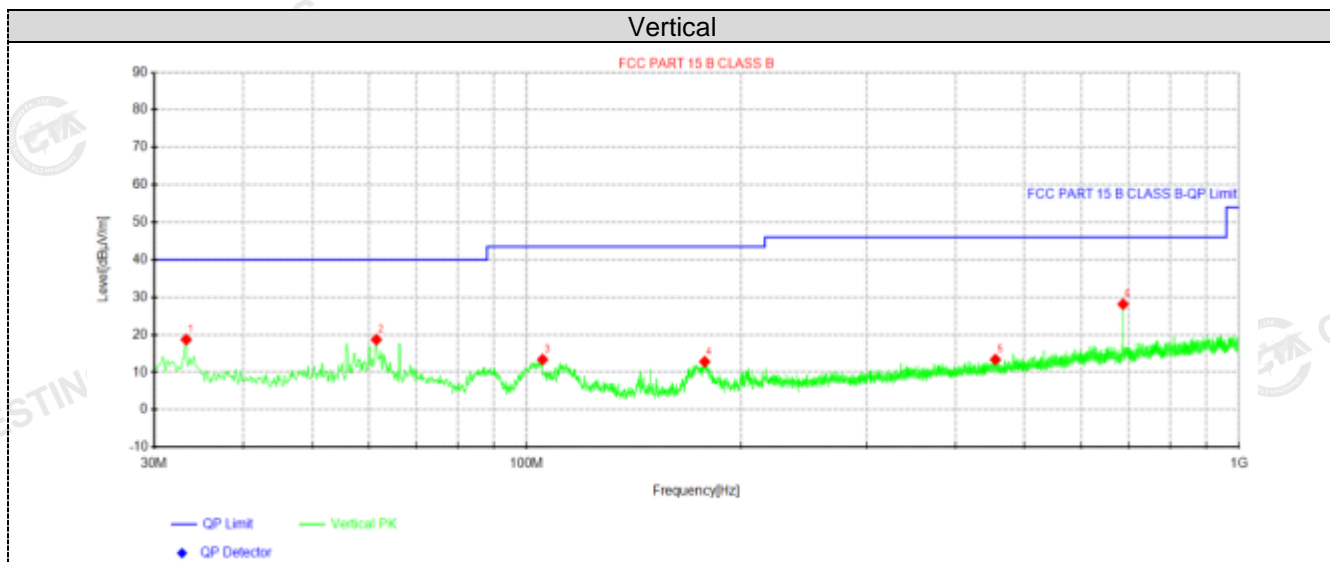

| Suspected Data List |             |                |                |               |                |             |             |           |          |
|---------------------|-------------|----------------|----------------|---------------|----------------|-------------|-------------|-----------|----------|
| NO.                 | Freq. [MHz] | Reading [dBuV] | Level [dBuV/m] | Factor [dB/m] | Limit [dBuV/m] | Margin [dB] | Height [cm] | Angle [°] | Polarity |
| 1                   | 33.2738     | 36.88          | 18.72          | -18.16        | 40.00          | 21.28       | 100         | 247       | Vertical |
| 2                   | 61.525      | 37.29          | 18.68          | -18.61        | 40.00          | 21.32       | 100         | 0         | Vertical |
| 3                   | 105.296     | 32.00          | 13.38          | -18.62        | 43.50          | 30.12       | 100         | 171       | Vertical |
| 4                   | 177.803     | 33.46          | 12.81          | -20.65        | 43.50          | 30.69       | 100         | 17        | Vertical |
| 5                   | 455.102     | 28.41          | 13.38          | -15.03        | 46.00          | 32.62       | 100         | 162       | Vertical |
| 6                   | 687.538     | 39.89          | 28.15          | -11.74        | 46.00          | 17.85       | 100         | 145       | Vertical |

Note:1).Level (dBuV/m)= Reading (dBuV)+ Factor (dB/m)

2). Factor(dB/m)=Antenna Factor (dB/m) + Cable loss (dB) - Pre Amplifier gain (dB)

3). Margin(dB) = Limit (dBuV/m) - Level (dBuV/m)



**For 1GHz to 25GHz**

Note: GFSK , π/4 DQPSK all have been tested, only worse case GFSK is reported.

**GFSK (above 1GHz)**

| Frequency(MHz): |                         |    | 2402           |             | Polarity:        |                       | HORIZONTAL        |                    |                          |
|-----------------|-------------------------|----|----------------|-------------|------------------|-----------------------|-------------------|--------------------|--------------------------|
| Frequency (MHz) | Emission Level (dBuV/m) |    | Limit (dBuV/m) | Margin (dB) | Raw Value (dBuV) | Antenna Factor (dB/m) | Cable Factor (dB) | Pre-amplifier (dB) | Correction Factor (dB/m) |
| 4804.00         | 61.71                   | PK | 74             | 12.29       | 65.98            | 32.33                 | 5.12              | 41.72              | -4.27                    |
| 4804.00         | 43.83                   | AV | 54             | 10.17       | 48.10            | 32.33                 | 5.12              | 41.72              | -4.27                    |
| 7206.00         | 52.38                   | PK | 74             | 21.62       | 52.90            | 36.6                  | 6.49              | 43.61              | -0.52                    |
| 7206.00         | 42.33                   | AV | 54             | 11.67       | 42.85            | 36.6                  | 6.49              | 43.61              | -0.52                    |

| Frequency(MHz): |                         |    | 2402           |             | Polarity:        |                       | VERTICAL          |                    |                          |
|-----------------|-------------------------|----|----------------|-------------|------------------|-----------------------|-------------------|--------------------|--------------------------|
| Frequency (MHz) | Emission Level (dBuV/m) |    | Limit (dBuV/m) | Margin (dB) | Raw Value (dBuV) | Antenna Factor (dB/m) | Cable Factor (dB) | Pre-amplifier (dB) | Correction Factor (dB/m) |
| 4804.00         | 60.17                   | PK | 74             | 13.83       | 64.44            | 32.33                 | 5.12              | 41.72              | -4.27                    |
| 4804.00         | 41.70                   | AV | 54             | 12.30       | 45.97            | 32.33                 | 5.12              | 41.72              | -4.27                    |
| 7206.00         | 50.51                   | PK | 74             | 23.49       | 51.03            | 36.6                  | 6.49              | 43.61              | -0.52                    |
| 7206.00         | 41.43                   | AV | 54             | 12.57       | 41.95            | 36.6                  | 6.49              | 43.61              | -0.52                    |

| Frequency(MHz): |                         |    | 2441           |             | Polarity:        |                       | HORIZONTAL        |                    |                          |
|-----------------|-------------------------|----|----------------|-------------|------------------|-----------------------|-------------------|--------------------|--------------------------|
| Frequency (MHz) | Emission Level (dBuV/m) |    | Limit (dBuV/m) | Margin (dB) | Raw Value (dBuV) | Antenna Factor (dB/m) | Cable Factor (dB) | Pre-amplifier (dB) | Correction Factor (dB/m) |
| 4882.00         | 61.53                   | PK | 74             | 12.47       | 65.41            | 32.6                  | 5.34              | 41.82              | -3.88                    |
| 4882.00         | 43.98                   | AV | 54             | 10.02       | 47.86            | 32.6                  | 5.34              | 41.82              | -3.88                    |
| 7323.00         | 52.87                   | PK | 74             | 21.13       | 52.98            | 36.8                  | 6.81              | 43.72              | -0.11                    |
| 7323.00         | 42.29                   | AV | 54             | 11.71       | 42.40            | 36.8                  | 6.81              | 43.72              | -0.11                    |

| Frequency(MHz): |                         |    | 2441           |             | Polarity:        |                       | VERTICAL          |                    |                          |
|-----------------|-------------------------|----|----------------|-------------|------------------|-----------------------|-------------------|--------------------|--------------------------|
| Frequency (MHz) | Emission Level (dBuV/m) |    | Limit (dBuV/m) | Margin (dB) | Raw Value (dBuV) | Antenna Factor (dB/m) | Cable Factor (dB) | Pre-amplifier (dB) | Correction Factor (dB/m) |
| 4882.00         | 58.48                   | PK | 74             | 15.52       | 62.36            | 32.6                  | 5.34              | 41.82              | -3.88                    |
| 4882.00         | 42.89                   | AV | 54             | 11.11       | 46.77            | 32.6                  | 5.34              | 41.82              | -3.88                    |
| 7323.00         | 50.91                   | PK | 74             | 23.09       | 51.02            | 36.8                  | 6.81              | 43.72              | -0.11                    |
| 7323.00         | 41.67                   | AV | 54             | 12.33       | 41.78            | 36.8                  | 6.81              | 43.72              | -0.11                    |

| Frequency(MHz): |                         |    | 2480           |             | Polarity:        |                       | HORIZONTAL        |                    |                          |
|-----------------|-------------------------|----|----------------|-------------|------------------|-----------------------|-------------------|--------------------|--------------------------|
| Frequency (MHz) | Emission Level (dBuV/m) |    | Limit (dBuV/m) | Margin (dB) | Raw Value (dBuV) | Antenna Factor (dB/m) | Cable Factor (dB) | Pre-amplifier (dB) | Correction Factor (dB/m) |
| 4960.00         | 60.58                   | PK | 74             | 13.42       | 63.66            | 32.73                 | 5.66              | 41.47              | -3.08                    |
| 4960.00         | 44.26                   | AV | 54             | 9.74        | 47.34            | 32.73                 | 5.66              | 41.47              | -3.08                    |
| 7440.00         | 53.88                   | PK | 74             | 20.12       | 53.43            | 37.04                 | 7.25              | 43.84              | 0.45                     |
| 7440.00         | 42.73                   | PK | 54             | 11.27       | 42.28            | 37.04                 | 7.25              | 43.84              | 0.45                     |

| Frequency(MHz): |                         |    | 2480           |             | Polarity:        |                       | VERTICAL          |                    |                          |
|-----------------|-------------------------|----|----------------|-------------|------------------|-----------------------|-------------------|--------------------|--------------------------|
| Frequency (MHz) | Emission Level (dBuV/m) |    | Limit (dBuV/m) | Margin (dB) | Raw Value (dBuV) | Antenna Factor (dB/m) | Cable Factor (dB) | Pre-amplifier (dB) | Correction Factor (dB/m) |
| 4960.00         | 58.33                   | PK | 74             | 15.67       | 61.41            | 32.73                 | 5.66              | 41.47              | -3.08                    |
| 4960.00         | 43.98                   | AV | 54             | 10.02       | 47.06            | 32.73                 | 5.66              | 41.47              | -3.08                    |
| 7440.00         | 52.21                   | PK | 74             | 21.79       | 51.76            | 37.04                 | 7.25              | 43.84              | 0.45                     |
| 7440.00         | 41.06                   | PK | 54             | 12.94       | 40.61            | 37.04                 | 7.25              | 43.84              | 0.45                     |

REMARKS:

Shenzhen CTA Testing Technology Co., Ltd.

Room 106, Building 1, Yibaolai Industrial Park, Qiaotou Community, Fuhai Street, Bao'an District, Shenzhen, China  
 Tel:+86-755 2322 5875 E-mail:cta@cta-test.cn Web:http://www.cta-test.cn

1. Emission level (dBuV/m) =Raw Value (dBuV)+Correction Factor (dB/m)
2. Correction Factor (dB/m) = Antenna Factor (dB/m)+Cable Factor (dB)- Pre-amplifier
3. Margin value = Limit value- Emission level.
4. -- Mean the PK detector measured value is below average limit.
5. The other emission levels were very low against the limit.

### Results of Band Edges Test (Radiated)

Note: GFSK,  $\pi/4$ DQPSK all have been tested, only worse case GFSK is reported.

#### GFSK

| Frequency(MHz): |                         |    | 2402           |             | Polarity:        |                       | HORIZONTAL        |                    |                          |
|-----------------|-------------------------|----|----------------|-------------|------------------|-----------------------|-------------------|--------------------|--------------------------|
| Frequency (MHz) | Emission Level (dBuV/m) |    | Limit (dBuV/m) | Margin (dB) | Raw Value (dBuV) | Antenna Factor (dB/m) | Cable Factor (dB) | Pre-amplifier (dB) | Correction Factor (dB/m) |
| 2390.00         | 60.60                   | PK | 74             | 13.40       | 71.02            | 27.42                 | 4.31              | 42.15              | -10.42                   |
| 2390.00         | 43.73                   | AV | 54             | 10.27       | 54.15            | 27.42                 | 4.31              | 42.15              | -10.42                   |
| Frequency(MHz): |                         |    | 2402           |             | Polarity:        |                       | VERTICAL          |                    |                          |
| Frequency (MHz) | Emission Level (dBuV/m) |    | Limit (dBuV/m) | Margin (dB) | Raw Value (dBuV) | Antenna Factor (dB/m) | Cable Factor (dB) | Pre-amplifier (dB) | Correction Factor (dB/m) |
| 2390.00         | 59.65                   | PK | 74             | 14.35       | 70.07            | 27.42                 | 4.31              | 42.15              | -10.42                   |
| 2390.00         | 40.16                   | AV | 54             | 13.84       | 50.58            | 27.42                 | 4.31              | 42.15              | -10.42                   |
| Frequency(MHz): |                         |    | 2480           |             | Polarity:        |                       | HORIZONTAL        |                    |                          |
| Frequency (MHz) | Emission Level (dBuV/m) |    | Limit (dBuV/m) | Margin (dB) | Raw Value (dBuV) | Antenna Factor (dB/m) | Cable Factor (dB) | Pre-amplifier (dB) | Correction Factor (dB/m) |
| 2483.50         | 60.43                   | PK | 74             | 13.57       | 70.54            | 27.7                  | 4.47              | 42.28              | -10.11                   |
| 2483.50         | 43.17                   | AV | 54             | 10.83       | 53.28            | 27.7                  | 4.47              | 42.28              | -10.11                   |
| Frequency(MHz): |                         |    | 2480           |             | Polarity:        |                       | VERTICAL          |                    |                          |
| Frequency (MHz) | Emission Level (dBuV/m) |    | Limit (dBuV/m) | Margin (dB) | Raw Value (dBuV) | Antenna Factor (dB/m) | Cable Factor (dB) | Pre-amplifier (dB) | Correction Factor (dB/m) |
| 2483.50         | 59.07                   | PK | 74             | 14.93       | 69.18            | 27.7                  | 4.47              | 42.28              | -10.11                   |
| 2483.50         | 41.38                   | AV | 54             | 12.62       | 51.49            | 27.7                  | 4.47              | 42.28              | -10.11                   |

#### REMARKS:

1. Emission level (dBuV/m) =Raw Value (dBuV)+Correction Factor (dB/m)
2. Correction Factor (dB/m) = Antenna Factor (dB/m)+Cable Factor (dB)- Pre-amplifier
3. Margin value = Limit value- Emission level.
4. -- Mean the PK detector measured value is below average limit.
5. The other emission levels were very low against the limit.

### 4.3 Maximum Peak Output Power

**Limit**

The Maximum Peak Output Power Measurement is 125mW (20.97).

**Test Procedure**

Remove the antenna from the EUT and then connect a low loss RF cable from the antenna port to the powersensor.

**Test Configuration**

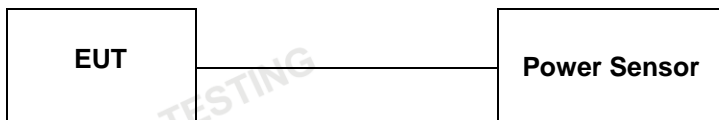

**Test Results**

| Type     | Channel | Output power (dBm) | Limit (dBm) | Result |
|----------|---------|--------------------|-------------|--------|
| GFSK     | 00      | -2.13              | 20.97       | Pass   |
|          | 39      | -1.46              |             |        |
|          | 78      | -0.85              |             |        |
| π/4DQPSK | 00      | -2.15              | 20.97       | Pass   |
|          | 39      | -1.46              |             |        |
|          | 78      | -0.88              |             |        |

Note: 1.The test results including the cable lose.

### 4.4 20dB Bandwidth

**Limit**

For frequency hopping systems operating in the 2400MHz-2483.5MHz no limit for 20dB bandwidth.

**Test Procedure**

The transmitter output was connected to the spectrum analyzer through an attenuator. The bandwidth of the fundamental frequency was measured by spectrum analyzer with 30 KHz RBW and 100 KHz VBW.

The 20dB bandwidth is defined as the total spectrum the power of which is higher than peak power minus 20dB.

**Test Configuration**

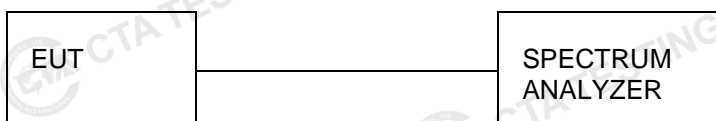

**Test Results**

| Modulation | Channel | 20dB bandwidth (MHz) | Result |
|------------|---------|----------------------|--------|
| GFSK       | CH00    | 1.002                | Pass   |
|            | CH39    | 1.005                |        |
|            | CH78    | 0.954                |        |
| π/4DQPSK   | CH00    | 1.305                |        |
|            | CH39    | 1.293                |        |
|            | CH78    | 1.347                |        |

Test plot as follows:

GFSK Modulation



CH00



CH39

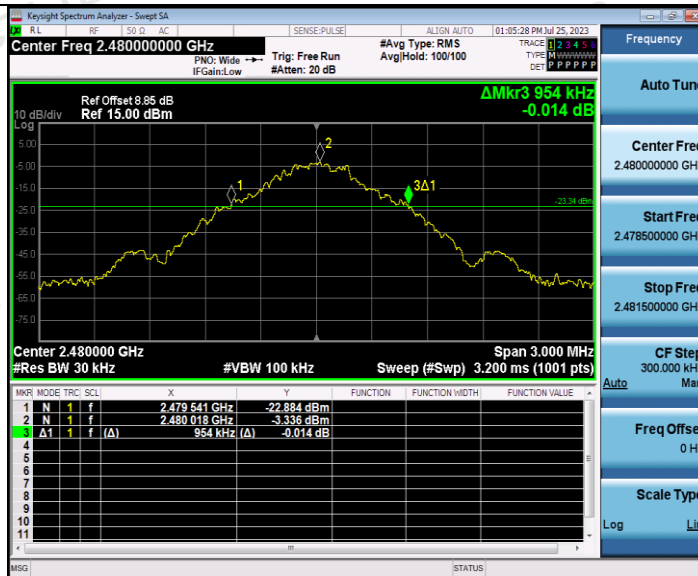

CH78

Shenzhen CTA Testing Technology Co., Ltd.

Room 106, Building 1, Yibaolai Industrial Park, Qiaotou Community, Fuhai Street, Bao'an District, Shenzhen, China  
 Tel:+86-755 2322 5875 E-mail:cta@cta-test.cn Web:http://www.cta-test.cn

$\pi/4$ DQPSK Modulation



CH00



CH39



CH78

Shenzhen CTA Testing Technology Co., Ltd.

Room 106, Building 1, Yibaolai Industrial Park, Qiaotou Community, Fuhai Street, Bao'an District, Shenzhen, China  
 Tel:+86-755 2322 5875 E-mail:cta@cta-test.cn Web:http://www.cta-test.cn

## 4.5 Frequency Separation

### LIMIT

According to 15.247(a)(1), frequency hopping systems shall have hopping channel carrier frequencies separated by minimum of 25KHz or the  $2/3 \times 20\text{dB}$  bandwidth of the hopping channel, whichever is greater.

### TEST PROCEDURE

The transmitter output was connected to the spectrum analyzer through an attenuator. The bandwidth of the fundamental frequency was measured by spectrum analyzer with 100 KHz RBW and 300 KHz VBW.

### TEST CONFIGURATION

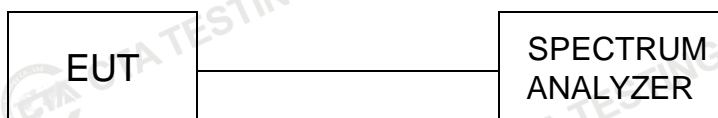

### TEST RESULTS

| Modulation    | Channel | Channel Separation (MHz) | Limit(MHz)                                  | Result |
|---------------|---------|--------------------------|---|--------|
| GFSK          | CH38    | 1.316                    | 25KHz or $2/3 \times 20\text{dB}$ bandwidth | Pass   |
|               | CH39    |                          |   |        |
| $\pi/4$ DQPSK | CH38    | 1.168                    | 25KHz or $2/3 \times 20\text{dB}$ bandwidth | Pass   |
|               | CH39    |                          |   |        |

Note:

We have tested all mode at high, middle and low channel, and recorded worst case at middle

Test plot as follows:

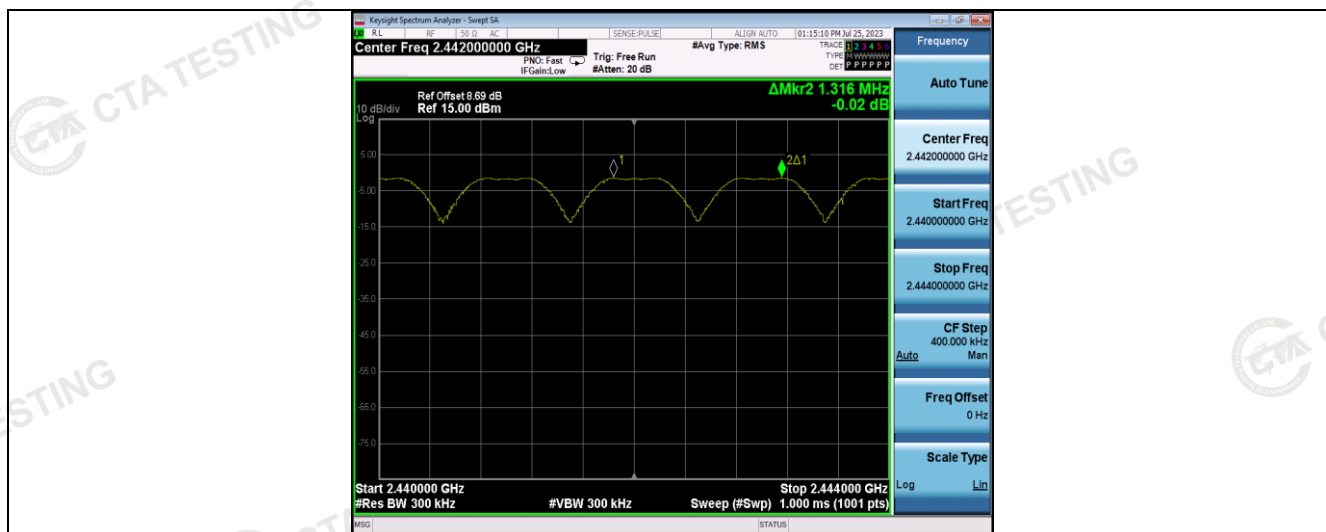

GFSK

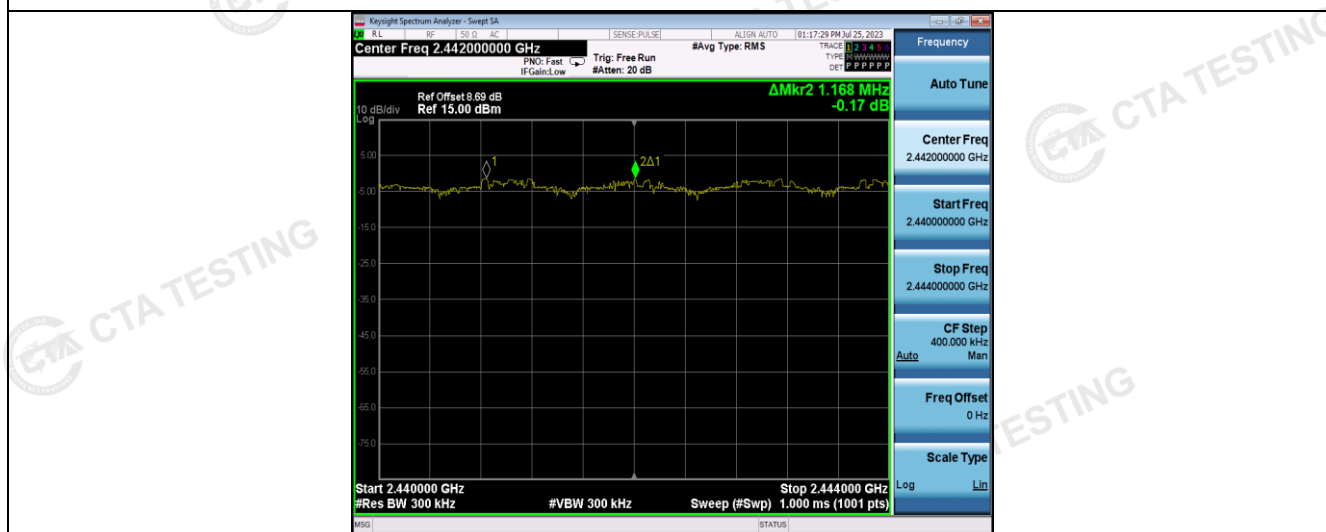

$\pi/4$ DQPSK



### 4.6 Number of hopping frequency

**Limit**

Frequency hopping systems in the 2400–2483.5 MHz band shall use at least 15 channels.

**Test Procedure**

The transmitter output was connected to the spectrum analyzer through an attenuator. Set spectrum analyzer start 2400MHz to 2483.5MHz with 100 KHz RBW and 300 KHz VBW.

**Test Configuration**



**Test Results**

| Modulation    | Number of Hopping Channel | Limit | Result |
|---------------|---------------------------|-------|--------|
| GFSK          | 79                        | ≥15   | Pass   |
| $\pi/4$ DQPSK | 79                        |       |        |

**Test plot as follows:**

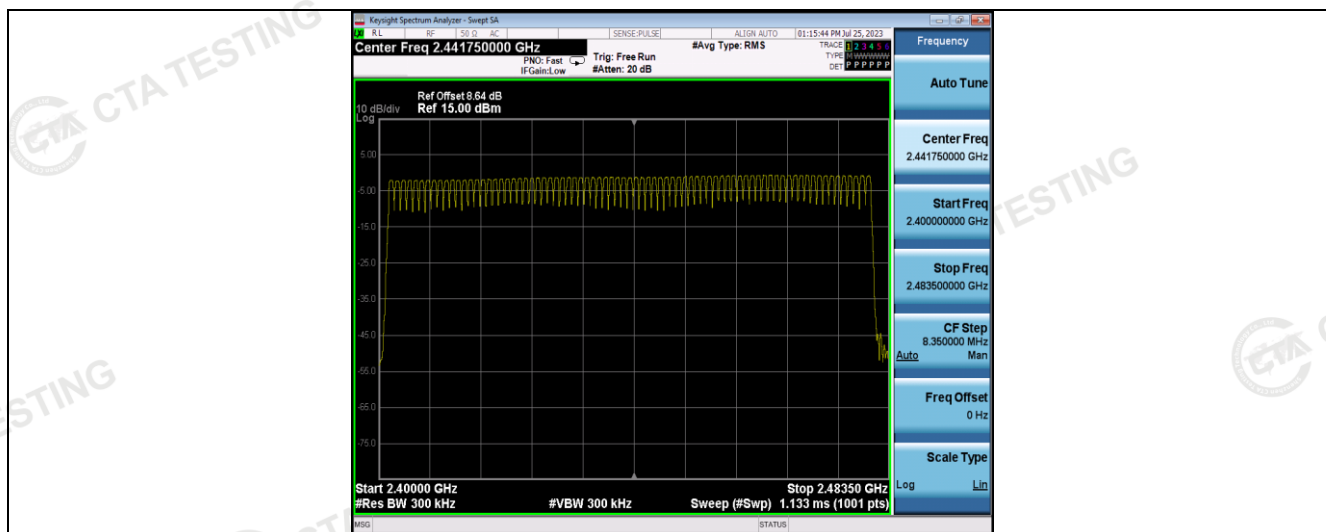

GFSK Modulation

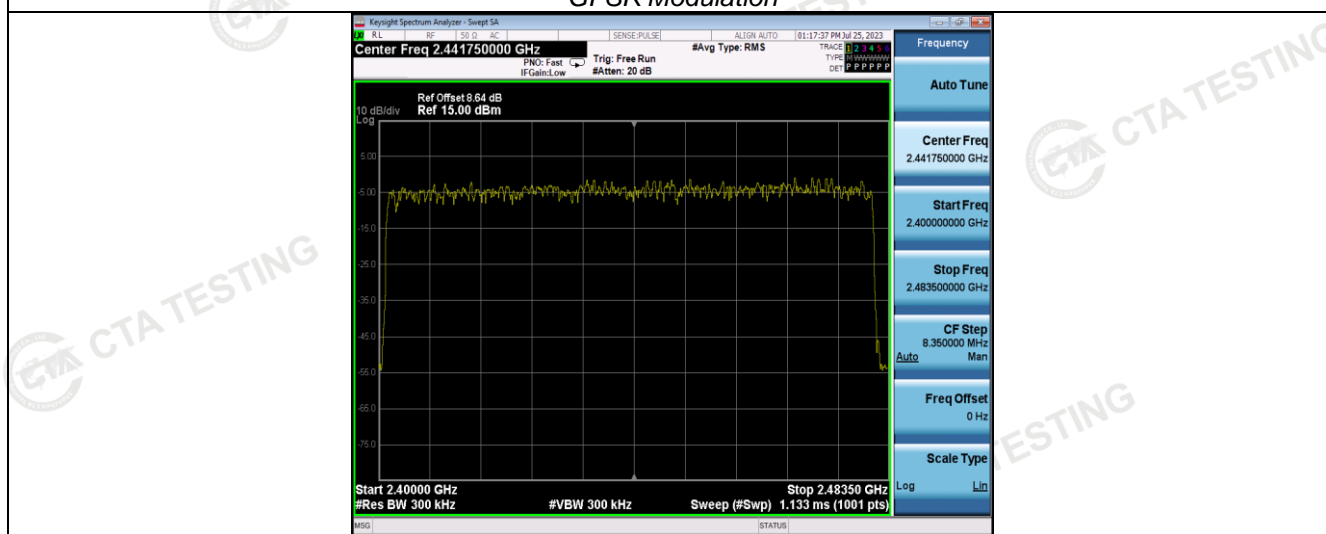

$\pi/4$ DQPSK Modulation

### 4.7 Time of Occupancy (Dwell Time)

**Limit**

The average time of occupancy on any channel shall not be greater than 0.4 seconds within a period of 0.4 seconds multiplied by the number of hopping channels employed.

**Test Procedure**

The transmitter output was connected to the spectrum analyzer through an attenuator. Set center frequency of spectrum analyzer=operating frequency with 1MHz RBW and 1MHz VBW, Span 0Hz.

**Test Configuration**

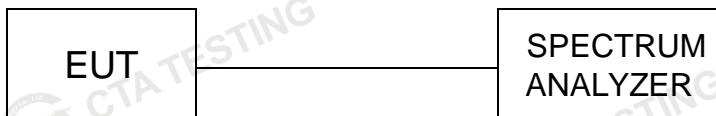

**Test Results**

| Modulation | Packet | Burst time (ms) | Dwell time (s) | Limit (s) | Result |
|------------|--------|-----------------|----------------|-----------|--------|
| GFSK       | DH1    | 0.36            | 0.115          | 0.40      | Pass   |
|            | DH3    | 1.62            | 0.259          |           |        |
|            | DH5    | 2.87            | 0.306          |           |        |
| π/4DQPSK   | 2-DH1  | 0.36            | 0.115          | 0.40      | Pass   |
|            | 2-DH3  | 1.62            | 0.259          |           |        |
|            | 2-DH5  | 2.87            | 0.306          |           |        |

Note: We have tested all mode at high, middle and low channel, and recorded worst case at middle channel.

Dwell time = Pulse time (ms) × (1600 ÷ 2 ÷ 79) × 31.6 Second for DH1, 2-DH1

Dwell time = Pulse time (ms) × (1600 ÷ 4 ÷ 79) × 31.6 Second for DH3, 2-DH3

Dwell time = Pulse time (ms) × (1600 ÷ 6 ÷ 79) × 31.6 Second for DH5, 2-DH5

Test plot as follows:

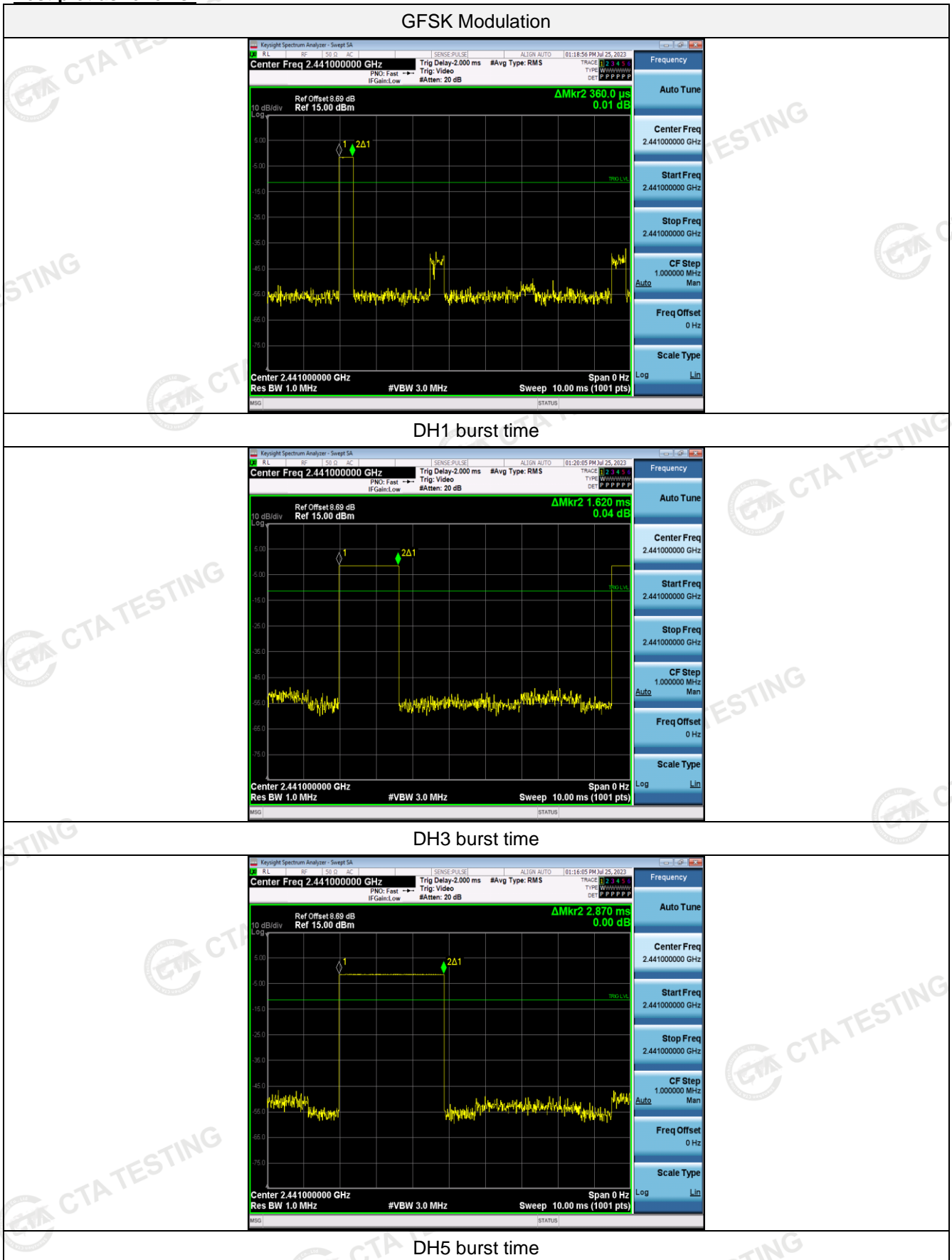

### $\pi/4$ DQPSK Modulation

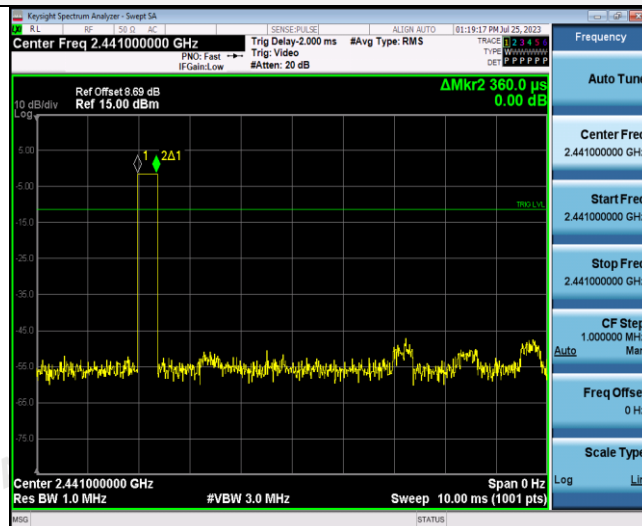

2-DH1 burst time

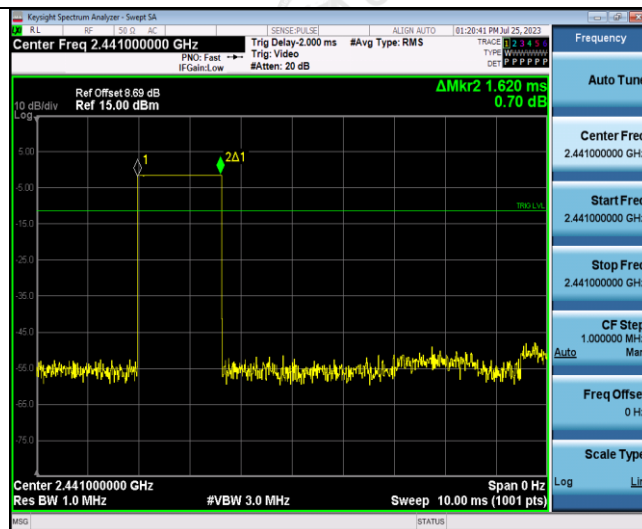

2-DH3 burst time

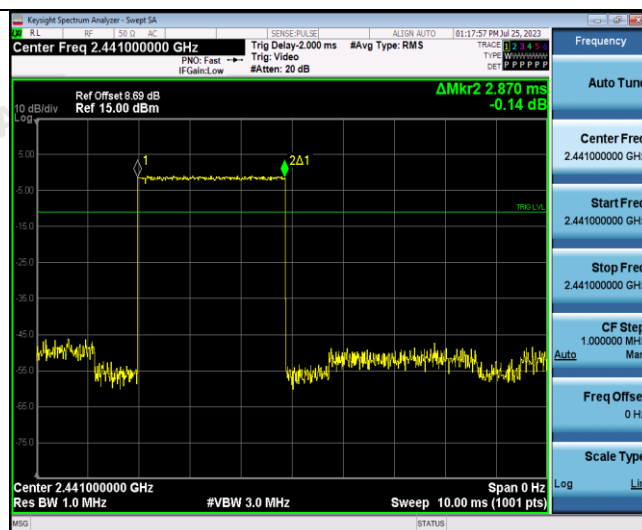

2-DH5 burst time

## 4.8 Out-of-band Emissions

### Limit

In any 100 kHz bandwidth outside the frequency band in which the spread spectrum or digitally modulated intentional radiator is operating, the radio frequency power that is produced by the intentional radiator shall be at least 20 dB below that in the 100 kHz bandwidth within the band that contains the highest level of the desired power, based on either an RF conducted or a radiated measurement, provided the transmitter demonstrates compliance with the peak conducted power limits. If the transmitter complies with the conducted power limits based on the use of RMS averaging over a time interval, as permitted under paragraph (b)(3) of this section, the attenuation required under this paragraph shall be 30 dB instead of 20 dB. Attenuation below the general limits specified in §15.209(a) is not required.

### Test Procedure

Connect the transmitter output to spectrum analyzer using a low loss RF cable, and set the spectrum analyzer to RBW=100 kHz, VBW= 300 kHz, peak detector, and max hold. Measurements utilizing these settings are made of the in-band reference level, bandedge and out-of-band emissions.

### Test Configuration

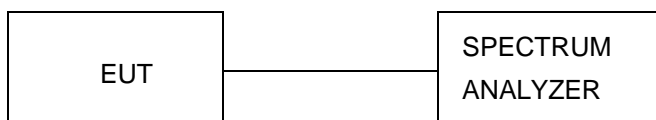

### Test Results

Remark: The measurement frequency range is from 30MHz to the 10th harmonic of the fundamental frequency. The lowest, middle and highest channels are tested to verify the spurious emissions and bandedge measurement data.

We measured all conditions (DH1, DH3, DH5) and recorded worst case at DH5

Test plot as follows:

