



2023

深圳祥博一科技有限公司

Shenzhen Xiangboyi Technology Co. Ltd

天线测试报告

Antenna report



TEST REPORT

01 客户名称/Customer :

02 项目名称/Project: 华一精品

03 立项编号/Project NO: XBY210553

04 工程师/Engineer: 杨小文
电话/Phone: 15820795642

PART 1

测试报告版本/Report version

日期 Date	天线版本 Antenna version	主板版本 PCB version	变更描述 Description of Change
2023-10-14			样品天线测试数据

NO	ITEMS	DETAILS
1	工作频段 Operating band	WIFI:2.4G
2	频率范围 Frequency band	WIFI:2400-2500Mhz
3	天线类型 Antenna type	WIFI:PIFA
4	天线材质及实现形状 Material and implementation shape	FPC+焊线

PART 3

Test system and equipment

	测试项目/Test items	设备/equipment
1: S参数 S parameter	1. 回波损耗 Return loss 2. 驻波比 VSWR	网络分析仪/Network analyzer: A338/A333
2: 耦合功率测试 Active test	1. 发射功率 Transmitting power 2. 接收灵敏度 Receiving sensitivity	综合测试仪/Comprehensive test instrument: Agilent 8960/ CMW500
3: 辐射模式与增益 Radiation mode and gain	1. 效率,增益 gain 2. 辐射模式 Radiation mode	1. 暗室/Shielding room: 7x4x3 m (ETS-3D) 2. 网络分析仪/Network analyzer: HP 8753D

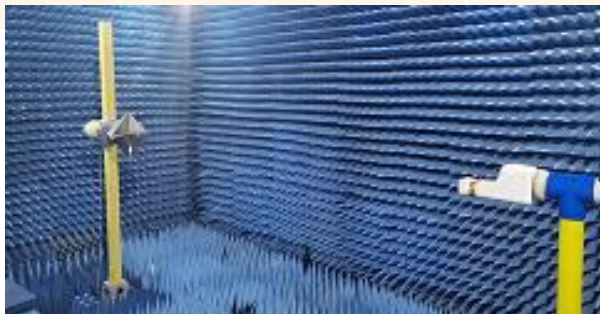
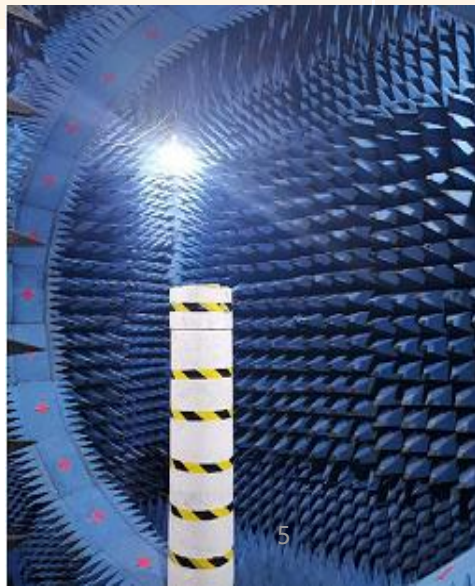

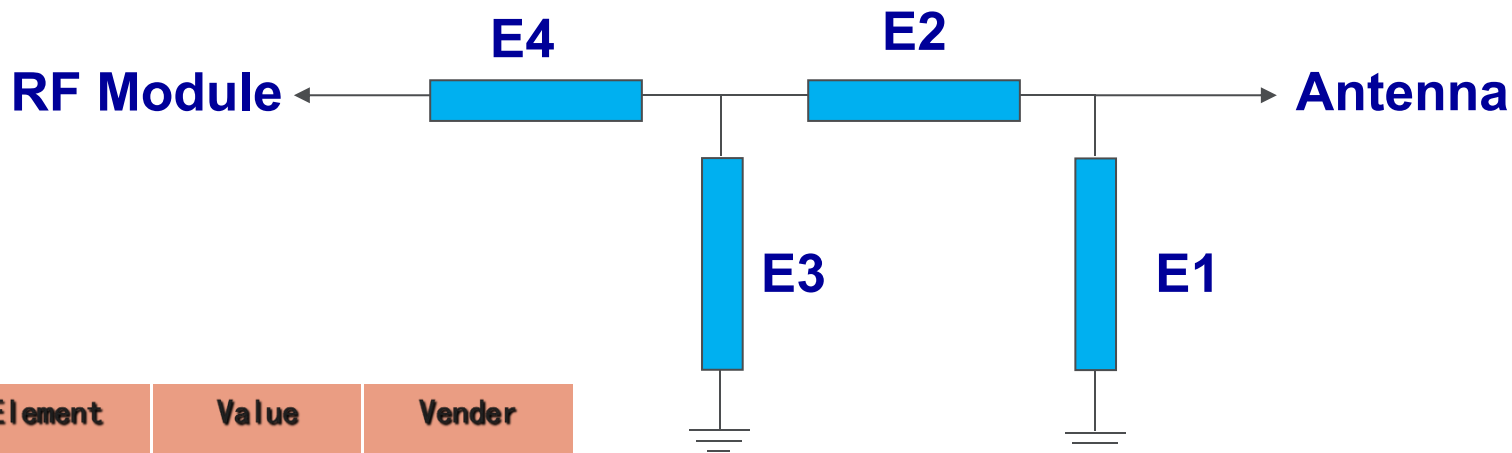

Element	Value	Vender
E1 (0402)	NA	
E2 (0402)	0 Ohm	
E3 (0402)	NA	
E4 (0402)	0 Ohm	

Original match unchanged.

WIFI BAND	802.11b : 11Mbps			802.11g : 54Mbps		
Channel	CH1	CH6	CH11	CH1	CH6	CH11
TRP	13.04	13.15	12.43	13.28	13.04	11.96
TIS			-82.6			-70.67

WIFI BAND	802.11n : MCS7					
Channel	CH1	CH6	CH11			
TRP	11.35	11.64	10.04			
TIS			-70.74			

Freq (MHz)	Effi (%)	Gain (dBi)
2400	39	-0.46
2410	35.48	-1.28
2420	41.98	-0.47
2430	36.69	-1.22
2440	50.56	0.59
2450	49.49	0.48
2460	55.76	1.02
2470	51.35	0.52
2480	62.51	1.21
2490	55.76	0.6
2500	54.78	0.44

PART 5

测试数据/RF Report

Horizontal

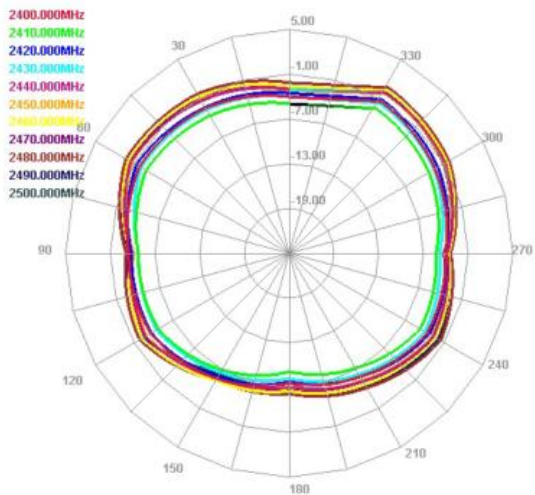

E1 Face

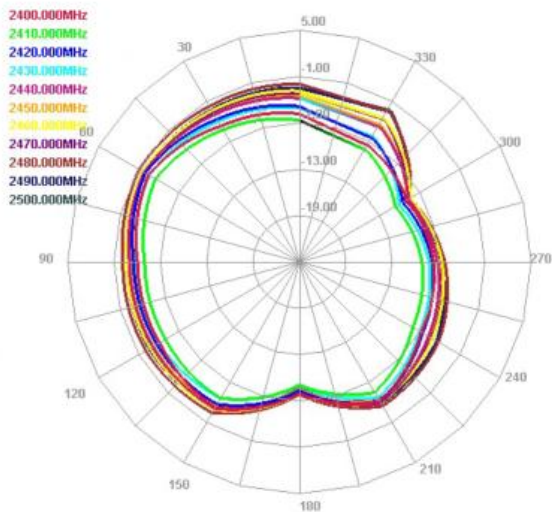

E2 Face

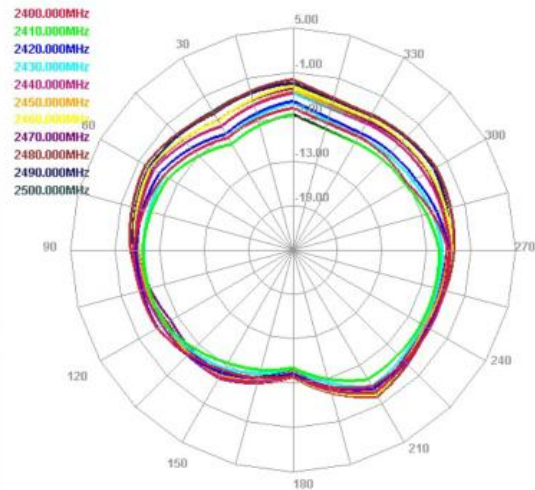

PART 5

测试数据/RFReport

2400.000MHz

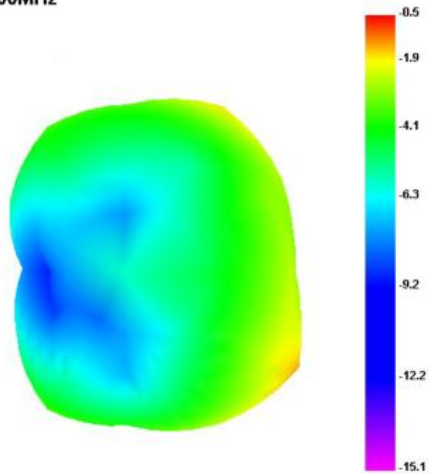

2450.000MHz

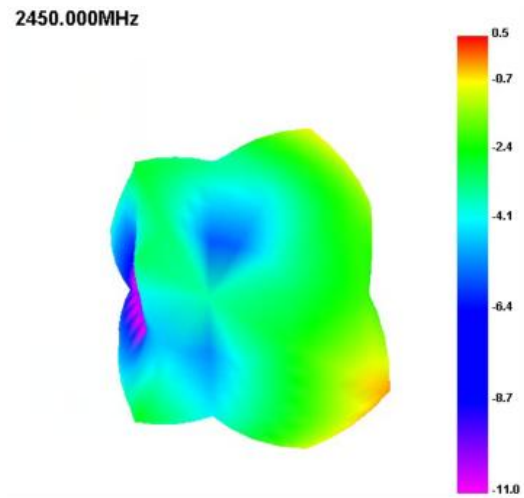

2500.000MHz

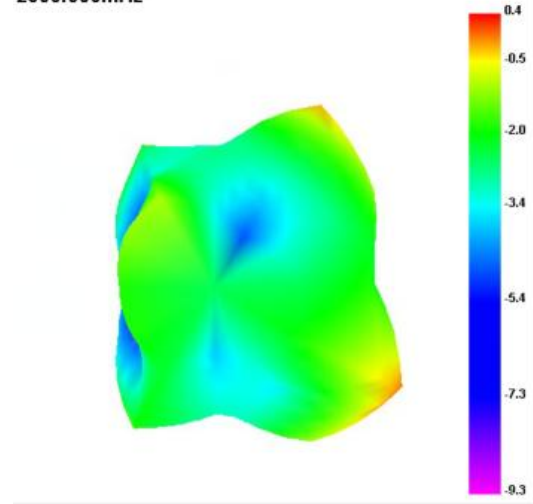

PART 6

测试数据/RF Report

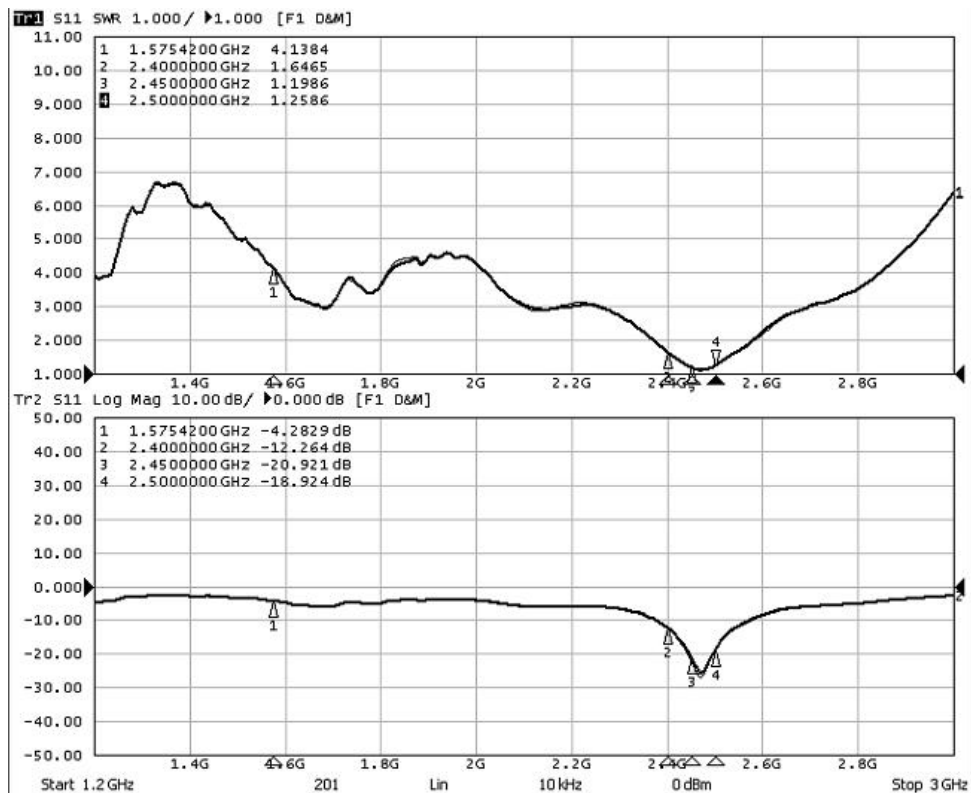

PART 7

组装方式/Assembly method







2023 Thanks!

Your content to play here, or through your copy, paste in this box, and select only the text. Your content to play here, or through your copy, paste in this box, and select only the text.

Shenzhen XiangBoYi Technology Co., Ltd.
Address: Second Floor, Room B, Room B, Block B, Zhongfeng Runfeng Pioneer Park, Minzhi Road, Longhua New District, Shenzhen, China