

TEST REPORT

Report No.: BCTC2408541397-1E

Applicant: SHENZHEN SNAPPER TECHNOLOGY CO., LTD

Product Name: Travel Power Bank

Test Model: PS-B009WALR

Tested Date: 2024-08-09 to 2024-08-29

Issued Date: 2024-08-29

Shenzhen BCTC Testing Co., Ltd.



FCC ID: 2BC8J-PS-B009WALR

Product Name: Travel Power Bank
Trademark: N/A
Model/Type Reference: PS-B009WALR
PS-B009WA, PS-B009WAL, QM10005AC, FO 008, APBCH10SQBKB,
APBCH10SQWHB, A 0319A, DLP4349C
Prepared For: SHENZHEN SNAPPER TECHNOLOGY CO., LTD
Address: F4, BldgE, Fenghuang third Industrial area Tengfeng Road, Fuyong, Baoan,
Shenzhen, 518000, China
Manufacturer: SHENZHEN SNAPPER TECHNOLOGY CO., LTD
Address: F4, BldgE, Fenghuang third Industrial area Tengfeng Road, Fuyong, Baoan,
Shenzhen, 518000, China
Prepared By: Shenzhen BCTC Testing Co., Ltd.
Address: 1-2/F., Building B, Pengzhou Industrial Park, No.158, Fuyuan 1st Road,
Zhancheng, Fuhai Subdistrict, Bao'an District, Shenzhen, Guangdong, China.
Sample Received Date: 2024-08-09
Sample Tested Date: 2024-08-09 to 2024-08-29
Issue Date: 2024-08-29
Report No.: BCTC2408541397-1E
Test Standards: FCC Part15.209
ANSI C63.10-2013
Test Results: PASS

Tested by:
Shanshan Zhang

Shanshan. Zhang / Project Handler

Approved by:



Zero Zhou/Reviewer

The test report is effective only with both signature and specialized stamp. This result(s) shown in this report refer only to the sample(s) tested. Without written approval of Shenzhen BCTC Testing Co., Ltd, this report can't be reproduced except in full. The tested sample(s) and the sample information are provided by the client.



Table Of Content

	Page
Test Report Declaration	
1. Version	4
2. Test Summary	5
3. Measurement Uncertainty	6
4. Product Information And Test Setup	7
4.1 Product Information	7
4.2 Support Equipment	7
4.3 Test Setup Configuration	8
4.4 Test Mode	9
5. Test Facility And Test Instrument Used	10
5.1 Test Facility	10
5.2 Test Instrument Used	10
6. Conducted Emissions	12
6.1 Block Diagram Of Test Setup	12
6.2 Limit	12
6.3 Test procedure	12
6.4 EUT operating Conditions	12
6.5 Test Result	13
7. Radiated Emissions	15
7.1 Block Diagram Of Test Setup	15
7.2 Limit	16
7.3 Test procedure	16
7.4 Test Result	17
8. Bandwidth Test	23
8.1 Test Procedure	23
8.2 Test Setup	23
8.3 Test Result	24
9. Antenna Requirements	25
9.1 Limit	25
9.2 Test Result	25
10. EUT Photographs	26
11. EUT Test Setup Photographs	27

(Note: N/A Means Not Applicable)

1. Version

Report No.	Issue Date	Description	Approved
BCTC2408541397-1E	2024-08-29	Original	Valid

TEC
TC
OVB
t See

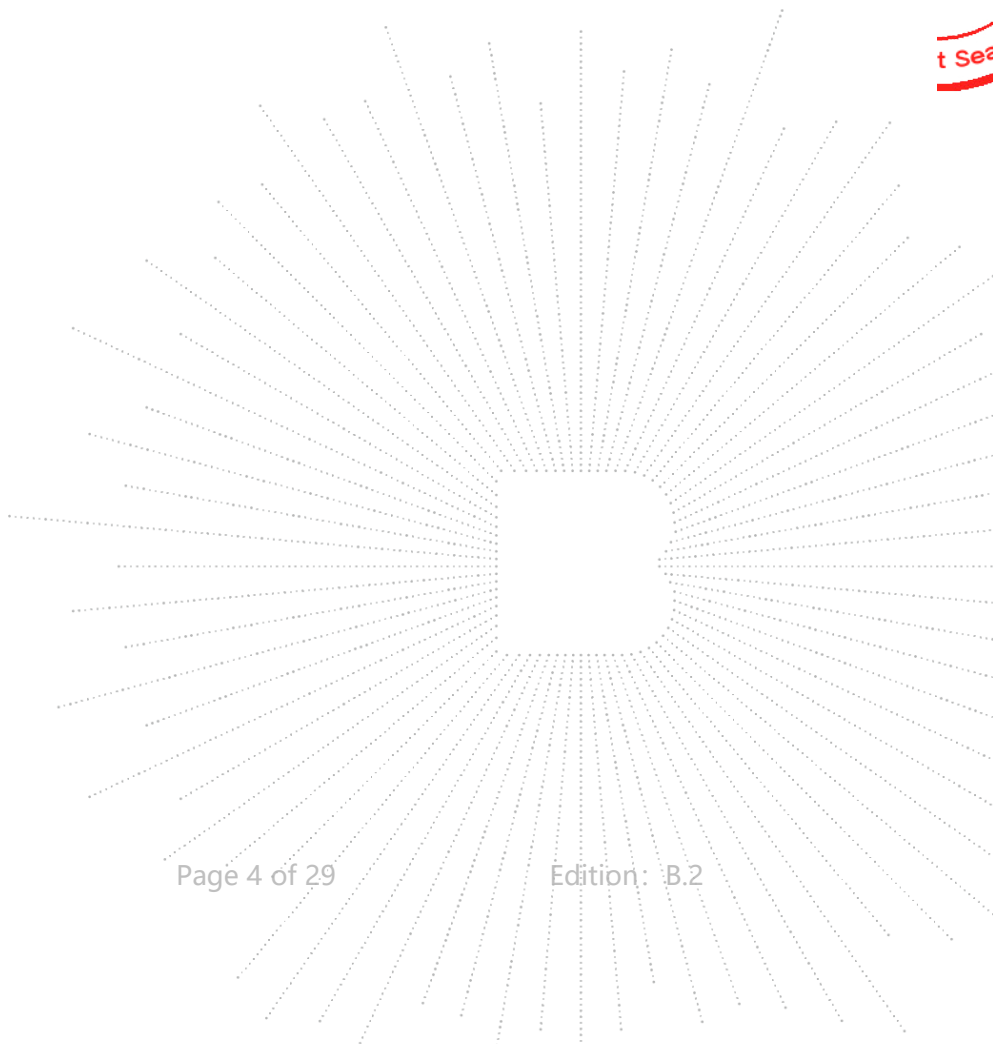

2. Test Summary

The Product has been tested according to the following specifications:

No.	Test Parameter	Clause No.	Results
1	Conducted Emission	15.207	PASS
2	Radiated Emission	15.209	PASS
3	20dB Bandwidth	15.215	PASS
4	Antenna Requirement	15.203	PASS

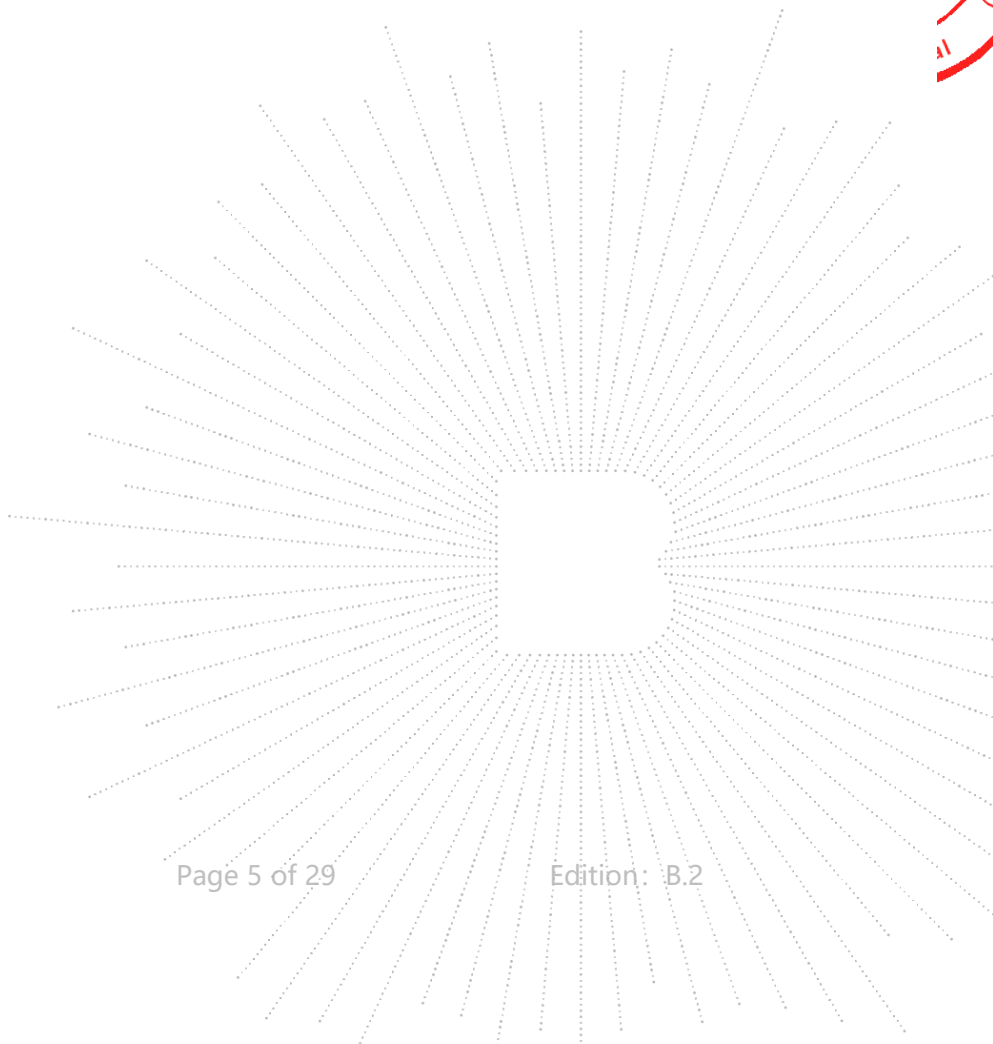

3. Measurement Uncertainty

Where relevant, the following measurement uncertainty levels have been estimated for tests performed on the Product as specified in CISPR 16-4-2. This uncertainty represents an expanded uncertainty expressed at approximately the 95% confidence level using a coverage factor of $k=2$.

No.	Item	Uncertainty
1	3m chamber Radiated spurious emission(30MHz-1GHz)	U=4.3dB
2	Conducted Emission (150kHz-30MHz)	U=3.2dB
3	humidity uncertainty	U=5.3%
4	Temperature uncertainty	U=0.59°C

CO., LTD

4. Product Information And Test Setup

4.1 Product Information

Model/Type Reference:	PS-B009WALR PS-B009WA, PS-B009WAL, QM10005AC, FO 008, APBCH10SQBKB, APBCH10SQWHB, A 0319A, DLP4349C
Model Differences:	All the model are the same circuit and RF module, except model names and appearance of the color.
Hardware Version:	N/A
Software Version:	N/A
Modulation:	ASK
Operation Frequency:	115kHz-205kHz, 320-350kHz
Antenna installation:	loop coil antenna
Ratings:	Battery: 10000mAh @3.7V 37Wh AC Input: 100-240V AC, 50Hz/60Hz, 0.3A(Max) Type-C Input: DC 5V=3A, 9V=2A, 12V=1.5A Type-C Output: DC 5V=3A, 9V=2.22A, 12V=1.67A Type-C Wire Output: DC 5V=3A, 9V=2.22A, 12V=1.67A Lightning adaptor output: DC 5V=2.4A, 9V=2.0A USB-A Output: DC 5V=3A, 9V=2A, 12V=1.5A, 18W Max Wireless Output: 5W/7.5W/10W/15W Watch Wireless Output: 5V=2.5W (Max) Adaptor mode output: 5V=2A Total Sharing Output: 5V=3A

4.2 Support Equipment

No.	Device Type	Brand	Model	Series No.	Note
E-1	Travel Power Bank	N/A	PS-B009WALR	N/A	EUT
E-2	ADAPTER	UGREEN	CD122	N/A	Auxiliary
E-3	Dummy load	N/A	DL01	N/A	Auxiliary

Notes:

1. All the equipment/cables were placed in the worst-case configuration to maximize the emission during the test.
2. Grounding was established in accordance with the manufacturer's requirements and conditions for the intended use.



4.3 Test Setup Configuration

See test photographs attached in *EUT TEST SETUP PHOTOGRAPHS* for the actual connections between Product and support equipment.

AC Mode:

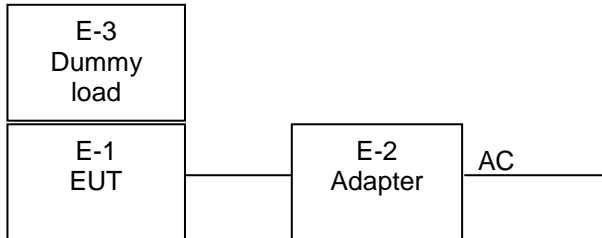

DC Mode:

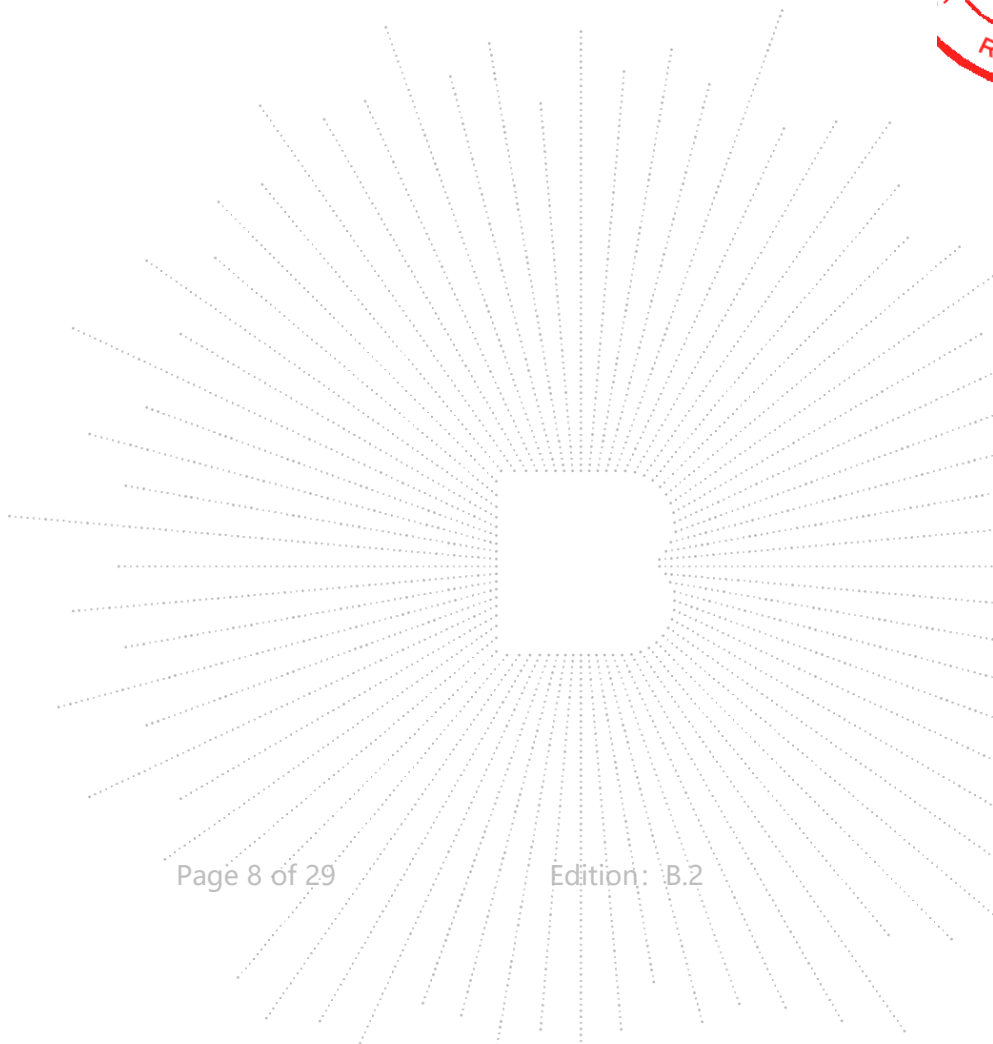
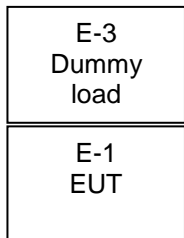

4.4 Test Mode

To investigate the maximum EMI emission characteristics generates from EUT, the test system was pre-scanning tested base on the consideration of following EUT operation mode or test configuration mode which possible have effect on EMI emission level. Each of these EUT operation mode(s) or test configuration mode(s) mentioned above was evaluated respectively.

AC Mode	Mode 1	AC Plug in + Wireless 5W(115-205kHz)
	Mode 2	AC Plug in + Wireless 2.5W(320-350kHz)
	Mode 3	Type-C in +Wireless 5W(115-205kHz)
	Mode 4	Type-C in + Wireless 2.5W(320-350kHz)
DC Mode	Mode 5	Wireless 5W(115-205kHz)
	Mode 6	Wireless 7.5W(115-205kHz)
	Mode 7	Wireless 10W(115-205kHz)
	Mode 8	Wireless 15W(115-205kHz)
	Mode 9	Wireless 2.5W(320-350kHz)

Note: All test mode were tested and passed, only shows the worst case mode which were recorded in this report.

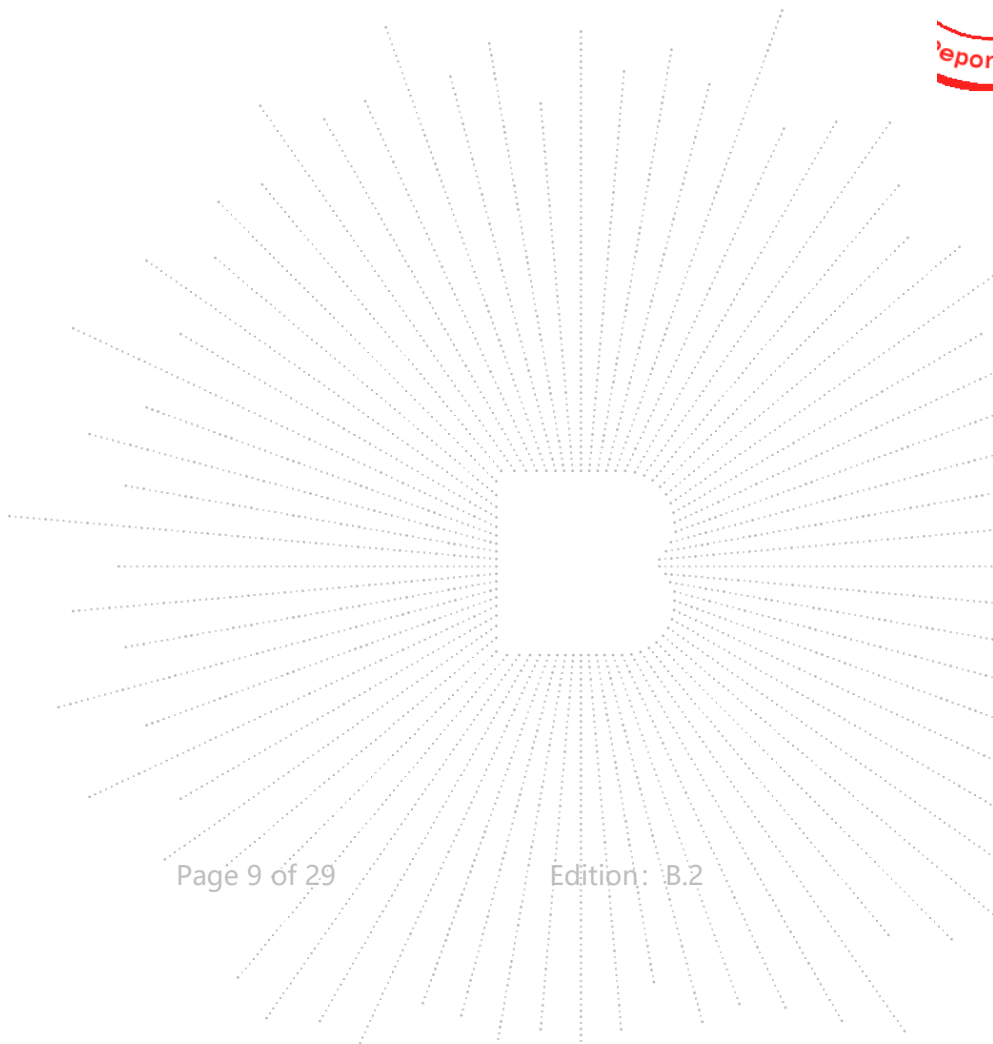

5. Test Facility And Test Instrument Used

5.1 Test Facility

All measurement facilities used to collect the measurement data are located at Shenzhen BCTC Testing Co., Ltd. Address:1-2/F., Building B, Pengzhou Industrial Park, No.158, Fuyuan 1st Road, Zhancheng, Fuhai Subdistrict, Bao'an District, Shenzhen, Guangdong, China. The site and apparatus are constructed in conformance with the requirements of ANSI C63.4 and CISPR 16-1-1 other equivalent standards.

FCC Test Firm Registration Number: 712850

A2LA certificate registration number is: CN1212

ISED Registered No.: 23583

ISED CAB identifier: CN0017

5.2 Test Instrument Used

Conducted Emissions Test					
Equipment	Manufacturer	Model#	Serial#	Last Cal.	Next Cal.
Receiver	R&S	ESR3	102075	May 16, 2024	May 15, 2025
LISN	R&S	ENV216	101375	May 16, 2024	May 15, 2025
Software	Frad	EZ-EMC	EMC-CON 3A1	\	\
Pulse limiter	Schwarzbeck	VTSD9561-F	01323	May 16, 2024	May 15, 2025

RF Conducted Test					
Equipment	Manufacturer	Model#	Serial#	Last Cal.	Next Cal.
Power Meter	Keysight	E4419	\	May 16, 2024	May 15, 2025
Power Sensor (AV)	Keysight	E9300A	\	May 16, 2024	May 15, 2025
Signal Analyzer 20kHz-26.5G Hz	Keysight	N9020A	MY49100060	May 16, 2024	May 15, 2025
Spectrum Analyzer 9kHz-40GHz	R&S	FSP 40	\	May 16, 2024	May 15, 2025

Radiated Emissions Test (966 Chamber01)					
Equipment	Manufacturer	Model#	Serial#	Last Cal.	Next Cal.
966 chamber	ChengYu	966 Room	966	May 16, 2024	May 15, 2025
Receiver	R&S	ESR3	102075	May 16, 2024	May 15, 2025
Receiver	R&S	ESRP	101154	May 16, 2024	May 15, 2025
Amplifier	Schwarzbeck	BBV9744	9744-0037	May 16, 2024	May 15, 2025
TRILOG Broadband Antenna	Schwarzbeck	VULB9163	942	May 21, 2024	May 20, 2025
Loop Antenna(9KHz -30MHz)	Schwarzbeck	FMZB1519B	00014	May 21, 2024	May 20, 2025
Amplifier	SKET	LAPA_01G1 8G-45dB	SK202104090 1	May 16, 2024	May 15, 2025
Horn Antenna	Schwarzbeck	BBHA9120D	1541	May 21, 2024	May 20, 2025
Amplifier(18G Hz-40GHz)	MITEQ	TTA1840-35-HG	2034381	May 16, 2024	May 15, 2025
Horn Antenn(18GHz-40GHz)	Schwarzbeck	BBHA9170	00822	May 21, 2024	May 20, 2025
Spectrum Analyzer9kHz-40GHz	R&S	FSP40	100363	May 16, 2024	May 15, 2025
Software	Frad	EZ-EMC	FA-03A2 RE	\	\

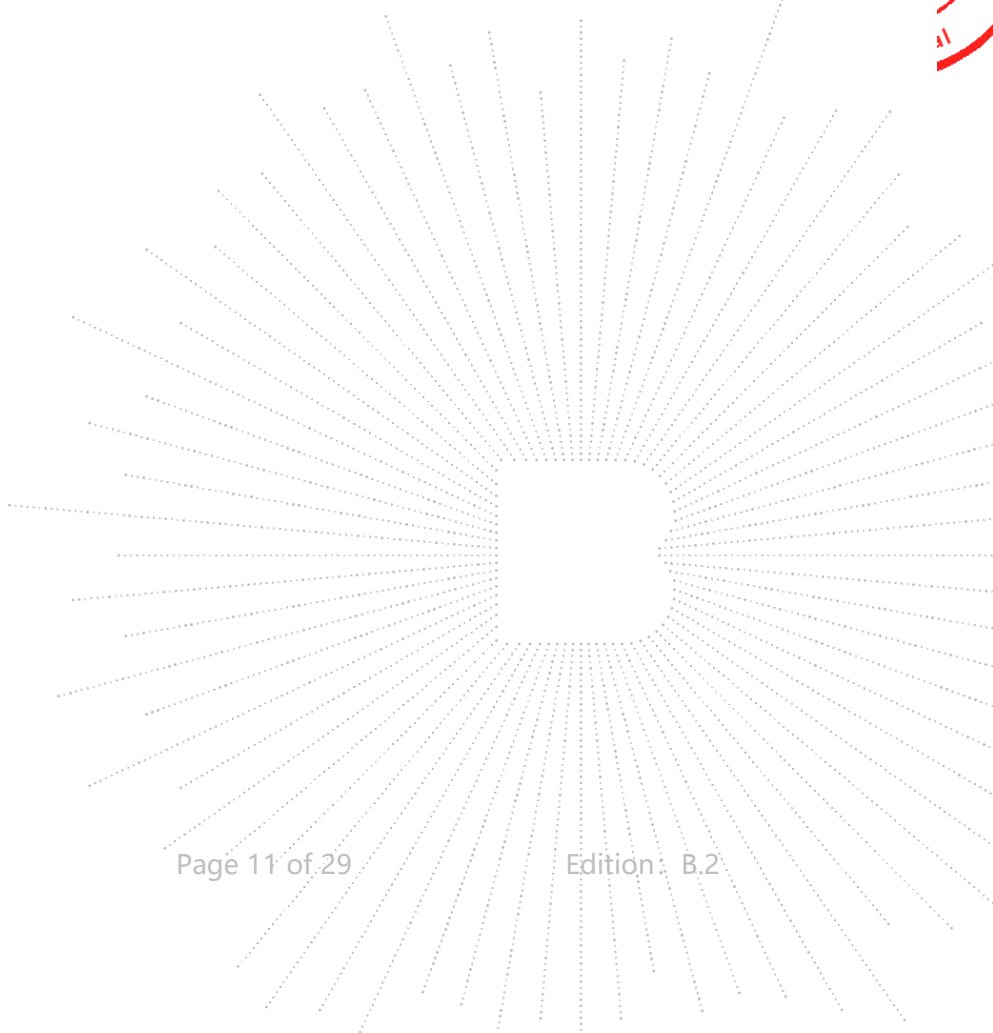

6. Conducted Emissions

6.1 Block Diagram Of Test Setup

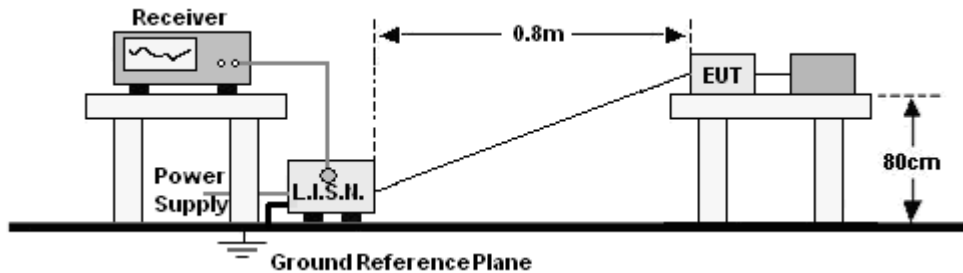

6.2 Limit

Frequency (MHz)	Limit (dBuV)	
	Quas-peak	Average
0.15 -0.5	66 - 56 *	56 - 46 *
0.50 -5.0	56.00	46.00
5.0 -30.0	60.00	50.00

Notes:
 1. *Decreasing linearly with logarithm of frequency.
 2. The lower limit shall apply at the transition frequencies.

6.3 Test procedure

Receiver Parameters	Setting
Attenuation	10 dB
Start Frequency	0.15 MHz
Stop Frequency	30 MHz
IF Bandwidth	9 kHz

- The Product was placed on a nonconductive table 0.8 m above the horizontal ground reference plane, and 0.4 m from the vertical ground reference plane, and connected to the main through Line Impedance Stability Network (L.I.S.N).
- The RBW of the receiver was set at 9 kHz in 150 kHz ~ 30MHz with Peak and AVG detector in Max Hold mode. Run the receiver's pre-scan to record the maximum disturbance generated from Product in all power lines in the full band.
- For each frequency whose maximum record was higher or close to limit, measure its QP and AVG values and record.

6.4 EUT operating Conditions

The EUT was configured for testing in a typical fashion (as a customer would normally use it). The EUT has been programmed to continuously transmit during test. This operating condition was tested and used to collect the included data.

6.5 Test Result

Temperature:	26 °C	Relative Humidity:	54%RH
Pressure:	101KPa	Phase :	L
Test Mode:	Mode 2 (The worst data)	Test Voltage:	AC 120V/60Hz

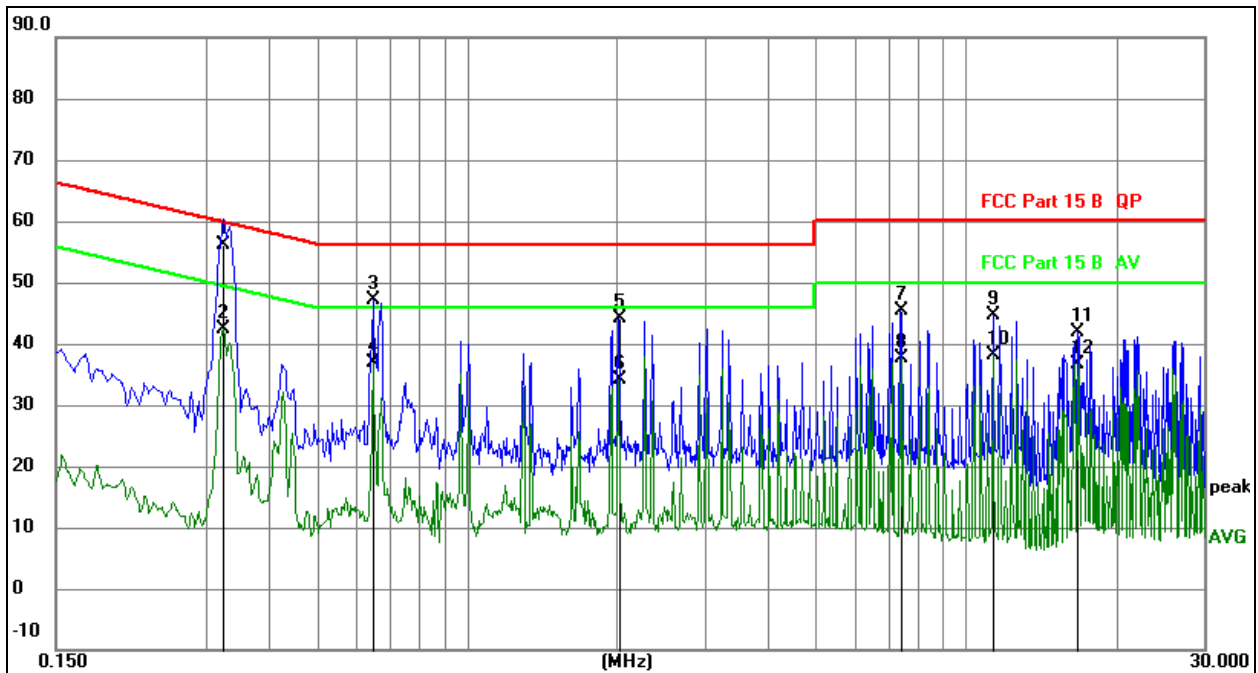

Remark:

1. All readings are Quasi-Peak and Average values.
2. Factor = Insertion Loss + Cable Loss.
3. Measurement = Reading Level + Correct Factor
4. Over = Measurement - Limit

No.	Mk.	Freq. MHz	Reading Level	Correct Factor dB	Measure- ment dBuV	Limit dBuV	Over dB	Detector
1	*	0.3250	36.17	20.07	56.24	59.58	-3.34	QP
2		0.3250	22.30	20.07	42.37	49.58	-7.21	AVG
3		0.6474	27.14	20.09	47.23	56.00	-8.77	QP
4		0.6474	16.70	20.09	36.79	46.00	-9.21	AVG
5		2.0119	24.10	20.10	44.20	56.00	-11.80	QP
6		2.0119	13.92	20.10	34.02	46.00	-11.98	AVG
7		7.3680	25.24	20.16	45.40	60.00	-14.60	QP
8		7.3680	17.58	20.16	37.74	50.00	-12.26	AVG
9		11.3170	24.31	20.21	44.52	60.00	-15.48	QP
10		11.3170	17.98	20.21	38.19	50.00	-11.81	AVG
11		16.7497	21.45	20.32	41.77	60.00	-18.23	QP
12		16.7497	16.32	20.32	36.64	50.00	-13.36	AVG

Temperature:	26 °C	Relative Humidity:	54%RH
Pressure:	101KPa	Phase :	N
Test Mode:	Mode 2 (The worst data)	Test Voltage:	AC 120V/60Hz

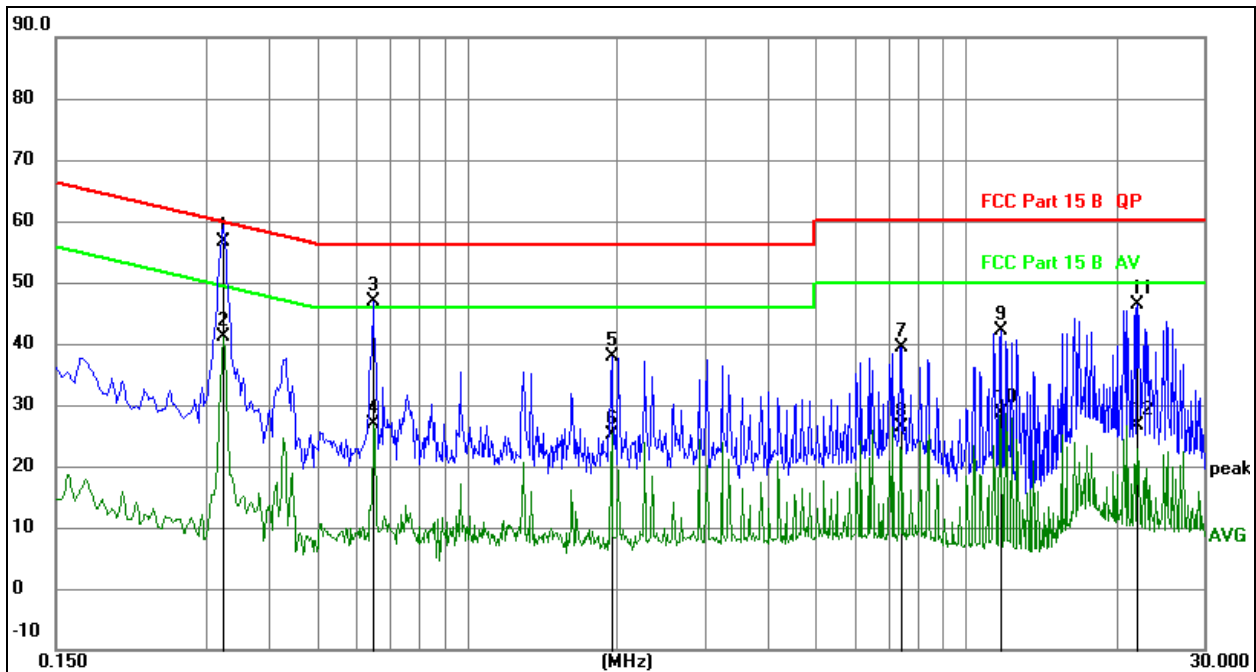
Remark:

1. All readings are Quasi-Peak and Average values.
2. Factor = Insertion Loss + Cable Loss.
3. Measurement = Reading Level + Correct Factor
4. Over = Measurement - Limit

No.	Mk.	Freq. MHz	Reading Level	Correct Factor dB	Measure- ment dBuV	Limit dBuV	Over dB	Detector
1	*	0.3250	36.52	20.07	56.59	59.58	-2.99	QP
2		0.3251	21.03	20.07	41.10	49.58	-8.48	AVG
3		0.6474	26.82	20.09	46.91	56.00	-9.09	QP
4		0.6474	6.78	20.09	26.87	46.00	-19.13	AVG
5		1.9489	17.72	20.10	37.82	56.00	-18.18	QP
6		1.9489	5.15	20.10	25.25	46.00	-20.75	AVG
7		7.3680	19.28	20.16	39.44	60.00	-20.56	QP
8		7.3680	6.24	20.16	26.40	50.00	-23.60	AVG
9		11.7446	21.90	20.22	42.12	60.00	-17.88	QP
10		11.7446	8.47	20.22	28.69	50.00	-21.31	AVG
11		22.0628	26.15	20.32	46.47	60.00	-13.53	QP
12		22.0628	6.27	20.32	26.59	50.00	-23.41	AVG

7. Radiated Emissions

7.1 Block Diagram Of Test Setup

(A) Radiated Emission Test-Up Frequency Below 30MHz

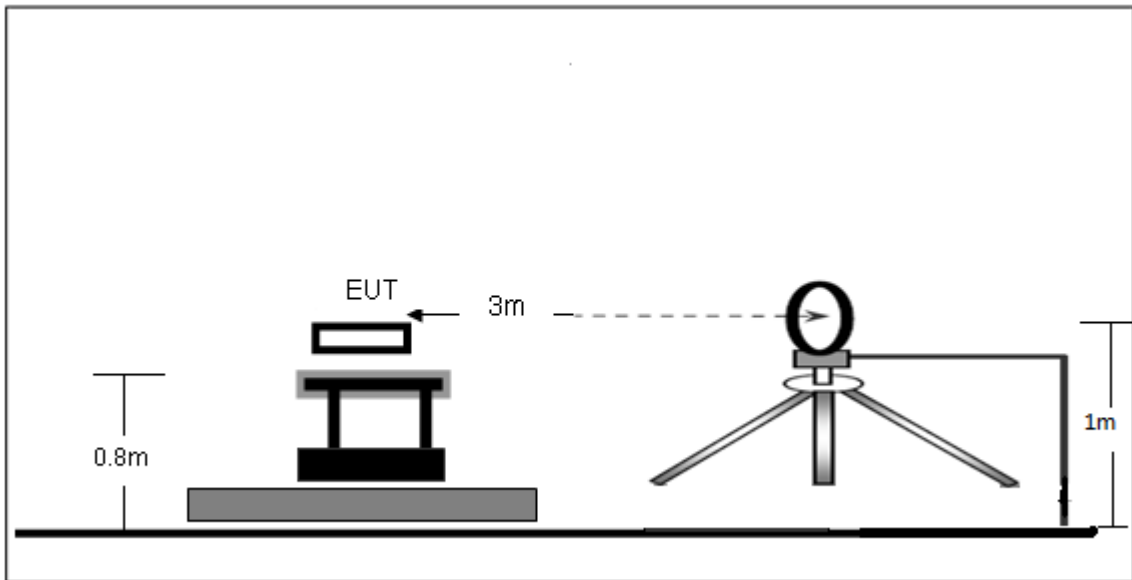

(B) Radiated Emission Test-Up Frequency 30MHz~1GHz

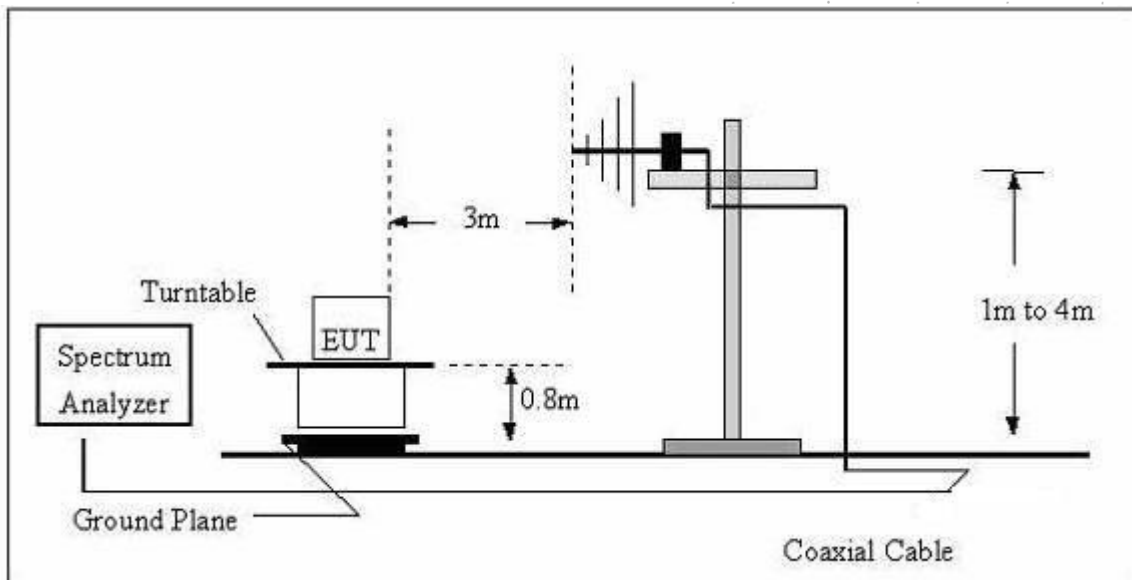

7.2 Limit

FCC §15.209; §15.205.

Test Standard	FCC Part15 C Section 15.209 and 15.205				
Test Limit	Frequency (MHz)	Field strength (microvolt/meter)	Limit (dBuV/m)	Remark	Measurement distance (m)
	0.009MHz~0.490MHz	2400/F(kHz)	-	-	300
	0.490MHz-1.705MHz	24000/F(kHz)	-	-	30
	1.705MHz-30MHz	30	-	-	30
	30MHz~88MHz	100	40.0	Quasi-peak	3
	88MHz~216MHz	150	43.5	Quasi-peak	3
	216MHz~960MHz	200	46.0	Quasi-peak	3
	960MHz~1000MHz	500	54.0	Quasi-peak	3
	Above 1000MHz	500	54.0	Average	3
-		74.0	Peak	3	

7.3 Test procedure

Receiver Parameter	Setting
Attenuation	Auto
9kHz~150kHz	RBW 200Hz for QP
150kHz~30MHz	RBW 9kHz for QP
30MHz~1000MHz	RBW 120kHz for QP

Below 1GHz test procedure as below:

- The EUT was placed on the top of a rotating table 0.8 meters above the ground at a 3 meter semi-anechoic chamber. The table was rotated 360 degrees to determine the position of the highest radiation.
- The EUT was set 3 meters away from the interference-receiving antenna, which was mounted on the top of a variable-height antenna tower.
- The antenna height is varied from one meter to four meters above the ground to determine the maximum value of the field strength. Both horizontal and vertical polarizations of the antenna are set to make the measurement.
- For each suspected emission, the EUT was arranged to its worst case and then the antenna was tuned to heights from 1 meter to 4 meters (for the test frequency of below 30MHz, the antenna was tuned to heights 1 meter) and the rotatable table was turned from 0 degrees to 360 degrees to find the maximum reading.
- The test-receiver system was set to Peak Detect Function and Specified Bandwidth with Maximum Hold Mode.
- If the emission level of the EUT in peak mode was 10dB lower than the limit specified, then testing could be stopped and the peak values of the EUT would be reported. Otherwise the emissions that did not have 10dB margin would be re-tested one by one using peak, quasi-peak or average method as specified and then reported in a data sheet.

Above 1GHz test procedure as below:

- Different between above is the test site, change from Semi- Anechoic Chamber to fully Anechoic Chamber and change form table 0.8 metre to 1.5 metre(Above 18GHz the distance is 1 meter and table is 1.5 metre).
- Test the EUT in the lowest channel ,the middle channel ,the Highest channel.

Note: Both horizontal and vertical antenna polarities were tested and performed pretest to three orthogonal axis. The worst case emissions were reported.

7.4 Test Result

9kHz-30MHz

Temperature:	26°C	Relative Humidity:	54%RH
Pressure:	101 kPa	Test Voltage:	DC 3.7V
Test Mode:	Mode 8	Polarization:	Coaxial(Worst)

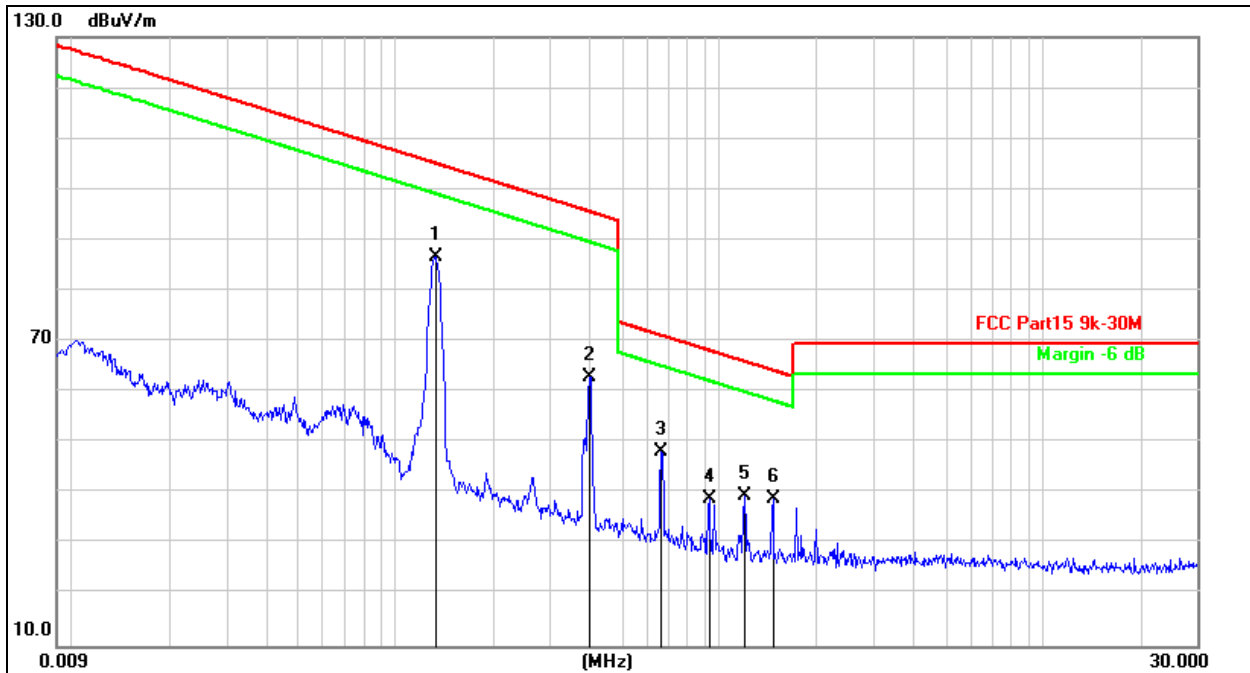

No.	Mk.	Freq. MHz	Reading Level dBuV	Correct Factor dB	Measure- ment dBuV/m	Limit dB/m	Over dB	Detector
1	*	0.1330	94.20	-7.55	86.65	105.13	-18.48	peak
2		0.3976	70.53	-7.64	62.89	95.62	-32.73	peak
3		0.6628	55.61	-7.40	48.21	71.18	-22.97	peak
4		0.9318	46.45	-7.36	39.09	68.23	-29.14	peak
5		1.1982	46.99	-7.35	39.64	66.06	-26.42	peak
6		1.4676	46.17	-7.34	38.83	64.30	-25.47	peak

Temperature:	26°C	Relative Humidity:	54%RH
Pressure:	101 kPa	Test Voltage:	DC 3.7V
Test Mode:	Mode 9	Polarization:	Coaxial(Worst)

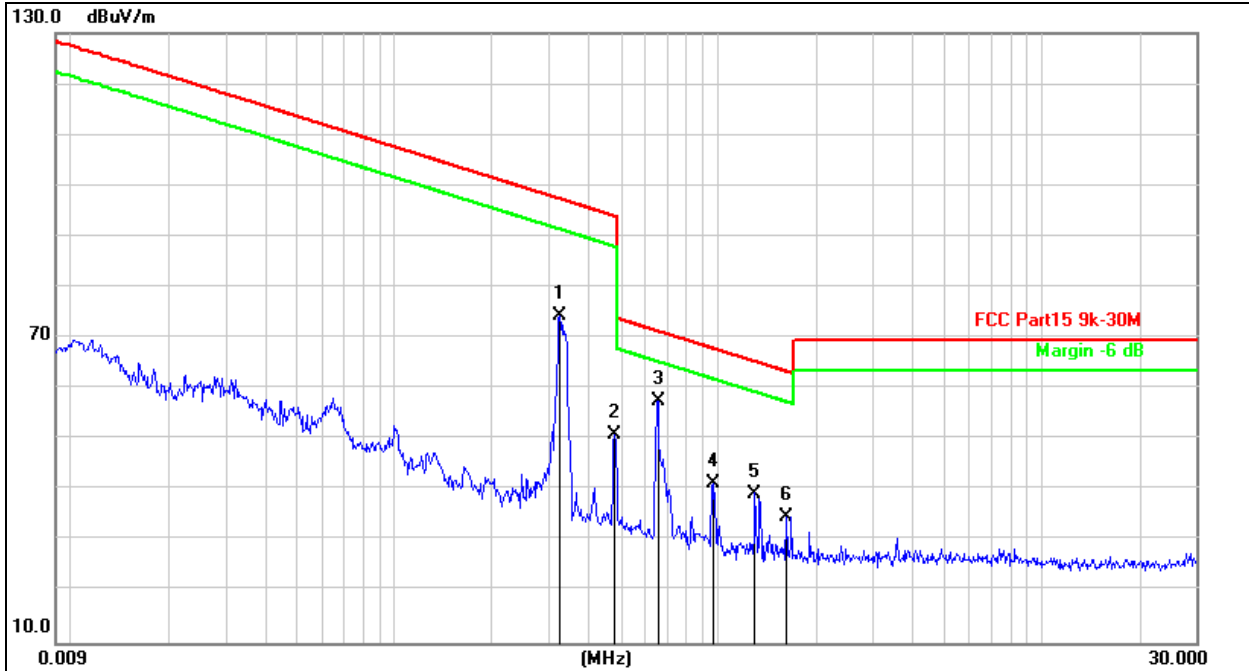

No.	Mk.	Freq. MHz	Reading Level dBuV	Correct Factor dB	Measure- ment dBuV/m	Limit dB/m	Over dB	Detector
1		0.3245	81.91	-7.69	74.22	97.38	-23.16	peak
2		0.4791	58.66	-7.58	51.08	94.00	-42.92	peak
3	*	0.6521	65.08	-7.41	57.67	71.32	-13.65	peak
4		0.9625	48.63	-7.36	41.27	67.95	-26.68	peak
5		1.2994	46.75	-7.35	39.40	65.35	-25.95	peak
6		1.6308	42.00	-7.33	34.67	63.39	-28.72	peak

CO.LTD

Between 30MHz – 1GHz

Temperature:	26 °C	Relative Humidity:	54%RH
Pressure:	101KPa	Phase:	Horizontal
Test Mode:	Mode 1	Test Voltage:	AC 120V/60Hz

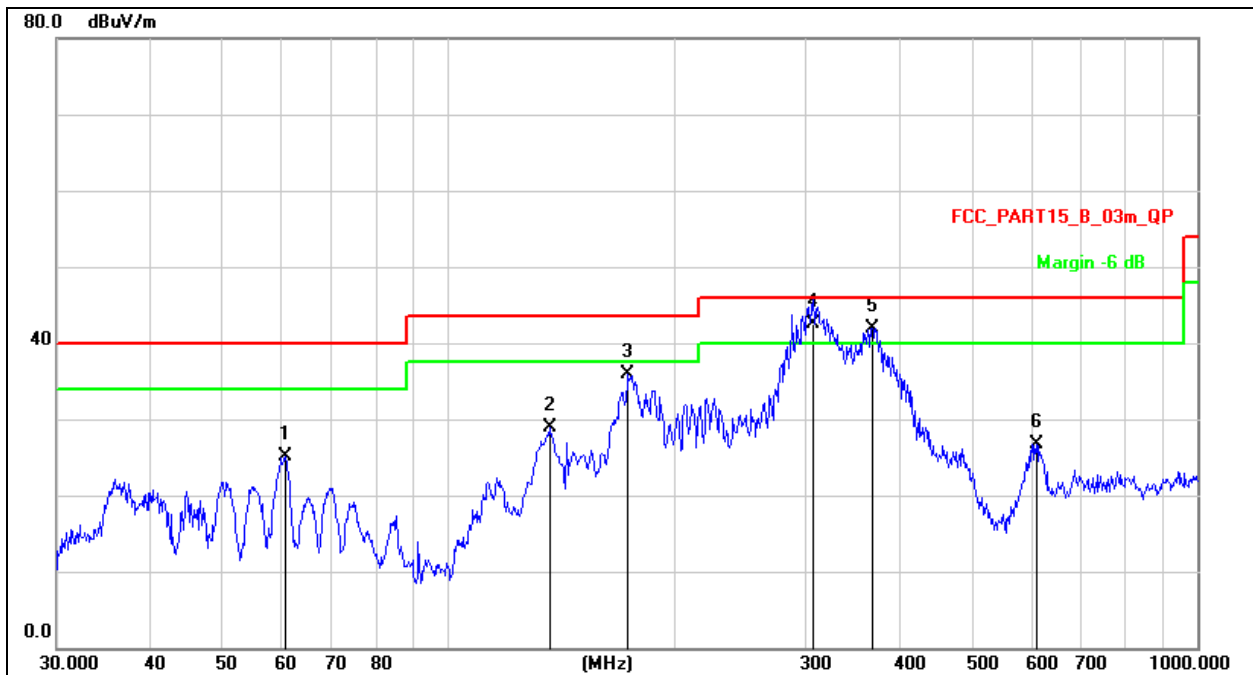

Remark:

1. Factor = Antenna Factor + Cable Loss – Pre-amplifier.
2. Measurement = Reading Level + Correct Factor
3. Over = Measurement - Limit

No.	Mk.	Freq. MHz	Reading Level dBuV	Correct Factor dB	Measure- ment dBuV/m	Limit dB/m	Over dB	Detector
1		60.7044	40.48	-15.44	25.04	40.00	-14.96	QP
2		136.4598	47.34	-18.48	28.86	43.50	-14.64	QP
3		173.8135	53.50	-17.66	35.84	43.50	-7.66	QP
4	*	306.1747	55.51	-13.02	42.49	46.00	-3.51	QP
5	!	368.1116	53.17	-11.25	41.92	46.00	-4.08	QP
6		609.9217	33.57	-6.85	26.72	46.00	-19.28	QP

SHENZHEN

Temperature:	26 °C	Relative Humidity:	54%RH
Pressure:	101KPa	Phase :	Vertical
Test Mode:	Mode 1	Test Voltage:	AC 120V/60Hz

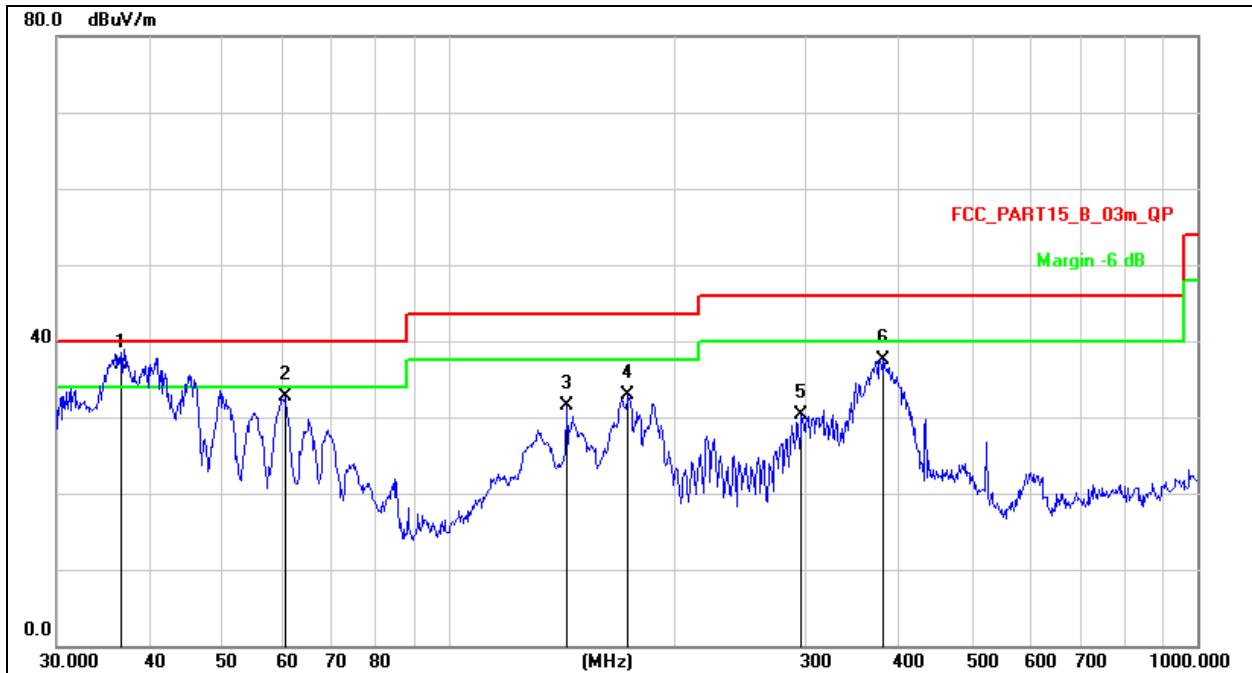

- Remark:
- Factor = Antenna Factor + Cable Loss – Pre-amplifier.
 - Measurement = Reading Level + Correct Factor
 - Over = Measurement - Limit

No.	Mk.	Freq. MHz	Reading Level dBuV	Correct Factor dB	Measure- ment dBuV/m	Limit dB/m	Over dB	Detector
1	*	36.6730	52.31	-15.36	36.95	40.00	-3.05	QP
2		60.4919	48.16	-15.39	32.77	40.00	-7.23	QP
3		143.8295	50.52	-19.00	31.52	43.50	-11.98	QP
4		173.8135	50.51	-17.66	32.85	43.50	-10.65	QP
5		296.1836	43.57	-13.32	30.25	46.00	-15.75	QP
6		381.2487	48.64	-11.08	37.56	46.00	-8.44	QP

Temperature:	26 °C	Relative Humidity:	54%RH
Pressure:	101KPa	Phase :	Horizontal
Test Mode:	Mode 9	Test Voltage:	DC 3.7V

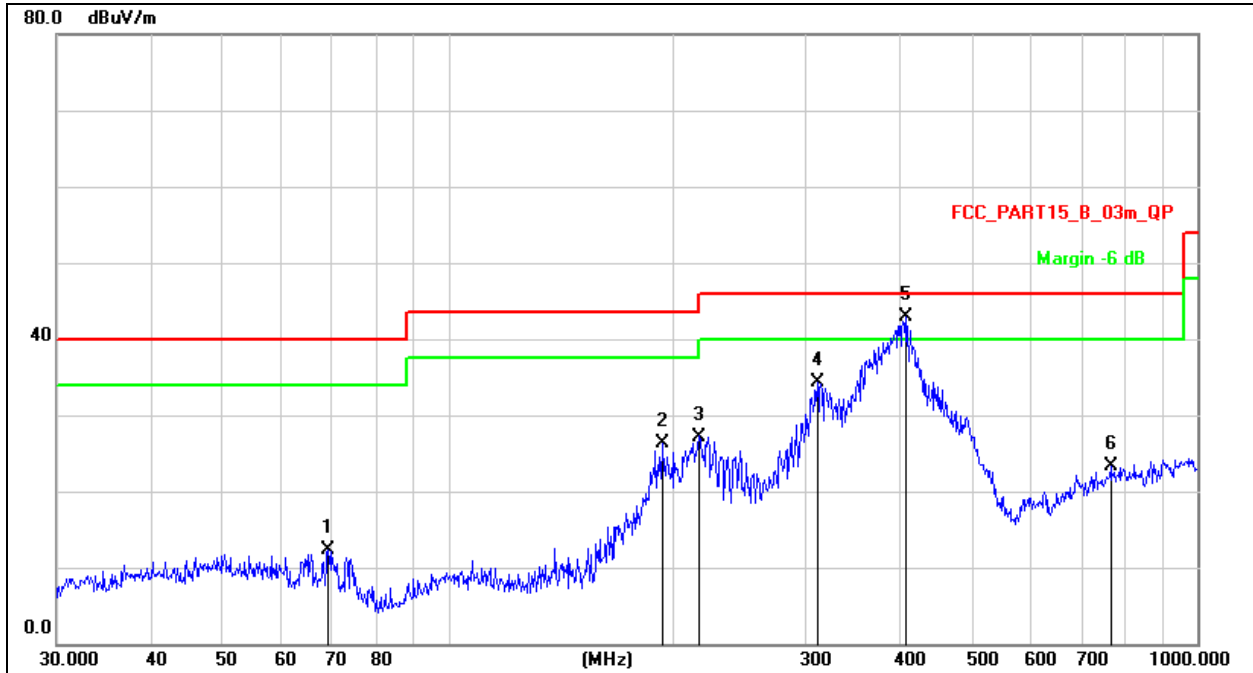

Remark:
 1. Factor = Antenna Factor + Cable Loss – Pre-amplifier.
 2. Measurement = Reading Level + Correct Factor
 3. Over = Measurement - Limit

No.	Mk.	Freq. MHz	Reading Level dBuV	Correct Factor dB	Measure- ment dBuV/m	Limit dB/m	Over dB	Detector
1		69.1141	30.13	-17.76	12.37	40.00	-27.63	QP
2		193.0945	42.54	-16.23	26.31	43.50	-17.19	QP
3		216.0240	42.46	-15.26	27.20	46.00	-18.80	QP
4		311.0867	47.09	-12.85	34.24	46.00	-11.76	QP
5	*	408.9460	53.55	-10.66	42.89	46.00	-3.11	QP
6		766.0571	28.05	-4.80	23.25	46.00	-22.75	QP

Temperature:	26 °C	Relative Humidity:	54%RH
Pressure:	101KPa	Phase :	Vertical
Test Mode:	Mode 9	Test Voltage:	DC 3.7V

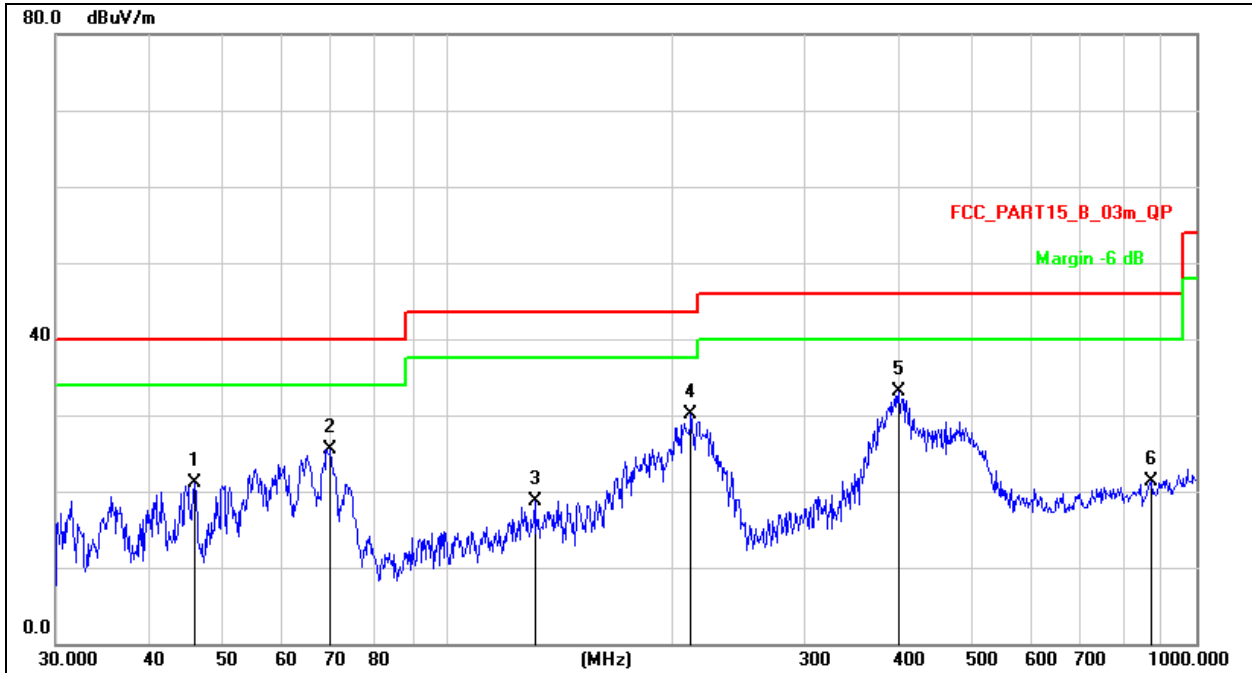

Remark:
 1. Factor = Antenna Factor + Cable Loss – Pre-amplifier.
 2. Measurement = Reading Level + Correct Factor
 3. Over = Measurement - Limit

No.	Mk.	Freq.	Reading Level	Correct Factor	Measurement	Limit	Over	Detector
		MHz	dBuV	dB	dBuV/m	dB/m	dB	
1		46.0162	35.39	-14.23	21.16	40.00	-18.84	QP
2		69.8449	43.39	-17.96	25.43	40.00	-14.57	QP
3		130.8369	36.87	-18.09	18.78	43.50	-24.72	QP
4		211.5264	45.46	-15.39	30.07	43.50	-13.43	QP
5	*	400.4318	43.93	-10.83	33.10	46.00	-12.90	QP
6		872.1832	24.96	-3.60	21.36	46.00	-24.64	QP

8. Bandwidth Test

8.1 Test Procedure

1. Set RBW = 1%~5% OBW.
2. Set the video bandwidth (VBW) $\geq 3 \times$ RBW.
3. Detector = Peak.
4. Trace mode = max hold.
5. Sweep = auto couple.
6. Allow the trace to stabilize.
7. Measure the maximum width of the emission that is constrained by the frequencies associated with the two outermost amplitude points (upper and lower frequencies) that are attenuated by 20 dB relative to the maximum level measured in the fundamental emission.

8.2 Test Setup

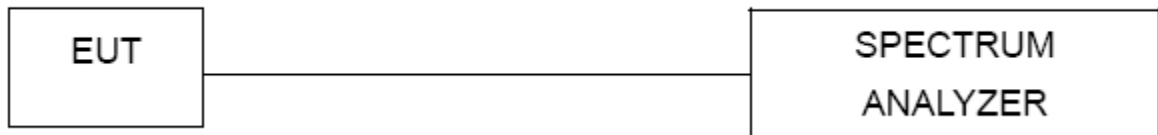

8.3 Test Result

Frequency (kHz)	20dB bandwidth (kHz)	Result
137	0.082	Pass
323.5	0.212	Pass

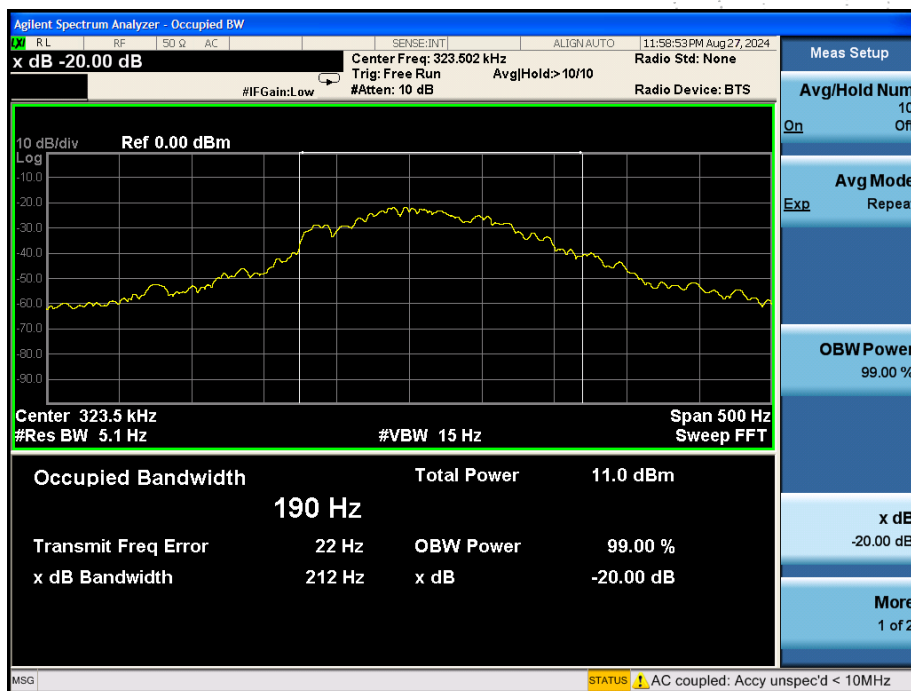
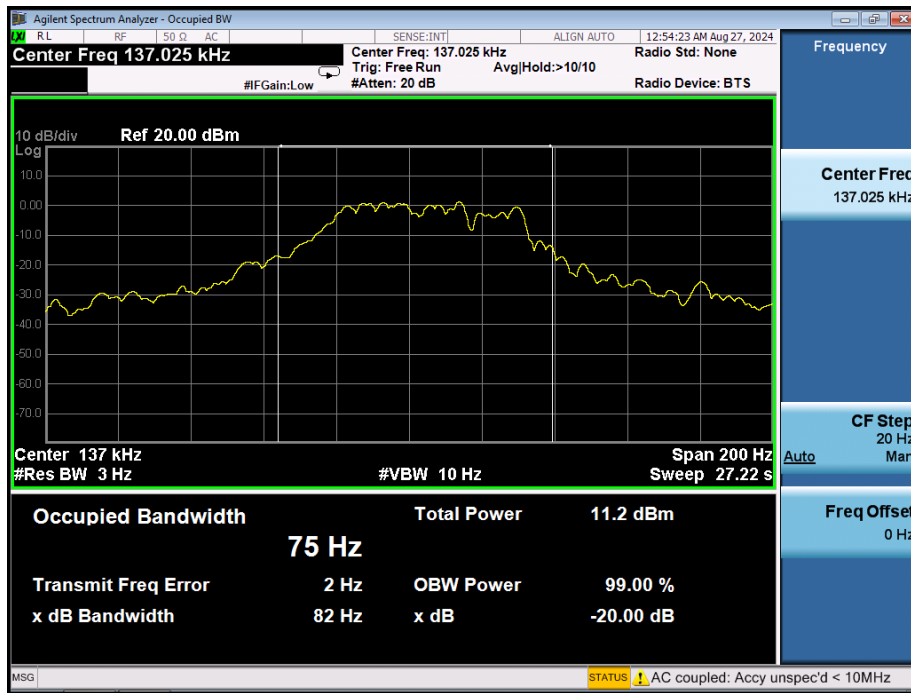

CO.LTD

9. Antenna Requirements

9.1 Limit

For intentional device, according to FCC 47 CFR Section 15.203, An intentional radiator shall be designed to ensure that no antenna other than that furnished by the responsible party shall be used with the device. The use of a permanently attached antenna or of an antenna that uses a unique coupling to the intentional radiator shall be considered sufficient to comply with the provisions of this section. The manufacturer may design the unit so that a broken antenna can be replaced by the user, but the use of a standard antenna jack or electrical connector is prohibited.

9.2 Test Result

The antenna used for this product is Inductive Loop coil antenna.

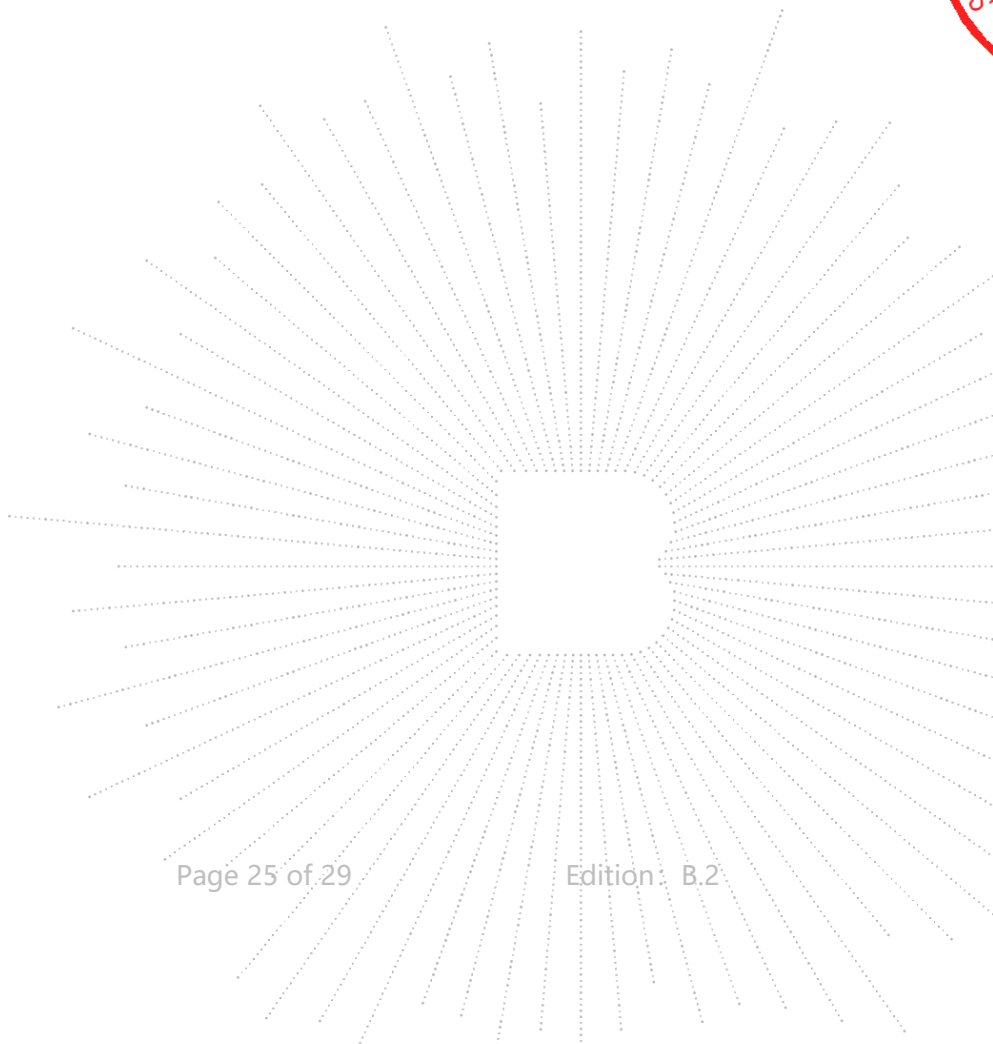

10. EUT Photographs

EUT Photo



NOTE: Appendix-Photographs Of EUT Constructional Details



11. EUT Test Setup Photographs

Conducted emissions



Radiated Measurement Photos

9kHz-30MHz

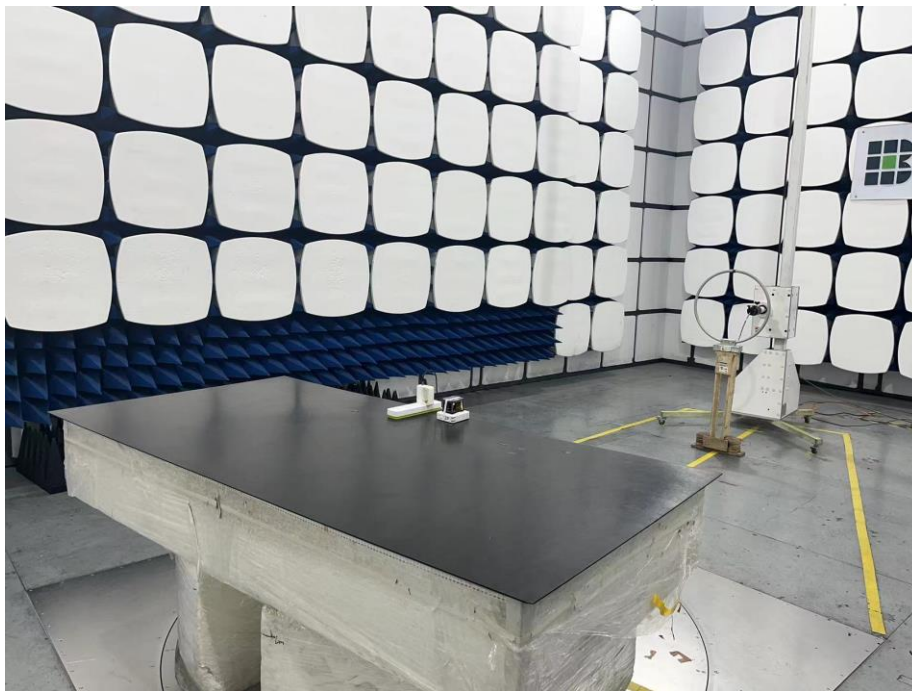

C T
CT
PRO
port S

30MHz-1GHz

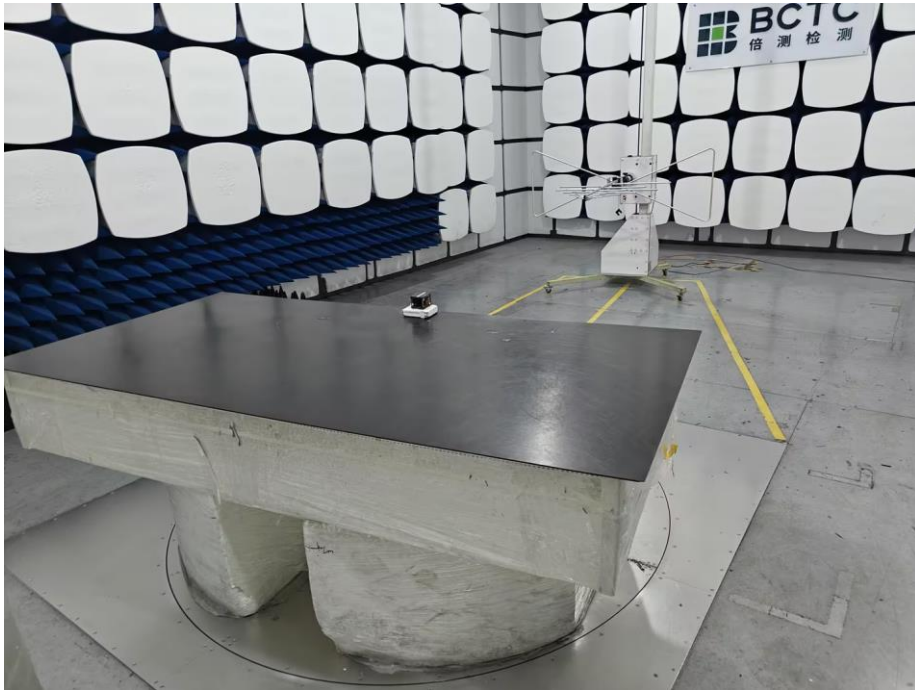

STATEMENT

1. The equipment lists are traceable to the national reference standards.
2. The test report can not be partially copied unless prior written approval is issued from our lab.
3. The test report is invalid without the "special seal for inspection and testing".
4. The test report is invalid without the signature of the approver.
5. The test process and test result is only related to the Unit Under Test.
6. Sample information is provided by the client and the laboratory is not responsible for its authenticity.
7. The quality system of our laboratory is in accordance with ISO/IEC17025.
8. If there is any objection to this test report, the client should inform issuing laboratory within 15 days from the date of receiving test report.

Address:

1-2/F., Building B, Pengzhou Industrial Park, No.158, Fuyuan 1st Road, Zhancheng, Fuhai Subdistrict, Bao'an District, Shenzhen, Guangdong, China

TEL: 400-788-9558

P.C.: 518103

FAX: 0755-33229357

Website: <http://www.chnbctc.com>

Consultation E-mail: bctc@bctc-lab.com.cn

Complaint/Advice E-mail: advice@bctc-lab.com.cn

***** END *****