

Installation Instructions for Ambient Light Accessories

Before installing this product, please connect the module to test whether the red, green, and blue lights on the light strip are functioning properly.

Wiring Diagram for Control Box Connection:

Connect the ACC wire (red) and the small lamp wire (orange) to the positive pole.
Connect the black wire to the negative pole.

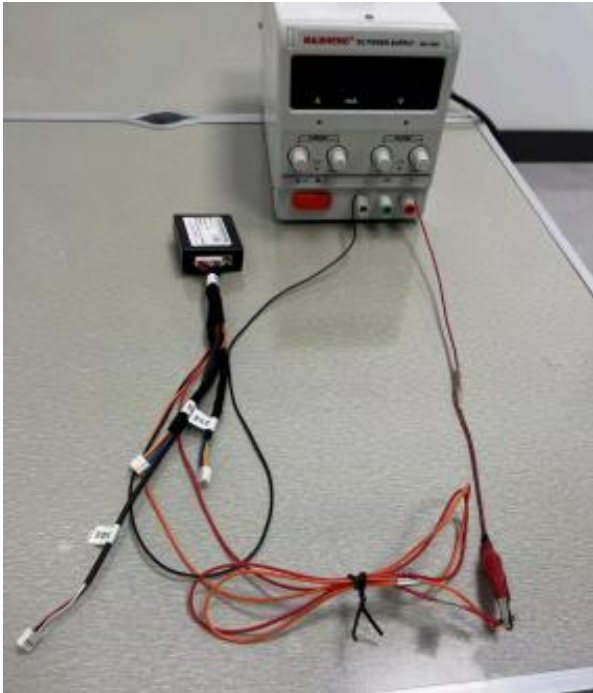



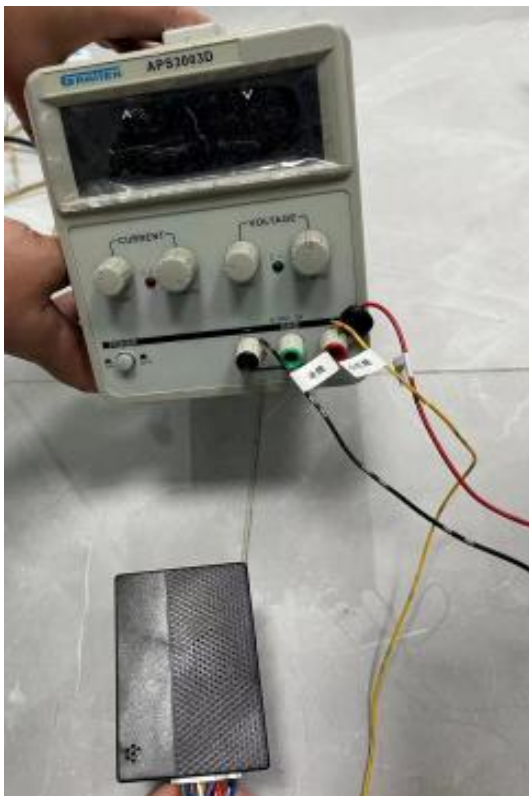

High-Power Control Box Electrical Connection Diagram:

Connect the ACC wire (red) and the small lamp wire (yellow) to the positive terminal.

Connect the black wire to the negative terminal.



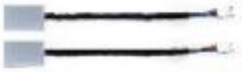

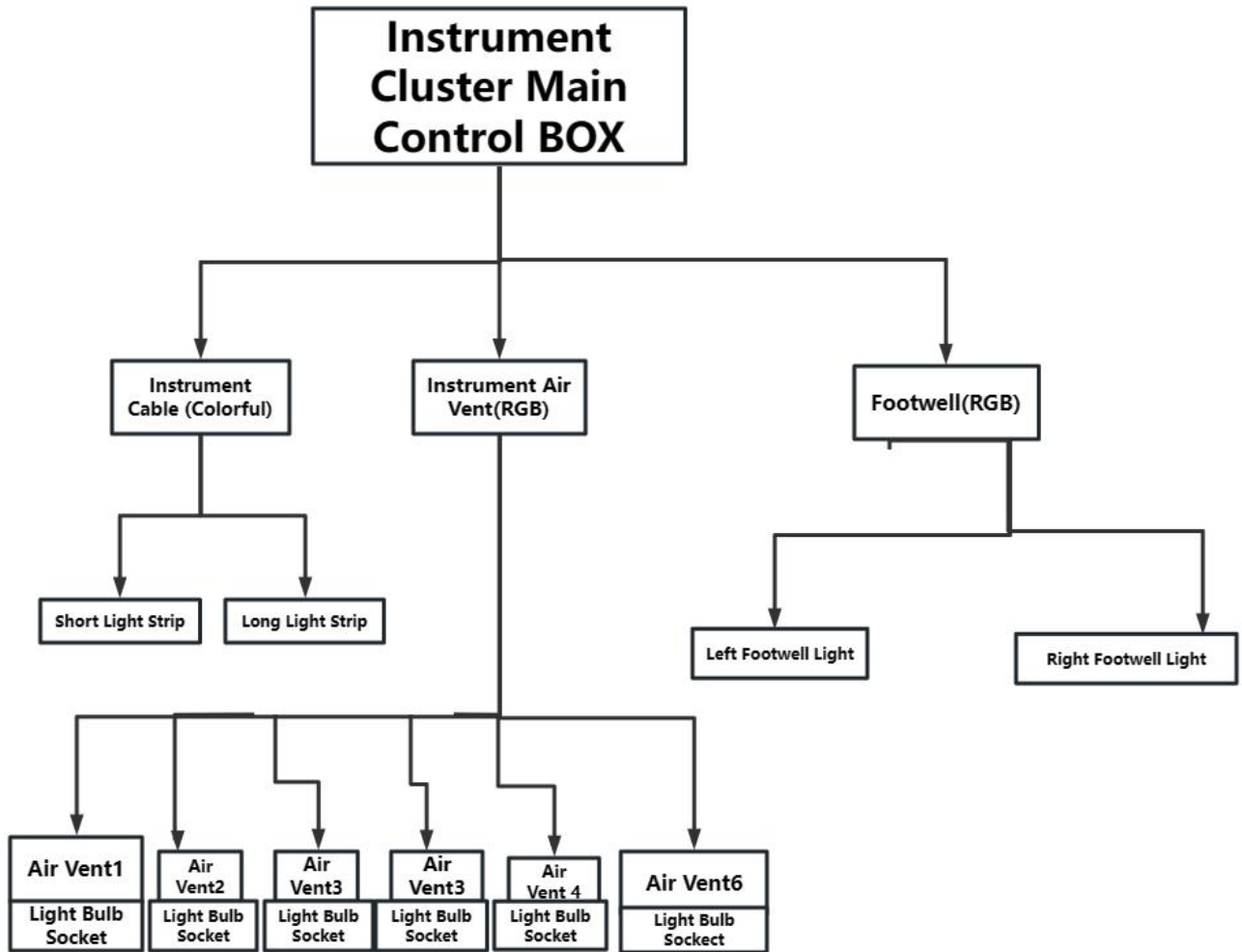

1. Instrument Main Control Box

Instrument Main Control Box				
Assembly Part	Location	Quantity	Unit	Image
Universal Control Box 18P Main Control		1	PCS	
Central Control Area Tube Light	Main Bracket: 30CM Co-Driver: 110CM Reflective Tape Applied on Three Sides with Backside Illumination	2	PCS	
Mercedes Universal Light Bulb Socket	Air Vent Light Socket	6	PCS	
Footwell Light	Universal 5V	2	PCS	
Instrument Cluster Extension Cable	Used for: Footwell Installation	1	PCS	
Colorful Instrument Cluster Extension Cable	Used for: Center Console Colorful Light Strips	1	PCS	
Customized Air Vent Cable	Customized for Specific Use	1	PCS	









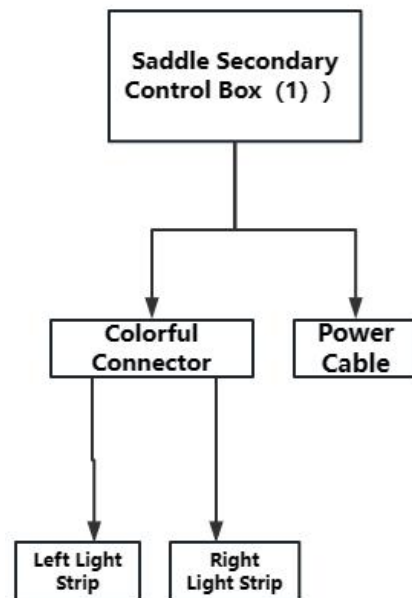
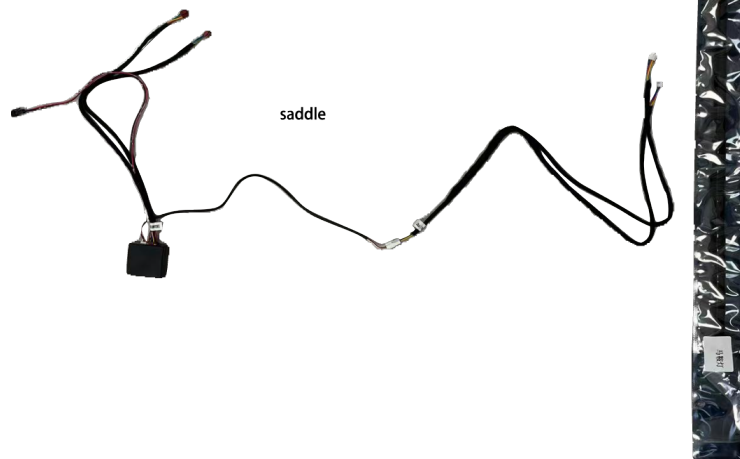

2. Saddle Secondary Control Box

Saddle/Armrest Box					
Universal 10P Secondary Control Box		1	PCS		
Colorful LED Light Strip	75cm Colorful Light Strip	2	PCS		
Colorful Extension Cable		1	PCS		
Universal Colorful Cable		1	PCS		
1 to 2 Split 60cm Extension Cable		1	PCS		









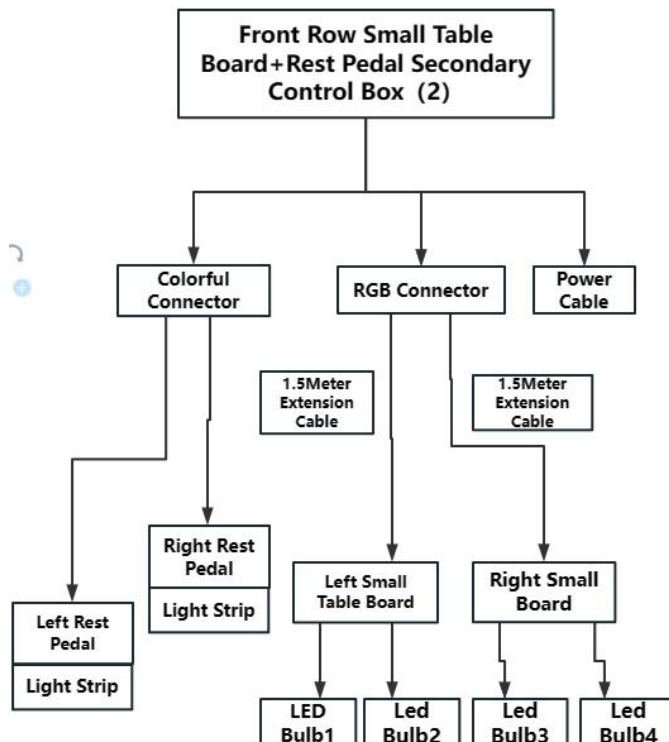
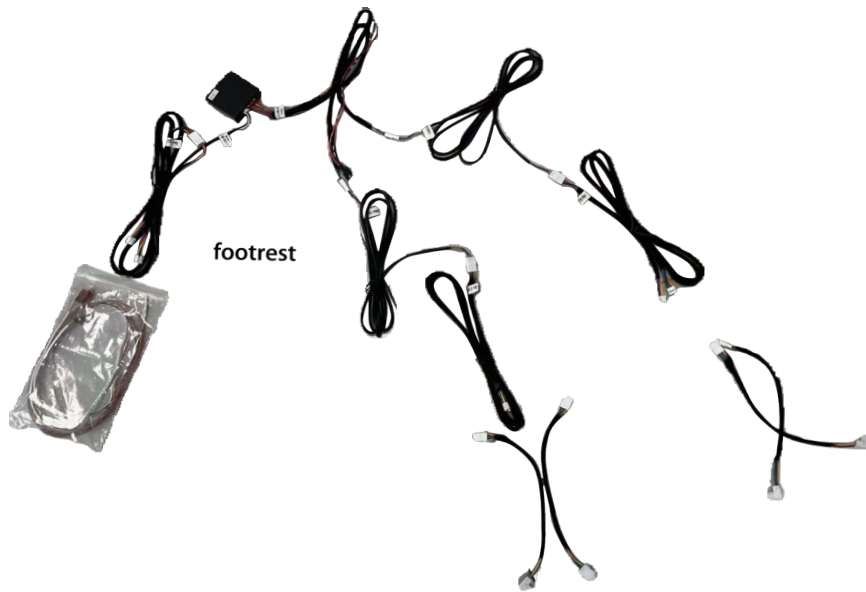



3. Front Seat Backrest + Footrest Secondary Control Box

Front Seat Backrest				
Universal 10P Secondary Control Box		1	PCS	
Universal Door Panel Cable		1	PCS	
1.5 Meter Extension Cable		2	PCS	

Mercedes Universal Light Bulb Socket		4	PCS	
Colorful Light Strip	Colorful Bare Light Strip + Heat Shrink Tubing Size: 90cm	2	PCS	
1 to 2 Split 60cm Extension Cable		3	PCS	
Colorful Extension Cable		1	PCS	









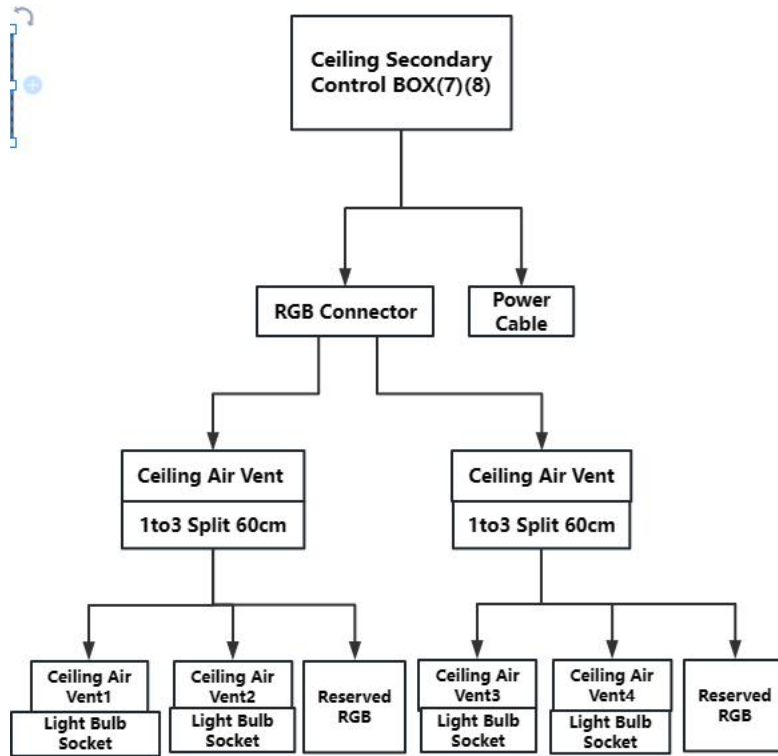

4. Ceiling Secondary Control Box

Ceiling Left				
Universal 10P Secondary Control Box		1	PCS	
Universal Door Panel Cable		1	PCS	
1 to 2 Split 60cm Extension Cable		1	PCS	
1 to 3 Extension Cable		1	PCS	
Mercedes Universal Light Bulb Socket		4	PCS	
Ceiling Right				
Universal 10P Secondary Control Box				
Universal Door Panel Cable		1	PCS	
1 to 2 Split 60cm Extension Cable		1	PCS	
1 to 3 Extension Cable		1	PCS	
Mercedes Universal Light Bulb Socket		4	PCS	



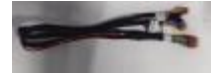

5. Middle Rear Door Secondary Control Box

Middle Door				
Universal 10P Secondary Control Box		2	PCS	
Colorful Outline Light Strip	75cm Colorful Light Strip	2	PCS	
Versatile Universal Door Panel Cable		2	PCS	
Versatile Colorful Four-Door Extension Cable		2	PCS	
Rear Door				
Universal 10P Secondary Control Box		2	PCS	
Colorful Outline Light Strip	75cm Colorful Light Strip	2	PCS	
Versatile Universal Door Panel Cable		2	PCS	
Versatile Colorful Four-Door Extension Cable		2	PCS	

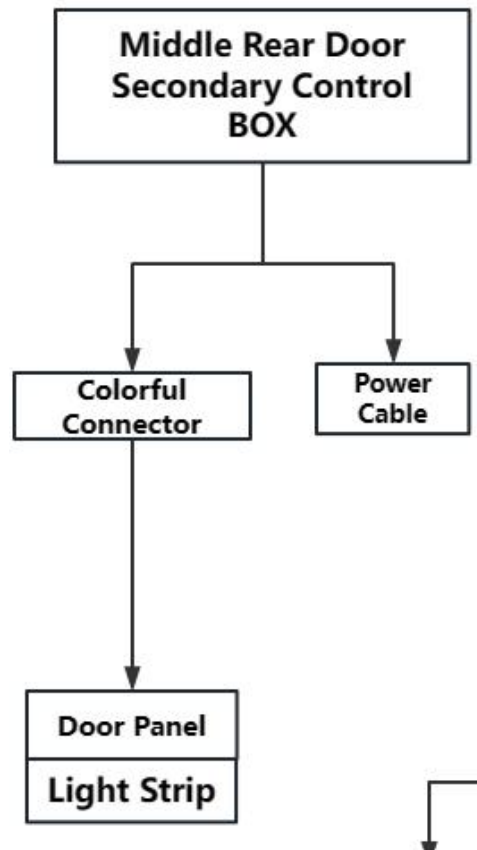
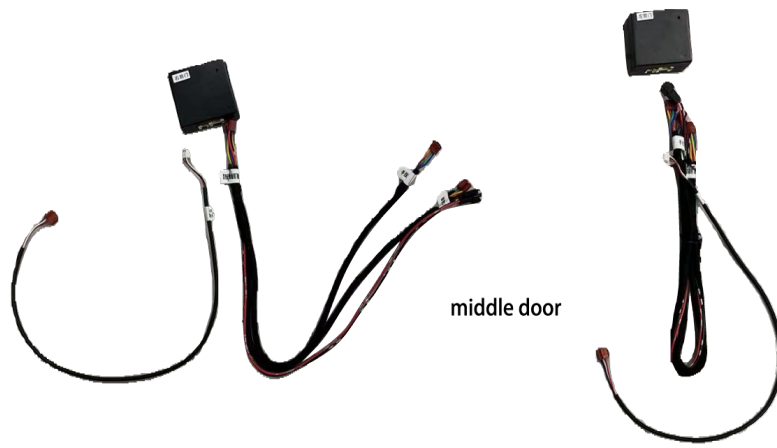

§ 15.19 Labelling requirements.

This device complies with part 15 of the FCC Rules. Operation is subject to the following two conditions:(1) This device may not cause harmful interference, and (2) this device must accept any interference received, including interference that may cause undesired operation.

§ 15.21 Information to user.

Any Changes or modifications not expressly approved by the party responsible for compliance could void the user's authority to operate the equipment.

§ 15.105 Information to the user.

Note: This equipment has been tested and found to comply with the limits for a Class B digital device, pursuant to part 15 of the FCC Rules. These limits are designed to provide reasonable protection against harmful interference in a residential installation. This equipment generates uses and can radiate radio frequency energy and, if not installed and used in accordance with the instructions, may cause harmful interference to radio communications. However, there is no guarantee that interference will not occur in a particular installation. If this equipment does cause harmful interference to radio or television reception, which can be determined by turning the equipment off and on, the user is encouraged to try to correct the interference by one or more of the following measures:

- Reorient or relocate the receiving antenna.
- Increase the separation between the equipment and receiver.
- Connect the equipment into an outlet on a circuit different from that to which the receiver is connected.
- Consult the dealer or an experienced radio/TV technician for help.

*RF warning for Mobile device:

This equipment complies with FCC radiation exposure limits set forth for an uncontrolled environment. This equipment should be installed and operated with minimum distance 20cm between the radiator & your body.