

# V9 Antenna debugging report

Manufacturer	:	CM Global Brands LTD
Address	:	17 Clifton Avenue, Stockton on Tees, United Kingdom
Model No.	:	Sleepbar

# Matching parameters

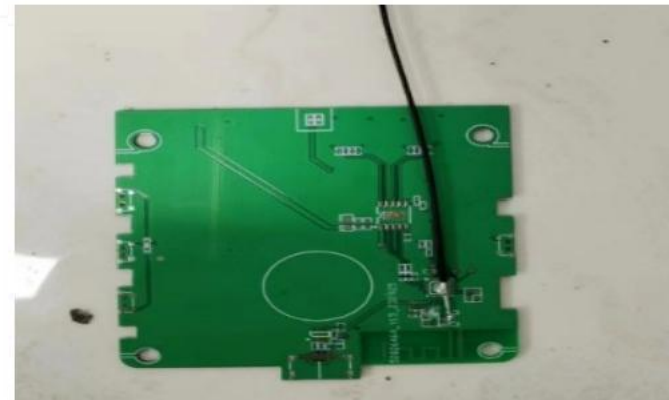
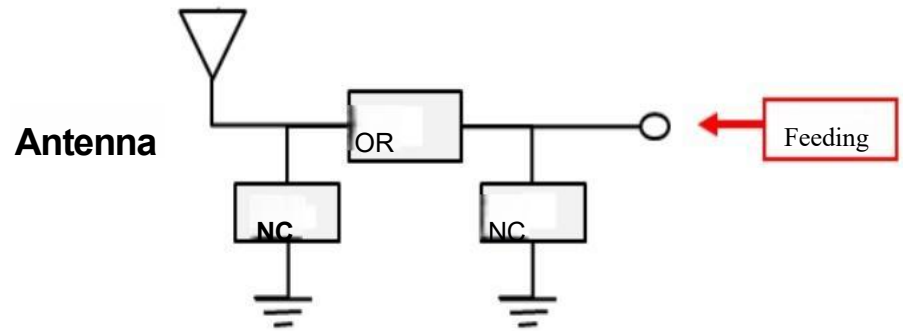
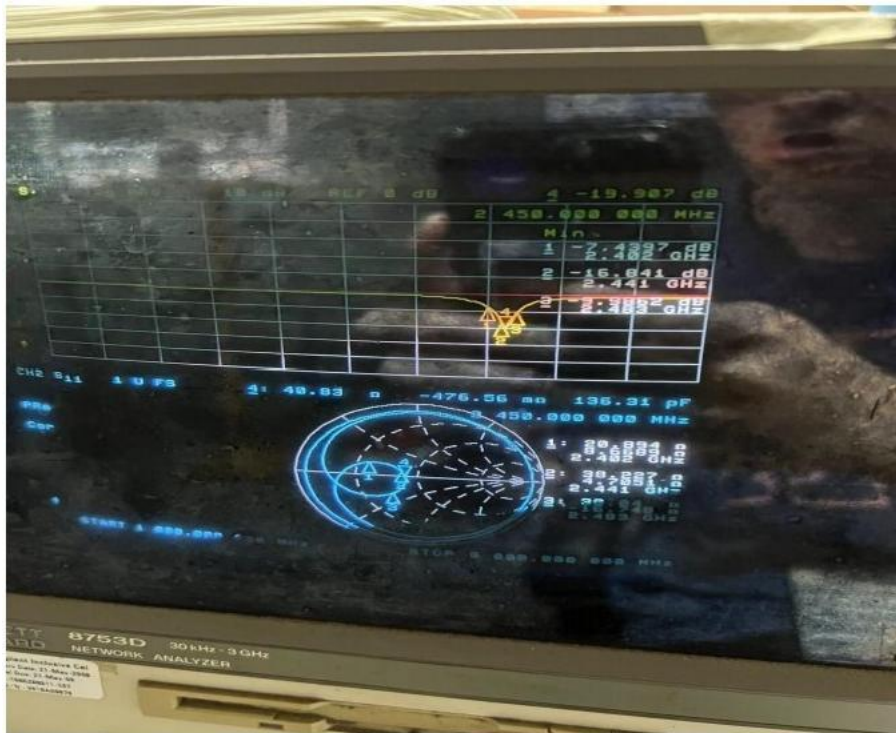

# Antenna efficiency

# 2D 3D field shape diagram

frequency 频率(MHz)	gain 增益(dBi)	gain 增益对应角度	mingain 最小增益	CO Gain 主极化最	CP Gain 交叉极化	efficiency 效率(%)
2400	1.13	$\psi=17, \theta=143$	-14.22	0	0	42.46
2410	1.05	$\psi=16, \theta=143$	-14.47	0	0	43.33
2420	2	$\psi=15, \theta=143$	-13.72	0	0	48.75
2430	2.27	$\psi=15, \theta=144$	-13.6	0	0	49
2440	1.85	$\psi=15, \theta=144$	-14.1	0	0	49
2450	2.38	$\psi=14, \theta=144$	-13.48	0	0	50.47
2460	2.35	$\psi=14, \theta=145$	-13.35	0	0	48.13
2470	1.96	$\psi=14, \theta=145$	-13.55	0	0	46.69
2480	2.13	$\psi=14, \theta=145$	-13.45	0	0	45.28
2490	1.32	$\psi=13, \theta=145$	-14.32	0	0	38.1
2500	1.06	$\psi=13, \theta=145$	-14.59	0	0	36.66

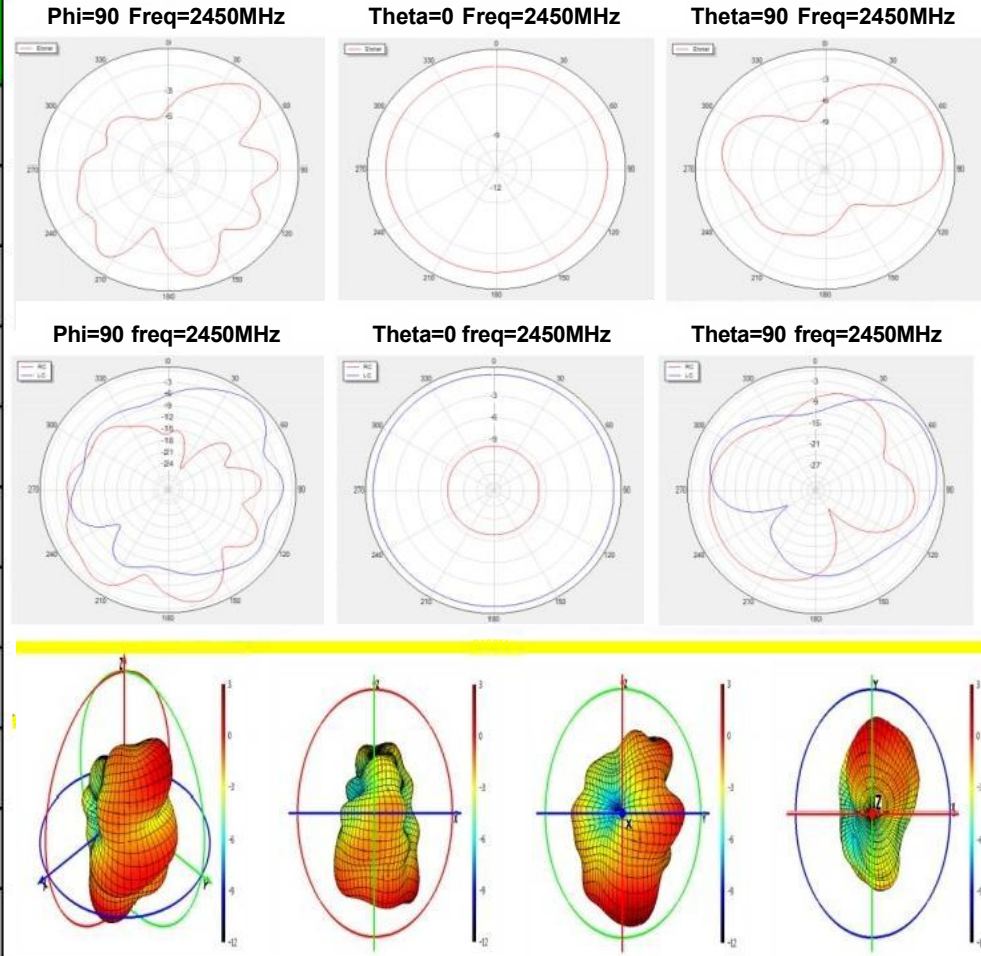

# Test equipment

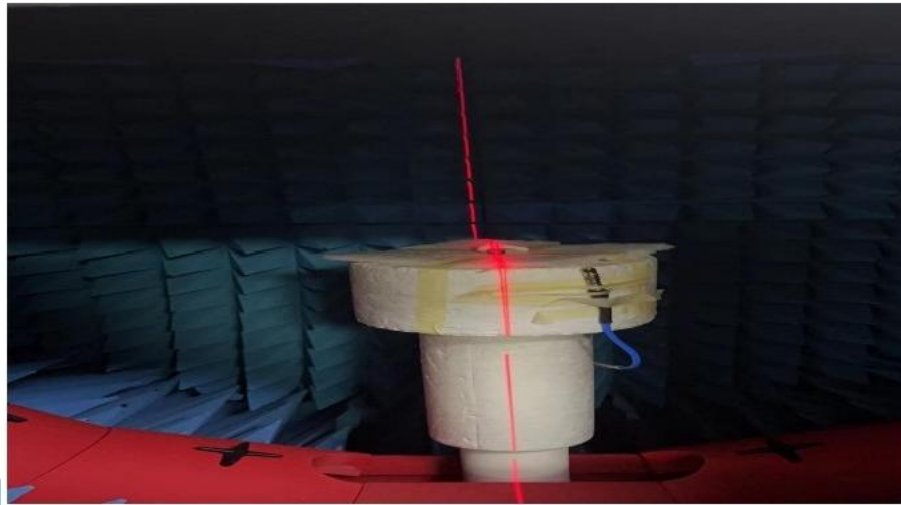
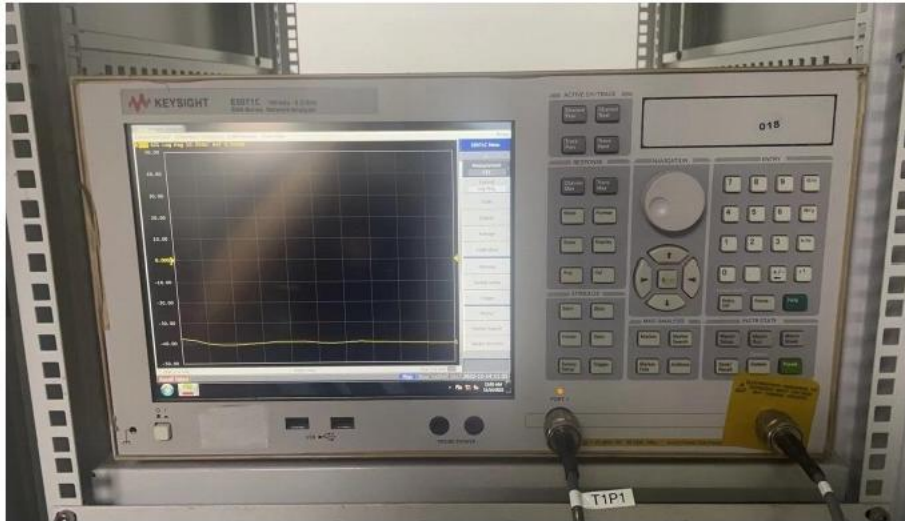

Antenna Photo & Length (mm)

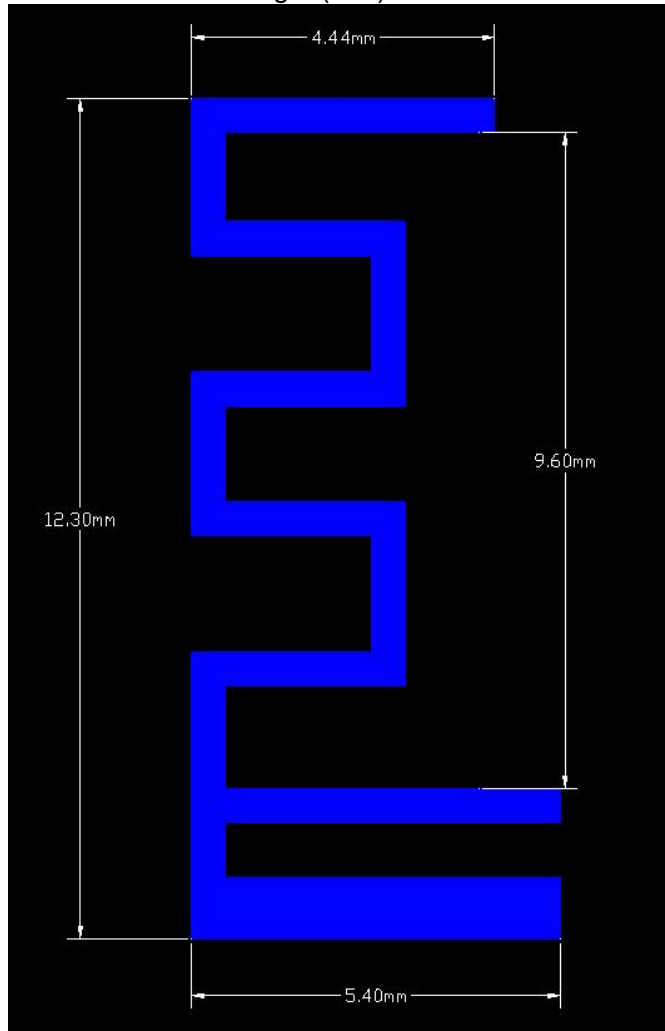

**Thank You**