

**CFR 47 FCC PART 15 SUBPART C
ISED RSS-247 Issue 3**

TEST REPORT

For

Gateway

MODEL NUMBER: SIMATIC FDE Gateway

**FCC ID: 2BC5R-FDEV1
IC: 31363-FDEV1**

REPORT NUMBER: 4790956043-1-RF-2

ISSUE DATE: November 28, 2023

Prepared for

**Siemens Industrial Automation Products Ltd., Chengdu
Tianyuan road 99, Chengdu High Tech Zone West, Chengdu, Sichuan Province,
China**

Prepared by

UL Verification Services (Guangzhou) Co., Ltd, Song Shan Lake Branch

**Building 10, Innovation Technology Park, No. 1, Li Bin Road, Song Shan Lake Hi-
Tech Development Zone Dongguan, 523808, People's Republic of China**

Tel: +86 769 22038881

Fax: +86 769 33244054

Website: www.ul.com

Revision History

Rev.	Issue Date	Revisions	Revised By
V0	November 28, 2023	Initial Issue	

Summary of Test Results

Test Item	Clause	Limit/Requirement	Result
Antenna Requirement	N/A	FCC Part 15.203/15.247 (c) RSS-GEN Clause 6.8	Pass
AC Power Line Conducted Emission	ANSI C63.10-2013, Clause 6.2	FCC Part 15.207 RSS-GEN Clause 8.8	N/A
Conducted Output Power	ANSI C63.10-2013, Clause 11.9.1.3	FCC Part 15.247 (b)(3) RSS-247 Clause 5.4 (d)	Pass
6dB Bandwidth and 99% Occupied Bandwidth	ANSI C63.10-2013, Clause 11.8.1	FCC Part 15.247 (a)(2) RSS-247 Clause 5.2 (a) ISED RSS-Gen Clause 6.7	Pass
Power Spectral Density	ANSI C63.10-2013, Clause 11.10.2	FCC Part 15.247 (e) RSS-247 Clause 5.2 (b)	Pass
Conducted Band edge and spurious emission	ANSI C63.10-2013, Clause 11.11	FCC Part 15.247(d) RSS-247 Clause 5.5	Pass
Radiated Band edge and Spurious Emission	ANSI C63.10-2013, Clause 11.12 & Clause 11.13	FCC Part 15.247 (d) FCC Part 15.205/15.209 RSS-247 Clause 5.5 RSS-GEN Clause 8.9	Pass
Duty Cycle	ANSI C63.10-2013, Clause 11.6	None; for reporting purposes only.	Pass

Note:

1. N/A: In this whole report not applicable.

*This test report is only published to and used by the applicant, and it is not for evidence purpose in China.

*The measurement result for the sample received is <Pass> according to <CFR 47 FCC PART 15 SUBPART C ISED RSS-247 Issue 3> when <Simple Acceptance> decision rule is applied.

CONTENTS

1. ATTESTATION OF TEST RESULTS.....	6
2. TEST METHODOLOGY.....	7
3. FACILITIES AND ACCREDITATION.....	7
4. CALIBRATION AND UNCERTAINTY	8
4.1. <i>MEASURING INSTRUMENT CALIBRATION</i>	<i>8</i>
4.2. <i>MEASUREMENT UNCERTAINTY.....</i>	<i>8</i>
5. EQUIPMENT UNDER TEST	9
5.1. <i>DESCRIPTION OF EUT</i>	<i>9</i>
5.2. <i>CHANNEL LIST</i>	<i>9</i>
5.3. <i>MAXIMUM POWER.....</i>	<i>9</i>
5.4. <i>TEST CHANNEL CONFIGURATION.....</i>	<i>9</i>
5.5. <i>THE WORSE CASE POWER SETTING PARAMETER.....</i>	<i>10</i>
5.6. <i>WORST-CASE CONFIGURATIONS.....</i>	<i>10</i>
5.7. <i>DESCRIPTION OF AVAILABLE ANTENNAS</i>	<i>11</i>
5.8. <i>SUPPORT UNITS FOR SYSTEM TEST.....</i>	<i>12</i>
6. MEASURING EQUIPMENT AND SOFTWARE USED.....	13
7. ANTENNA PORT TEST RESULTS	16
7.1. <i>CONDUCTED OUTPUT POWER.....</i>	<i>16</i>
7.2. <i>6DB BANDWIDTH AND 99% OCCUPIED BANDWIDTH.....</i>	<i>17</i>
7.3. <i>POWER SPECTRAL DENSITY</i>	<i>19</i>
7.4. <i>CONDUCTED BAND EDGE AND SPURIOUS EMISSION.....</i>	<i>21</i>
7.5. <i>DUTY CYCLE.....</i>	<i>23</i>
8. RADIATED TEST RESULTS.....	24
8.1. <i>FOR EXTERNAL ANTENNA DATA</i>	<i>32</i>
8.1.1. <i>RESTRICTED BANDEDGE</i>	<i>32</i>
8.1.2. <i>SPURIOUS EMISSIONS(1 GHz~3 GHz)</i>	<i>45</i>
8.1.3. <i>SPURIOUS EMISSIONS(3 GHz~18 GHz)</i>	<i>51</i>
8.1.4. <i>SPURIOUS EMISSIONS(9 kHz~30 MHz).....</i>	<i>69</i>
8.1.5. <i>SPURIOUS EMISSIONS(18 GHz~26 GHz)</i>	<i>72</i>
8.1.6. <i>SPURIOUS EMISSIONS(30 MHz~1 GHz).....</i>	<i>74</i>
8.2. <i>FOR INTERNAL ANTENNA DATA</i>	<i>76</i>
8.2.1. <i>RESTRICTED BANDEDGE</i>	<i>76</i>
8.2.2. <i>SPURIOUS EMISSIONS(1 GHz~3 GHz)</i>	<i>85</i>
8.2.3. <i>SPURIOUS EMISSIONS(3 GHz~18 GHz)</i>	<i>91</i>
8.2.4. <i>SPURIOUS EMISSIONS(9 kHz~30 MHz).....</i>	<i>109</i>
8.2.5. <i>SPURIOUS EMISSIONS(18 GHz~26 GHz)</i>	<i>112</i>
8.2.6. <i>SPURIOUS EMISSIONS(30 MHz~1 GHz).....</i>	<i>114</i>

9.	ANTENNA REQUIREMENT	116
10.	TEST DATA FOR EXTERNAL ANTENNA	117
10.1.	<i>APPENDIX A1: DTS BANDWIDTH.....</i>	117
10.1.1.	Test Result.....	117
10.1.2.	Test Graphs	118
10.2.	<i>APPENDIX B1: OCCUPIED CHANNEL BANDWIDTH.....</i>	121
10.2.1.	Test Result.....	121
10.2.2.	Test Graphs	122
10.3.	<i>APPENDIX C1: MAXIMUM CONDUCTED OUTPUT POWER.....</i>	125
10.3.1.	Test Result.....	125
10.4.	<i>APPENDIX D1: MAXIMUM POWER SPECTRAL DENSITY.....</i>	126
10.4.1.	Test Result.....	126
10.4.2.	Test Graphs	127
10.5.	<i>APPENDIX E1: BAND EDGE MEASUREMENTS.....</i>	130
10.5.1.	Test Result.....	130
10.5.2.	Test Graphs	131
10.6.	<i>APPENDIX F1: CONDUCTED SPURIOUS EMISSION</i>	133
10.6.1.	Test Result.....	133
10.6.2.	Test Graphs	134
10.7.	<i>APPENDIX G1: DUTY CYCLE.....</i>	142
10.7.1.	Test Result.....	142
10.7.2.	Test Graphs	143
11.	TEST DATA FOR INTERNAL ANTENNA	144
11.1.	<i>APPENDIX A2: DTS BANDWIDTH.....</i>	144
11.1.1.	Test Result.....	144
11.1.2.	Test Graphs	145
11.2.	<i>APPENDIX B2: OCCUPIED CHANNEL BANDWIDTH.....</i>	148
11.2.1.	Test Result.....	148
11.2.2.	Test Graphs	149
11.3.	<i>APPENDIX C2: MAXIMUM CONDUCTED OUTPUT POWER.....</i>	152
11.3.1.	Test Result.....	152
11.4.	<i>APPENDIX D2: MAXIMUM POWER SPECTRAL DENSITY.....</i>	153
11.4.1.	Test Result.....	153
11.4.2.	Test Graphs	154
11.5.	<i>APPENDIX E2: BAND EDGE MEASUREMENTS.....</i>	157
11.5.1.	Test Result.....	157
11.5.2.	Test Graphs	158
11.6.	<i>APPENDIX F2: CONDUCTED SPURIOUS EMISSION</i>	160
11.6.1.	Test Result.....	160
11.6.2.	Test Graphs	161
11.7.	<i>APPENDIX G2: DUTY CYCLE.....</i>	169
11.7.1.	Test Result.....	169
11.7.2.	Test Graphs	170

1. ATTESTATION OF TEST RESULTS

Applicant Information

Company Name: Siemens Industrial Automation Products Ltd., Chengdu
 Address: Tianyuan road 99, Chengdu High Tech Zone West, Chengdu, Sichuan Province, China

Manufacturer Information

Company Name: Siemens Industrial Automation Products Ltd., Chengdu
 Address: Tianyuan road 99, Chengdu High Tech Zone West, Chengdu, Sichuan Province, China

EUT Information

EUT Name: Gateway
 Model: SIMATIC FDE Gateway
 Sample Received Date: September 1, 2023
 Sample Status: Normal
 Sample ID: 6408936
 Date of Tested: September 8, 2023 to November 28, 2023

APPLICABLE STANDARDS	
STANDARD	TEST RESULTS
CFR 47 FCC PART 15 SUBPART C ISED RSS-247 Issue 3	Pass

Prepared By:

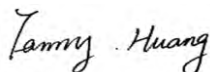

Fanny Huang
 Engineer Project Associate

Checked By:

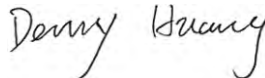

Denny Huang
 Senior Project Engineer

Approved By:



Stephen Guo
 Operations Manager

2. TEST METHODOLOGY

All tests were performed in accordance with the standard CFR 47 FCC PART 15 SUBPART C ISED RSS-247 Issue 3, KDB 558074 D01 15.247 Meas Guidance v05r02, KDB 414788 D01 Radiated Test Site v01r01, CFR 47 FCC Part 2, ANSI C63.10-2013 and ISED RSS-GEN Issue 5

3. FACILITIES AND ACCREDITATION

Accreditation Certificate	<p>A2LA (Certificate No.: 4102.01) UL Verification Services (Guangzhou) Co., Ltd. Song Shan Lake Branch. has been assessed and proved to be in compliance with A2LA.</p> <p>FCC (FCC Designation No.: CN1187) UL Verification Services (Guangzhou) Co., Ltd. Song Shan Lake Branch. Has been recognized to perform compliance testing on equipment subject to the Commission's Declaration of Conformity (DoC) and Certification rules</p> <p>ISED (Company No.: 21320) UL Verification Services (Guangzhou) Co., Ltd. Song Shan Lake Branch. has been registered and fully described in a report filed with ISED. The Company Number is 21320 and the test lab Conformity Assessment Body Identifier (CABID) is CN0046.</p> <p>VCCI (Registration No.: G-20019, R-20004, C-20012 and T-20011) UL Verification Services (Guangzhou) Co., Ltd. Song Shan Lake Branch. has been assessed and proved to be in compliance with VCCI, the Membership No. is 3793. Facility Name: Chamber D, the VCCI registration No. is G-20019 and R-20004 Shielding Room B , the VCCI registration No. is C-20012 and T-20011</p>
---------------------------	-------------------------------------------------------------------------------------------------------------------------------------------------------------------------------------------------------------------------------------------------------------------------------------------------------------------------------------------------------------------------------------------------------------------------------------------------------------------------------------------------------------------------------------------------------------------------------------------------------------------------------------------------------------------------------------------------------------------------------------------------------------------------------------------------------------------------------------------------------------------------------------------------------------------------------------------------------------------------------------------------------------------------------------------------------------------------------------------------------------------------------------------------------------------------

Note 1:

All tests measurement facilities use to collect the measurement data are located at Building 10, Innovation Technology Park, No. 1, Li Bin Road, Song Shan Lake Hi-Tech Development Zone Dongguan, 523808, People's Republic of China.

Note 2:

The test anechoic chamber in UL Verification Services (Guangzhou) Co., Ltd. Song Shan Lake Branch had been calibrated and compared to the open field sites and the test anechoic chamber is shown to be equivalent to or worst case from the open field site.

Note 3:

For below 30 MHz, lab had performed measurements at test anechoic chamber and comparing to measurements obtained on an open field site. And these measurements below 30 MHz had been correlated to measurements performed on an OFS.

4. CALIBRATION AND UNCERTAINTY

4.1. MEASURING INSTRUMENT CALIBRATION

The measuring equipment utilized to perform the tests documented in this report has been calibrated in accordance with the manufacturer's recommendations and is traceable to recognized national standards.

4.2. MEASUREMENT UNCERTAINTY

Where relevant, the following measurement uncertainty levels have been estimated for tests performed on the apparatus:

Test Item	Uncertainty
Conduction emission	3.62 dB
Radiated Emission (Included Fundamental Emission) (9 kHz ~ 30 MHz)	2.2 dB
Radiated Emission (Included Fundamental Emission) (30 MHz ~ 1 GHz)	4.00 dB
Radiated Emission (Included Fundamental Emission) (1 GHz to 26 GHz)	5.78 dB (1 GHz ~ 18 GHz)
	5.23 dB (18 GHz ~ 26 GHz)
Duty Cycle	±0.028%
DTS and 99% Occupied Bandwidth	±0.0196%
Maximum Conducted Output Power	±0.686 dB
Maximum Power Spectral Density Level	±0.743 dB
Conducted Band-edge Compliance	±1.328 dB
Conducted Unwanted Emissions In Non-restricted Frequency Bands	±0.746 dB (9 kHz ~ 1 GHz)
	±1.328dB (1 GHz ~ 26 GHz)
Note: This uncertainty represents an expanded uncertainty expressed at approximately the 95% confidence level using a coverage factor of k=2.	

5. EQUIPMENT UNDER TEST

5.1. DESCRIPTION OF EUT

EUT Name	Gateway
Model	SIMATIC FDE Gateway
Frequency Range:	2412 MHz to 2462 MHz
Type of Modulation:	IEEE 802.11b: DSSS(CCK, DQPSK, DBPSK) IEEE 802.11g/n: OFDM(64-QAM, 16-QAM, QPSK, BPSK)
Radio Technology:	IEEE 802.11b/g/n HT20
Normal Test Voltage:	DC 12 V/ DC 24 V

Note: We have pre-tested two power supplies, only the worst data DC 12 V usage was recorded in the report.

5.2. CHANNEL LIST

Channel List For Bandwidth=20 MHz							
Channel	Frequency (MHz)	Channel	Frequency (MHz)	Channel	Frequency (MHz)	Channel	Frequency (MHz)
1	2412	4	2427	7	2442	10	2457
2	2417	5	2432	8	2447	11	2462
3	2422	6	2437	9	2452	/	/

5.3. MAXIMUM POWER

IEEE Std. 802.11	Frequency (MHz)	Channel Number	Maximum Conducted AVG Output Power (dBm)
b	2412 ~ 2462	1-11[11]	14.12
g	2412 ~ 2462	1-11[11]	9.16
n HT20	2412 ~ 2462	1-11[11]	8.10

5.4. TEST CHANNEL CONFIGURATION

IEEE Std. 802.11	Test Channel Number	Frequency
b	CH 1(Low Channel), CH 6(MID Channel), CH 11(High Channel)	2412 MHz, 2437 MHz, 2462 MHz
g	CH 1(Low Channel), CH 6(MID Channel), CH 11(High Channel)	2412 MHz, 2437 MHz, 2462 MHz
n HT20	CH 1(Low Channel), CH 6(MID Channel), CH 11(High Channel)	2412 MHz, 2437 MHz, 2462 MHz

5.5. THE WORSE CASE POWER SETTING PARAMETER

The Worse Case Power Setting Parameter under 2400 ~ 2483.5MHz Band							
Test Software		Radio Tool					
Modulation Mode	Transmit Antenna Number	Test Channel					
		NCB: 20MHz			NCB: 40MHz		
		CH 1	CH 6	CH 11	CH 3	CH 6	CH 9
802.11b	1	0	0	0	/		
802.11g	1	0	4	4			
802.11n HT20	1	0	4	4			

5.6. WORST-CASE CONFIGURATIONS

The EUT was tested in the following configuration(s):

Controlled in test mode using a software application on the EUT supplied by customer. The application was used to enable a continuous transmission and to select the mode, test channels, bandwidth, data rates as required.

Test channels referring to section 5.4.

Maximum power setting referring to section 5.5.

Worst-case data rates as provided by the client were:

802.11b mode: 1 Mbps

802.11g mode: 6 Mbps

802.11n HT20 mode: MCS0

The measured additional path loss was included in any path loss calculations for all RF cable used during tested.

The product supports internal and external antennas but does not support MIMO mode.

5.7. DESCRIPTION OF AVAILABLE ANTENNAS

Internal Antenna			
Antenna	Frequency (MHz)	Antenna Type	MAX Antenna Gain (dBi)
1	2412-2462	LTCC Antenna	2.1

External Antenna					
Antenna	Frequency (MHz)	Antenna Type	MAX Antenna Gain (dBi)	Cable loss	Final Gain
2	2412-2462	Vertical monopole omni-Antenna	2	-0.53	1.47

Test Mode	Transmit and Receive Mode	Description
IEEE 802.11b	<input checked="" type="checkbox"/> 1TX, 1RX	Antenna 1, 2 can be used as transmitting/receiving antenna.
IEEE 802.11g	<input checked="" type="checkbox"/> 1TX, 1RX	Antenna 1, 2 can be used as transmitting/receiving antenna.
IEEE 802.11n HT20	<input checked="" type="checkbox"/> 1TX, 1RX	Antenna 1, 2 can be used as transmitting/receiving antenna.

Note: The product supports internal and external antennas but does not support MIMO mode.

5.8. SUPPORT UNITS FOR SYSTEM TEST

SUPPORT EQUIPMENT

Item	Equipment	Brand Name	Model Name	Remarks
1	Laptop	Lenovo	E42-80	R303U5AG
2	UART	/	/	/
3	RJ45 dummy load	/	/	/
4	DC Power Supply	ZHAOXIN	PS-305D	/

I/O CABLES

Cable No	Port	Connector Type	Cable Type	Cable Length(m)	Remarks
1	USB	/	/	1.0	/

ACCESSORIES

Item	Accessory	Brand Name	Model Name	Description
/	/	/	/	/

TEST SETUP

The EUT can work in engineering mode with a software through a Laptop.

SETUP DIAGRAM FOR TESTS

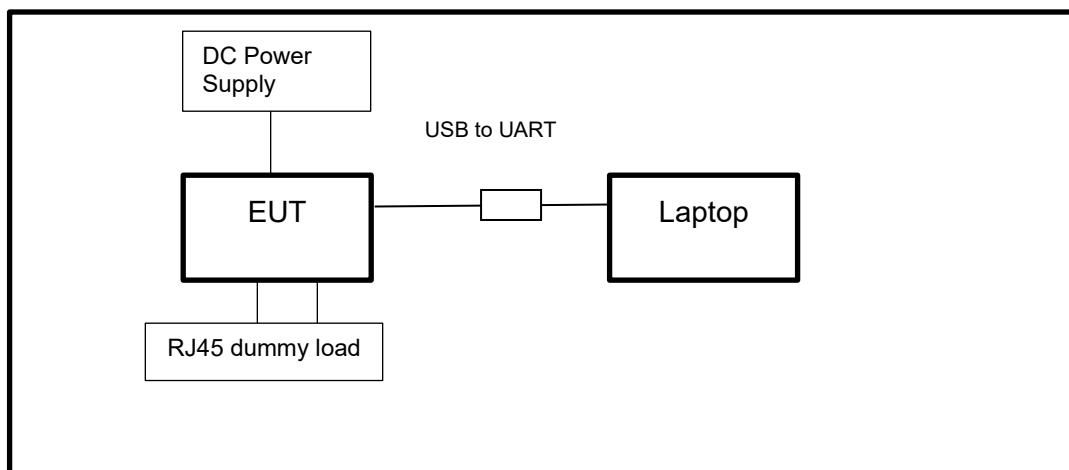

6. MEASURING EQUIPMENT AND SOFTWARE USED

R&S TS 8997 Test System						
Equipment	Manufacturer	Model No.	Serial No.	Upper Last Cal.	Last Cal.	Due. Date
Power sensor, Power Meter	R&S	OSP120	100921	/	Mar.31, 2023	Mar.30, 2024
Vector Signal Generator	R&S	SMBV100A	261637	Oct.17, 2022	Oct.12, 2023	Oct.11, 2024
Signal Generator	R&S	SMB100A	178553	Oct.17, 2022	Oct.12, 2023	Oct.11, 2024
Signal Analyzer	R&S	FSV40	101118	Oct.17, 2022	Oct.12, 2023	Oct.11, 2024
Software						
Description	Manufacturer	Name	Version			
For R&S TS 8997 Test System	Rohde & Schwarz	EMC 32	10.60.10			
Tonsend RF Test System						
Equipment	Manufacturer	Model No.	Serial No.	Upper Last Cal.	Last Cal.	Due. Date
Wideband Radio Communication Tester	R&S	CMW500	155523	Oct.17, 2022	Oct.12, 2023	Oct.11, 2024
Wireless Connectivity Tester	R&S	CMW270	1201.0002N75-102	Sep.28, 2022	Sep.27, 2023	Sep.26, 2024
PXA Signal Analyzer	Keysight	N9030A	MY55410512	Oct.17, 2022	Oct.12, 2023	Oct.11, 2024
MXG Vector Signal Generator	Keysight	N5182B	MY56200284	Oct.17, 2022	Oct.12, 2023	Oct.11, 2024
MXG Vector Signal Generator	Keysight	N5172B	MY56200301	Oct.17, 2022	Oct.12, 2023	Oct.11, 2024
DC power supply	Keysight	E3642A	MY55159130	Oct.17, 2022	Oct.12, 2023	Oct.11, 2024
Temperature & Humidity Chamber	SANMOOD	SG-80-CC-2	2088	Oct.17, 2022	Oct.12, 2023	Oct.11, 2024
Attenuator	Aglient	8495B	2814a12853	Oct.18, 2022	Oct.12, 2023	Oct.11, 2024
RF Control Unit	Tonscend	JS0806-2	23B80620666	/	April 18,2023	April 17,2024
Software						
Description	Manufacturer	Name	Version			
Tonsend SRD Test System	Tonsend	JS1120-3 RF Test System	V3.2.22			

Conducted Emissions						
Equipment	Manufacturer	Model No.	Serial No.	Upper Last Cal.	Last Cal.	Due. Date
EMI Test Receiver	R&S	ESR3	101961	Oct.17, 2022	Oct.13, 2023	Oct.12, 2024
Two-Line V-Network	R&S	ENV216	101983	Oct.17, 2022	Oct.13, 2023	Oct.12, 2024
Artificial Mains Networks	Schwarzbeck	NSLK 8126	8126465	Oct.17, 2022	Oct.13, 2023	Oct.12, 2024
Software						
Description			Manufacturer	Name	Version	
Test Software for Conducted Emissions			Farad	EZ-EMC	Ver. UL-3A1	

Radiated Emissions						
Equipment	Manufacturer	Model No.	Serial No.	Upper Last Cal.	Last Cal.	Due. Date
MXE EMI Receiver	KESIGHT	N9038A	MY56400036	Oct.17, 2022	Oct.12, 2023	Oct.11, 2024
Hybrid Log Periodic Antenna	TDK	HLP-3003C	130959	/	Aug.02, 2021	Aug.01, 2024
Preamplifier	HP	8447D	2944A09099	Oct.17, 2022	Oct.12, 2023	Oct.11, 2024
EMI Measurement Receiver	R&S	ESR26	101377	Oct.17, 2022	Oct.12, 2023	Oct.11, 2024
Horn Antenna	TDK	HRN-0118	130940	/	July 20, 2021	July 19, 2024
Preamplifier	TDK	PA-02-0118	TRS-305-00067	Oct.17, 2022	Oct.12, 2023	Oct.11, 2024
Horn Antenna	Schwarzbeck	BBHA9170	697	/	July 20, 2021	July 19, 2024
Preamplifier	TDK	PA-02-2	TRS-307-00003	Oct.17, 2022	Oct.12, 2023	Oct.11, 2024
Preamplifier	TDK	PA-02-3	TRS-308-00002	Oct.17, 2022	Oct.12, 2023	Oct.11, 2024
Loop antenna	Schwarzbeck	1519B	00008	/	Dec.14, 2021	Dec.13, 2024
Preamplifier	TDK	PA-02-001-3000	TRS-302-00050	Oct.17, 2022	Oct.12, 2023	Oct.11, 2024
Preamplifier	Mini-Circuits	ZX60-83LN-S+	SUP01202035	Oct.17, 2022	Oct.12, 2023	Oct.11, 2024
High Pass Filter	Wi	WHKX10-2700-3000-18000-40SS	23	/	Dec.01,2022	Nov.30,2023
Highpass Filter	Wainwright	WHKX10-5850-6500-1800-40SS	4	/	Dec.01,2022	Nov.30,2023

Band Reject Filter	Wainwright	WRCJV12-5695-5725-5850-5880-40SS	4	/	Dec.01,2022	Nov.30,2023
Band Reject Filter	Wainwright	WRCJV20-5120-5150-5350-5380-60SS	2	/	Dec.01,2022	Nov.30,2023
Band Reject Filter	Wainwright	WRCJV20-5440-5470-5725-5755-60SS	1	/	Dec.01,2022	Nov.30,2023
Band Reject Filter	Wainwright	WRCJV8-2350-2400-2483.5-2533.5-40SS	4	/	Dec.01,2022	Nov.30,2023
Band Reject Filter	Wainwright	WRCD5-1879-1879.85-1880.15-1881-40SS	1	/	Dec.01,2022	Nov.30,2023
Notch Filter	Wainwright	WHJ10-882-980-7000-40SS	1	/	Dec.01,2022	Nov.30,2023
Software						
Description			Manufacturer	Name	Version	
Test Software for Radiated Emissions			Farad	EZ-EMC	Ver. UL-3A1	

Other Instrument						
Equipment	Manufacturer	Model No.	Serial No.	Upper Last Cal.	Last Cal.	Due. Date
Temperature humidity probe	OMEGA	ITHX-SD-5	18470007	Oct.22, 2022	Oct.19, 2023	Oct.18, 2024
Barometer	Yiyi	Baro	N/A	Oct.24, 2022	Oct.19, 2023	Oct.18, 2024
Attenuator	Agilent	8495B	2814a12853	Oct.18, 2022	Oct.12, 2023	Oct.11, 2024

7. ANTENNA PORT TEST RESULTS

7.1. CONDUCTED OUTPUT POWER

LIMITS

CFR 47 FCC Part15 (15.247) Subpart C ISED RSS-247 ISSUE 3			
Section	Test Item	Limit	Frequency Range (MHz)
CFR 47 FCC 15.247(b)(3) ISED RSS-247 5.4 (d)	AVG Output Power	1 watt or 30 dBm	2400-2483.5

TEST PROCEDURE

Refer to ANSI C63.10-2013 clause 11.9.2.3.1.

Connect the EUT to a low loss RF cable from the antenna port to the power sensor (video bandwidth is greater than the occupied bandwidth).

Measure peak emission level, the indicated level is the average output power, after any corrections for external attenuators and cables.

The test result in dBm by adding $[10 \log (1 / D)]$, where D is the duty cycle.

TEST SETUP

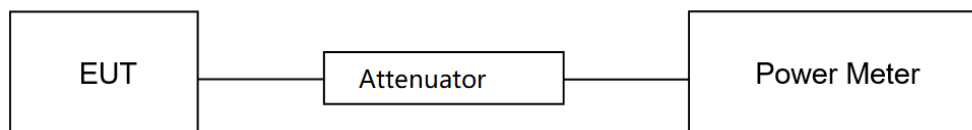

TEST ENVIRONMENT

Temperature	25.4°C	Relative Humidity	59.2%
Atmosphere Pressure	101kPa	Test Voltage	DC 12 V

TEST DATE / ENGINEER

Test Date	September 8, 2023	Test By	Johnson Liu
-----------	-------------------	---------	-------------

TEST RESULTS

Please refer to section "Test Data" - Appendix C1&C2

7.2. 6DB BANDWIDTH AND 99% OCCUPIED BANDWIDTH

LIMITS

CFR 47 FCC Part15 (15.247) Subpart C ISED RSS-247 ISSUE 3			
Section	Test Item	Limit	Frequency Range (MHz)
CFR 47 FCC 15.247(a)(2) ISED RSS-247 5.2 (a)	6 dB Bandwidth	≥ 500 kHz	2400-2483.5
ISED RSS-Gen Clause 6.7	99 % Occupied Bandwidth	For reporting purposes only.	2400-2483.5

TEST PROCEDURE

Refer to ANSI C63.10-2013 clause 11.8 for DTS bandwidth and clause 6.9 for Occupied Bandwidth.

Connect the EUT to the spectrum analyzer and use the following settings:

Center Frequency	The center frequency of the channel under test
Frequency Span	For 6 dB Bandwidth: Enough to capture all products of the modulation carrier emission For 99 % Occupied Bandwidth: Between 1.5 times and 5.0 times the OBW
Detector	Peak
RBW	For 6 dB Bandwidth: 100 kHz For 99 % Occupied Bandwidth: 1 % to 5 % of the occupied bandwidth
VBW	For 6 dB Bandwidth: $\geq 3 \times \text{RBW}$ For 99 % Occupied Bandwidth: $\geq 3 \times \text{RBW}$
Trace	Max hold
Sweep	Auto couple

a) Use the 99 % power bandwidth function of the instrument, allow the trace to stabilize and report the measured bandwidth.

b) Allow the trace to stabilize and measure the maximum width of the emission that is constrained by the frequencies associated with the two outermost amplitude points (upper and lower frequencies) that are attenuated by 6 dB relative to the maximum level measured in the fundamental emission.

TEST SETUP

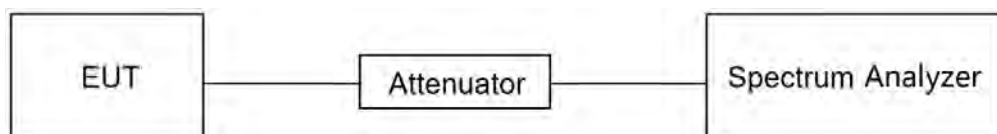

TEST ENVIRONMENT

Temperature	25.4°C	Relative Humidity	59.2%
Atmosphere Pressure	101kPa	Test Voltage	DC 12 V

TEST DATE / ENGINEER

Test Date	September 8, 2023	Test By	Johnson Liu
-----------	-------------------	---------	-------------

TEST RESULTS

Please refer to section "Test Data" - Appendix A1&A2&B1&B2

7.3. POWER SPECTRAL DENSITY

LIMITS

CFR 47 FCC Part15 (15.247) Subpart C ISED RSS-247 ISSUE 3			
Section	Test Item	Limit	Frequency Range (MHz)
CFR 47 FCC §15.247 (e) ISED RSS-247 5.2 (b)	Power Spectral Density	8 dBm in any 3 kHz band	2400-2483.5

TEST PROCEDURE

Refer to ANSI C63.10-2013 clause 11.10.5.

Connect the EUT to the spectrum analyzer and use the following settings:

Center Frequency	The center frequency of the channel under test
Detector	power averaging (rms)
RBW	$3 \text{ kHz} \leq \text{RBW} \leq 100 \text{ kHz}$
VBW	$\geq 3 \times \text{RBW}$
Span	1.5 x OBW bandwidth
Trace	Employ trace averaging(rms)mode over a minimum of 100 traces
Sweep time	Auto couple

Allow trace to fully stabilize and use the peak marker function to determine the maximum amplitude level within the RBW.

If measured value exceeds limit, reduce RBW (no less than 3 kHz) and repeat.

TEST SETUP

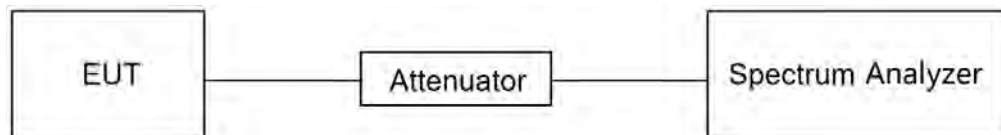

TEST ENVIRONMENT

Temperature	25.4°C	Relative Humidity	59.2%
Atmosphere Pressure	101kPa	Test Voltage	DC 12 V

TEST DATE / ENGINEER

Test Date	September 8, 2023	Test By	Johnson Liu
-----------	-------------------	---------	-------------

TEST RESULTS

Please refer to section "Test Data" - Appendix D1&D2

7.4. CONDUCTED BAND EDGE AND SPURIOUS EMISSION

LIMITS

CFR 47 FCC Part15 (15.247) Subpart C ISED RSS-247 ISSUE 3		
Section	Test Item	Limit
CFR 47 FCC §15.247 (d) ISED RSS-247 5.5	Conducted Bandedge and Spurious Emissions	at least 30 dB below that in the 100 kHz bandwidth within the band that contains the highest level of the desired power

TEST PROCEDURE

Refer to ANSI C63.10-2013 clause 11.11 and 11.13.

Connect the EUT to the spectrum analyzer and use the following settings for reference level measurement:

Center Frequency	The center frequency of the channel under test
Detector	Peak
RBW	100 kHz
VBW	$\geq 3 \times \text{RBW}$
Span	1.5 x DTS bandwidth
Trace	Max hold
Sweep time	Auto couple.

Allow trace to fully stabilize and use the peak marker function to determine the maximum PSD level.

Change the settings for emission level measurement:

Span	Set the center frequency and span to encompass frequency range to be measured
Detector	Peak
RBW	100 kHz
VBW	$\geq 3 \times \text{RBW}$
measurement points	$\geq \text{span}/\text{RBW}$
Trace	Max hold
Sweep time	Auto couple.

Allow trace to fully stabilize and use the peak marker function to determine the maximum PSD level. Ensure that the amplitude of all unwanted emissions outside of the authorized frequency band (excluding restricted frequency bands) is attenuated by at least the minimum requirements specified in 11.11.

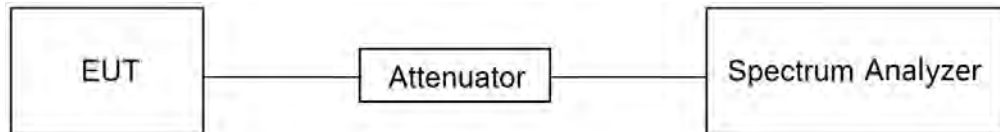
TEST SETUP

TEST ENVIRONMENT

Temperature	25.4°C	Relative Humidity	59.2%
Atmosphere Pressure	101kPa	Test Voltage	DC 12 V

TEST DATE / ENGINEER

Test Date	September 8, 2023	Test By	Johnson Liu
-----------	-------------------	---------	-------------

TEST RESULTS

Please refer to section "Test Data" - Appendix E1&E2&F1&F2

7.5. DUTY CYCLE

LIMITS

None; for reporting purposes only.

TEST PROCEDURE

Refer to ANSI C63.10-2013 clause 11.6 Zero – Span Spectrum Analyzer method.

TEST SETUP

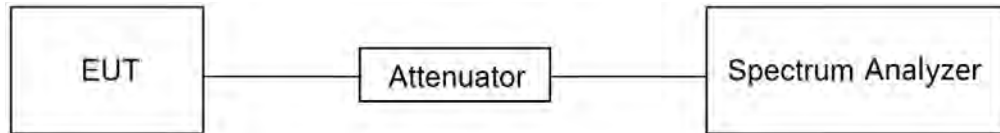

TEST ENVIRONMENT

Temperature	25.4°C	Relative Humidity	59.2%
Atmosphere Pressure	101kPa	Test Voltage	DC 12 V

TEST DATE / ENGINEER

Test Date	September 8, 2023	Test By	Johnson Liu
-----------	-------------------	---------	-------------

TEST RESULTS

Please refer to section "Test Data" - Appendix G1&G2

8. RADIATED TEST RESULTS

LIMITS

Please refer to CFR 47 FCC §15.205 and §15.209.

Please refer to ISED RSS-GEN Clause 8.9 and Clause 8.10.

Radiation Disturbance Test Limit for FCC (Class B) (9 kHz ~ 1 GHz)

Emissions radiated outside of the specified frequency bands above 30 MHz			
Frequency Range (MHz)	Field Strength Limit (uV/m) at 3 m	Field Strength Limit (dBuV/m) at 3 m	
		Quasi-Peak	
30 - 88	100	40	
88 - 216	150	43.5	
216 - 960	200	46	
Above 960	500	54	
Above 1000	500	Peak	Average
		74	54

FCC Emissions radiated outside of the specified frequency bands below 30 MHz		
Frequency (MHz)	Field strength (microvolts/meter)	Measurement distance (meters)
0.009-0.490	2400/F(kHz)	300
0.490-1.705	24000/F(kHz)	30
1.705-30.0	30	30

ISED General field strength limits at frequencies below 30 MHz

Table 6 – General field strength limits at frequencies below 30 MHz		
Frequency	Magnetic field strength (H-Field) (uA/m)	Measurement distance (m)
9 - 490 kHz ^{Note 1}	6.37/F (F in kHz)	300
490 - 1705 kHz	63.7/F (F in kHz)	30
1.705 - 30 MHz	0.08	30

Note 1: The emission limits for the ranges 9-90 kHz and 110-490 kHz are based on measurements employing a linear average detector.

ISED Restricted bands please refer to ISED RSS-GEN Clause 8.10

Table 7 – Restricted frequency bands^{Note 1}

MHz	MHz	GHz
0.090 - 0.110	149.9 - 150.05	9.0 - 9.2
0.495 - 0.505	156.52475 - 156.52525	9.3 - 9.5
2.1735 - 2.1905	156.7 - 156.9	10.6 - 12.7
3.020 - 3.026	162.0125 - 167.17	13.25 - 13.4
4.125 - 4.128	167.72 - 173.2	14.47 - 14.5
4.17725 - 4.17775	240 - 285	15.35 - 16.2
4.20725 - 4.20775	322 - 335.4	17.7 - 21.4
5.677 - 5.683	399.9 - 410	22.01 - 23.12
6.215 - 6.218	608 - 614	23.6 - 24.0
6.26775 - 6.26825	960 - 1427	31.2 - 31.8
6.31175 - 6.31225	1435 - 1626.5	36.43 - 36.5
8.291 - 8.294	1645.5 - 1646.5	Above 38.6
8.362 - 8.366	1660 - 1710	
8.37625 - 8.38675	1718.8 - 1722.2	
8.41425 - 8.41475	2200 - 2300	
12.29 - 12.293	2310 - 2390	
12.51975 - 12.52025	2483.5 - 2500	
12.57675 - 12.57725	2655 - 2900	
13.36 - 13.41	3260 - 3267	
16.42 - 16.423	3332 - 3339	
16.69475 - 16.69525	3345.8 - 3358	
16.80425 - 16.80475	3500 - 4400	
25.5 - 25.67	4500 - 5150	
37.5 - 38.25	5350 - 5460	
73 - 74.6	7250 - 7750	
74.8 - 75.2	8025 - 8500	
108 - 138		

Note 1: Certain frequency bands listed in table 7 and in bands above 38.6 GHz are designated for licence-exempt applications. These frequency bands and the requirements that apply to related devices are set out in the 200 and 300 series of RSSs.

FCC Restricted bands of operation refer to FCC §15.205 (a):

MHz	MHz	MHz	GHz
0.090-0.110	16.42-16.423	399.9-410	4.5-5.15
¹ 0.495-0.505	16.69475-16.69525	608-614	5.35-5.46
2.1735-2.1905	16.80425-16.80475	960-1240	7.25-7.75
4.125-4.128	25.5-25.67	1300-1427	8.025-8.5
4.17725-4.17775	37.5-38.25	1435-1626.5	9.0-9.2
4.20725-4.20775	73-74.6	1645.5-1646.5	9.3-9.5
6.215-6.218	74.8-75.2	1660-1710	10.6-12.7
6.26775-6.26825	108-121.94	1718.8-1722.2	13.25-13.4
6.31175-6.31225	123-138	2200-2300	14.47-14.5
8.291-8.294	149.9-150.05	2310-2390	15.35-16.2
8.362-8.366	156.52475-156.52525	2483.5-2500	17.7-21.4
8.37625-8.38675	156.7-156.9	2690-2900	22.01-23.12
8.41425-8.41475	162.0125-167.17	3260-3267	23.6-24.0
12.29-12.293	167.72-173.2	3332-3339	31.2-31.8
12.51975-12.52025	240-285	3345.8-3358	36.43-36.5
12.57675-12.57725	322-335.4	3600-4400	(²)
13.36-13.41			

Note: ¹Until February 1, 1999, this restricted band shall be 0.490-0.510 MHz.

²Above 38.6c

TEST PROCEDURE

Below 30 MHz

The setting of the spectrum analyzer

RBW	200 Hz (From 9 kHz to 0.15 MHz)/ 9 kHz (From 0.15 MHz to 30 MHz)
VBW	200 Hz (From 9 kHz to 0.15 MHz)/ 9 kHz (From 0.15 MHz to 30 MHz)
Sweep	Auto

1. The testing follows the guidelines in ANSI C63.10-2013 clause 6.4.
2. The EUT was arranged to its worst case and then turntable (from 0 degree to 360 degrees) to find the maximum reading. A pre-amp and a high pass filter are used for the test in order to get better signal level. Both Horizontal, Face-on and Face-off polarizations of the antenna are set to make the measurement.
3. The EUT was placed on a turntable with 80 cm above ground.
4. The EUT was set 3 meters from the interference receiving antenna, which was mounted on the top of a 1 m height antenna tower.
5. The radiated emission limits are based on measurements employing a CISPR quasi-peak detector except for the frequency bands 9-90 kHz, 110-490 kHz and above 1000 MHz Radiated emission limits in these three bands are based on measurements employing an average detector.
6. For measurement below 1 GHz, the initial step in collecting conducted emission data is a spectrum analyzer peak detector mode pre-scanning the measurement frequency range. Significant peaks are then marked and then Quasi Peak and average detector mode re-measured. If the emission level of the EUT measured by the peak detector is 3 dB lower than the applicable limit, the peak emission level will be reported. Otherwise, the emission measurement will be repeated using the quasi-peak and average detector and reported.
7. Although these tests were performed other than open field site, adequate comparison measurements were confirmed against 30m open field site. Therefore sufficient tests were made to demonstrate that the alternative site produces results that correlate with the ones of tests made in an open field site based on KDB 414788.
8. The limits in CFR 47, Part 15, Subpart C, paragraph 15.209 (a), are identical to those in RSS-GEN Section 8.9, Table 6, since the measurements are performed in terms of magnetic field strength and converted to electric field strength levels (as reported in the table) using the free space impedance of 377Ω . For example, the measurement frequency X kHz resulted in a level of Y dBuV/m, which is equivalent to $Y-51.5 = Z$ dBuA/m, which has the same margin, W dB, to the corresponding RSS-GEN Table 6 limit as it has to be 15.209(a) limit.

Below 1 GHz and above 30 MHz

The setting of the spectrum analyzer

RBW	120 kHz
VBW	300 kHz
Sweep	Auto
Detector	Peak/QP
Trace	Max hold

1. The testing follows the guidelines in ANSI C63.10-2013 clause 6.5.
2. The EUT was arranged to its worst case and then tune the antenna tower (from 1 m to 4 m) and turntable (from 0 degree to 360 degrees) to find the maximum reading. A pre-amp and a high pass filter are used for the test in order to get better signal level. Both horizontal and vertical polarizations of the antenna are set to make the measurement.
3. The EUT was placed on a turntable with 80 cm above ground.
4. The EUT was set 3 meters from the interference receiving antenna, which was mounted on the top of a variable height antenna tower.
5. For measurement below 1 GHz, the initial step in collecting conducted emission data is a spectrum analyzer peak detector mode pre-scanning the measurement frequency range. Significant peaks are then marked and then Quasi Peak detector mode re-measured. If the emission level of the EUT measured by the peak detector is 3 dB lower than the applicable limit, the peak emission level will be reported. Otherwise, the emission measurement will be repeated using the quasi-peak detector and reported.

Above 1 GHz

The setting of the spectrum analyzer

RBW	1 MHz
VBW	PEAK: 3 MHz AVG: see note 6
Sweep	Auto
Detector	Peak
Trace	Max hold

1. The testing follows the guidelines in ANSI C63.10-2013 clause 6.6.
2. The EUT was arranged to its worst case and then tune the antenna tower (from 1 m to 4 m) and turntable (from 0 degree to 360 degrees) to find the maximum reading. A pre-amp and a high pass filter are used for the test in order to get better signal level. Both horizontal and vertical polarizations of the antenna are set to make the measurement.
3. The EUT was placed on a turntable with 1.5 m above ground.
4. The EUT was set 3 meters from the interference receiving antenna, which was mounted on the top of a variable height antenna tower.
5. For measurement above 1 GHz, the emission measurement will be measured by the peak detector. This peak level, once corrected, must comply with the limit specified in Section 15.209.
6. For measurements above 1 GHz the resolution bandwidth is set to 1 MHz, then the video bandwidth is set to 3 MHz for peak measurements and 1 MHz resolution bandwidth with 1/T video bandwidth with peak detector for average measurements. For the Duty Cycle please refer to clause 7.5. ON TIME AND DUTY CYCLE.

X axis, Y axis, Z axis positions:

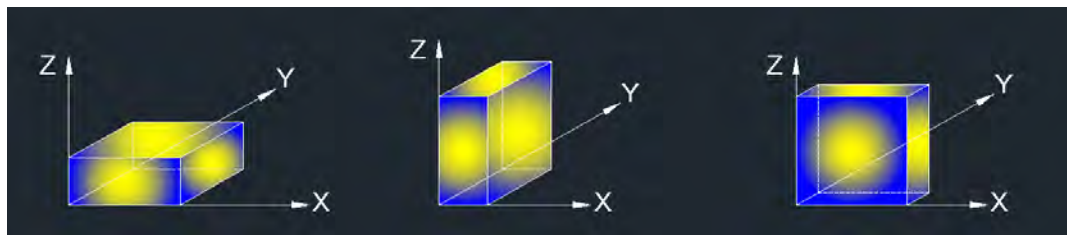

Note 1: For all radiated test, EUT in each of three orthogonal axis emissions had been tested, but only the worst case (X axis) data recorded in the report.

Note 2: The EUT was fully exercised with external accessories during the test. In the case of multiple accessory external ports, an external accessory shall be connected to one of each type of port.

For Restricted Bandedge:

Note:

1. Measurement = Reading Level + Correct Factor.
2. If the peak values are less than the average limit of 54 dBuV/m, the average result is deemed to comply with average limit.
3. PK=Peak: Peak detector.
4. AV=Average: VBW=1/Ton, where: Ton is the transmitting duration.
5. For the transmitting duration, please refer to clause 7.5.
6. Only the worst data was recorded, if it complies with the limit, the other emissions deemed to comply with the limit.
7. Both horizontal and vertical have been tested, only the worst data was recorded in the report.
8. All modes have been tested, but only the worst data was recorded in the report.

For Radiate Spurious emission (9 kHz ~ 30 MHz):

Note:

1. Measurement = Reading Level + Correct Factor.
2. If the peak values are less than the QP limit, the QP result is deemed to comply with QP limit.
3. All 3 polarizations (Horizontal, Face-on and Face-off) of the loop antenna had been tested, but only the worst data recorded in the report.
4. All modes have been tested, but only the worst data was recorded in the report.
5. dBuA/m= dBuV/m- 20Log10[120π] = dBuV/m- 51.5

For Radiate Spurious Emission (30 MHz ~ 1 GHz):

Note:

1. Result Level = Read Level + Correct Factor.
2. If the peak values are less than the QP limit, the QP result is deemed to comply with QP limit.
3. All modes have been tested, but only the worst data was recorded in the report.

For Radiate Spurious Emission (1 GHz ~ 3 GHz):

Note:

1. Measurement = Reading Level + Correct Factor.
2. If the peak values are less than the average limit of 54 dBuV/m, the average result is deemed to comply with average limit.
3. Peak: Peak detector.
4. AVG: VBW=1/Ton, where: Ton is the transmitting duration.
5. For the transmitting duration, please refer to clause 7.5.
6. Filter losses were only considered in the spurious frequency bands and the authorized band was not corrected for Band reject filter losses.
7. Proper operation of the transmitter prior to adding the filter to the measurement chain.
8. All modes have been tested, but only the worst data was recorded in the report.

For Radiate Spurious Emission (3 GHz ~ 18 GHz):

Note:

1. Peak Result = Reading Level + Correct Factor.
2. If the peak values are less than the average limit of 54 dBuV/m, the average result is deemed to comply with average limit.
3. Peak: Peak detector.
4. AVG: $VBW=1/T_{on}$, where: T_{on} is the transmitting duration.
5. For the transmitting duration, please refer to clause 7.5.
6. Filter losses were only considered in the spurious frequency bands and the authorized band was not corrected for High Pass Filter losses.
7. Proper operation of the transmitter prior to adding the filter to the measurement chain.
8. All modes have been tested, but only the worst data was recorded in the report.

For Radiate Spurious emission (18 GHz ~ 26 GHz):

Note:

1. Measurement = Reading Level + Correct Factor.
2. If the peak values are less than the average limit of 54 dBuV/m, the average result is deemed to comply with average limit.
3. Peak: Peak detector.
4. All modes have been tested, but only the worst data was recorded in the report.

TEST SETUP

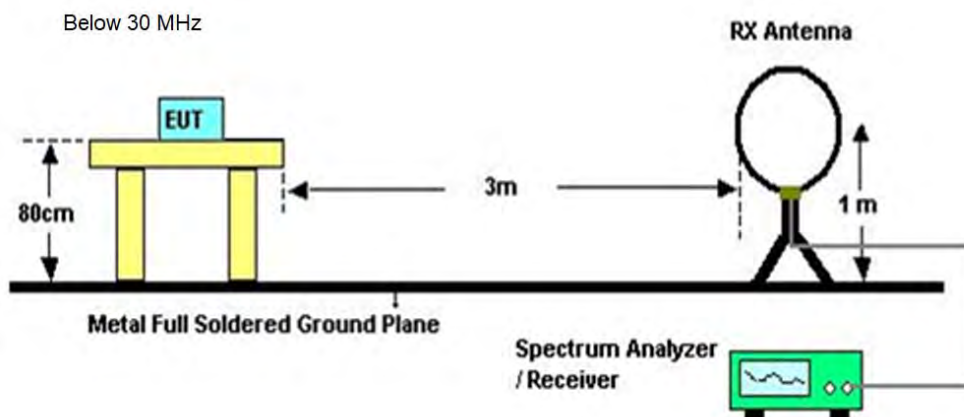

Below 1 GHz and above 30 MHz

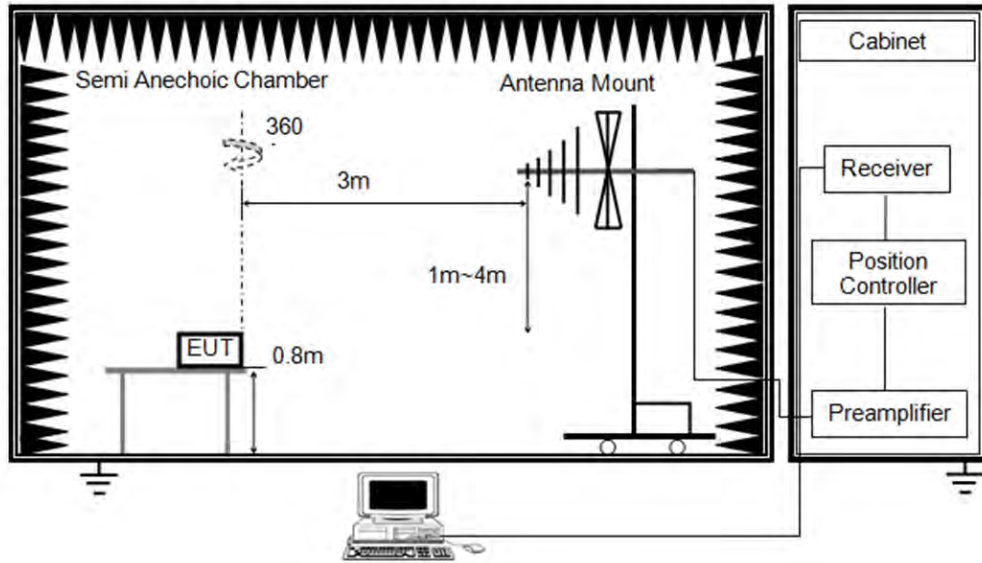

Above 1 GHz

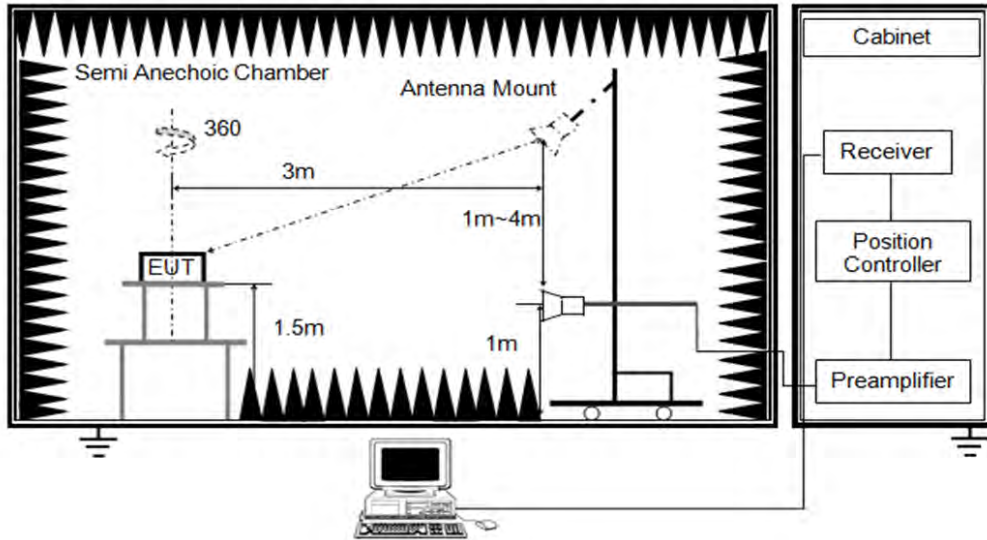

TEST ENVIRONMENT

Temperature	25.3°C	Relative Humidity	62%
Atmosphere Pressure	101kPa	Test Voltage	

TEST DATE / ENGINEER

Test Date	October 15, 2023	Test By	Rex Huang
-----------	------------------	---------	-----------

TEST RESULTS

8.1. FOR EXTERNAL ANTENNA DATA

8.1.1. RESTRICTED BANDEGE

Test Mode:	802.11b PK	Frequency(MHz):	2412
Polarity:	Horizontal	Test Voltage:	DC 12 V

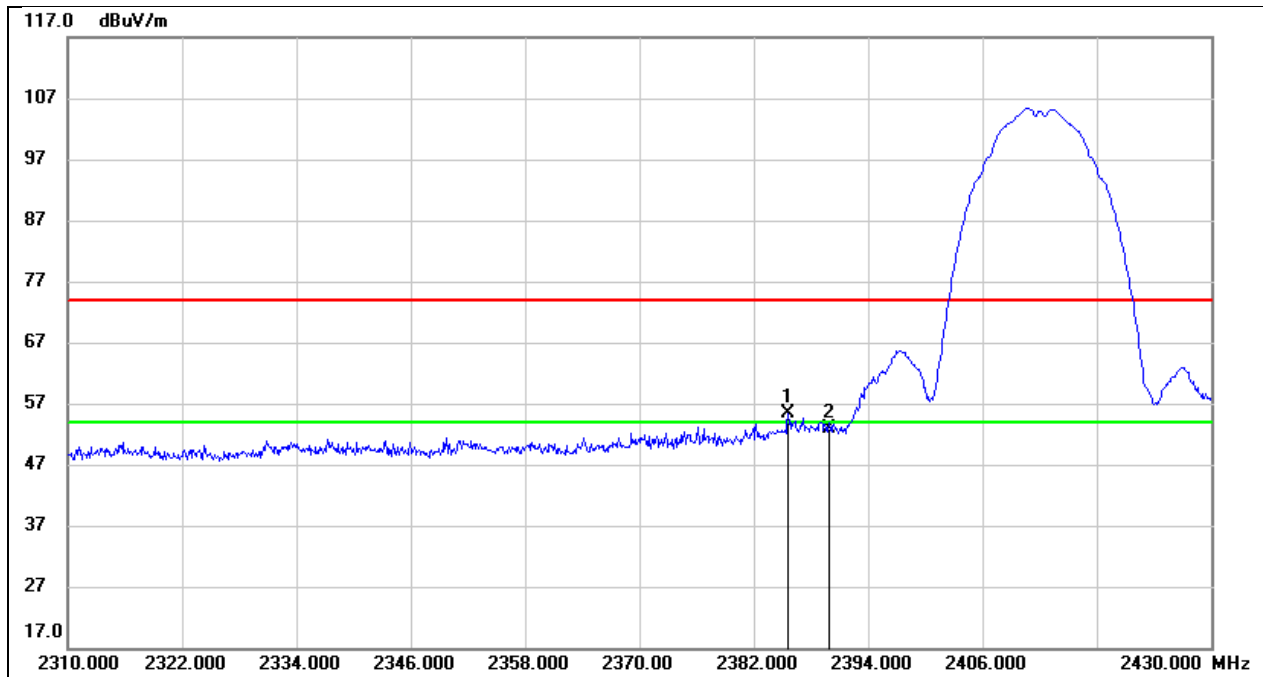

No.	Frequency (MHz)	Reading (dBuV)	Correct (dB/m)	Result (dBuV/m)	Limit (dBuV/m)	Margin (dB)	Remark
1	2385.600	23.36	32.14	55.50	74.00	-18.50	peak
2	2390.000	20.82	32.16	52.98	74.00	-21.02	peak

Test Mode:	802.11b PK	Frequency(MHz):	2412
Polarity:	Vertical	Test Voltage:	DC 12 V

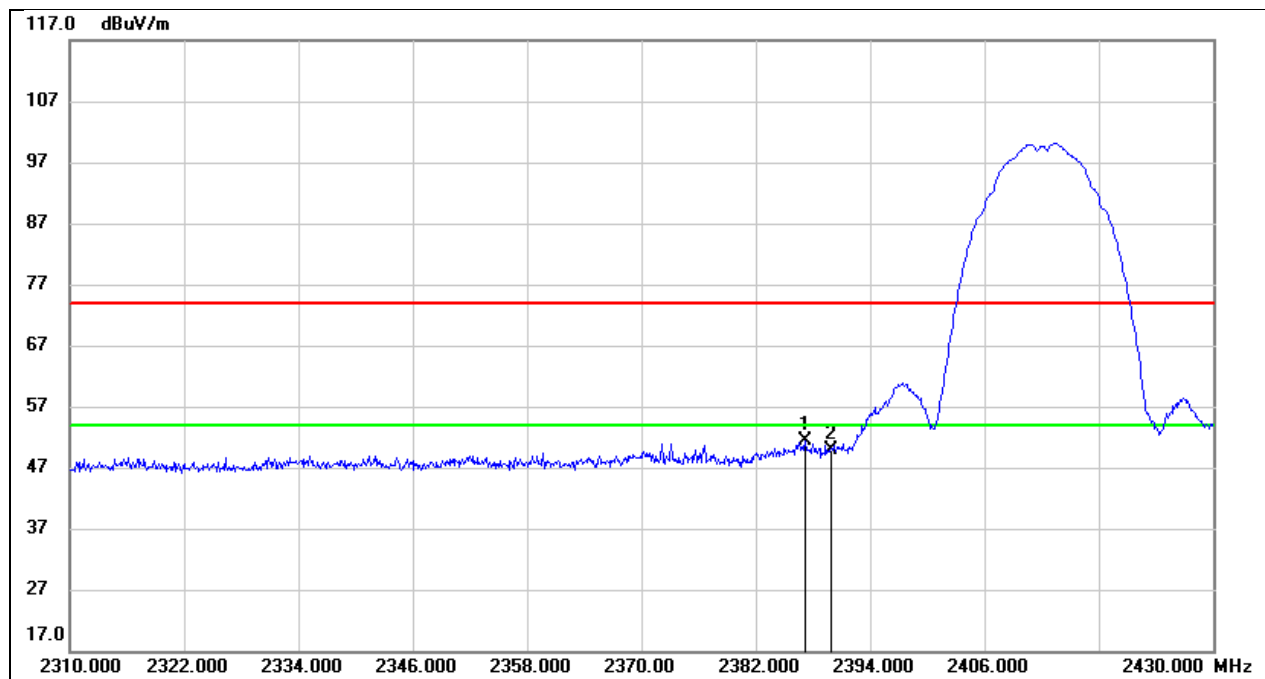

No.	Frequency (MHz)	Reading (dBuV)	Correct (dB/m)	Result (dBuV/m)	Limit (dBuV/m)	Margin (dB)	Remark
1	2387.160	19.29	32.15	51.44	74.00	-22.56	peak
2	2390.000	17.64	32.16	49.80	74.00	-24.20	peak

Test Mode:	802.11b AV	Frequency(MHz):	2412
Polarity:	Horizontal	Test Voltage:	DC 12 V

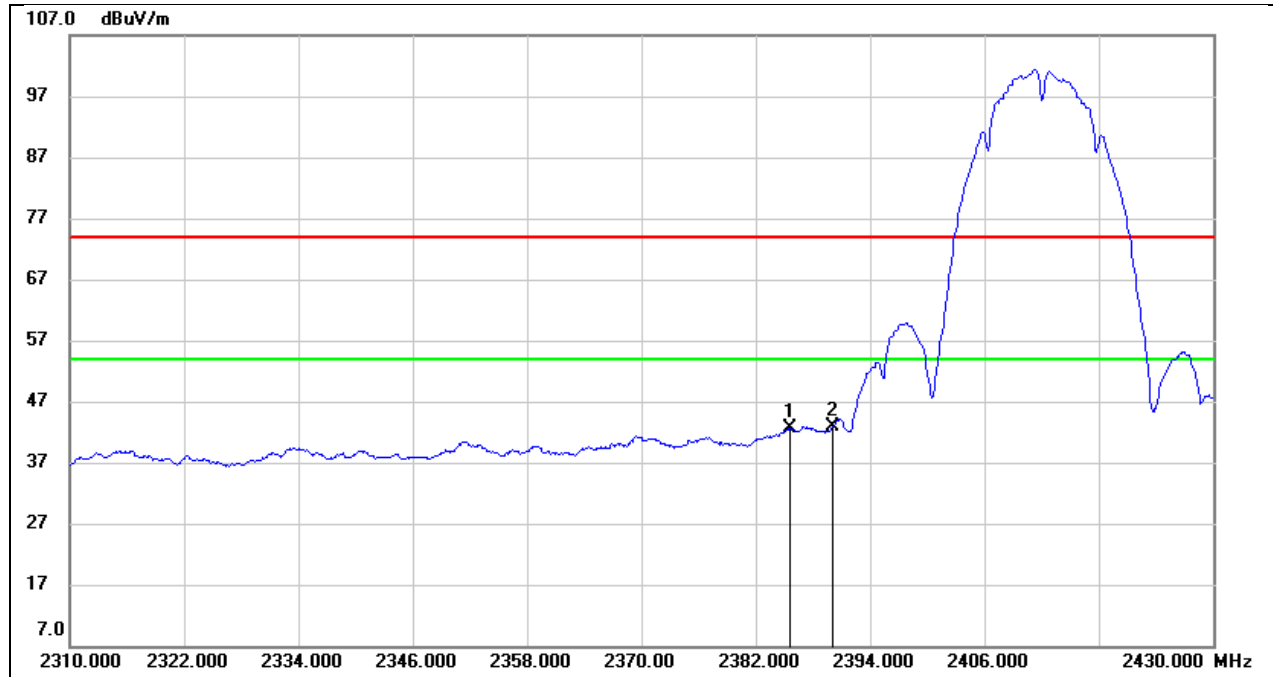

No.	Frequency (MHz)	Reading (dBuV)	Correct (dB/m)	Result (dBuV/m)	Limit (dBuV/m)	Margin (dB)	Remark
1	2385.600	10.47	32.14	42.61	54.00	-11.39	AVG
2	2390.000	10.71	32.16	42.87	54.00	-11.13	AVG

Test Mode:	802.11b PK	Frequency(MHz):	2462
Polarity:	Horizontal	Test Voltage:	DC 12 V

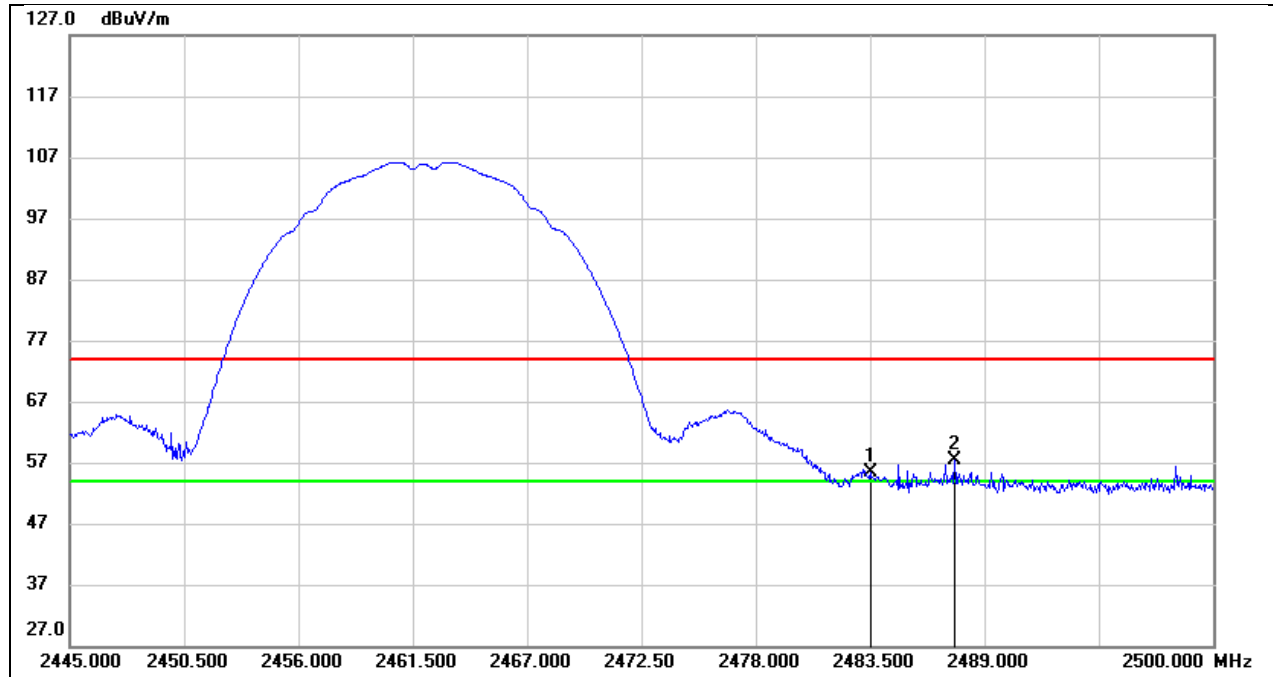

No.	Frequency (MHz)	Reading (dBuV)	Correct (dB/m)	Result (dBuV/m)	Limit (dBuV/m)	Margin (dB)	Remark
1	2483.500	22.94	32.44	55.38	74.00	-18.62	peak
2	2487.570	25.01	32.46	57.47	74.00	-16.53	peak

Test Mode:	802.11b AV	Frequency(MHz):	2462
Polarity:	Horizontal	Test Voltage:	DC 12 V

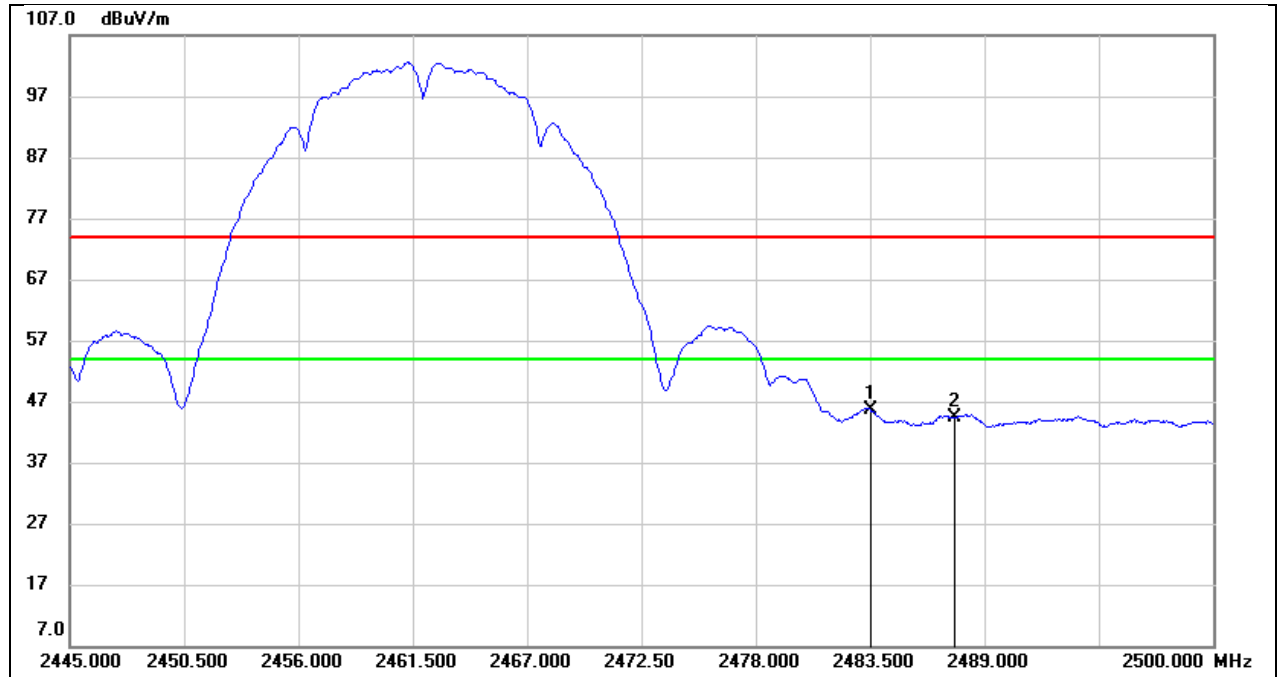

No.	Frequency (MHz)	Reading (dBuV)	Correct (dB/m)	Result (dBuV/m)	Limit (dBuV/m)	Margin (dB)	Remark
1	2483.500	13.13	32.44	45.57	54.00	-8.43	AVG
2	2487.570	11.84	32.46	44.30	54.00	-9.70	AVG

Test Mode:	802.11g PK	Frequency(MHz):	2412
Polarity:	Horizontal	Test Voltage:	DC 12 V

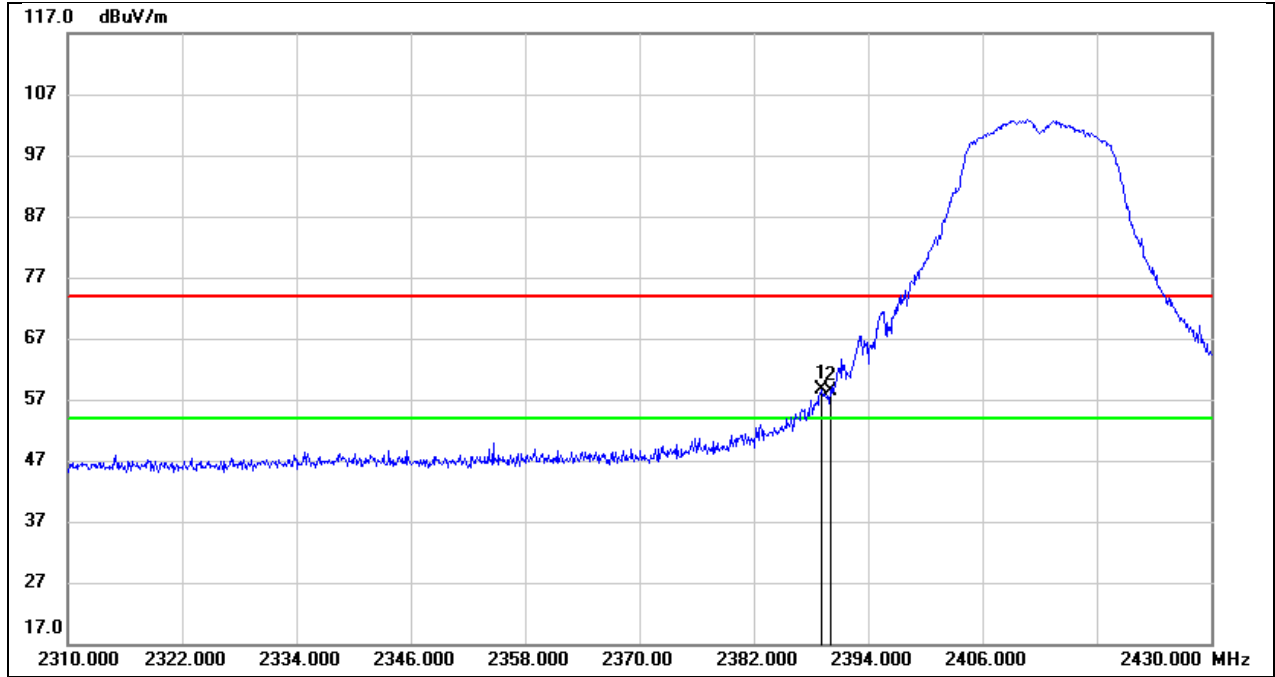

No.	Frequency (MHz)	Reading (dBuV)	Correct (dB/m)	Result (dBuV/m)	Limit (dBuV/m)	Margin (dB)	Remark
1	2389.080	26.39	32.16	58.55	74.00	-15.45	peak
2	2390.000	26.34	32.16	58.50	74.00	-15.50	peak

Test Mode:	802.11g AV	Frequency(MHz):	2412
Polarity:	Horizontal	Test Voltage:	DC 12 V

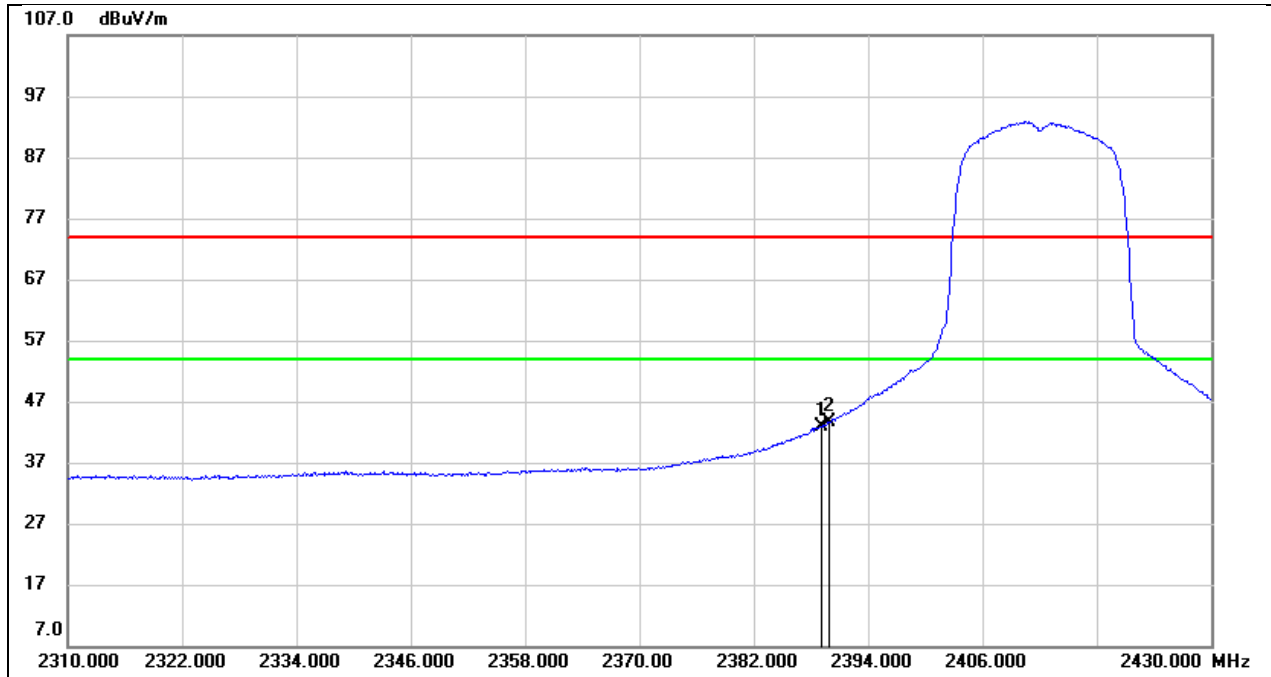

No.	Frequency (MHz)	Reading (dBuV)	Correct (dB/m)	Result (dBuV/m)	Limit (dBuV/m)	Margin (dB)	Remark
1	2389.080	10.71	32.16	42.87	54.00	-11.13	AVG
2	2390.000	11.56	32.16	43.72	54.00	-10.28	AVG

Test Mode:	802.11g PK	Frequency(MHz):	2462
Polarity:	Horizontal	Test Voltage:	DC 12 V

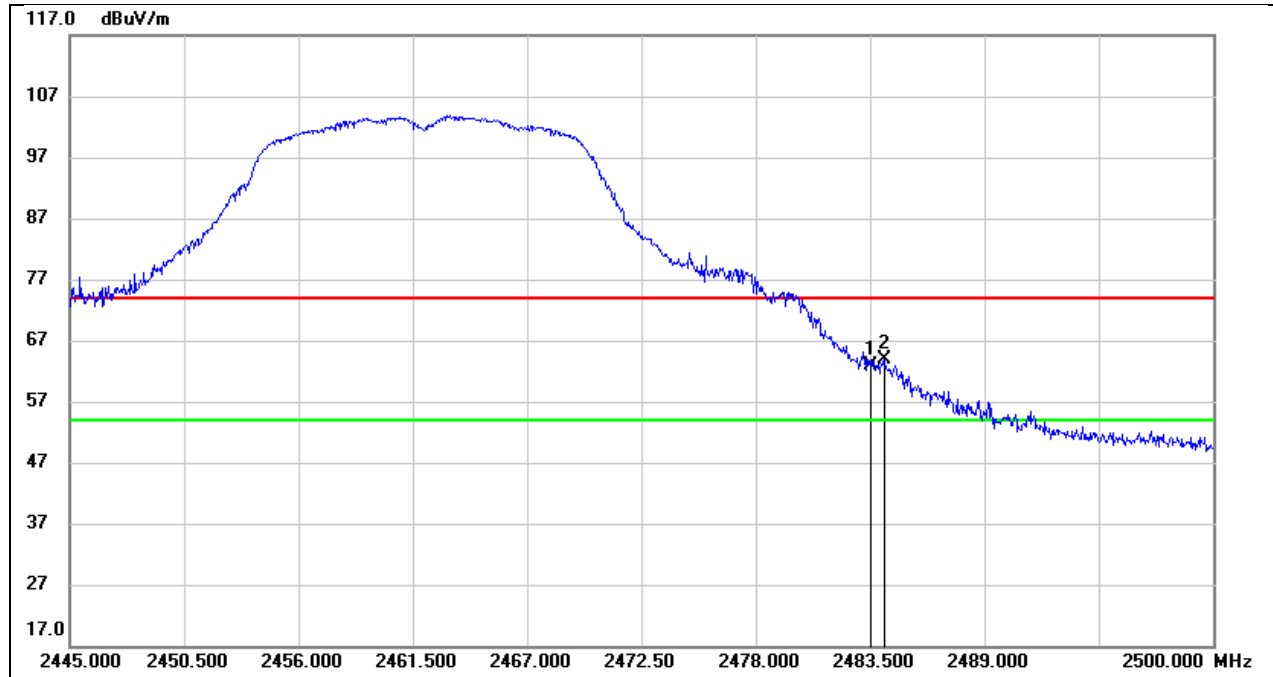

No.	Frequency (MHz)	Reading (dBuV)	Correct (dB/m)	Result (dBuV/m)	Limit (dBuV/m)	Margin (dB)	Remark
1	2483.500	30.46	32.44	62.90	74.00	-11.10	peak
2	2484.215	31.41	32.44	63.85	74.00	-10.15	peak

Test Mode:	802.11g AV	Frequency(MHz):	2462
Polarity:	Horizontal	Test Voltage:	DC 12 V

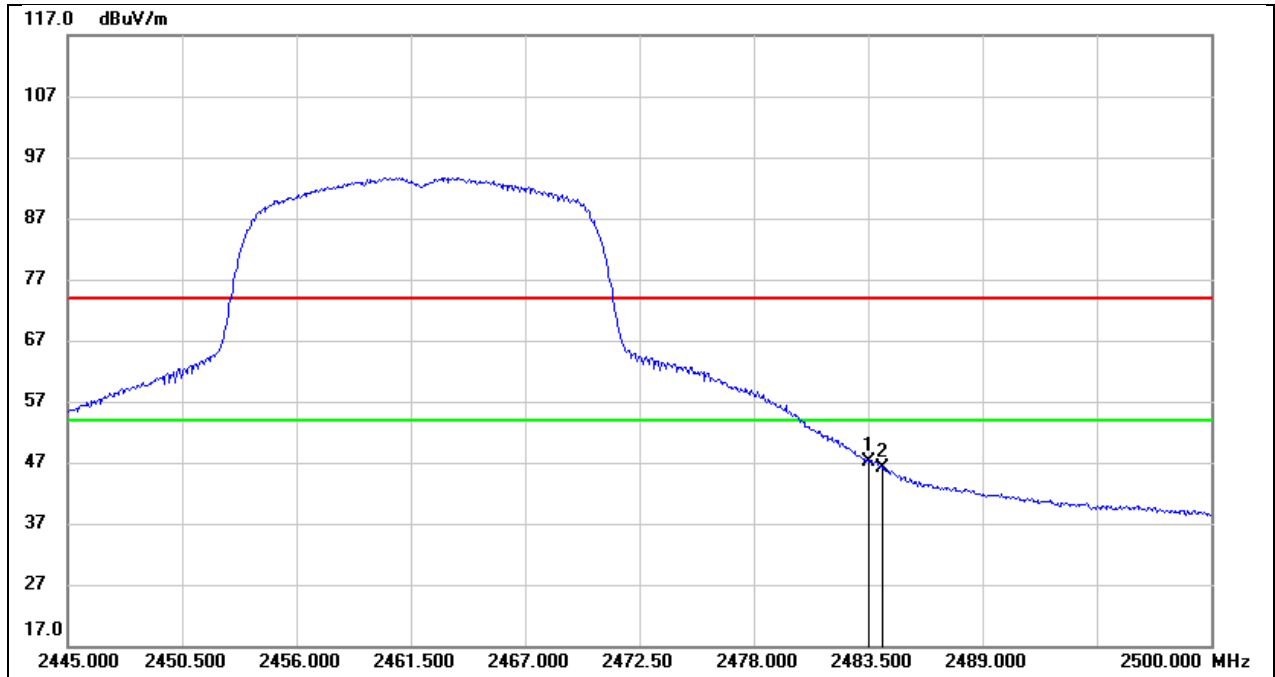

No.	Frequency (MHz)	Reading (dBuV)	Correct (dB/m)	Result (dBuV/m)	Limit (dBuV/m)	Margin (dB)	Remark
1	2483.500	14.64	32.44	47.08	54.00	-6.92	AVG
2	2484.215	13.79	32.44	46.23	54.00	-7.77	AVG

Test Mode:	802.11n HT20 PK	Frequency(MHz):	2412
Polarity:	Horizontal	Test Voltage:	DC 12 V

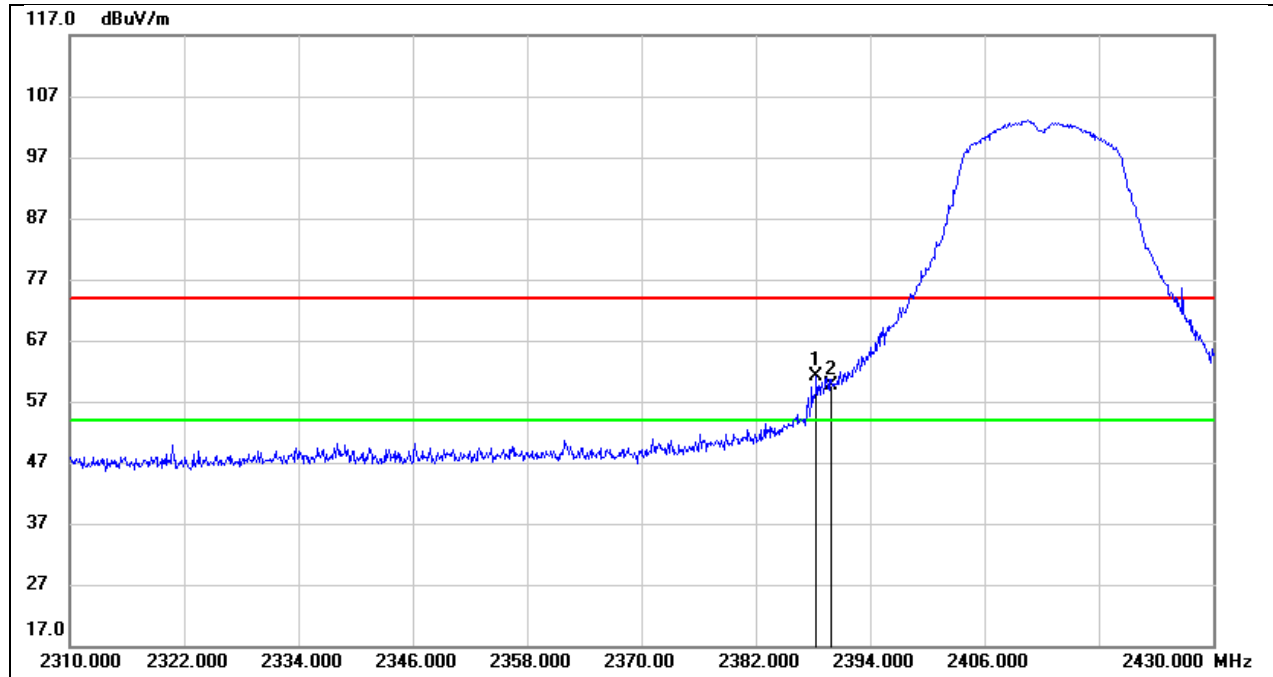

No.	Frequency (MHz)	Reading (dBuV)	Correct (dB/m)	Result (dBuV/m)	Limit (dBuV/m)	Margin (dB)	Remark
1	2388.360	28.85	32.16	61.01	74.00	-12.99	peak
2	2390.000	27.53	32.16	59.69	74.00	-14.31	peak

Test Mode:	802.11n HT20 AV	Frequency(MHz):	2412
Polarity:	Horizontal	Test Voltage:	DC 12 V

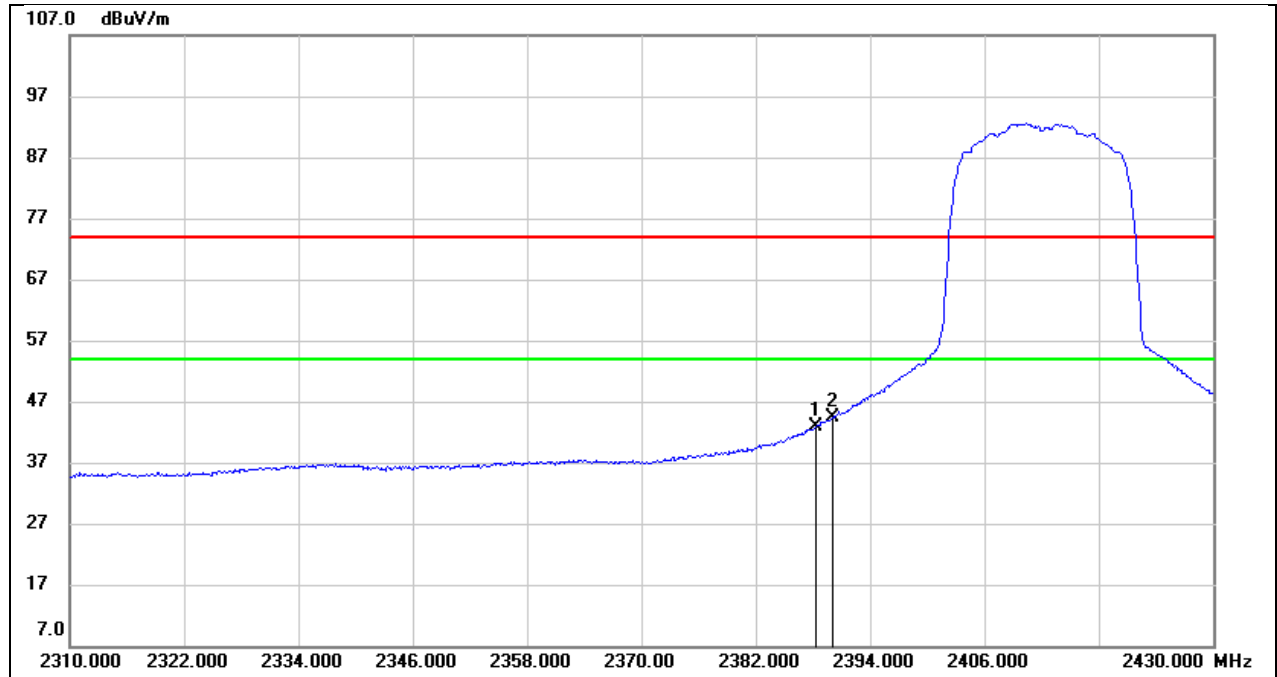

No.	Frequency (MHz)	Reading (dBuV)	Correct (dB/m)	Result (dBuV/m)	Limit (dBuV/m)	Margin (dB)	Remark
1	2388.360	10.78	32.16	42.94	54.00	-11.06	AVG
2	2390.000	12.30	32.16	44.46	54.00	-9.54	AVG

Test Mode:	802.11n HT20 PK	Frequency(MHz):	2462
Polarity:	Horizontal	Test Voltage:	DC 12 V

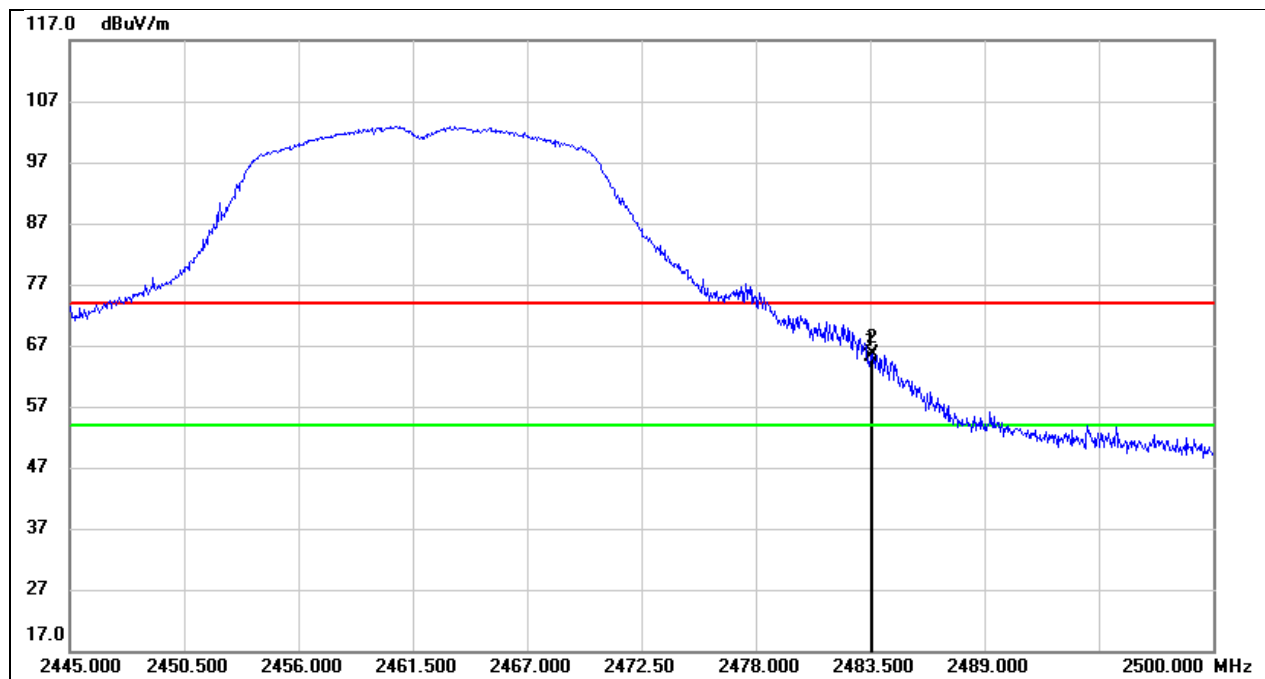

No.	Frequency (MHz)	Reading (dBuV)	Correct (dB/m)	Result (dBuV/m)	Limit (dBuV/m)	Margin (dB)	Remark
1	2483.500	32.74	32.44	65.18	74.00	-8.82	peak
2	2483.610	33.10	32.44	65.54	74.00	-8.46	peak

Test Mode:	802.11n HT20 AV	Frequency(MHz):	2462
Polarity:	Horizontal	Test Voltage:	DC 12 V

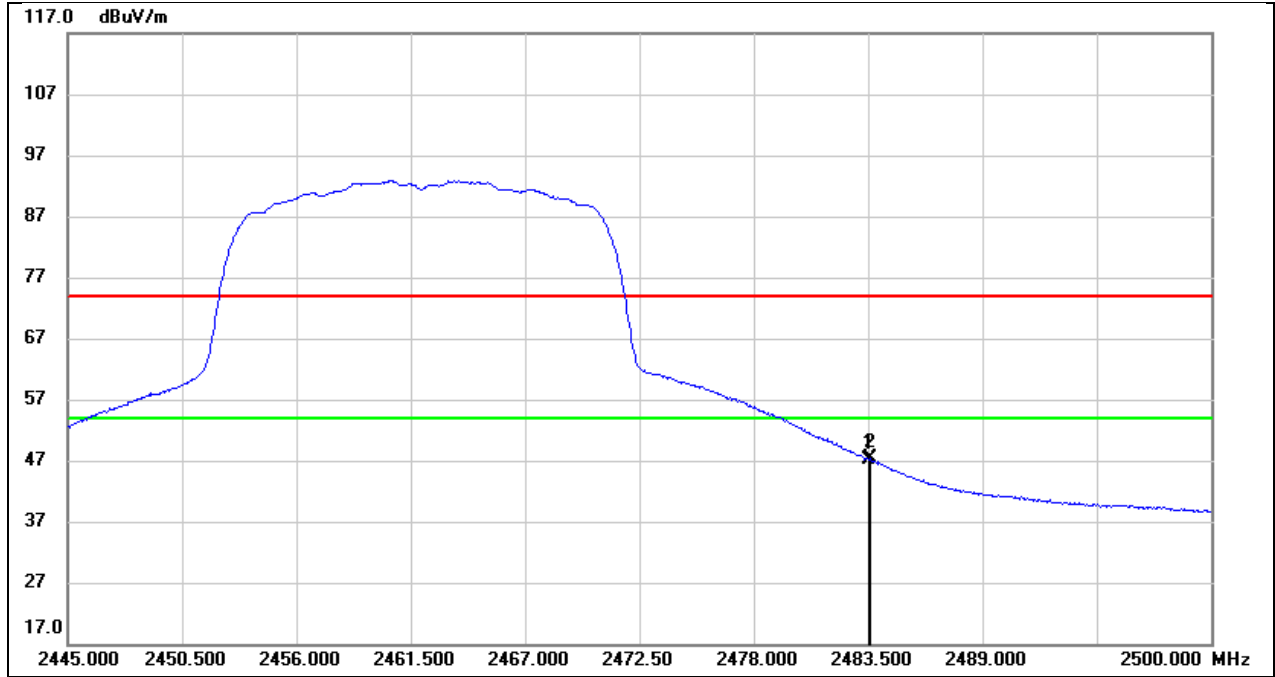

No.	Frequency (MHz)	Reading (dBuV)	Correct (dB/m)	Result (dBuV/m)	Limit (dBuV/m)	Margin (dB)	Remark
1	2483.500	14.70	32.44	47.14	54.00	-6.86	AVG
2	2483.610	14.85	32.44	47.29	54.00	-6.71	AVG

8.1.2. SPURIOUS EMISSIONS(1 GHz~3 GHz)

Test Mode:	802.11b	Frequency(MHz):	2412
Polarity:	Horizontal	Test Voltage:	DC 12 V

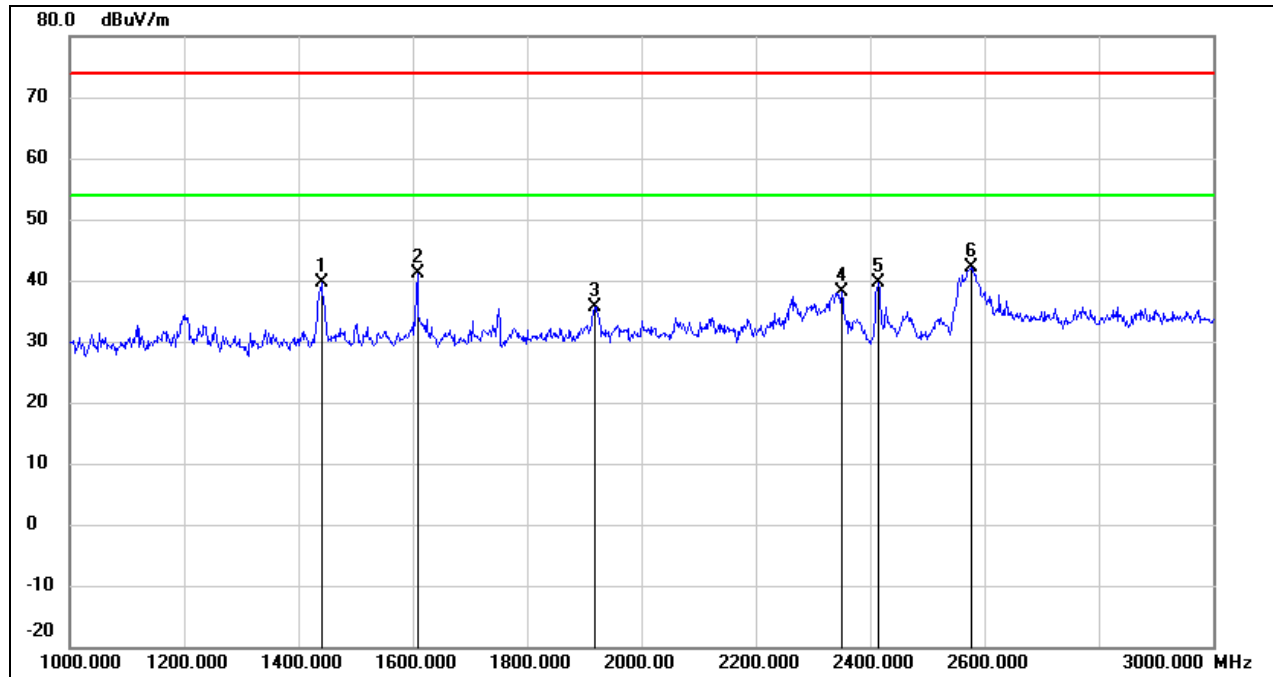

No.	Frequency (MHz)	Reading (dBuV)	Correct (dB/m)	Result (dBuV/m)	Limit (dBuV/m)	Margin (dB)	Remark
1	1440.000	52.58	-12.98	39.60	74.00	-34.40	peak
2	1608.000	53.53	-12.35	41.18	74.00	-32.82	peak
3	1918.000	46.97	-11.33	35.64	74.00	-38.36	peak
4	2350.000	47.29	-9.26	38.03	74.00	-35.97	peak
5	2412.000	48.47	-8.93	39.54	/	/	fundamental
6	2576.000	50.49	-8.26	42.23	74.00	-31.77	peak

Test Mode:	802.11b	Frequency(MHz):	2412
Polarity:	Vertical	Test Voltage:	DC 12 V

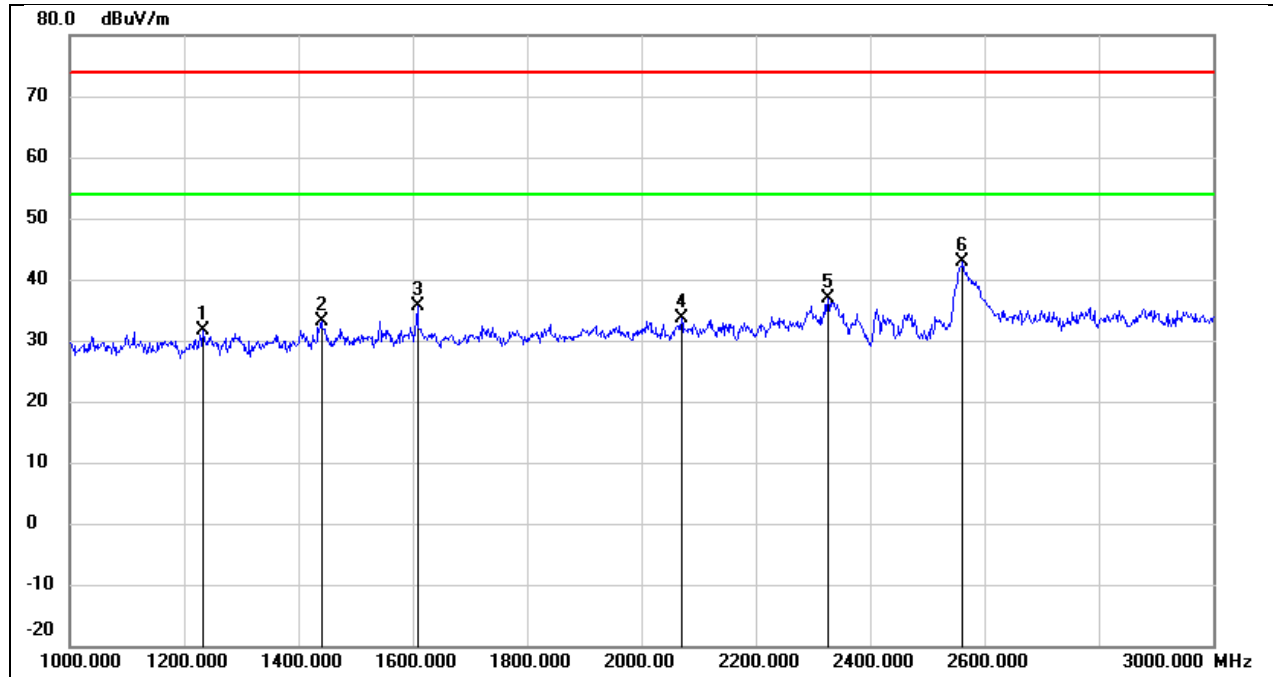

No.	Frequency (MHz)	Reading (dBuV)	Correct (dB/m)	Result (dBuV/m)	Limit (dBuV/m)	Margin (dB)	Remark
1	1232.000	45.50	-13.95	31.55	74.00	-42.45	peak
2	1440.000	46.09	-12.98	33.11	74.00	-40.89	peak
3	1608.000	48.06	-12.35	35.71	74.00	-38.29	peak
4	2070.000	44.37	-10.70	33.67	74.00	-40.33	peak
5	2326.000	46.26	-9.38	36.88	74.00	-37.12	peak
6	2562.000	51.28	-8.31	42.97	74.00	-31.03	peak

Test Mode:	802.11b	Frequency(MHz):	2437
Polarity:	Horizontal	Test Voltage:	DC 12 V

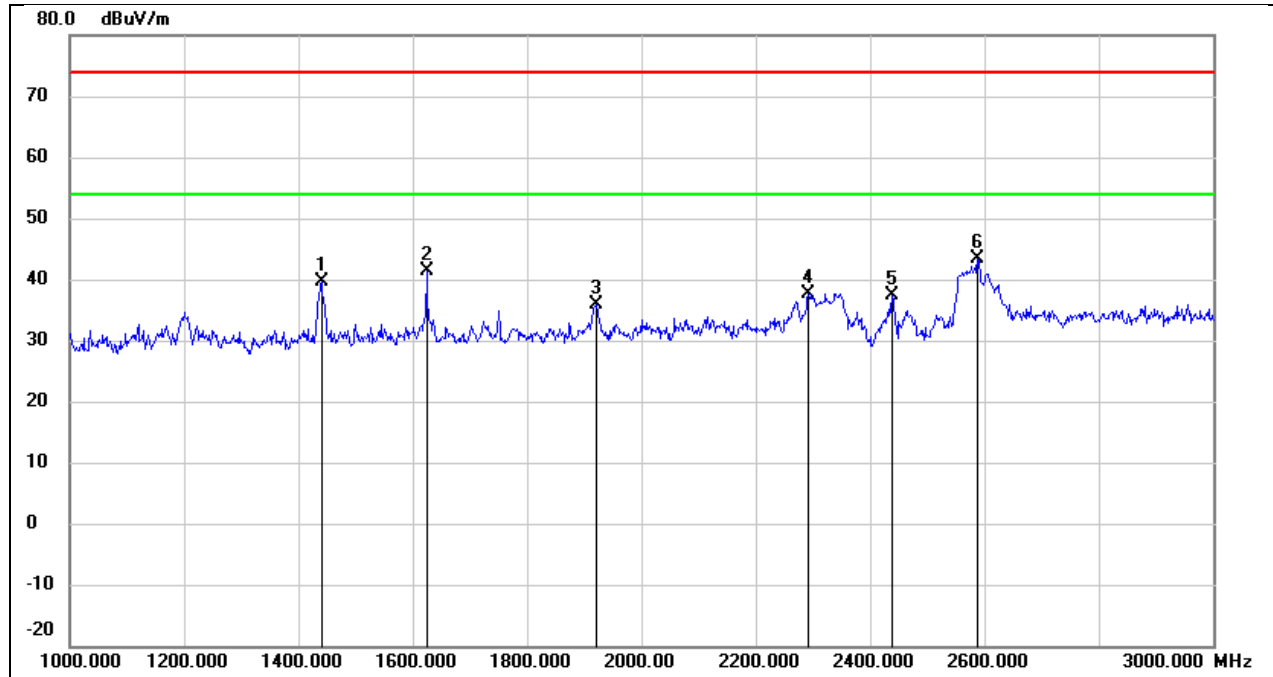

No.	Frequency (MHz)	Reading (dBuV)	Correct (dB/m)	Result (dBuV/m)	Limit (dBuV/m)	Margin (dB)	Remark
1	1440.000	52.63	-12.98	39.65	74.00	-34.35	peak
2	1624.000	53.73	-12.30	41.43	74.00	-32.57	peak
3	1922.000	47.16	-11.32	35.84	74.00	-38.16	peak
4	2292.000	47.26	-9.56	37.70	74.00	-36.30	peak
5	2437.000	46.15	-8.80	37.35	/	/	fundamental
6	2588.000	51.62	-8.22	43.40	74.00	-30.60	peak

Test Mode:	802.11b	Frequency(MHz):	2437
Polarity:	Vertical	Test Voltage:	DC 12 V

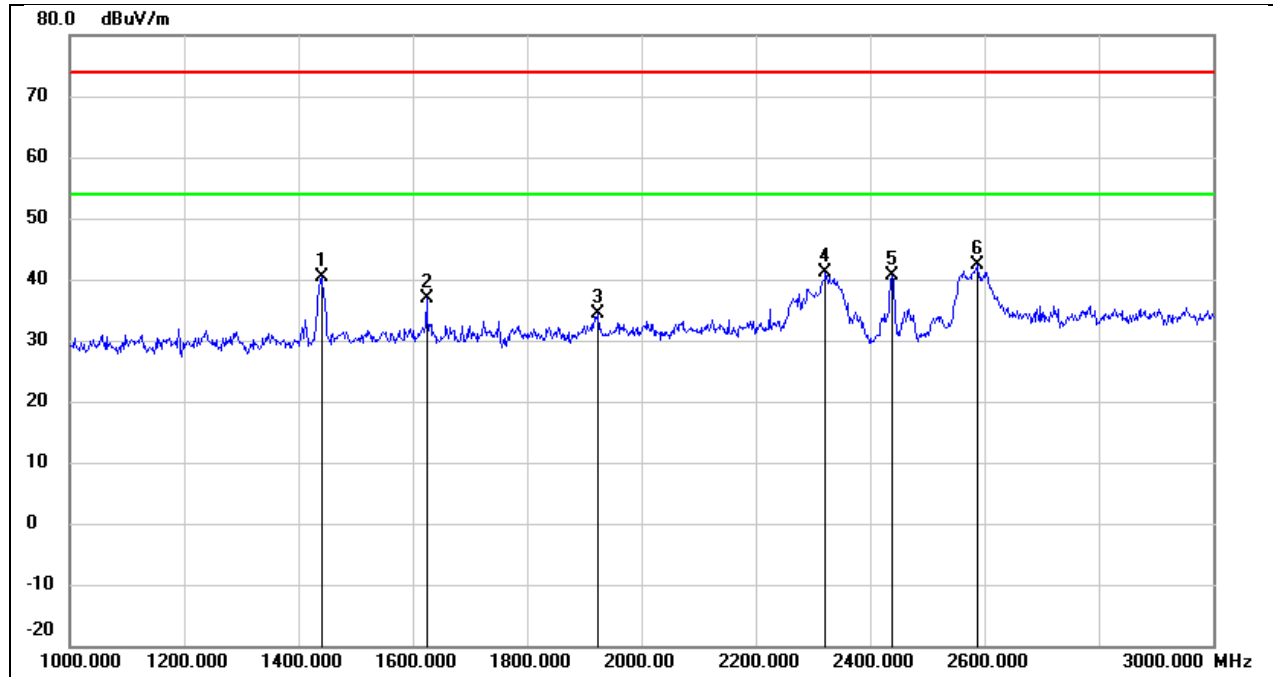

No.	Frequency (MHz)	Reading (dBuV)	Correct (dB/m)	Result (dBuV/m)	Limit (dBuV/m)	Margin (dB)	Remark
1	1440.000	53.45	-12.98	40.47	74.00	-33.53	peak
2	1624.000	49.26	-12.30	36.96	74.00	-37.04	peak
3	1924.000	45.76	-11.31	34.45	74.00	-39.55	peak
4	2322.000	50.53	-9.40	41.13	74.00	-32.87	peak
5	2437.000	49.33	-8.80	40.53	/	/	fundamental
6	2588.000	50.58	-8.22	42.36	74.00	-31.64	peak

Test Mode:	802.11b	Frequency(MHz):	2462
Polarity:	Horizontal	Test Voltage:	DC 12 V

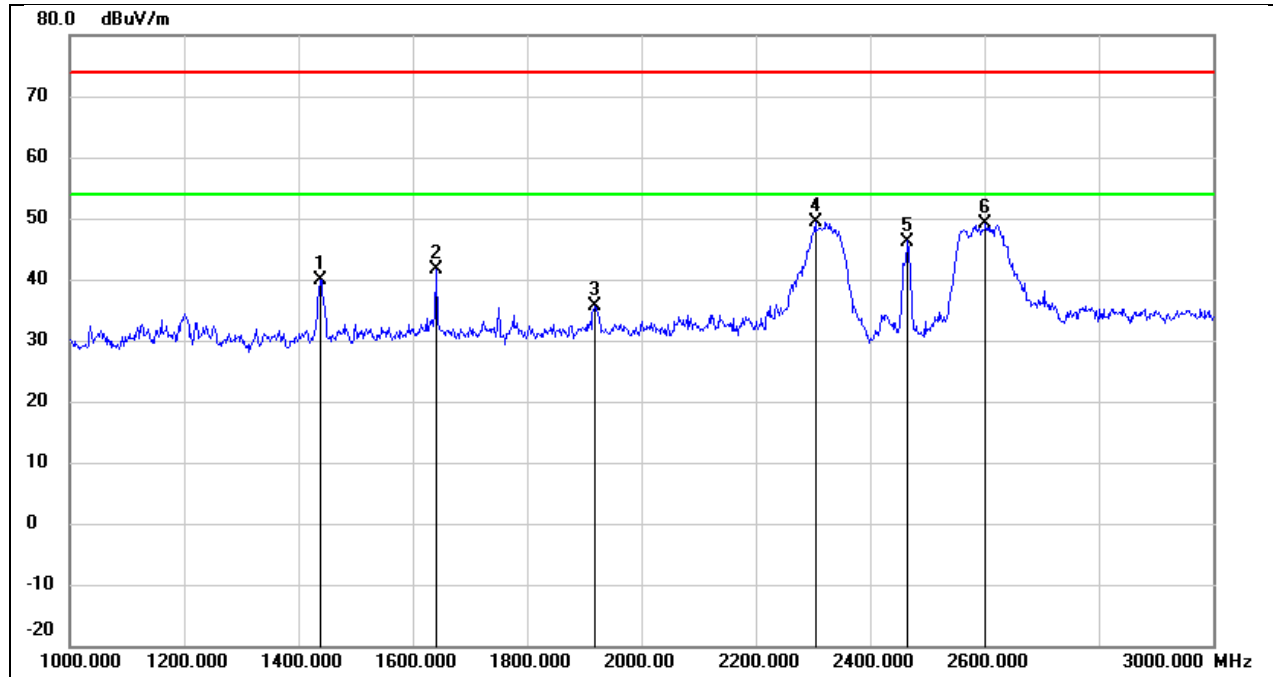

No.	Frequency (MHz)	Reading (dBuV)	Correct (dB/m)	Result (dBuV/m)	Limit (dBuV/m)	Margin (dB)	Remark
1	1438.000	52.87	-13.00	39.87	74.00	-34.13	peak
2	1642.000	53.80	-12.24	41.56	74.00	-32.44	peak
3	1918.000	46.98	-11.33	35.65	74.00	-38.35	peak
4	2304.000	58.87	-9.50	49.37	74.00	-24.63	peak
5	2462.000	54.91	-8.66	46.25	/	/	fundamental
6	2602.000	57.25	-8.19	49.06	74.00	-24.94	peak

Test Mode:	802.11b	Frequency(MHz):	2462
Polarity:	Vertical	Test Voltage:	DC 12 V

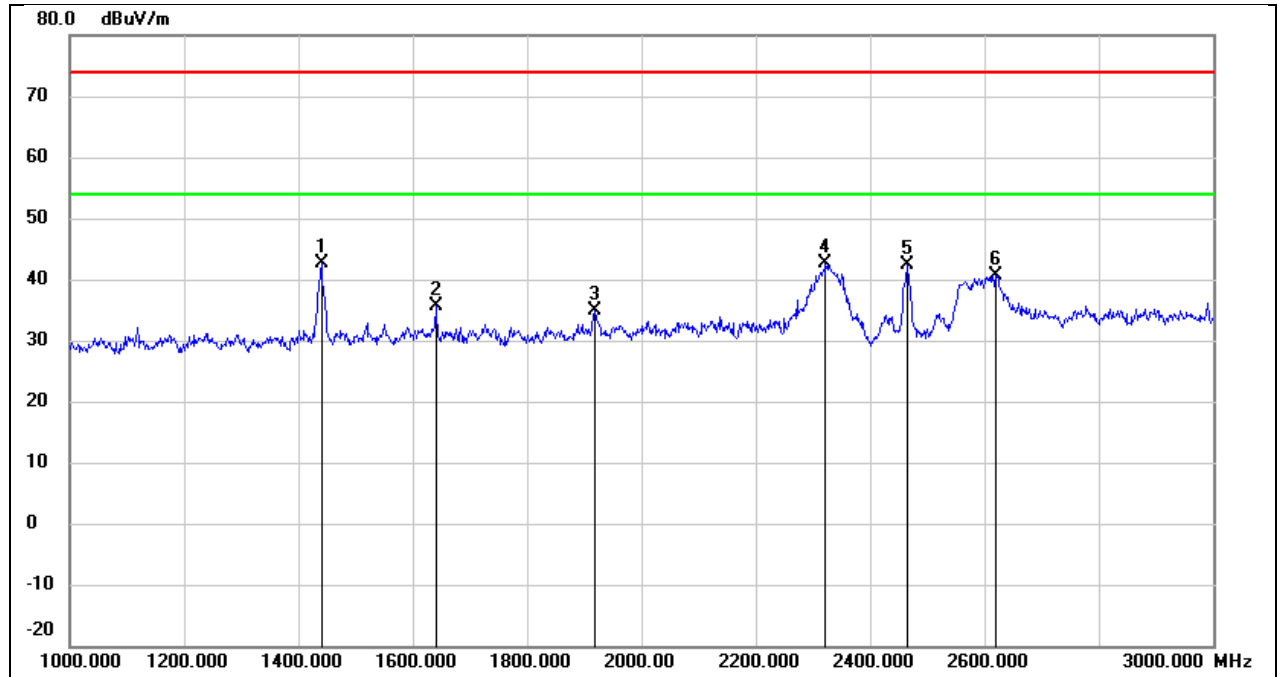

No.	Frequency (MHz)	Reading (dBuV)	Correct (dB/m)	Result (dBuV/m)	Limit (dBuV/m)	Margin (dB)	Remark
1	1440.000	55.65	-12.98	42.67	74.00	-31.33	peak
2	1640.000	47.91	-12.24	35.67	74.00	-38.33	peak
3	1918.000	46.17	-11.33	34.84	74.00	-39.16	peak
4	2322.000	51.98	-9.40	42.58	74.00	-31.42	peak
5	2462.000	51.11	-8.68	42.43	/	/	fundamental
6	2620.000	48.75	-8.13	40.62	74.00	-33.38	peak

8.1.3. SPURIOUS EMISSIONS(3 GHz~18 GHz)

Test Mode:	802.11b	Frequency(MHz):	2412
Polarity:	Horizontal	Test Voltage:	DC 12 V

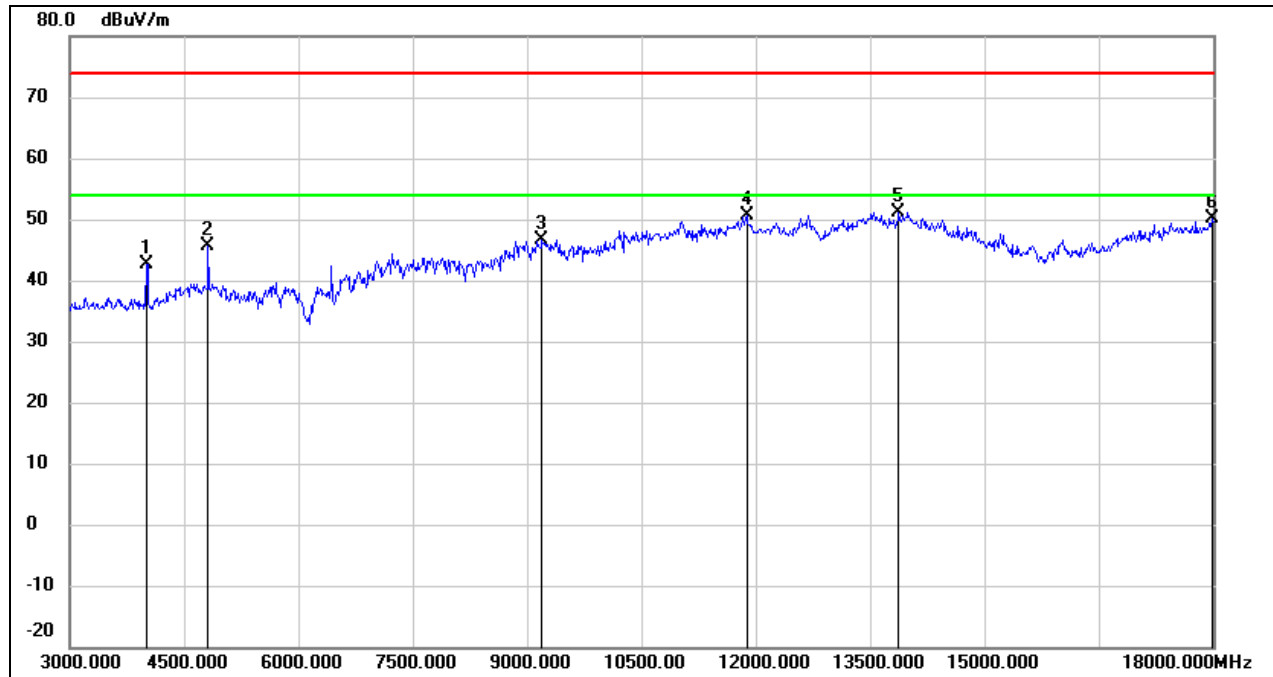

No.	Frequency (MHz)	Reading (dBuV)	Correct (dB/m)	Result (dBuV/m)	Limit (dBuV/m)	Margin (dB)	Remark
1	4005.000	46.50	-3.78	42.72	74.00	-31.28	peak
2	4815.000	45.97	-0.26	45.71	74.00	-28.29	peak
3	9195.000	36.11	10.56	46.67	74.00	-27.33	peak
4	11880.000	33.01	17.63	50.64	74.00	-23.36	peak
5	13875.000	29.41	21.70	51.11	74.00	-22.89	peak
6	17985.000	24.45	25.60	50.05	74.00	-23.95	peak

Test Mode:	802.11b	Frequency(MHz):	2412
Polarity:	Vertical	Test Voltage:	DC 12 V

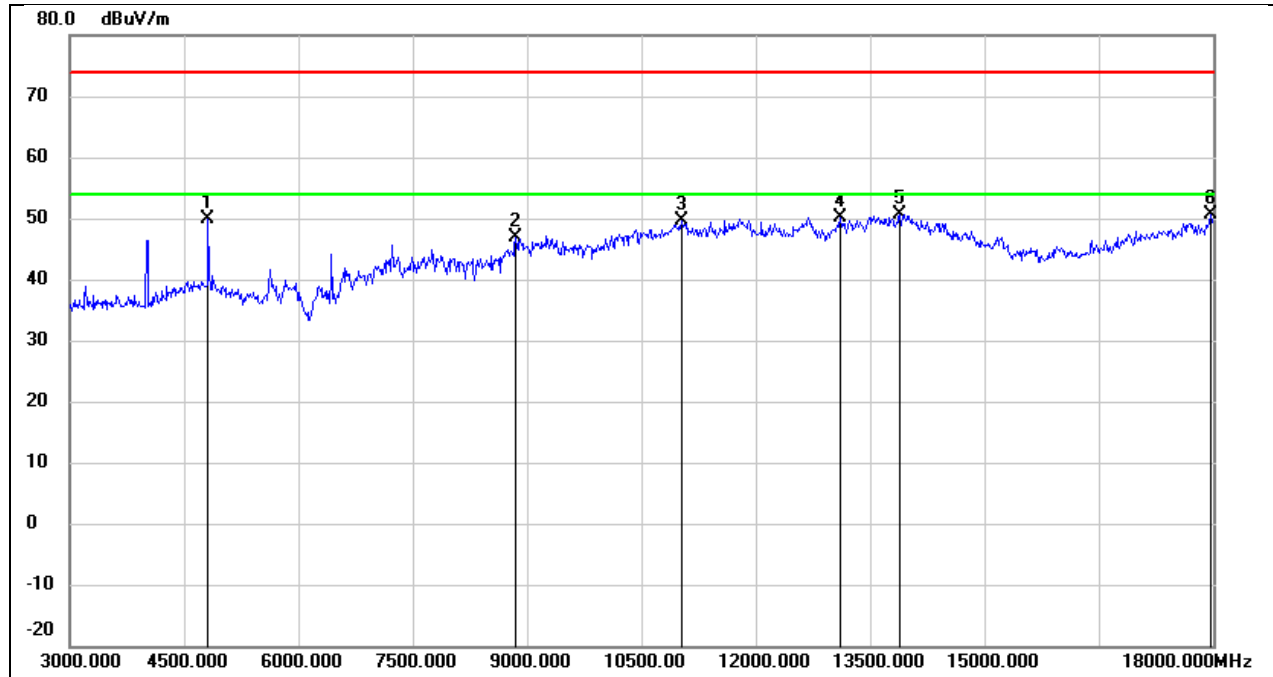

No.	Frequency (MHz)	Reading (dBuV)	Correct (dB/m)	Result (dBuV/m)	Limit (dBuV/m)	Margin (dB)	Remark
1	4815.000	50.03	-0.26	49.77	74.00	-24.23	peak
2	8850.000	37.42	9.39	46.81	74.00	-27.19	peak
3	11025.000	34.74	14.85	49.59	74.00	-24.41	peak
4	13110.000	31.05	19.20	50.25	74.00	-23.75	peak
5	13890.000	28.98	21.72	50.70	74.00	-23.30	peak
6	17970.000	25.12	25.51	50.63	74.00	-23.37	peak

Test Mode:	802.11b	Frequency(MHz):	2437
Polarity:	Horizontal	Test Voltage:	DC 12 V

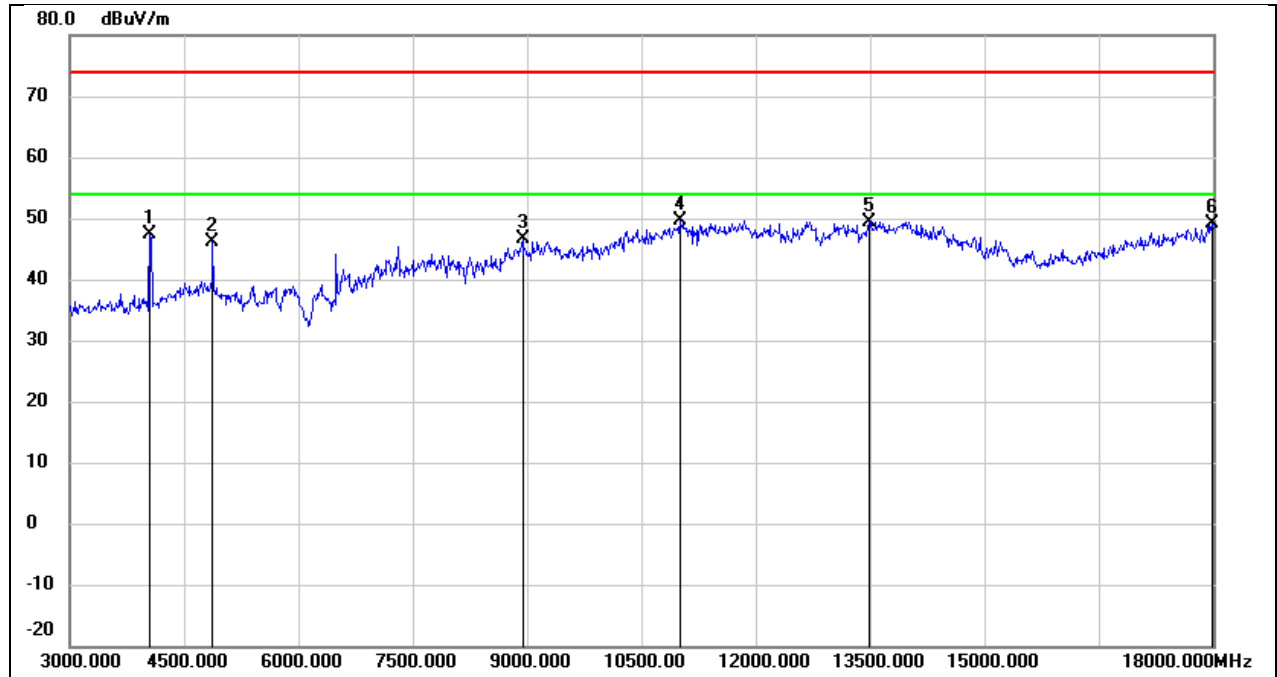

No.	Frequency (MHz)	Reading (dBuV)	Correct (dB/m)	Result (dBuV/m)	Limit (dBuV/m)	Margin (dB)	Remark
1	4050.000	51.01	-3.56	47.45	74.00	-26.55	peak
2	4875.000	46.18	-0.03	46.15	74.00	-27.85	peak
3	8940.000	36.53	10.04	46.57	74.00	-27.43	peak
4	11010.000	34.80	14.81	49.61	74.00	-24.39	peak
5	13485.000	28.66	20.84	49.50	74.00	-24.50	peak
6	17985.000	23.52	25.60	49.12	74.00	-24.88	peak

Test Mode:	802.11b	Frequency(MHz):	2437
Polarity:	Vertical	Test Voltage:	DC 12 V

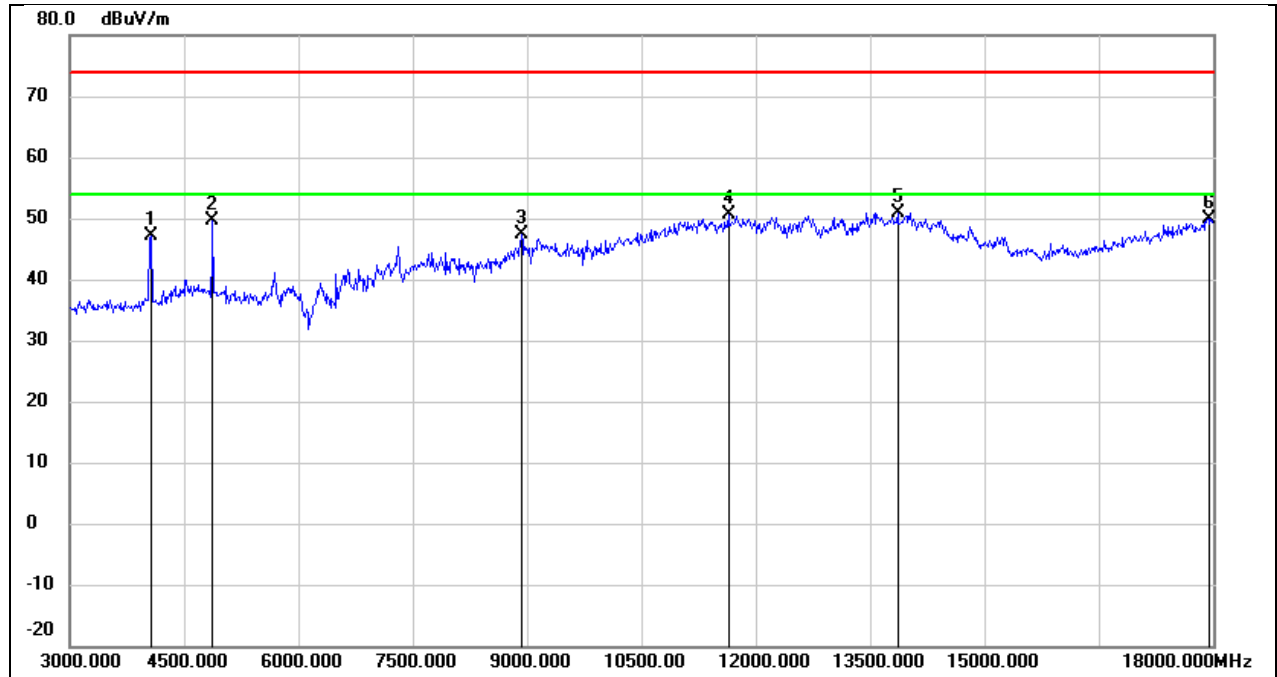

No.	Frequency (MHz)	Reading (dBuV)	Correct (dB/m)	Result (dBuV/m)	Limit (dBuV/m)	Margin (dB)	Remark
1	4065.000	50.62	-3.49	47.13	74.00	-26.87	peak
2	4875.000	49.59	-0.03	49.56	74.00	-24.44	peak
3	8925.000	37.40	9.94	47.34	74.00	-26.66	peak
4	11640.000	33.76	16.98	50.74	74.00	-23.26	peak
5	13860.000	29.13	21.67	50.80	74.00	-23.20	peak
6	17940.000	24.57	25.34	49.91	74.00	-24.09	peak

Test Mode:	802.11b	Frequency(MHz):	2462
Polarity:	Horizontal	Test Voltage:	DC 12 V

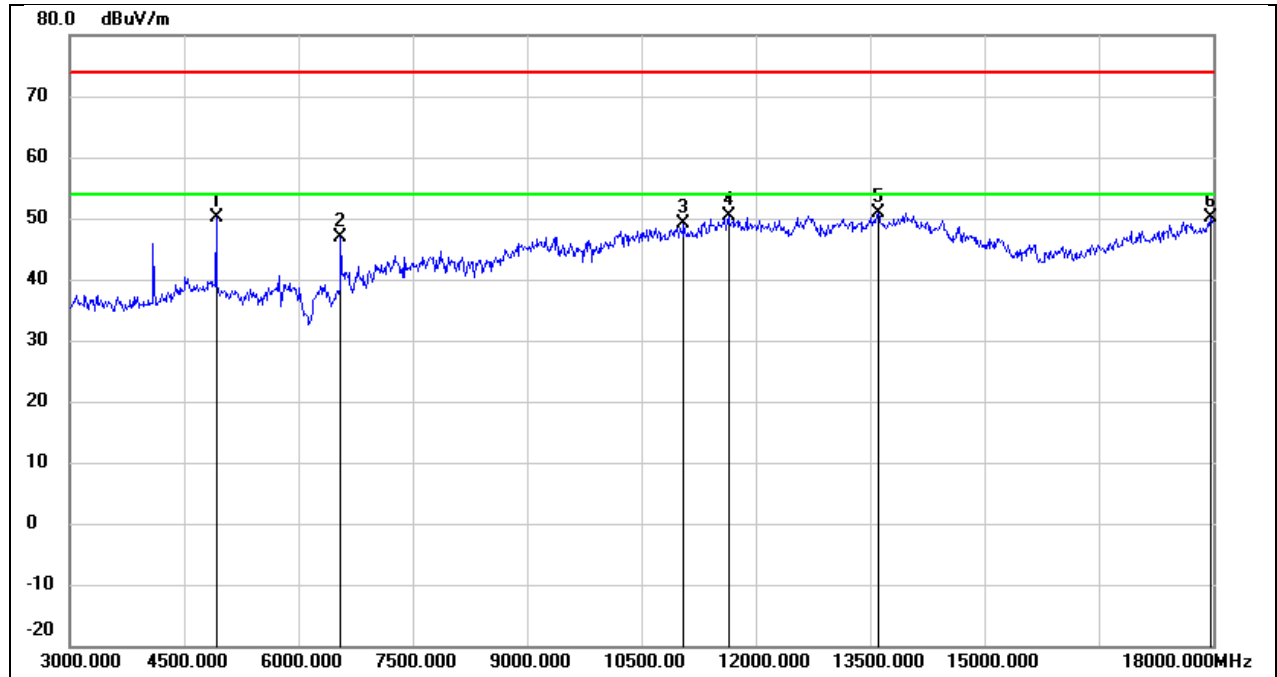

No.	Frequency (MHz)	Reading (dBuV)	Correct (dB/m)	Result (dBuV/m)	Limit (dBuV/m)	Margin (dB)	Remark
1	4920.000	50.06	0.14	50.20	74.00	-23.80	peak
2	6555.000	42.28	4.49	46.77	74.00	-27.23	peak
3	11055.000	34.08	14.96	49.04	74.00	-24.96	peak
4	11640.000	33.41	16.98	50.39	74.00	-23.61	peak
5	13605.000	29.79	21.12	50.91	74.00	-23.09	peak
6	17970.000	24.54	25.51	50.05	74.00	-23.95	peak

Test Mode:	802.11b	Frequency(MHz):	2462
Polarity:	Vertical	Test Voltage:	DC 12 V

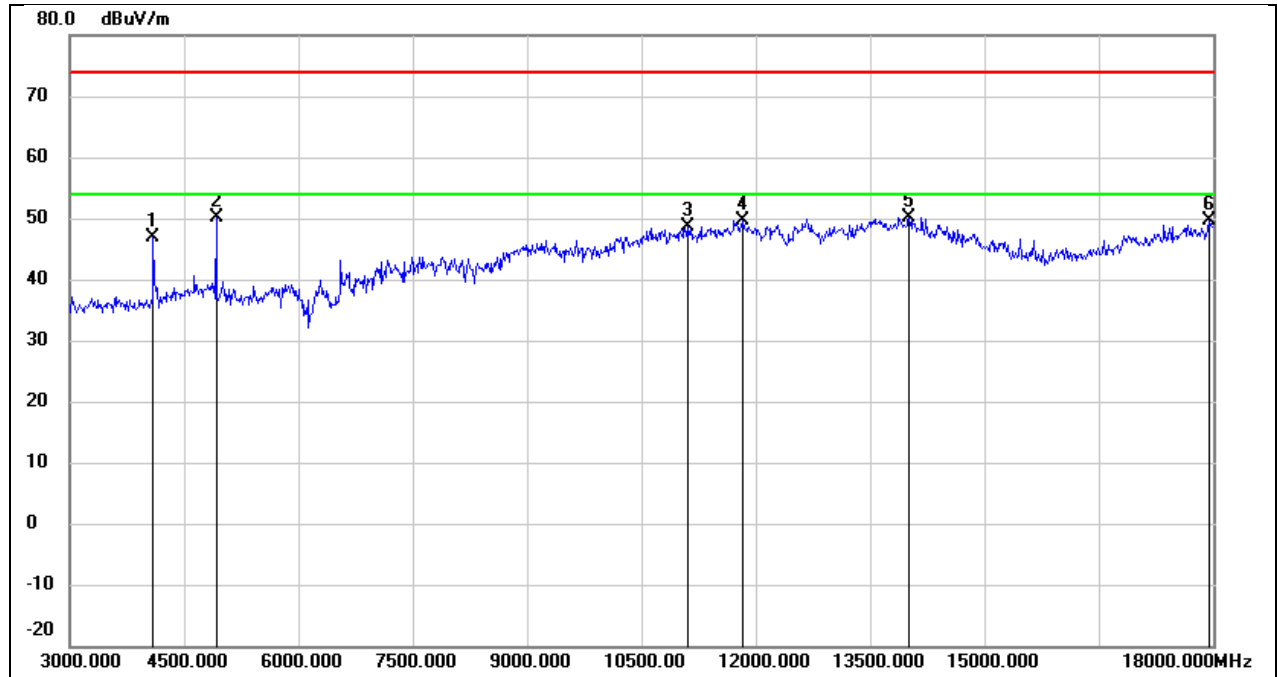

No.	Frequency (MHz)	Reading (dBuV)	Correct (dB/m)	Result (dBuV/m)	Limit (dBuV/m)	Margin (dB)	Remark
1	4095.000	50.26	-3.35	46.91	74.00	-27.09	peak
2	4920.000	50.09	0.14	50.23	74.00	-23.77	peak
3	11100.000	33.44	15.14	48.58	74.00	-25.42	peak
4	11835.000	32.19	17.51	49.70	74.00	-24.30	peak
5	14010.000	28.28	21.93	50.21	74.00	-23.79	peak
6	17940.000	24.17	25.34	49.51	74.00	-24.49	peak

Test Mode:	802.11g	Frequency(MHz):	2412
Polarity:	Horizontal	Test Voltage:	DC 12 V

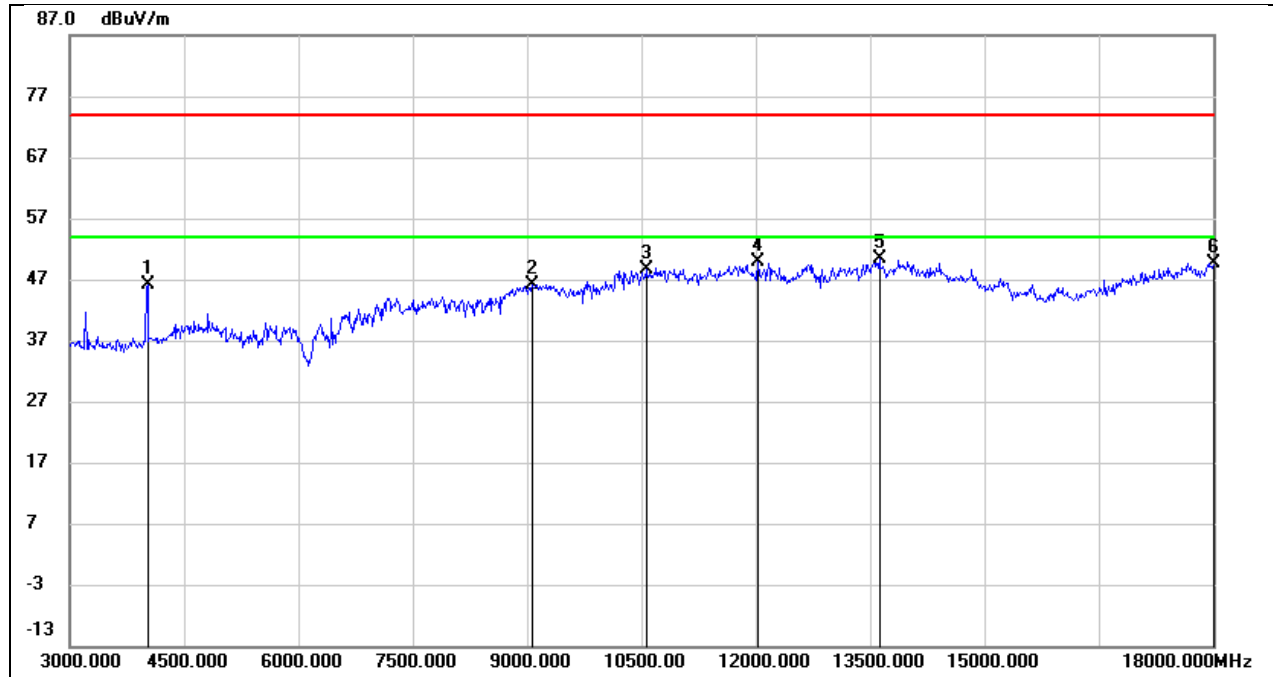

No.	Frequency (MHz)	Reading (dBuV)	Correct (dB/m)	Result (dBuV/m)	Limit (dBuV/m)	Margin (dB)	Remark
1	4020.000	49.73	-3.71	46.02	74.00	-27.98	peak
2	9060.000	35.66	10.51	46.17	74.00	-27.83	peak
3	10560.000	35.52	13.20	48.72	74.00	-25.28	peak
4	12030.000	31.84	17.94	49.78	74.00	-24.22	peak
5	13620.000	29.26	21.15	50.41	74.00	-23.59	peak
6	18000.000	23.93	25.69	49.62	74.00	-24.38	peak

Test Mode:	802.11g	Frequency(MHz):	2412
Polarity:	Vertical	Test Voltage:	DC 12 V

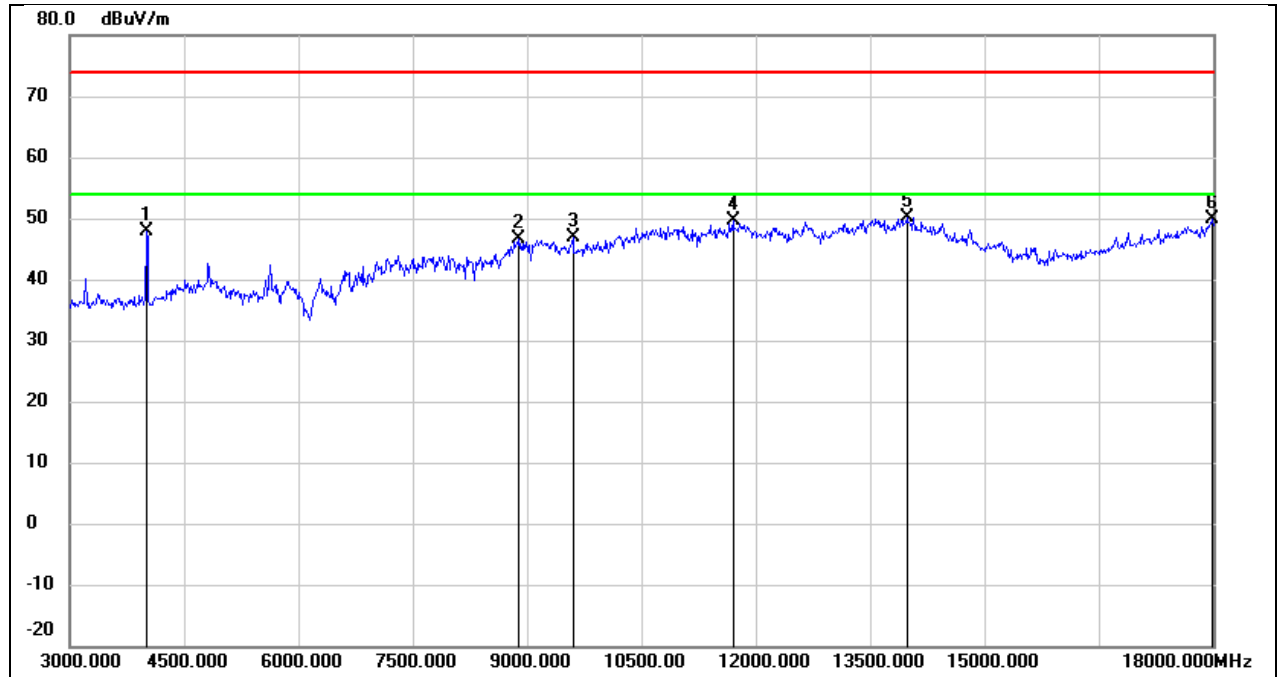

No.	Frequency (MHz)	Reading (dBuV)	Correct (dB/m)	Result (dBuV/m)	Limit (dBuV/m)	Margin (dB)	Remark
1	4005.000	51.77	-3.78	47.99	74.00	-26.01	peak
2	8895.000	36.87	9.71	46.58	74.00	-27.42	peak
3	9600.000	35.95	10.95	46.90	74.00	-27.10	peak
4	11700.000	32.51	17.14	49.65	74.00	-24.35	peak
5	13980.000	28.24	21.92	50.16	74.00	-23.84	peak
6	17985.000	24.20	25.60	49.80	74.00	-24.20	peak

Test Mode:	802.11g	Frequency(MHz):	2437
Polarity:	Horizontal	Test Voltage:	DC 12 V

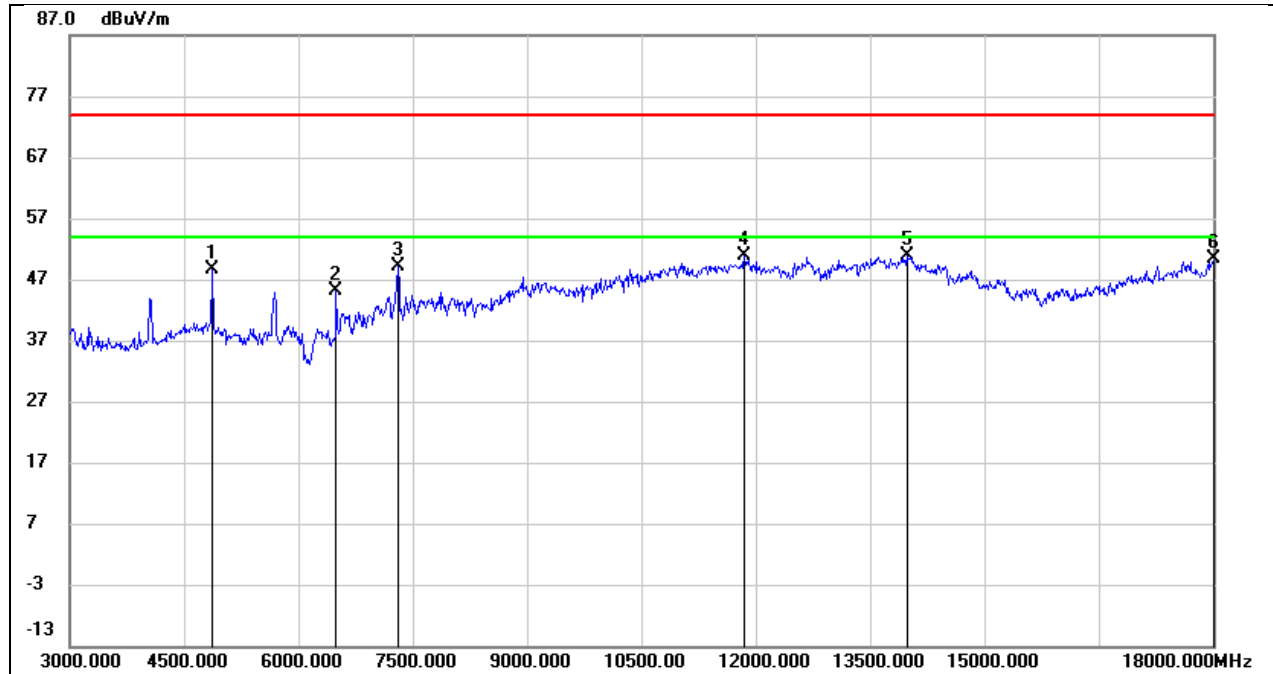

No.	Frequency (MHz)	Reading (dBuV)	Correct (dB/m)	Result (dBuV/m)	Limit (dBuV/m)	Margin (dB)	Remark
1	4875.000	48.60	-0.03	48.57	74.00	-25.43	peak
2	6495.000	40.89	4.20	45.09	74.00	-28.91	peak
3	7305.000	42.63	6.47	49.10	74.00	-24.90	peak
4	11850.000	33.24	17.56	50.80	74.00	-23.20	peak
5	13980.000	28.94	21.92	50.86	74.00	-23.14	peak
6	18000.000	24.77	25.69	50.46	74.00	-23.54	peak

Test Mode:	802.11g	Frequency(MHz):	2437
Polarity:	Vertical	Test Voltage:	DC 12 V

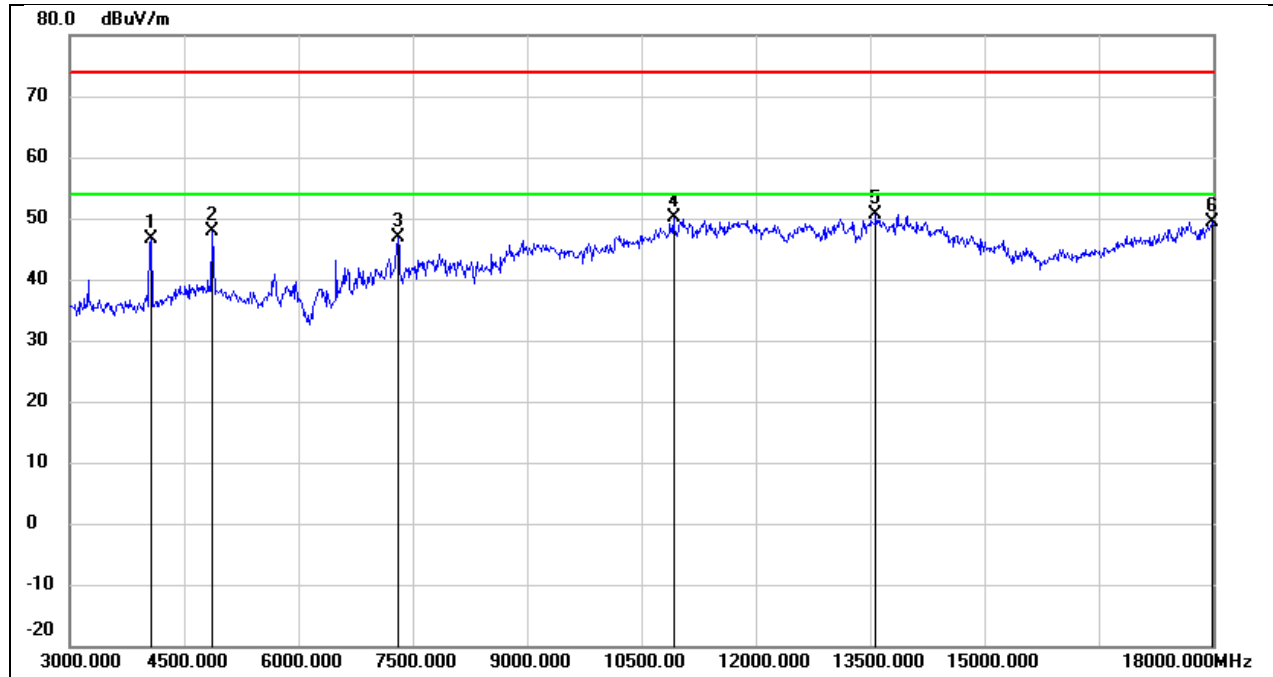

No.	Frequency (MHz)	Reading (dBuV)	Correct (dB/m)	Result (dBuV/m)	Limit (dBuV/m)	Margin (dB)	Remark
1	4065.000	50.22	-3.49	46.73	74.00	-27.27	peak
2	4860.000	48.08	-0.09	47.99	74.00	-26.01	peak
3	7305.000	40.40	6.47	46.87	74.00	-27.13	peak
4	10920.000	35.62	14.49	50.11	74.00	-23.89	peak
5	13575.000	29.50	21.06	50.56	74.00	-23.44	peak
6	17985.000	23.85	25.60	49.45	74.00	-24.55	peak

Test Mode:	802.11g	Frequency(MHz):	2462
Polarity:	Horizontal	Test Voltage:	DC 12 V

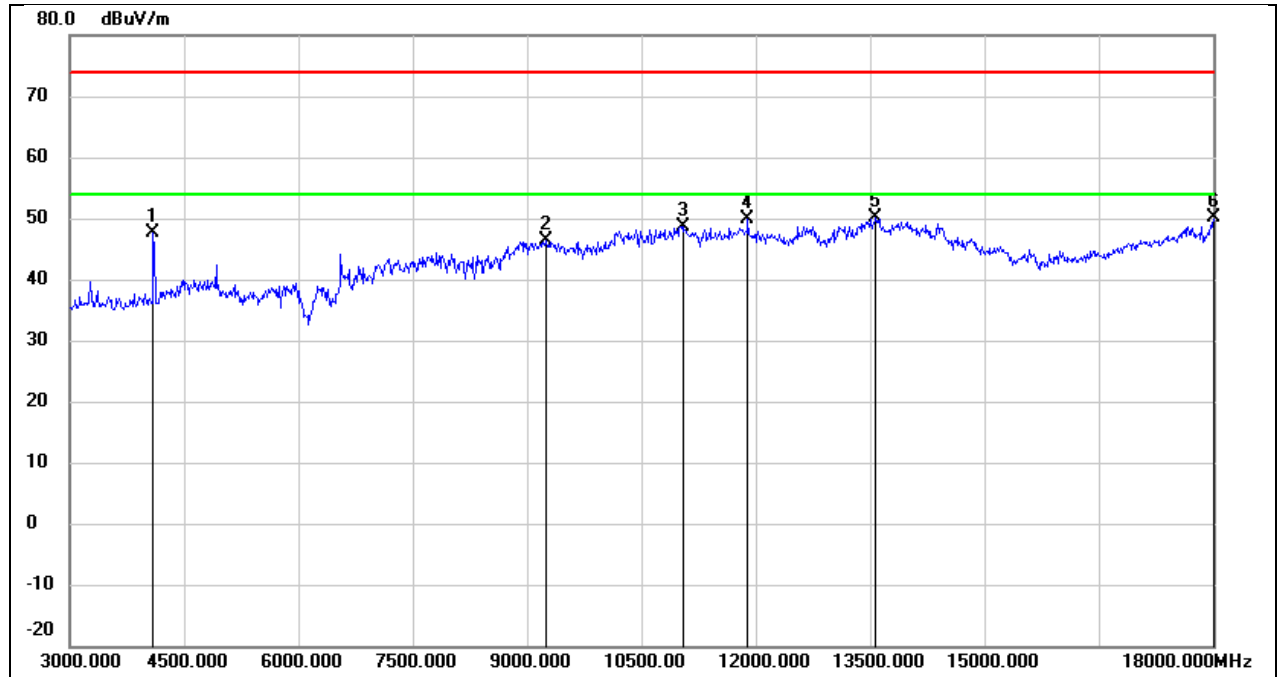

No.	Frequency (MHz)	Reading (dBuV)	Correct (dB/m)	Result (dBuV/m)	Limit (dBuV/m)	Margin (dB)	Remark
1	4095.000	50.90	-3.35	47.55	74.00	-26.45	peak
2	9240.000	35.76	10.58	46.34	74.00	-27.66	peak
3	11055.000	33.77	14.96	48.73	74.00	-25.27	peak
4	11895.000	32.26	17.68	49.94	74.00	-24.06	peak
5	13575.000	29.03	21.06	50.09	74.00	-23.91	peak
6	18000.000	24.51	25.69	50.20	74.00	-23.80	peak

Test Mode:	802.11g	Frequency(MHz):	2462
Polarity:	Vertical	Test Voltage:	DC 12 V

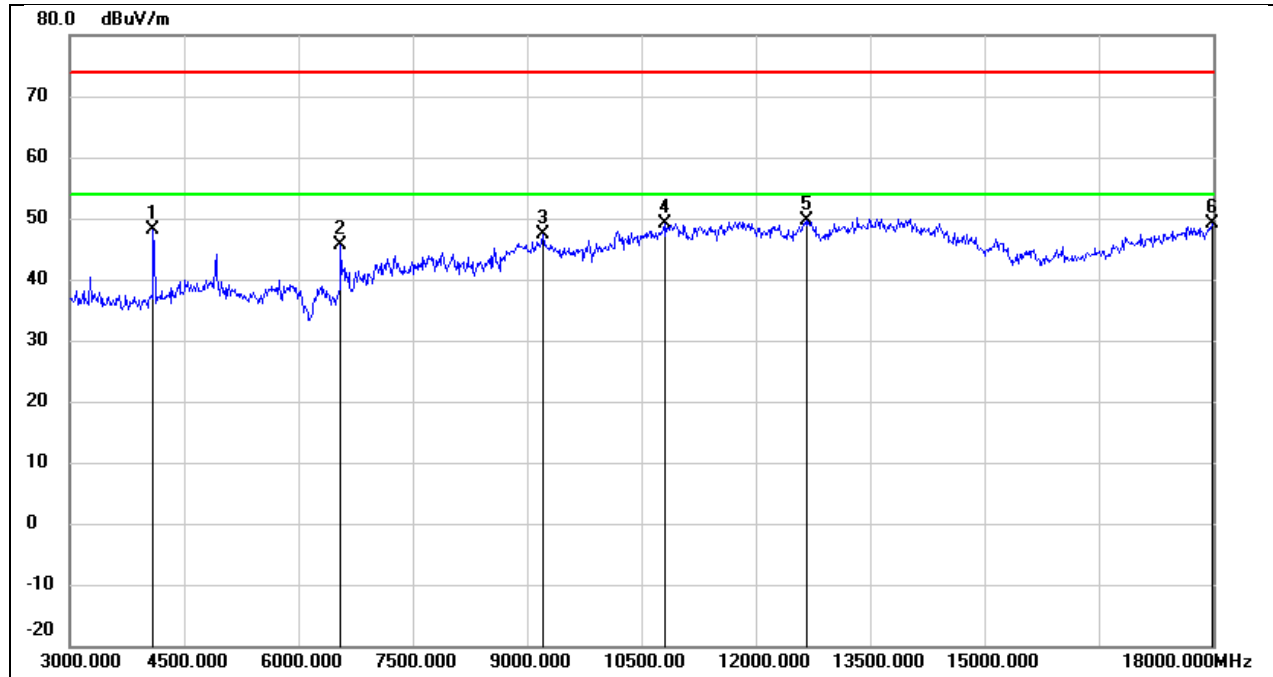

No.	Frequency (MHz)	Reading (dBuV)	Correct (dB/m)	Result (dBuV/m)	Limit (dBuV/m)	Margin (dB)	Remark
1	4095.000	51.45	-3.35	48.10	74.00	-25.90	peak
2	6555.000	41.02	4.49	45.51	74.00	-28.49	peak
3	9210.000	36.72	10.57	47.29	74.00	-26.71	peak
4	10800.000	35.01	14.06	49.07	74.00	-24.93	peak
5	12675.000	31.53	17.99	49.52	74.00	-24.48	peak
6	17985.000	23.65	25.60	49.25	74.00	-24.75	peak

Test Mode:	802.11n HT20	Frequency(MHz):	2412
Polarity:	Horizontal	Test Voltage:	DC 12 V

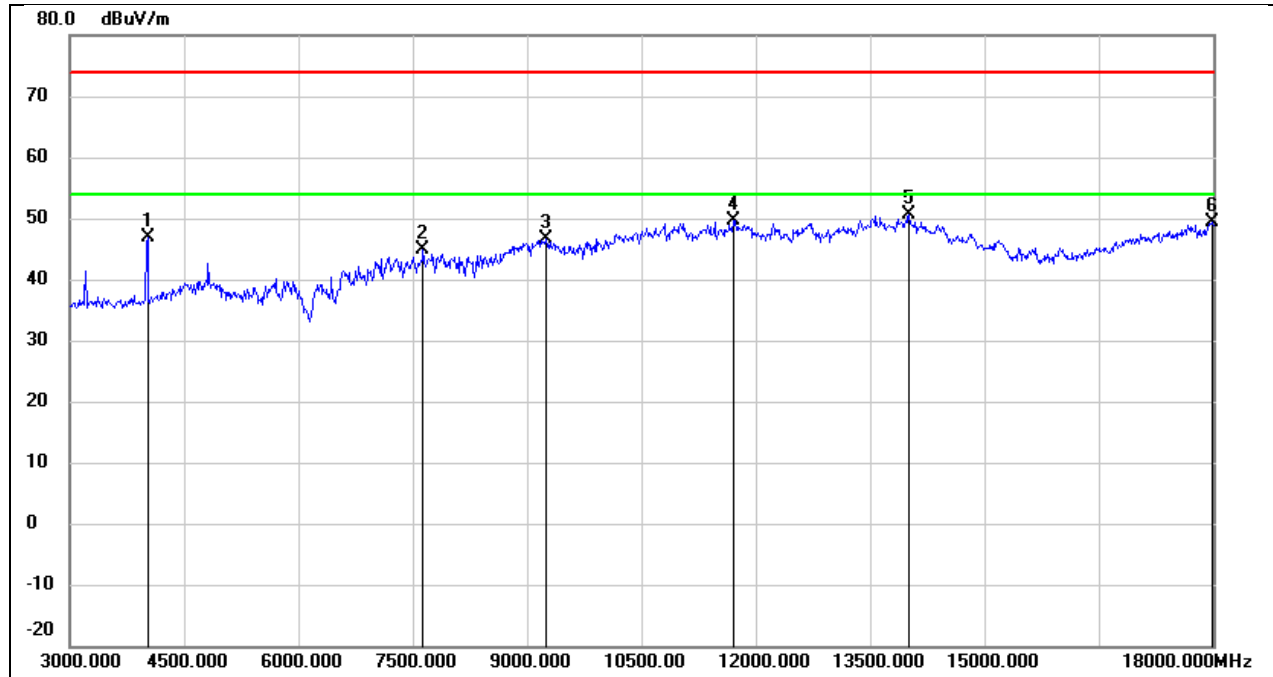

No.	Frequency (MHz)	Reading (dBuV)	Correct (dB/m)	Result (dBuV/m)	Limit (dBuV/m)	Margin (dB)	Remark
1	4020.000	50.64	-3.71	46.93	74.00	-27.07	peak
2	7635.000	38.57	6.33	44.90	74.00	-29.10	peak
3	9240.000	35.97	10.58	46.55	74.00	-27.45	peak
4	11700.000	32.47	17.14	49.61	74.00	-24.39	peak
5	14010.000	28.66	21.93	50.59	74.00	-23.41	peak
6	17985.000	23.69	25.60	49.29	74.00	-24.71	peak

Test Mode:	802.11n HT20	Frequency(MHz):	2412
Polarity:	Vertical	Test Voltage:	DC 12 V

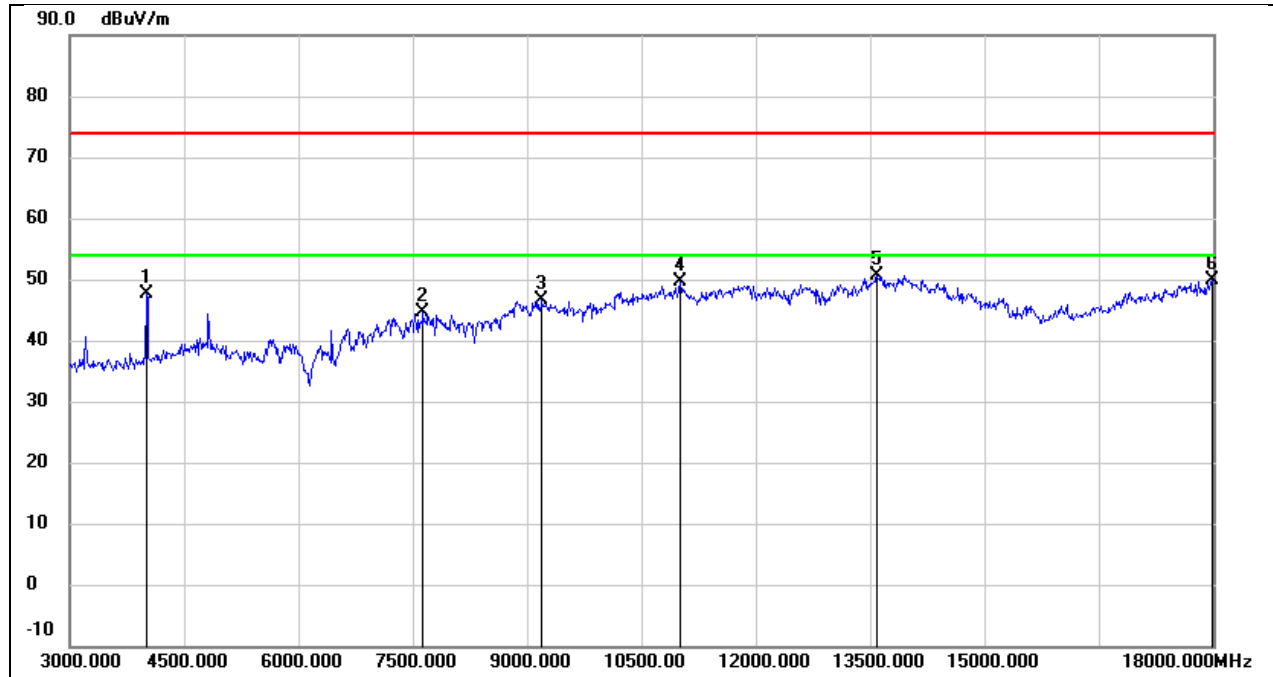

No.	Frequency (MHz)	Reading (dBuV)	Correct (dB/m)	Result (dBuV/m)	Limit (dBuV/m)	Margin (dB)	Remark
1	4005.000	51.48	-3.78	47.70	74.00	-26.30	peak
2	7635.000	38.36	6.33	44.69	74.00	-29.31	peak
3	9195.000	36.09	10.56	46.65	74.00	-27.35	peak
4	11010.000	34.89	14.81	49.70	74.00	-24.30	peak
5	13590.000	29.57	21.09	50.66	74.00	-23.34	peak
6	17985.000	24.32	25.60	49.92	74.00	-24.08	peak

Test Mode:	802.11n HT20	Frequency(MHz):	2437
Polarity:	Horizontal	Test Voltage:	DC 12 V

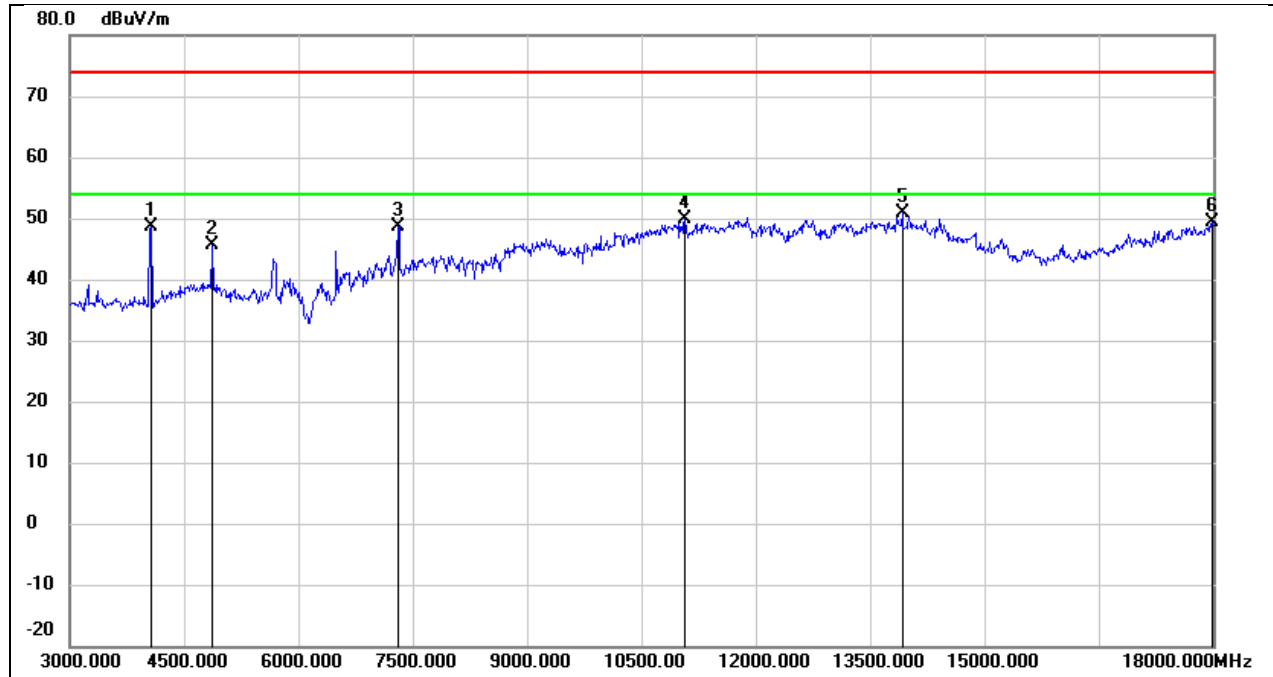

No.	Frequency (MHz)	Reading (dBuV)	Correct (dB/m)	Result (dBuV/m)	Limit (dBuV/m)	Margin (dB)	Remark
1	4065.000	52.16	-3.49	48.67	74.00	-25.33	peak
2	4875.000	45.60	-0.03	45.57	74.00	-28.43	peak
3	7305.000	42.27	6.47	48.74	74.00	-25.26	peak
4	11070.000	34.81	15.03	49.84	74.00	-24.16	peak
5	13920.000	29.07	21.79	50.86	74.00	-23.14	peak
6	17985.000	23.67	25.60	49.27	74.00	-24.73	peak

Test Mode:	802.11n HT20	Frequency(MHz):	2437
Polarity:	Vertical	Test Voltage:	DC 12 V

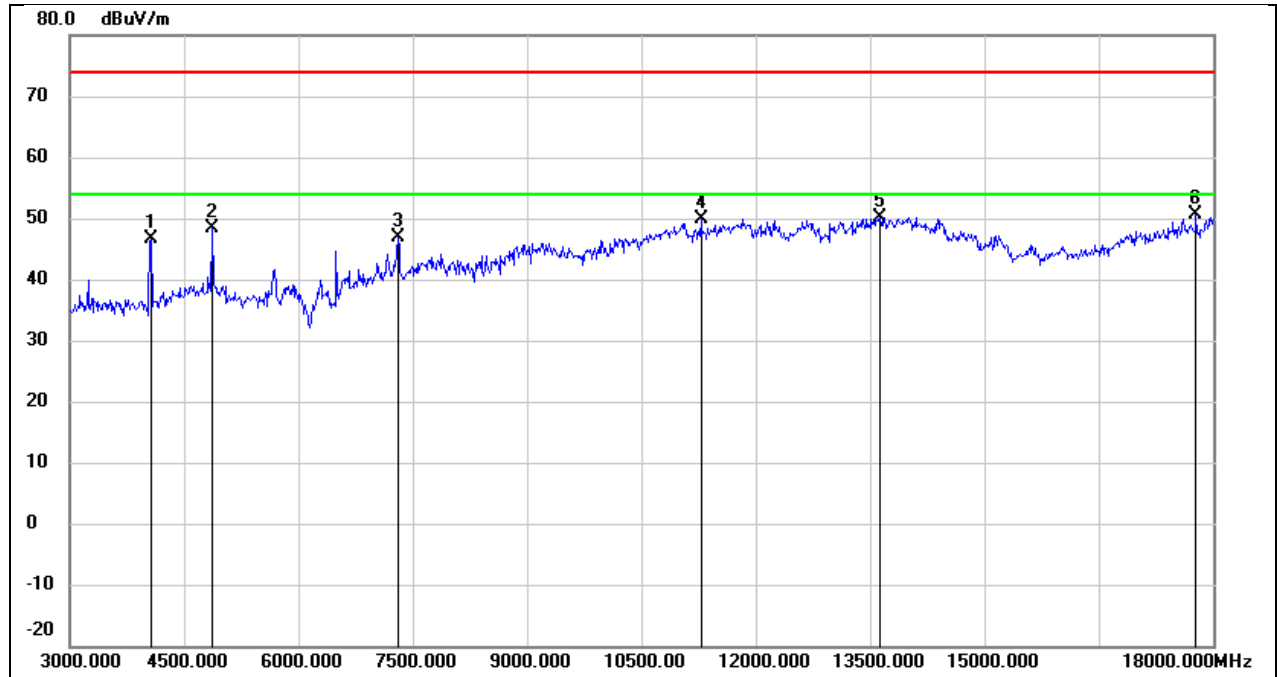

No.	Frequency (MHz)	Reading (dBuV)	Correct (dB/m)	Result (dBuV/m)	Limit (dBuV/m)	Margin (dB)	Remark
1	4065.000	50.02	-3.49	46.53	74.00	-27.47	peak
2	4875.000	48.35	-0.03	48.32	74.00	-25.68	peak
3	7305.000	40.52	6.47	46.99	74.00	-27.01	peak
4	11280.000	34.01	15.80	49.81	74.00	-24.19	peak
5	13620.000	29.04	21.15	50.19	74.00	-23.81	peak
6	17775.000	26.22	24.36	50.58	74.00	-23.42	peak

Test Mode:	802.11n HT20	Frequency(MHz):	2462
Polarity:	Horizontal	Test Voltage:	DC 12 V

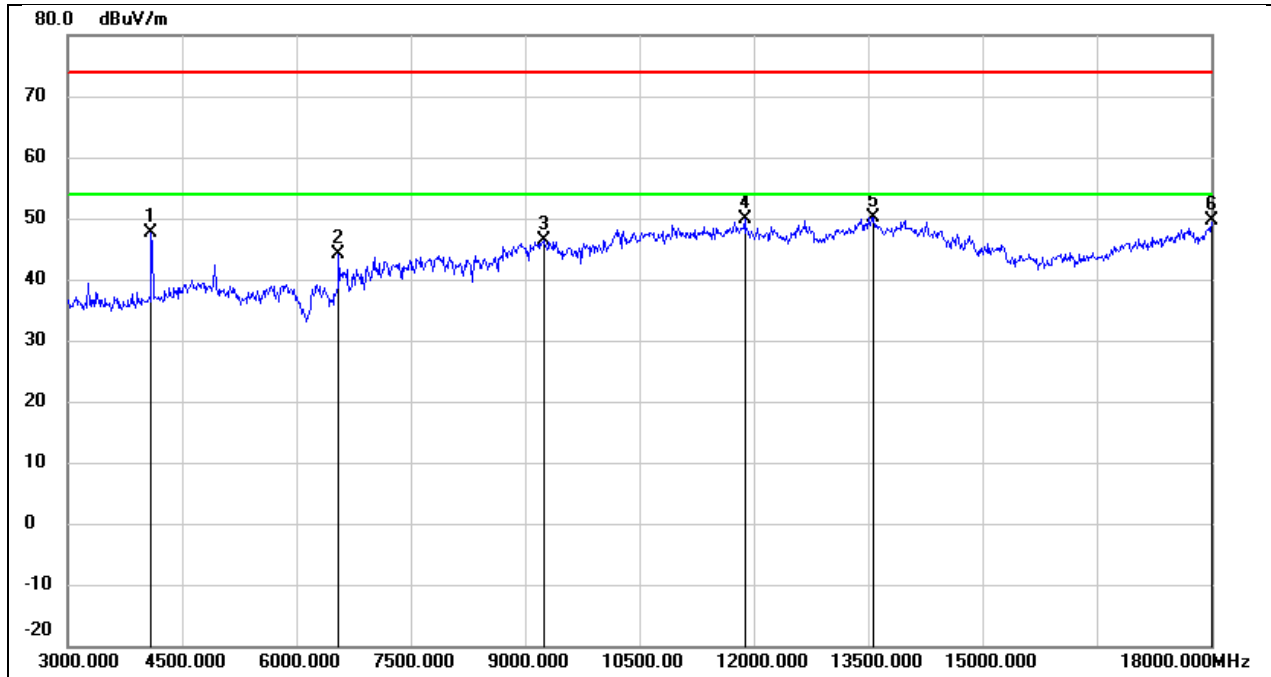

No.	Frequency (MHz)	Reading (dBuV)	Correct (dB/m)	Result (dBuV/m)	Limit (dBuV/m)	Margin (dB)	Remark
1	4095.000	50.92	-3.35	47.57	74.00	-26.43	peak
2	6555.000	39.61	4.49	44.10	74.00	-29.90	peak
3	9240.000	35.78	10.58	46.36	74.00	-27.64	peak
4	11880.000	32.13	17.63	49.76	74.00	-24.24	peak
5	13575.000	29.12	21.06	50.18	74.00	-23.82	peak
6	18000.000	23.98	25.69	49.67	74.00	-24.33	peak

Test Mode:	802.11n HT20	Frequency(MHz):	2462
Polarity:	Vertical	Test Voltage:	DC 12 V

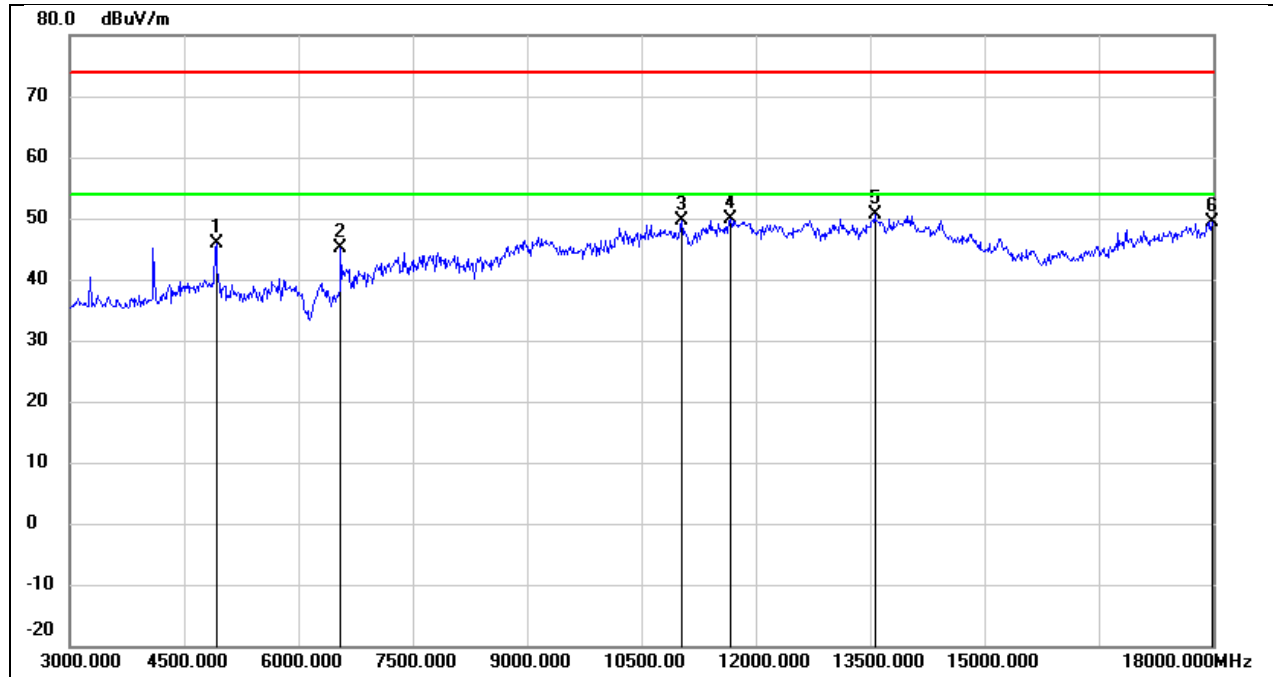

No.	Frequency (MHz)	Reading (dBuV)	Correct (dB/m)	Result (dBuV/m)	Limit (dBuV/m)	Margin (dB)	Remark
1	4920.000	45.86	0.14	46.00	74.00	-28.00	peak
2	6555.000	40.59	4.49	45.08	74.00	-28.92	peak
3	11025.000	34.87	14.85	49.72	74.00	-24.28	peak
4	11670.000	32.77	17.07	49.84	74.00	-24.16	peak
5	13560.000	29.51	21.04	50.55	74.00	-23.45	peak
6	17985.000	23.77	25.60	49.37	74.00	-24.63	peak

8.1.4. SPURIOUS EMISSIONS(9 kHz~30 MHz)

Test Mode:	802.11b	Frequency(MHz):	2412
Polarity:	Horizontal	Test Voltage:	DC 12 V

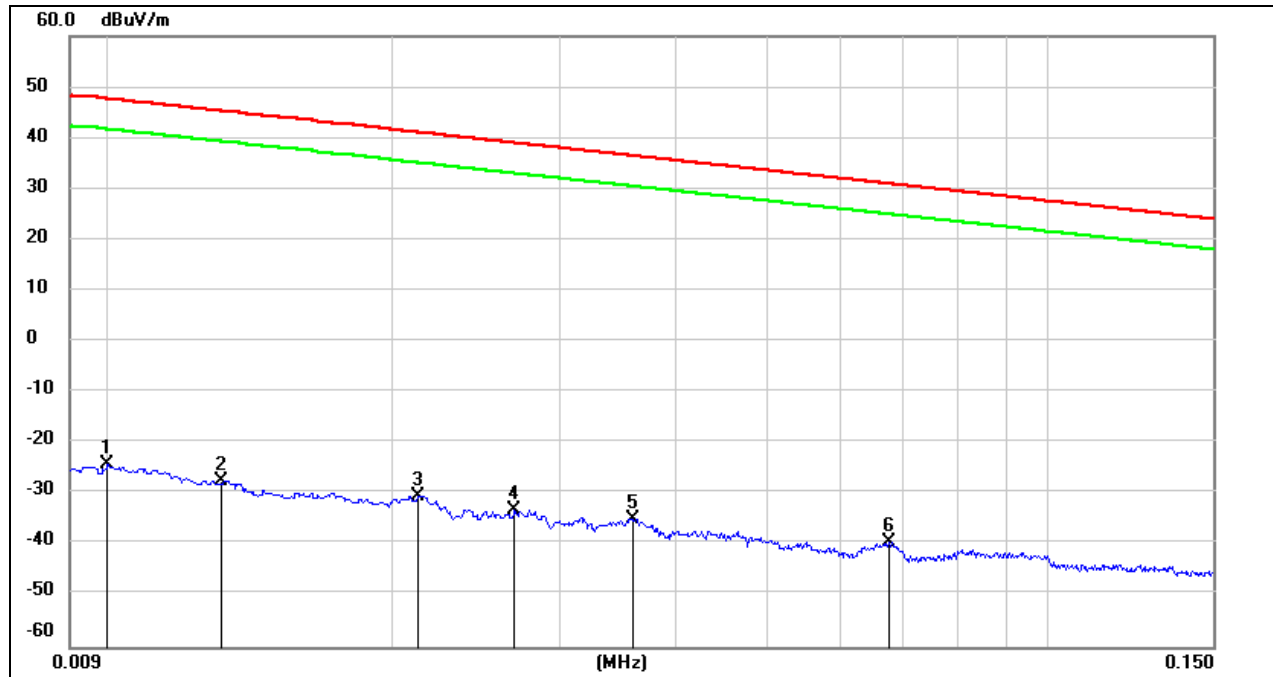

No.	Frequency (MHz)	Reading (dBuV)	Correct (dB/m)	FCC Result (dBuV/m)	FCC Limit (dBuV/m)	ISED Result (dBuA/m)	ISED Limit (dBuA/m)	Margin (dB)	Remark
1	0.01	77.22	-101.4	-24.18	47.6	-75.68	-3.9	-71.78	peak
2	0.0131	73.97	-101.38	-27.41	45.25	-78.91	-6.25	-72.66	peak
3	0.0212	71.04	-101.35	-30.31	41.07	-81.81	-10.43	-71.38	peak
4	0.0269	68.35	-101.38	-33.03	39.01	-84.53	-12.49	-72.04	peak
5	0.0359	66.56	-101.42	-34.86	36.5	-86.36	-15	-71.36	peak
6	0.0675	62.14	-101.56	-39.42	31.02	-90.92	-20.48	-70.44	peak

Test Mode:	802.11b	Frequency(MHz):	2412
Polarity:	Horizontal	Test Voltage:	DC 12 V

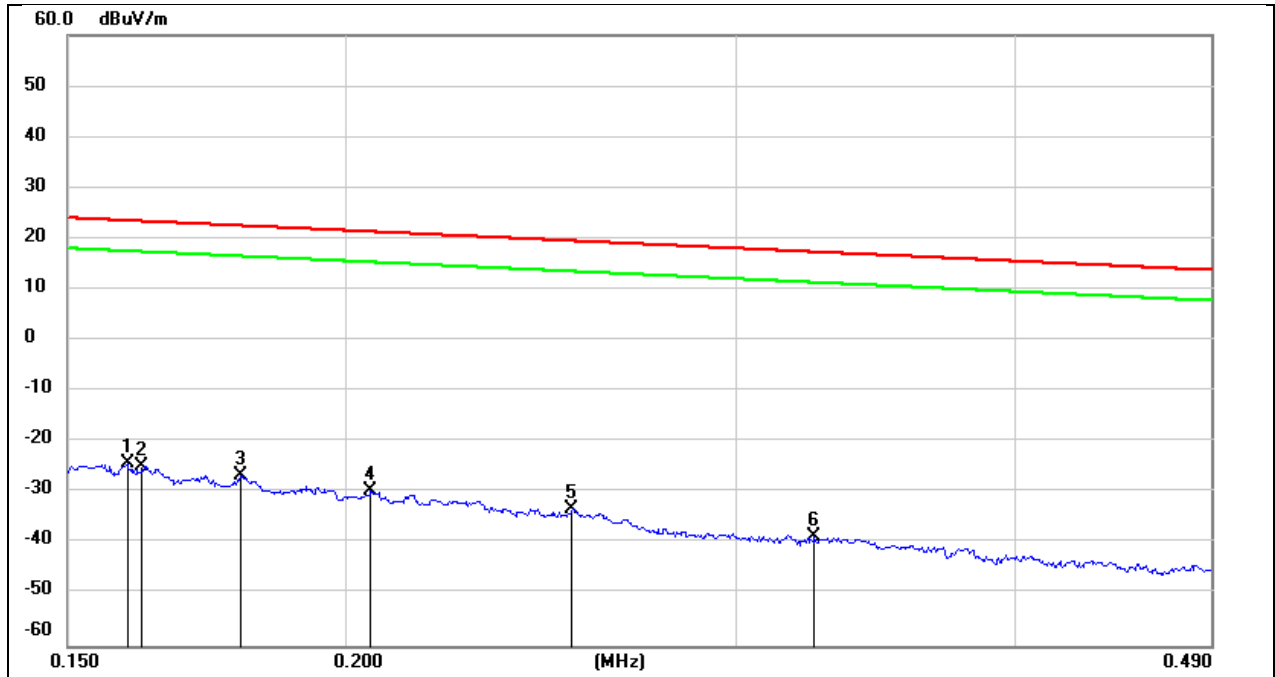

No.	Frequency (MHz)	Reading (dBuV)	Correct (dB/m)	FCC Result (dBuV/m)	FCC Limit (dBuV/m)	ISED Result (dBuA/m)	ISED Limit (dBuA/m)	Margin (dB)	Remark
1	0.1595	77.36	-101.65	-24.29	23.55	-75.79	-27.95	-47.84	peak
2	0.1621	76.92	-101.65	-24.73	23.41	-76.23	-28.09	-48.14	peak
3	0.1794	75.27	-101.68	-26.41	22.53	-77.91	-28.97	-48.94	peak
4	0.2053	72.3	-101.73	-29.43	21.35	-80.93	-30.15	-50.78	peak
5	0.253	68.64	-101.8	-33.16	19.54	-84.66	-31.96	-52.7	peak
6	0.3251	63.21	-101.88	-38.67	17.36	-90.17	-34.14	-56.03	peak

Test Mode:	802.11b	Frequency(MHz):	2412
Polarity:	Horizontal	Test Voltage:	DC 12 V

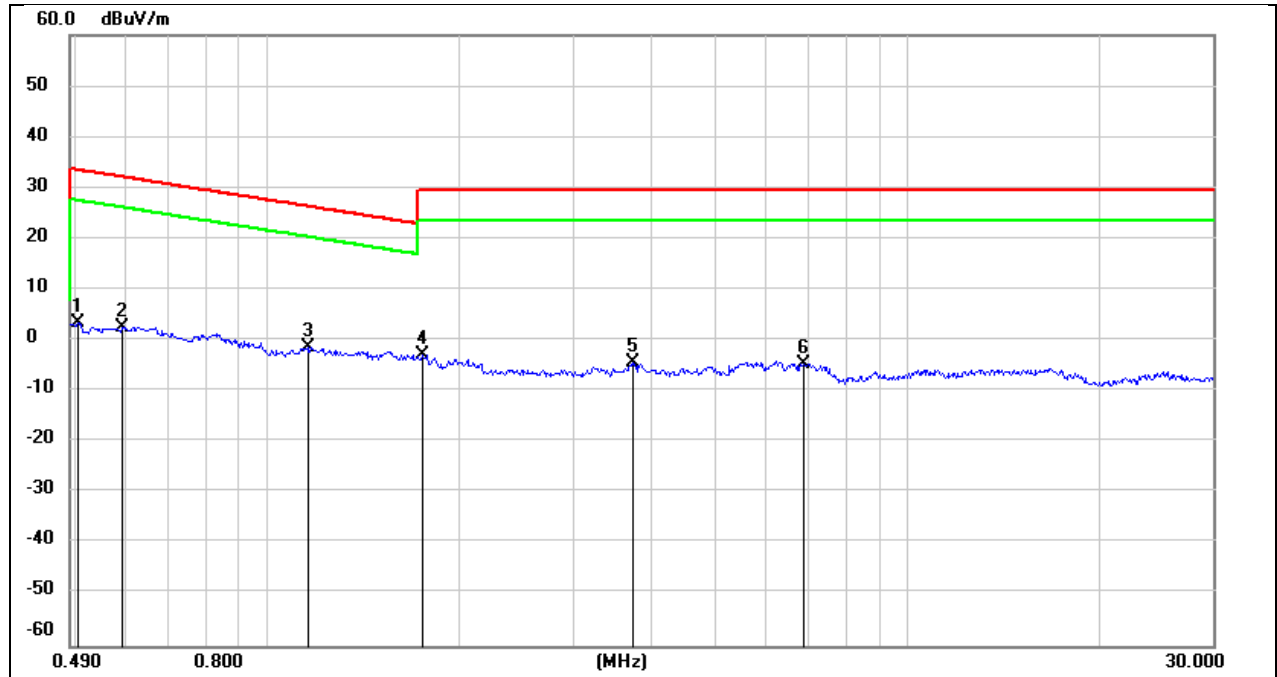

No.	Frequency (MHz)	Reading (dBuV)	Correct (dB/m)	FCC Result (dBuV/m)	FCC Limit (dBuV/m)	ISED Result (dBuA/m)	ISED Limit (dBuA/m)	Margin (dB)	Remark
1	0.5039	65.43	-62.07	3.36	33.56	-48.14	-17.94	-30.2	peak
2	0.5917	64.74	-62.08	2.66	32.16	-48.84	-19.34	-29.5	peak
3	1.1531	60.75	-62.2	-1.45	26.37	-52.95	-25.13	-27.82	peak
4	1.7473	59.06	-61.94	-2.88	29.54	-54.38	-21.96	-32.42	peak
5	3.71	57.2	-61.41	-4.21	29.54	-55.71	-21.96	-33.75	peak
6	6.8936	56.59	-61.22	-4.63	29.54	-56.13	-21.96	-34.17	peak

8.1.5. SPURIOUS EMISSIONS(18 GHz~26 GHz)

Test Mode:	802.11b	Frequency(MHz):	2412
Polarity:	Horizontal	Test Voltage:	DC 12 V

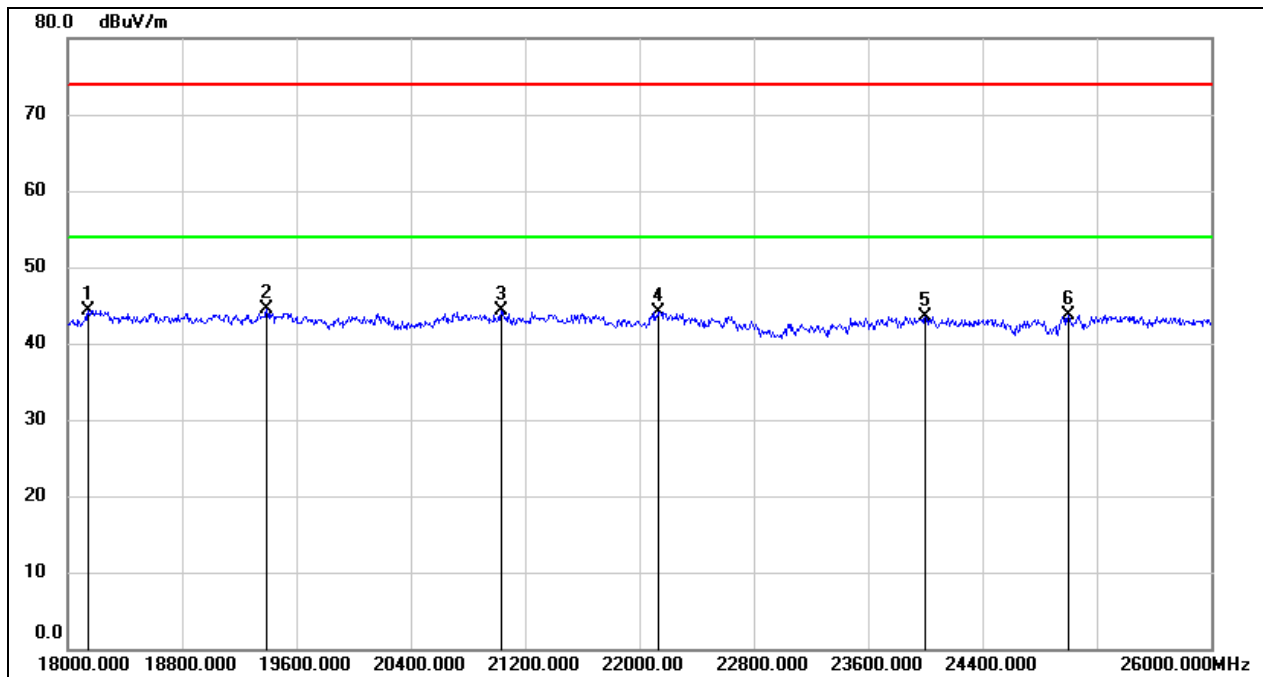

No.	Frequency (MHz)	Reading (dBuV)	Correct (dB/m)	Result (dBuV/m)	Limit (dBuV/m)	Margin (dB)	Remark
1	18144.000	49.77	-5.48	44.29	74.00	-29.71	peak
2	19392.000	50.12	-5.57	44.55	74.00	-29.45	peak
3	21032.000	49.15	-4.87	44.28	74.00	-29.72	peak
4	22136.000	48.41	-4.34	44.07	74.00	-29.93	peak
5	24000.000	46.21	-2.75	43.46	74.00	-30.54	peak
6	25000.000	45.86	-2.10	43.76	74.00	-30.24	peak

Test Mode:	802.11b	Frequency(MHz):	2412
Polarity:	Vertical	Test Voltage:	DC 12 V

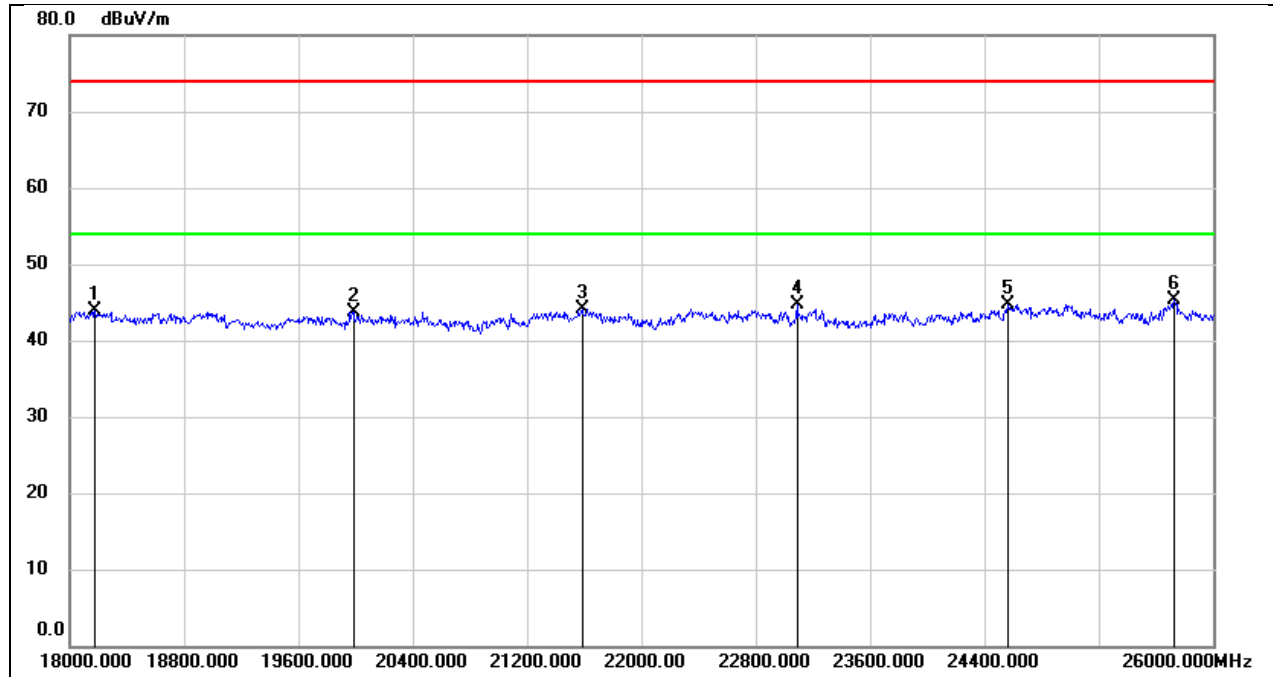

No.	Frequency (MHz)	Reading (dBuV)	Correct (dB/m)	Result (dBuV/m)	Limit (dBuV/m)	Margin (dB)	Remark
1	18176.000	49.40	-5.51	43.89	74.00	-30.11	peak
2	19984.000	49.21	-5.44	43.77	74.00	-30.23	peak
3	21584.000	48.60	-4.56	44.04	74.00	-29.96	peak
4	23088.000	48.02	-3.41	44.61	74.00	-29.39	peak
5	24568.000	47.10	-2.33	44.77	74.00	-29.23	peak
6	25728.000	46.11	-0.72	45.39	74.00	-28.61	peak

8.1.6. SPURIOUS EMISSIONS(30 MHz~1 GHz)

Test Mode:	802.11b	Frequency(MHz):	2412
Polarity:	Horizontal	Test Voltage:	DC12V

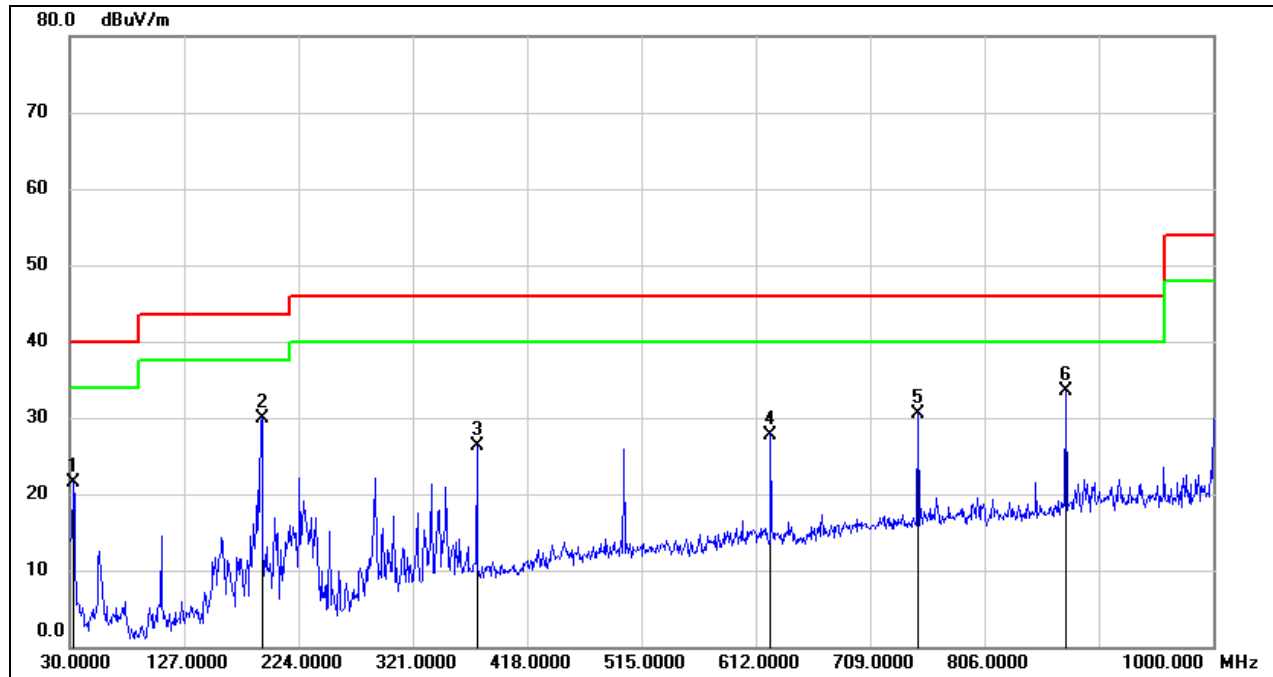

No.	Frequency (MHz)	Reading (dBuV)	Correct (dB/m)	Result (dBuV/m)	Limit (dBuV/m)	Margin (dB)	Remark
1	32.9100	40.11	-18.69	21.42	40.00	-18.58	QP
2	192.9600	46.57	-16.66	29.91	43.50	-13.59	QP
3	375.3200	39.16	-12.92	26.24	46.00	-19.76	QP
4	624.6100	37.23	-9.43	27.80	46.00	-18.20	QP
5	749.7400	37.56	-7.14	30.42	46.00	-15.58	QP
6	874.8700	38.90	-5.44	33.46	46.00	-12.54	QP

Test Mode:	802.11b	Frequency(MHz):	2412
Polarity:	Vertical	Test Voltage:	DC12V

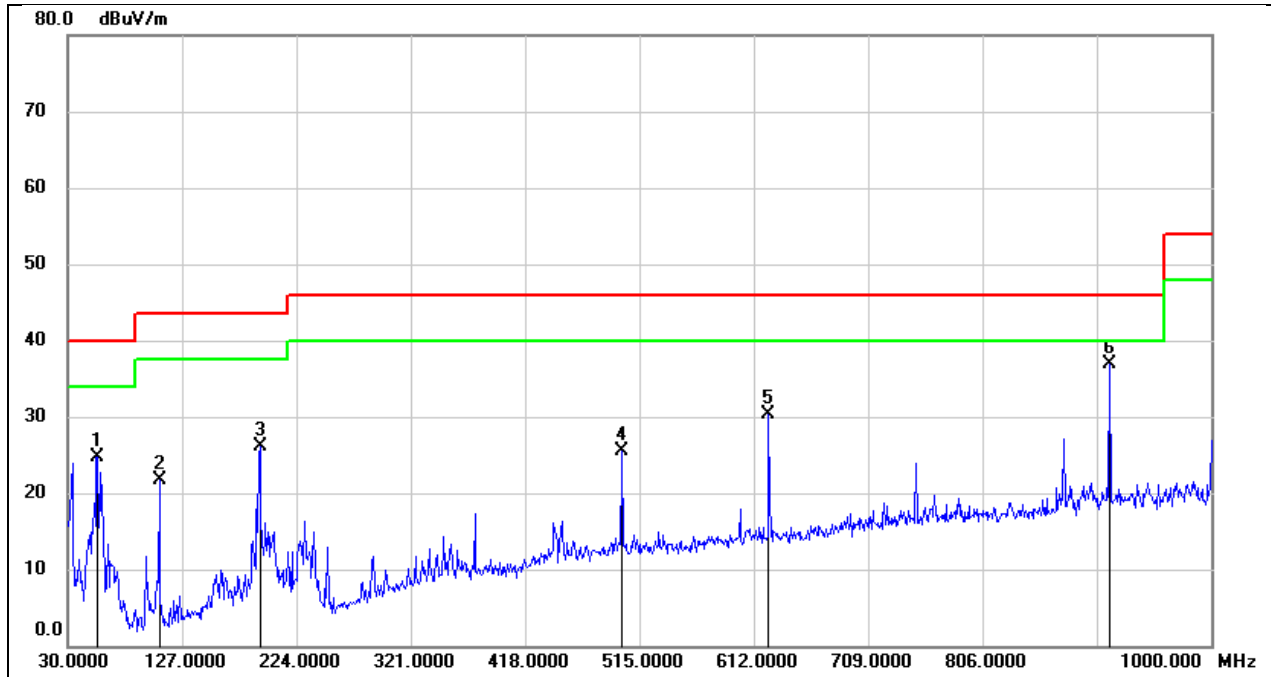

No.	Frequency (MHz)	Reading (dBuV)	Correct (dB/m)	Result (dBuV/m)	Limit (dBuV/m)	Margin (dB)	Remark
1	55.2200	45.11	-20.43	24.68	40.00	-15.32	QP
2	107.6000	42.13	-20.52	21.61	43.50	-21.89	QP
3	192.9600	42.80	-16.66	26.14	43.50	-17.36	QP
4	500.4500	36.23	-10.67	25.56	46.00	-20.44	QP
5	624.6100	39.83	-9.43	30.40	46.00	-15.60	QP
6	913.6700	41.66	-4.67	36.99	46.00	-9.01	QP

8.2. FOR INTERNAL ANTENNA DATA

8.2.1. RESTRICTED BANDEGE

Test Mode:	802.11b PK	Frequency(MHz):	2412
Polarity:	Horizontal	Test Voltage:	DC 12 V

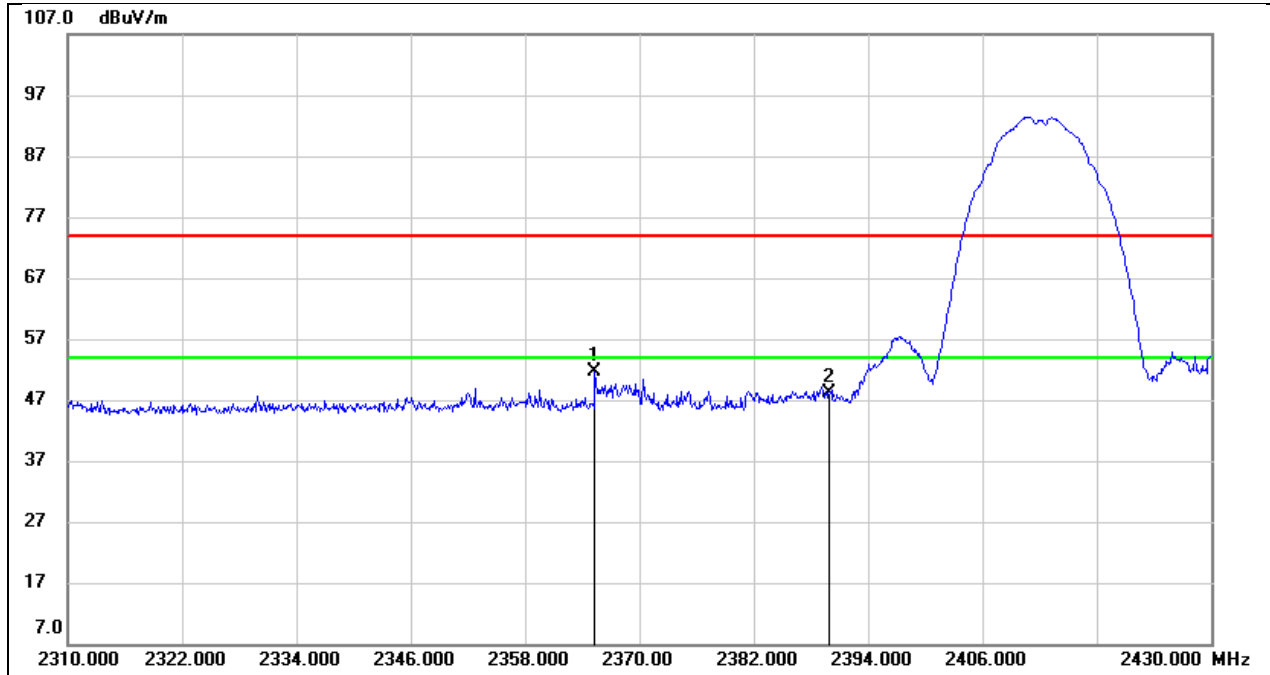

No.	Frequency (MHz)	Reading (dBuV)	Correct (dB/m)	Result (dBuV/m)	Limit (dBuV/m)	Margin (dB)	Remark
1	2365.320	19.61	32.09	51.70	74.00	-22.30	peak
2	2390.000	15.99	32.16	48.15	74.00	-25.85	peak

Test Mode:	802.11b PK	Frequency(MHz):	2412
Polarity:	Vertical	Test Voltage:	DC 12 V

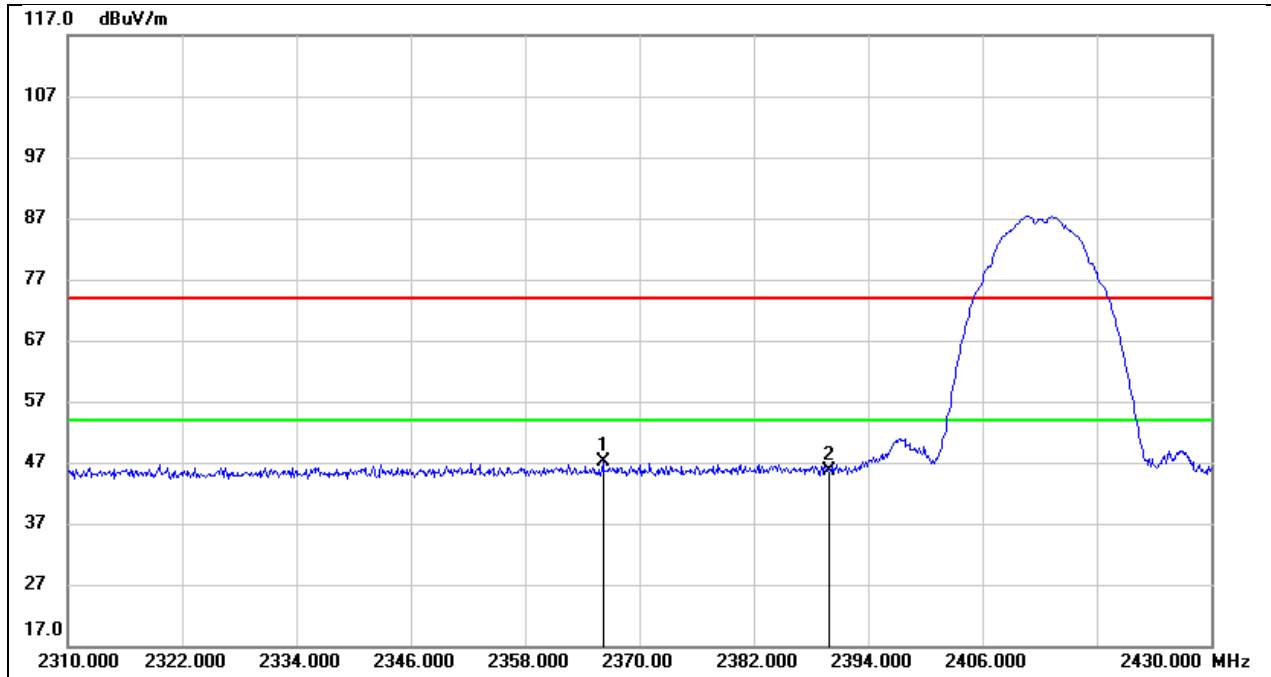

No.	Frequency (MHz)	Reading (dBuV)	Correct (dB/m)	Result (dBuV/m)	Limit (dBuV/m)	Margin (dB)	Remark
1	2366.160	14.98	32.09	47.07	74.00	-26.93	peak
2	2390.000	13.39	32.16	45.55	74.00	-28.45	peak

Test Mode:	802.11b PK	Frequency(MHz):	2462
Polarity:	Horizontal	Test Voltage:	DC 12 V

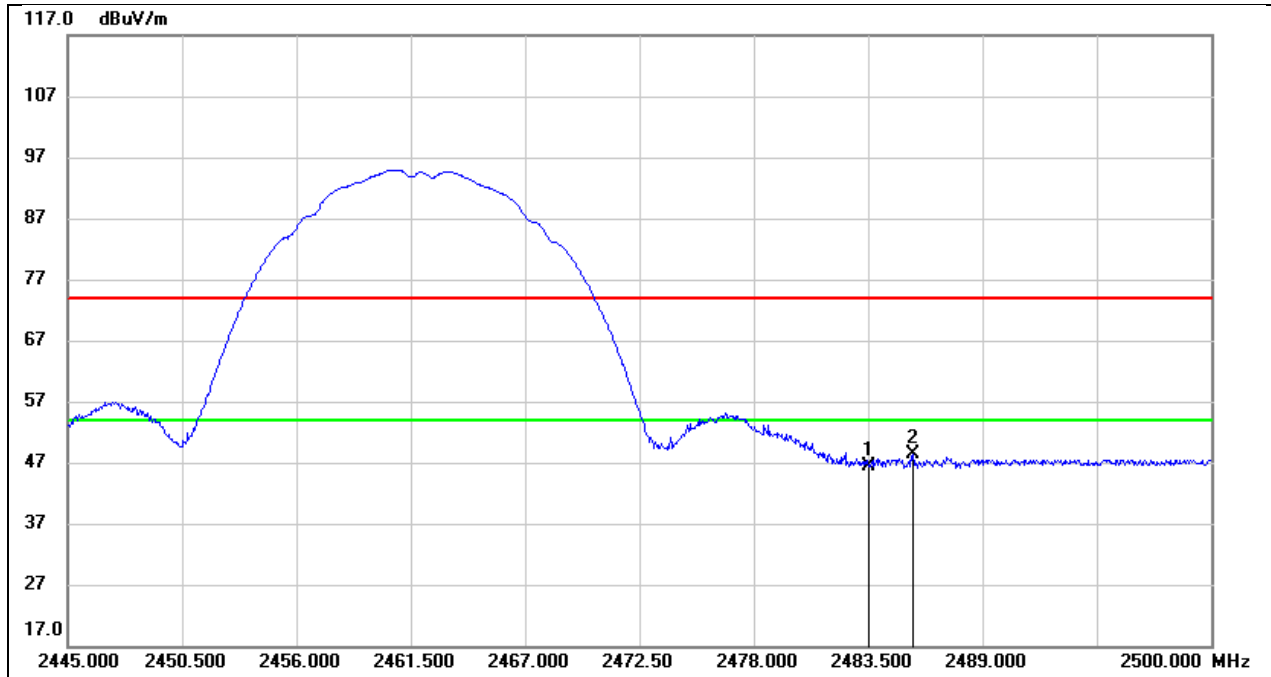

No.	Frequency (MHz)	Reading (dBuV)	Correct (dB/m)	Result (dBuV/m)	Limit (dBuV/m)	Margin (dB)	Remark
1	2483.500	13.95	32.44	46.39	74.00	-27.61	peak
2	2485.645	15.97	32.44	48.41	74.00	-25.59	peak

Test Mode:	802.11g PK	Frequency(MHz):	2412
Polarity:	Horizontal	Test Voltage:	DC 12 V

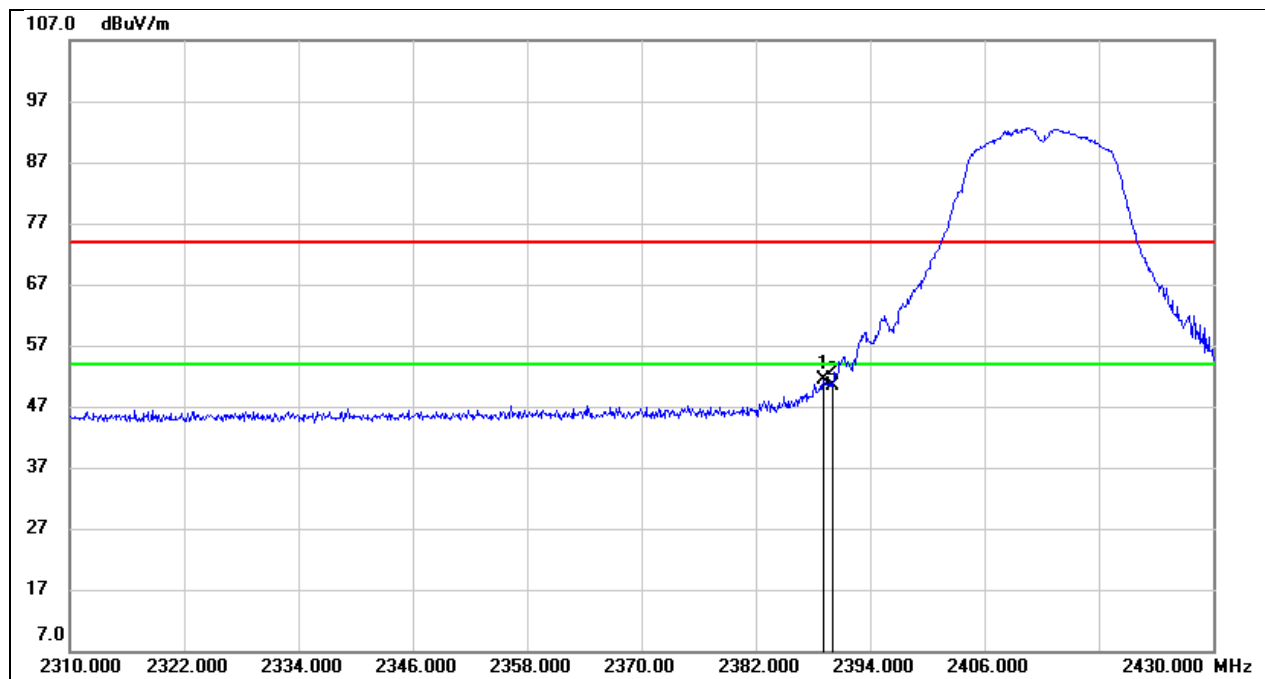

No.	Frequency (MHz)	Reading (dBuV)	Correct (dB/m)	Result (dBuV/m)	Limit (dBuV/m)	Margin (dB)	Remark
1	2389.080	19.16	32.16	51.32	74.00	-22.68	peak
2	2390.000	18.28	32.16	50.44	74.00	-23.56	peak

Test Mode:	802.11g PK	Frequency(MHz):	2462
Polarity:	Horizontal	Test Voltage:	DC 12 V

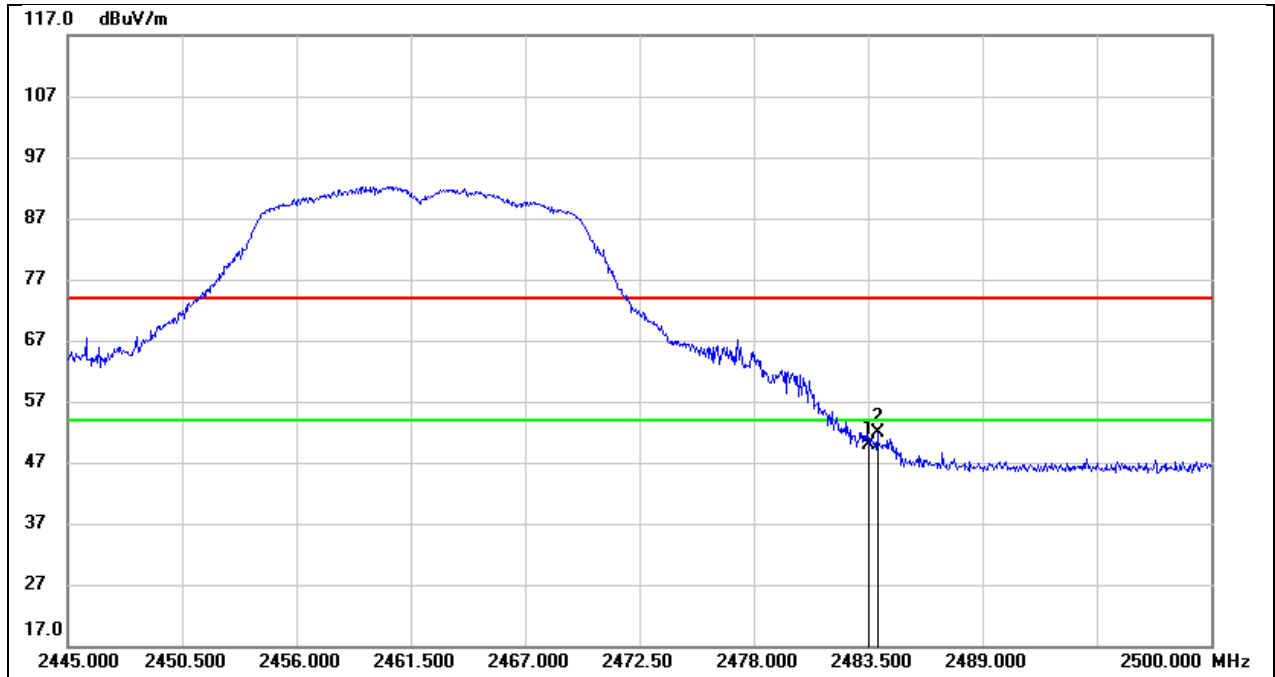

No.	Frequency (MHz)	Reading (dBuV)	Correct (dB/m)	Result (dBuV/m)	Limit (dBuV/m)	Margin (dB)	Remark
1	2483.500	17.41	32.44	49.85	74.00	-24.15	peak
2	2483.940	19.49	32.44	51.93	74.00	-22.07	peak

Test Mode:	802.11n HT20 PK	Frequency(MHz):	2412
Polarity:	Horizontal	Test Voltage:	DC 12 V

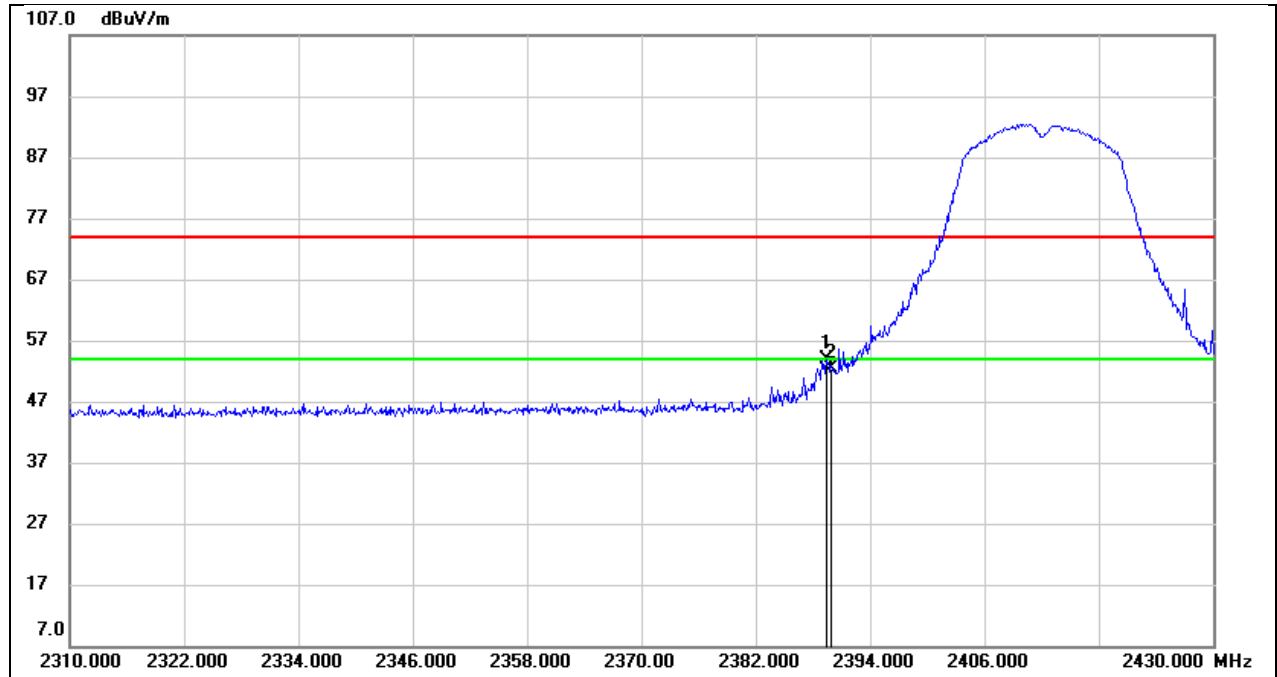

No.	Frequency (MHz)	Reading (dBuV)	Correct (dB/m)	Result (dBuV/m)	Limit (dBuV/m)	Margin (dB)	Remark
1	2389.440	21.78	32.16	53.94	74.00	-20.06	peak
2	2390.000	20.27	32.16	52.43	74.00	-21.57	peak

Test Mode:	802.11n HT20 AV	Frequency(MHz):	2412
Polarity:	Horizontal	Test Voltage:	DC 12 V

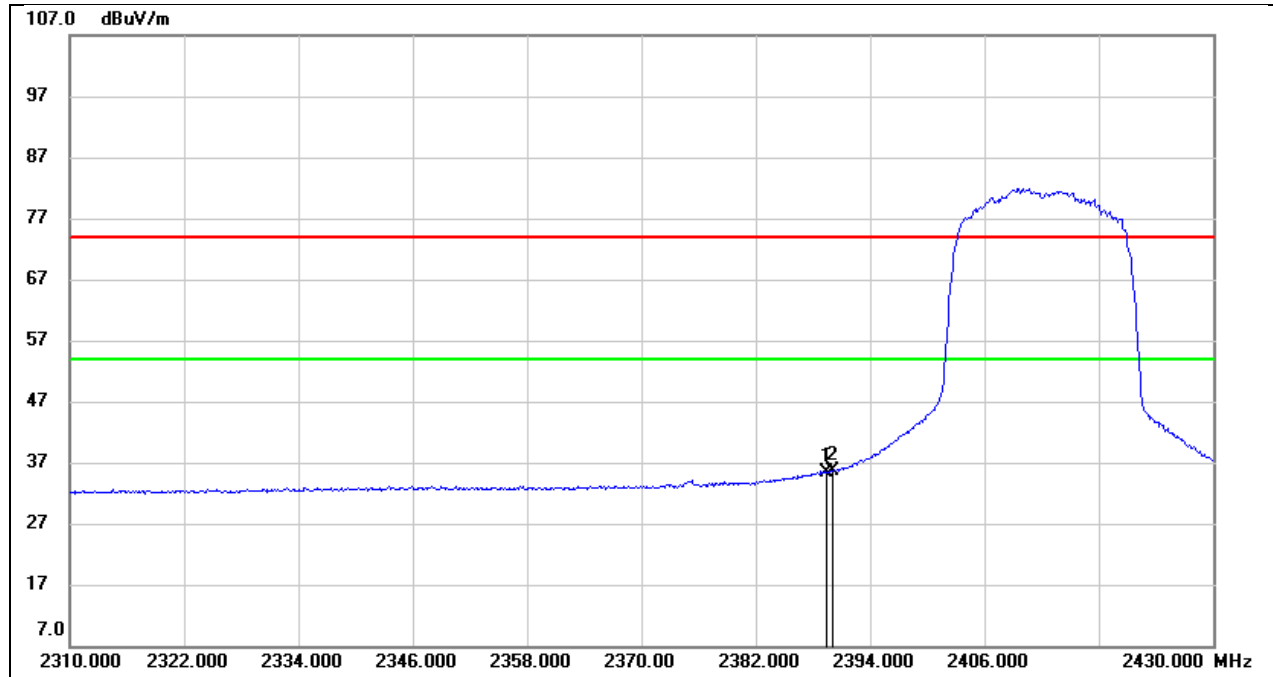

No.	Frequency (MHz)	Reading (dBuV)	Correct (dB/m)	Result (dBuV/m)	Limit (dBuV/m)	Margin (dB)	Remark
1	2389.440	3.18	32.16	35.34	54.00	-18.66	AVG
2	2390.000	3.58	32.16	35.74	54.00	-18.26	AVG

Test Mode:	802.11n HT20 PK	Frequency(MHz):	2462
Polarity:	Horizontal	Test Voltage:	DC 12 V

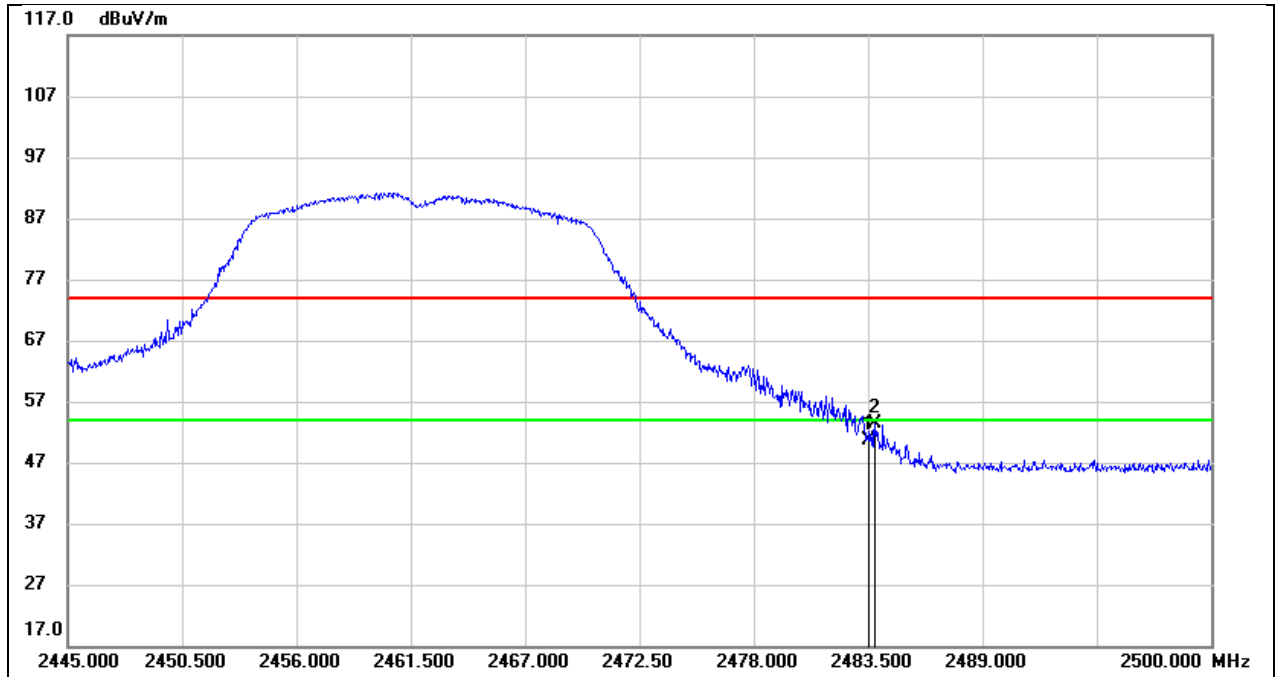

No.	Frequency (MHz)	Reading (dBuV)	Correct (dB/m)	Result (dBuV/m)	Limit (dBuV/m)	Margin (dB)	Remark
1	2483.500	18.14	32.44	50.58	74.00	-23.42	peak
2	2483.830	20.90	32.44	53.34	74.00	-20.66	peak

Test Mode:	802.11n HT20 AV	Frequency(MHz):	2462
Polarity:	Horizontal	Test Voltage:	DC 12 V

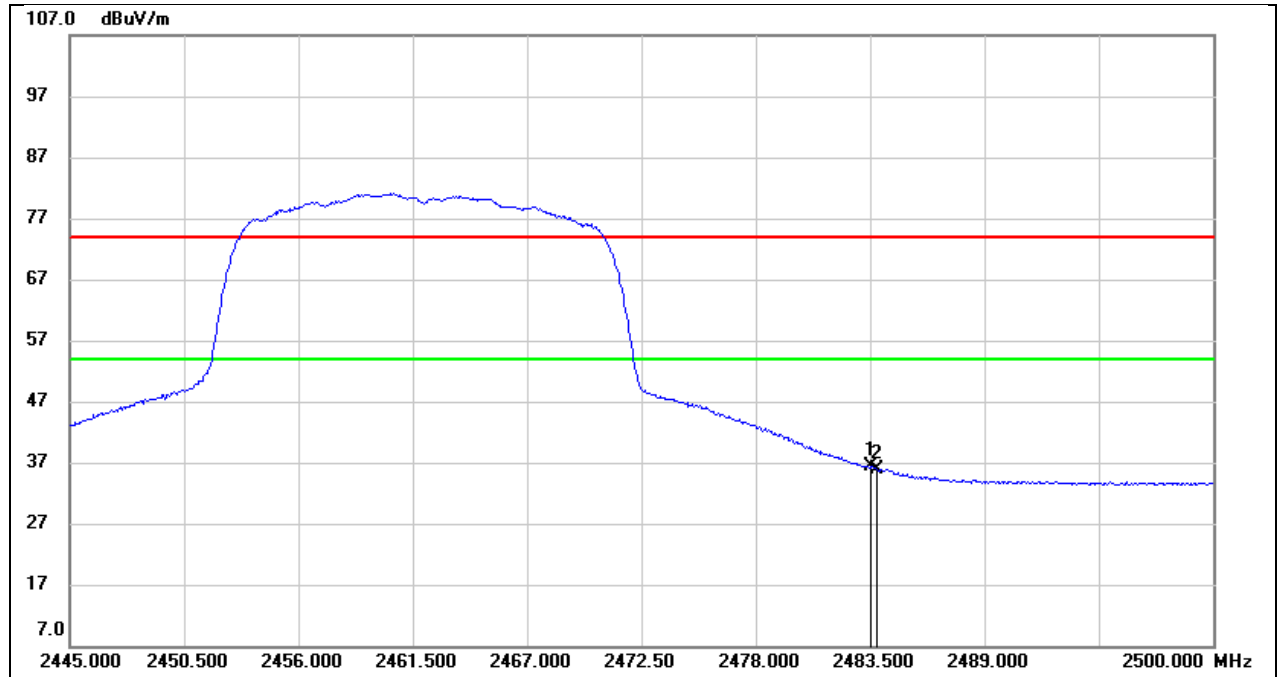

No.	Frequency (MHz)	Reading (dBuV)	Correct (dB/m)	Result (dBuV/m)	Limit (dBuV/m)	Margin (dB)	Remark
1	2483.500	3.87	32.44	36.31	54.00	-17.69	AVG
2	2483.830	3.45	32.44	35.89	54.00	-18.11	AVG

8.2.2. SPURIOUS EMISSIONS(1 GHz~3 GHz)

Test Mode:	802.11b	Frequency(MHz):	2412
Polarity:	Horizontal	Test Voltage:	DC 12 V

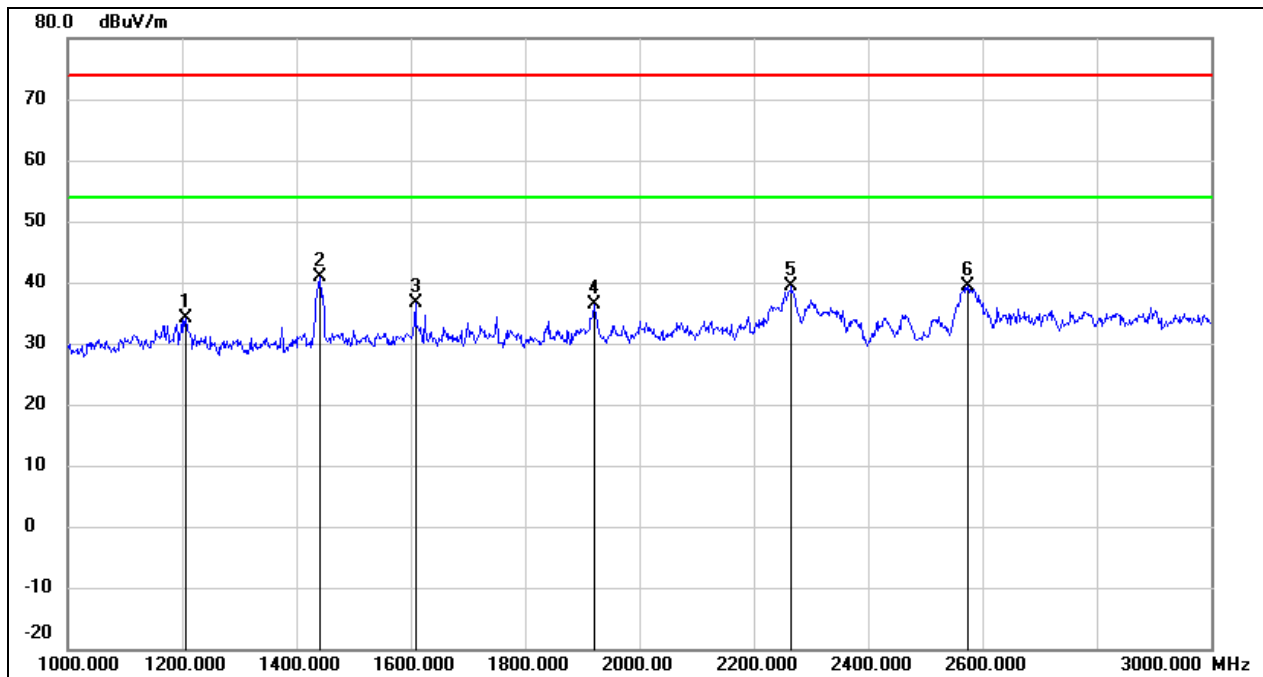

No.	Frequency (MHz)	Reading (dBuV)	Correct (dB/m)	Result (dBuV/m)	Limit (dBuV/m)	Margin (dB)	Remark
1	1206.000	48.09	-14.07	34.02	74.00	-39.98	peak
2	1442.000	53.81	-12.98	40.83	74.00	-33.17	peak
3	1608.000	48.91	-12.35	36.56	74.00	-37.44	peak
4	1920.000	47.66	-11.32	36.34	74.00	-37.66	peak
5	2266.000	48.99	-9.69	39.30	74.00	-34.70	peak
6	2574.000	47.64	-8.27	39.37	74.00	-34.63	peak

Test Mode:	802.11b	Frequency(MHz):	2412
Polarity:	Vertical	Test Voltage:	DC 12 V

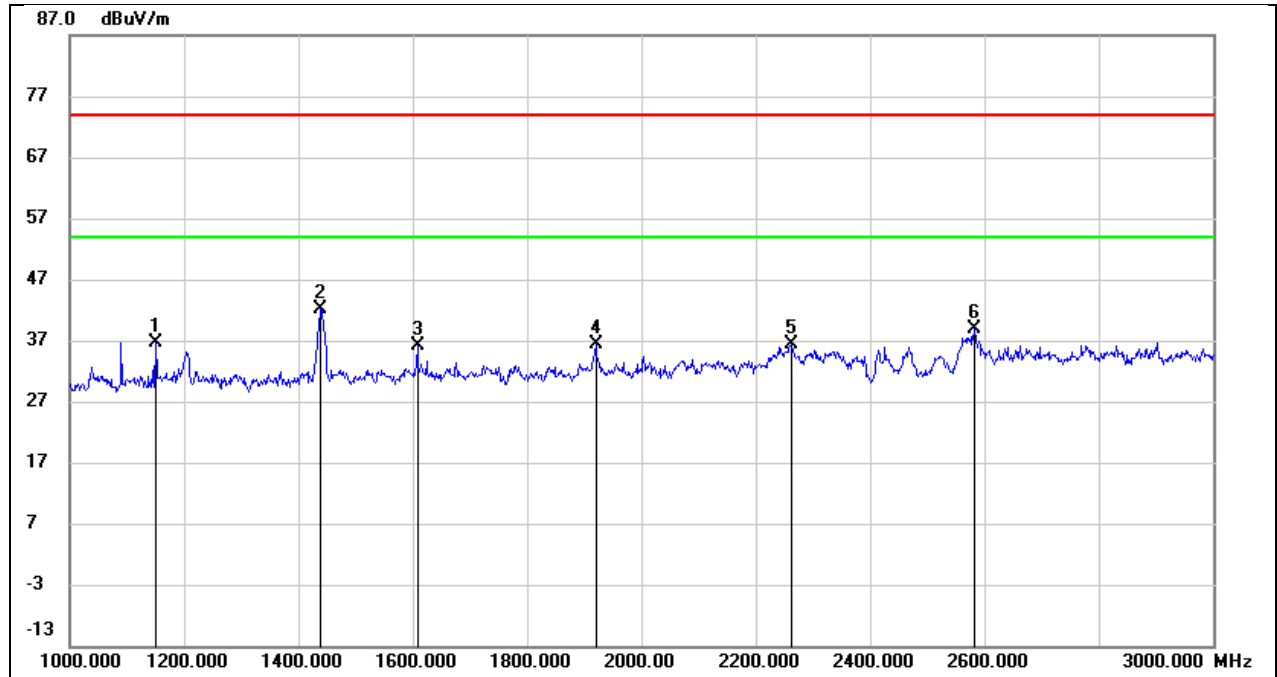

No.	Frequency (MHz)	Reading (dBuV)	Correct (dB/m)	Result (dBuV/m)	Limit (dBuV/m)	Margin (dB)	Remark
1	1150.000	50.96	-14.33	36.63	74.00	-37.37	peak
2	1438.000	55.07	-13.00	42.07	74.00	-31.93	peak
3	1608.000	48.48	-12.35	36.13	74.00	-37.87	peak
4	1920.000	47.70	-11.32	36.38	74.00	-37.62	peak
5	2262.000	46.10	-9.72	36.38	74.00	-37.62	peak
6	2582.000	47.15	-8.24	38.91	74.00	-35.09	peak

Test Mode:	802.11b	Frequency(MHz):	2437
Polarity:	Horizontal	Test Voltage:	DC 12 V

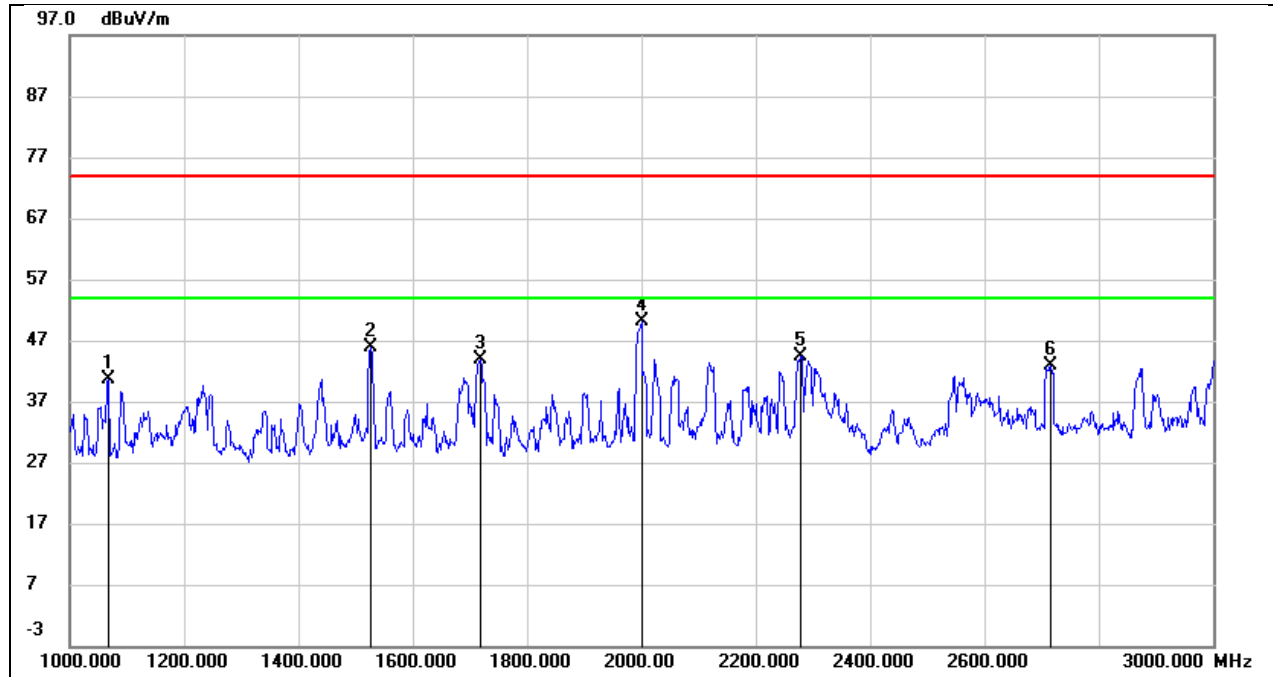

No.	Frequency (MHz)	Reading (dBuV)	Correct (dB/m)	Result (dBuV/m)	Limit (dBuV/m)	Margin (dB)	Remark
1	1068.000	55.24	-14.72	40.52	74.00	-33.48	peak
2	1526.000	58.52	-12.63	45.89	74.00	-28.11	peak
3	1718.000	55.97	-11.99	43.98	74.00	-30.02	peak
4	2000.000	61.12	-11.06	50.06	74.00	-23.94	peak
5	2278.000	54.09	-9.64	44.45	74.00	-29.55	peak
6	2716.000	50.60	-7.84	42.76	74.00	-31.24	peak

Test Mode:	802.11b	Frequency(MHz):	2437
Polarity:	Vertical	Test Voltage:	DC 12 V

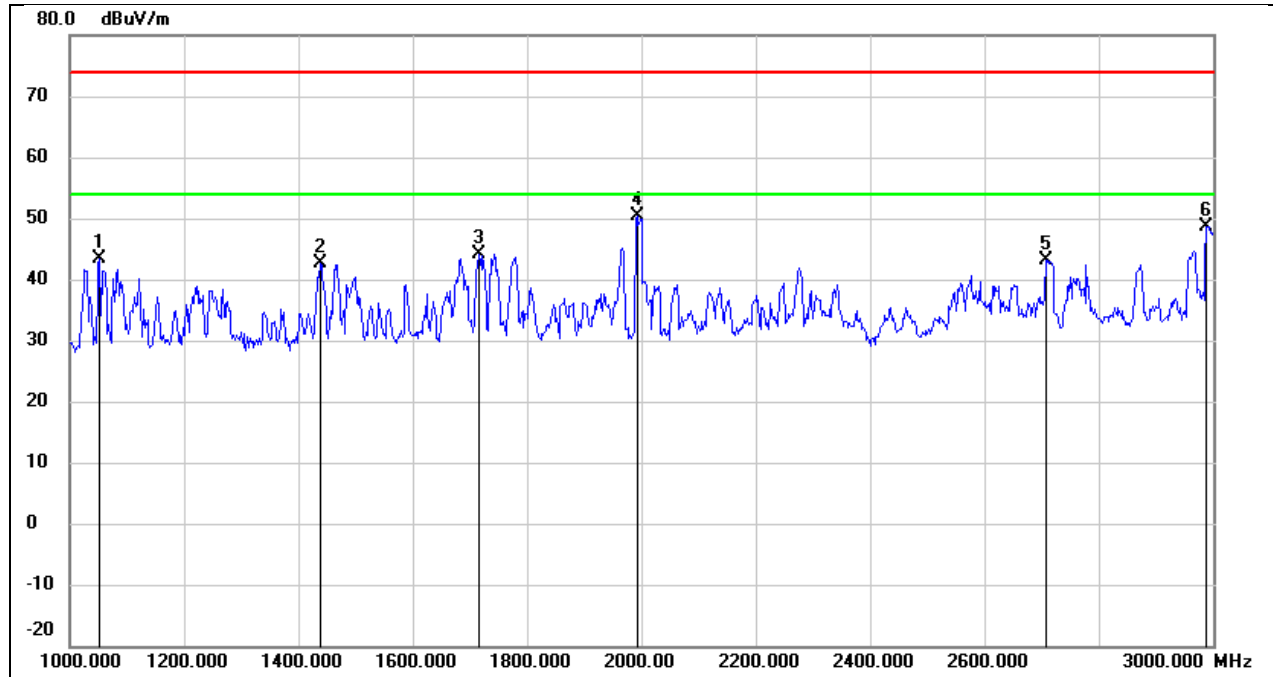

No.	Frequency (MHz)	Reading (dBuV)	Correct (dB/m)	Result (dBuV/m)	Limit (dBuV/m)	Margin (dB)	Remark
1	1052.000	58.21	-14.79	43.42	74.00	-30.58	peak
2	1438.000	55.52	-13.00	42.52	74.00	-31.48	peak
3	1716.000	56.24	-12.00	44.24	74.00	-29.76	peak
4	1992.000	61.36	-11.09	50.27	74.00	-23.73	peak
5	2708.000	50.98	-7.86	43.12	74.00	-30.88	peak
6	2988.000	55.65	-7.02	48.63	74.00	-25.37	peak

Test Mode:	802.11b	Frequency(MHz):	2462
Polarity:	Horizontal	Test Voltage:	DC 12 V

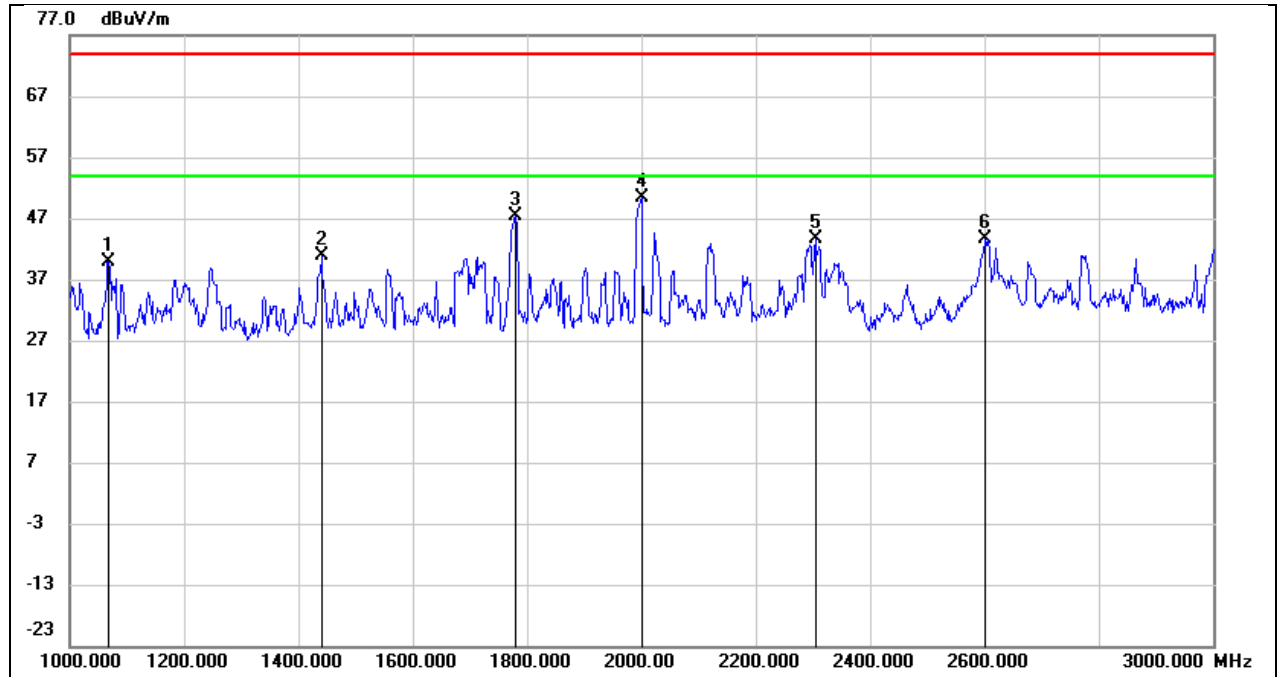

No.	Frequency (MHz)	Reading (dBuV)	Correct (dB/m)	Result (dBuV/m)	Limit (dBuV/m)	Margin (dB)	Remark
1	1068.000	54.52	-14.72	39.80	74.00	-34.20	peak
2	1440.000	53.78	-12.98	40.80	74.00	-33.20	peak
3	1780.000	59.09	-11.79	47.30	74.00	-26.70	peak
4	2000.000	61.54	-11.06	50.48	74.00	-23.52	peak
5	2304.000	53.13	-9.50	43.63	74.00	-30.37	peak
6	2602.000	51.81	-8.19	43.62	74.00	-30.38	peak

Test Mode:	802.11b	Frequency(MHz):	2462
Polarity:	Vertical	Test Voltage:	DC 12 V

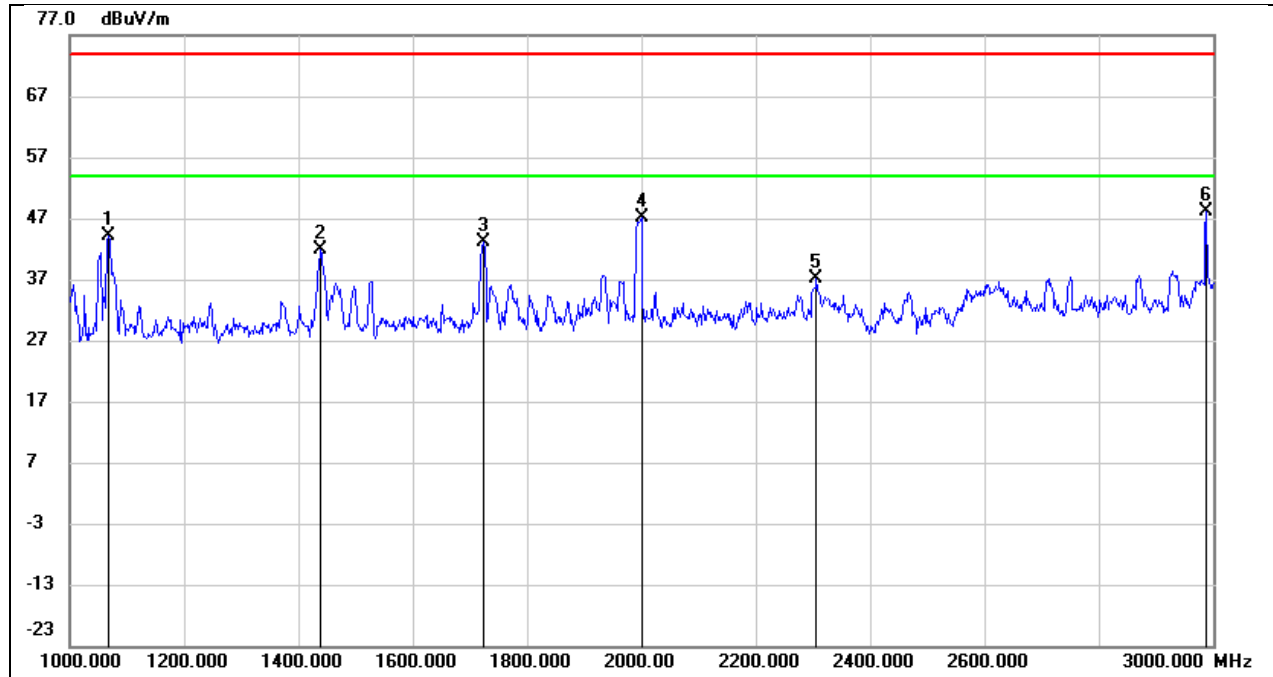

No.	Frequency (MHz)	Reading (dBuV)	Correct (dB/m)	Result (dBuV/m)	Limit (dBuV/m)	Margin (dB)	Remark
1	1068.000	58.75	-14.72	44.03	74.00	-29.97	peak
2	1438.000	54.78	-13.00	41.78	74.00	-32.22	peak
3	1724.000	55.11	-11.97	43.14	74.00	-30.86	peak
4	2000.000	58.08	-11.06	47.02	74.00	-26.98	peak
5	2306.000	46.73	-9.49	37.24	74.00	-36.76	peak
6	2988.000	55.21	-7.02	48.19	74.00	-25.81	peak

8.2.3. SPURIOUS EMISSIONS(3 GHz~18 GHz)

Test Mode:	802.11b	Frequency(MHz):	2412
Polarity:	Horizontal	Test Voltage:	DC 12 V

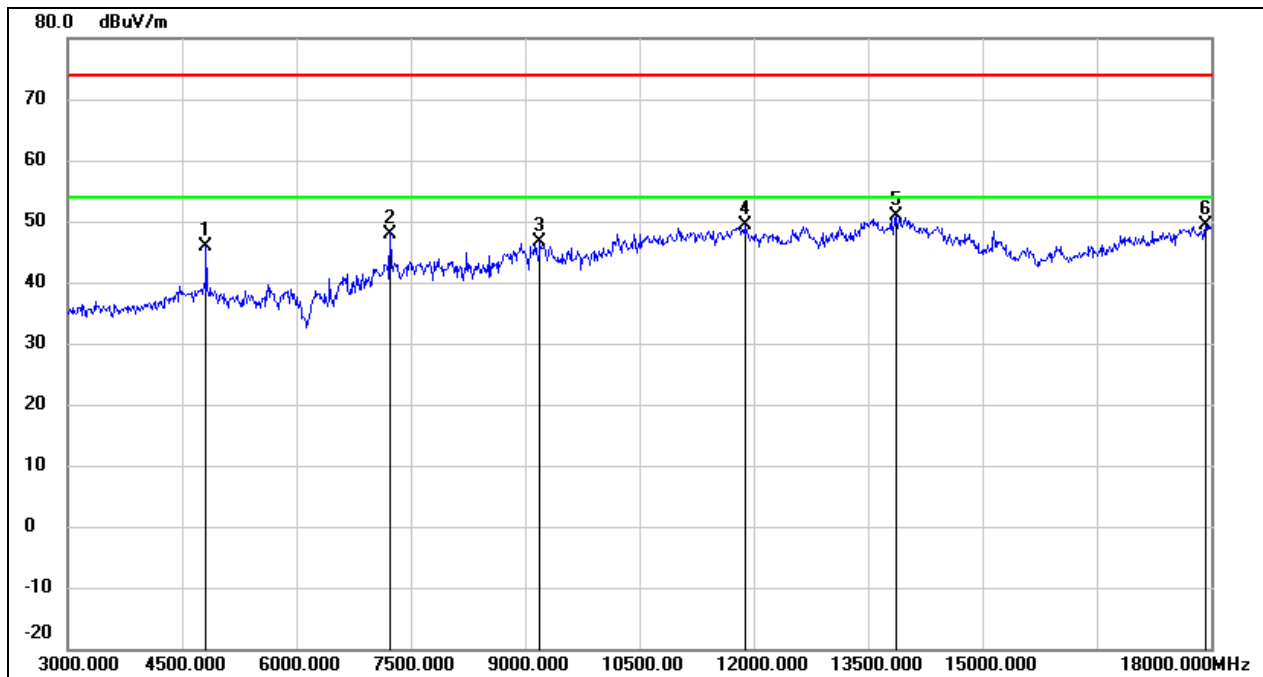

No.	Frequency (MHz)	Reading (dBuV)	Correct (dB/m)	Result (dBuV/m)	Limit (dBuV/m)	Margin (dB)	Remark
1	4815.000	46.18	-0.26	45.92	74.00	-28.08	peak
2	7230.000	41.47	6.53	48.00	74.00	-26.00	peak
3	9195.000	36.08	10.56	46.64	74.00	-27.36	peak
4	11880.000	31.63	17.63	49.26	74.00	-24.74	peak
5	13875.000	29.12	21.70	50.82	74.00	-23.18	peak
6	17925.000	24.21	25.25	49.46	74.00	-24.54	peak

Test Mode:	802.11b	Frequency(MHz):	2412
Polarity:	Vertical	Test Voltage:	DC 12 V

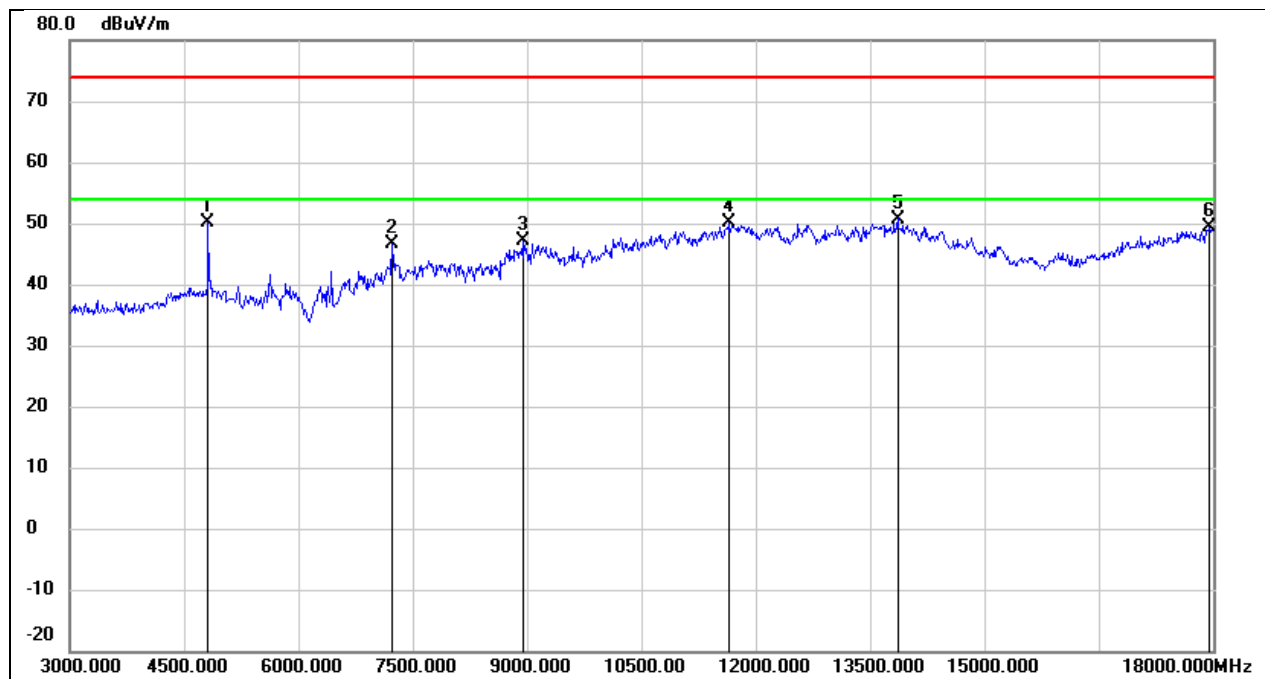

No.	Frequency (MHz)	Reading (dBuV)	Correct (dB/m)	Result (dBuV/m)	Limit (dBuV/m)	Margin (dB)	Remark
1	4815.000	50.49	-0.26	50.23	74.00	-23.77	peak
2	7230.000	40.19	6.53	46.72	74.00	-27.28	peak
3	8940.000	37.12	10.04	47.16	74.00	-26.84	peak
4	11655.000	33.23	17.01	50.24	74.00	-23.76	peak
5	13860.000	29.08	21.67	50.75	74.00	-23.25	peak
6	17955.000	23.92	25.42	49.34	74.00	-24.66	peak

Test Mode:	802.11b	Frequency(MHz):	2437
Polarity:	Horizontal	Test Voltage:	DC 12 V

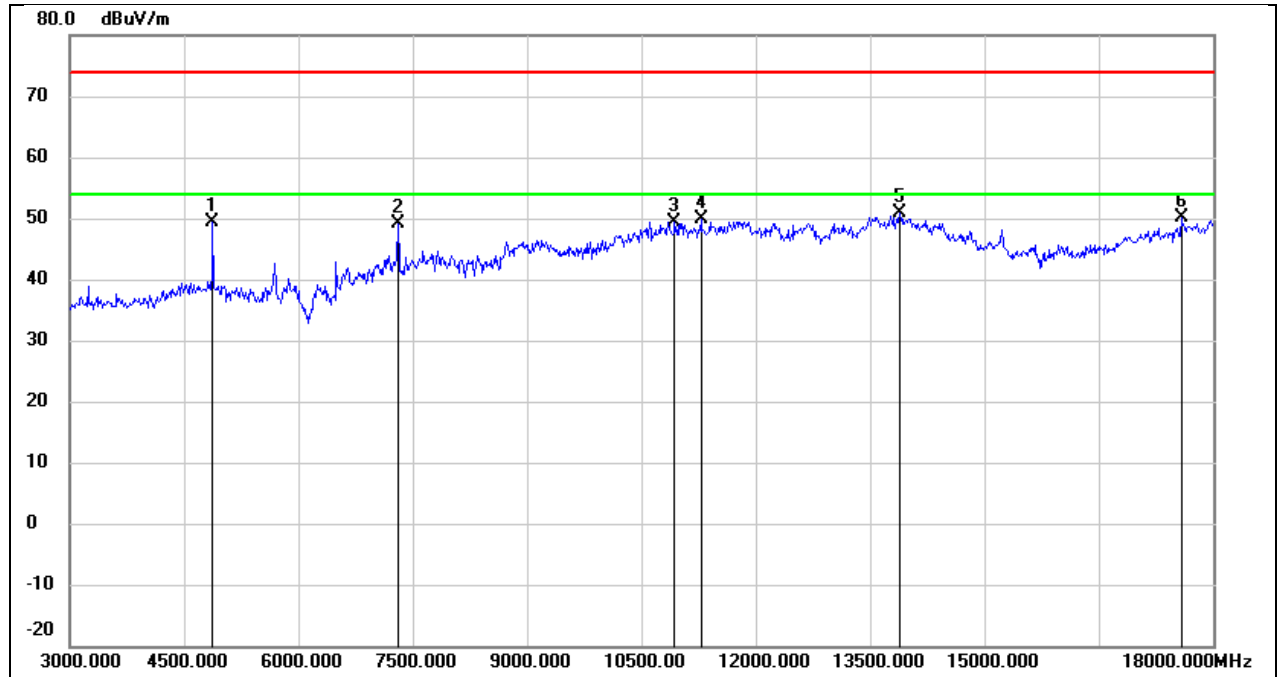

No.	Frequency (MHz)	Reading (dBuV)	Correct (dB/m)	Result (dBuV/m)	Limit (dBuV/m)	Margin (dB)	Remark
1	4875.000	49.36	-0.03	49.33	74.00	-24.67	peak
2	7305.000	42.75	6.47	49.22	74.00	-24.78	peak
3	10935.000	34.88	14.54	49.42	74.00	-24.58	peak
4	11280.000	33.96	15.80	49.76	74.00	-24.24	peak
5	13890.000	29.07	21.72	50.79	74.00	-23.21	peak
6	17580.000	26.96	23.20	50.16	74.00	-23.84	peak

Test Mode:	802.11b	Frequency(MHz):	2437
Polarity:	Vertical	Test Voltage:	DC 12 V

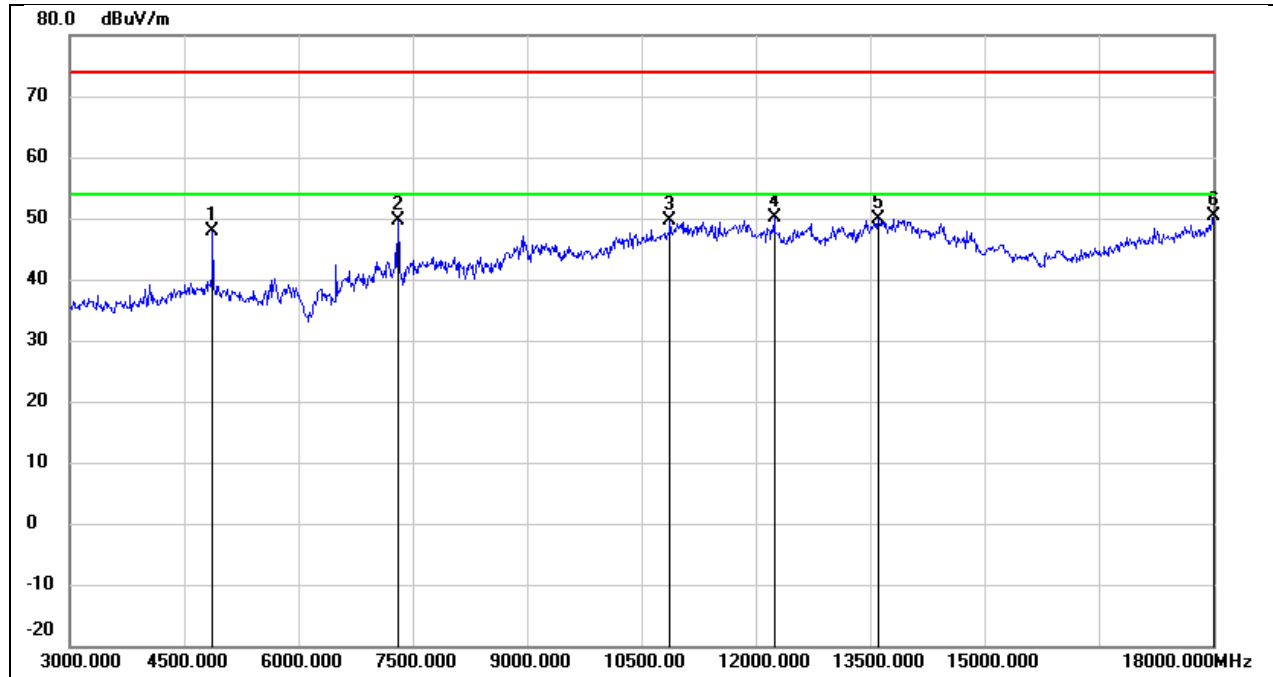

No.	Frequency (MHz)	Reading (dBuV)	Correct (dB/m)	Result (dBuV/m)	Limit (dBuV/m)	Margin (dB)	Remark
1	4875.000	48.02	-0.03	47.99	74.00	-26.01	peak
2	7305.000	43.15	6.47	49.62	74.00	-24.38	peak
3	10875.000	35.24	14.32	49.56	74.00	-24.44	peak
4	12240.000	32.46	17.79	50.25	74.00	-23.75	peak
5	13605.000	28.72	21.12	49.84	74.00	-24.16	peak
6	18000.000	24.62	25.69	50.31	74.00	-23.69	peak

Test Mode:	802.11b	Frequency(MHz):	2462
Polarity:	Horizontal	Test Voltage:	DC 12 V

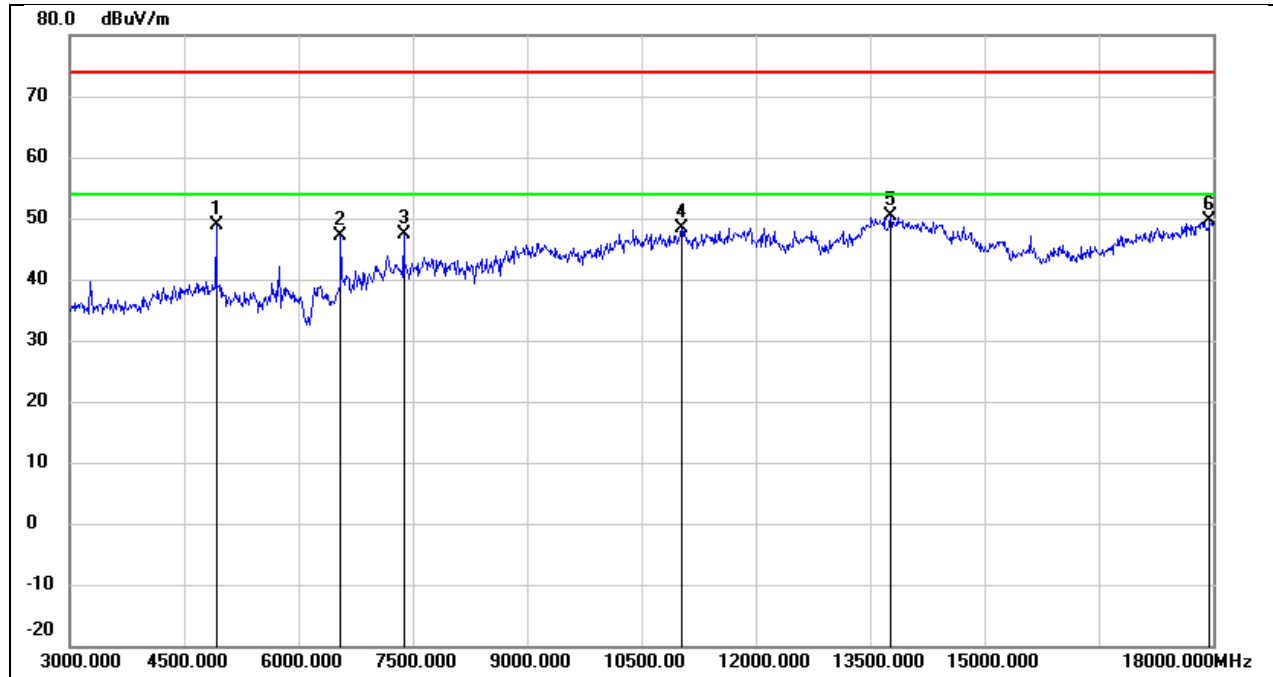

No.	Frequency (MHz)	Reading (dBuV)	Correct (dB/m)	Result (dBuV/m)	Limit (dBuV/m)	Margin (dB)	Remark
1	4920.000	48.76	0.14	48.90	74.00	-25.10	peak
2	6555.000	42.57	4.49	47.06	74.00	-26.94	peak
3	7380.000	40.87	6.42	47.29	74.00	-26.71	peak
4	11025.000	33.58	14.85	48.43	74.00	-25.57	peak
5	13770.000	28.79	21.47	50.26	74.00	-23.74	peak
6	17955.000	24.11	25.42	49.53	74.00	-24.47	peak

Test Mode:	802.11b	Frequency(MHz):	2462
Polarity:	Vertical	Test Voltage:	DC 12 V

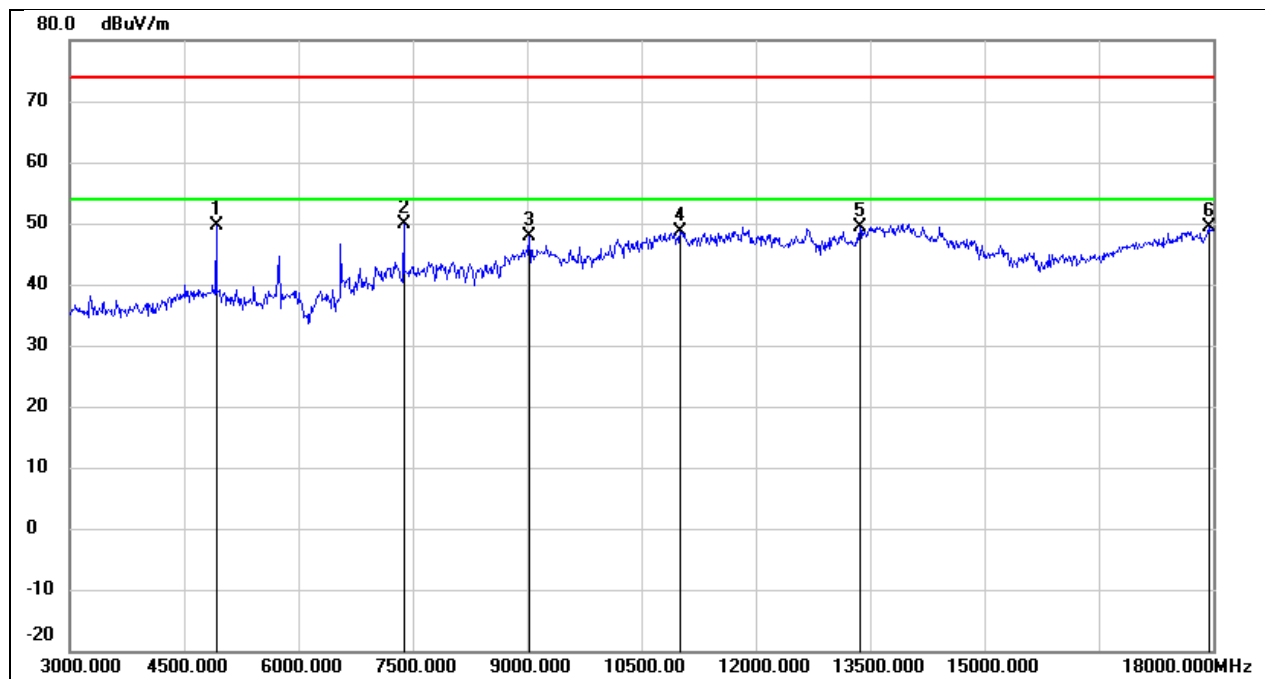

No.	Frequency (MHz)	Reading (dBuV)	Correct (dB/m)	Result (dBuV/m)	Limit (dBuV/m)	Margin (dB)	Remark
1	4920.000	49.58	0.14	49.72	74.00	-24.28	peak
2	7380.000	43.52	6.42	49.94	74.00	-24.06	peak
3	9030.000	37.29	10.49	47.78	74.00	-26.22	peak
4	11010.000	33.93	14.81	48.74	74.00	-25.26	peak
5	13365.000	29.02	20.31	49.33	74.00	-24.67	peak
6	17940.000	24.06	25.34	49.40	74.00	-24.60	peak

Test Mode:	802.11g	Frequency(MHz):	2412
Polarity:	Horizontal	Test Voltage:	DC 12 V

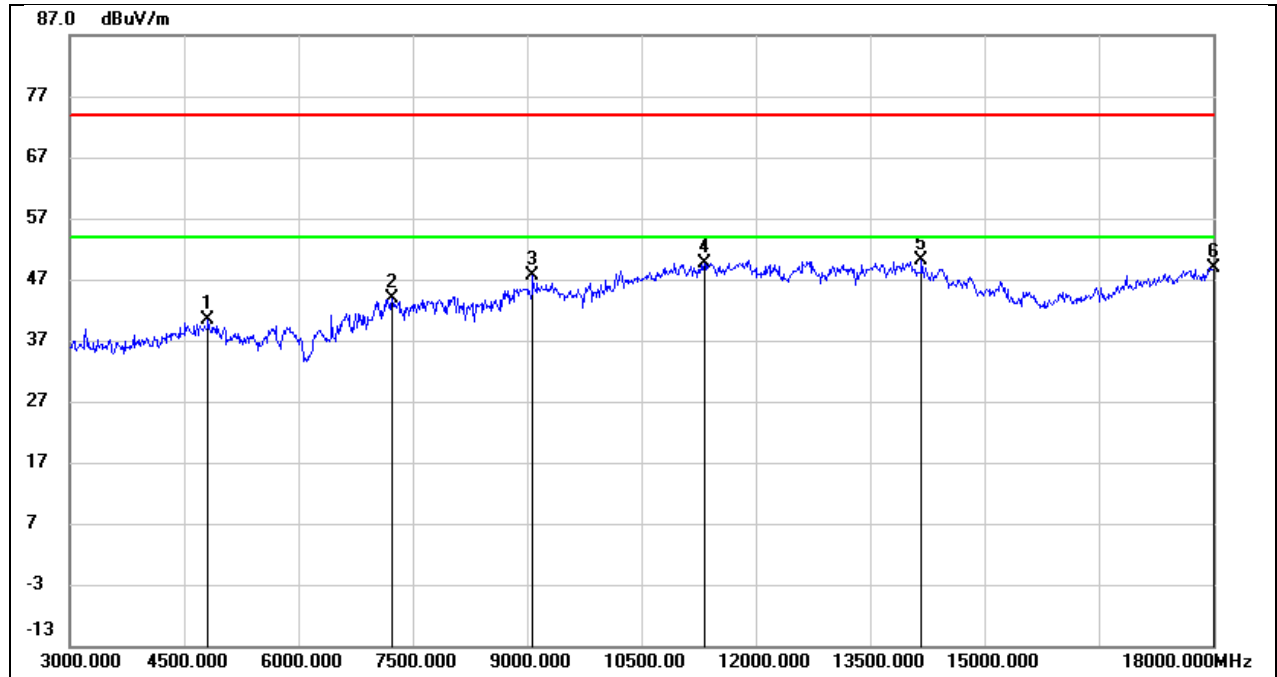

No.	Frequency (MHz)	Reading (dBuV)	Correct (dB/m)	Result (dBuV/m)	Limit (dBuV/m)	Margin (dB)	Remark
1	4815.000	40.75	-0.26	40.49	74.00	-33.51	peak
2	7230.000	37.34	6.53	43.87	74.00	-30.13	peak
3	9075.000	37.01	10.52	47.53	74.00	-26.47	peak
4	11325.000	33.68	15.95	49.63	74.00	-24.37	peak
5	14175.000	28.84	21.24	50.08	74.00	-23.92	peak
6	18000.000	23.30	25.69	48.99	74.00	-25.01	peak

Test Mode:	802.11g	Frequency(MHz):	2412
Polarity:	Vertical	Test Voltage:	DC 12 V

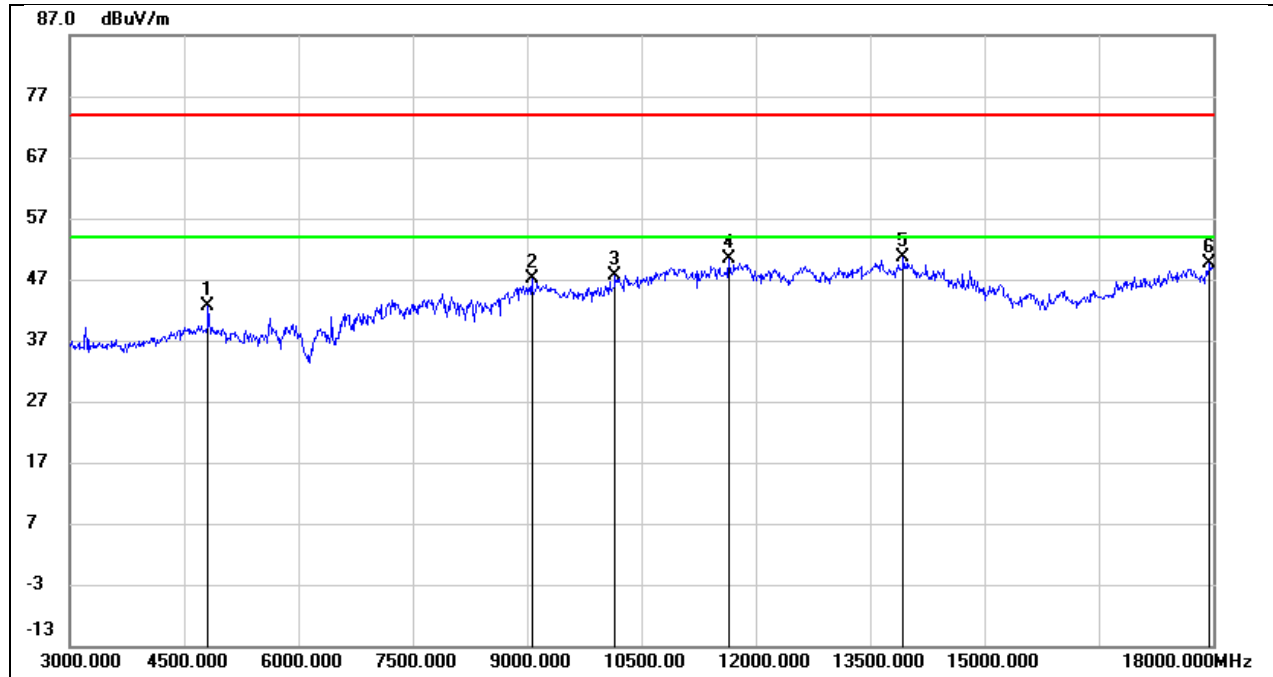

No.	Frequency (MHz)	Reading (dBuV)	Correct (dB/m)	Result (dBuV/m)	Limit (dBuV/m)	Margin (dB)	Remark
1	4815.000	42.92	-0.26	42.66	74.00	-31.34	peak
2	9060.000	36.60	10.51	47.11	74.00	-26.89	peak
3	10155.000	35.39	12.32	47.71	74.00	-26.29	peak
4	11640.000	33.40	16.98	50.38	74.00	-23.62	peak
5	13935.000	28.71	21.82	50.53	74.00	-23.47	peak
6	17955.000	24.12	25.42	49.54	74.00	-24.46	peak

Test Mode:	802.11g	Frequency(MHz):	2437
Polarity:	Horizontal	Test Voltage:	DC 12 V

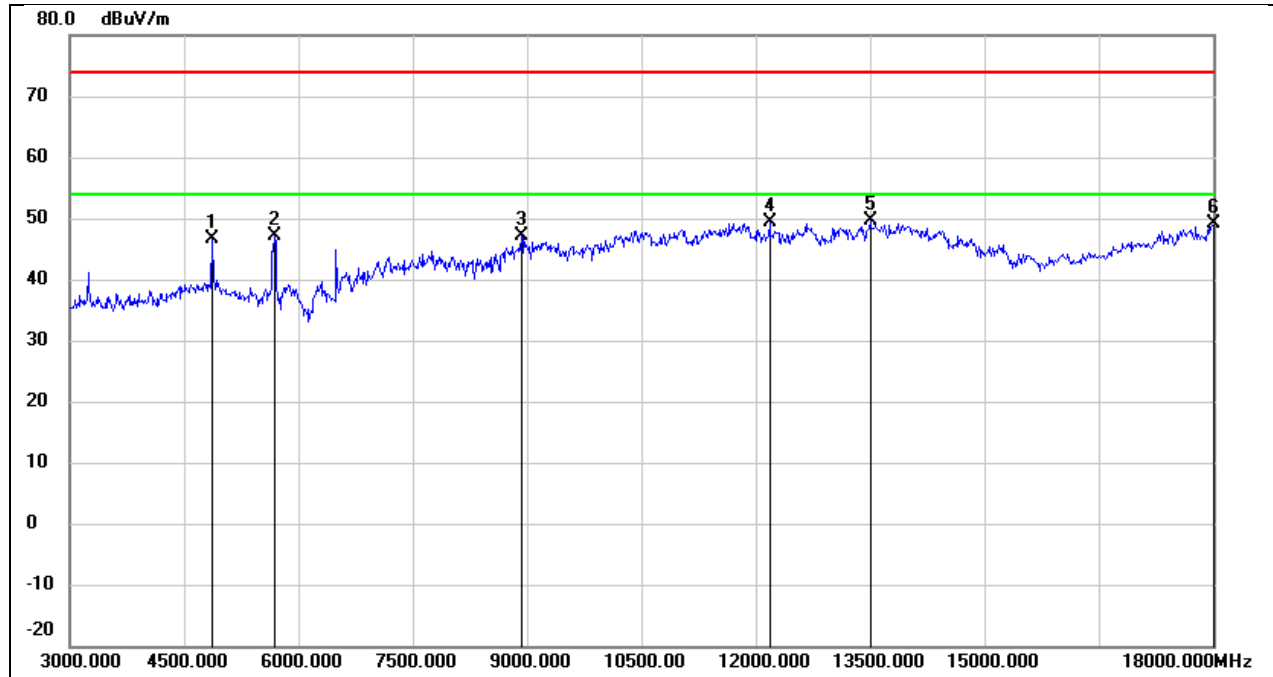

No.	Frequency (MHz)	Reading (dBuV)	Correct (dB/m)	Result (dBuV/m)	Limit (dBuV/m)	Margin (dB)	Remark
1	4860.000	46.61	-0.09	46.52	74.00	-27.48	peak
2	5685.000	45.80	1.37	47.17	74.00	-26.83	peak
3	8925.000	37.28	9.94	47.22	74.00	-26.78	peak
4	12180.000	31.61	17.83	49.44	74.00	-24.56	peak
5	13500.000	28.69	20.90	49.59	74.00	-24.41	peak
6	18000.000	23.56	25.69	49.25	74.00	-24.75	peak

Test Mode:	802.11g	Frequency(MHz):	2437
Polarity:	Vertical	Test Voltage:	DC 12 V

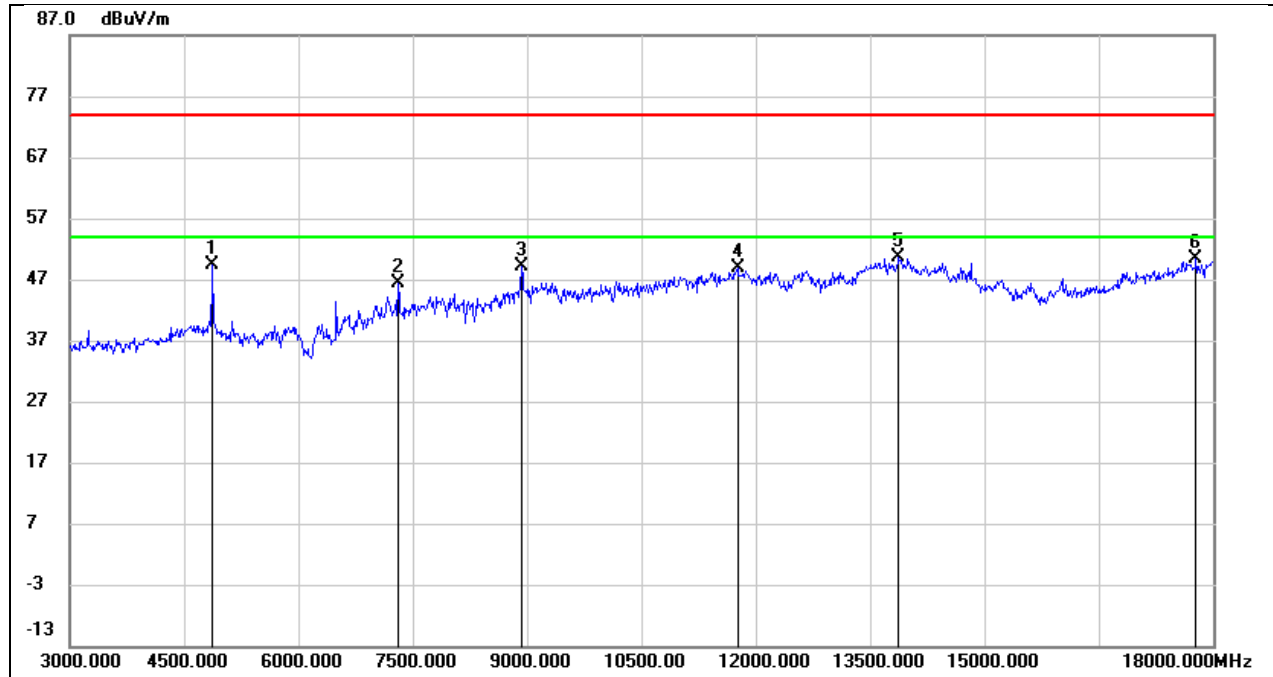

No.	Frequency (MHz)	Reading (dBuV)	Correct (dB/m)	Result (dBuV/m)	Limit (dBuV/m)	Margin (dB)	Remark
1	4875.000	49.51	-0.03	49.48	74.00	-24.52	peak
2	7305.000	39.89	6.47	46.36	74.00	-27.64	peak
3	8925.000	39.21	9.94	49.15	74.00	-24.85	peak
4	11760.000	31.63	17.31	48.94	74.00	-25.06	peak
5	13875.000	28.96	21.70	50.66	74.00	-23.34	peak
6	17775.000	25.93	24.36	50.29	74.00	-23.71	peak

Test Mode:	802.11g	Frequency(MHz):	2462
Polarity:	Horizontal	Test Voltage:	DC 12 V

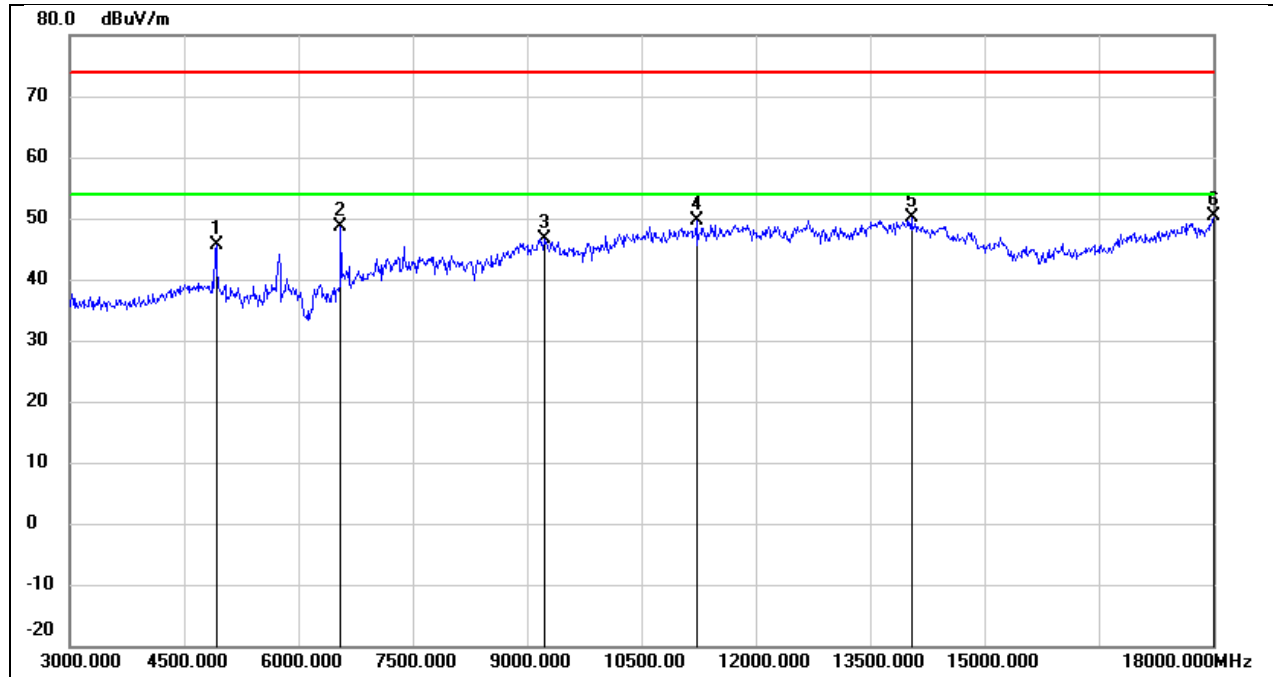

No.	Frequency (MHz)	Reading (dBuV)	Correct (dB/m)	Result (dBuV/m)	Limit (dBuV/m)	Margin (dB)	Remark
1	4920.000	45.44	0.14	45.58	74.00	-28.42	peak
2	6555.000	44.13	4.49	48.62	74.00	-25.38	peak
3	9225.000	36.12	10.58	46.70	74.00	-27.30	peak
4	11220.000	34.10	15.57	49.67	74.00	-24.33	peak
5	14040.000	28.22	21.79	50.01	74.00	-23.99	peak
6	18000.000	24.58	25.69	50.27	74.00	-23.73	peak

Test Mode:	802.11g	Frequency(MHz):	2462
Polarity:	Vertical	Test Voltage:	DC 12 V

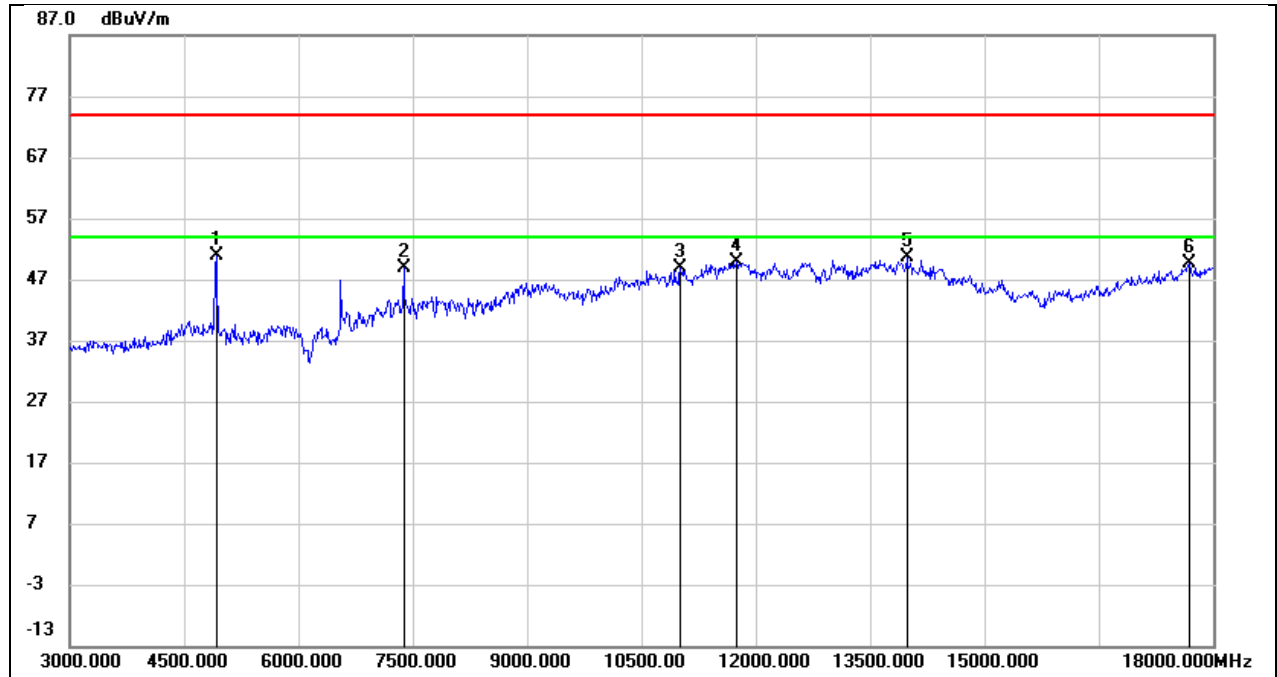

No.	Frequency (MHz)	Reading (dBuV)	Correct (dB/m)	Result (dBuV/m)	Limit (dBuV/m)	Margin (dB)	Remark
1	4920.000	50.73	0.14	50.87	74.00	-23.13	peak
2	7380.000	42.50	6.42	48.92	74.00	-25.08	peak
3	11010.000	34.01	14.81	48.82	74.00	-25.18	peak
4	11745.000	32.61	17.27	49.88	74.00	-24.12	peak
5	13980.000	28.64	21.92	50.56	74.00	-23.44	peak
6	17685.000	25.76	23.82	49.58	74.00	-24.42	peak

Test Mode:	802.11n HT20	Frequency(MHz):	2412
Polarity:	Horizontal	Test Voltage:	DC 12 V

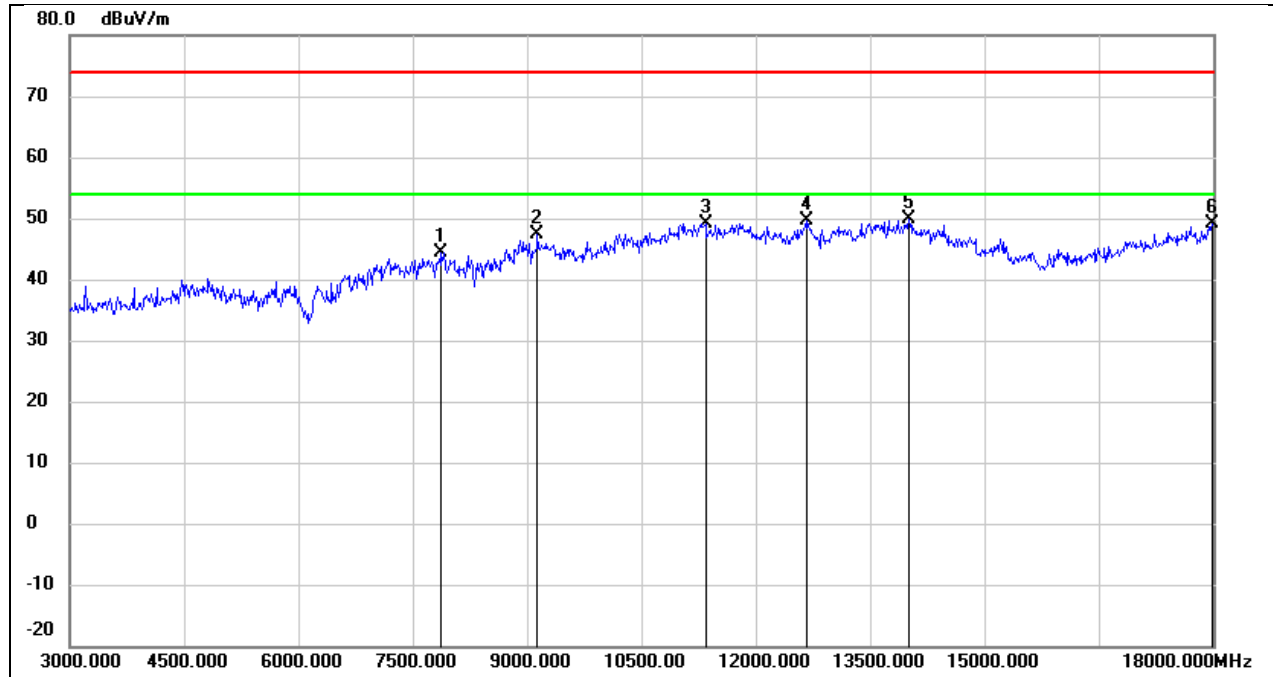

No.	Frequency (MHz)	Reading (dBuV)	Correct (dB/m)	Result (dBuV/m)	Limit (dBuV/m)	Margin (dB)	Remark
1	7875.000	37.97	6.31	44.28	74.00	-29.72	peak
2	9135.000	36.83	10.55	47.38	74.00	-26.62	peak
3	11340.000	33.18	16.01	49.19	74.00	-24.81	peak
4	12660.000	31.63	17.95	49.58	74.00	-24.42	peak
5	14010.000	28.00	21.93	49.93	74.00	-24.07	peak
6	17985.000	23.44	25.60	49.04	74.00	-24.96	peak

Test Mode:	802.11n HT20	Frequency(MHz):	2412
Polarity:	Vertical	Test Voltage:	DC 12 V

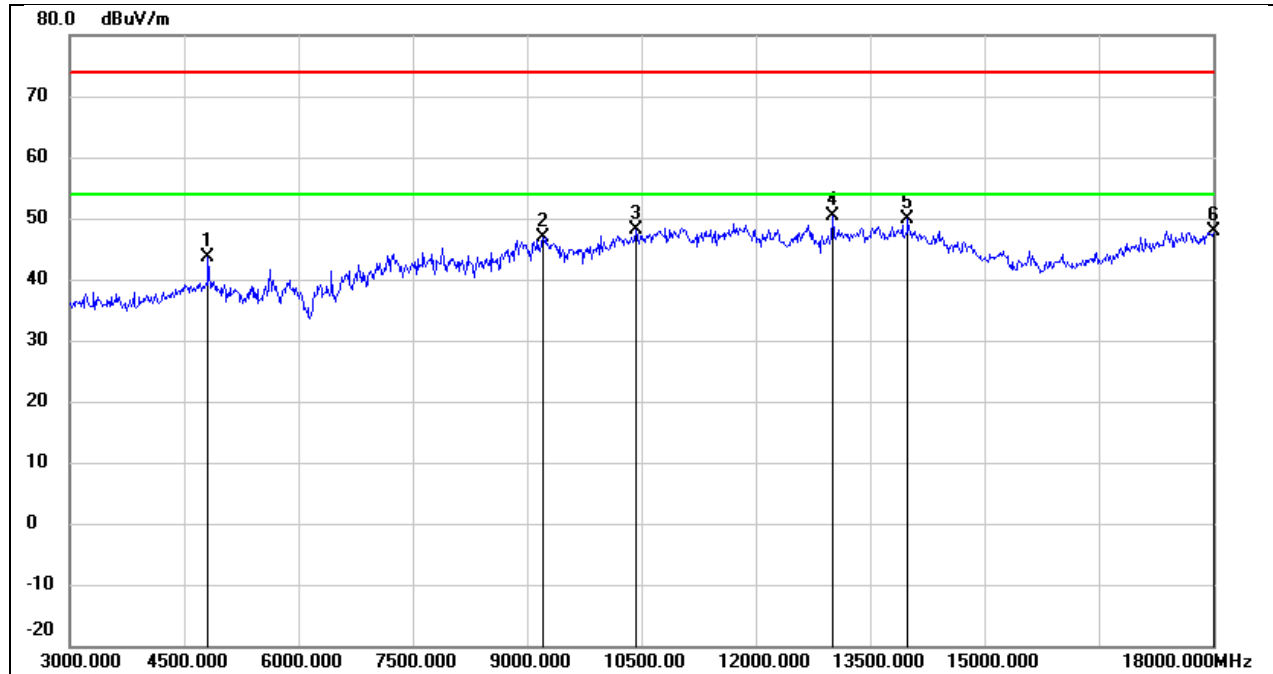

No.	Frequency (MHz)	Reading (dBuV)	Correct (dB/m)	Result (dBuV/m)	Limit (dBuV/m)	Margin (dB)	Remark
1	4815.000	43.82	-0.26	43.56	74.00	-30.44	peak
2	9210.000	36.28	10.57	46.85	74.00	-27.15	peak
3	10425.000	35.22	12.84	48.06	74.00	-25.94	peak
4	13005.000	31.71	18.74	50.45	74.00	-23.55	peak
5	13995.000	27.83	21.95	49.78	74.00	-24.22	peak
6	18000.000	22.29	25.69	47.98	74.00	-26.02	peak

Test Mode:	802.11n HT20	Frequency(MHz):	2437
Polarity:	Horizontal	Test Voltage:	DC 12 V

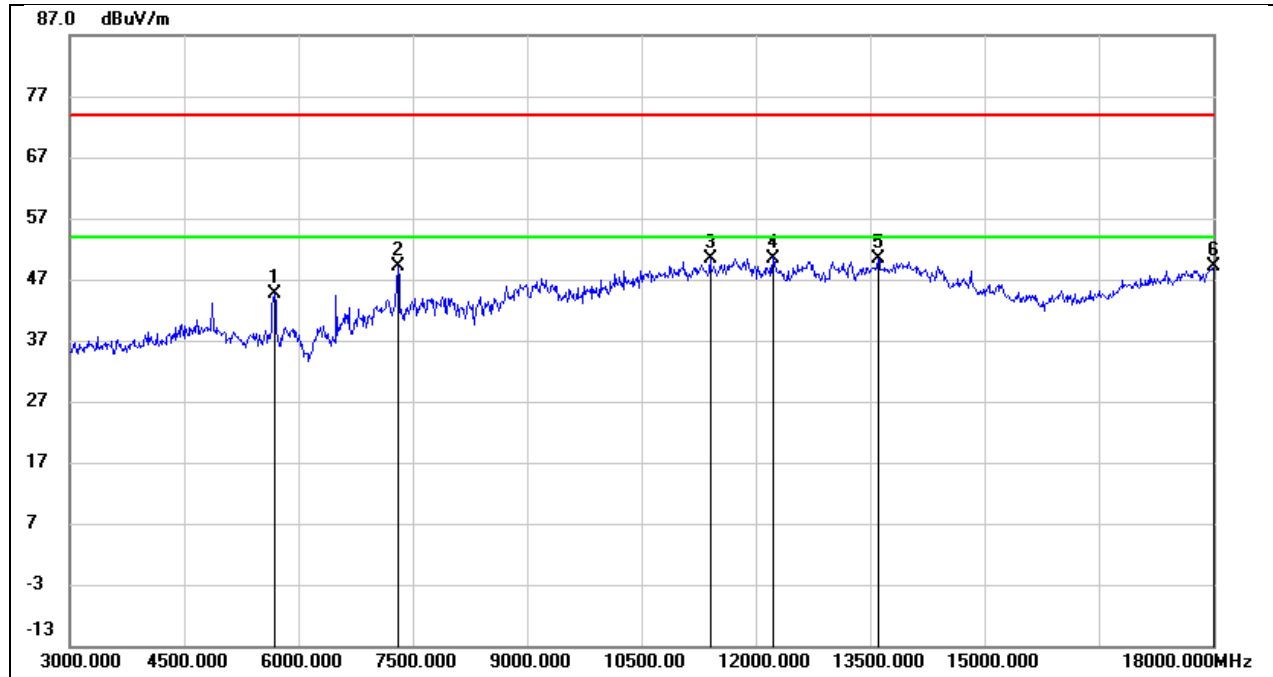

No.	Frequency (MHz)	Reading (dBuV)	Correct (dB/m)	Result (dBuV/m)	Limit (dBuV/m)	Margin (dB)	Remark
1	5685.000	43.30	1.37	44.67	74.00	-29.33	peak
2	7305.000	42.78	6.47	49.25	74.00	-24.75	peak
3	11400.000	34.04	16.23	50.27	74.00	-23.73	peak
4	12225.000	32.71	17.79	50.50	74.00	-23.50	peak
5	13605.000	29.19	21.12	50.31	74.00	-23.69	peak
6	18000.000	23.32	25.69	49.01	74.00	-24.99	peak

Test Mode:	802.11n HT20	Frequency(MHz):	2437
Polarity:	Vertical	Test Voltage:	DC 12 V

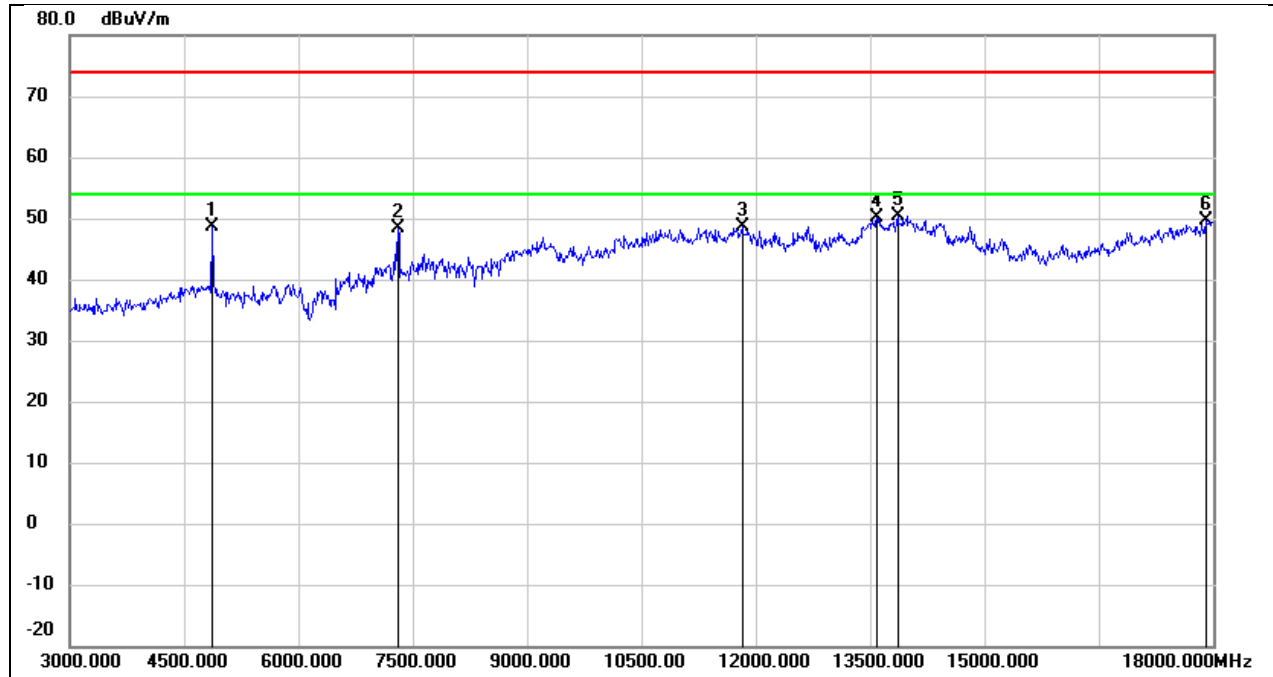

No.	Frequency (MHz)	Reading (dBuV)	Correct (dB/m)	Result (dBuV/m)	Limit (dBuV/m)	Margin (dB)	Remark
1	4875.000	48.77	-0.03	48.74	74.00	-25.26	peak
2	7305.000	41.93	6.47	48.40	74.00	-25.60	peak
3	11820.000	31.09	17.47	48.56	74.00	-25.44	peak
4	13590.000	29.02	21.09	50.11	74.00	-23.89	peak
5	13860.000	28.81	21.67	50.48	74.00	-23.52	peak
6	17910.000	24.38	25.16	49.54	74.00	-24.46	peak

Test Mode:	802.11n HT20	Frequency(MHz):	2462
Polarity:	Horizontal	Test Voltage:	DC 12 V

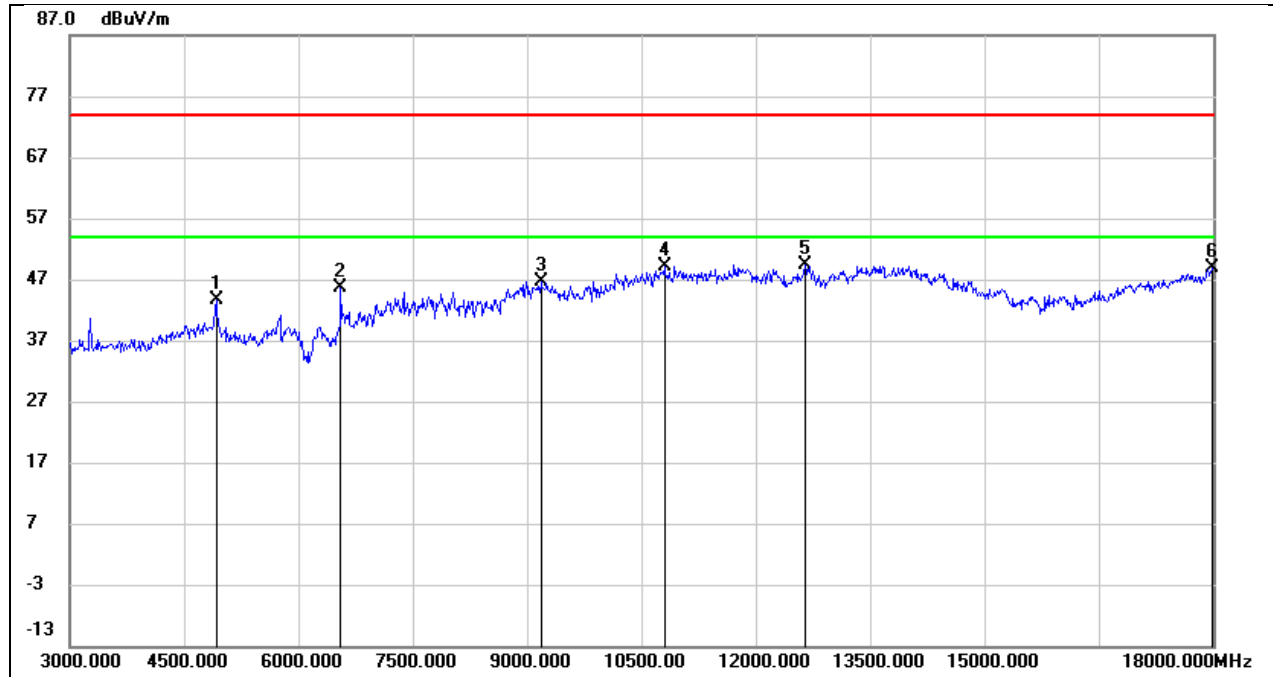

No.	Frequency (MHz)	Reading (dBuV)	Correct (dB/m)	Result (dBuV/m)	Limit (dBuV/m)	Margin (dB)	Remark
1	4920.000	43.53	0.14	43.67	74.00	-30.33	peak
2	6555.000	41.10	4.49	45.59	74.00	-28.41	peak
3	9180.000	36.01	10.56	46.57	74.00	-27.43	peak
4	10800.000	35.10	14.06	49.16	74.00	-24.84	peak
5	12645.000	31.35	17.92	49.27	74.00	-24.73	peak
6	17985.000	23.33	25.60	48.93	74.00	-25.07	peak

Test Mode:	802.11n HT20	Frequency(MHz):	2462
Polarity:	Vertical	Test Voltage:	DC 12 V

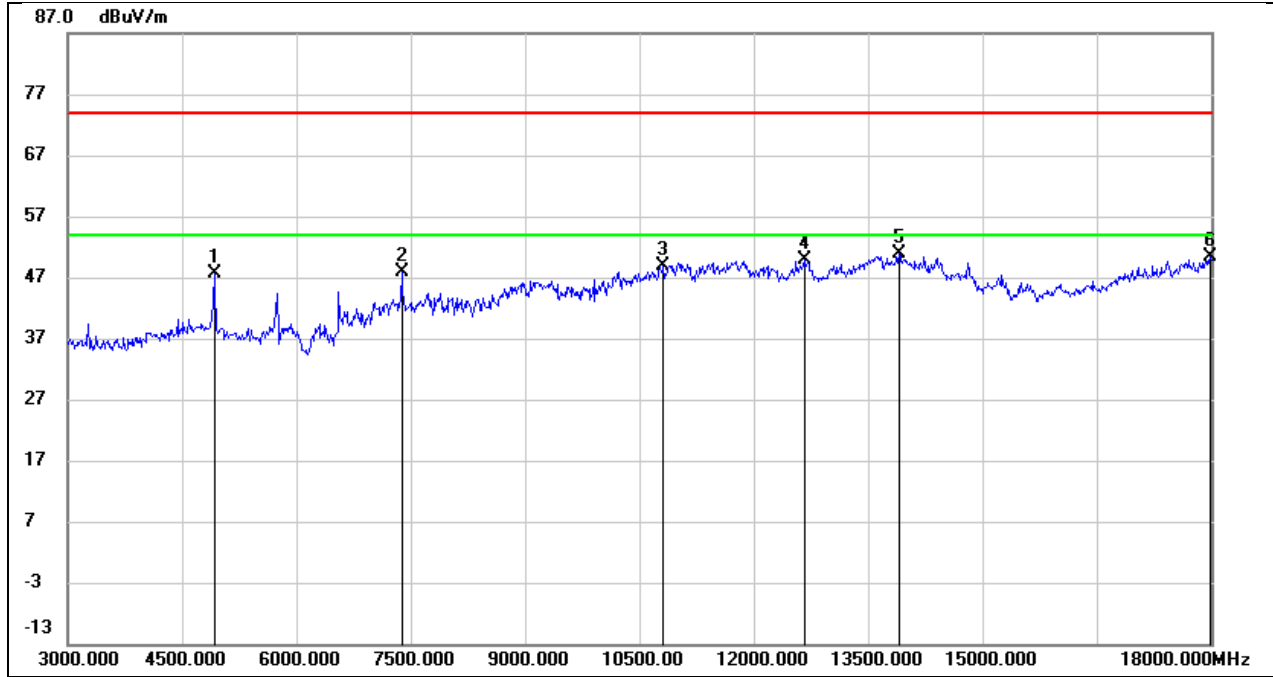

No.	Frequency (MHz)	Reading (dBuV)	Correct (dB/m)	Result (dBuV/m)	Limit (dBuV/m)	Margin (dB)	Remark
1	4920.000	47.46	0.14	47.60	74.00	-26.40	peak
2	7380.000	41.49	6.42	47.91	74.00	-26.09	peak
3	10815.000	34.87	14.11	48.98	74.00	-25.02	peak
4	12660.000	31.84	17.95	49.79	74.00	-24.21	peak
5	13905.000	29.05	21.76	50.81	74.00	-23.19	peak
6	17985.000	24.75	25.60	50.35	74.00	-23.65	peak

8.2.4. SPURIOUS EMISSIONS(9 kHz~30 MHz)

Test Mode:	802.11b	Frequency(MHz):	2412
Polarity:	Horizontal	Test Voltage:	DC 12 V

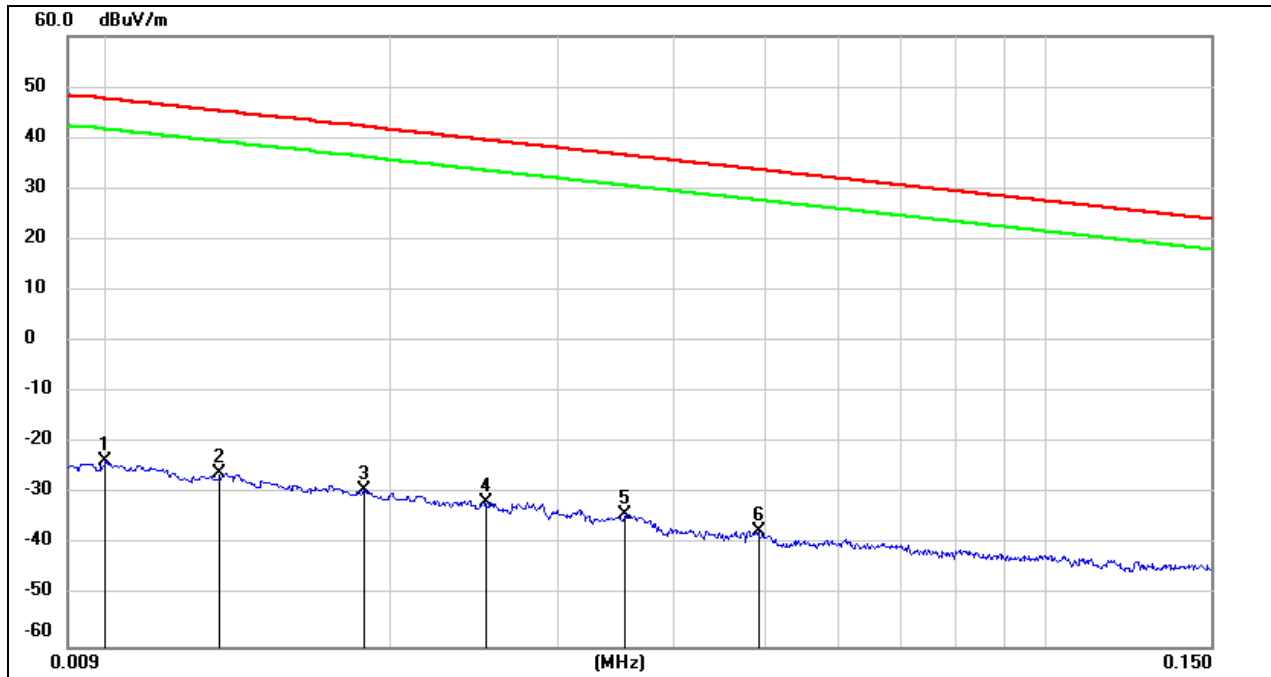

No.	Frequency (MHz)	Reading (dBuV)	Correct (dB/m)	FCC Result (dBuV/m)	FCC Limit (dBuV/m)	ISED Result (dBuA/m)	ISED Limit (dBuA/m)	Margin (dB)	Remark
1	0.01	77.72	-101.4	-23.68	47.6	-75.18	-3.9	-71.28	peak
2	0.0131	75.45	-101.38	-25.93	45.25	-77.43	-6.25	-71.18	peak
3	0.0187	72.2	-101.35	-29.15	42.16	-80.65	-9.34	-71.31	peak
4	0.0252	69.82	-101.37	-31.55	39.57	-83.05	-11.93	-71.12	peak
5	0.0354	67.47	-101.41	-33.94	36.62	-85.44	-14.88	-70.56	peak
6	0.0492	64.05	-101.47	-37.42	33.76	-88.92	-17.74	-71.18	peak

Test Mode:	802.11b	Frequency(MHz):	2412
Polarity:	Horizontal	Test Voltage:	DC 12 V

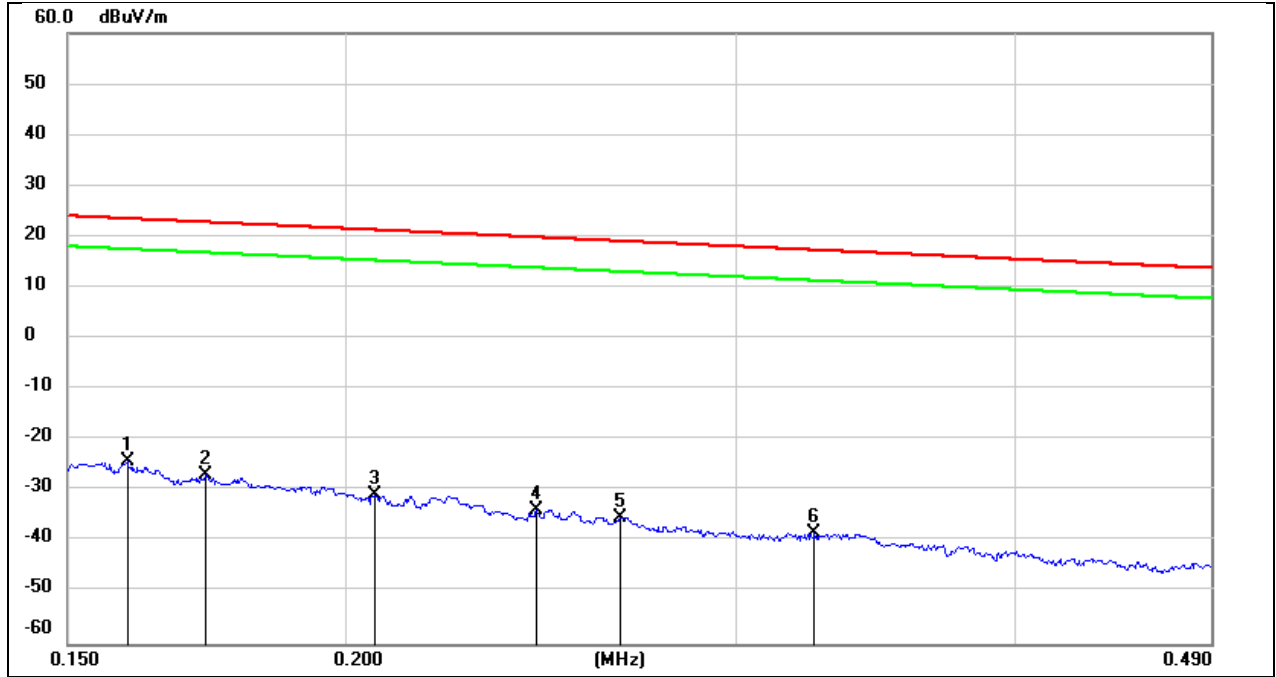

No.	Frequency (MHz)	Reading (dBuV)	Correct (dB/m)	FCC Result (dBuV/m)	FCC Limit (dBuV/m)	ISED Result (dBuA/m)	ISED Limit (dBuA/m)	Margin (dB)	Remark
1	0.1595	77.36	-101.65	-24.29	23.55	-75.79	-27.95	-47.84	peak
2	0.1731	74.96	-101.67	-26.71	22.84	-78.21	-28.66	-49.55	peak
3	0.2064	71.08	-101.73	-30.65	21.31	-82.15	-30.19	-51.96	peak
4	0.2436	67.96	-101.79	-33.83	19.87	-85.33	-31.63	-53.7	peak
5	0.2659	66.55	-101.82	-35.27	19.11	-86.77	-32.39	-54.38	peak
6	0.3251	63.71	-101.88	-38.17	17.36	-89.67	-34.14	-55.53	peak

Test Mode:	802.11b	Frequency(MHz):	2412
Polarity:	Horizontal	Test Voltage:	DC 12 V

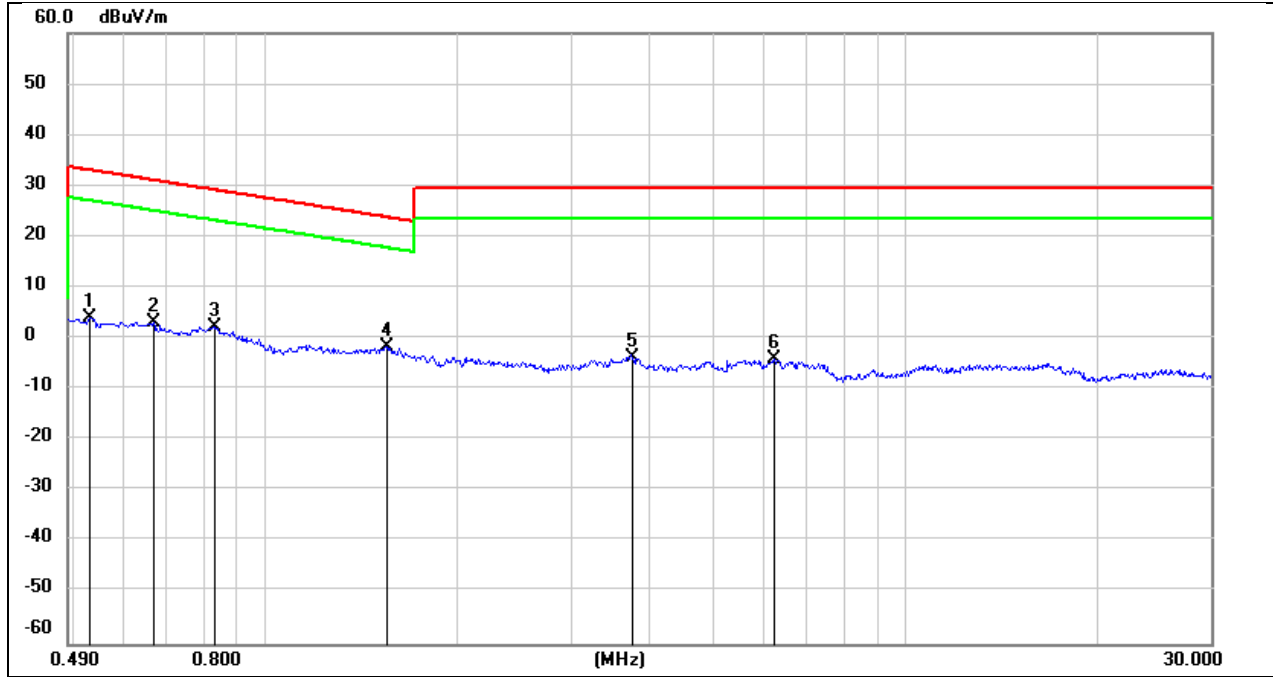

No.	Frequency (MHz)	Reading (dBuV)	Correct (dB/m)	FCC Result (dBuV/m)	FCC Limit (dBuV/m)	ISED Result (dBuA/m)	ISED Limit (dBuA/m)	Margin (dB)	Remark
1	0.5298	66.03	-62.08	3.95	33.12	-47.55	-18.38	-29.17	peak
2	0.6671	65.25	-62.1	3.15	31.12	-48.35	-20.38	-27.97	peak
3	0.8296	64.44	-62.17	2.27	29.23	-49.23	-22.27	-26.96	peak
4	1.5443	60.35	-62.03	-1.68	23.83	-53.18	-27.67	-25.51	peak
5	3.7406	57.8	-61.4	-3.6	29.54	-55.1	-21.96	-33.14	peak
6	6.2445	57.13	-61.32	-4.19	29.54	-55.69	-21.96	-33.73	peak

8.2.5. SPURIOUS EMISSIONS(18 GHz~26 GHz)

Test Mode:	802.11b	Frequency(MHz):	2412
Polarity:	Horizontal	Test Voltage:	DC 12 V

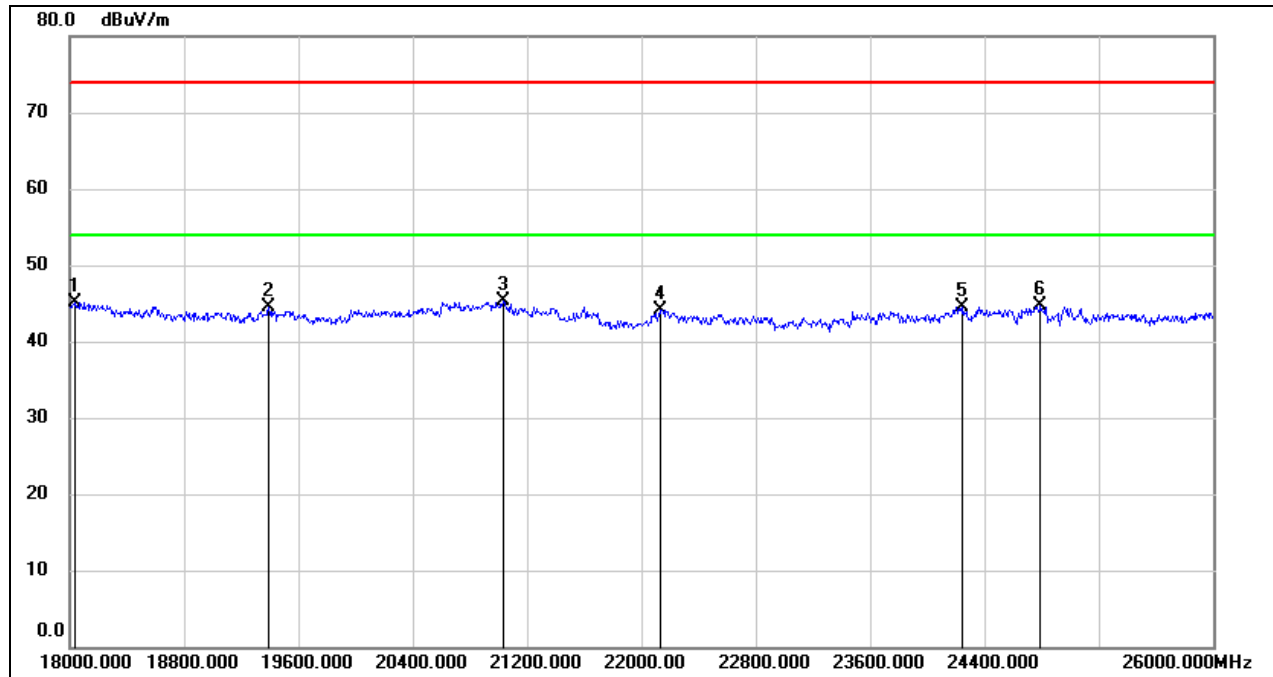

No.	Frequency (MHz)	Reading (dBuV)	Correct (dB/m)	Result (dBuV/m)	Limit (dBuV/m)	Margin (dB)	Remark
1	18040.000	50.45	-5.41	45.04	74.00	-28.96	peak
2	19392.000	50.12	-5.57	44.55	74.00	-29.45	peak
3	21032.000	50.15	-4.87	45.28	74.00	-28.72	peak
4	22136.000	48.41	-4.34	44.07	74.00	-29.93	peak
5	24248.000	47.32	-2.83	44.49	74.00	-29.51	peak
6	24792.000	46.98	-2.28	44.70	74.00	-29.30	peak

Test Mode:	802.11b	Frequency(MHz):	2412
Polarity:	Vertical	Test Voltage:	DC 12 V

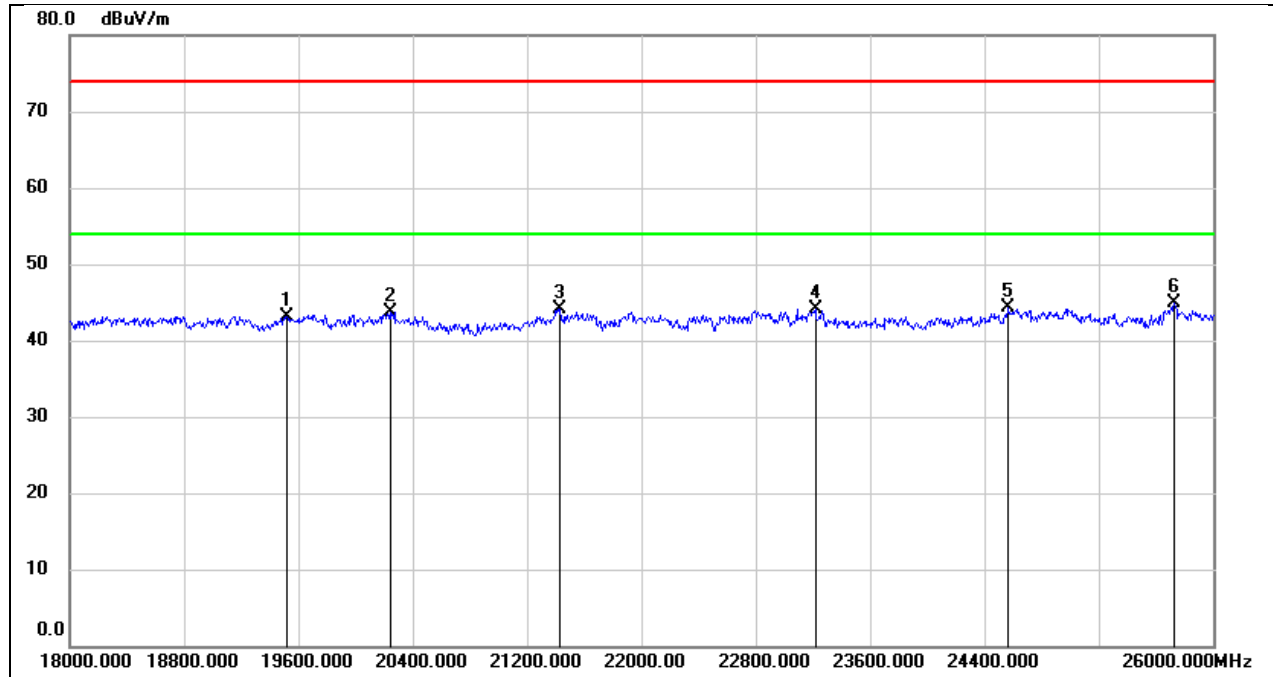

No.	Frequency (MHz)	Reading (dBuV)	Correct (dB/m)	Result (dBuV/m)	Limit (dBuV/m)	Margin (dB)	Remark
1	19520.000	48.68	-5.52	43.16	74.00	-30.84	peak
2	20240.000	49.32	-5.61	43.71	74.00	-30.29	peak
3	21432.000	48.74	-4.71	44.03	74.00	-29.97	peak
4	23216.000	47.51	-3.38	44.13	74.00	-29.87	peak
5	24568.000	46.60	-2.33	44.27	74.00	-29.73	peak
6	25728.000	45.61	-0.72	44.89	74.00	-29.11	peak

8.2.6. SPURIOUS EMISSIONS(30 MHz~1 GHz)

Test Mode:	802.11b	Frequency(MHz):	2412
Polarity:	Horizontal	Test Voltage:	DC12V

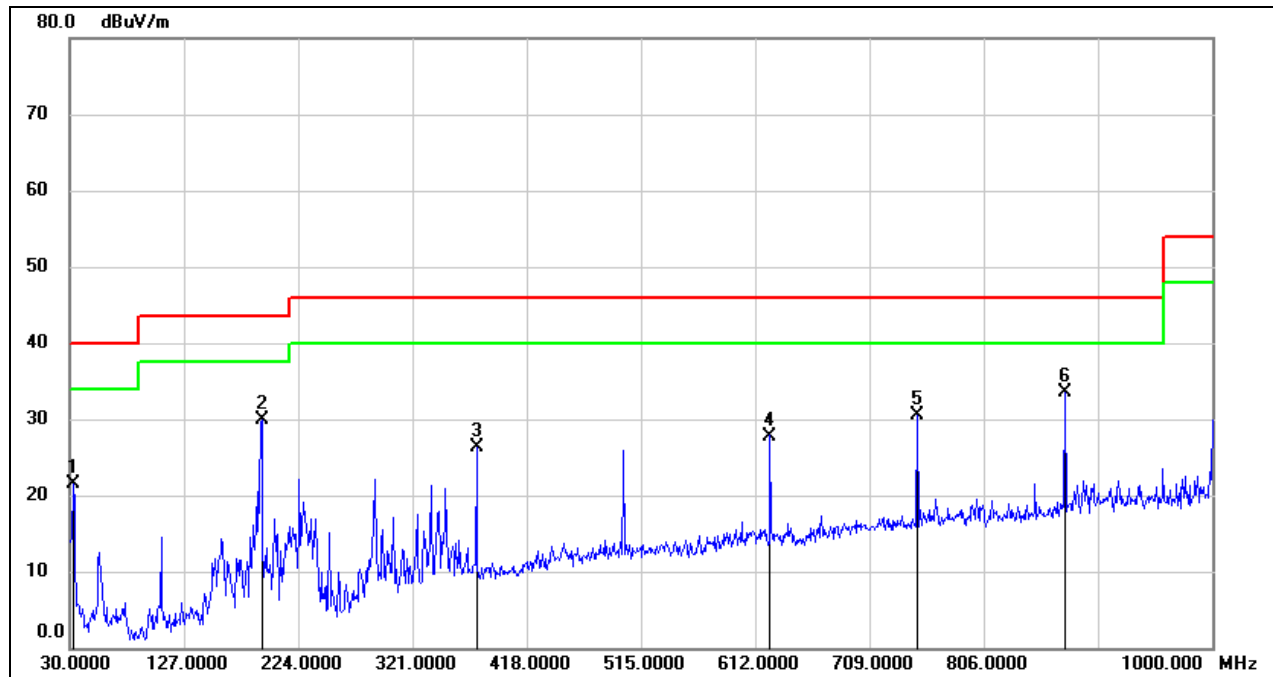

No.	Frequency (MHz)	Reading (dBuV)	Correct (dB/m)	Result (dBuV/m)	Limit (dBuV/m)	Margin (dB)	Remark
1	32.9100	40.11	-18.69	21.42	40.00	-18.58	QP
2	192.9600	46.57	-16.66	29.91	43.50	-13.59	QP
3	375.3200	39.16	-12.92	26.24	46.00	-19.76	QP
4	624.6100	37.23	-9.43	27.80	46.00	-18.20	QP
5	749.7400	37.56	-7.14	30.42	46.00	-15.58	QP
6	874.8700	38.90	-5.44	33.46	46.00	-12.54	QP

Test Mode:	802.11b	Frequency(MHz):	2412
Polarity:	Vertical	Test Voltage:	DC12V

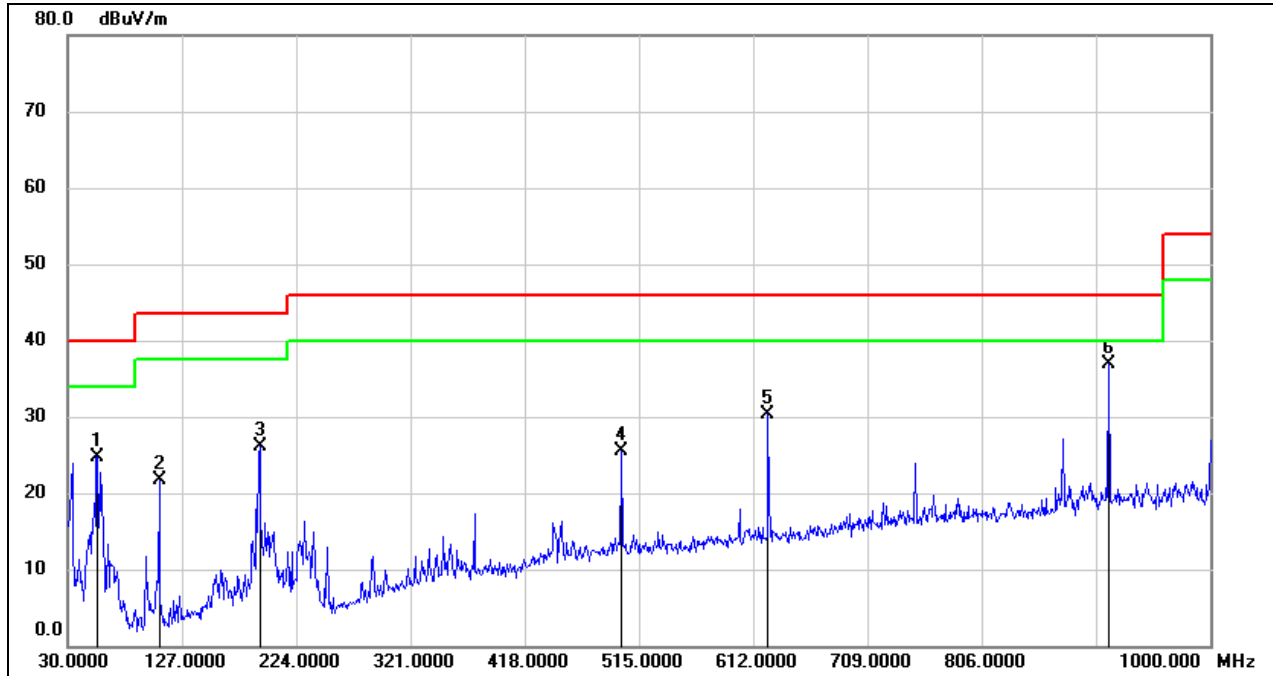

No.	Frequency (MHz)	Reading (dBuV)	Correct (dB/m)	Result (dBuV/m)	Limit (dBuV/m)	Margin (dB)	Remark
1	55.2200	45.11	-20.43	24.68	40.00	-15.32	QP
2	107.6000	42.13	-20.52	21.61	43.50	-21.89	QP
3	192.9600	42.80	-16.66	26.14	43.50	-17.36	QP
4	500.4500	36.23	-10.67	25.56	46.00	-20.44	QP
5	624.6100	39.83	-9.43	30.40	46.00	-15.60	QP
6	913.6700	41.66	-4.67	36.99	46.00	-9.01	QP

9. ANTENNA REQUIREMENT

REQUIREMENT

Please refer to FCC part 15.203

An intentional radiator shall be designed to ensure that no antenna other than that furnished by the responsible party shall be used with the device. The use of a permanently attached antenna or of an antenna that uses a unique coupling to the intentional radiator shall be considered sufficient to comply with the provisions of this section. The manufacturer may design the unit so that a broken antenna can be replaced by the user, but the use of a standard antenna jack or electrical connector is prohibited.

Please refer to FCC part 15.247(b)(4)

The conducted output power limit specified in paragraph (b) of this section is based on the use of antennas with directional gains that do not exceed 6 dBi. Except as shown in paragraph (c) of this section, if transmitting antennas of directional gain greater than 6 dBi are used, the conducted output power from the intentional radiator shall be reduced below the stated values in paragraphs (b)(1), (b)(2), and (b)(3) of this section, as appropriate, by the amount in dB that the directional gain of the antenna exceeds 6 dBi.

DESCRIPTION

Pass

10. TEST DATA FOR EXTERNAL ANTENNA

10.1. APPENDIX A1: DTS BANDWIDTH

10.1.1. Test Result

Test Mode	Antenna	Frequency[MHz]	DTS BW [MHz]	FL[MHz]	FH[MHz]	Limit[MHz]	Verdict
11B	Ant2	2412	9.080	2407.480	2416.560	≥0.5	PASS
		2437	9.080	2432.480	2441.560	≥0.5	PASS
		2462	9.040	2457.480	2466.520	≥0.5	PASS
11G	Ant2	2412	13.880	2404.480	2418.360	≥0.5	PASS
		2437	13.840	2430.720	2444.560	≥0.5	PASS
		2462	13.760	2455.120	2468.880	≥0.5	PASS
11N20SISO	Ant2	2412	13.840	2405.720	2419.560	≥0.5	PASS
		2437	13.440	2429.440	2442.880	≥0.5	PASS
		2462	14.040	2454.480	2468.520	≥0.5	PASS

10.1.2. Test Graphs





11G Ant2 2412



11G Ant2 2437



11G Ant2 2462





11N20SISO Ant2 2462

10.2. APPENDIX B1: OCCUPIED CHANNEL BANDWIDTH

10.2.1. Test Result

Test Mode	Antenna	Frequency[MHz]	OCB [MHz]	FL[MHz]	FH[MHz]	Verdict
11B	Ant2	2412	13.777	2405.1601	2418.9371	PASS
		2437	13.956	2430.0576	2444.0136	PASS
		2462	14.041	2454.9581	2468.9991	PASS
11G	Ant2	2412	16.658	2403.7015	2420.3595	PASS
		2437	17.302	2428.3768	2445.6788	PASS
		2462	16.684	2453.6345	2470.3185	PASS
11N20SISO	Ant2	2412	17.688	2403.1684	2420.8564	PASS
		2437	17.998	2428.0188	2446.0168	PASS
		2462	17.752	2453.1305	2470.8825	PASS

10.2.2. Test Graphs



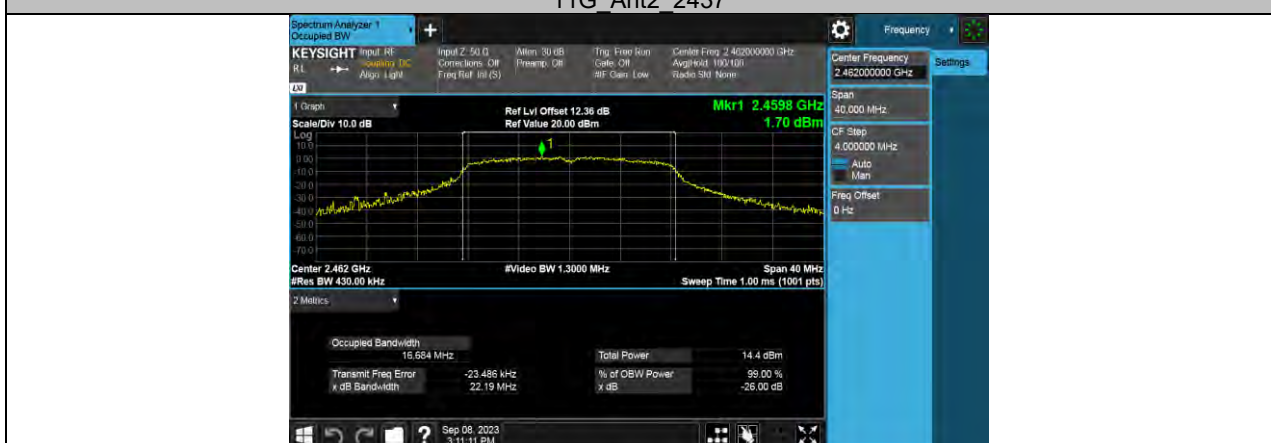

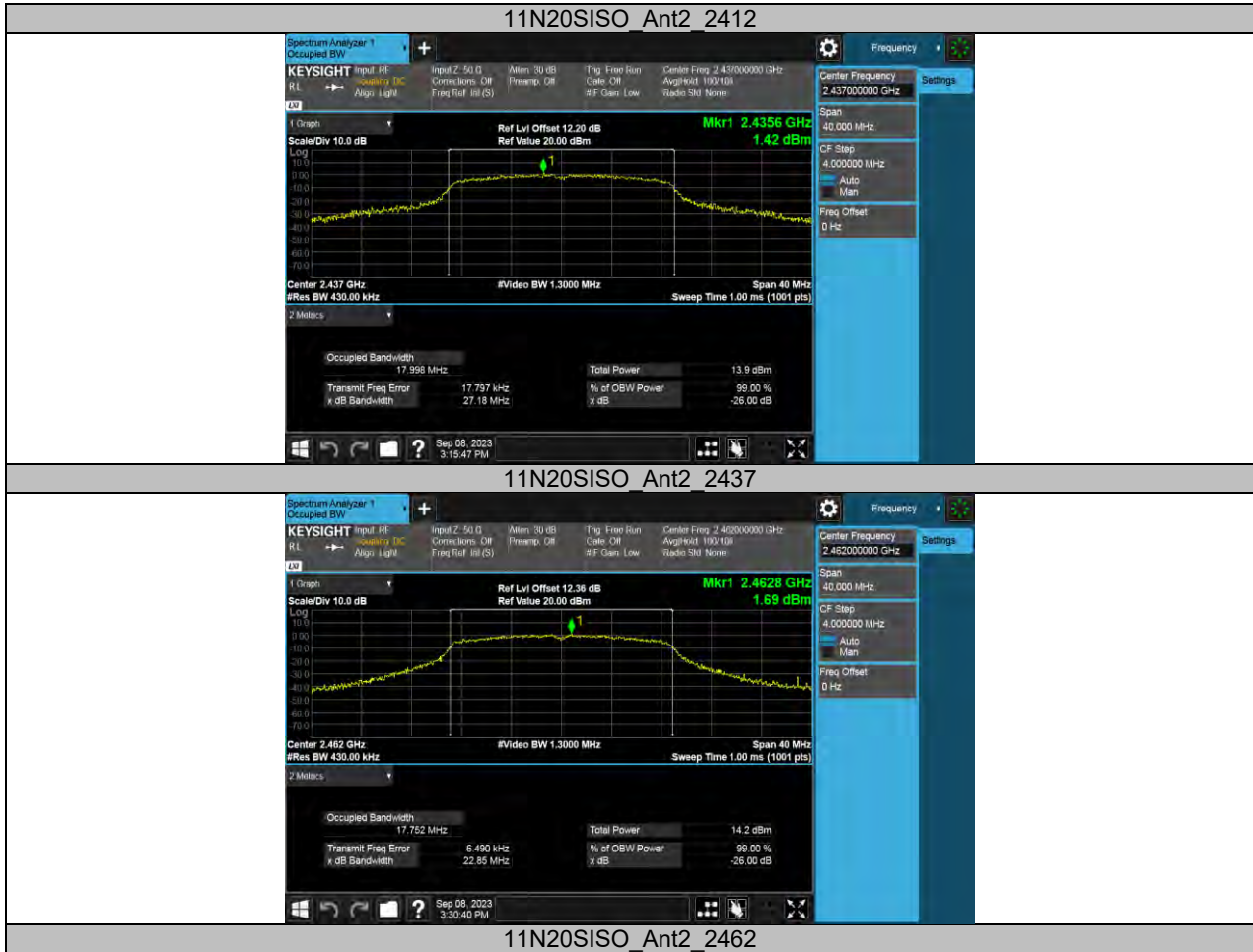

10.3. APPENDIX C1: MAXIMUM CONDUCTED OUTPUT POWER

10.3.1. Test Result

Test Mode	Antenna	Frequency[MHz]	Result[dBm]	Limit[dBm]	Verdict
11B	Ant2	2412	12.69	≤30.00	PASS
		2437	13.17	≤30.00	PASS
		2462	14.12	≤30.00	PASS
11G	Ant2	2412	8.09	≤30.00	PASS
		2437	9.16	≤30.00	PASS
		2462	8.44	≤30.00	PASS
11N20SISO	Ant2	2412	7.64	≤30.00	PASS
		2437	7.90	≤30.00	PASS
		2462	8.10	≤30.00	PASS

Note: 1. Conducted Power=Meas. Level+ Correction Factor

2. The Duty Cycle Factor (refer to section 7.5) had already compensated to the test data.

10.4. APPENDIX D1: MAXIMUM POWER SPECTRAL DENSITY

10.4.1. Test Result

Test Mode	Antenna	Frequency[MHz]	Result[dBm/3kHz]	Limit[dBm/3kHz]	Verdict
11B	Ant2	2412	-14.85	≤8.00	PASS
		2437	-14.6	≤8.00	PASS
		2462	-13.41	≤8.00	PASS
11G	Ant2	2412	-22.84	≤8.00	PASS
		2437	-21.99	≤8.00	PASS
		2462	-6.15	≤8.00	PASS
11N20SISO	Ant2	2412	-23.68	≤8.00	PASS
		2437	-23.45	≤8.00	PASS
		2462	-23.08	≤8.00	PASS

10.4.2. Test Graphs



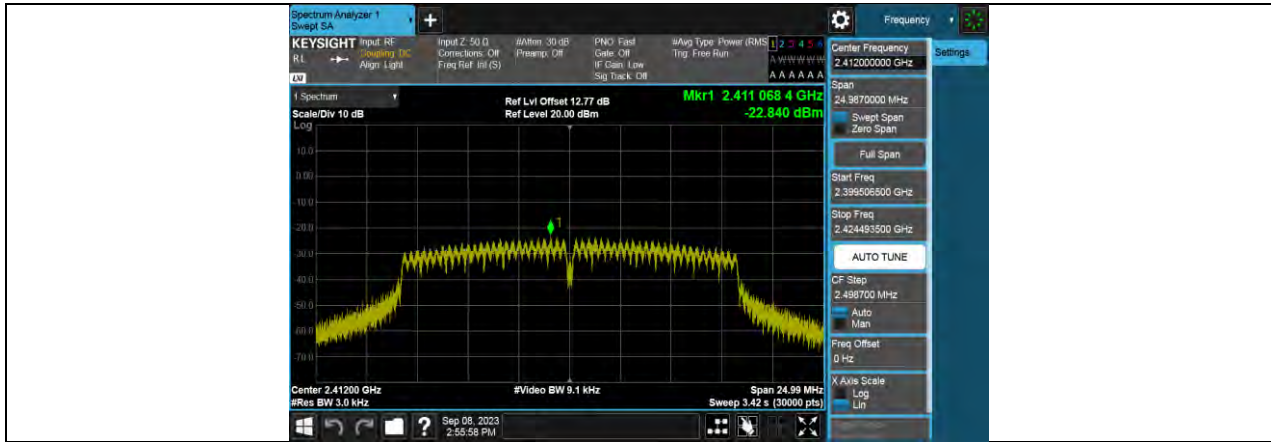

11G Ant2 2412

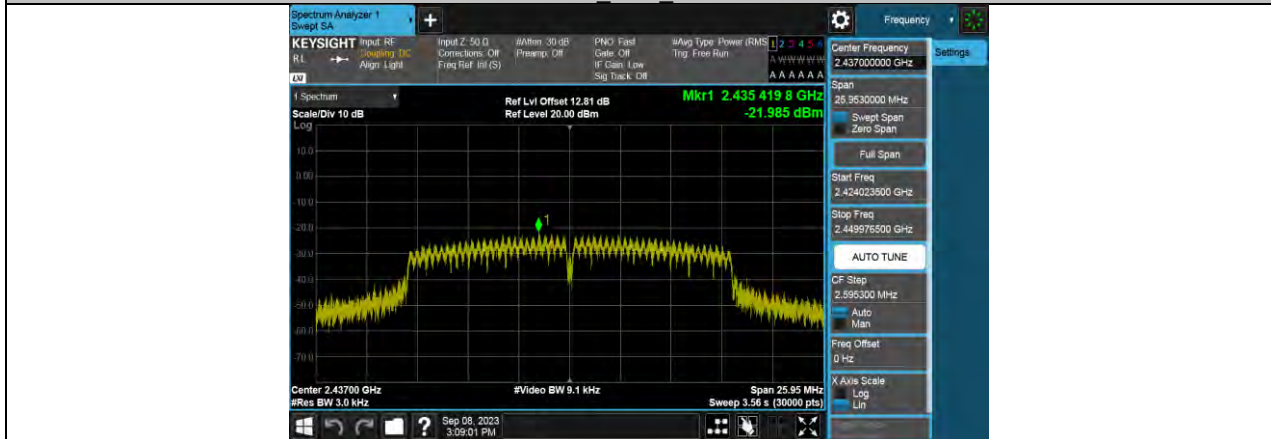

11G Ant2 2437

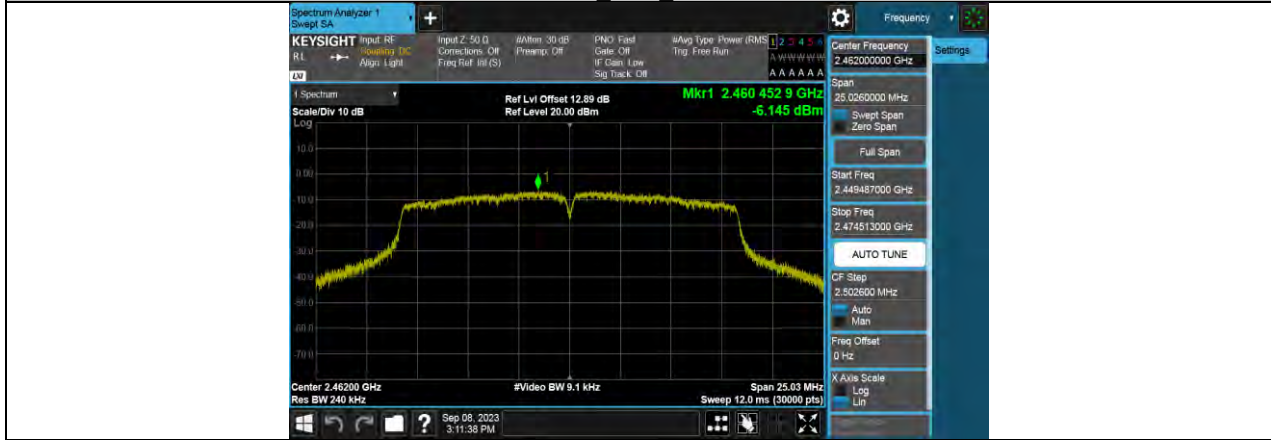

11G Ant2 2462

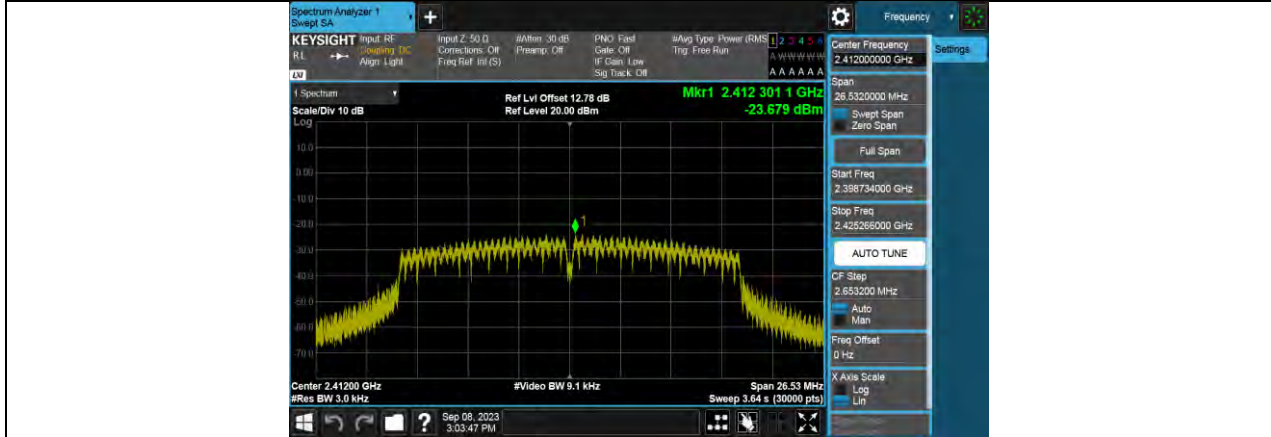

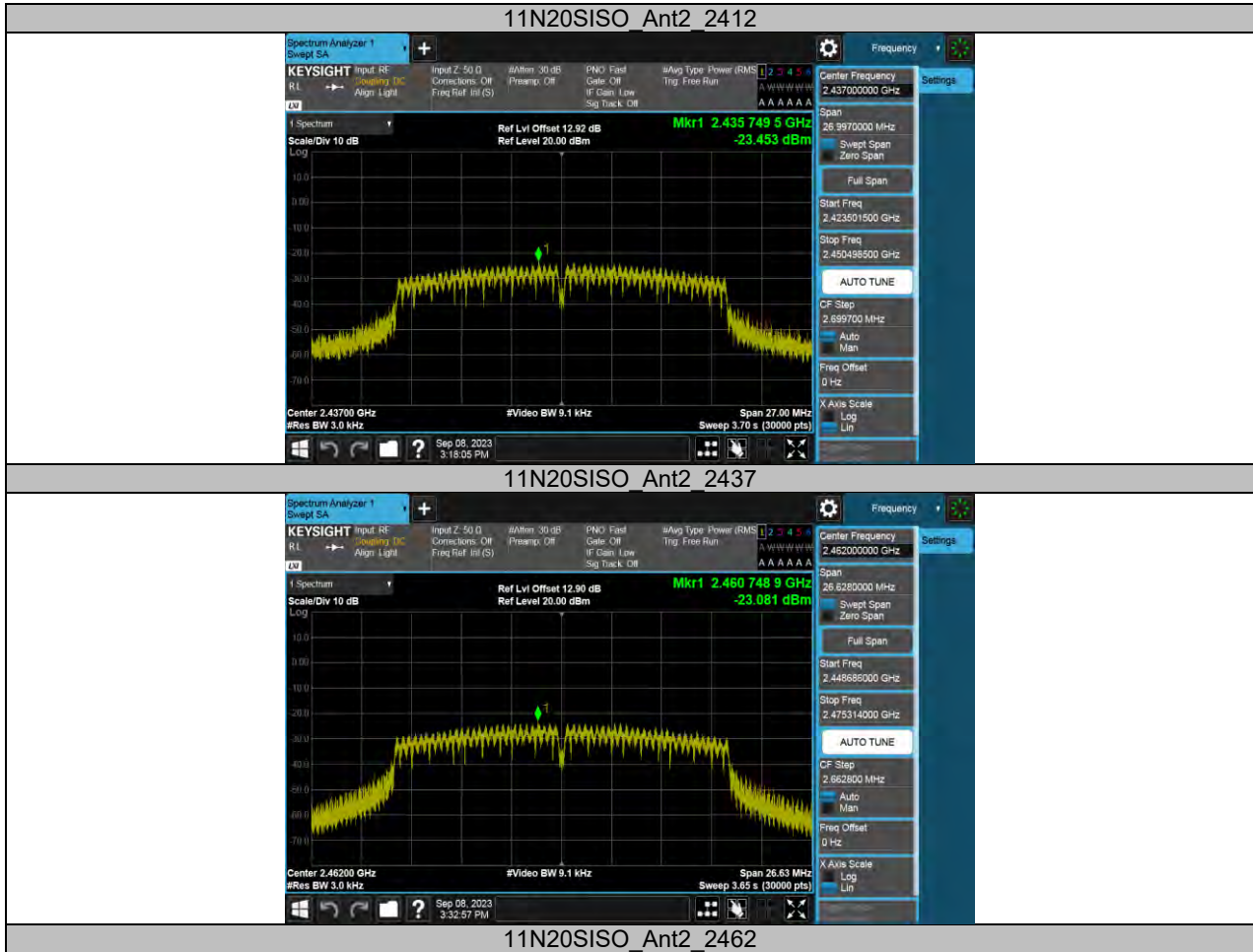

10.5. APPENDIX E1: BAND EDGE MEASUREMENTS

10.5.1. Test Result

Test Mode	Antenna	ChName	Frequency [MHz]	RefLevel [dBm]	Result[dBm]	Limit[dBm]	Verdict
11B	Ant2	Low	2412	2.99	-38.86	≤-27.01	PASS
		High	2462	4.32	-45.83	≤-25.68	PASS
11G	Ant2	Low	2412	-1.69	-36.49	≤-31.69	PASS
		High	2462	-2.34	-45.59	≤-32.34	PASS
11N20SISO	Ant2	Low	2412	-2.15	-36.72	≤-32.15	PASS
		High	2462	-1.79	-45.17	≤-31.79	PASS

10.5.2. Test Graphs

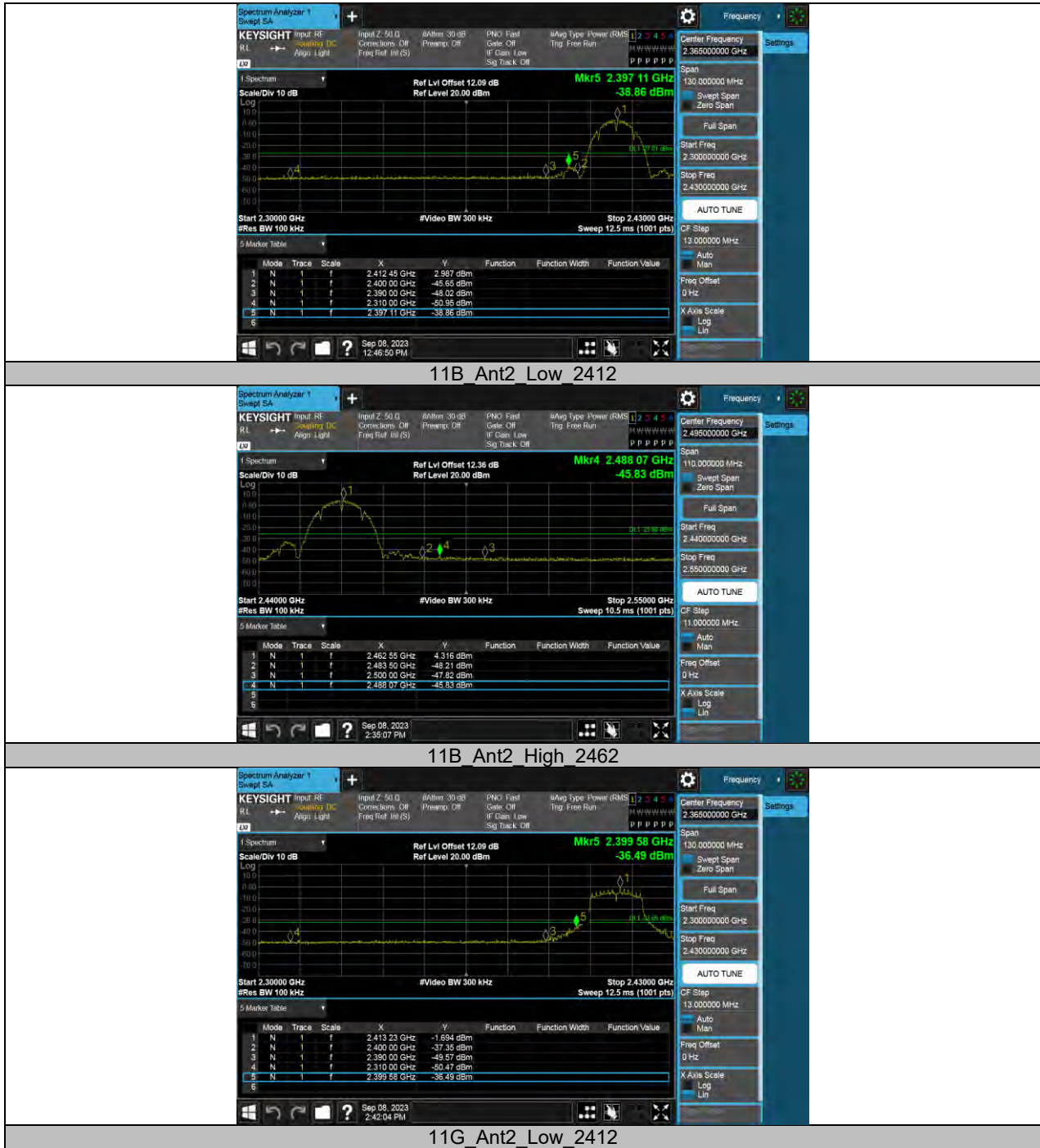



10.6. APPENDIX F1: CONDUCTED SPURIOUS EMISSION

10.6.1. Test Result

Test Mode	Antenna	Frequency[MHz]	FreqRange [Mhz]	Result [dBm]	Limit [dBm]	Verdict
11B	Ant2	2412	Reference	2.82	---	PASS
			30~1000	-57.88	≤-27.18	PASS
			1000~26500	-49.66	≤-27.18	PASS
		2437	Reference	2.71	---	PASS
			30~1000	-58.59	≤-27.29	PASS
			1000~26500	-49.25	≤-27.29	PASS
		2462	Reference	3.58	---	PASS
			30~1000	-57.88	≤-26.42	PASS
			1000~26500	-50.01	≤-26.42	PASS
11G	Ant2	2412	Reference	-4.98	---	PASS
			30~1000	-58.21	≤-34.98	PASS
			1000~26500	-49.99	≤-34.98	PASS
		2437	Reference	-4.46	---	PASS
			30~1000	-58.63	≤-34.46	PASS
			1000~26500	-49.52	≤-34.46	PASS
		2462	Reference	-3.72	---	PASS
			30~1000	-58.91	≤-33.72	PASS
			1000~26500	-48.83	≤-33.72	PASS
11N20SISO	Ant2	2412	Reference	-6.22	---	PASS
			30~1000	-58.69	≤-36.22	PASS
			1000~26500	-49.5	≤-36.22	PASS
		2437	Reference	-5.85	---	PASS
			30~1000	-58.51	≤-35.85	PASS
			1000~26500	-49.51	≤-35.85	PASS
		2462	Reference	-4.33	---	PASS
			30~1000	-58.72	≤-34.33	PASS
			1000~26500	-48.97	≤-34.33	PASS

10.6.2. Test Graphs



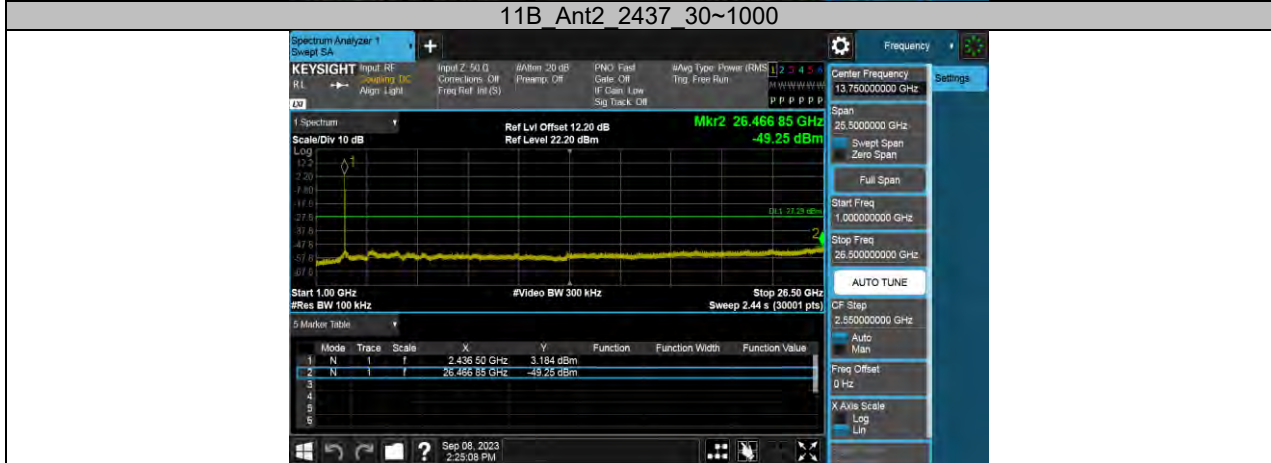
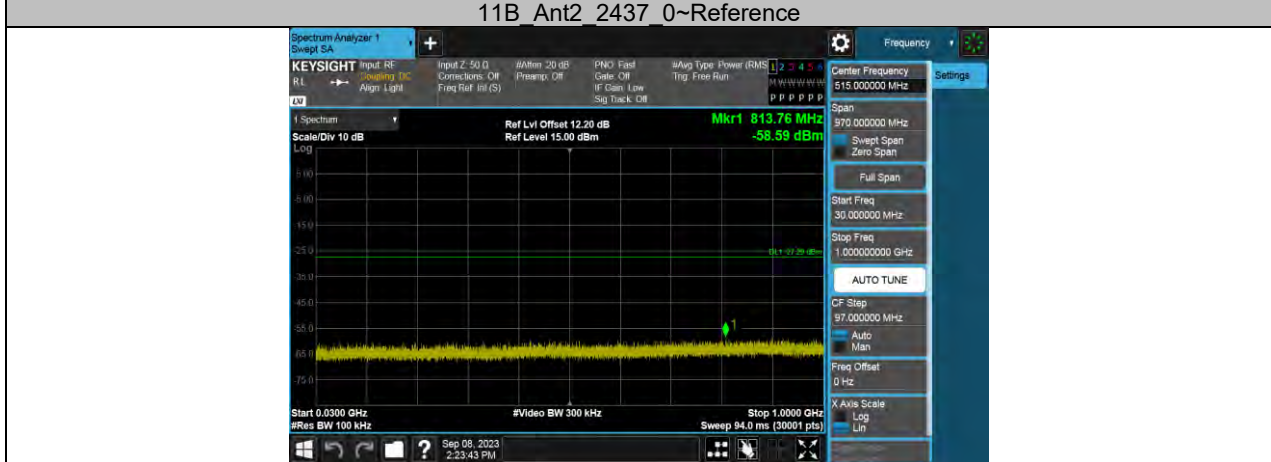

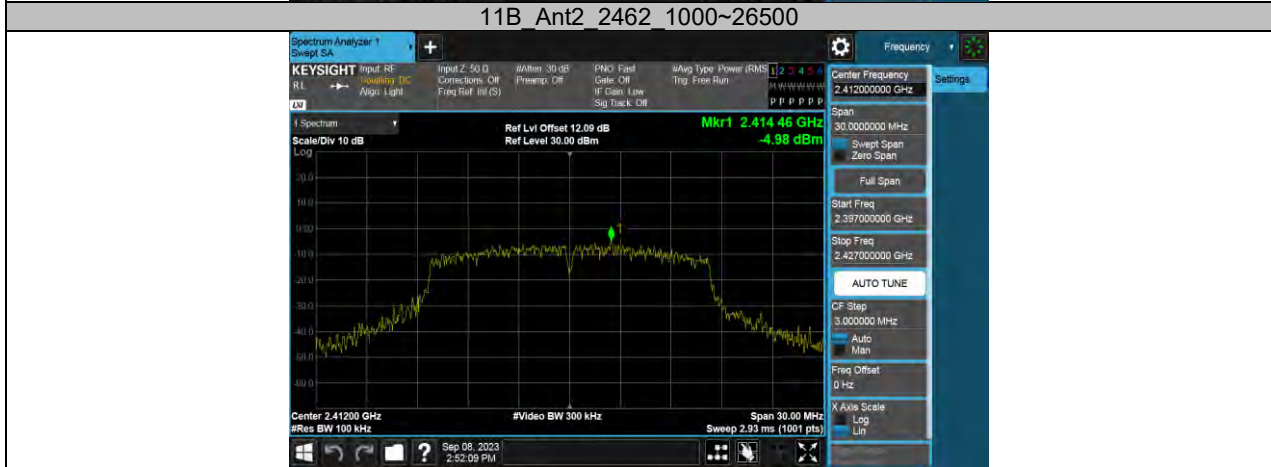
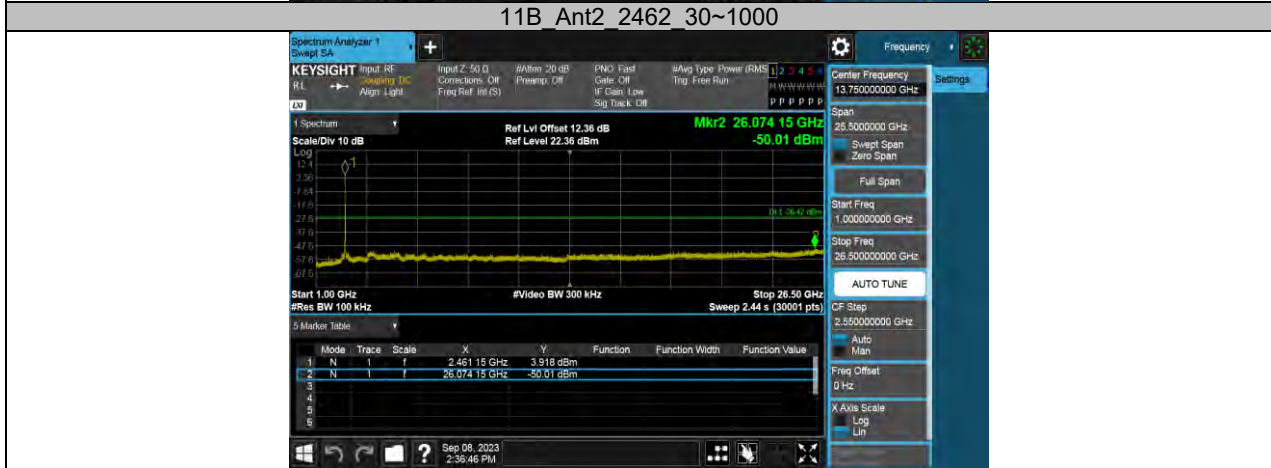
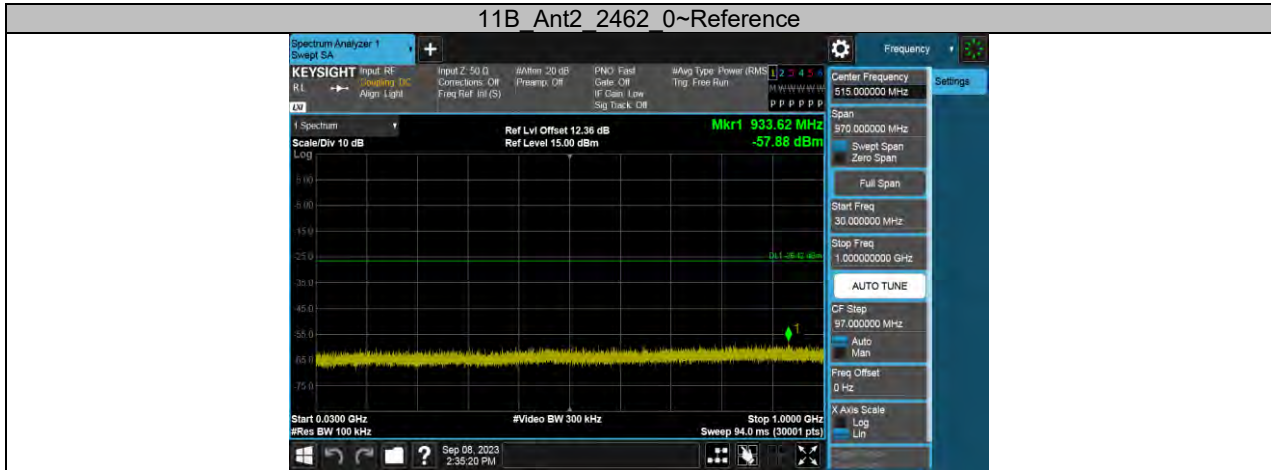

11G_Ant2_2412_0~Reference

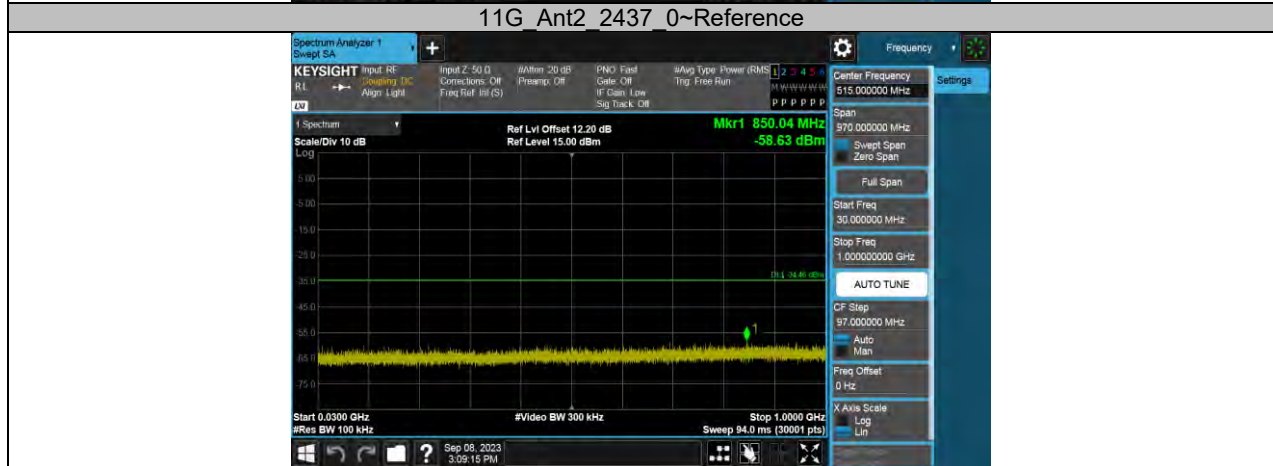
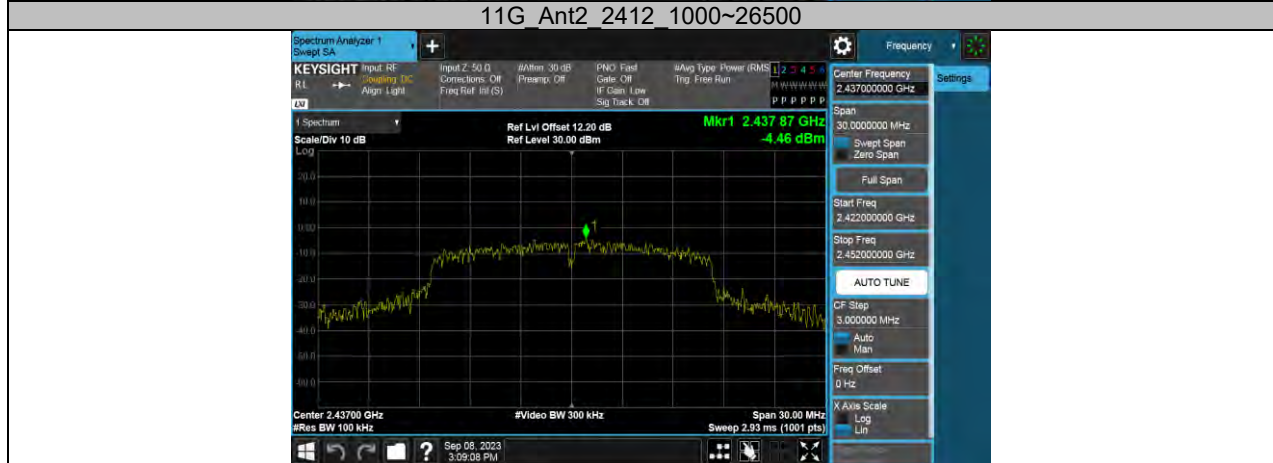
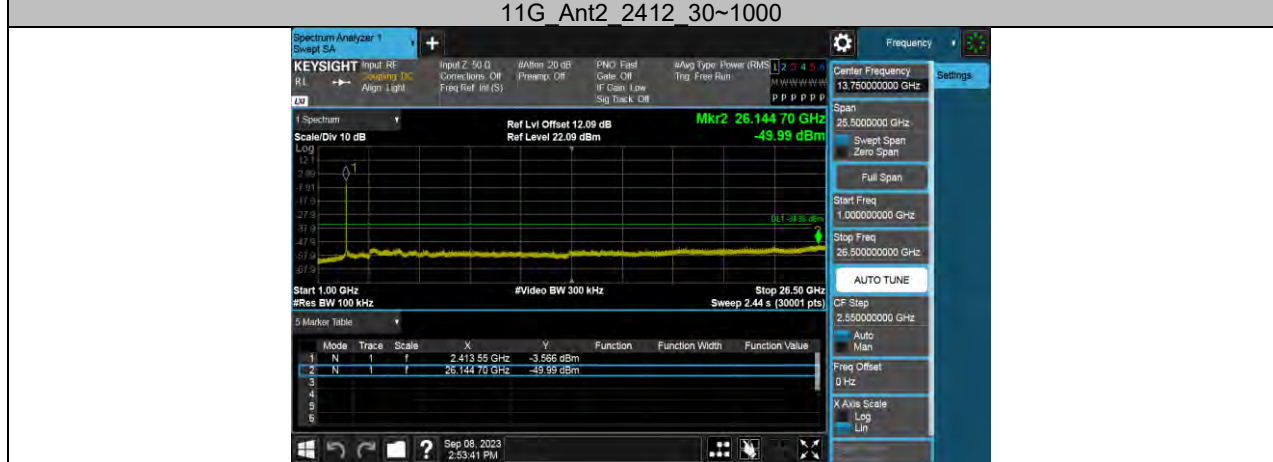

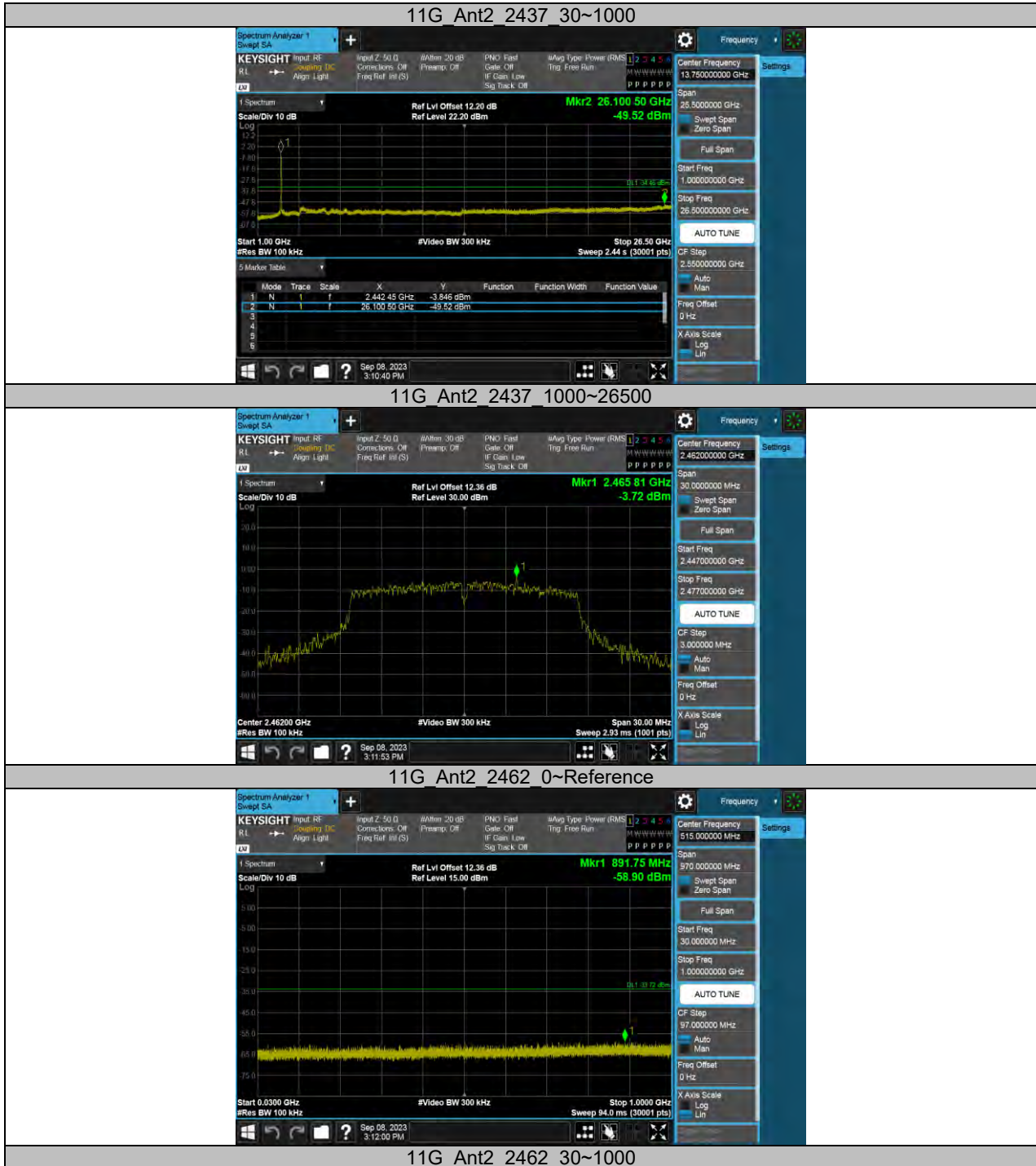

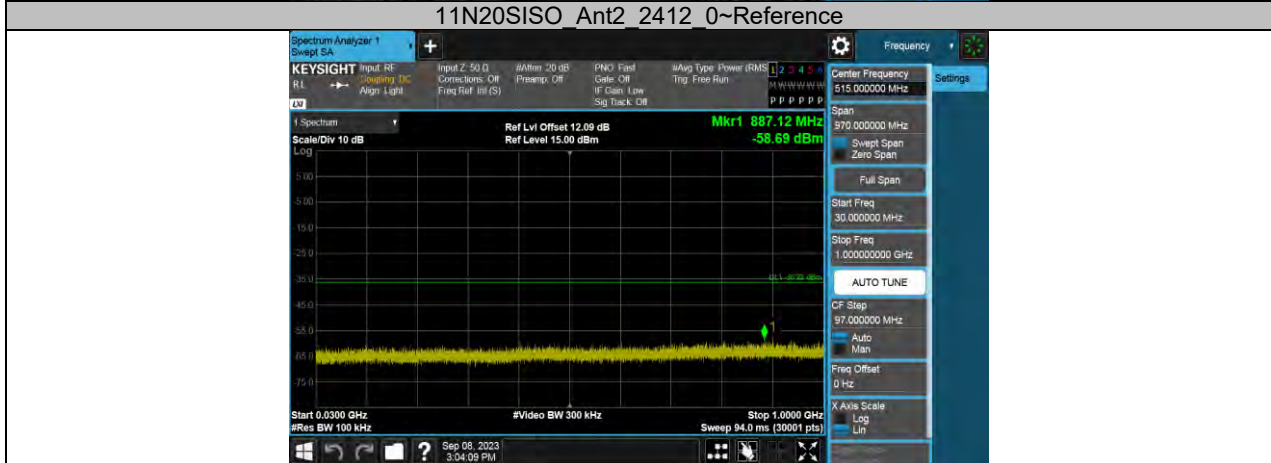

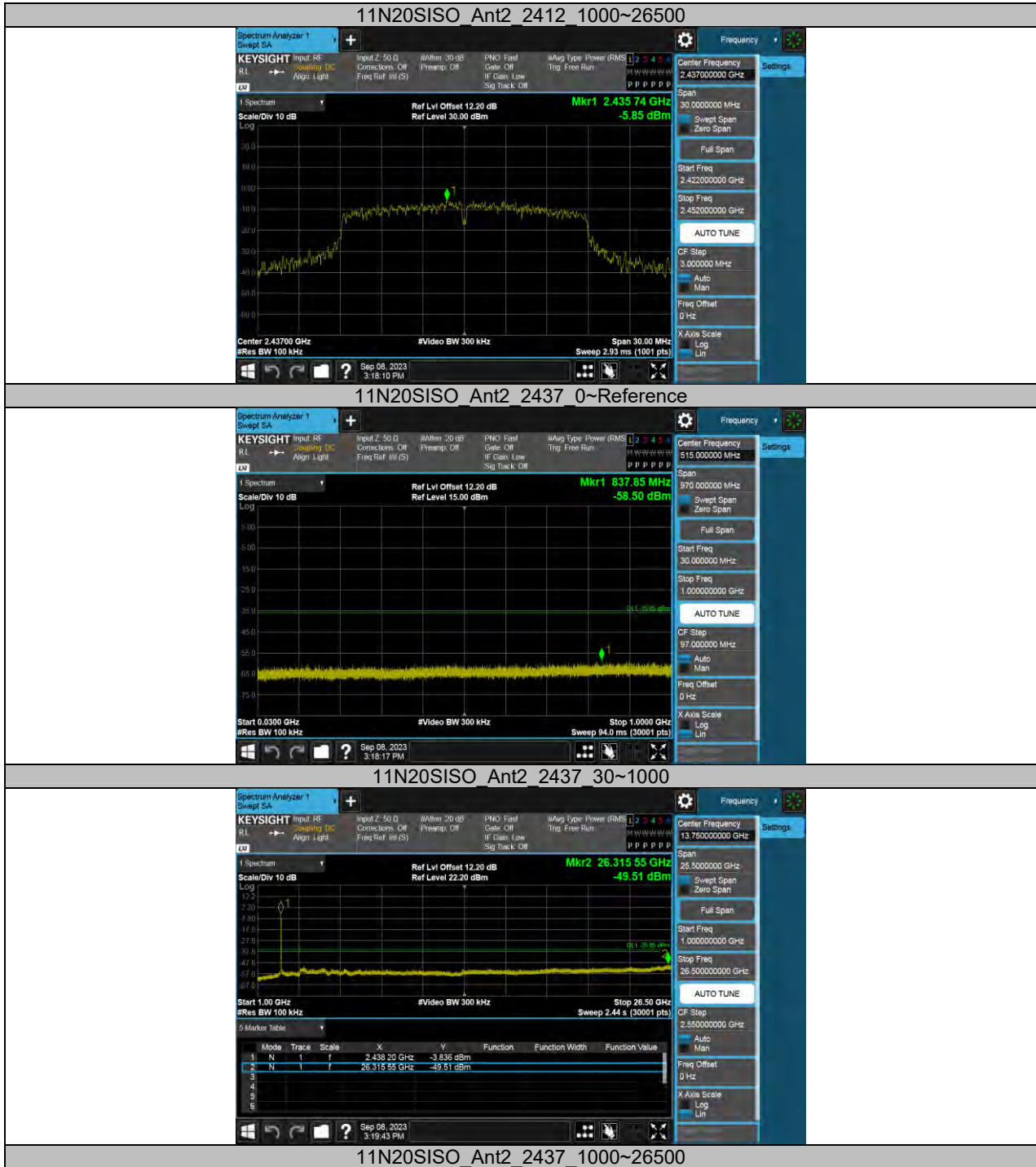

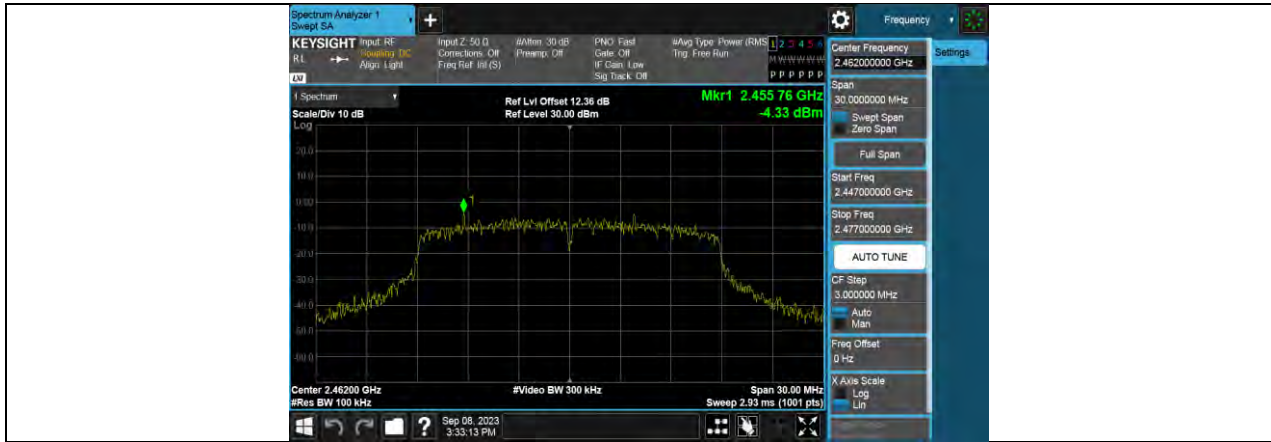

11N20SISO Ant2 2462 0~Reference

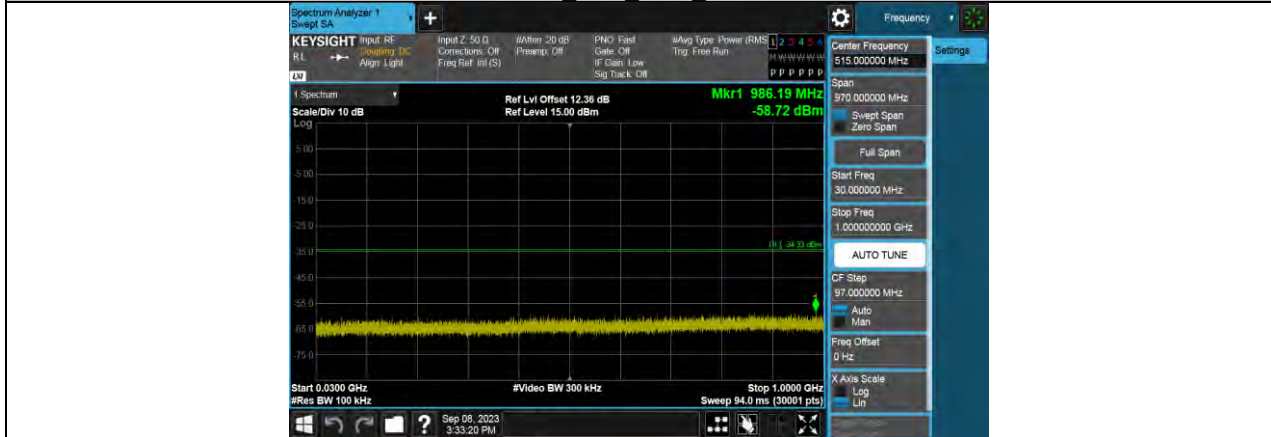

11N20SISO Ant2 2462 30~1000



11N20SISO Ant2 2462 1000~26500

10.7. APPENDIX G1: DUTY CYCLE

10.7.1. Test Result

Test Mode	On Time (msec)	Period (msec)	Duty Cycle x (Linear)	Duty Cycle (%)	Duty Cycle Correction Factor (dB)	1/T Minimum VBW (kHz)	Final setting For VBW (kHz)
11B	8.19	8.66	0.9457	94.57	0.24	0.12	1
11G	1.36	1.59	0.8553	85.53	0.68	0.74	1
11N20SISO	1.27	1.49	0.8523	85.23	0.69	0.79	1

Note:

Duty Cycle Correction Factor=10log (1/x).

Where: x is Duty Cycle (Linear)

Where: T is On Time

If that calculated VBW is not available on the analyzer then the next higher value should be used.

10.7.2. Test Graphs



11. TEST DATA FOR INTERNAL ANTENNA

11.1. APPENDIX A2: DTS BANDWIDTH

11.1.1. Test Result

Test Mode	Antenna	Frequency[MHz]	DTS BW [MHz]	FL[MHz]	FH[MHz]	Limit[MHz]	Verdict
11B	Ant1	2412	9.080	2407.480	2416.560	≥0.5	PASS
		2437	9.120	2432.440	2441.560	≥0.5	PASS
		2462	9.120	2457.440	2466.560	≥0.5	PASS
11G	Ant1	2412	13.800	2404.480	2418.280	≥0.5	PASS
		2437	15.000	2429.560	2444.560	≥0.5	PASS
		2462	14.400	2455.160	2469.560	≥0.5	PASS
11N20SISO	Ant1	2412	14.960	2404.520	2419.480	≥0.5	PASS
		2437	15.000	2429.520	2444.520	≥0.5	PASS
		2462	15.000	2454.520	2469.520	≥0.5	PASS

11.1.2. Test Graphs



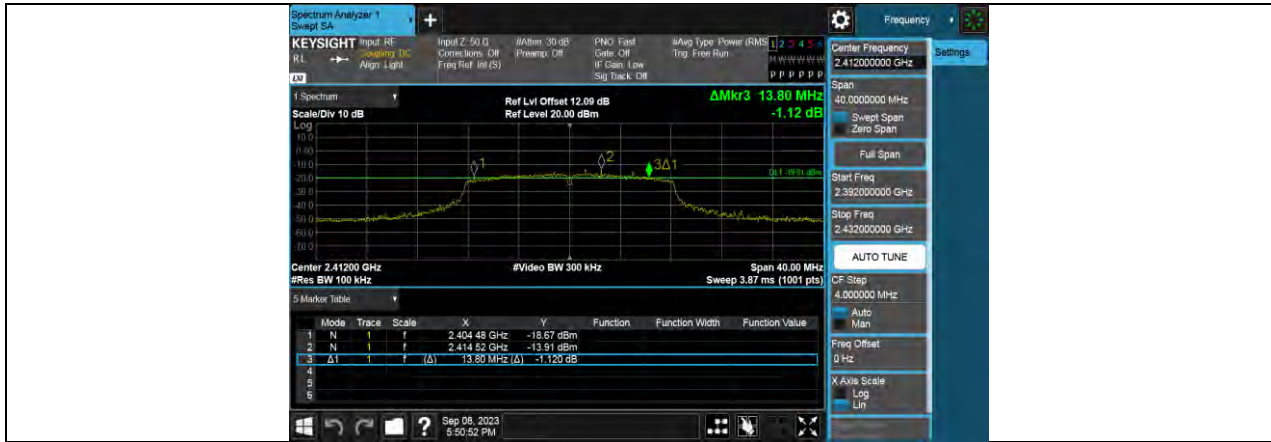

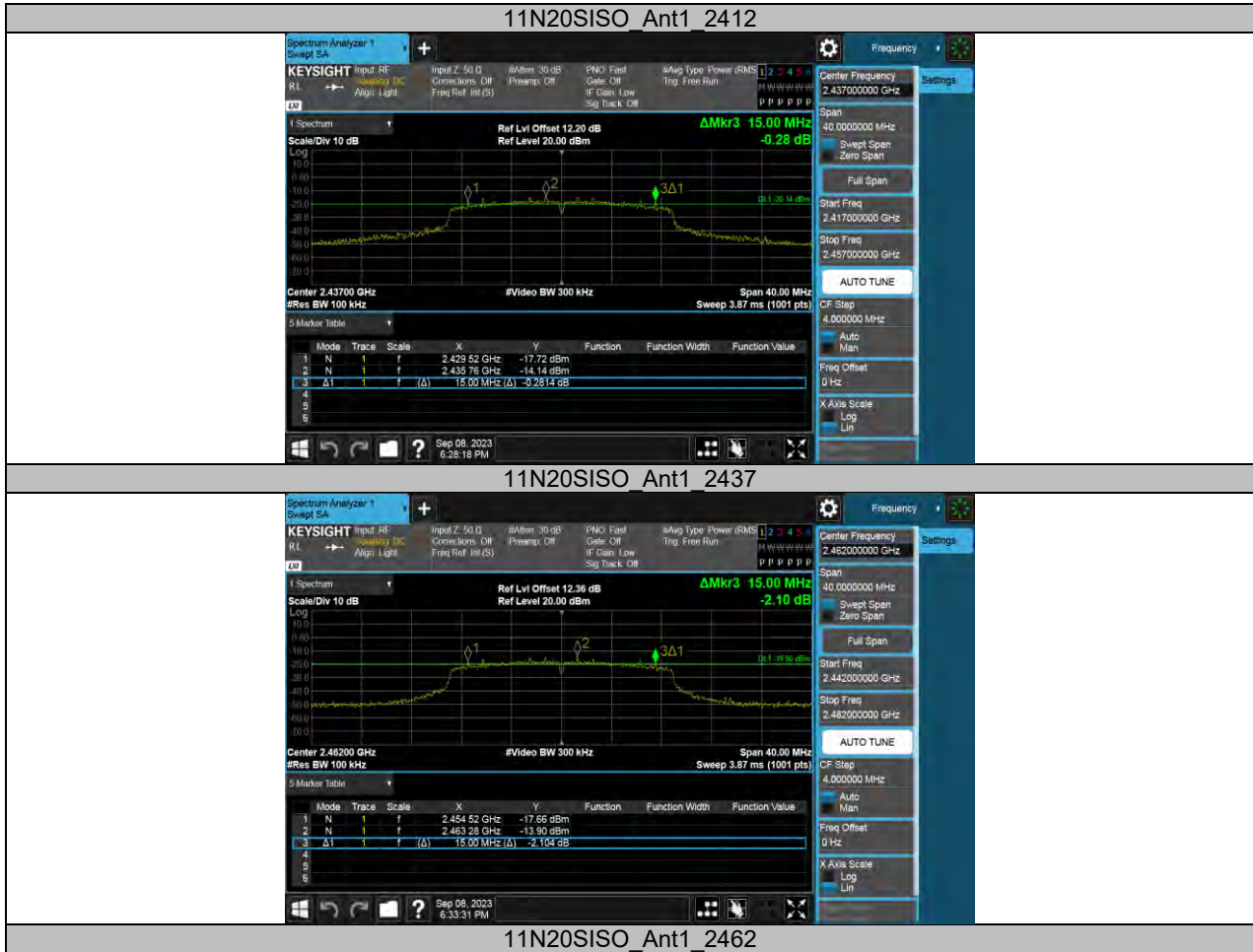

11.2. APPENDIX B2: OCCUPIED CHANNEL BANDWIDTH

11.2.1. Test Result

Test Mode	Antenna	Frequency[MHz]	OCB [MHz]	FL[MHz]	FH[MHz]	Verdict
11B	Ant1	2412	14.105	2405.0177	2419.1227	PASS
		2437	14.105	2429.9413	2444.0463	PASS
		2462	14.180	2454.8927	2469.0727	PASS
11G	Ant1	2412	16.795	2403.5710	2420.3660	PASS
		2437	17.455	2428.1784	2445.6334	PASS
		2462	16.766	2453.5555	2470.3215	PASS
11N20SISO	Ant1	2412	17.834	2403.1048	2420.9388	PASS
		2437	18.055	2427.9184	2445.9734	PASS
		2462	17.880	2453.0535	2470.9335	PASS

11.2.2. Test Graphs





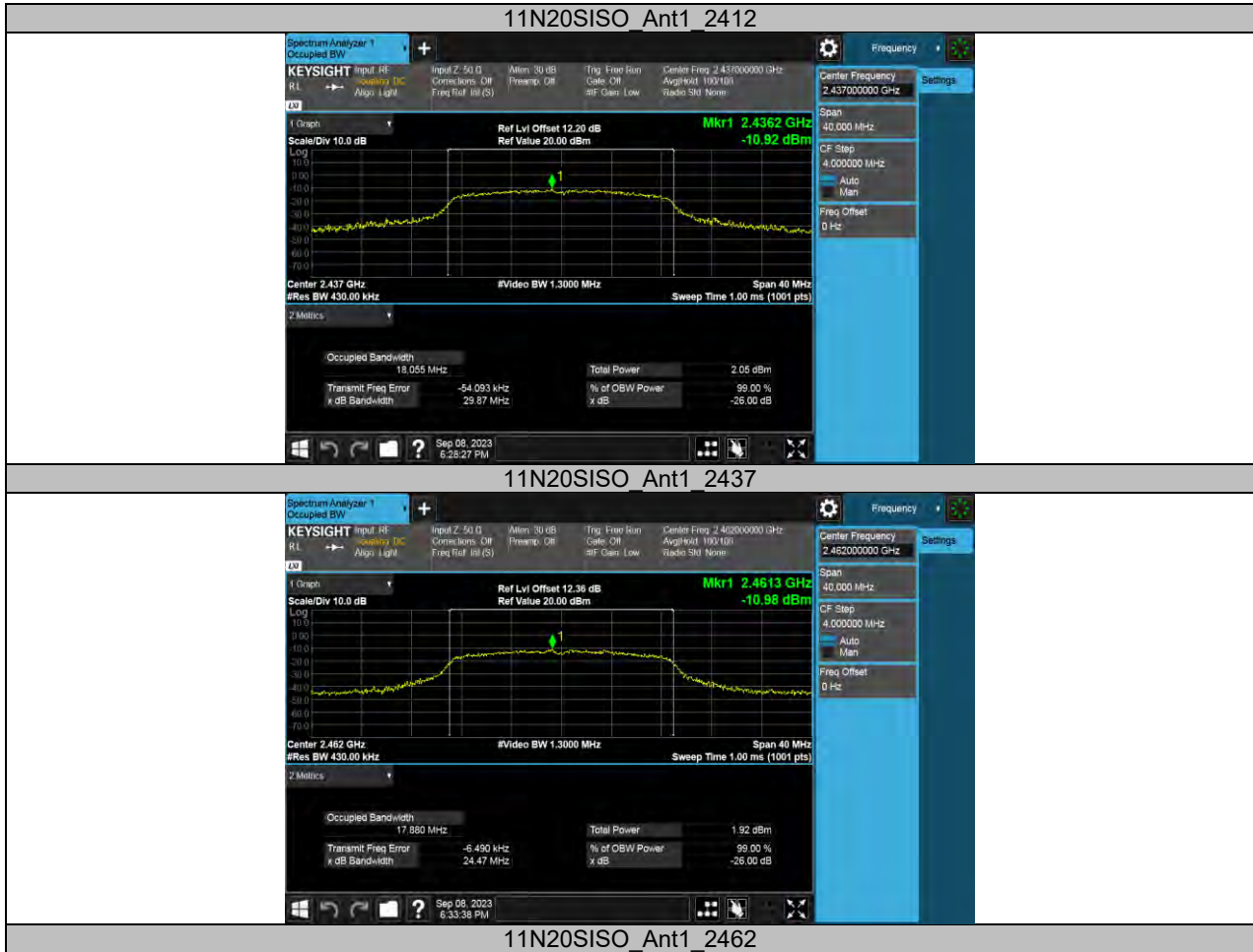

11.3. APPENDIX C2: MAXIMUM CONDUCTED OUTPUT POWER

11.3.1. Test Result

Test Mode	Antenna	Frequency[MHz]	Result[dBm]	Limit[dBm]	Verdict
11B	Ant1	2412	2.18	≤30.00	PASS
		2437	1.69	≤30.00	PASS
		2462	1.49	≤30.00	PASS
11G	Ant1	2412	-3.45	≤30.00	PASS
		2437	-2.72	≤30.00	PASS
		2462	-3.82	≤30.00	PASS
11N20SISO	Ant1	2412	-3.33	≤30.00	PASS
		2437	-4.04	≤30.00	PASS
		2462	-4.07	≤30.00	PASS

Note: 1. Conducted Power=Meas. Level+ Correction Factor

2. The Duty Cycle Factor (refer to section 7.5) had already compensated to the test data.

11.4. APPENDIX D2: MAXIMUM POWER SPECTRAL DENSITY

11.4.1. Test Result

Test Mode	Antenna	Frequency[MHz]	Result[dBm/3kHz]	Limit[dBm/3kHz]	Verdict
11B	Ant1	2412	-26.87	≤8.00	PASS
		2437	-27.04	≤8.00	PASS
		2462	-27.26	≤8.00	PASS
11G	Ant1	2412	-34.35	≤8.00	PASS
		2437	-17.64	≤8.00	PASS
		2462	-34.85	≤8.00	PASS
11N20SISO	Ant1	2412	-34.86	≤8.00	PASS
		2437	-35.51	≤8.00	PASS
		2462	-35.63	≤8.00	PASS

11.4.2. Test Graphs



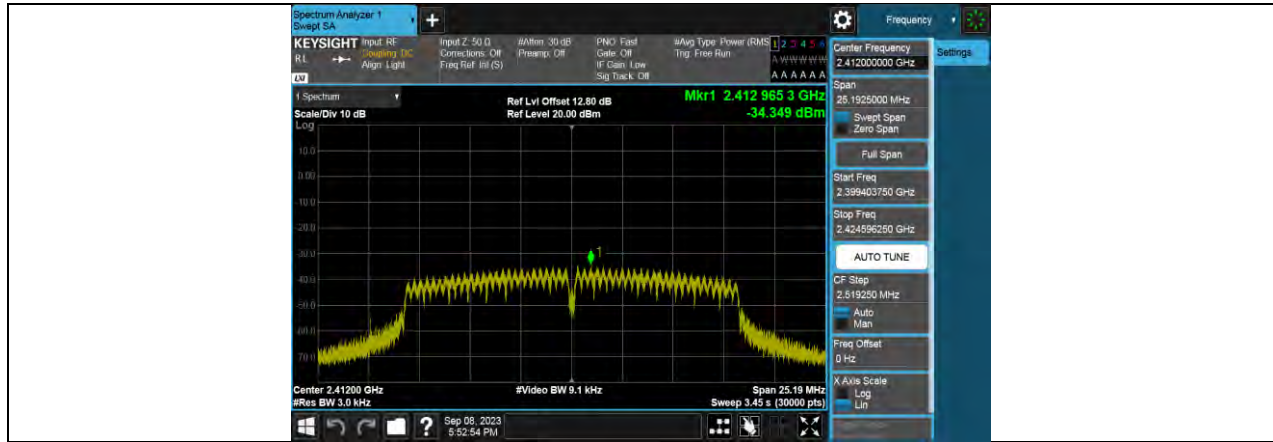

11G Ant1 2412



11G Ant1 2437

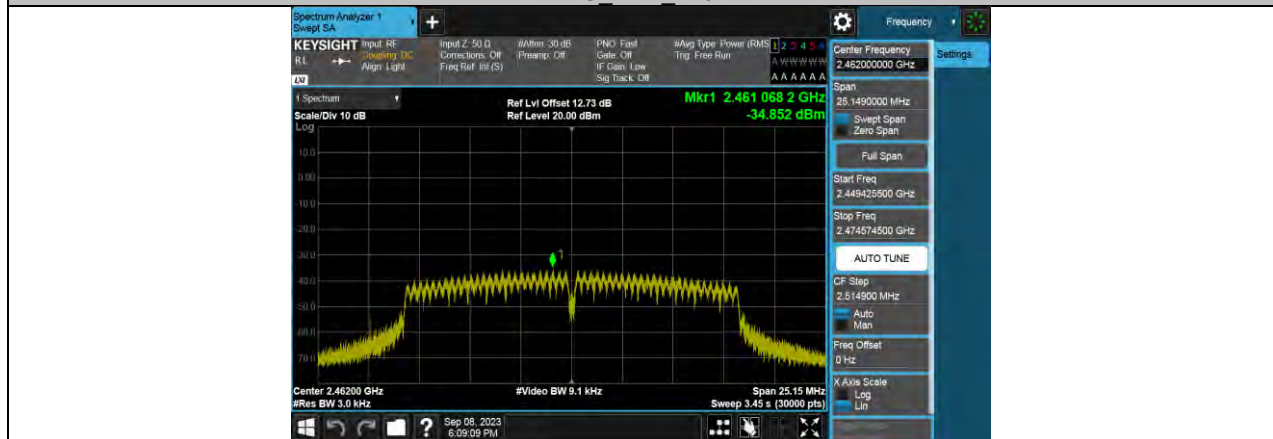

11G Ant1 2462

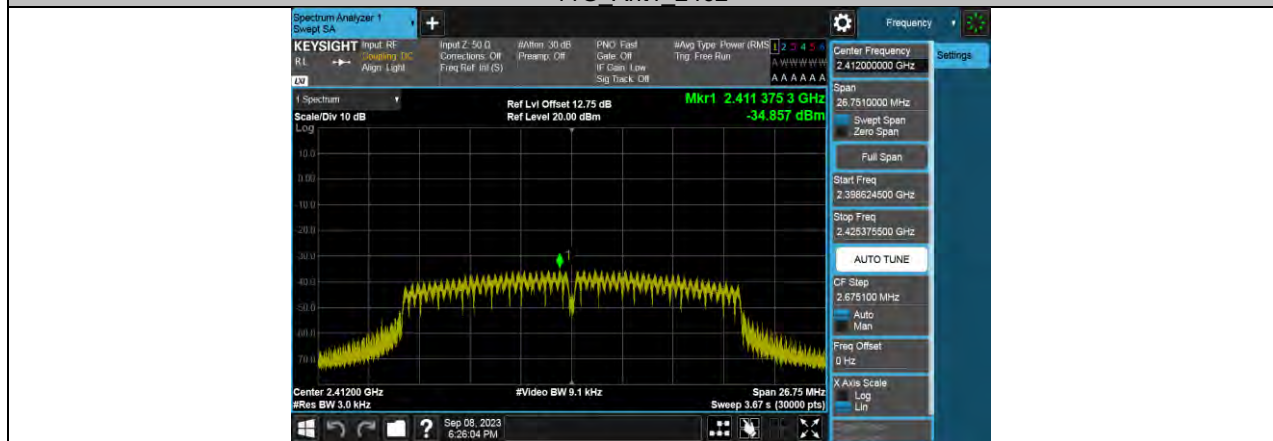

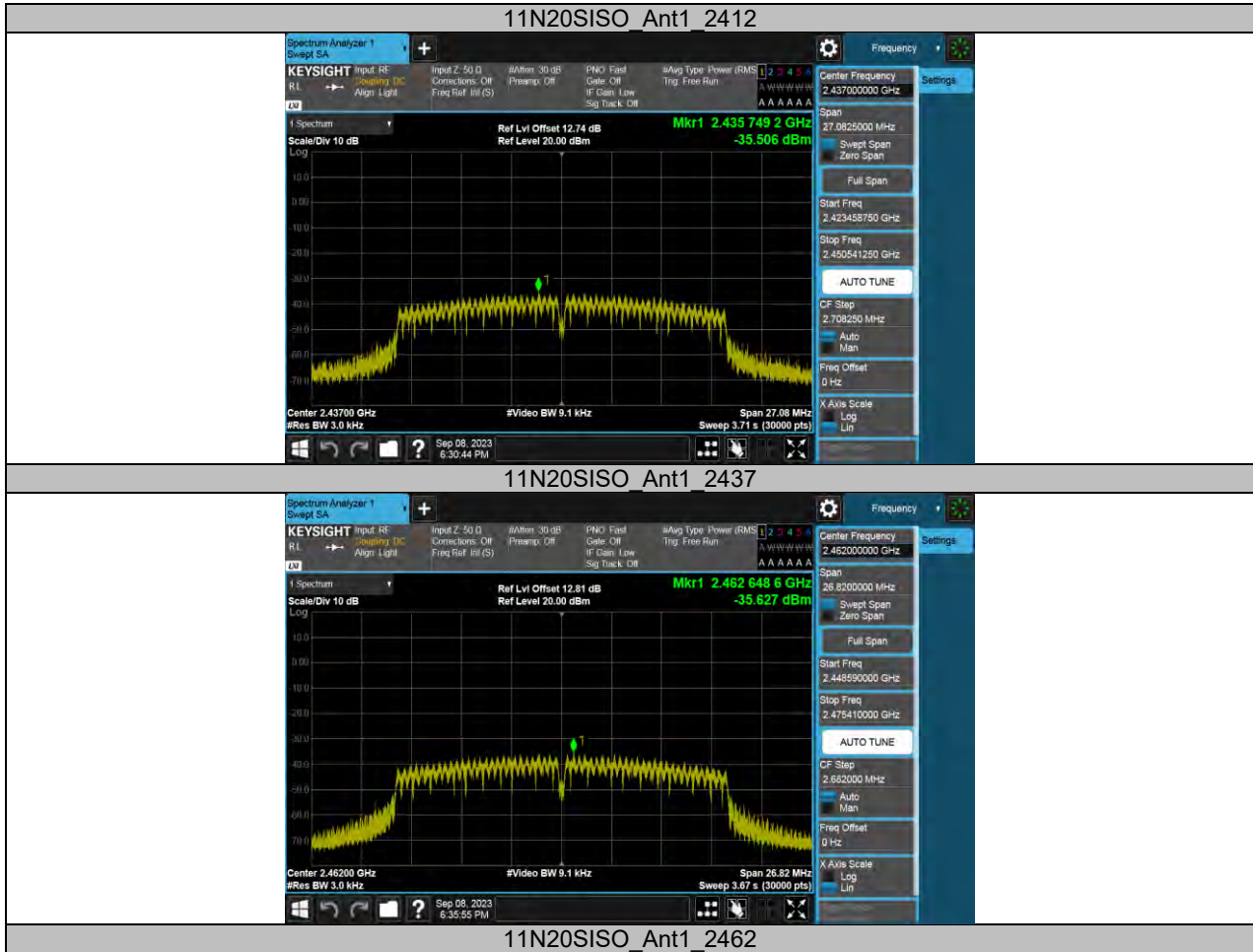

11.5. APPENDIX E2: BAND EDGE MEASUREMENTS

11.5.1. Test Result

Test Mode	Antenna	ChName	Frequency [MHz]	RefLevel [dBm]	Result[dBm]	Limit[dBm]	Verdict
11B	Ant1	Low	2412	-7.70	-43.59	≤ -37.7	PASS
		High	2462	-8.22	-45.99	≤ -38.22	PASS
11G	Ant1	Low	2412	-13.28	-45.02	≤ -43.28	PASS
		High	2462	-14.17	-46.85	≤ -44.17	PASS
11N20SISO	Ant1	Low	2412	-14.29	-46.31	≤ -44.29	PASS
		High	2462	-14.72	-47.03	≤ -44.72	PASS

11.5.2. Test Graphs

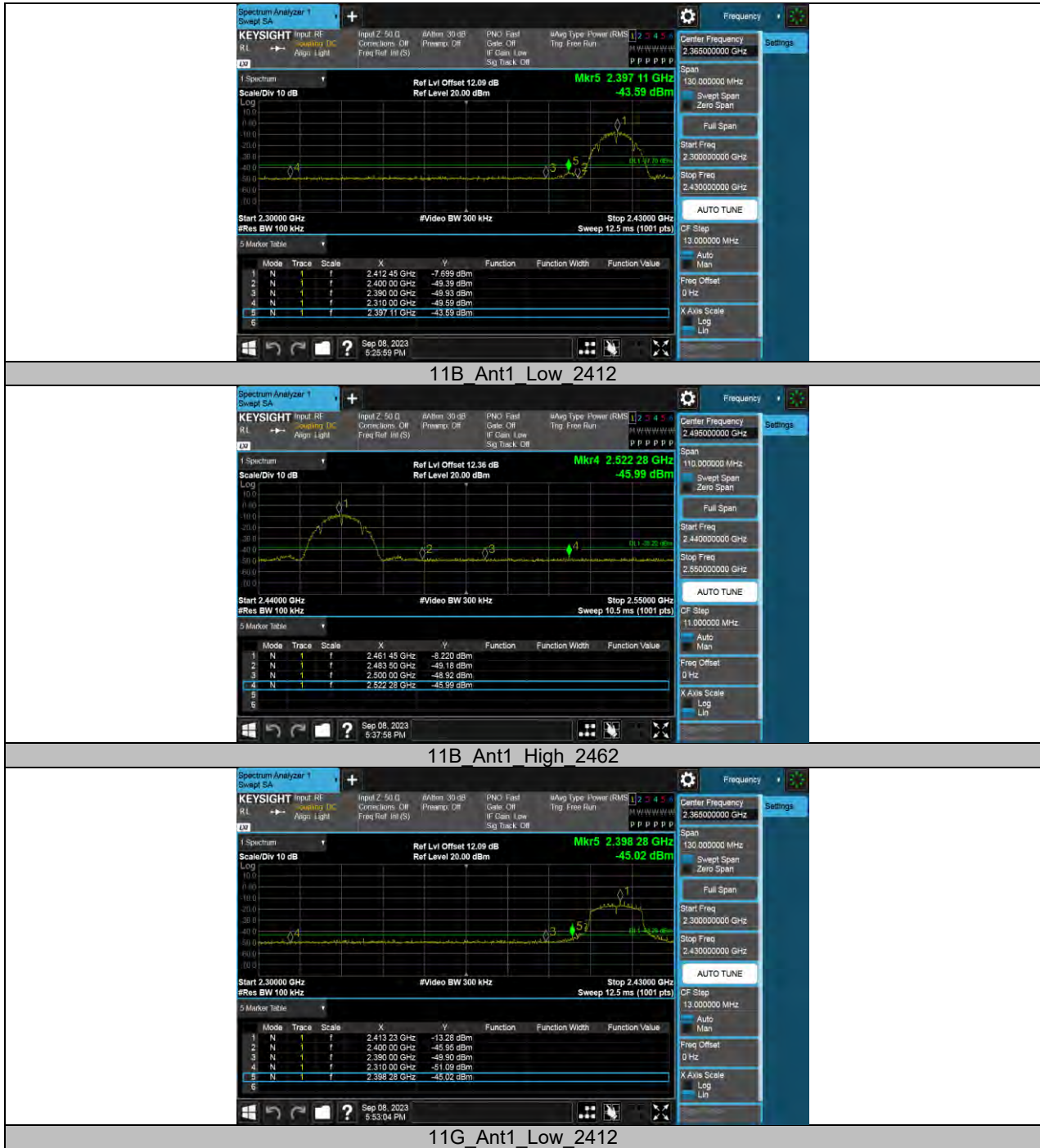



11.6. APPENDIX F2: CONDUCTED SPURIOUS EMISSION

11.6.1. Test Result

Test Mode	Antenna	Frequency[MHz]	FreqRange [Mhz]	RefLevel [dBm]	Result [dBm]	Limit [dBm]	Verdict
11B	Ant1	2412	Reference	-7.90	-7.90	---	PASS
			30~1000	-7.90	-57.76	≤-37.9	PASS
			1000~26500	-7.90	-49.7	≤-37.9	PASS
		2437	Reference	-8.51	-8.51	---	PASS
			30~1000	-8.51	-58.16	≤-38.51	PASS
			1000~26500	-8.51	-49.78	≤-38.51	PASS
		2462	Reference	-8.71	-8.71	---	PASS
			30~1000	-8.71	-58.48	≤-38.71	PASS
			1000~26500	-8.71	-49.35	≤-38.71	PASS
11G	Ant1	2412	Reference	-16.85	-16.85	---	PASS
			30~1000	-16.85	-58.32	≤-46.85	PASS
			1000~26500	-16.85	-49.9	≤-46.85	PASS
		2437	Reference	-14.97	-14.97	---	PASS
			30~1000	-14.97	-57.95	≤-44.97	PASS
			1000~26500	-14.97	-49.27	≤-44.97	PASS
		2462	Reference	-15.49	-15.49	---	PASS
			30~1000	-15.49	-58.14	≤-45.49	PASS
			1000~26500	-15.49	-49.92	≤-45.49	PASS
11N20SISO	Ant1	2412	Reference	-15.51	-15.51	---	PASS
			30~1000	-15.51	-58.52	≤-45.51	PASS
			1000~26500	-15.51	-50.01	≤-45.51	PASS
		2437	Reference	-18.02	-18.02	---	PASS
			30~1000	-18.02	-58.46	≤-48.02	PASS
			1000~26500	-18.02	-50.27	≤-48.02	PASS
		2462	Reference	-17.81	-17.81	---	PASS
			30~1000	-17.81	-57.96	≤-47.81	PASS
			1000~26500	-17.81	-49.27	≤-47.81	PASS

11.6.2. Test Graphs



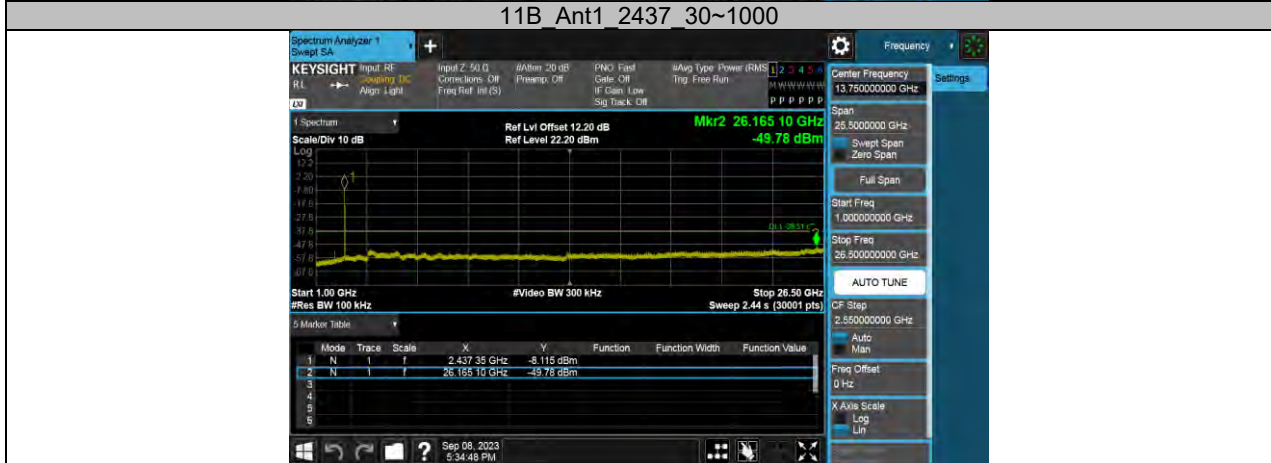

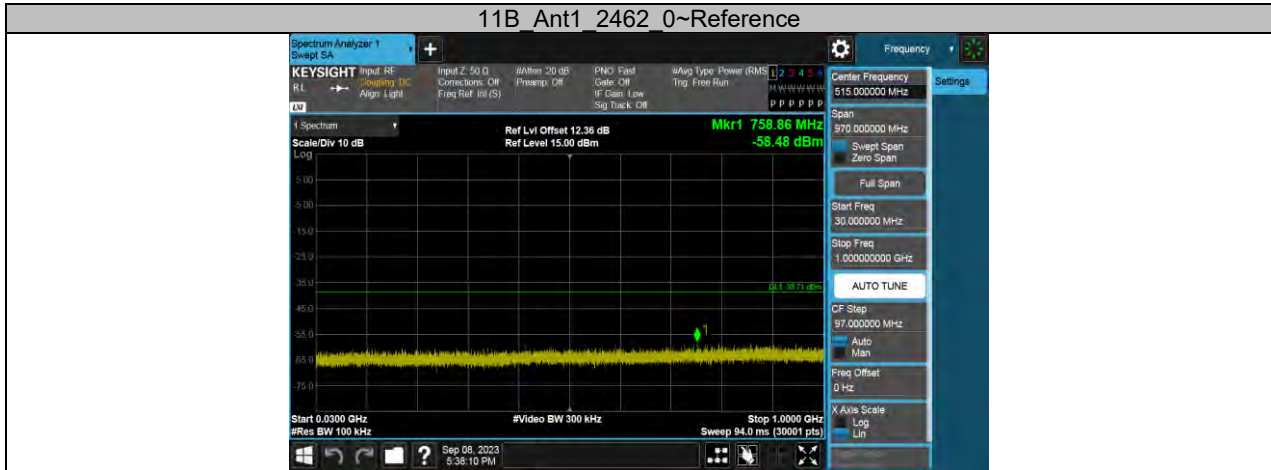

11G Ant1_2412_0~Reference

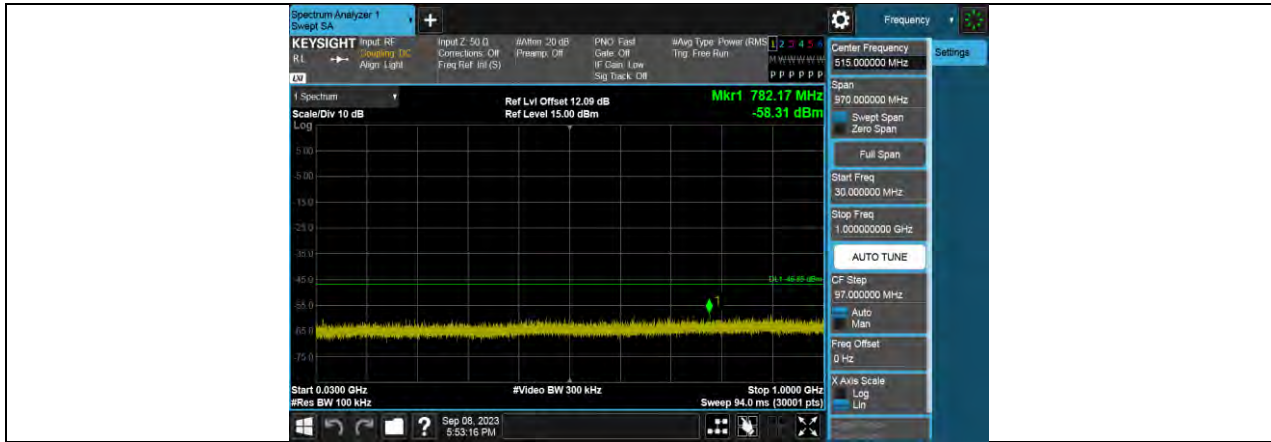

11G Ant1 2412 30~1000



11G Ant1 2412 1000~26500



11G Ant1 2437 0~Reference

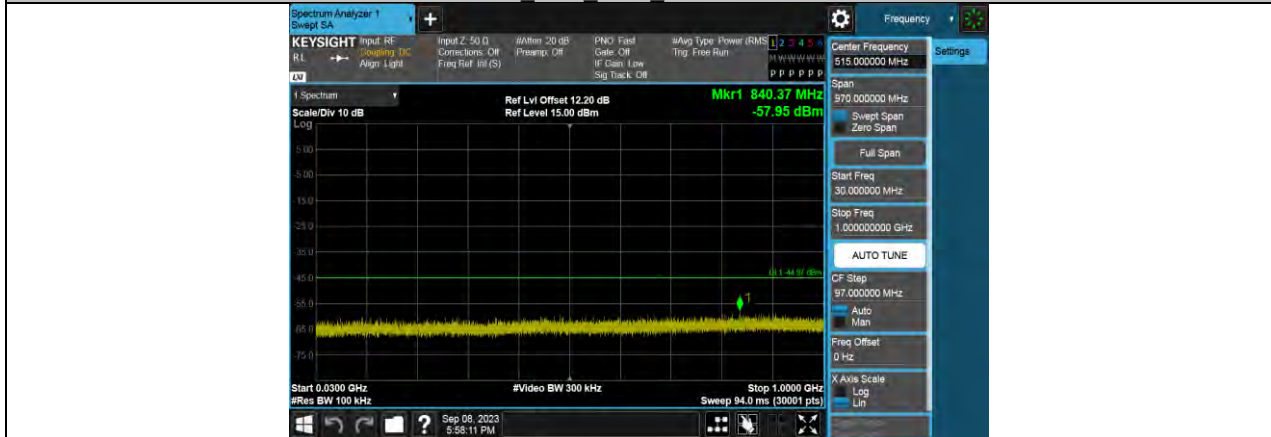

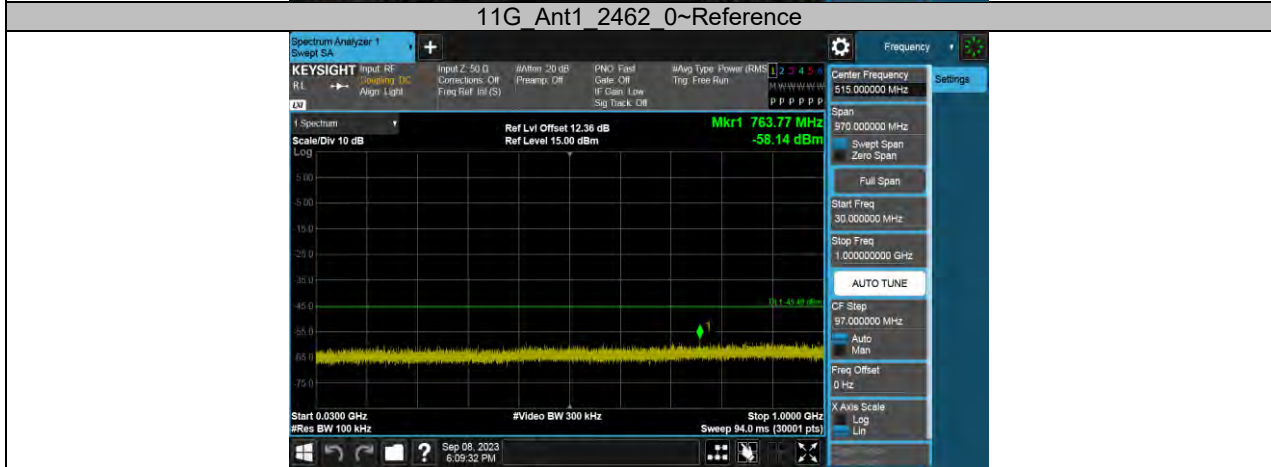
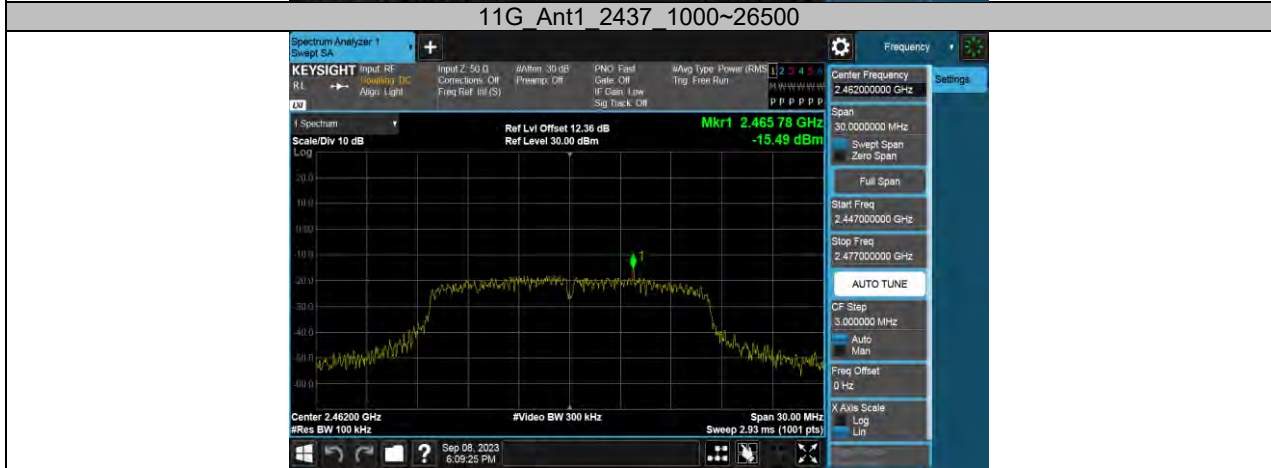
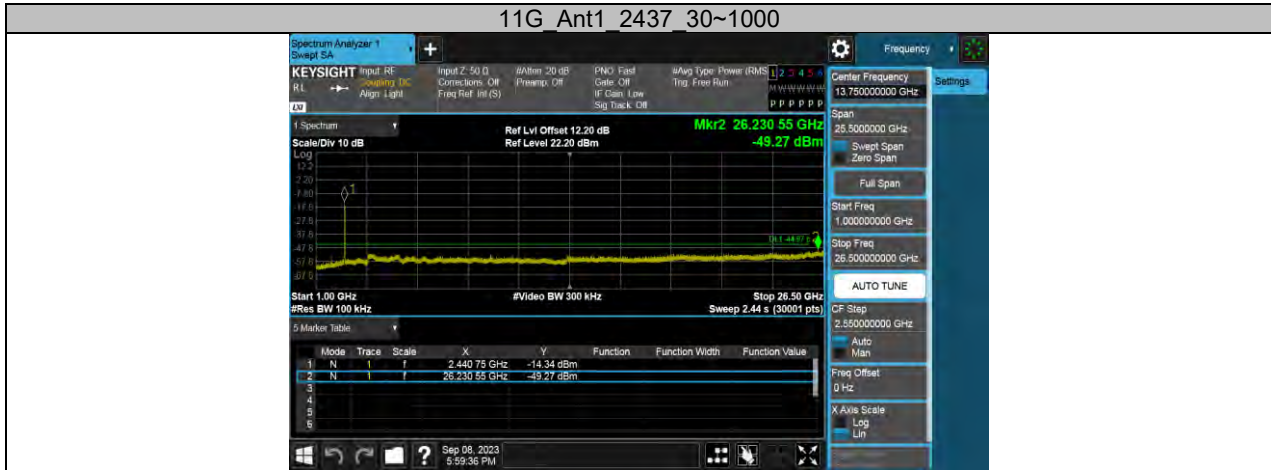

11G Ant1 2462 30~1000

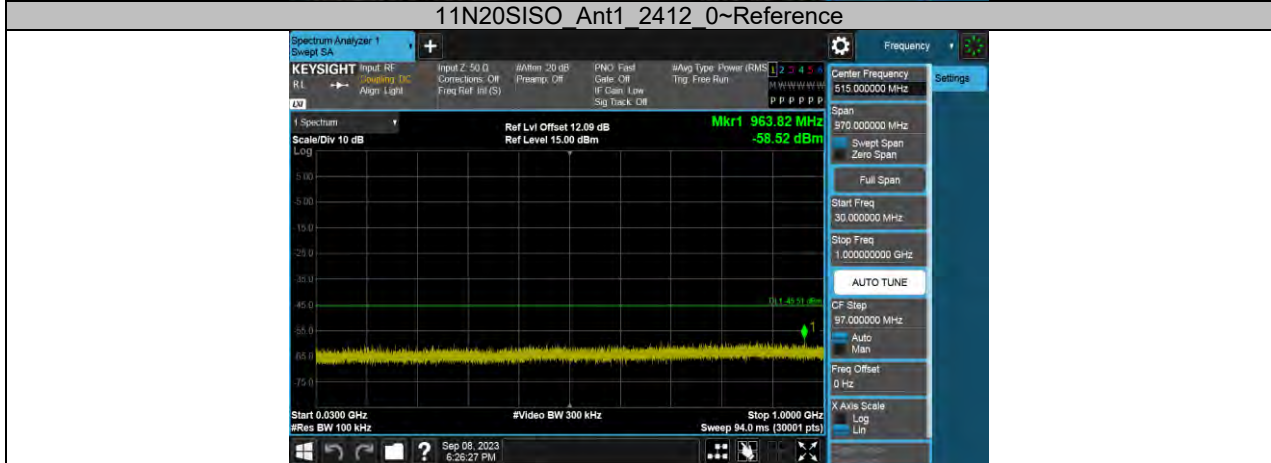

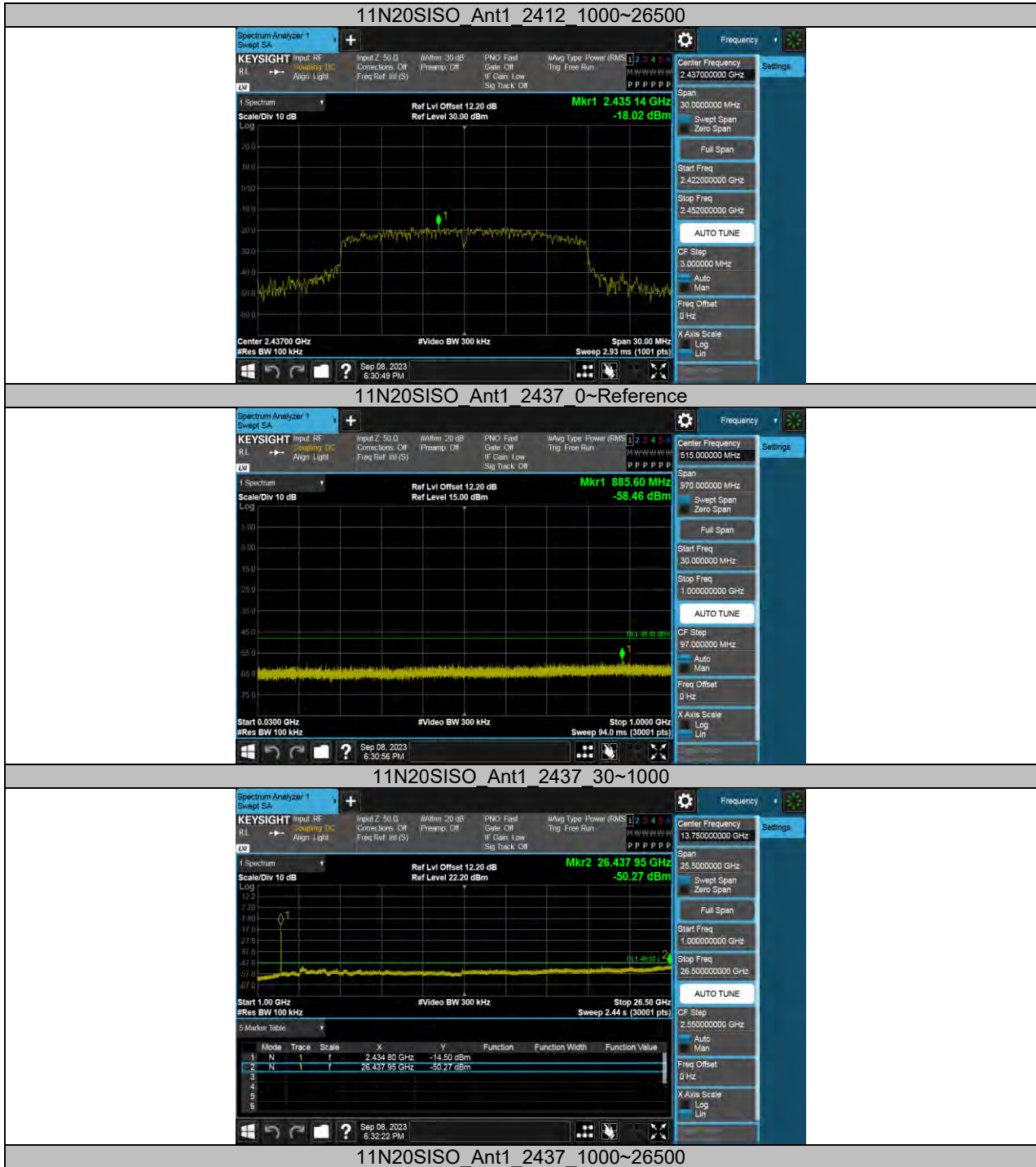

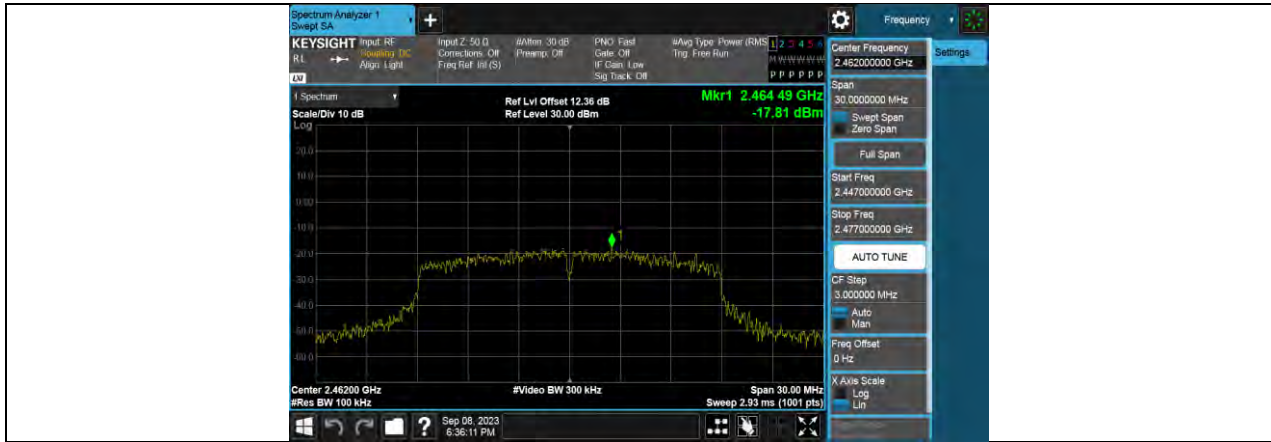

11N20SISO Ant1 2462 0~Reference



11N20SISO Ant1 2462 30~1000



11N20SISO Ant1 2462 1000~26500

11.7. APPENDIX G2: DUTY CYCLE

11.7.1. Test Result

Test Mode	On Time (msec)	Period (msec)	Duty Cycle x (Linear)	Duty Cycle (%)	Duty Cycle Correction Factor (dB)	1/T Minimum VBW (kHz)	Final setting For VBW (kHz)
11B	8.20	8.64	0.9491	94.91	0.23	0.12	1
11G	1.36	1.60	0.8500	85.00	0.71	0.74	1
11N20SISO	1.27	1.48	0.8581	85.81	0.66	0.79	1

Note:

Duty Cycle Correction Factor=10log (1/x).

Where: x is Duty Cycle (Linear)

Where: T is On Time

If that calculated VBW is not available on the analyzer then the next higher value should be used.

11.7.2. Test Graphs



END OF REPORT