

Appendix Test Data

| | | | |
|------------------|-------------------|--------------------|--------------------|
| Report No.: | 18220WC40076101 | Test Sample No.: | 1-2-2 |
| Start Test Date: | 2024.4.22 | Finish Test Date: | 2024.4.22 |
| Test Engineer: | <i>Joker Wang</i> | Auditor: | <i>Justin Feng</i> |
| Temperature: | 25.5°C | Relative Humidity: | 47% |
| Pressure: | 101kPa | | |

Appendix A: -20dB Bandwidth

| Condition | Antenna | Modulation | Frequency (MHz) | -20dB BW(MHz) | if larger than CFS |
|-----------|---------|------------|-----------------|---------------|--------------------|
| NVNT | ANT1 | 1-DH5 | 2402.00 | 1.025 | Yes |
| NVNT | ANT1 | 1-DH5 | 2441.00 | 1.031 | Yes |
| NVNT | ANT1 | 1-DH5 | 2480.00 | 1.034 | Yes |
| NVNT | ANT1 | 2-DH5 | 2402.00 | 1.325 | Yes |
| NVNT | ANT1 | 2-DH5 | 2441.00 | 1.328 | Yes |
| NVNT | ANT1 | 2-DH5 | 2480.00 | 1.328 | Yes |
| NVNT | ANT1 | 3-DH5 | 2402.00 | 1.295 | Yes |
| NVNT | ANT1 | 3-DH5 | 2441.00 | 1.289 | Yes |
| NVNT | ANT1 | 3-DH5 | 2480.00 | 1.286 | Yes |

-20dB_Bandwidth_NVNT_ANT1_1-DH5_2402

Shenzhen Anbotek Compliance Laboratory Limited

Address: 1/F., Building D, Sogood Science and Technology Park, Sanwei Community, Hangcheng Street, Bao'an District, Shenzhen, Guangdong, China.
Tel: (86) 0755-26066440 Fax: (86) 0755-26014772 Email: service@anbotek.com



Hotline
400-003-0500
www.anbotek.com.cn



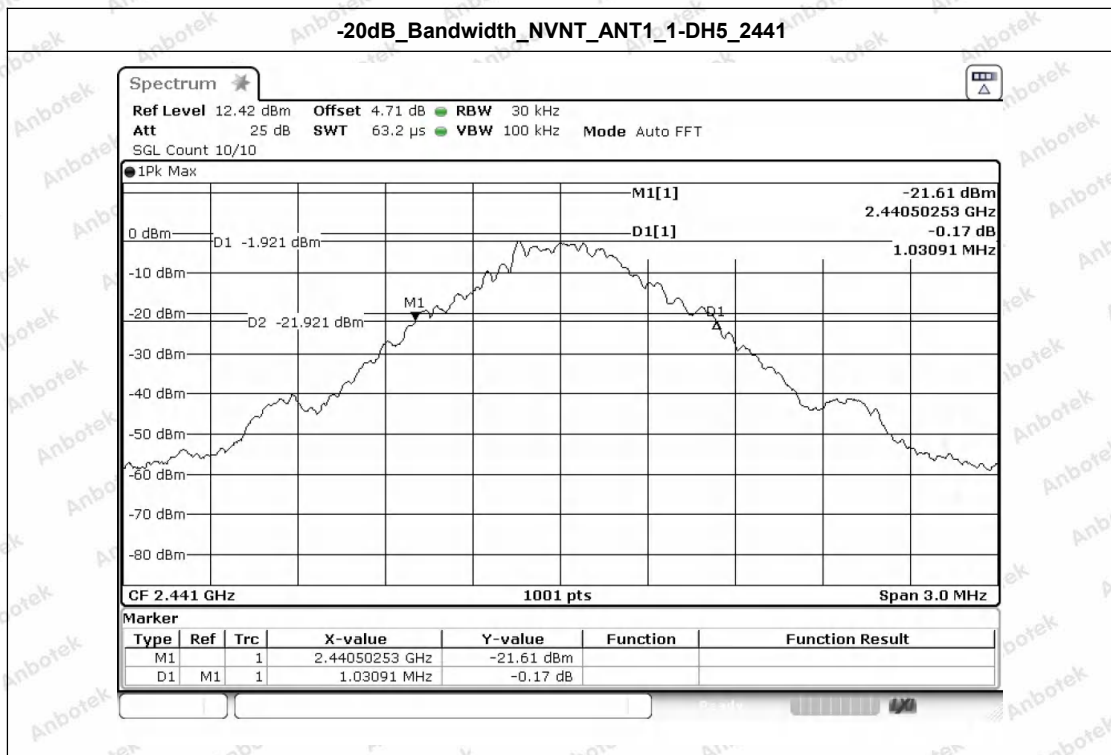
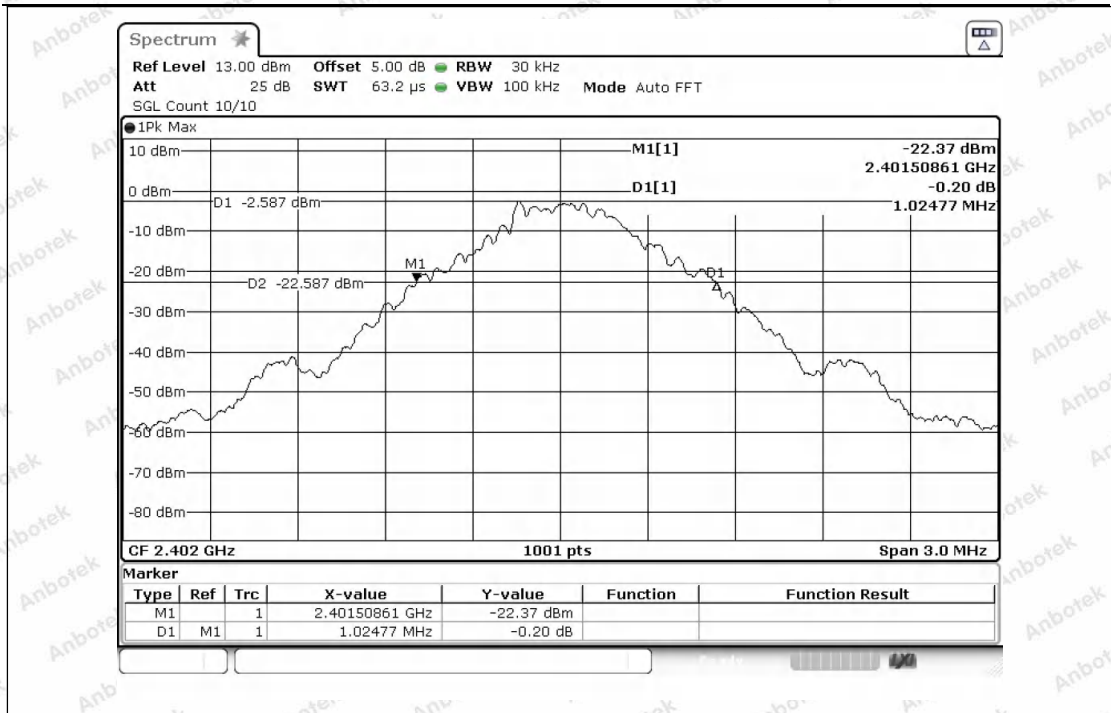

-20dB_Bandwidth_NVNT_ANT1_1-DH5_2480

Shenzhen Anbotek Compliance Laboratory Limited

Address: 1/F., Building D, Sogood Science and Technology Park, Sanwei Community, Hangcheng Street, Bao'an District, Shenzhen, Guangdong, China.
 Tel: (86) 0755-26066440 Fax: (86) 0755-26014772 Email: service@anbotek.com

Hotline
 400-003-0500
www.anbotek.com.cn



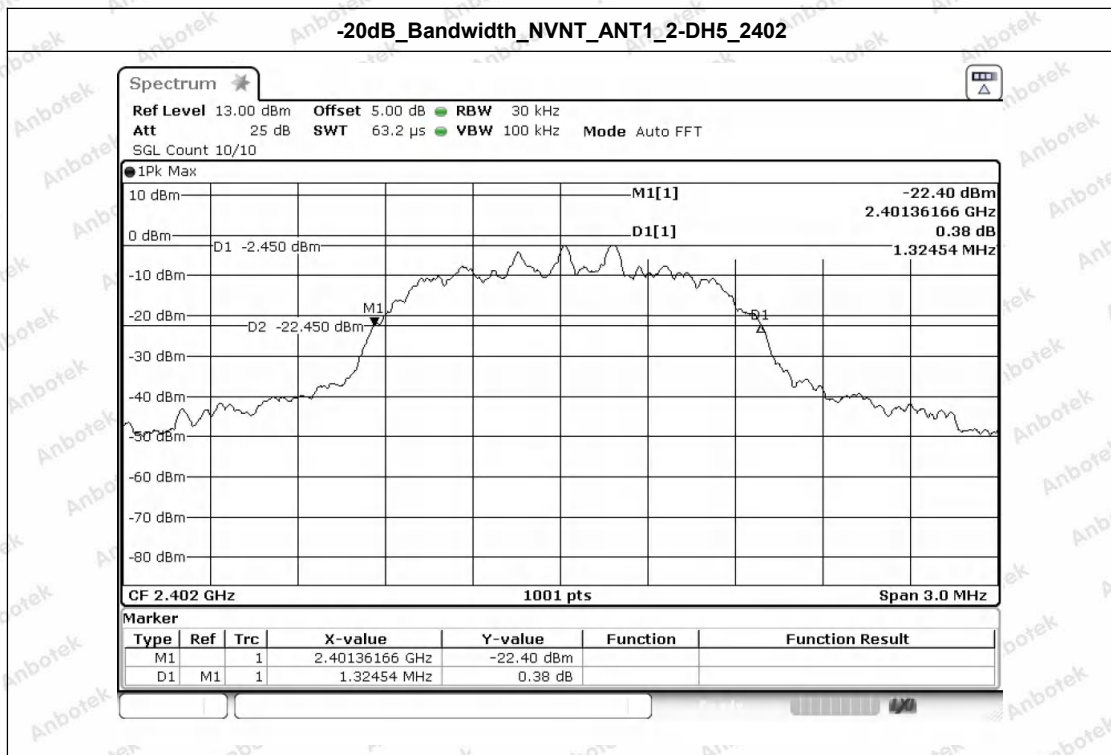
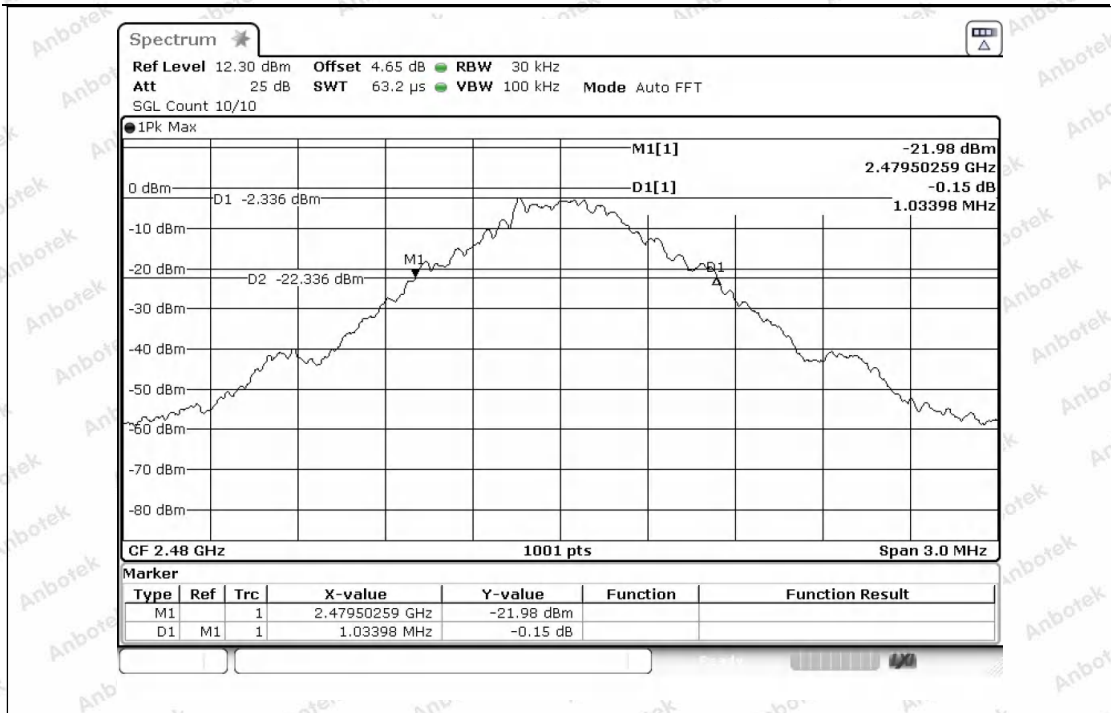

-20dB_Bandwidth_NVNT_ANT1_2-DH5_2441

Shenzhen Anbotek Compliance Laboratory Limited

Address: 1/F., Building D, Sogood Science and Technology Park, Sanwei Community, Hangcheng Street, Bao'an District, Shenzhen, Guangdong, China.
 Tel: (86) 0755-26066440 Fax: (86) 0755-26014772 Email: service@anbotek.com

Hotline
 400-003-0500
www.anbotek.com.cn



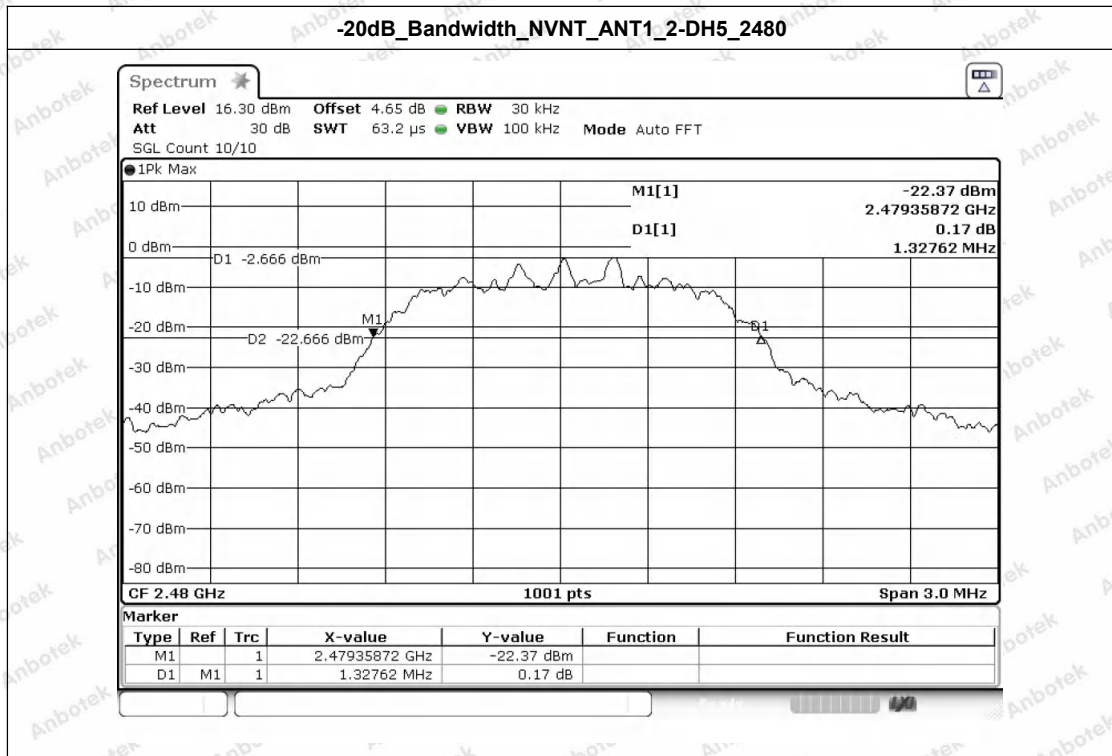
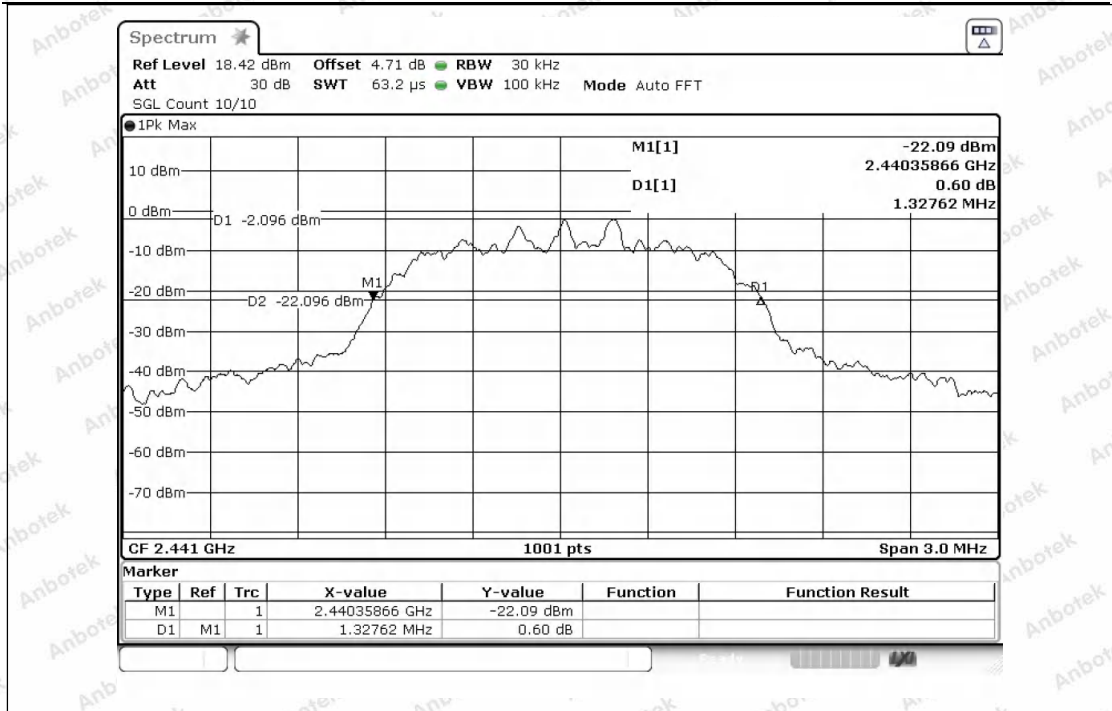

-20dB_Bandwidth_NVNT_ANT1_3-DH5_2402

Shenzhen Anbotek Compliance Laboratory Limited

Address: 1/F., Building D, Sogood Science and Technology Park, Sanwei Community, Hangcheng Street, Bao'an District, Shenzhen, Guangdong, China.
 Tel: (86) 0755-26066440 Fax: (86) 0755-26014772 Email: service@anbotek.com

Hotline
 400-003-0500
www.anbotek.com.cn



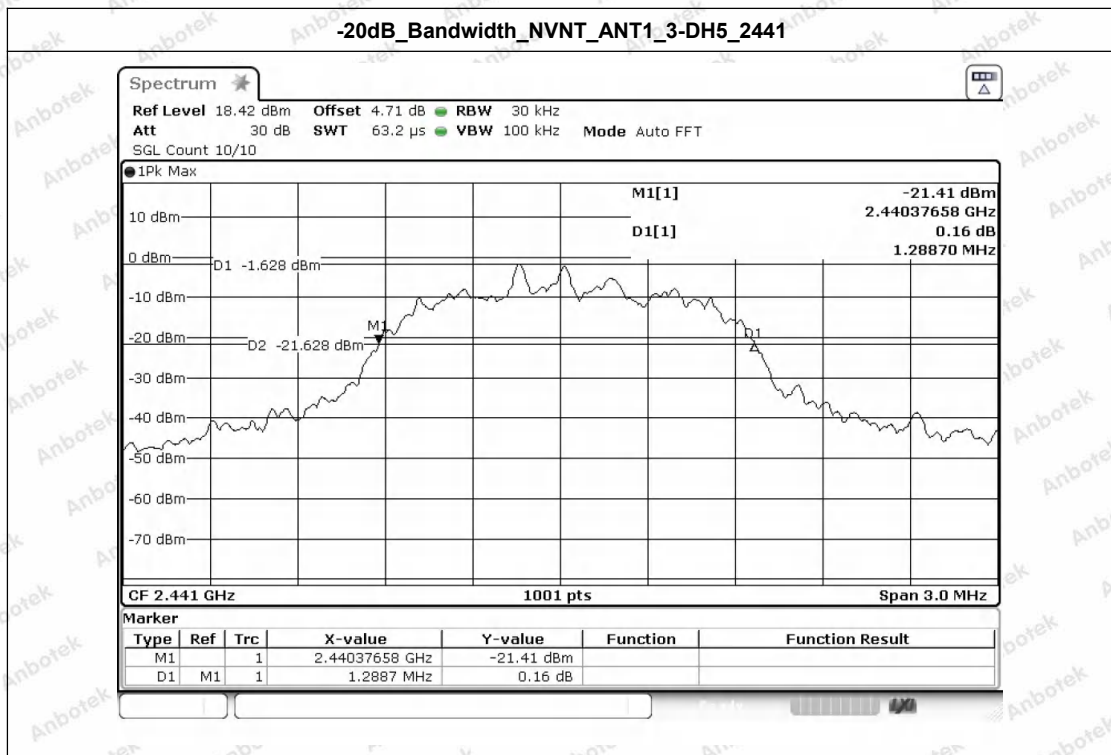
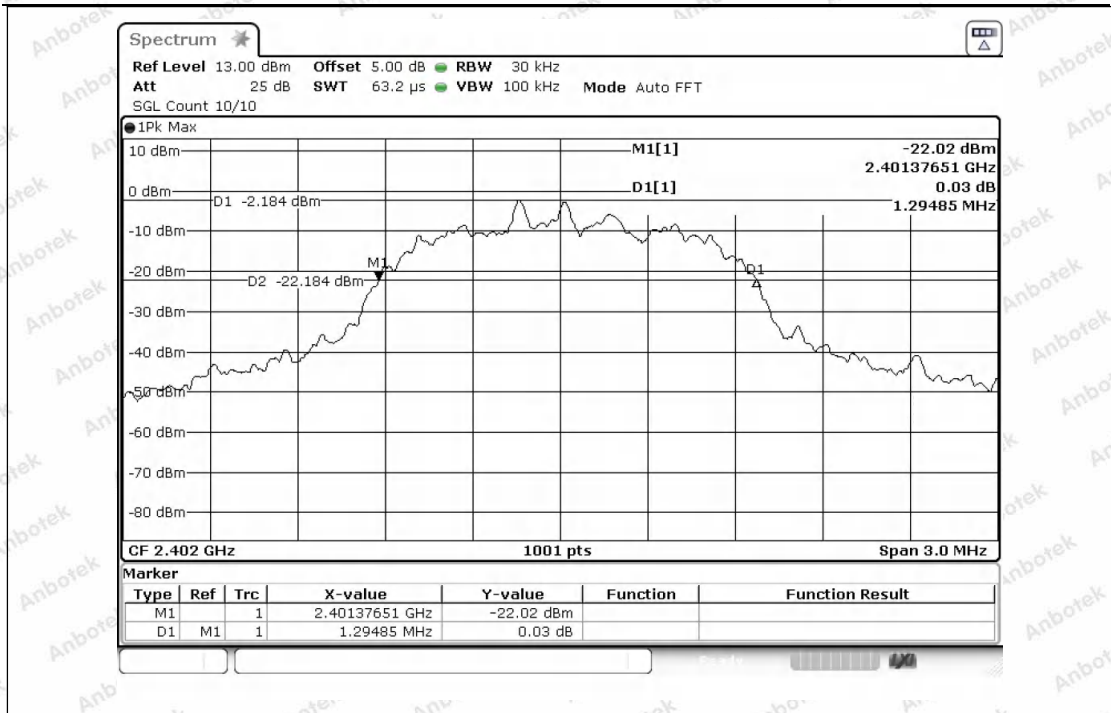

-20dB_Bandwidth_NVNT_ANT1_3-DH5_2480

Shenzhen Anbotek Compliance Laboratory Limited

Address: 1/F., Building D, Sogood Science and Technology Park, Sanwei Community, Hangcheng Street, Bao'an District, Shenzhen, Guangdong, China.
 Tel: (86) 0755-26066440 Fax: (86) 0755-26014772 Email: service@anbotek.com

Hotline
 400-003-0500
www.anbotek.com.cn



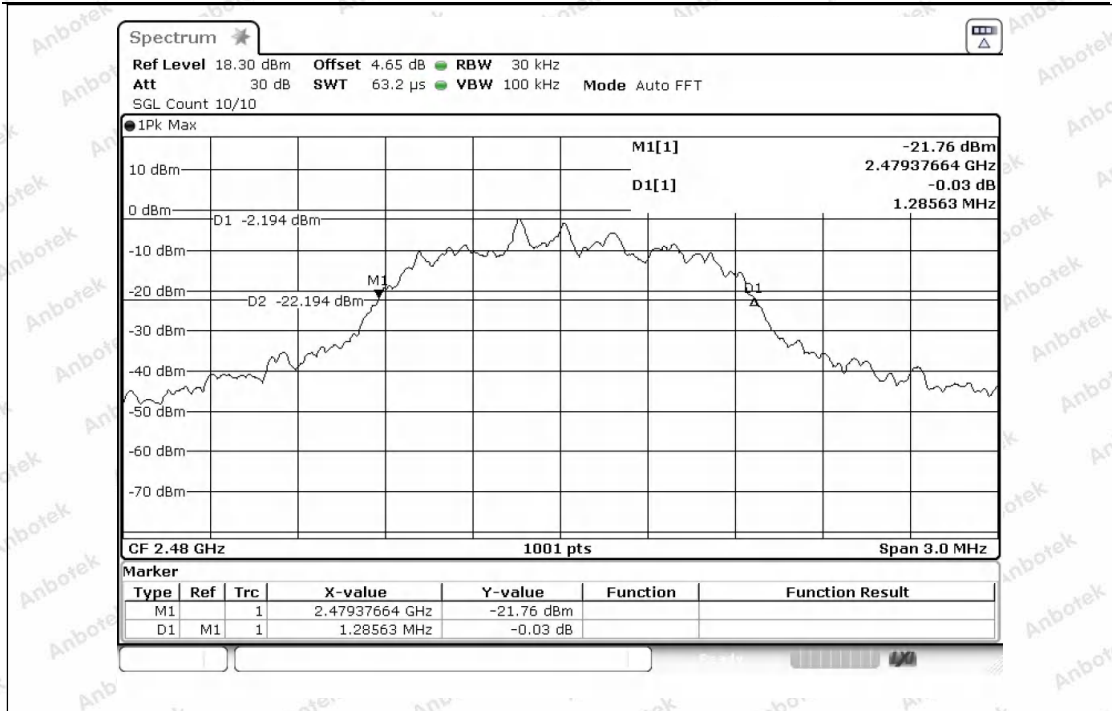

Shenzhen Anbotek Compliance Laboratory Limited

Address: 1/F., Building D, Sogood Science and Technology Park, Sanwei Community, Hangcheng Street, Bao'an District, Shenzhen, Guangdong, China.
 Tel: (86) 0755-26066440 Fax: (86) 0755-26014772 Email: service@anbotek.com

 Hotline
 400-003-0500
www.anbotek.com.cn



Appendix B: 99% Occupied Bandwidth

| Condition | Antenna | Modulation | Frequency (MHz) | 99% BW (MHz) |
|-----------|---------|------------|-----------------|--------------|
| NVNT | ANT1 | 1-DH5 | 2402.00 | 0.917 |
| NVNT | ANT1 | 1-DH5 | 2441.00 | 0.932 |
| NVNT | ANT1 | 1-DH5 | 2480.00 | 0.947 |
| NVNT | ANT1 | 2-DH5 | 2402.00 | 1.202 |
| NVNT | ANT1 | 2-DH5 | 2441.00 | 1.211 |
| NVNT | ANT1 | 2-DH5 | 2480.00 | 1.226 |
| NVNT | ANT1 | 3-DH5 | 2402.00 | 1.202 |
| NVNT | ANT1 | 3-DH5 | 2441.00 | 1.208 |
| NVNT | ANT1 | 3-DH5 | 2480.00 | 1.214 |

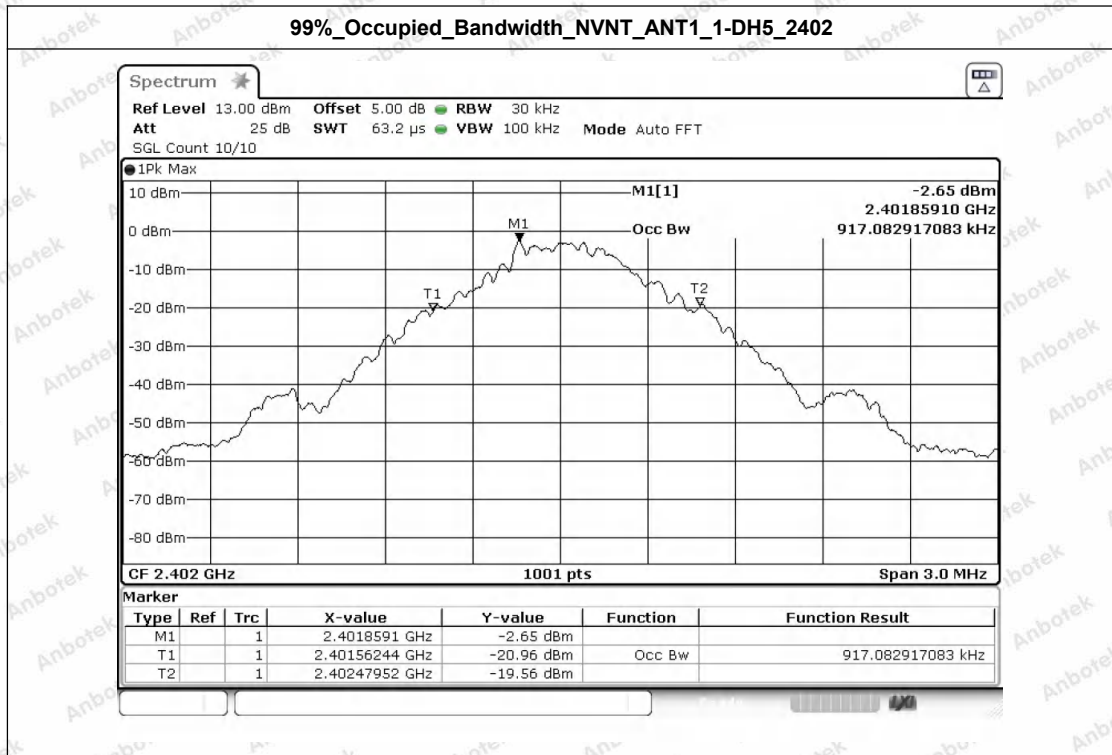

99%_Occupied_Bandwidth_NVNT_ANT1_1-DH5_2441



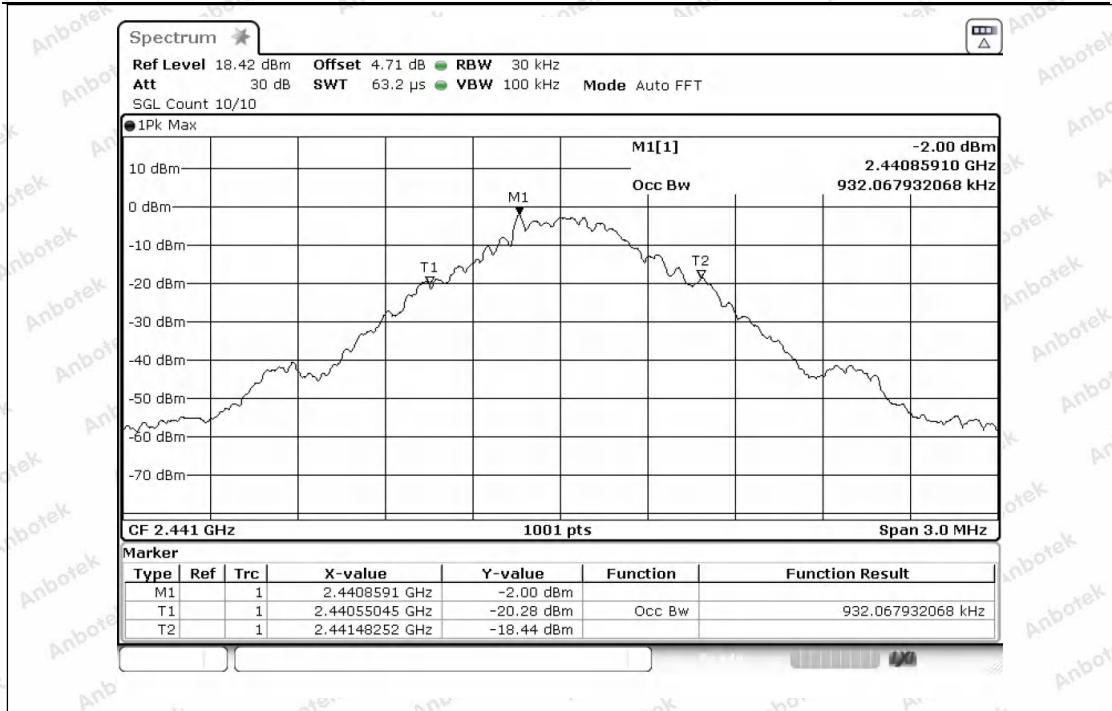

99%_Occupied_Bandwidth_NVNT_ANT1_1-DH5_2480

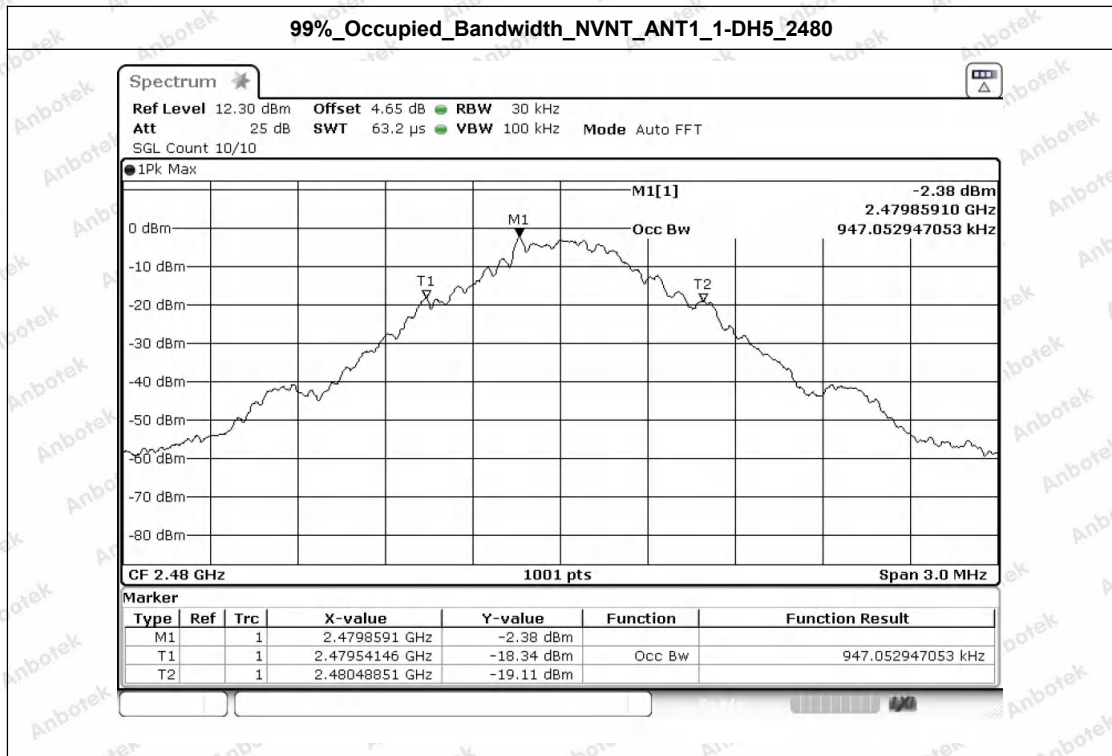

99%_Occupied_Bandwidth_NVNT_ANT1_2-DH5_2402

Shenzhen Anbotek Compliance Laboratory Limited

Address: 1/F., Building D, Sogood Science and Technology Park, Sanwei Community, Hangcheng Street, Bao'an District, Shenzhen, Guangdong, China.
 Tel: (86) 0755-26066440 Fax: (86) 0755-26014772 Email: service@anbotek.com

Hotline 400-003-0500
 www.anbotek.com.cn



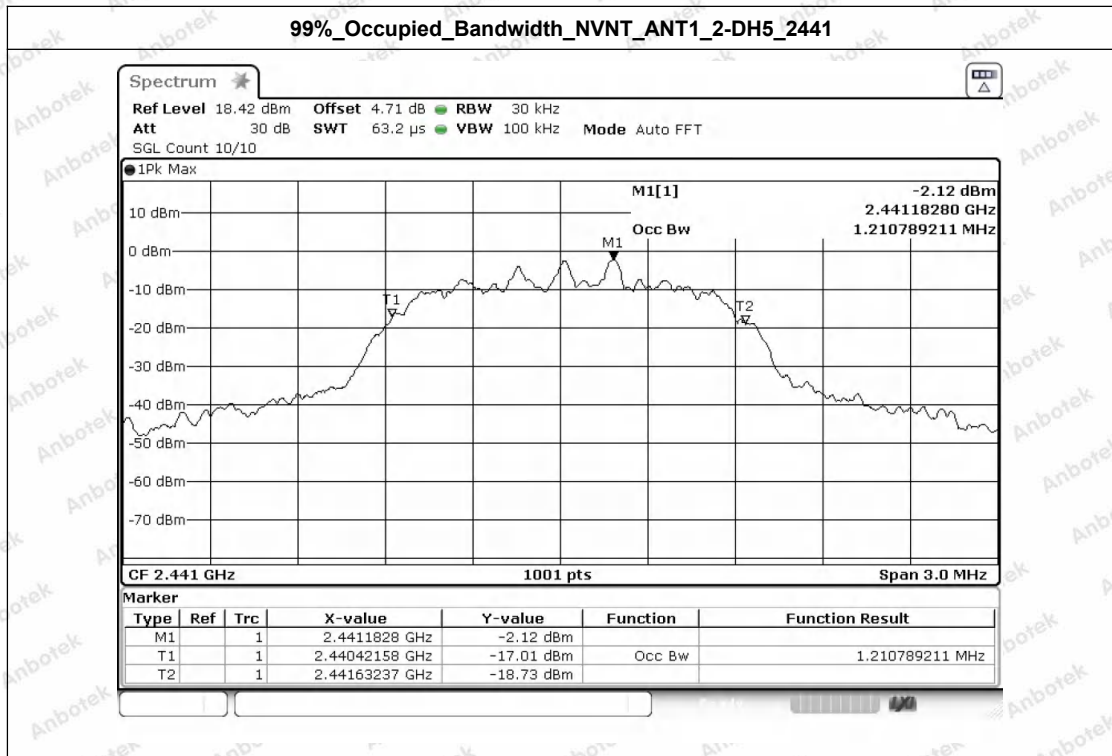
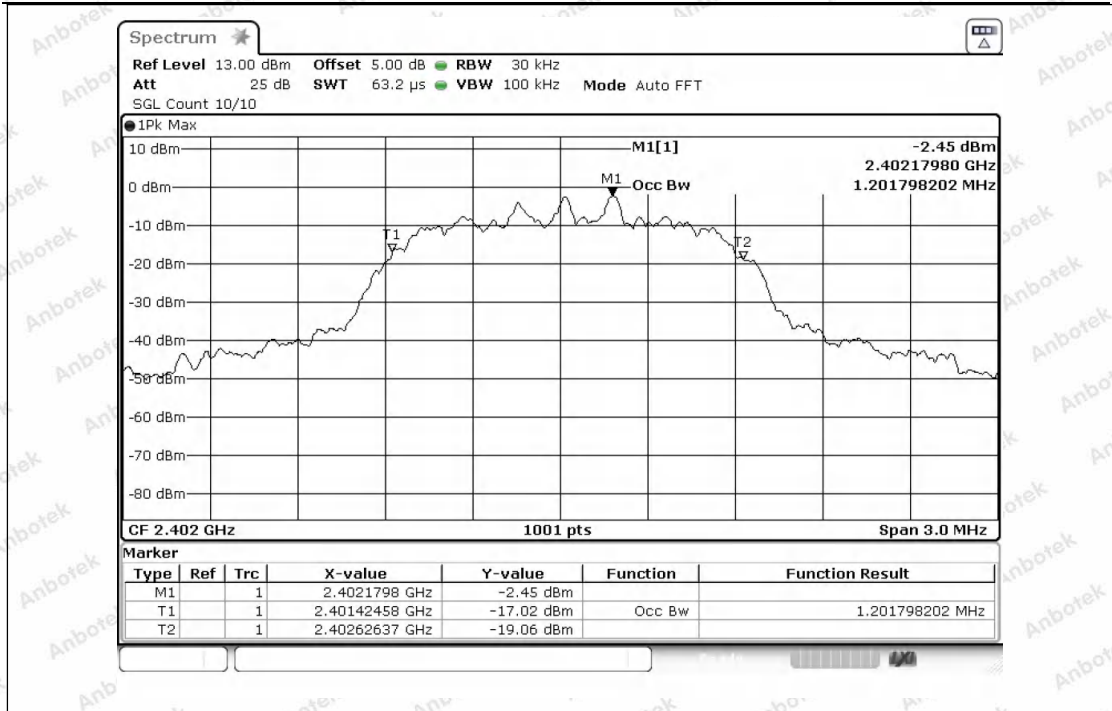

99%_Occupied_Bandwidth_NVNT_ANT1_2-DH5_2480

Shenzhen Anbotek Compliance Laboratory Limited

Address: 1/F., Building D, Sogood Science and Technology Park, Sanwei Community, Hangcheng Street, Bao'an District, Shenzhen, Guangdong, China.
 Tel: (86) 0755-26066440 Fax: (86) 0755-26014772 Email: service@anbotek.com

Hotline 400-003-0500
 www.anbotek.com.cn



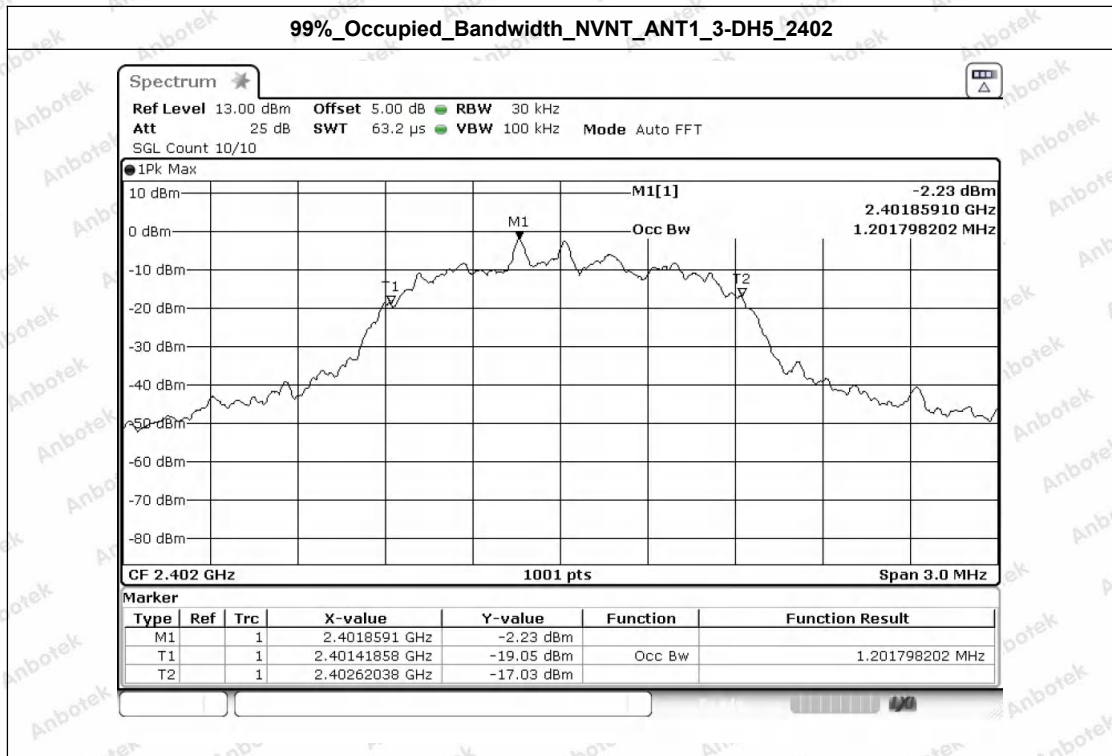
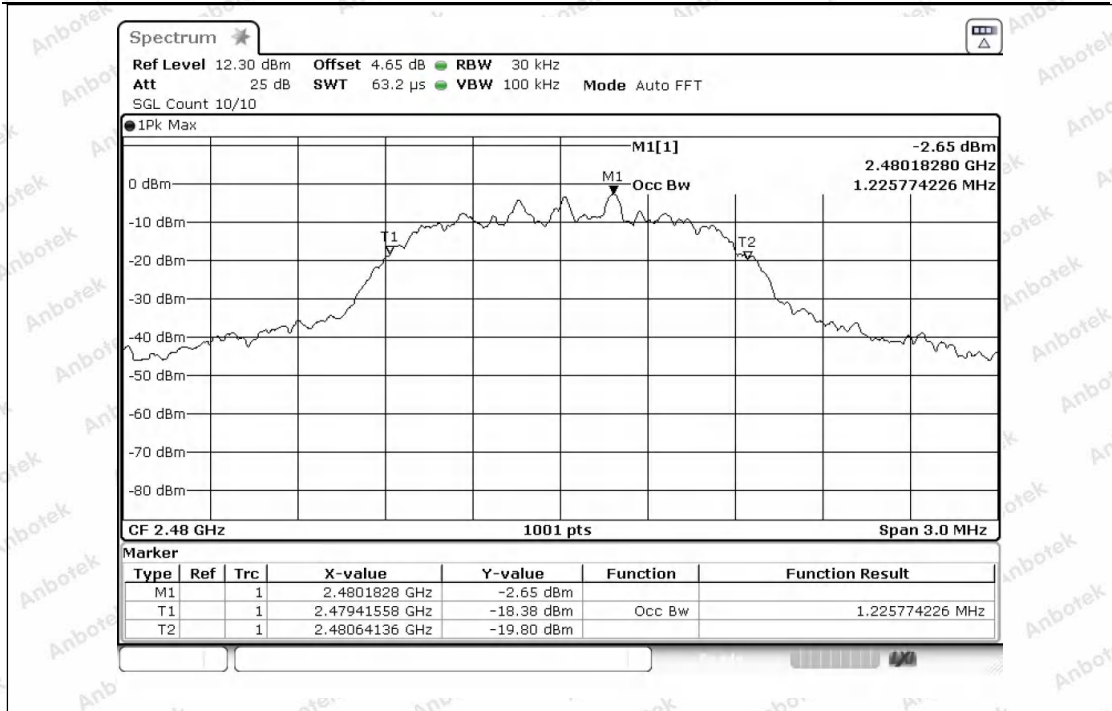

99%_Occupied_Bandwidth_NVNT_ANT1_3-DH5_2441

Shenzhen Anbotek Compliance Laboratory Limited

Address: 1/F., Building D, Sogood Science and Technology Park, Sanwei Community, Hangcheng Street, Bao'an District, Shenzhen, Guangdong, China.
 Tel: (86) 0755-26066440 Fax: (86) 0755-26014772 Email: service@anbotek.com

Hotline
 400-003-0500
 www.anbotek.com.cn



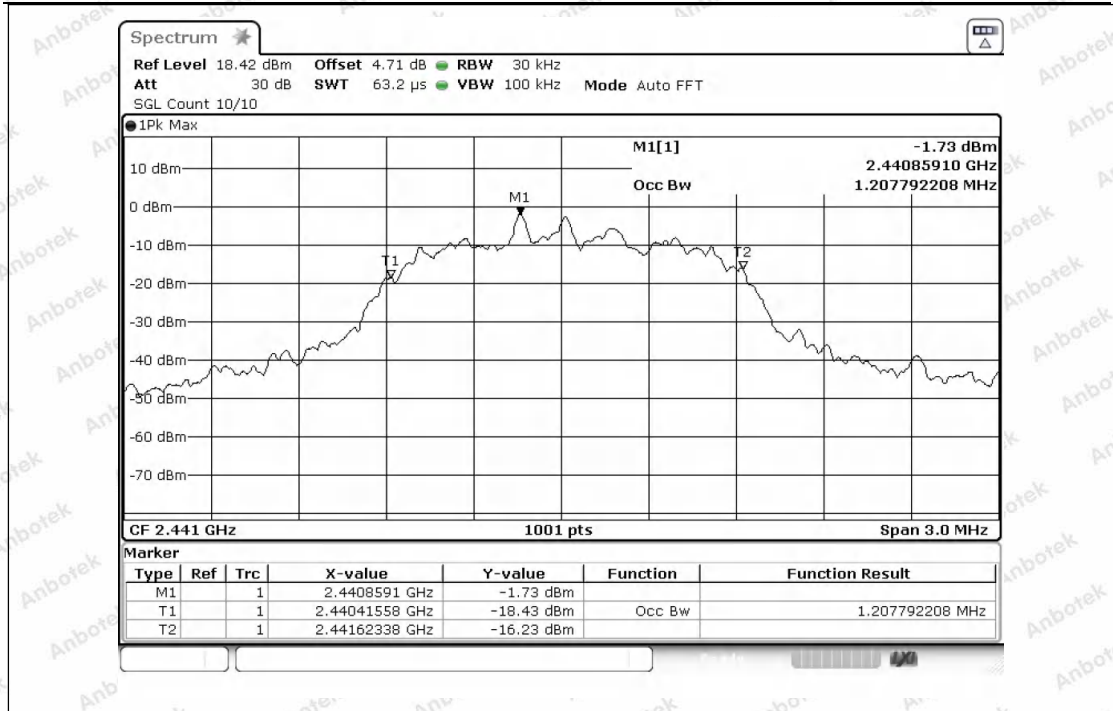

99%_Occupied_Bandwidth_NVNT_ANT1_3-DH5_2480

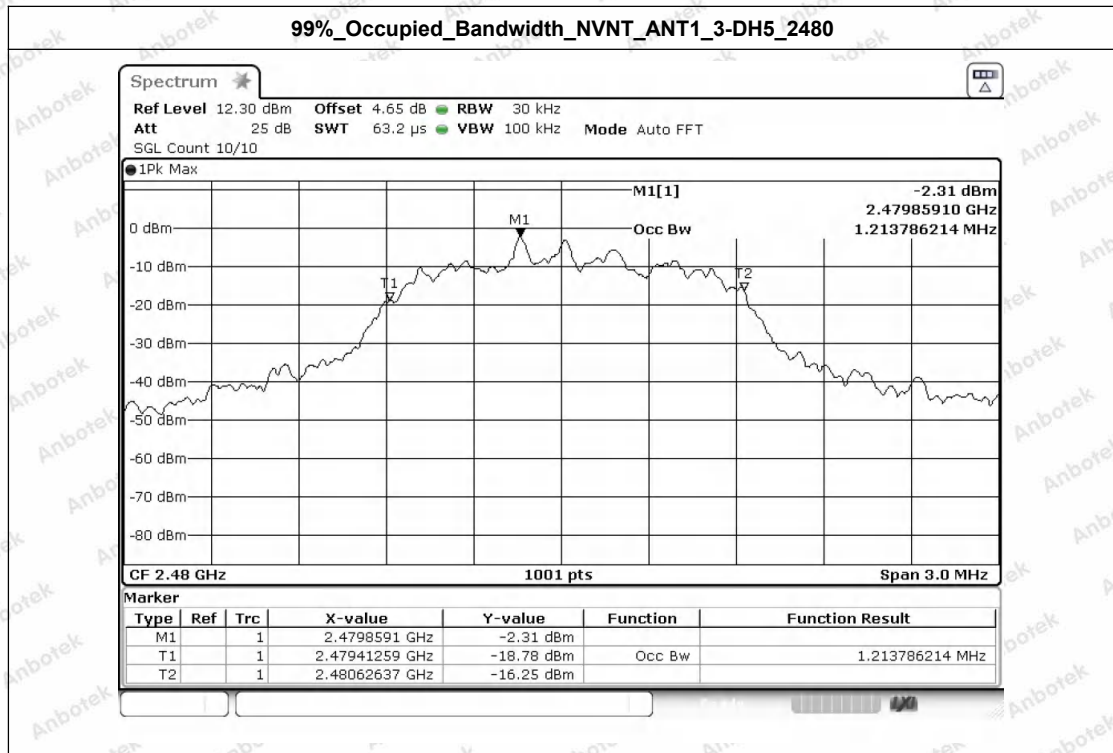

Shenzhen Anbotek Compliance Laboratory Limited

Address: 1/F., Building D, Sogood Science and Technology Park, Sanwei Community, Hangcheng Street, Bao'an District, Shenzhen, Guangdong, China.
 Tel: (86) 0755-26066440 Fax: (86) 0755-26014772 Email: service@anbotek.com

Hotline 400-003-0500
 www.anbotek.com.cn



Appendix C: Peak Output Power

| Condition | Antenna | Modulation | Frequency (MHz) | Max. Conducted Power(dBm) | Max. Conducted Power(mW) | Limit(mW) | Result |
|-----------|---------|------------|-----------------|---------------------------|--------------------------|-----------|--------|
| NVNT | ANT1 | 1-DH5 | 2402.00 | -0.04 | 0.99 | 125 | Pass |
| NVNT | ANT1 | 1-DH5 | 2441.00 | 0.42 | 1.10 | 125 | Pass |
| NVNT | ANT1 | 1-DH5 | 2480.00 | 0.05 | 1.01 | 125 | Pass |
| NVNT | ANT1 | 2-DH5 | 2402.00 | 1.15 | 1.30 | 125 | Pass |
| NVNT | ANT1 | 2-DH5 | 2441.00 | 1.34 | 1.36 | 125 | Pass |
| NVNT | ANT1 | 2-DH5 | 2480.00 | 0.97 | 1.25 | 125 | Pass |
| NVNT | ANT1 | 3-DH5 | 2402.00 | 1.27 | 1.34 | 125 | Pass |
| NVNT | ANT1 | 3-DH5 | 2441.00 | 1.62 | 1.45 | 125 | Pass |
| NVNT | ANT1 | 3-DH5 | 2480.00 | 1.13 | 1.30 | 125 | Pass |

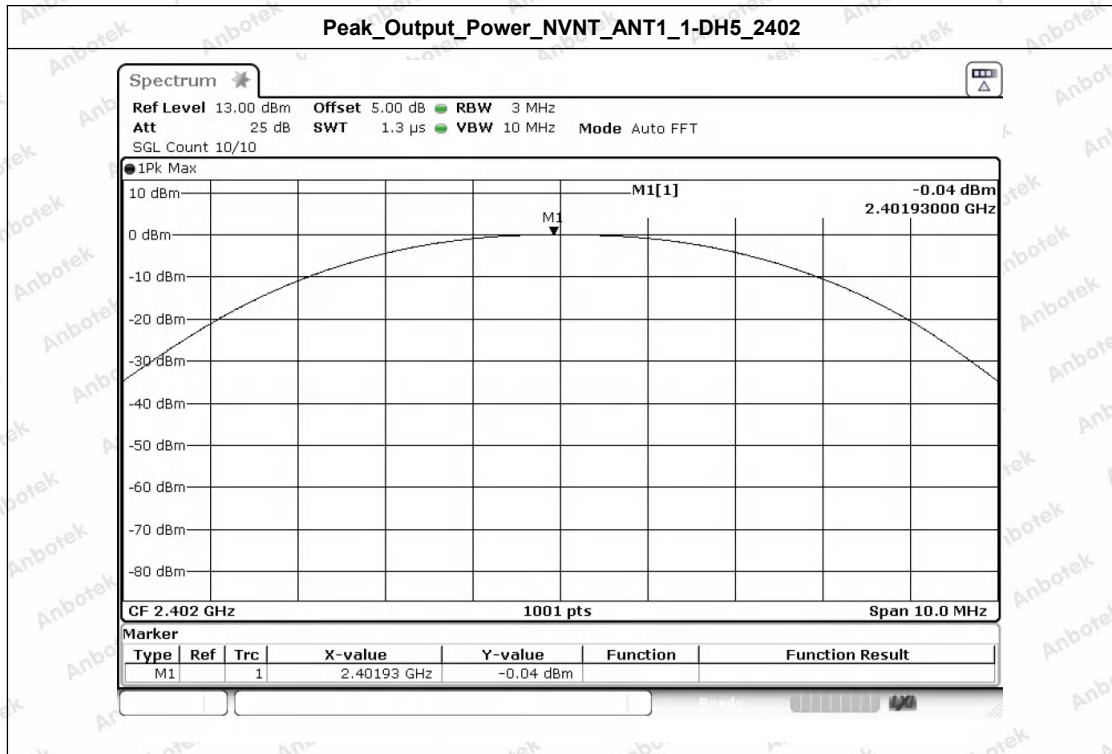

Peak_Output_Power_NVNT_ANT1_1-DH5_2441



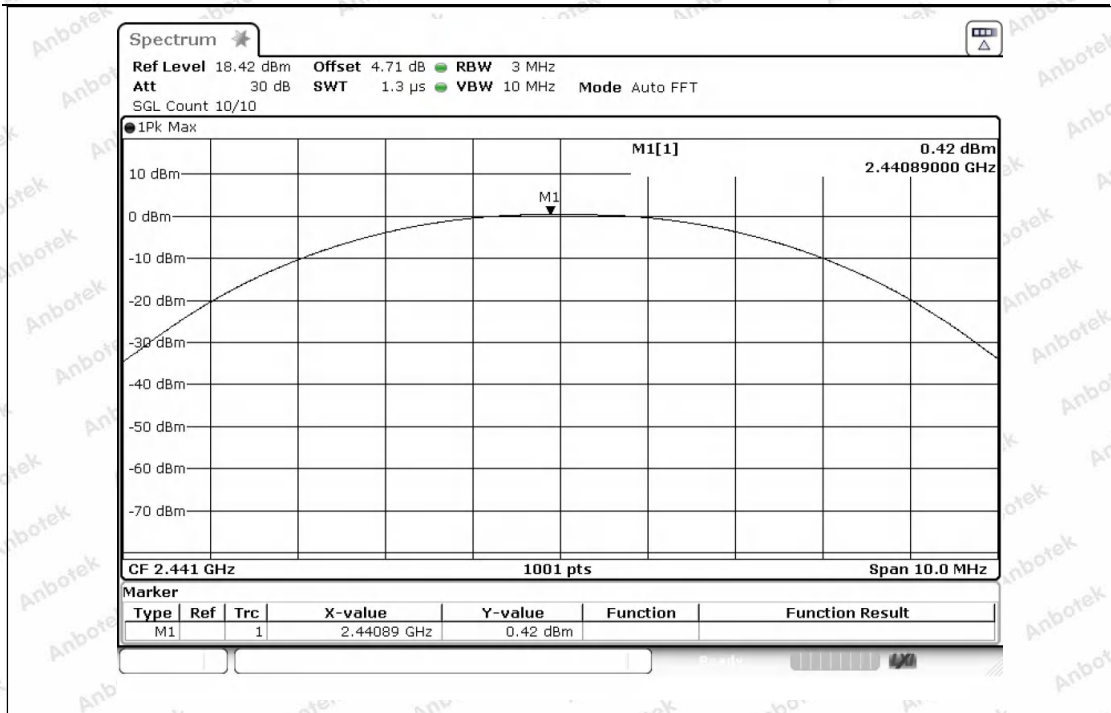

Peak_Output_Power_NVNT_ANT1_1-DH5_2480

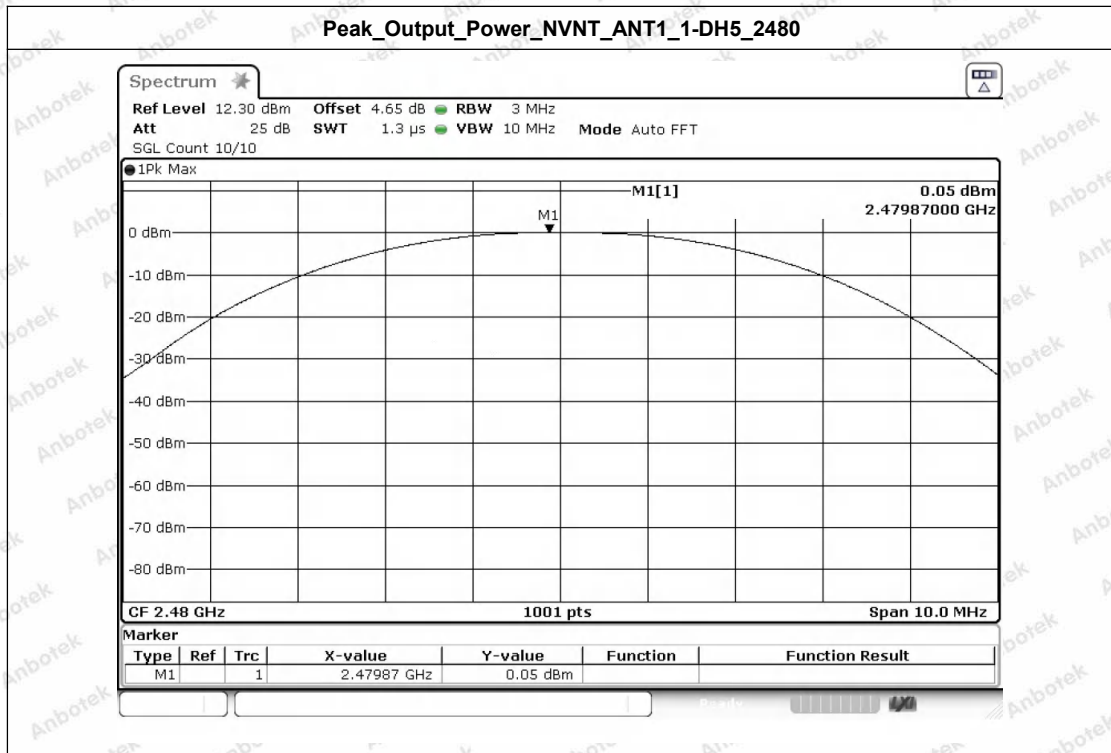

Peak_Output_Power_NVNT_ANT1_2-DH5_2402



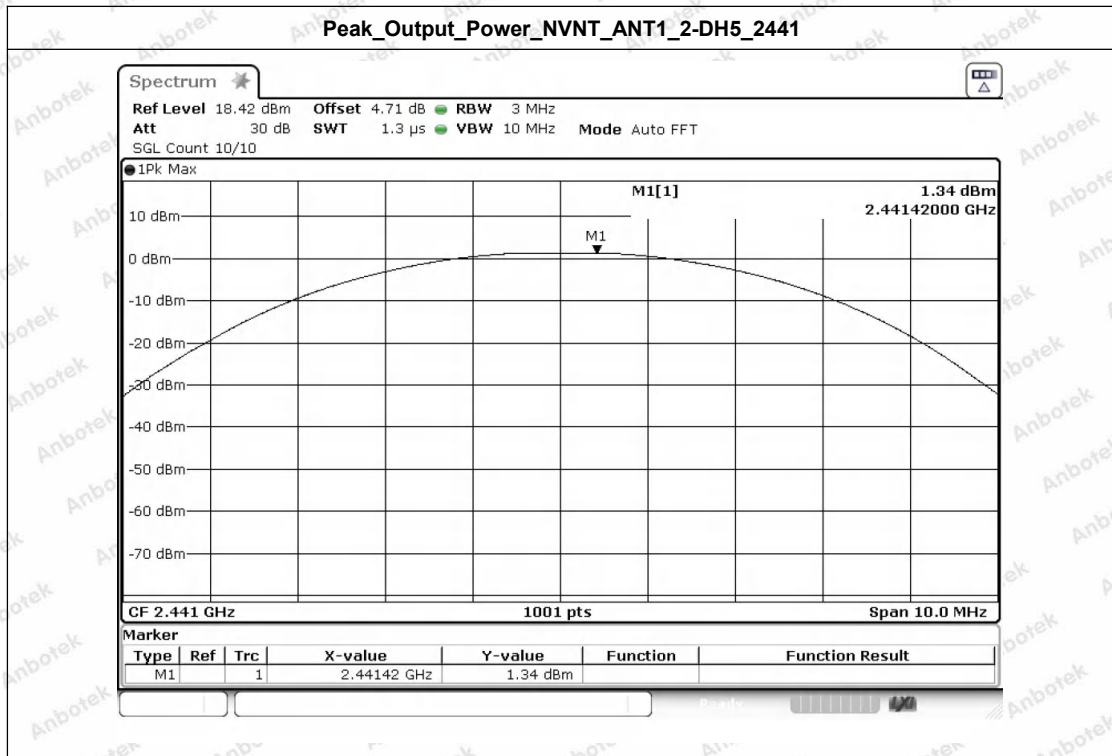
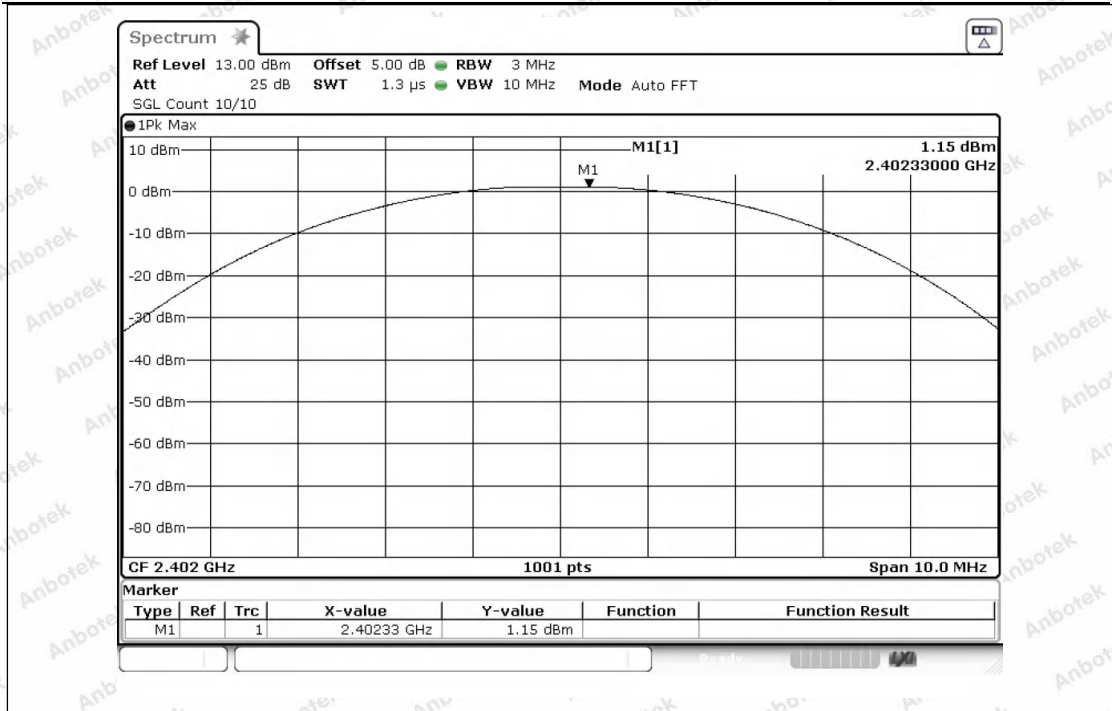

Peak Output Power_NVNT_ANT1_2-DH5_2480



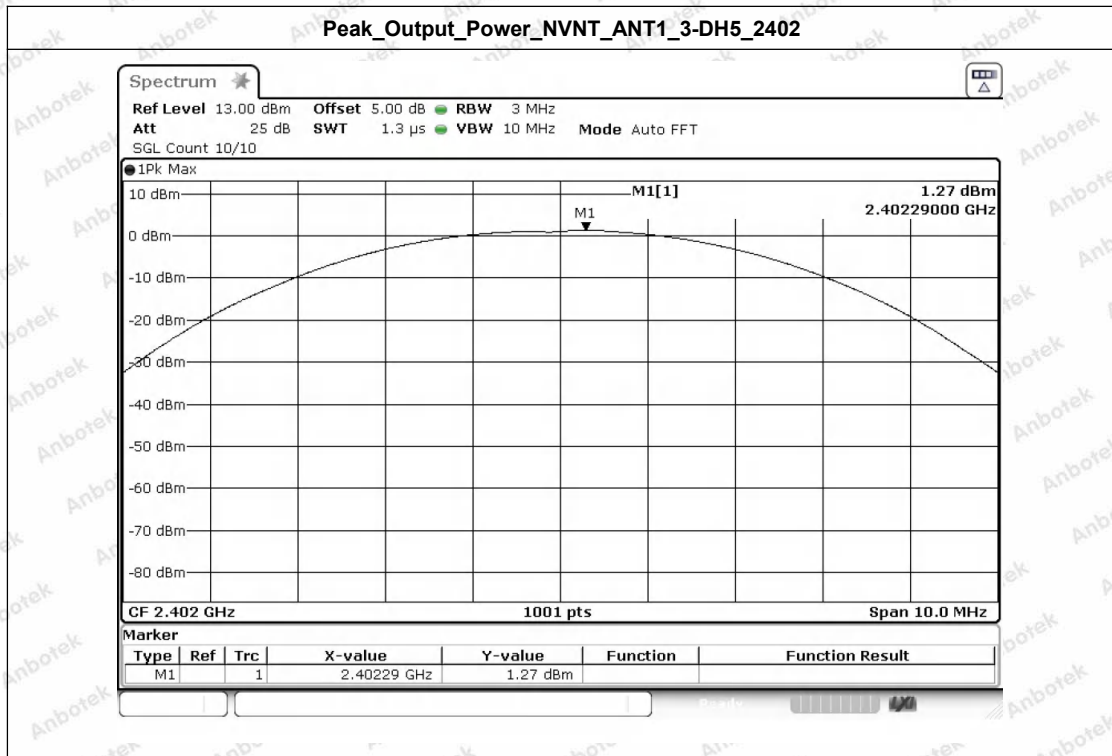
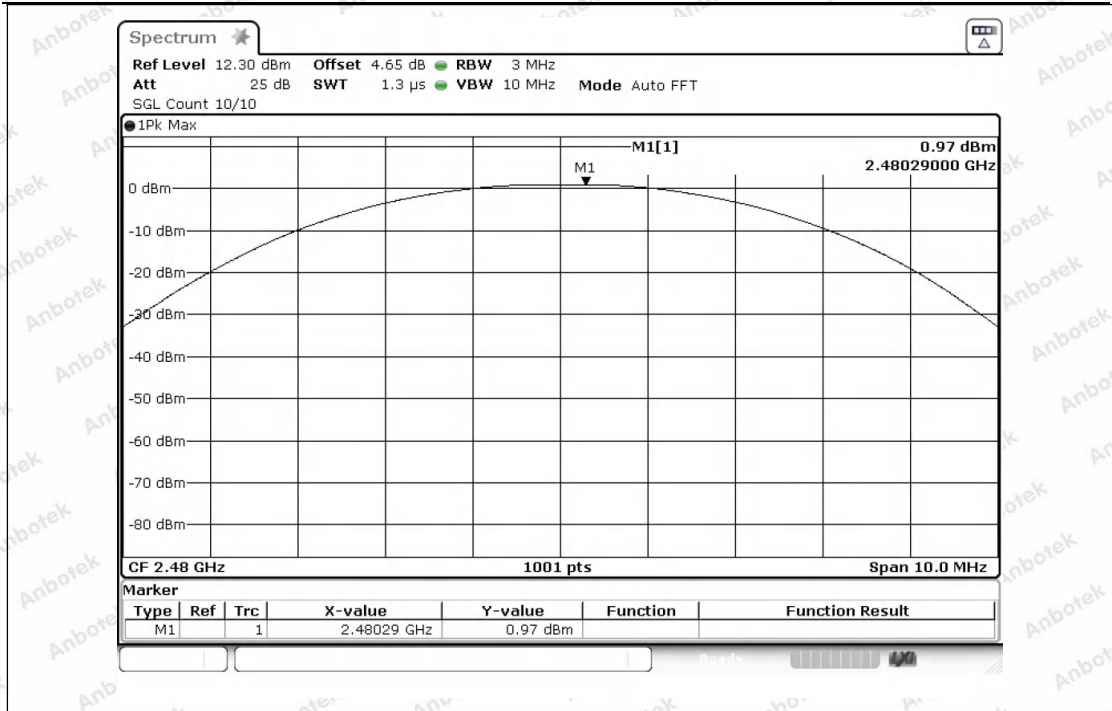

Peak Output Power NVNT_ANT1_3-DH5_2441



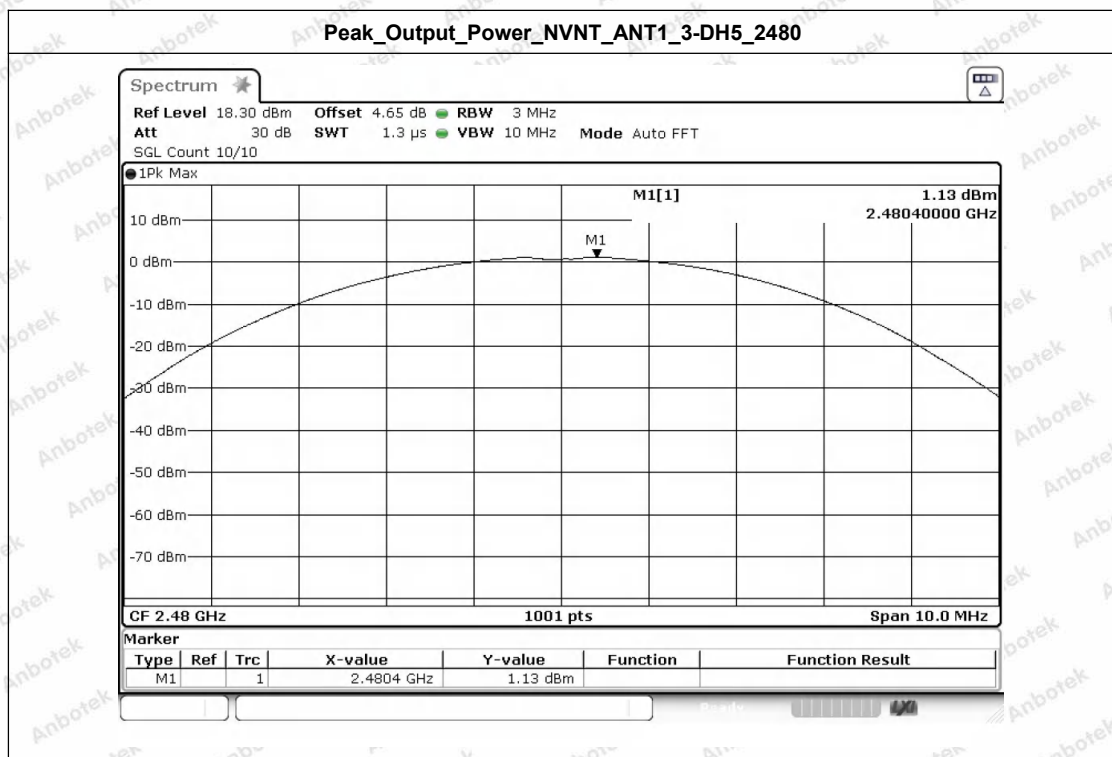
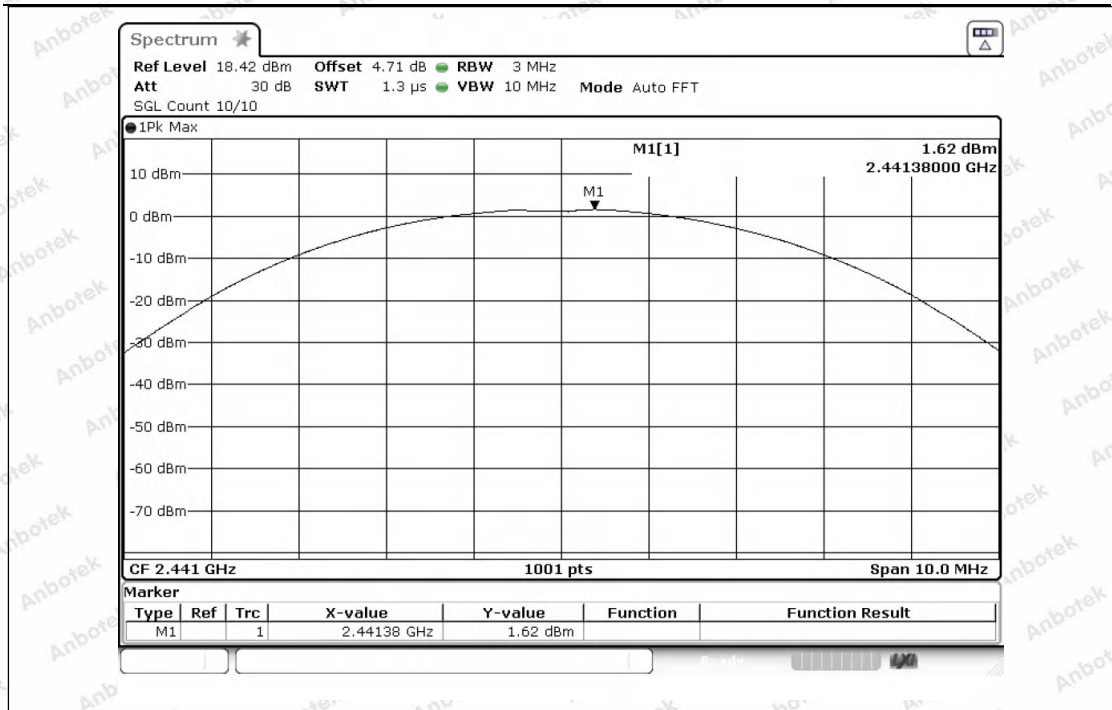

Shenzhen Anbotek Compliance Laboratory Limited

Address: 1/F., Building D, Sogood Science and Technology Park, Sanwei Community, Hangcheng Street, Bao'an District, Shenzhen, Guangdong, China.
 Tel: (86) 0755-26066440 Fax: (86) 0755-26014772 Email: service@anbotek.com

Hotline
 400-003-0500
www.anbotek.com.cn



Appendix D: Spurious Emissions

| Condition | Antenna | Modulation | TX Mode | Spurious MAX.Value(dBm) | Limit | Result |
|-----------|---------|------------|---------|----------------------------|---------|--------|
| NVNT | ANT1 | 1-DH5 | 2402.00 | -47.590 | -20.186 | Pass |
| NVNT | ANT1 | 1-DH5 | 2441.00 | -43.455 | -19.834 | Pass |
| NVNT | ANT1 | 1-DH5 | 2480.00 | -50.628 | -20.230 | Pass |
| NVNT | ANT1 | 2-DH5 | 2402.00 | -42.596 | -19.715 | Pass |
| NVNT | ANT1 | 2-DH5 | 2441.00 | -43.153 | -19.439 | Pass |
| NVNT | ANT1 | 2-DH5 | 2480.00 | -43.483 | -19.977 | Pass |
| NVNT | ANT1 | 3-DH5 | 2402.00 | -48.770 | -20.076 | Pass |
| NVNT | ANT1 | 3-DH5 | 2441.00 | -43.160 | -19.594 | Pass |
| NVNT | ANT1 | 3-DH5 | 2480.00 | -41.733 | -20.071 | Pass |

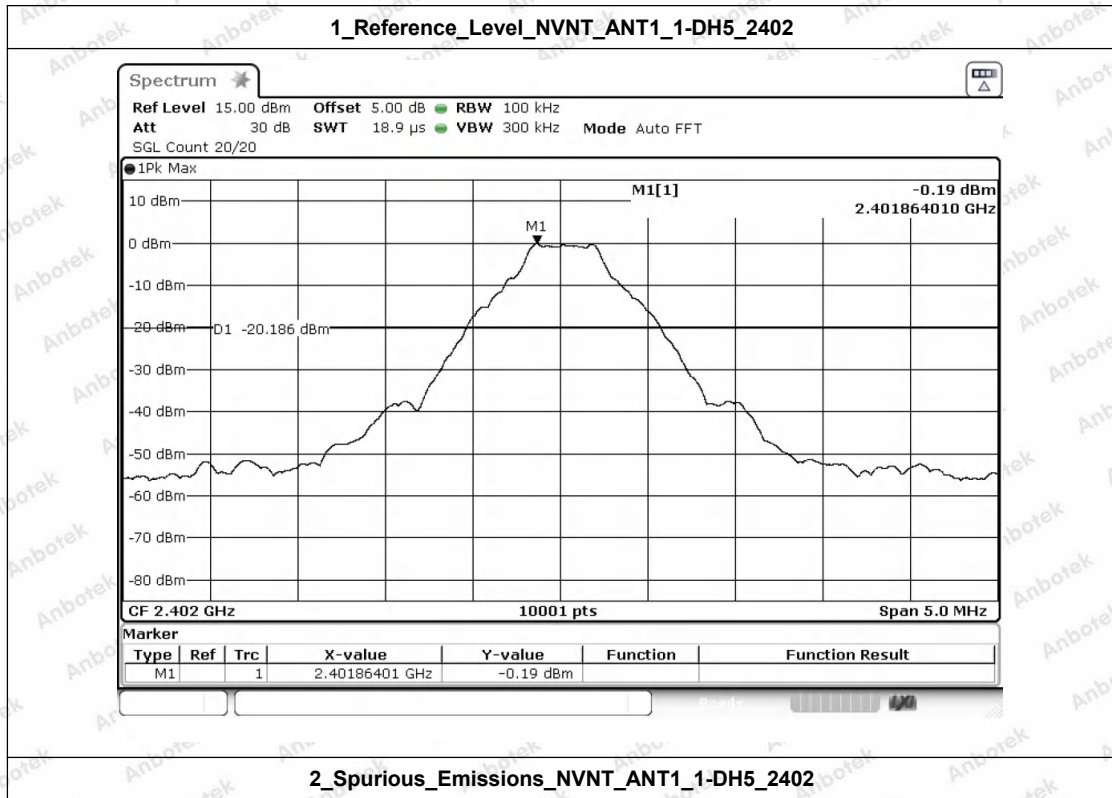

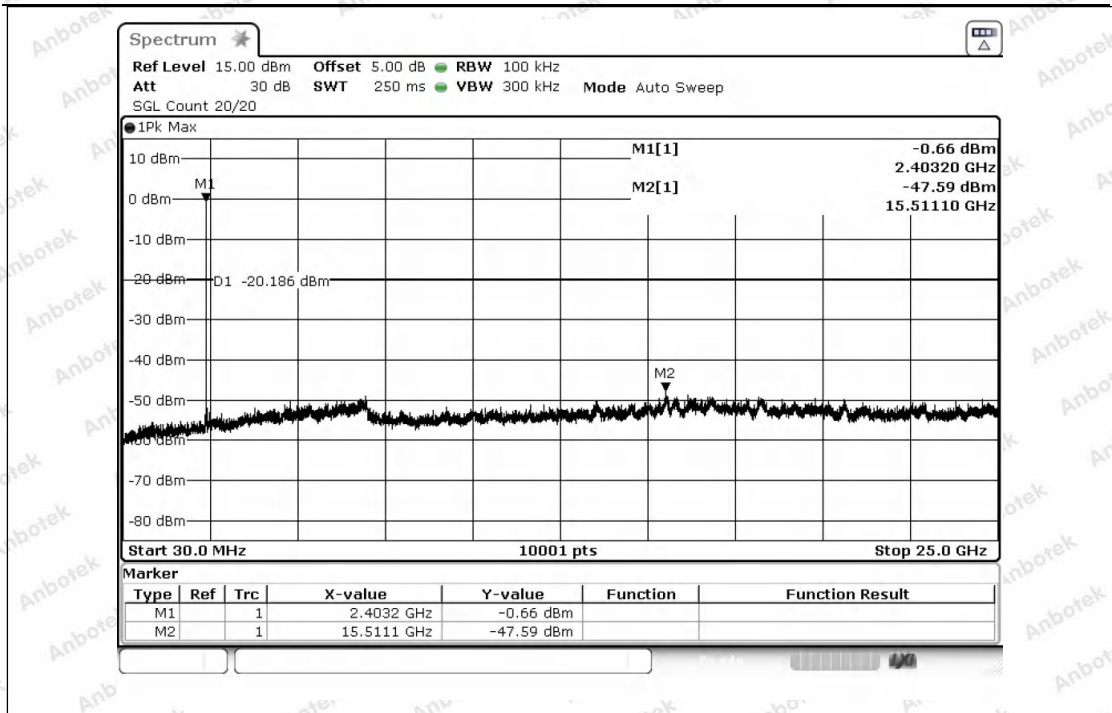

1_Reference_Level_NVNT_ANT1_1-DH5_2441

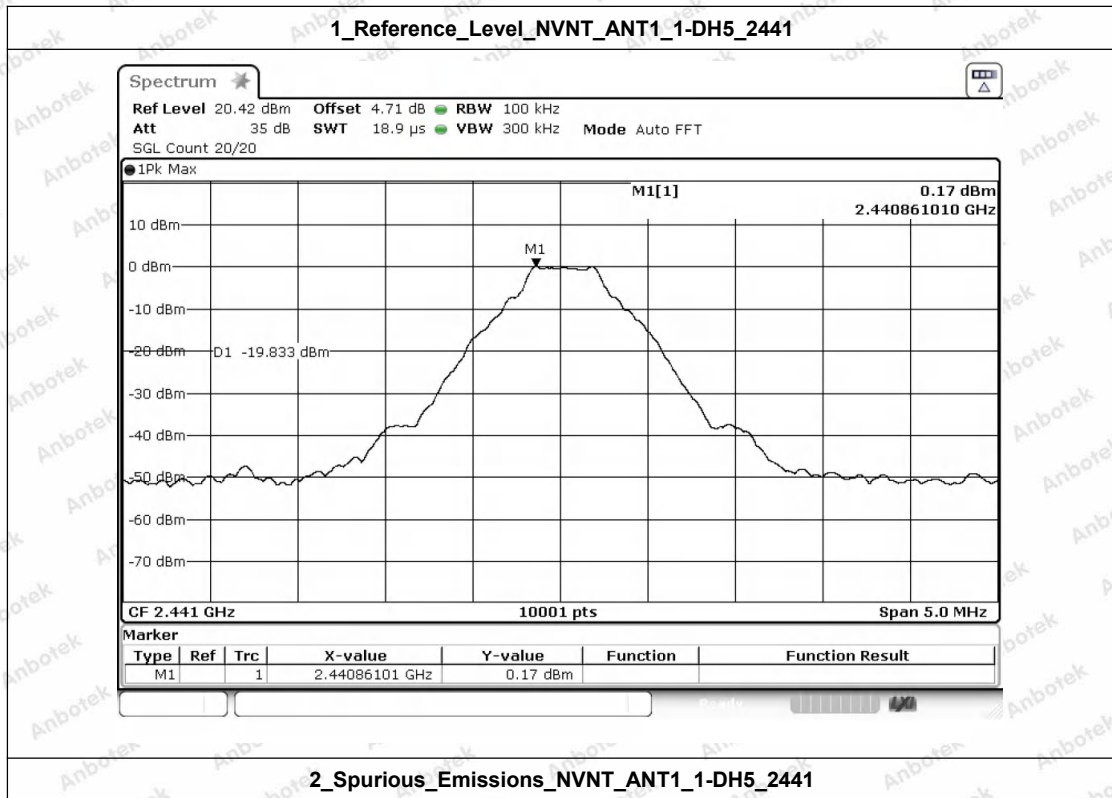

2_Spurious_Emissions_NVNT_ANT1_1-DH5_2441

Shenzhen Anbotek Compliance Laboratory Limited

Address: 1/F., Building D, Sogood Science and Technology Park, Sanwei Community, Hangcheng Street, Bao'an District, Shenzhen, Guangdong, China.
 Tel: (86) 0755-26066440 Fax: (86) 0755-26014772 Email: service@anbotek.com

Hotline 400-003-0500
 www.anbotek.com.cn



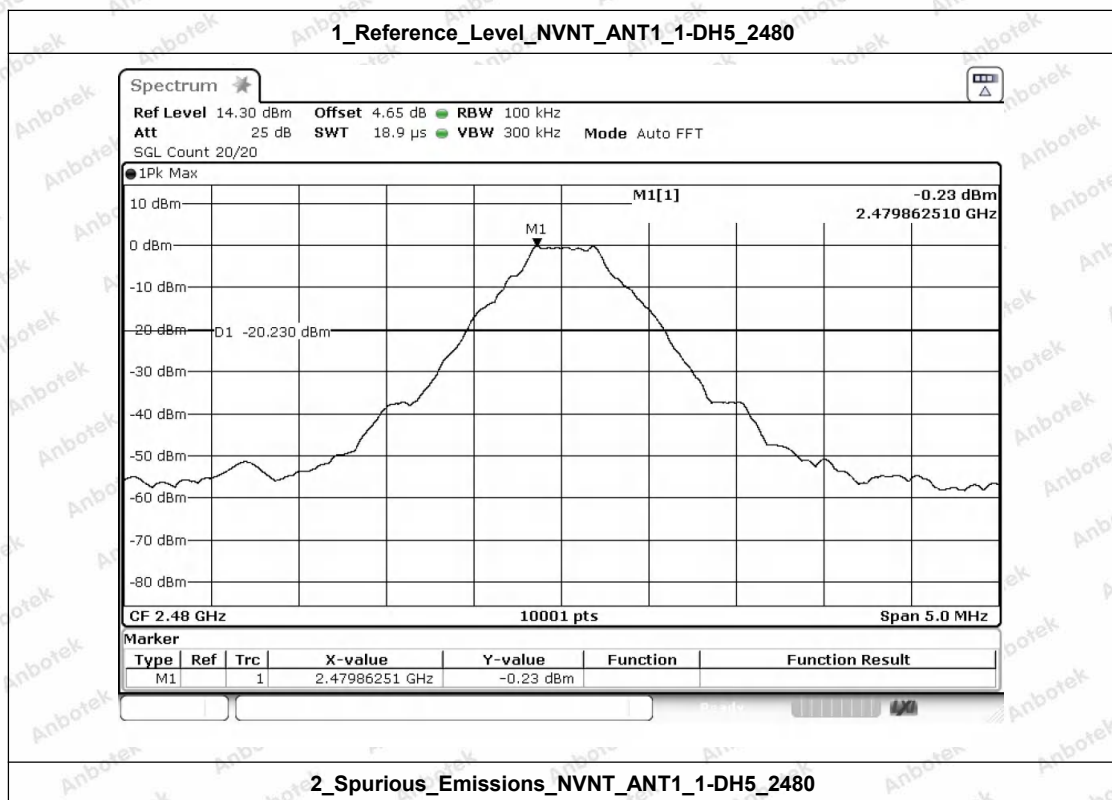
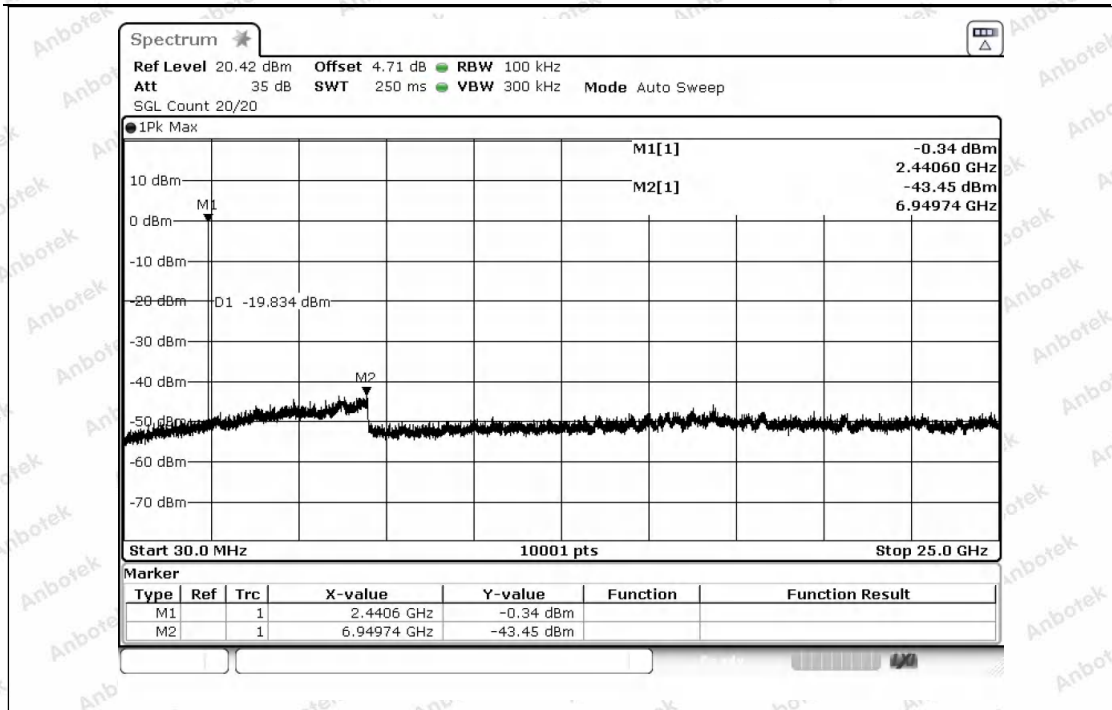

2_Spurious_Emissions_NVNT_ANT1_1-DH5_2480

Shenzhen Anbotek Compliance Laboratory Limited

Address: 1/F., Building D, Sogood Science and Technology Park, Sanwei Community, Hangcheng Street, Bao'an District, Shenzhen, Guangdong, China.
 Tel: (86) 0755-26066440 Fax: (86) 0755-26014772 Email: service@anbotek.com

Hotline
 400-003-0500
 www.anbotek.com.cn



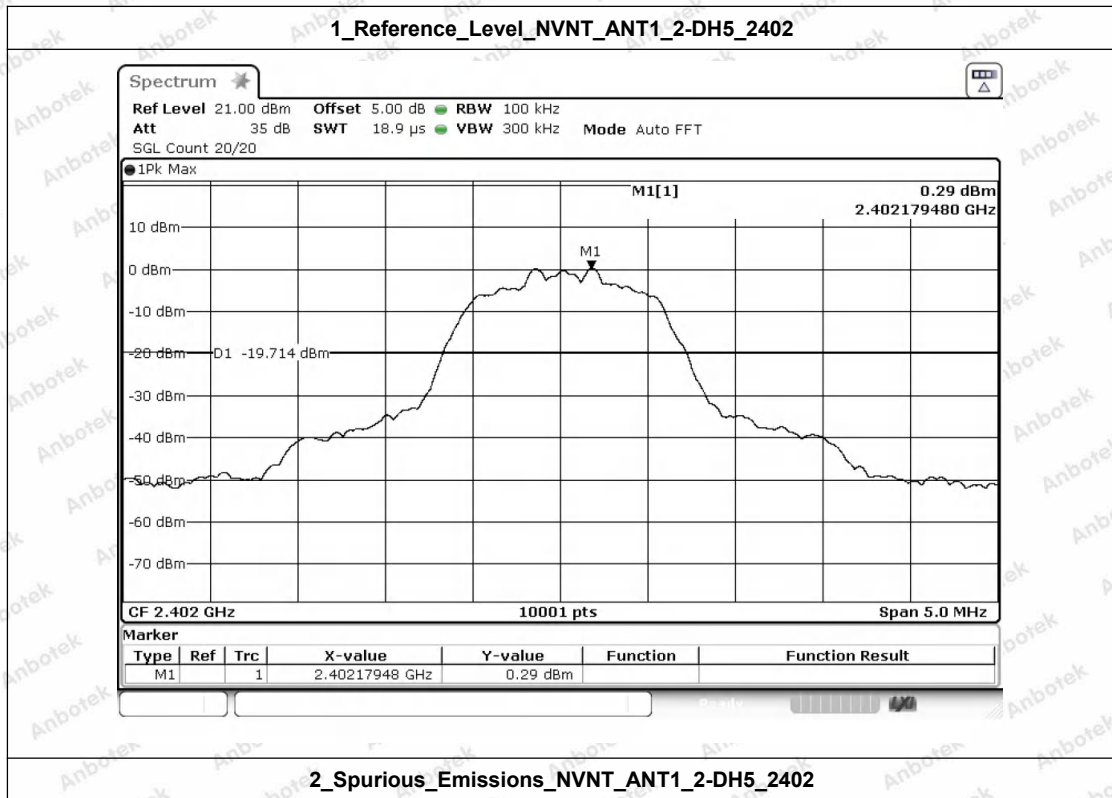
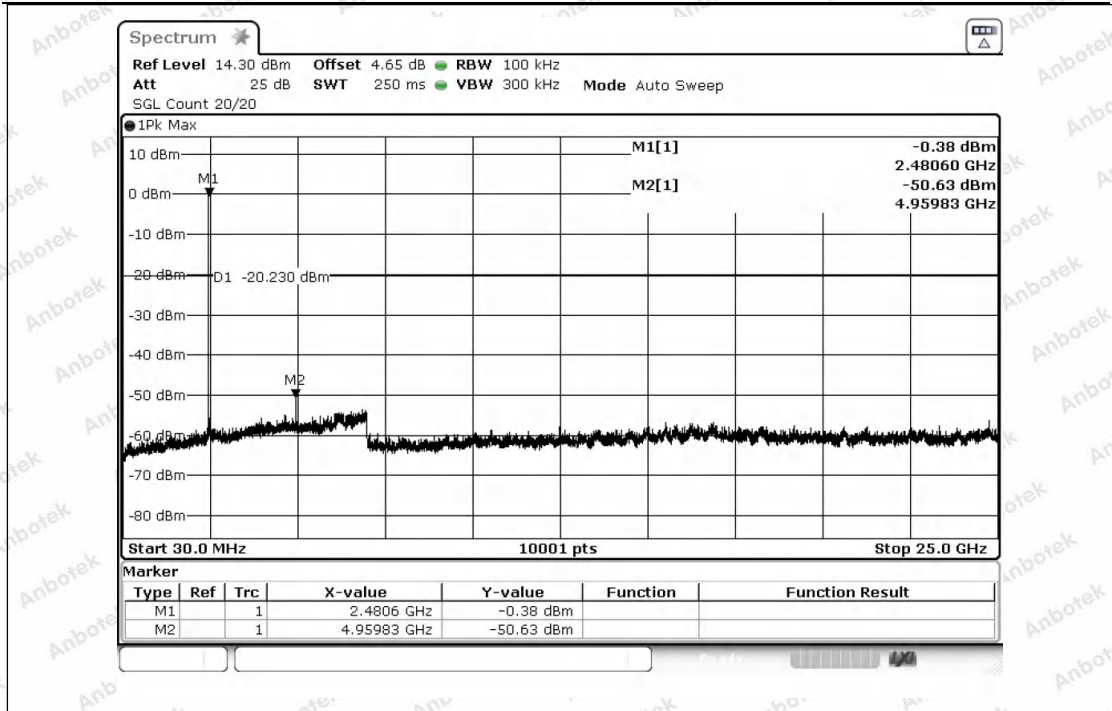

2_Spurious_Emissions_NVNT_ANT1_2-DH5_2402

Shenzhen Anbotek Compliance Laboratory Limited

Address: 1/F., Building D, Sogood Science and Technology Park, Sanwei Community, Hangcheng Street, Bao'an District, Shenzhen, Guangdong, China.
 Tel: (86) 0755-26066440 Fax: (86) 0755-26014772 Email: service@anbotek.com

Hotline
 400-003-0500
 www.anbotek.com.cn



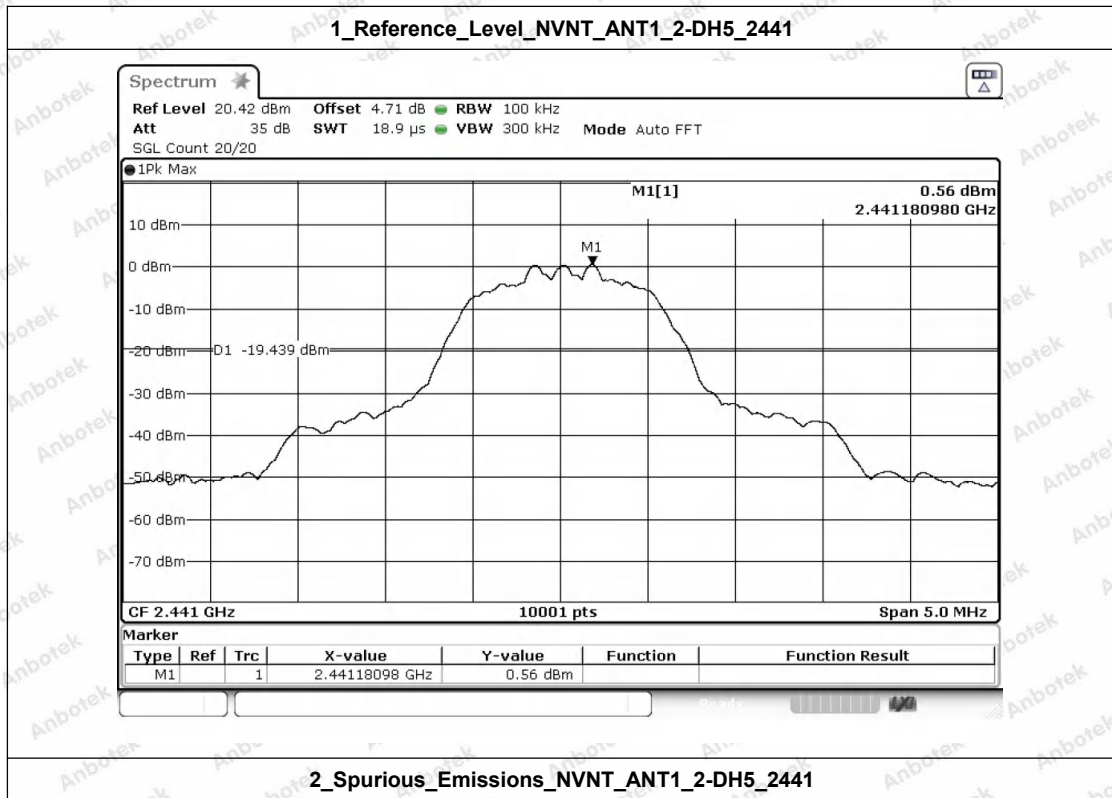
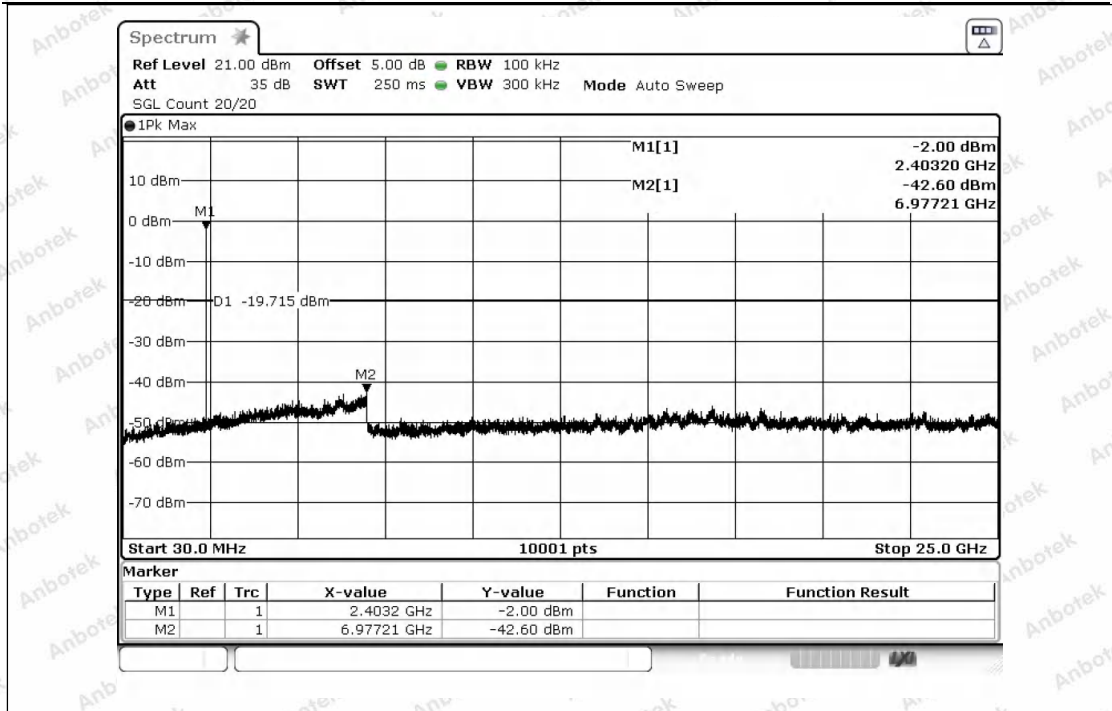

Shenzhen Anbotek Compliance Laboratory Limited

Address: 1/F., Building D, Sogood Science and Technology Park, Sanwei Community, Hangcheng Street, Bao'an District, Shenzhen, Guangdong, China.
 Tel: (86) 0755-26066440 Fax: (86) 0755-26014772 Email: service@anbotek.com

Hotline
 400-003-0500
 www.anbotek.com.cn



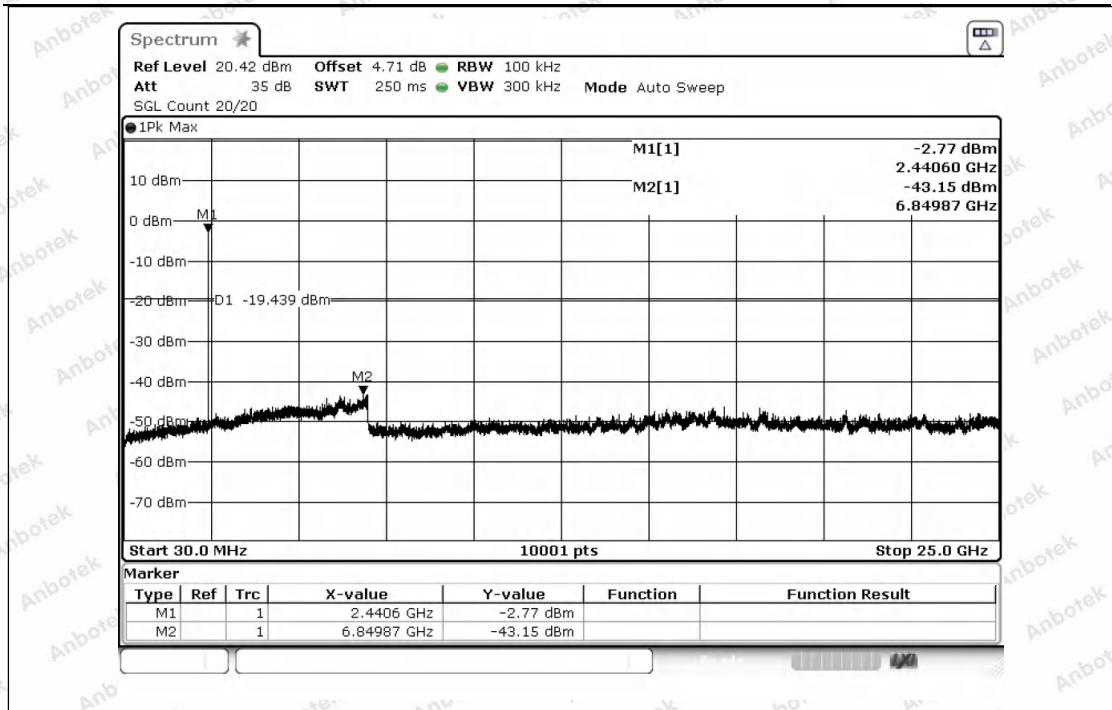

1_Reference_Level_NVNT_ANT1_2-DH5_2480

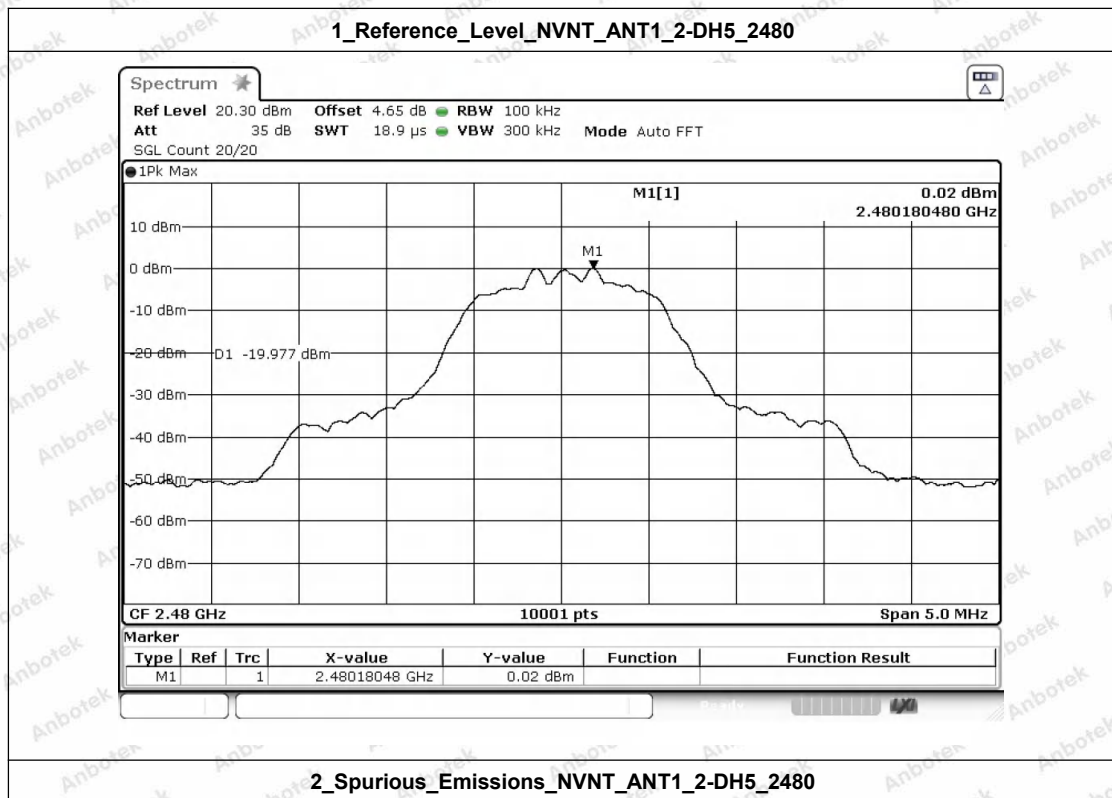

2_Spurious_Emissions_NVNT_ANT1_2-DH5_2480

Shenzhen Anbotek Compliance Laboratory Limited

Address: 1/F., Building D, Sogood Science and Technology Park, Sanwei Community, Hangcheng Street, Bao'an District, Shenzhen, Guangdong, China.
 Tel: (86) 0755-26066440 Fax: (86) 0755-26014772 Email: service@anbotek.com

Hotline
 400-003-0500
 www.anbotek.com.cn



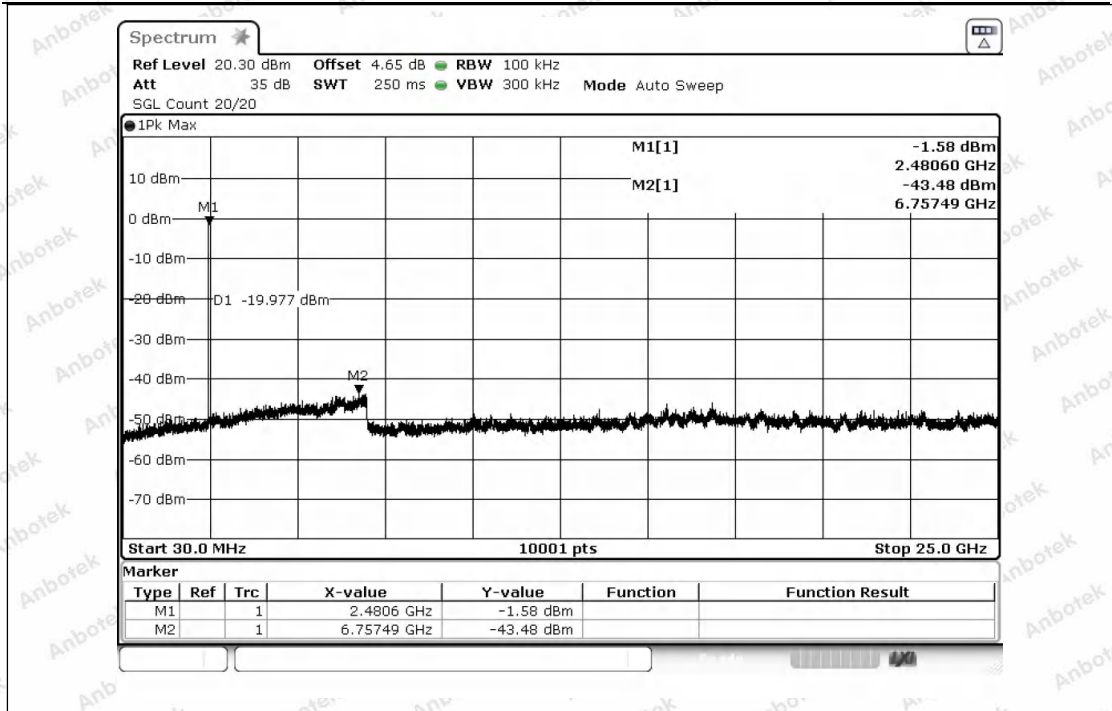

1_Reference_Level_NVNT_ANT1_3-DH5_2402

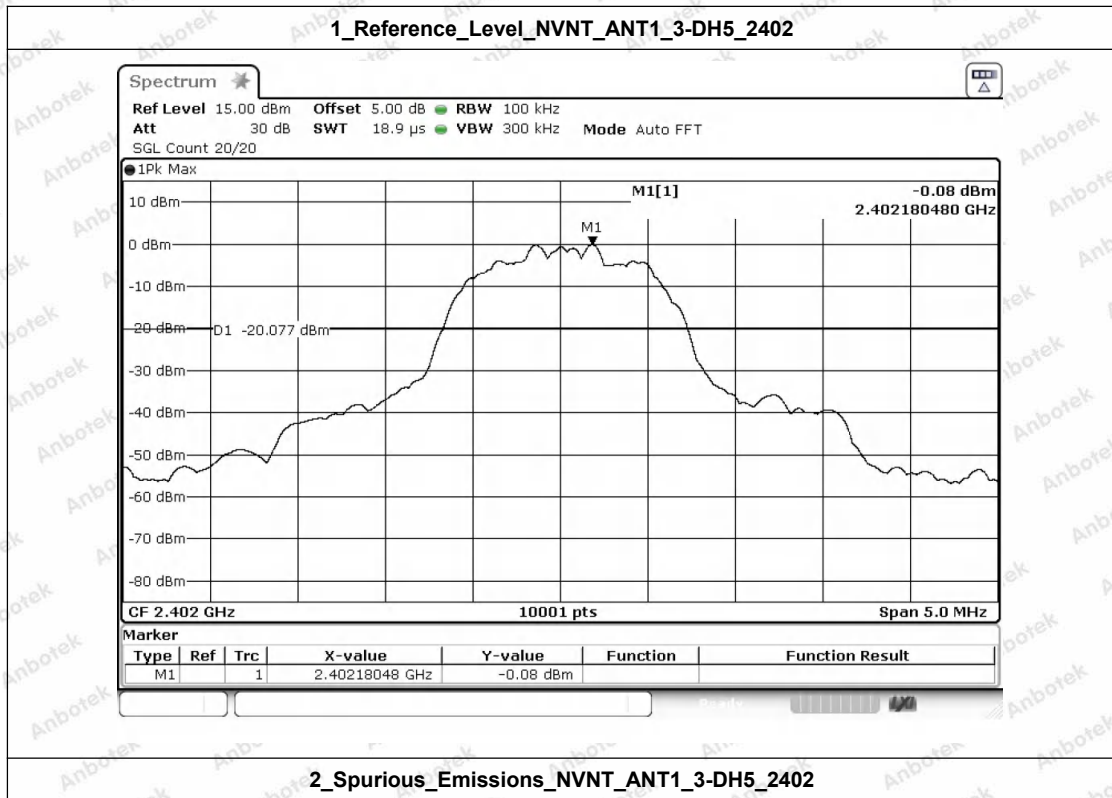

2_Spurious_Emissions_NVNT_ANT1_3-DH5_2402

Shenzhen Anbotek Compliance Laboratory Limited

Address: 1/F., Building D, Sogood Science and Technology Park, Sanwei Community, Hangcheng Street, Bao'an District, Shenzhen, Guangdong, China.
 Tel: (86) 0755-26066440 Fax: (86) 0755-26014772 Email: service@anbotek.com

Hotline
 400-003-0500
 www.anbotek.com.cn



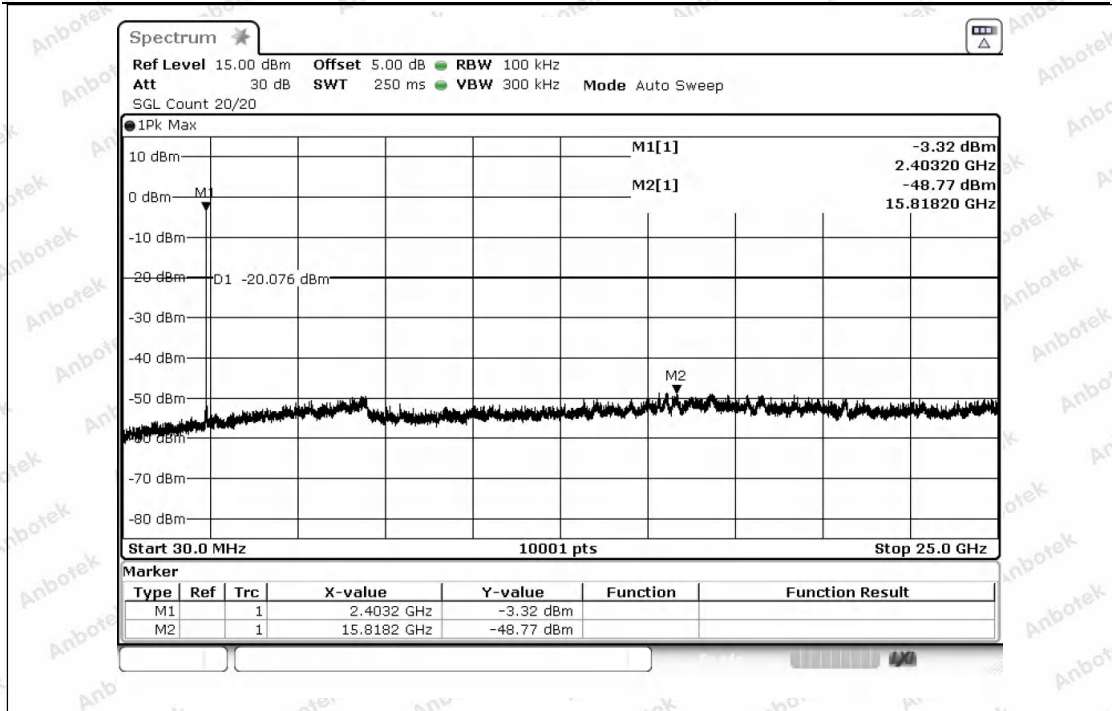

1_Reference_Level_NVNT_ANT1_3-DH5_2441

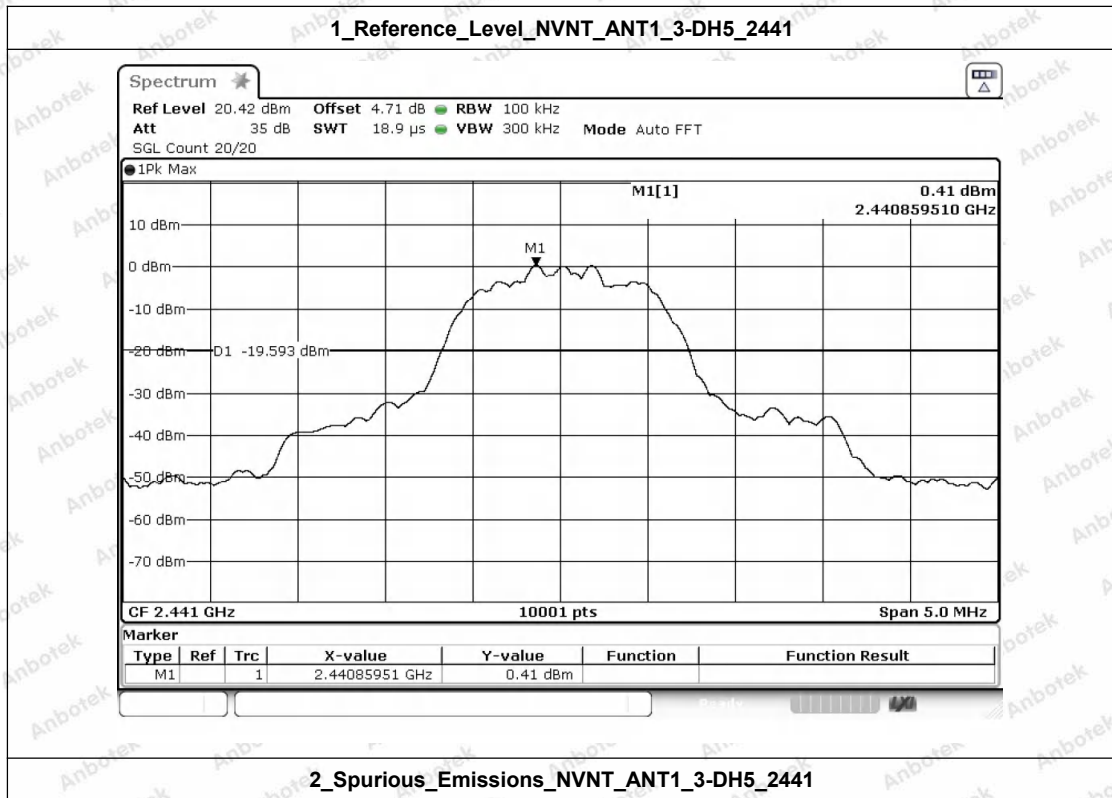

2_Spurious_Emissions_NVNT_ANT1_3-DH5_2441

Shenzhen Anbotek Compliance Laboratory Limited

Address: 1/F., Building D, Sogood Science and Technology Park, Sanwei Community, Hangcheng Street, Bao'an District, Shenzhen, Guangdong, China.
 Tel: (86) 0755-26066440 Fax: (86) 0755-26014772 Email: service@anbotek.com

Hotline 400-003-0500
 www.anbotek.com.cn



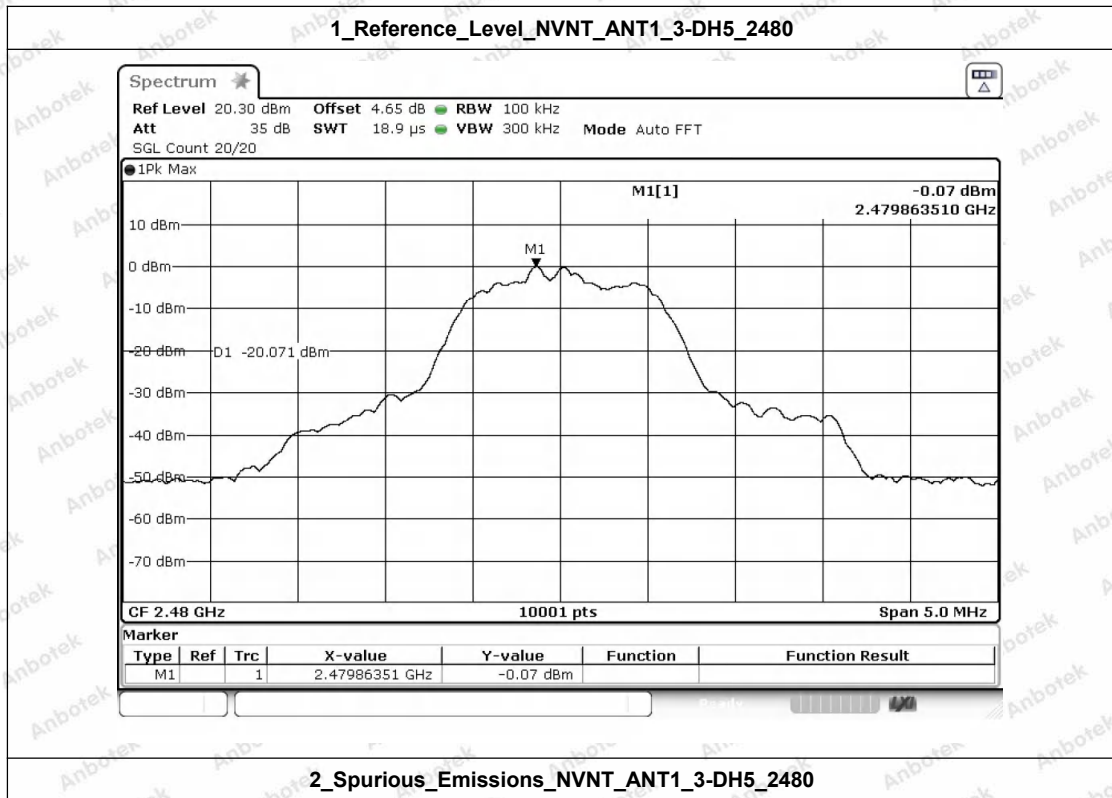
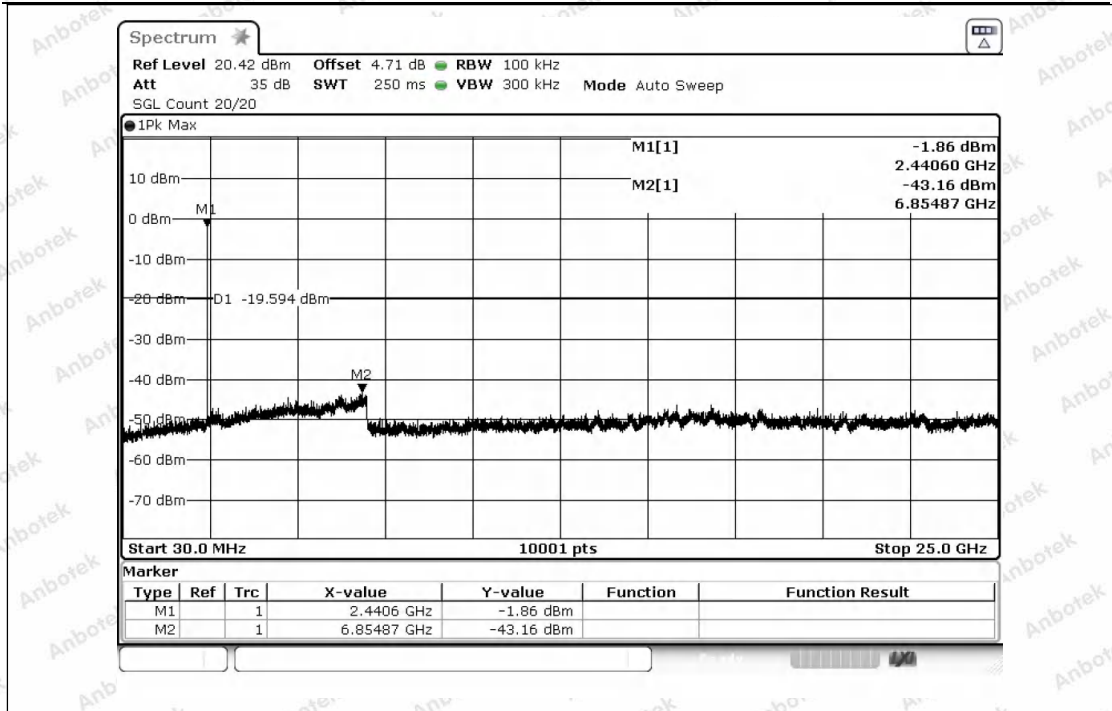

2_Spurious_Emissions_NVNT_ANT1_3-DH5_2480

Shenzhen Anbotek Compliance Laboratory Limited

Address: 1/F., Building D, Sogood Science and Technology Park, Sanwei Community, Hangcheng Street, Bao'an District, Shenzhen, Guangdong, China.
 Tel: (86) 0755-26066440 Fax: (86) 0755-26014772 Email: service@anbotek.com

Hotline 400-003-0500
 www.anbotek.com.cn



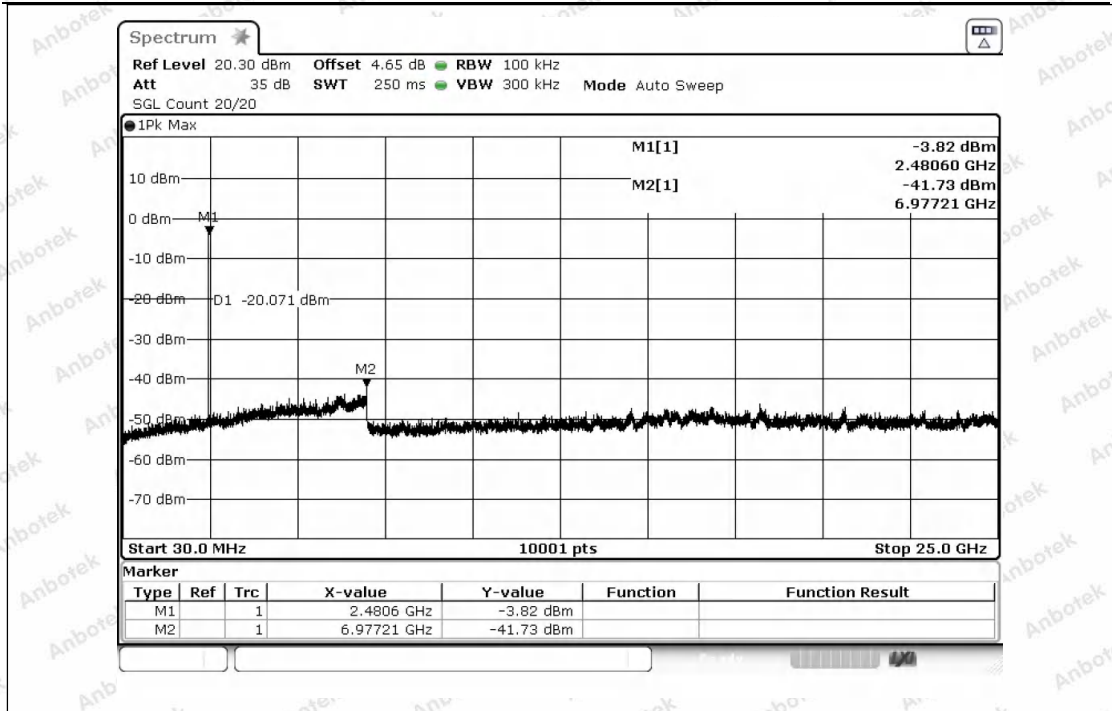

Shenzhen Anbotek Compliance Laboratory Limited

Address: 1/F., Building D, Sogood Science and Technology Park, Sanwei Community, Hangcheng Street, Bao'an District, Shenzhen, Guangdong, China.
 Tel: (86) 0755-26066440 Fax: (86) 0755-26014772 Email: service@anbotek.com

Hotline
 400-003-0500
 www.anbotek.com.cn



Appendix E: Bandedge

| Condition | Antenna | Modulation | TX Mode | Bandedge MAX.Value | Limit | Result |
|-----------|---------|------------|-------------|--------------------|---------|--------|
| NVNT | ANT1 | 1-DH5 | 2402.00 | -50.594 | -20.186 | Pass |
| NVNT | ANT1 | 1-DH5 | Hopping_LCH | -53.200 | -19.472 | Pass |
| NVNT | ANT1 | 1-DH5 | 2480.00 | -54.245 | -20.230 | Pass |
| NVNT | ANT1 | 1-DH5 | Hopping_HCH | -47.822 | -19.788 | Pass |
| NVNT | ANT1 | 2-DH5 | 2402.00 | -48.600 | -19.715 | Pass |
| NVNT | ANT1 | 2-DH5 | Hopping_LCH | -54.039 | -18.970 | Pass |
| NVNT | ANT1 | 2-DH5 | 2480.00 | -48.438 | -19.977 | Pass |
| NVNT | ANT1 | 2-DH5 | Hopping_HCH | -53.368 | -19.363 | Pass |
| NVNT | ANT1 | 3-DH5 | 2402.00 | -52.861 | -20.076 | Pass |
| NVNT | ANT1 | 3-DH5 | Hopping_LCH | -53.109 | -19.253 | Pass |
| NVNT | ANT1 | 3-DH5 | 2480.00 | -48.401 | -20.071 | Pass |
| NVNT | ANT1 | 3-DH5 | Hopping_HCH | -53.457 | -19.425 | Pass |

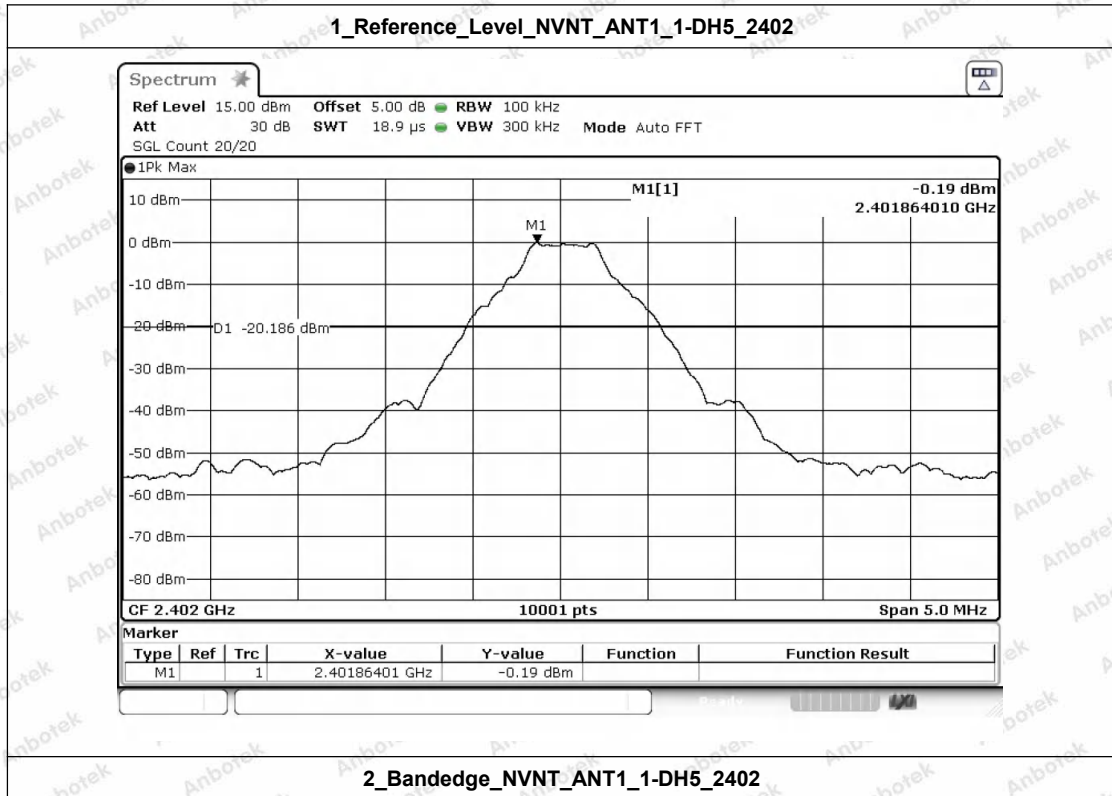

2_Bandedge_NVNT_ANT1_1-DH5_2402

Shenzhen Anbotek Compliance Laboratory Limited

Address: 1/F., Building D, Sogood Science and Technology Park, Sanwei Community, Hangcheng Street, Bao'an District, Shenzhen, Guangdong, China.
 Tel: (86) 0755-26066440 Fax: (86) 0755-26014772 Email: service@anbotek.com

Hotline
 400-003-0500
 www.anbotek.com.cn



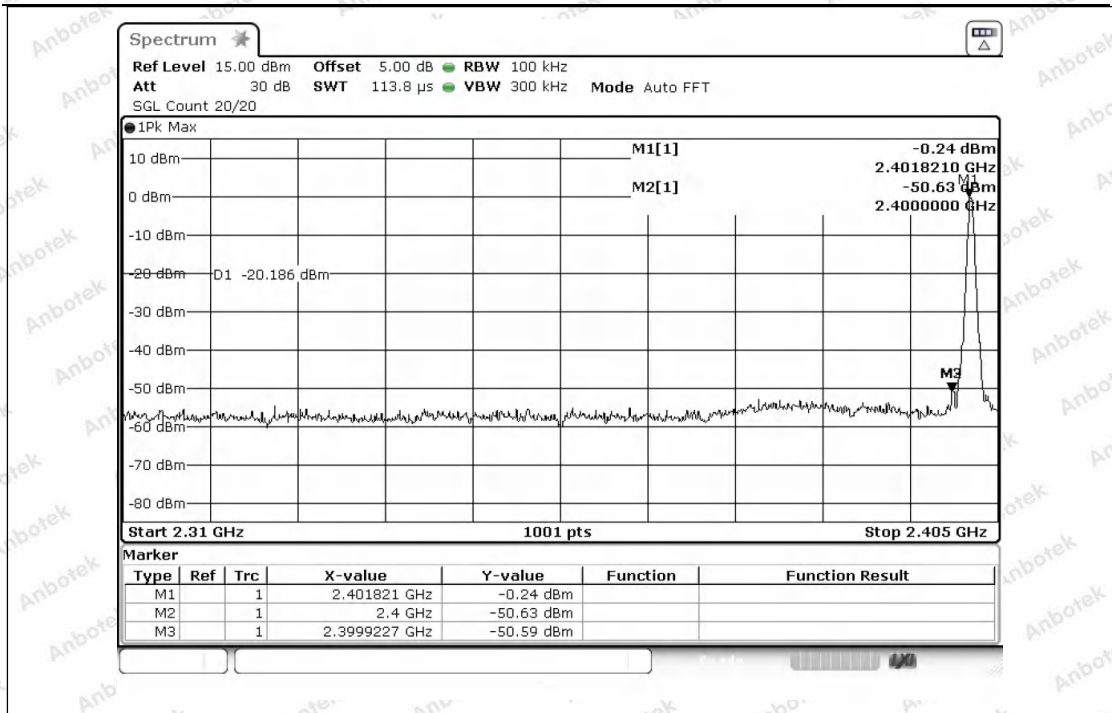

1_Reference_Level_Hopping_NVNT_ANT1_1-DH5_Hopping

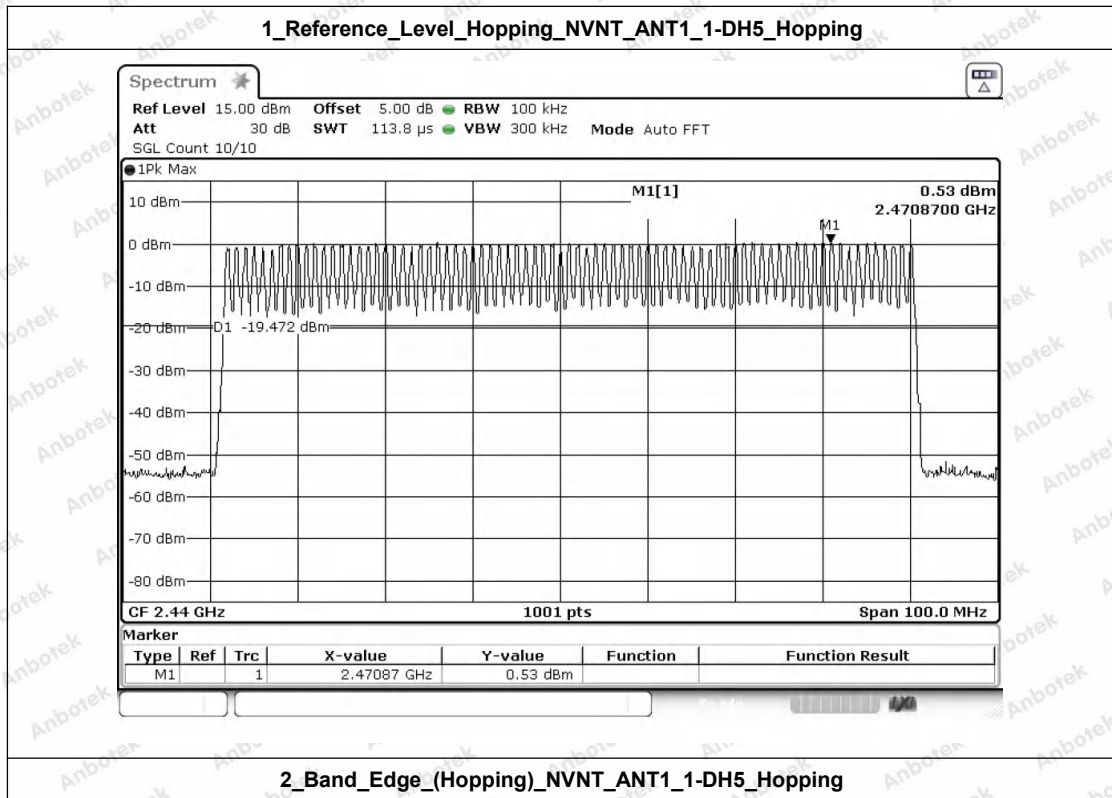

2_Band_Edge_(Hopping)_NVNT_ANT1_1-DH5_Hopping

Shenzhen Anbotek Compliance Laboratory Limited

Address: 1/F., Building D, Sogood Science and Technology Park, Sanwei Community, Hangcheng Street, Bao'an District, Shenzhen, Guangdong, China.
 Tel: (86) 0755-26066440 Fax: (86) 0755-26014772 Email: service@anbotek.com

Hotline 400-003-0500
 www.anbotek.com.cn



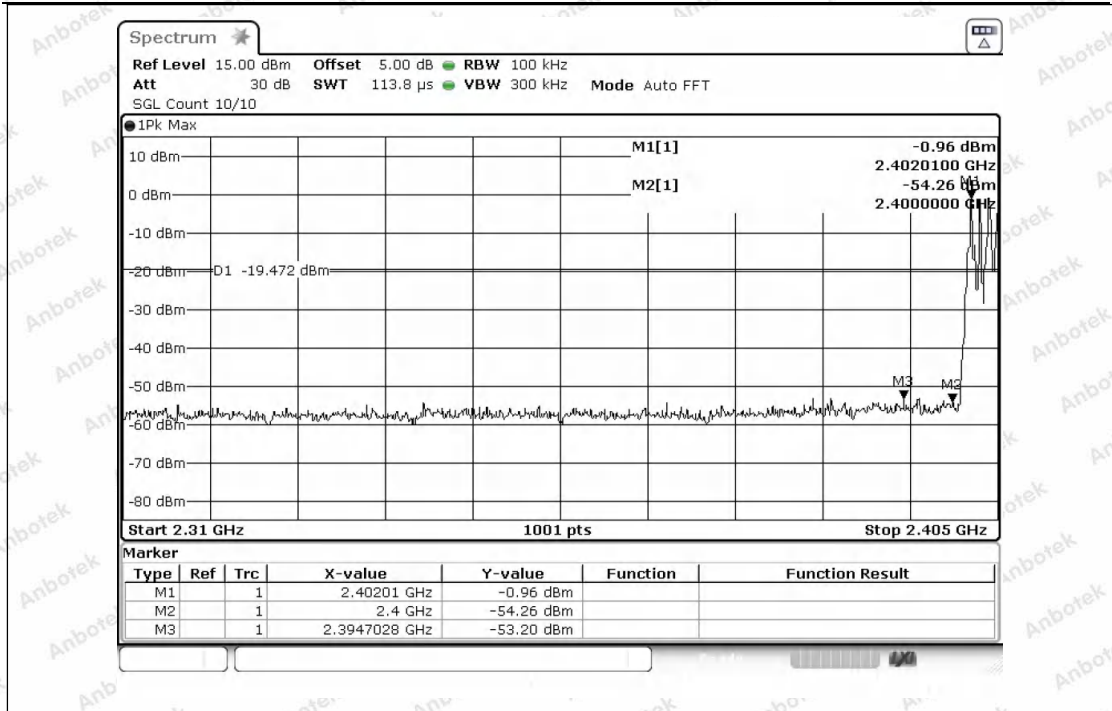

1_Reference_Level_NVNT_ANT1_1-DH5_2480

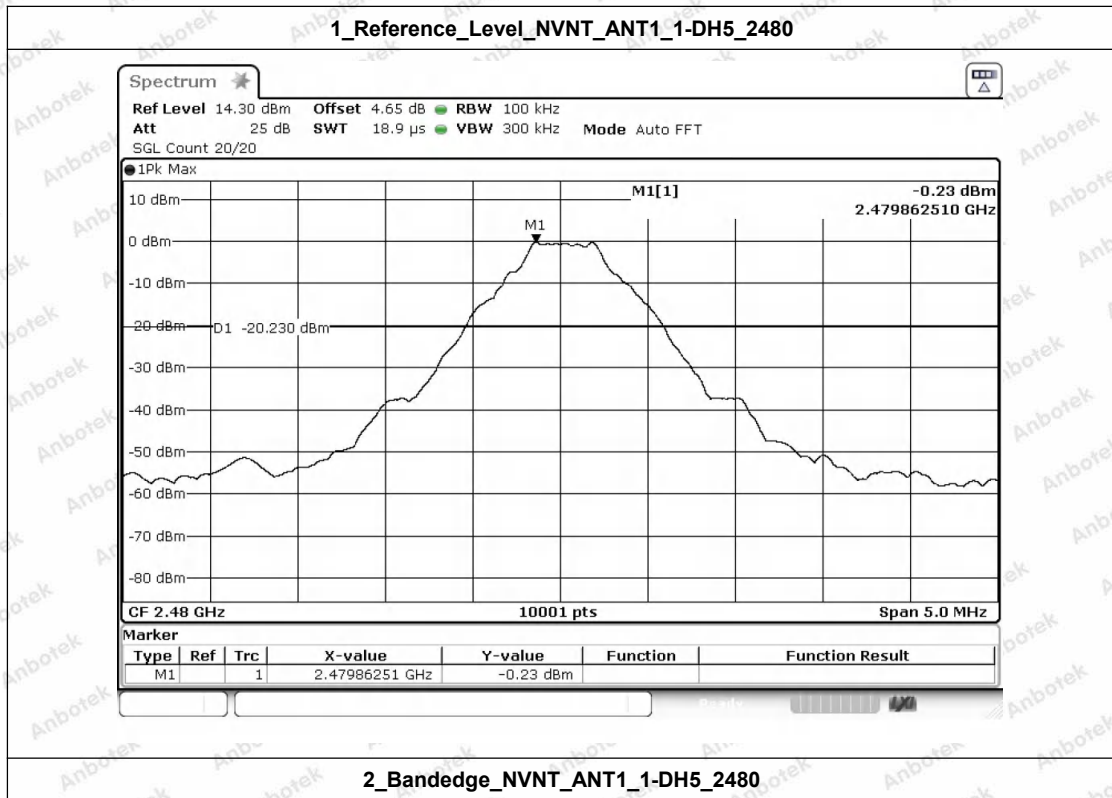

2_Bandedge_NVNT_ANT1_1-DH5_2480

Shenzhen Anbotek Compliance Laboratory Limited

Address: 1/F., Building D, Sogood Science and Technology Park, Sanwei Community, Hangcheng Street, Bao'an District, Shenzhen, Guangdong, China.
 Tel: (86) 0755-26066440 Fax: (86) 0755-26014772 Email: service@anbotek.com

Hotline 400-003-0500
 www.anbotek.com.cn



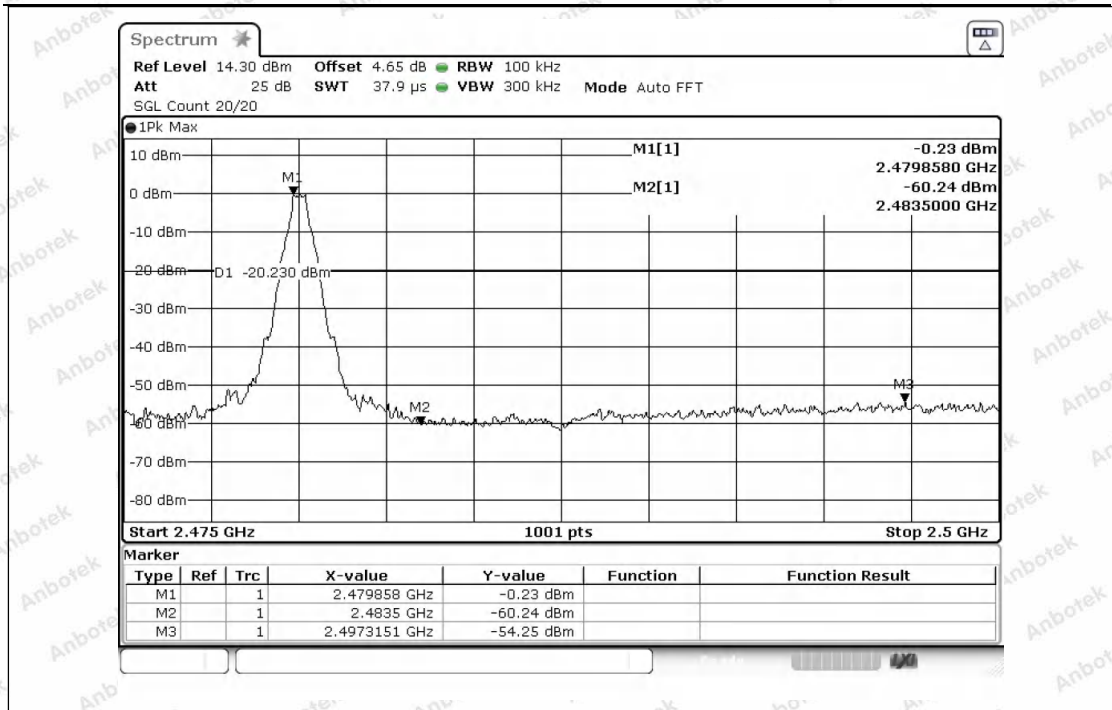

1_Reference_Level_Hopping_NVNT_ANT1_1-DH5_Hopping

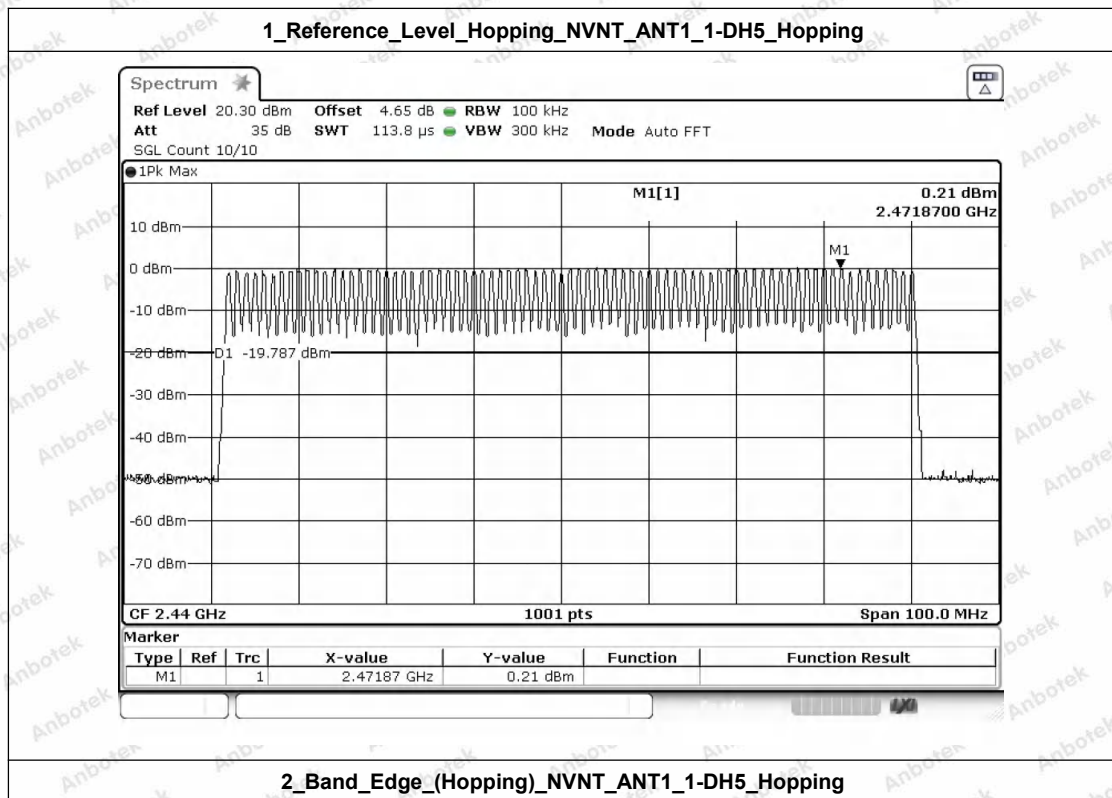

2_Band_Edge_(Hopping)_NVNT_ANT1_1-DH5_Hopping



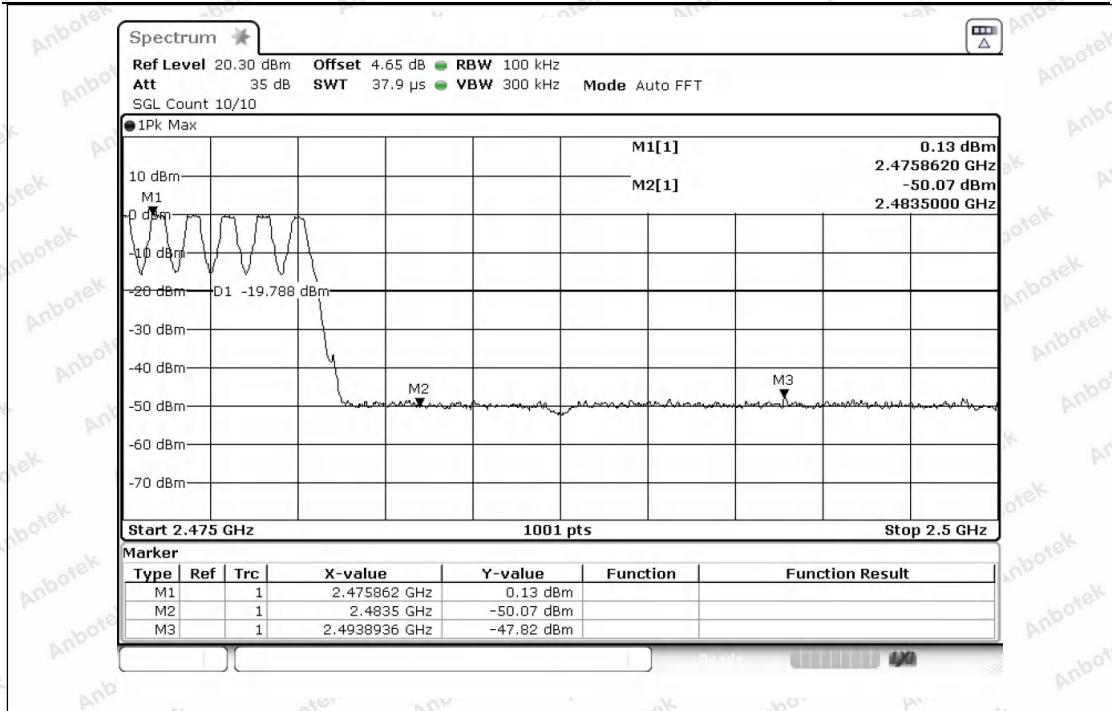

1_Reference_Level_NVNT_ANT1_2-DH5_2402

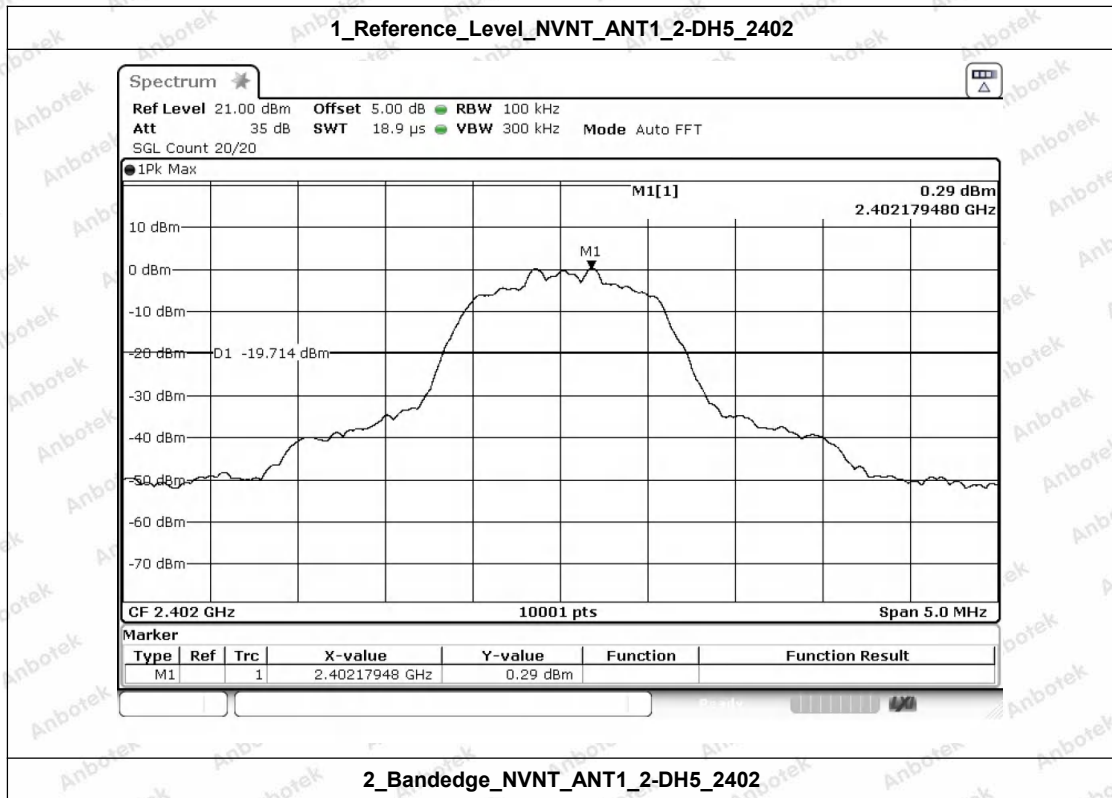

2_Bandedge_NVNT_ANT1_2-DH5_2402



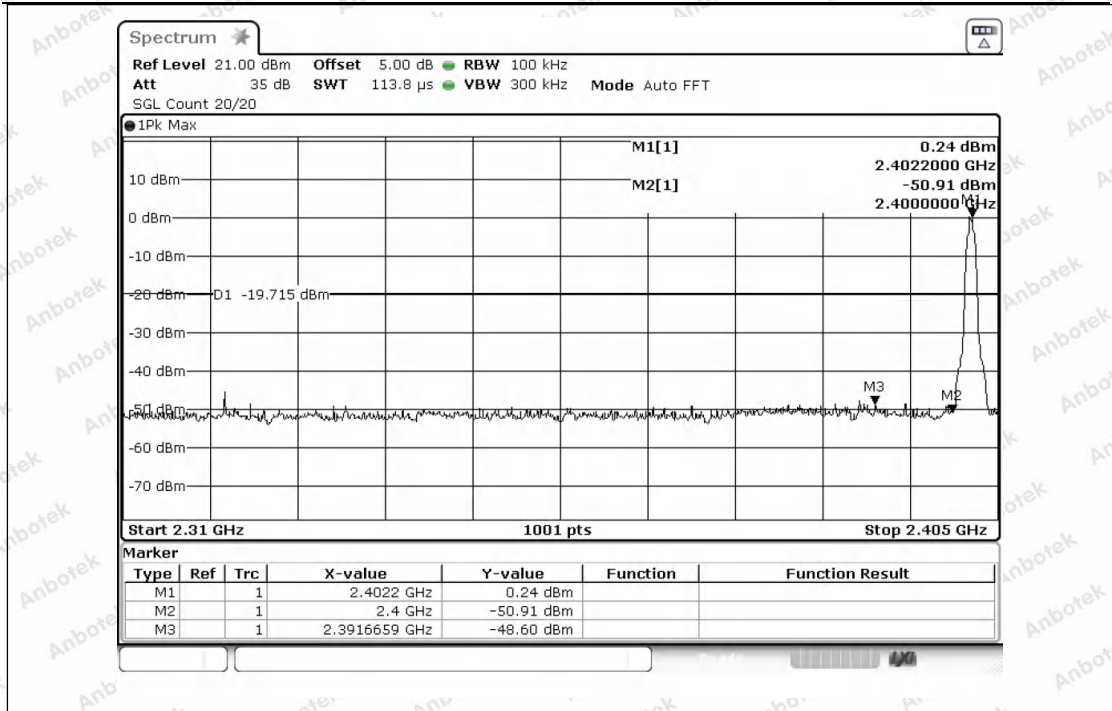

1_Reference_Level_Hopping_NVNT_ANT1_2-DH5_Hopping

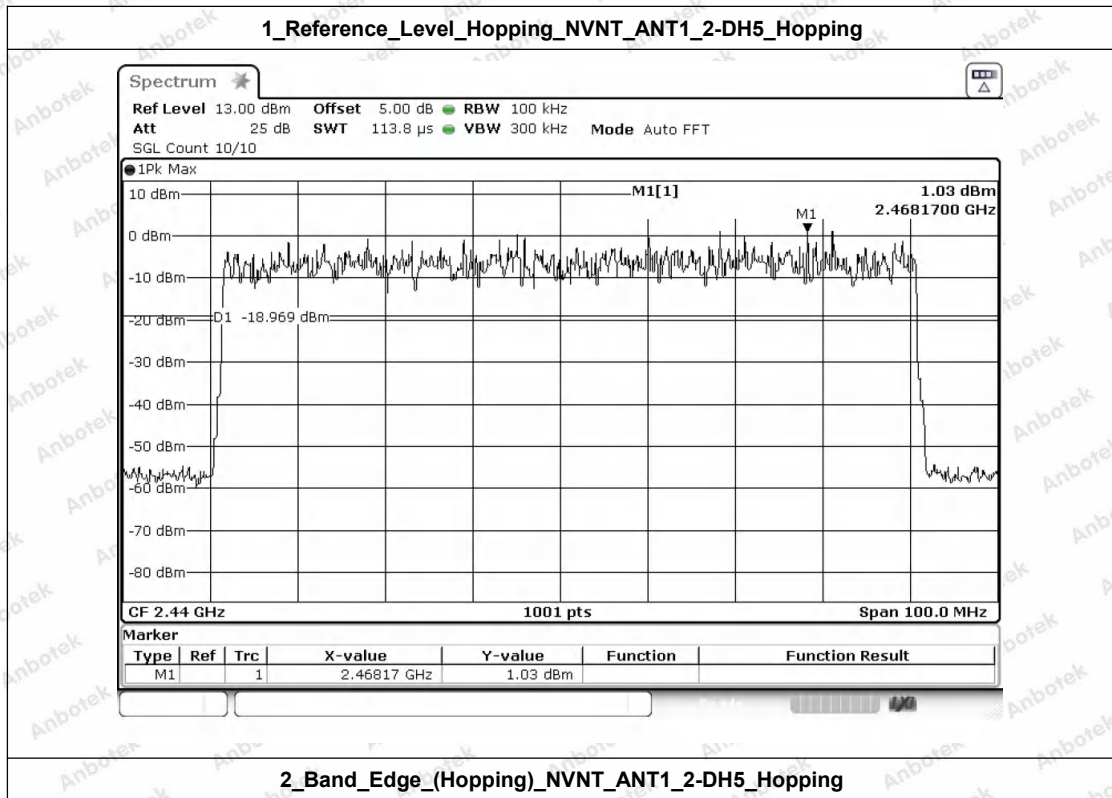

2_Band_Edge_(Hopping)_NVNT_ANT1_2-DH5_Hopping

Shenzhen Anbotek Compliance Laboratory Limited

Address: 1/F., Building D, Sogood Science and Technology Park, Sanwei Community, Hangcheng Street, Bao'an District, Shenzhen, Guangdong, China.
 Tel: (86) 0755-26066440 Fax: (86) 0755-26014772 Email: service@anbotek.com

Hotline
 400-003-0500
 www.anbotek.com.cn



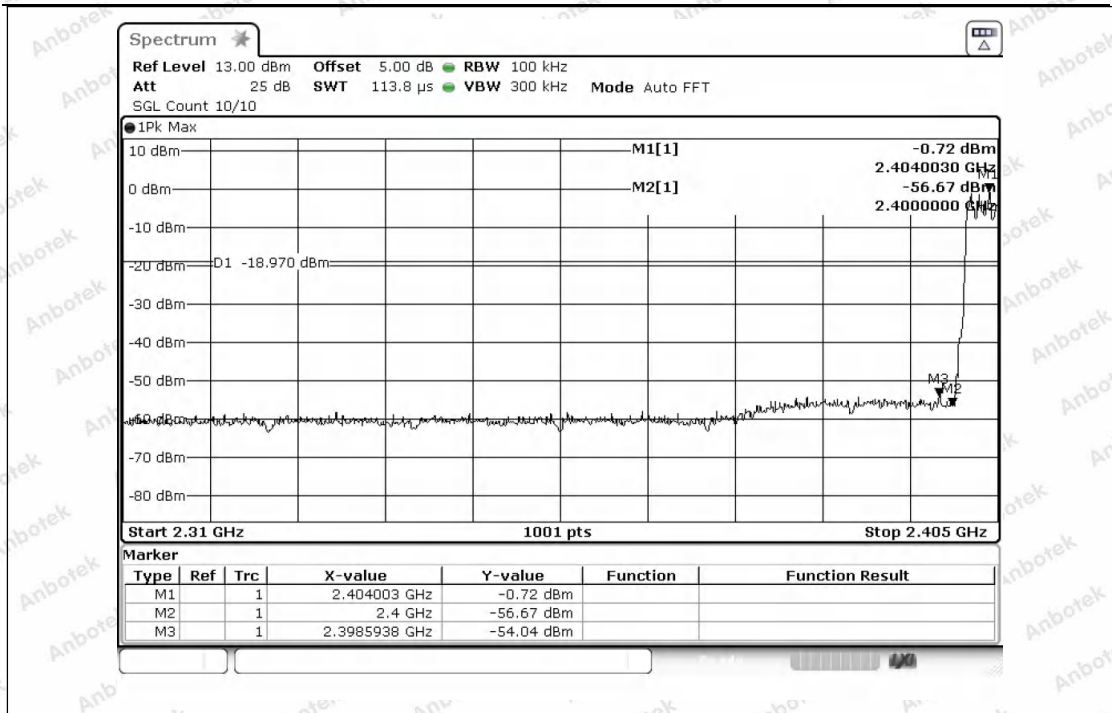

1_Reference_Level_NVNT_ANT1_2-DH5_2480

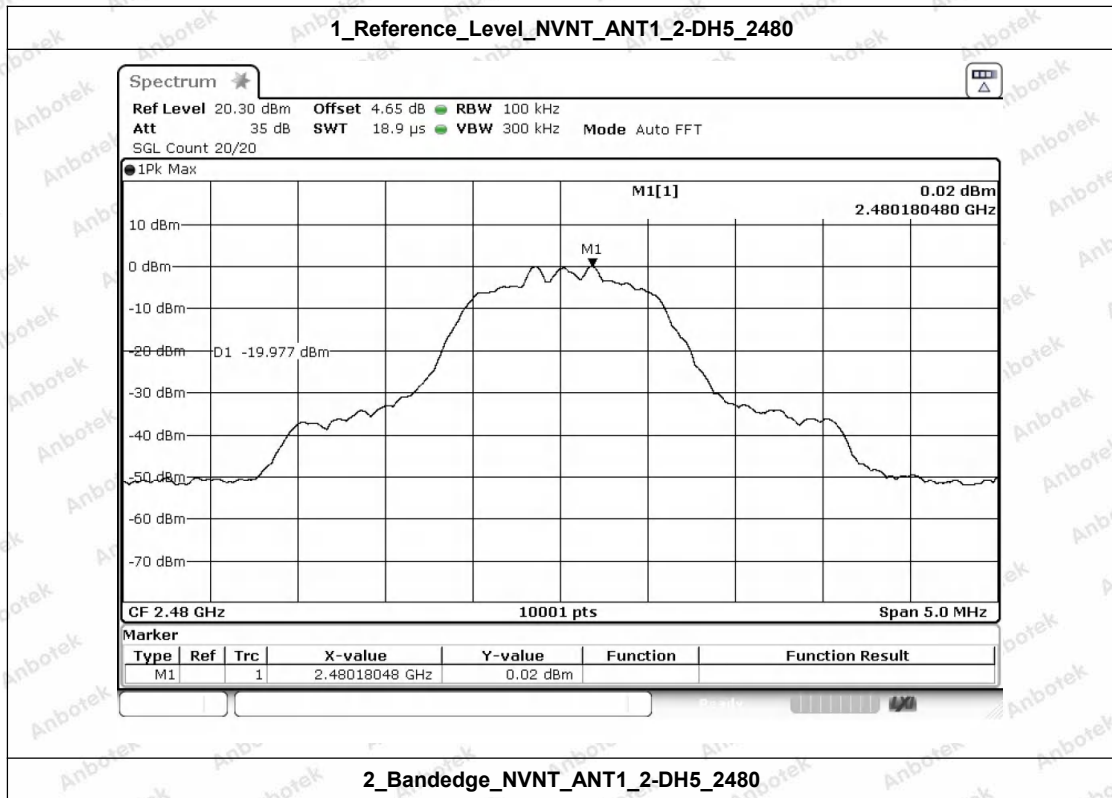

2_Bandedge_NVNT_ANT1_2-DH5_2480



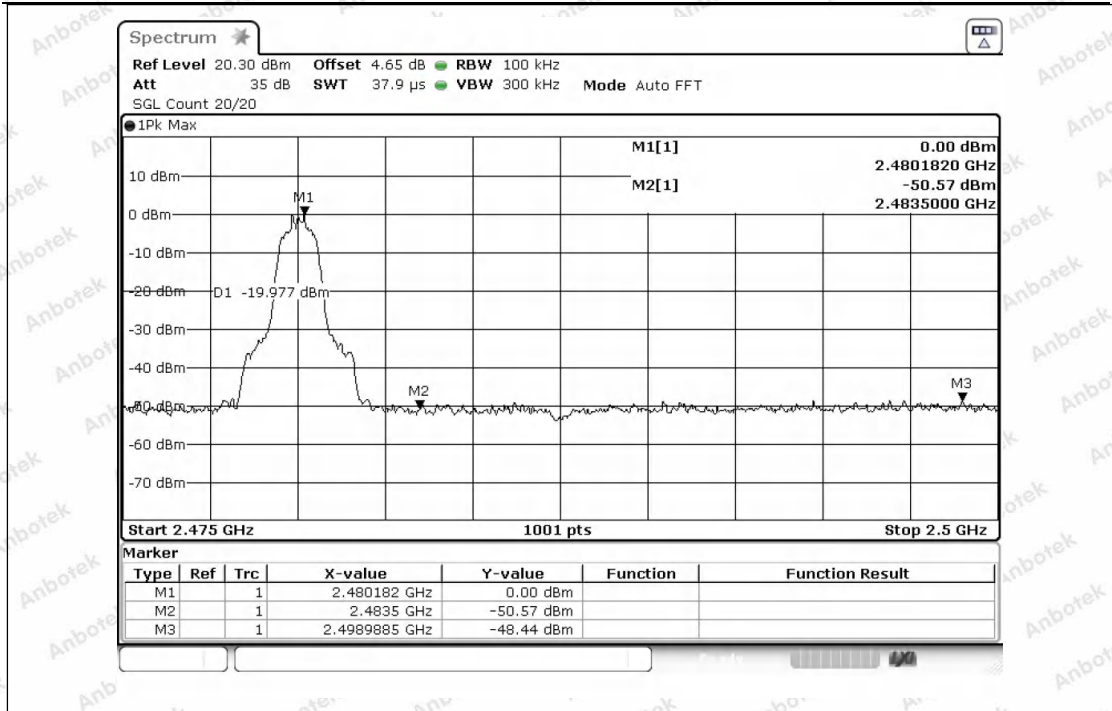

1_Reference_Level_Hopping_NVNT_ANT1_2-DH5_Hopping

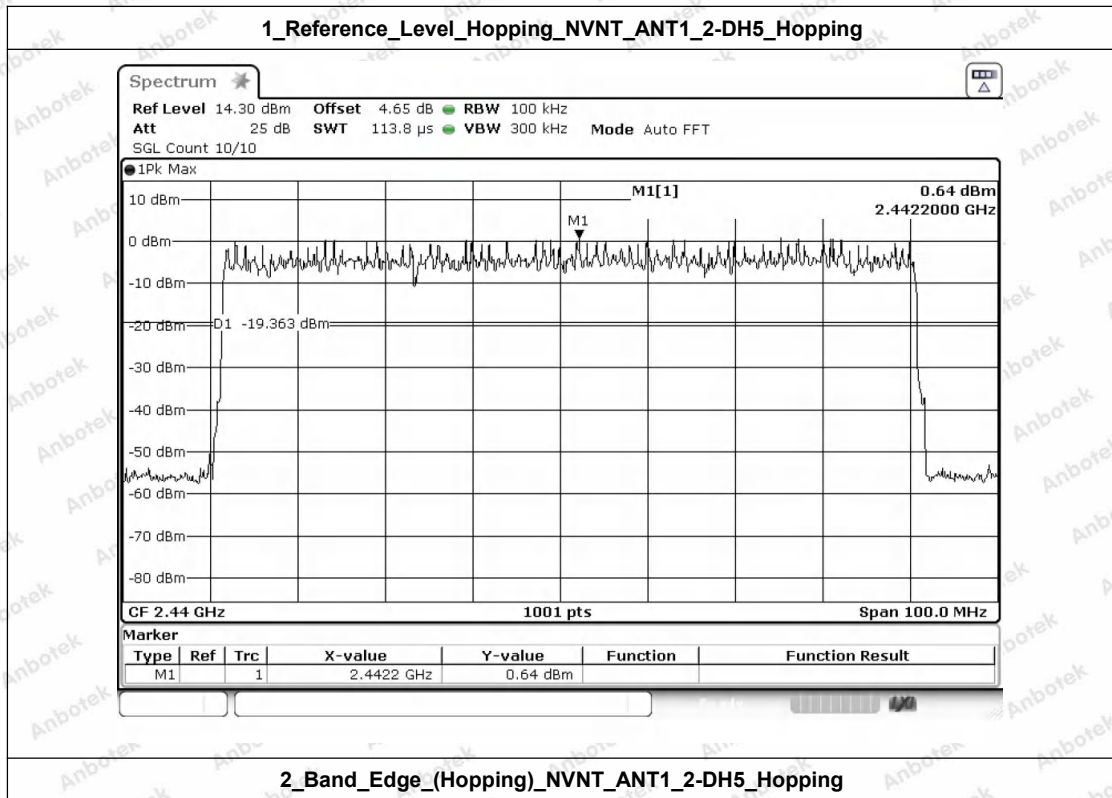

2_Band_Edge_(Hopping)_NVNT_ANT1_2-DH5_Hopping

Shenzhen Anbotek Compliance Laboratory Limited

Address: 1/F., Building D, Sogood Science and Technology Park, Sanwei Community, Hangcheng Street, Bao'an District, Shenzhen, Guangdong, China.
 Tel: (86) 0755-26066440 Fax: (86) 0755-26014772 Email: service@anbotek.com

Hotline
 400-003-0500
 www.anbotek.com.cn



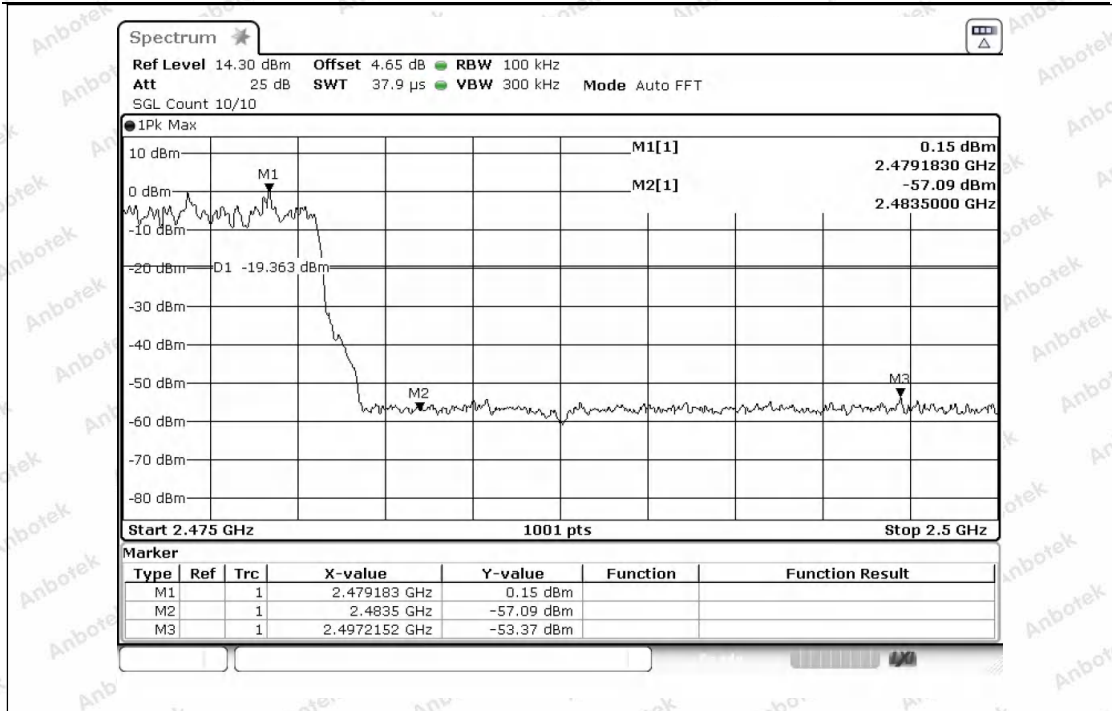

1_Reference_Level_NVNT_ANT1_3-DH5_2402

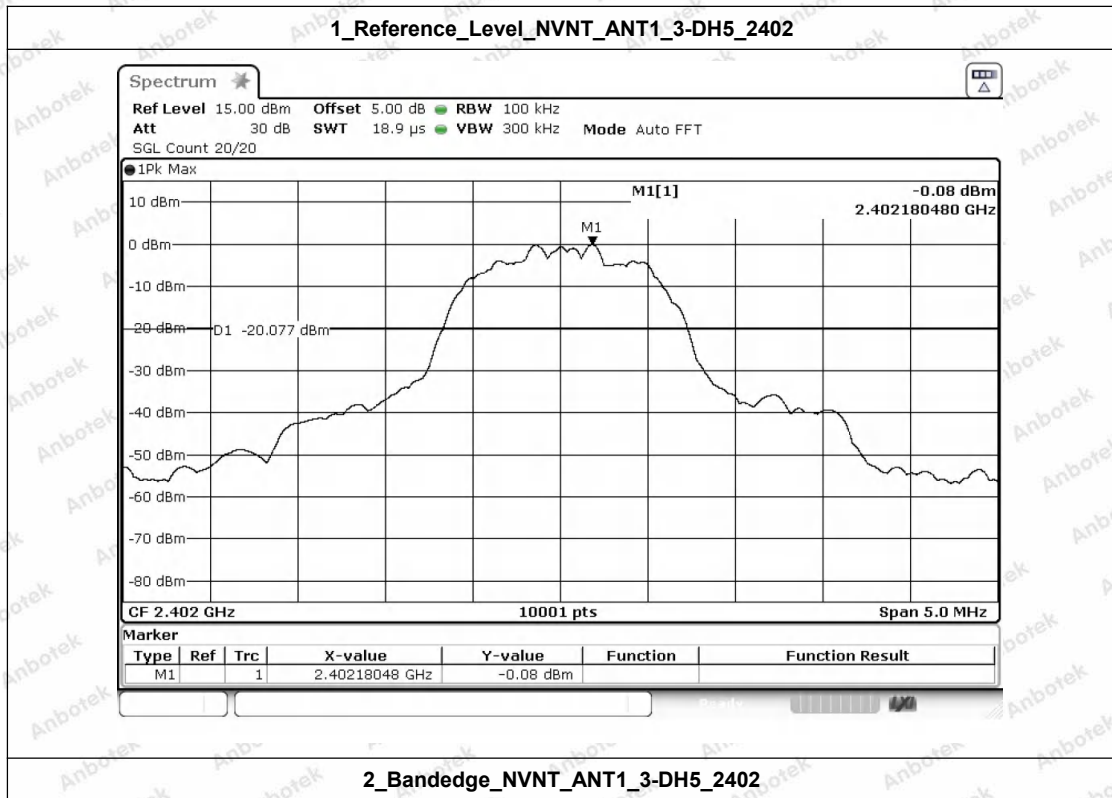

2_Bandedge_NVNT_ANT1_3-DH5_2402

Shenzhen Anbotek Compliance Laboratory Limited

Address: 1/F., Building D, Sogood Science and Technology Park, Sanwei Community, Hangcheng Street, Bao'an District, Shenzhen, Guangdong, China.
 Tel: (86) 0755-26066440 Fax: (86) 0755-26014772 Email: service@anbotek.com

Hotline 400-003-0500
 www.anbotek.com.cn



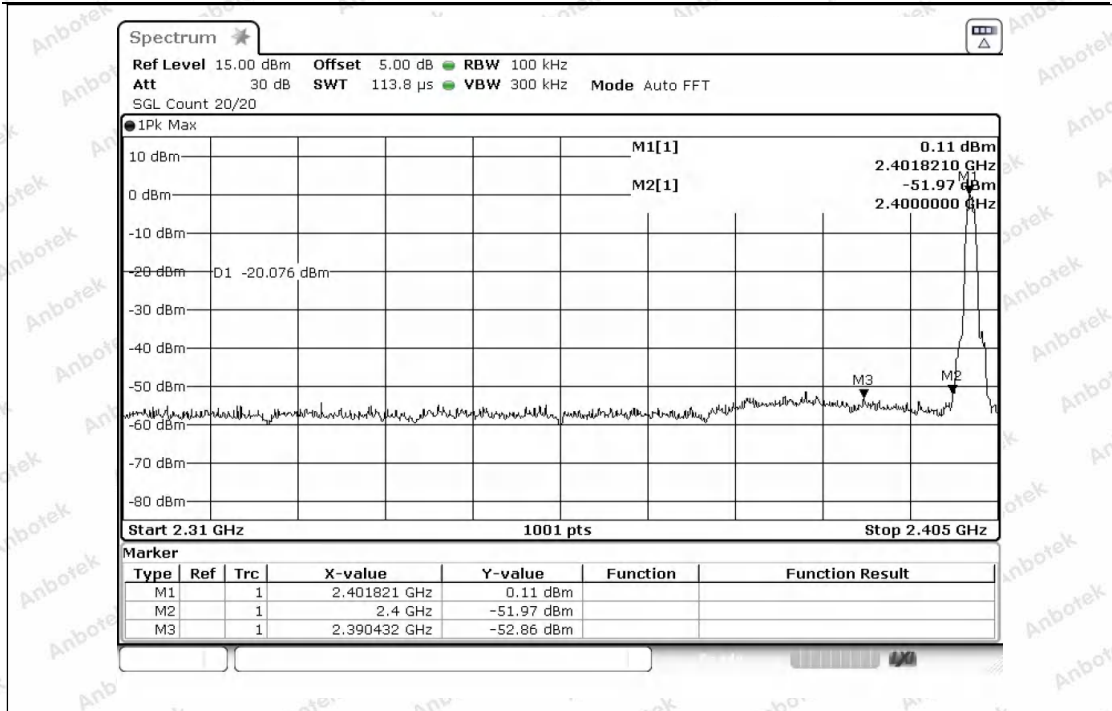

1_Reference_Level_Hopping_NVNT_ANT1_3-DH5_Hopping

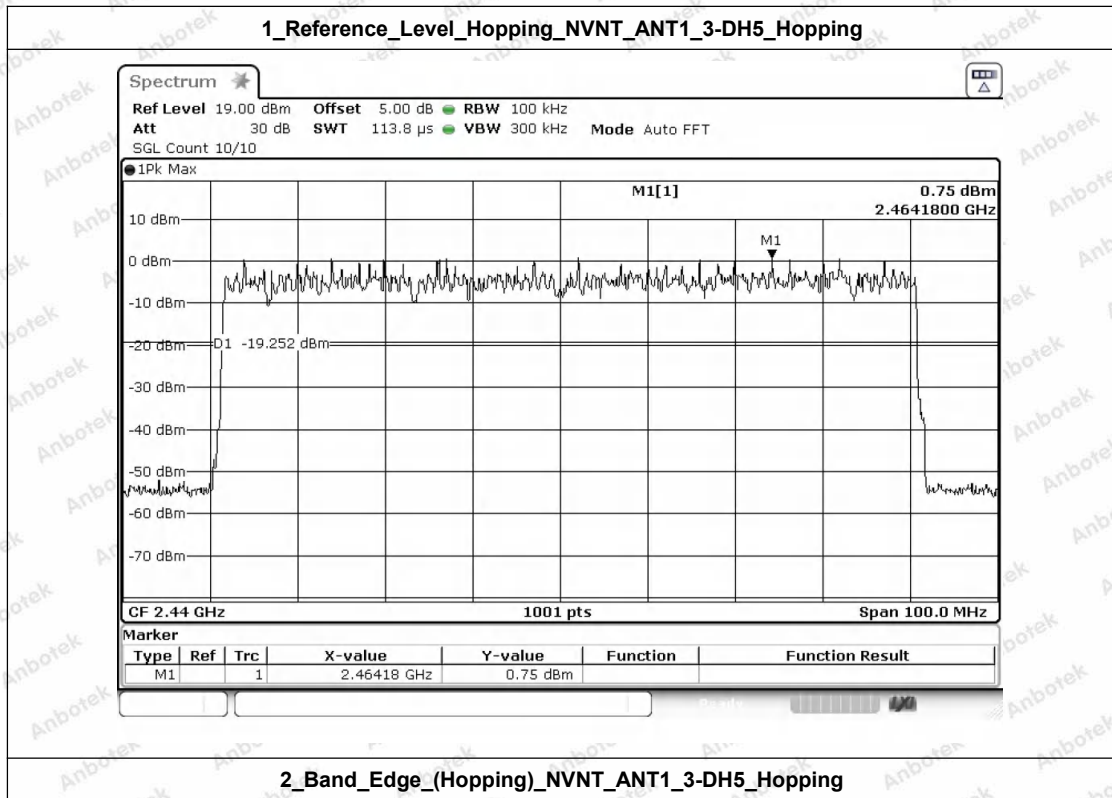

2_Band_Edge_(Hopping)_NVNT_ANT1_3-DH5_Hopping



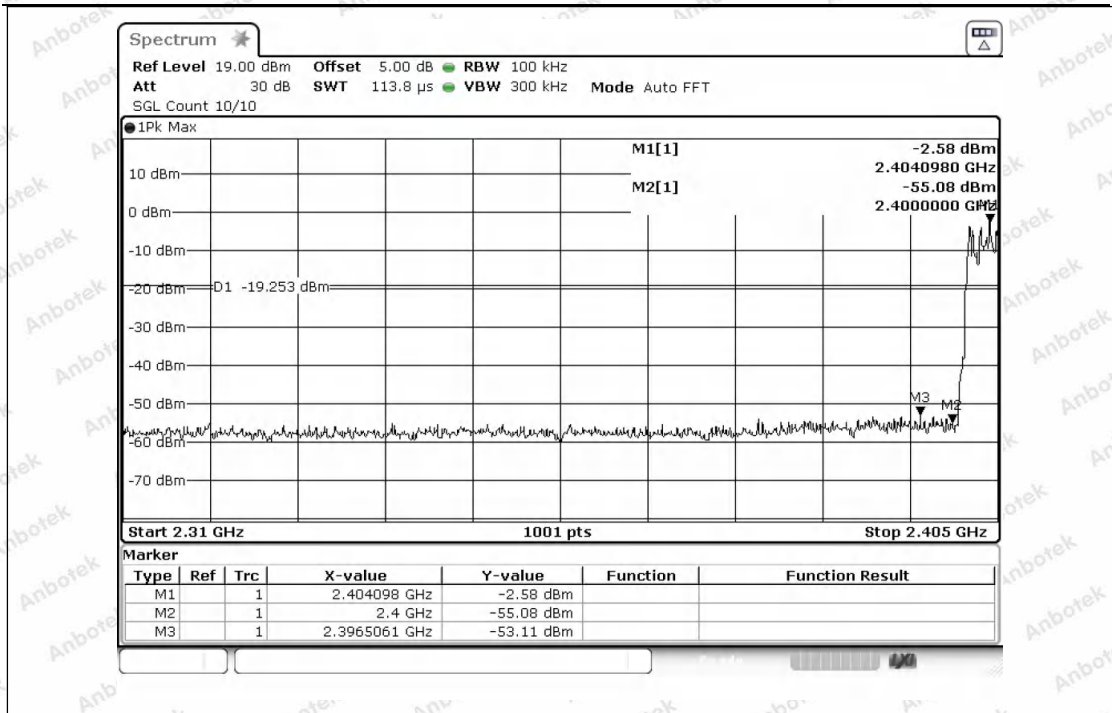

1_Reference_Level_NVNT_ANT1_3-DH5_2480

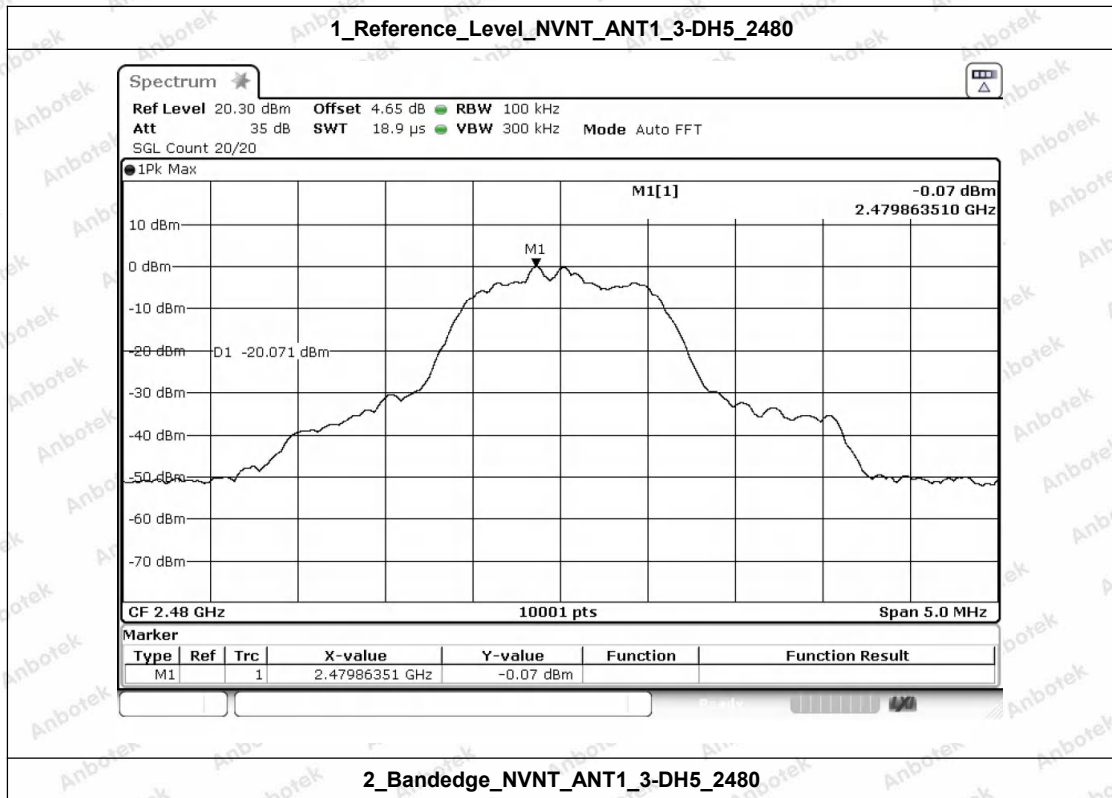

2_Bandedge_NVNT_ANT1_3-DH5_2480



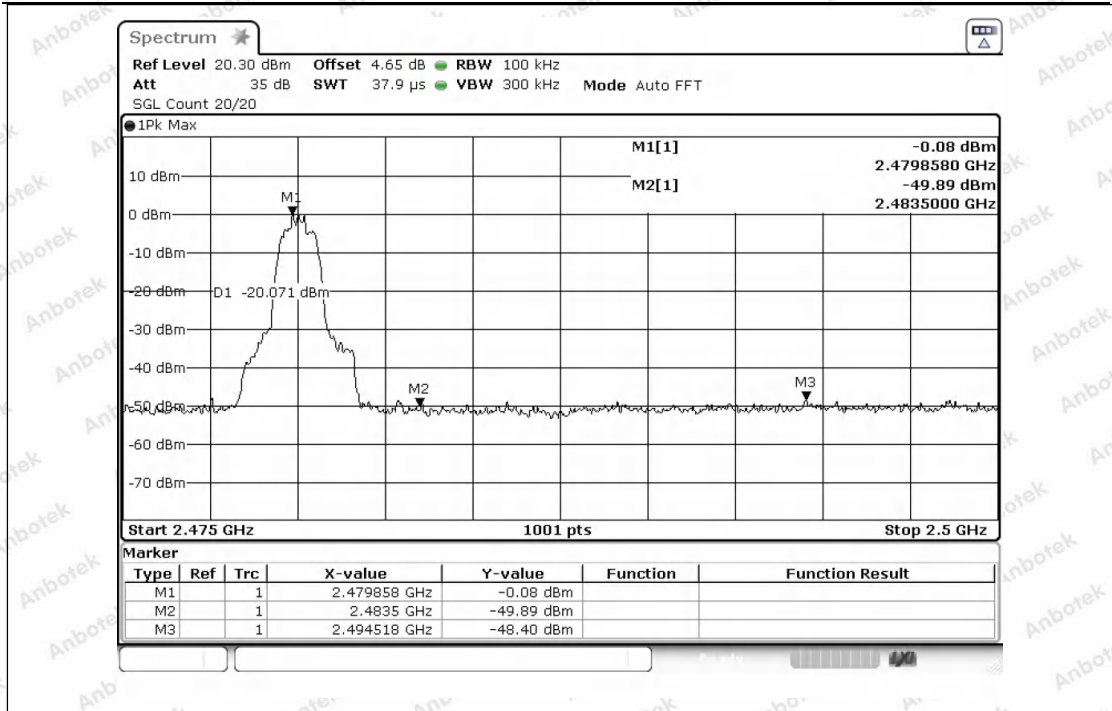

1_Reference_Level_Hopping_NVNT_ANT1_3-DH5_Hopping

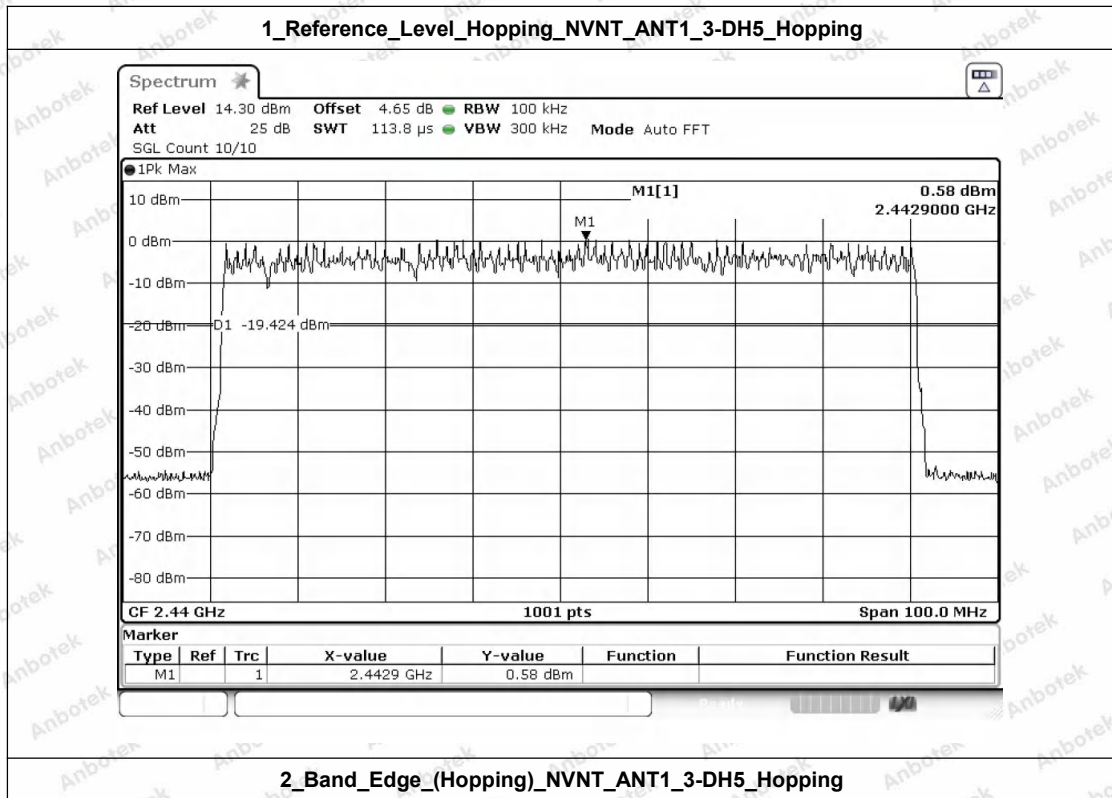

2_Band_Edge_(Hopping)_NVNT_ANT1_3-DH5_Hopping

Shenzhen Anbotek Compliance Laboratory Limited

Address: 1/F., Building D, Sogood Science and Technology Park, Sanwei Community, Hangcheng Street, Bao'an District, Shenzhen, Guangdong, China.
 Tel: (86) 0755-26066440 Fax: (86) 0755-26014772 Email: service@anbotek.com

Hotline 400-003-0500
 www.anbotek.com.cn



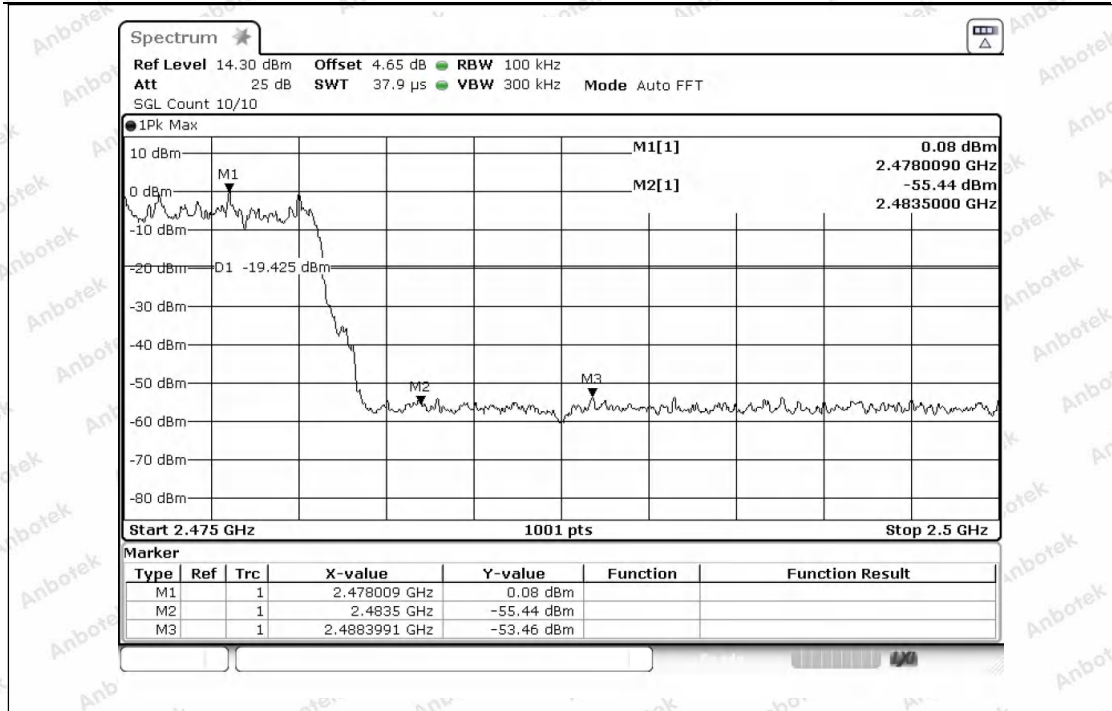

Shenzhen Anbotek Compliance Laboratory Limited

Address: 1/F., Building D, Sogood Science and Technology Park, Sanwei Community, Hangcheng Street, Bao'an District, Shenzhen, Guangdong, China.
 Tel: (86) 0755-26066440 Fax: (86) 0755-26014772 Email: service@anbotek.com

Hotline
 400-003-0500
 www.anbotek.com.cn



Appendix F: Carrier Frequencies Separation (Hopping)

| Condition | Antenna | Modulation | Frequency(MHz) | Hopping NO.0 (MHz) | Hopping NO.1 (MHz) | Carrier Frequencies Separation(MHz) | Limit(MHz) | Result |
|-----------|---------|------------|----------------|--------------------|--------------------|-------------------------------------|------------|--------|
| NVNT | ANT1 | 1-DH5 | 2441.00 | 2440.880 | 2442.177 | 1.30 | 0.687 | Pass |
| NVNT | ANT1 | 2-DH5 | 2441.00 | 2441.018 | 2442.186 | 1.17 | 0.885 | Pass |
| NVNT | ANT1 | 3-DH5 | 2441.00 | 2440.844 | 2441.944 | 1.10 | 0.859 | Pass |

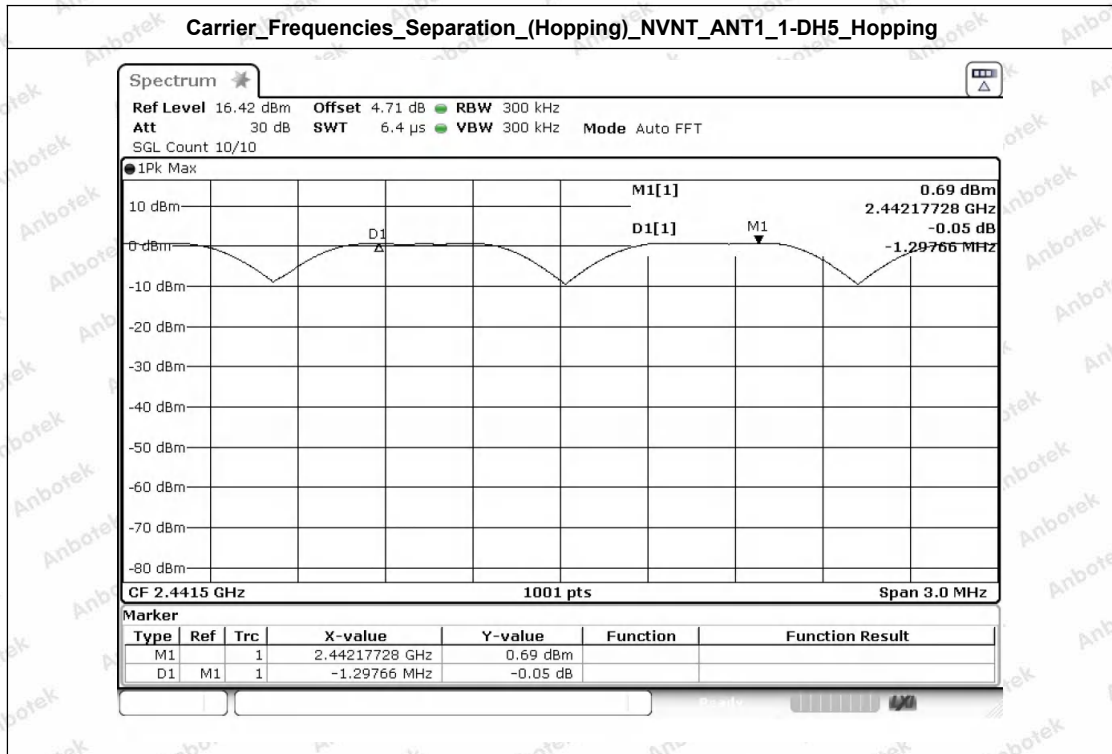

Carrier_Frequencies_Separation_(Hopping)_NVNT_ANT1_2-DH5_Hopping



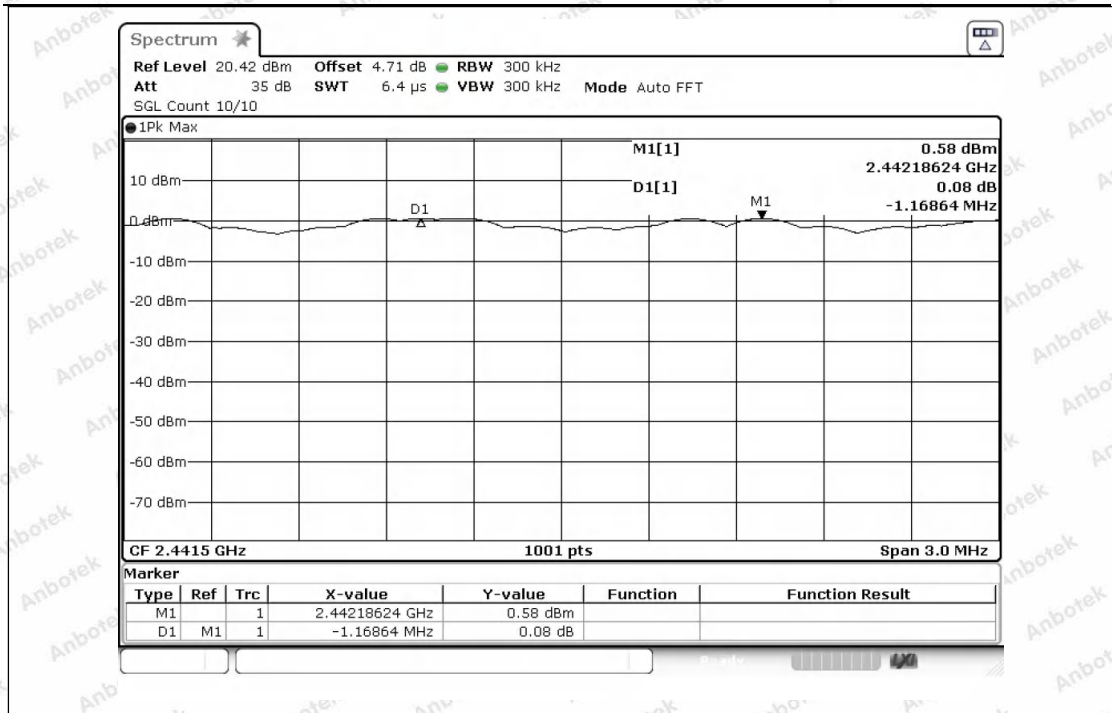

Carrier_Frequencies_Separation_(Hopping)_NVNT_ANT1_3-DH5_Hopping

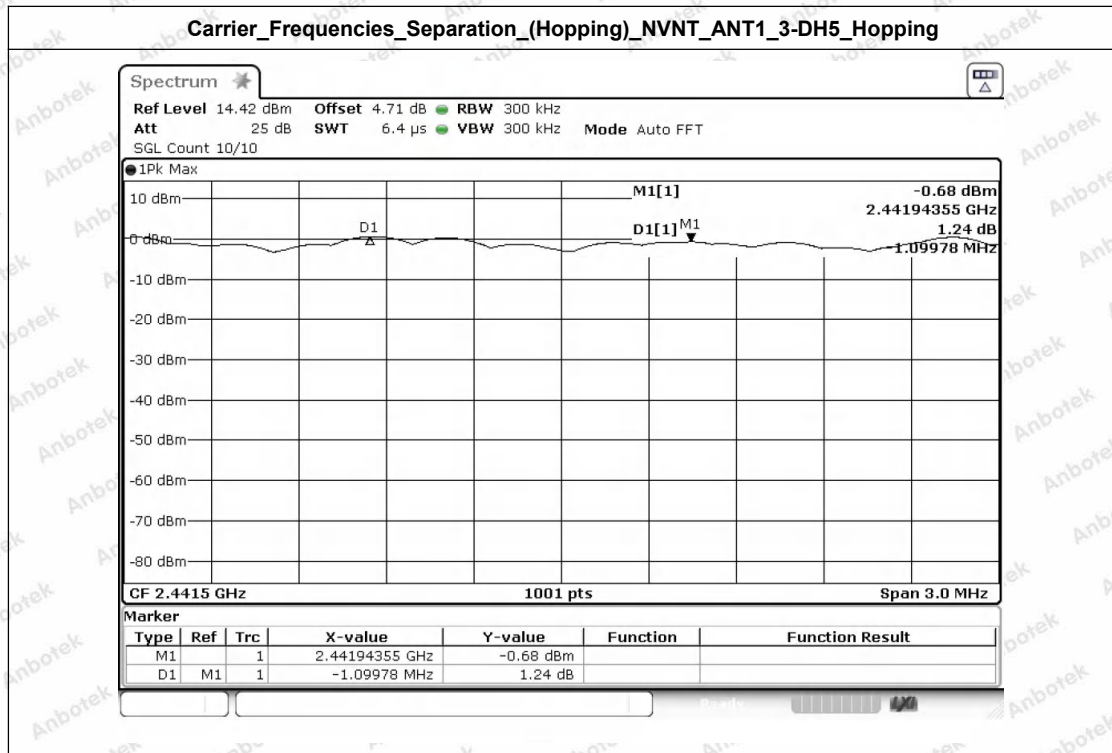

Shenzhen Anbotek Compliance Laboratory Limited

Address: 1/F., Building D, Sogood Science and Technology Park, Sanwei Community, Hangcheng Street, Bao'an District, Shenzhen, Guangdong, China.
 Tel: (86) 0755-26066440 Fax: (86) 0755-26014772 Email: service@anbotek.com

Hotline
 400-003-0500
www.anbotek.com.cn



Appendix G: Number of Hopping Channel (Hopping)

| Condition | Antenna | Modulation | Hopping Num | Limit | Result |
|-----------|---------|------------|-------------|-------|--------|
| NVNT | ANT1 | 1-DH5 | 79 | 15 | Pass |
| NVNT | ANT1 | 2-DH5 | 79 | 15 | Pass |
| NVNT | ANT1 | 3-DH5 | 79 | 15 | Pass |

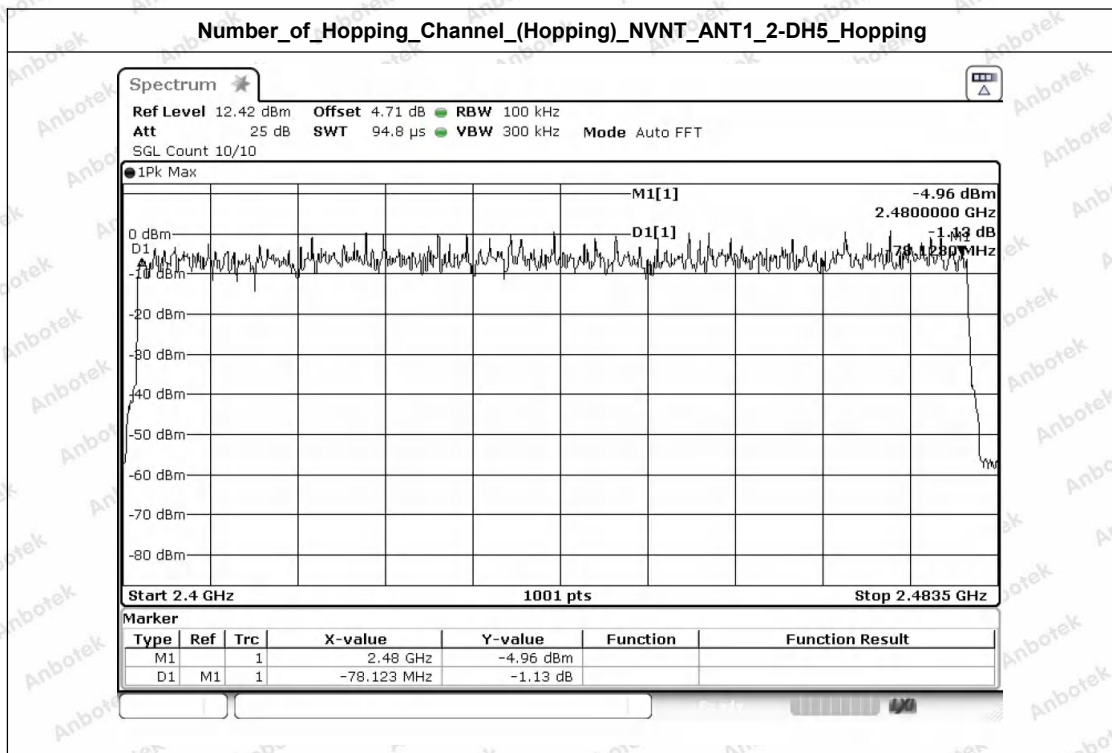
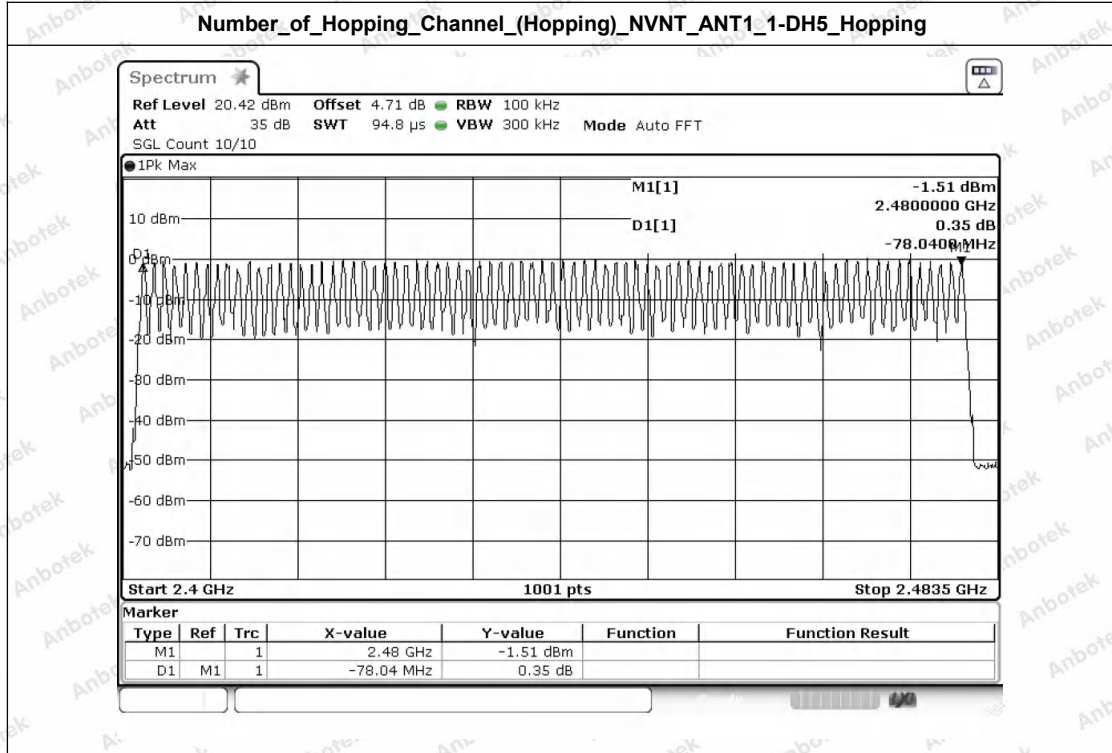

Shenzhen Anbotek Compliance Laboratory Limited

Address: 1/F., Building D, Sogood Science and Technology Park, Sanwei Community, Hangcheng Street, Bao'an District, Shenzhen, Guangdong, China.
 Tel: (86) 0755-26066440 Fax: (86) 0755-26014772 Email: service@anbotek.com

Hotline
 400-003-0500
 www.anbotek.com.cn



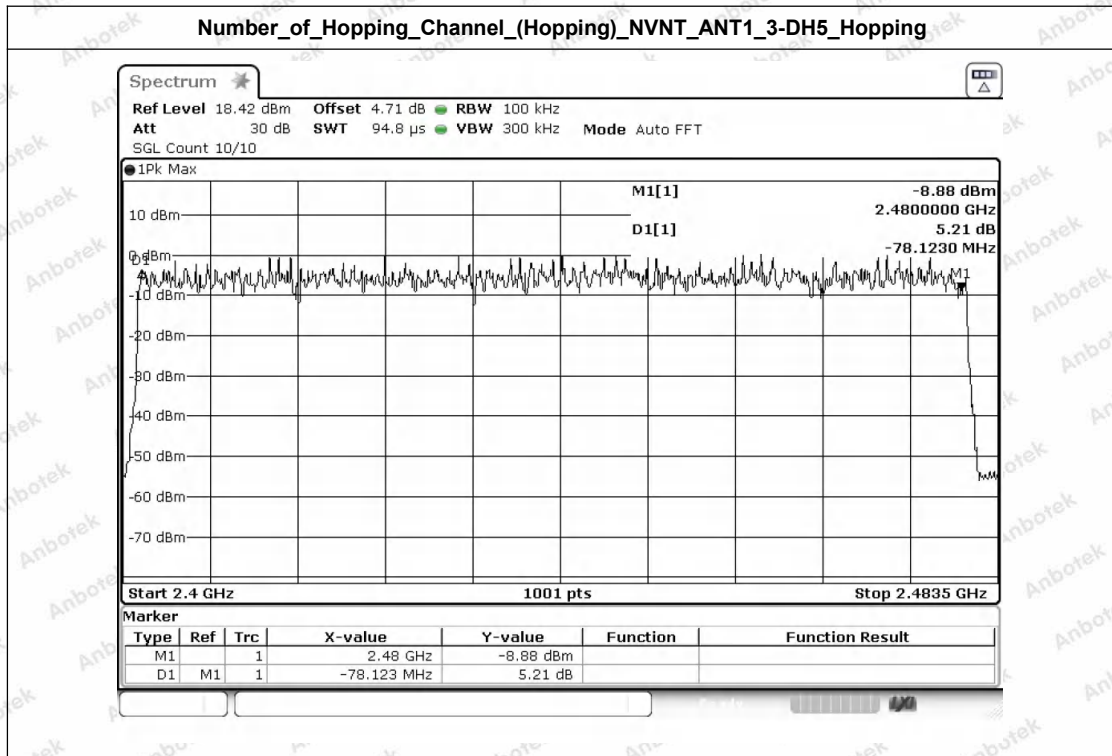

Shenzhen Anbotek Compliance Laboratory Limited

Address: 1/F., Building D, Sogood Science and Technology Park, Sanwei Community, Hangcheng Street, Bao'an District, Shenzhen, Guangdong, China.
 Tel: (86) 0755-26066440 Fax: (86) 0755-26014772 Email: service@anbotek.com



Hotline
 400-003-0500
www.anbotek.com.cn



Appendix H: Dwell Time (Hopping)

| Condition | Antenna | Packet Type | Pulse Time(ms) | Hops | Dwell Time(ms) | Limit(s) | Result |
|-----------|---------|-------------|----------------|--------|----------------|----------|--------|
| NVNT | ANT1 | 1-DH5 | 2.890 | 103.00 | 297.670 | 0.40 | Pass |
| NVNT | ANT1 | 2-DH5 | 2.900 | 102.00 | 295.800 | 0.40 | Pass |
| NVNT | ANT1 | 3-DH5 | 2.900 | 99.00 | 287.100 | 0.40 | Pass |
| NVNT | ANT1 | 1-DH1 | 0.380 | 319.00 | 121.220 | 0.40 | Pass |
| NVNT | ANT1 | 1-DH3 | 1.650 | 157.00 | 259.050 | 0.40 | Pass |
| NVNT | ANT1 | 2-DH1 | 0.390 | 319.00 | 124.410 | 0.40 | Pass |
| NVNT | ANT1 | 2-DH3 | 1.640 | 169.00 | 277.160 | 0.40 | Pass |
| NVNT | ANT1 | 3-DH1 | 0.400 | 317.00 | 126.800 | 0.40 | Pass |
| NVNT | ANT1 | 3-DH3 | 1.650 | 160.00 | 264.000 | 0.40 | Pass |

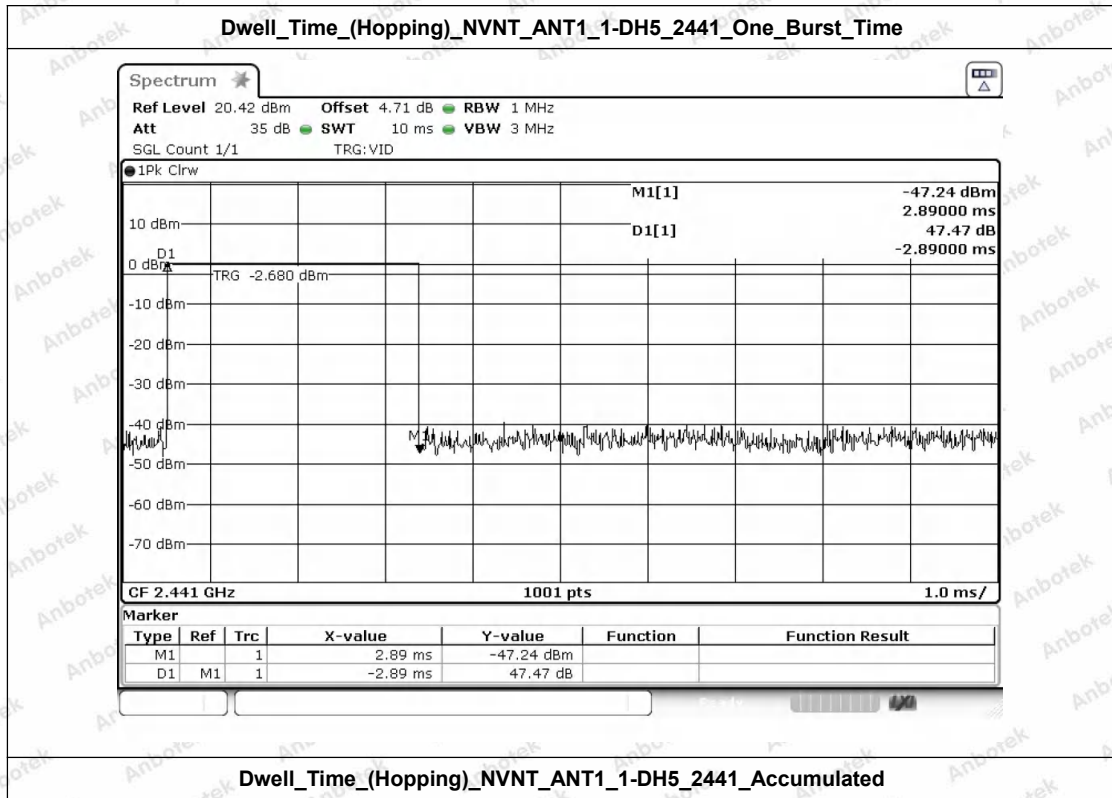

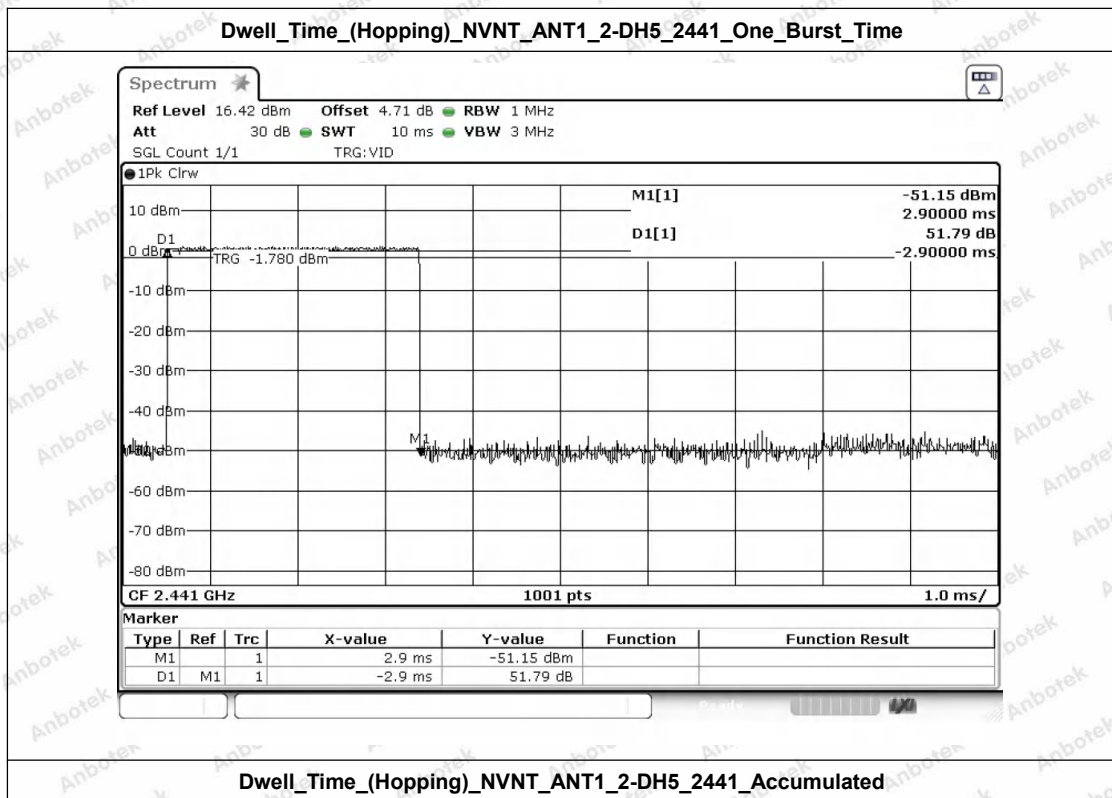
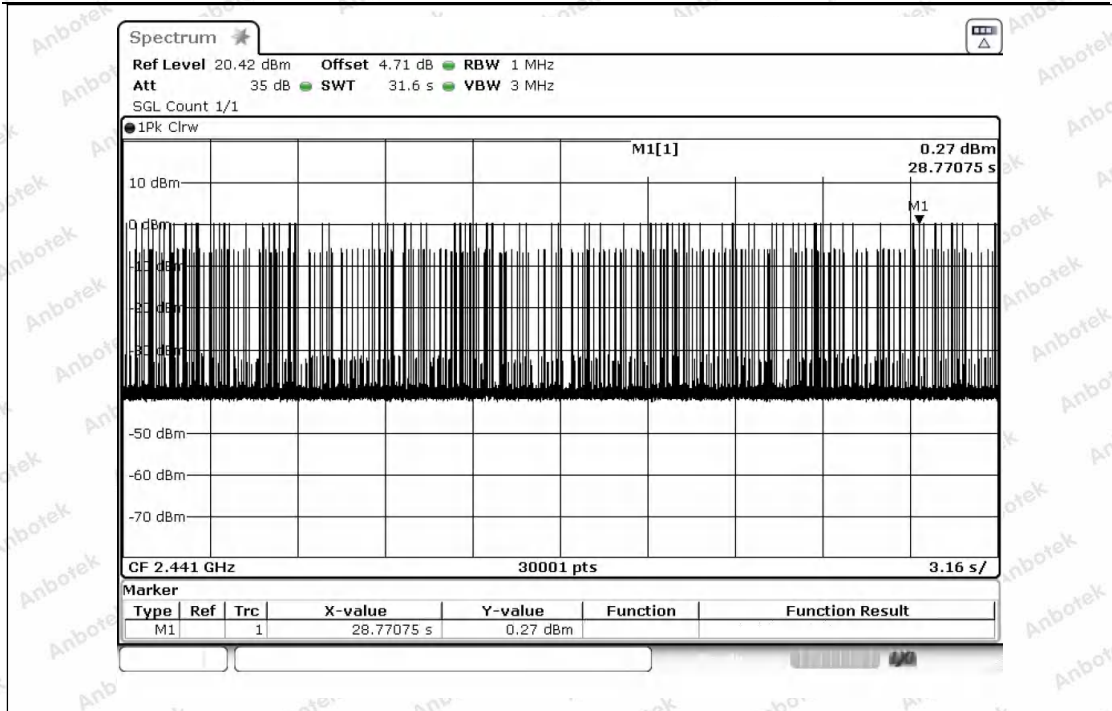

Dwell_Time_(Hopping)_NVNT_ANT1_2-DH5_2441_Accumulated



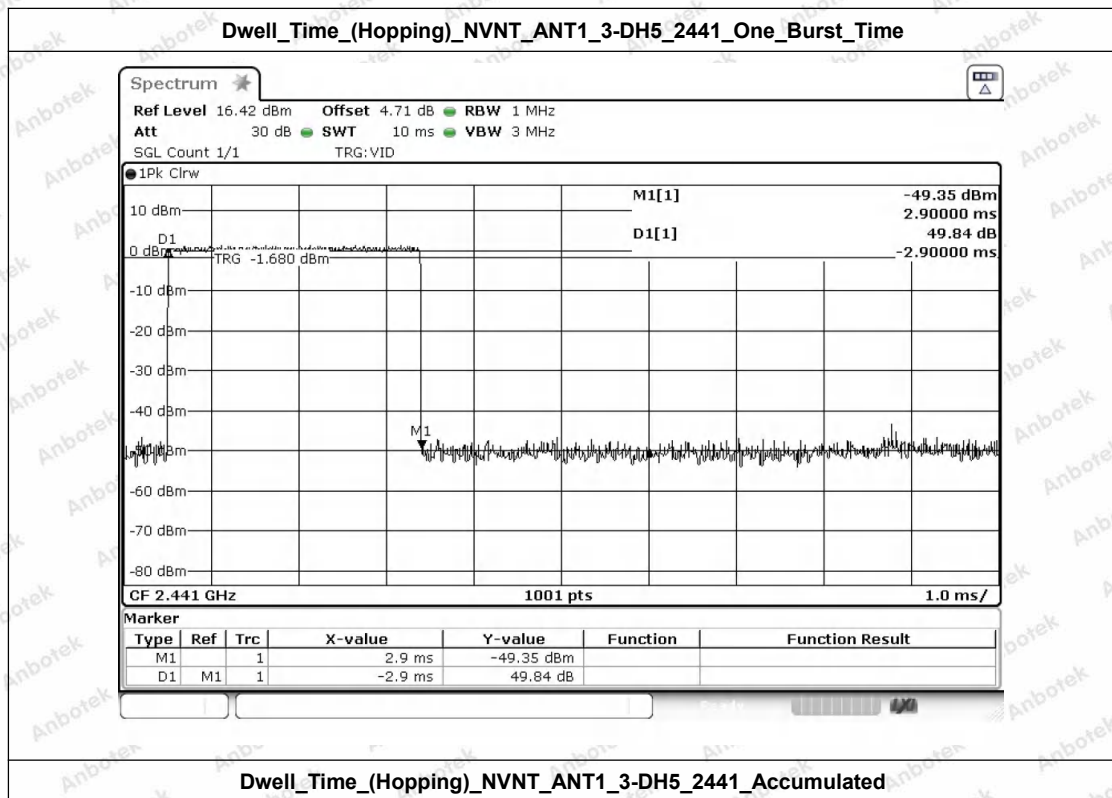
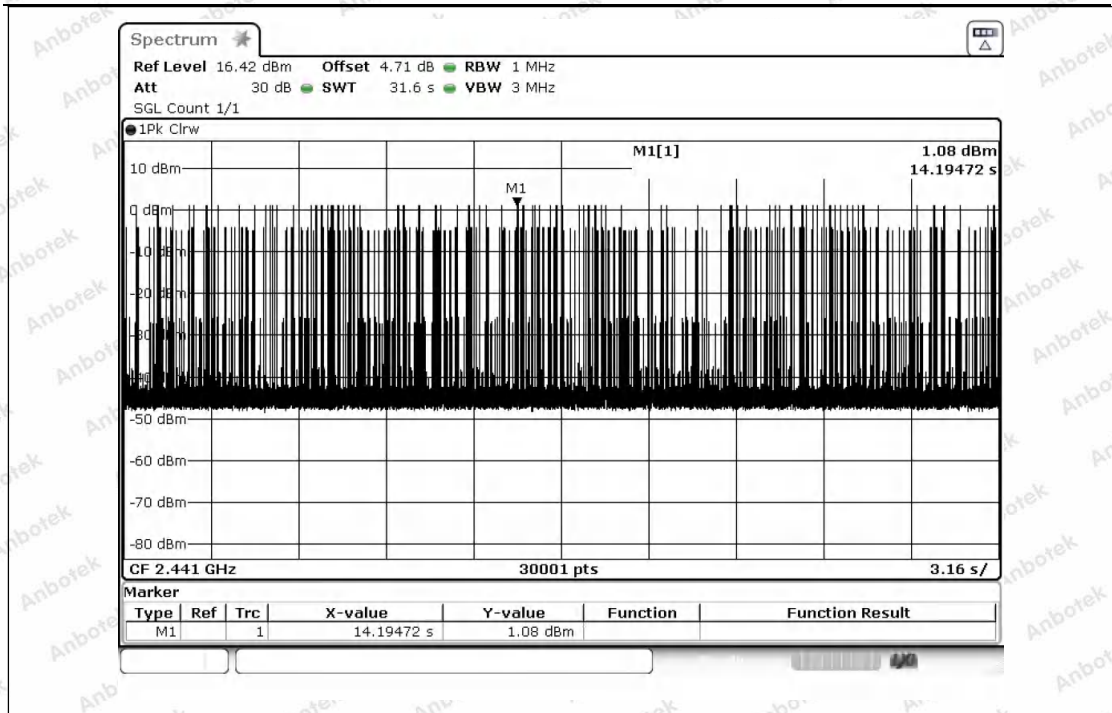

Dwell_Time_(Hopping)_NVNT_ANT1_3-DH5_2441_Accumulated



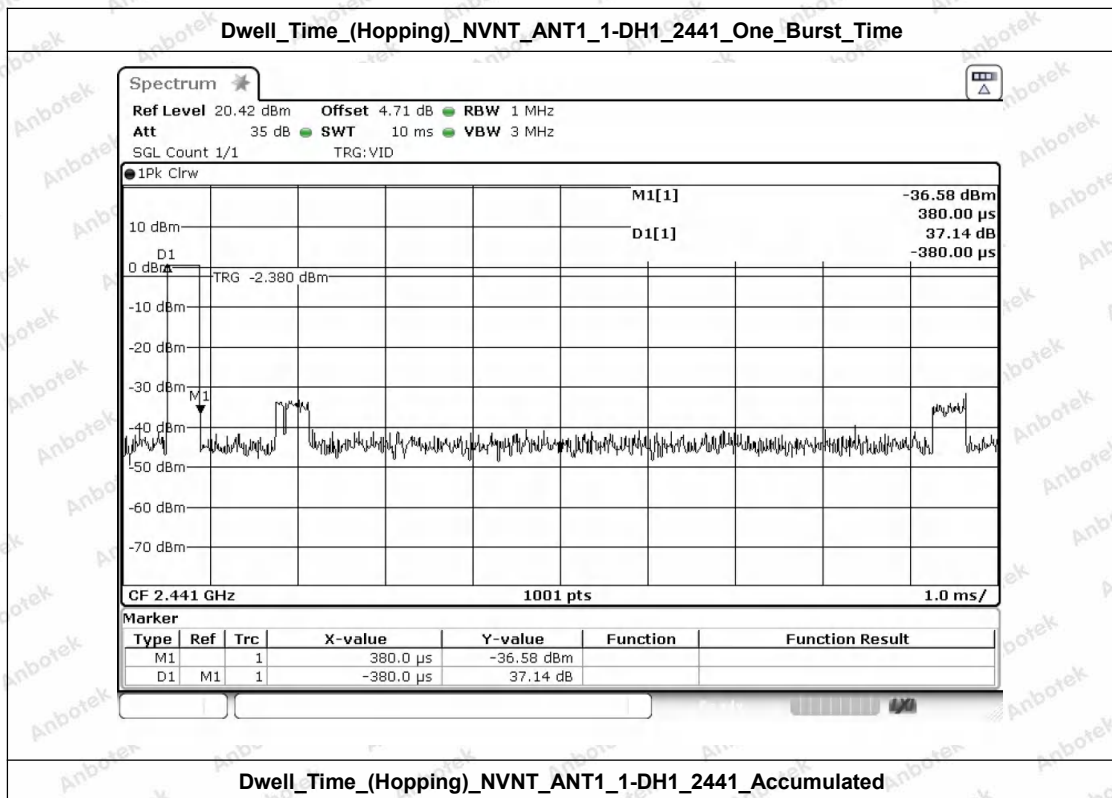
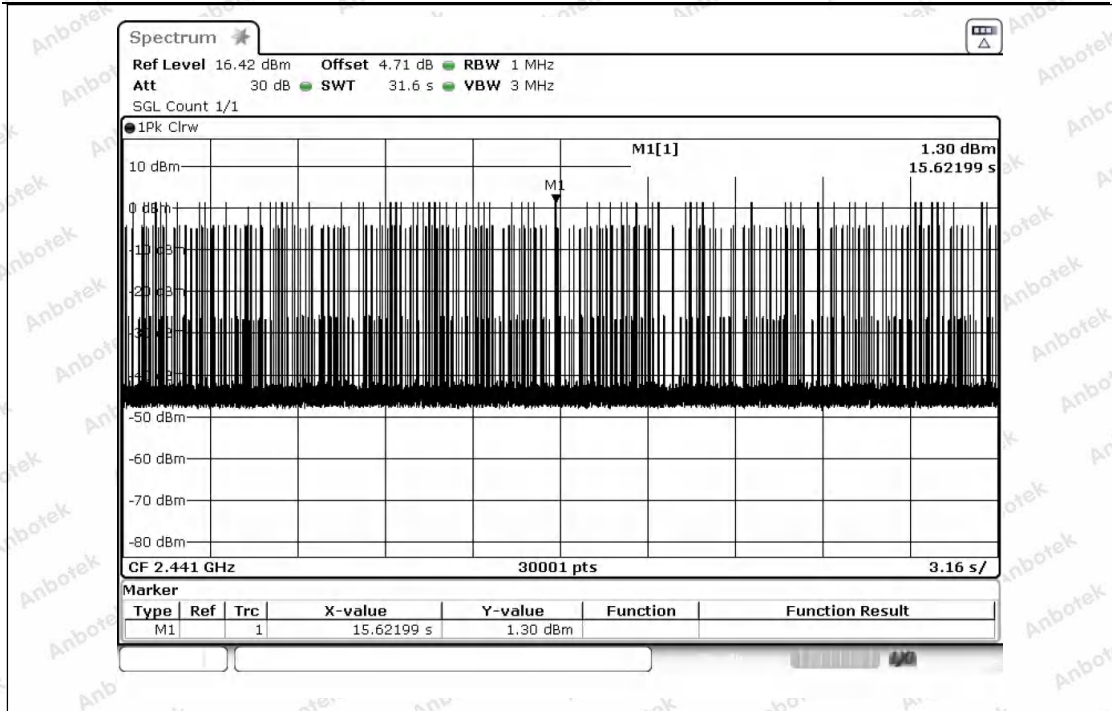

Dwell_Time_(Hopping)_NVNT_ANT1_1-DH1_2441_Accumulated



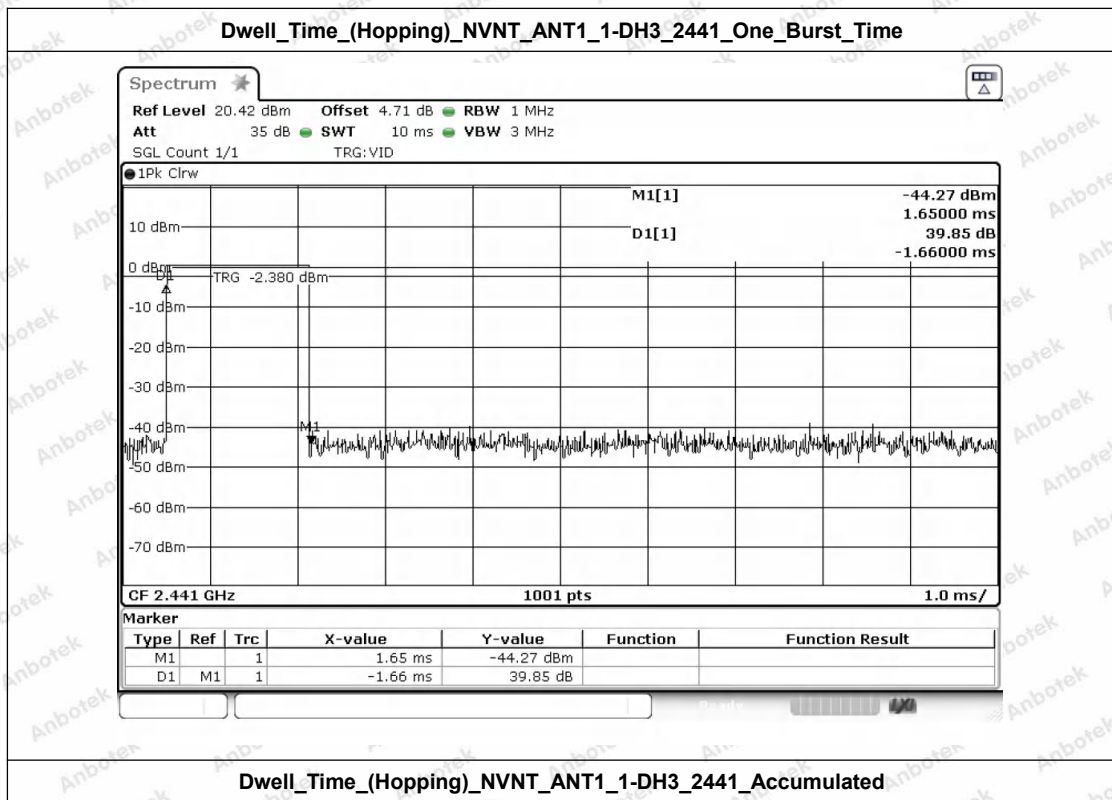
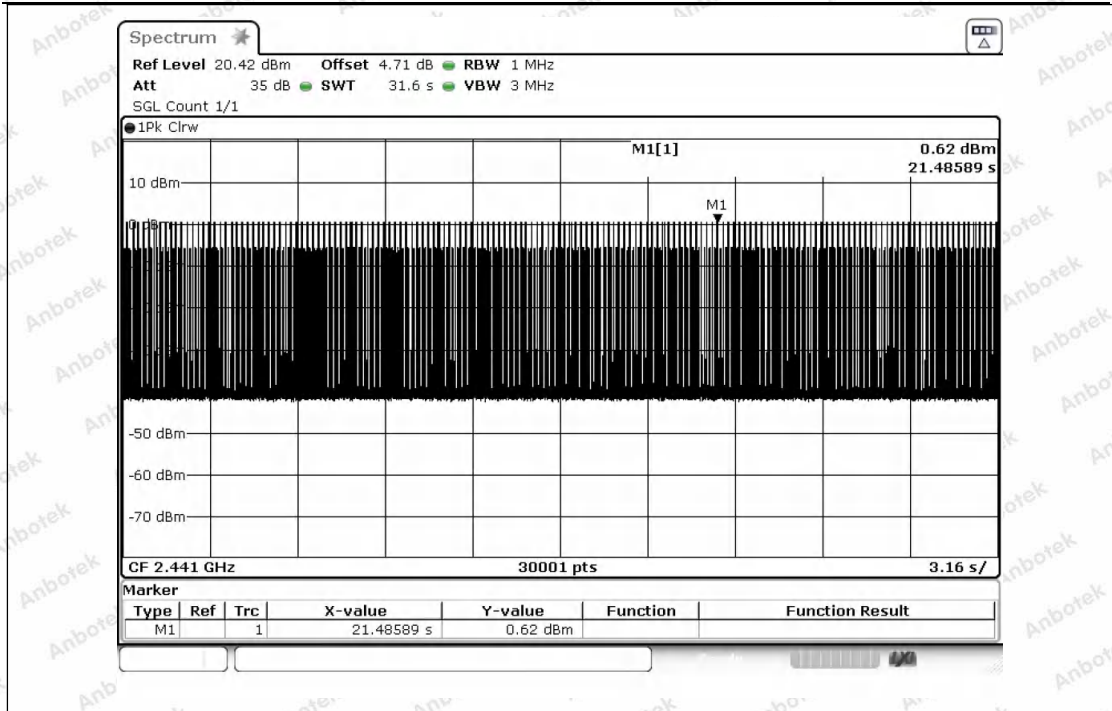

Dwell_Time_(Hopping)_NVNT_ANT1_1-DH3_2441_Accumulated



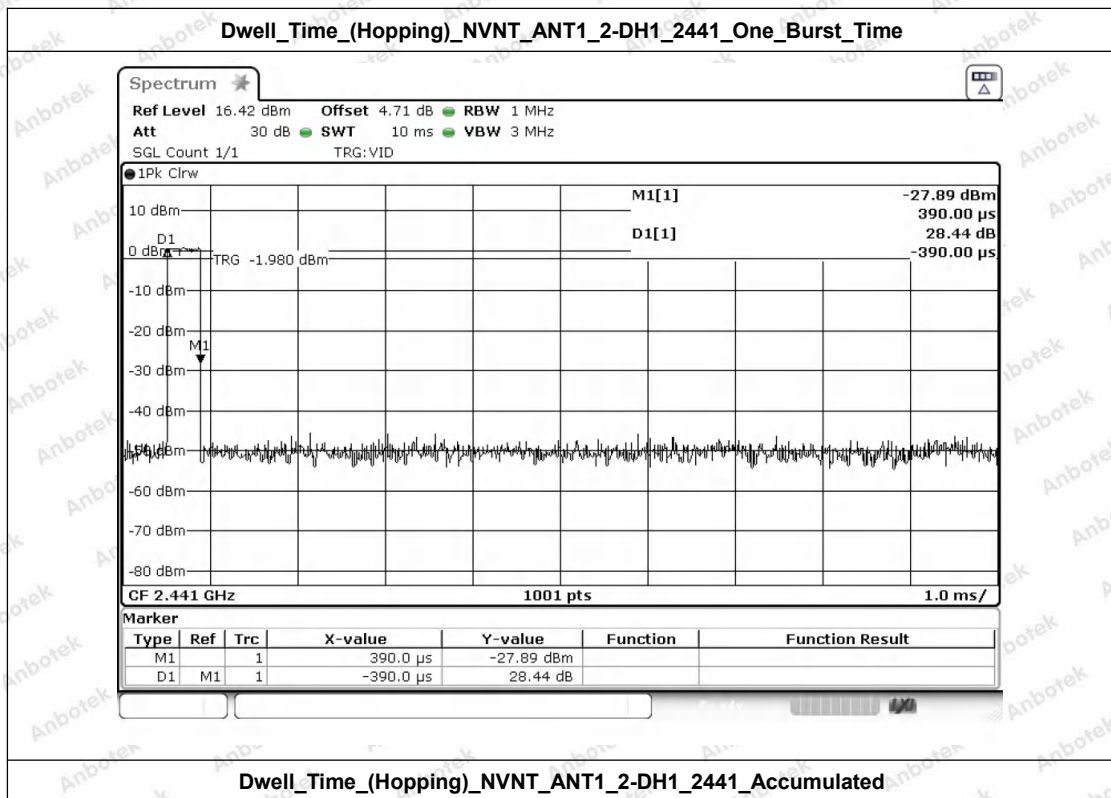
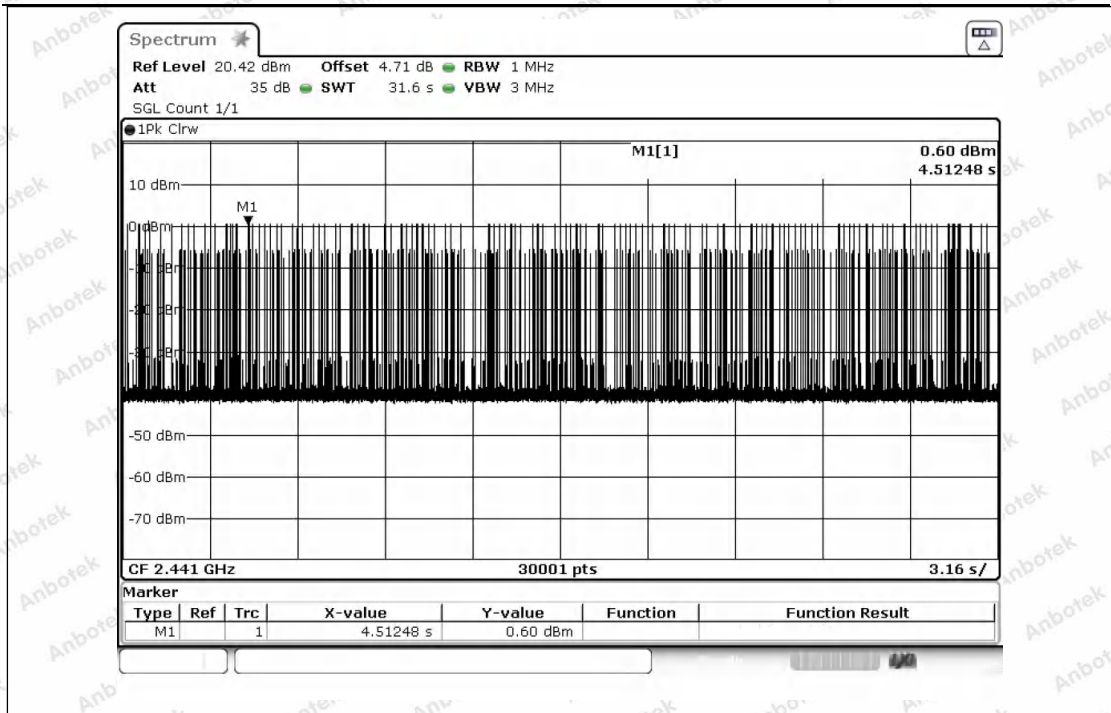

Dwell_Time_(Hopping)_NVNT_ANT1_2-DH1_2441_Accumulated



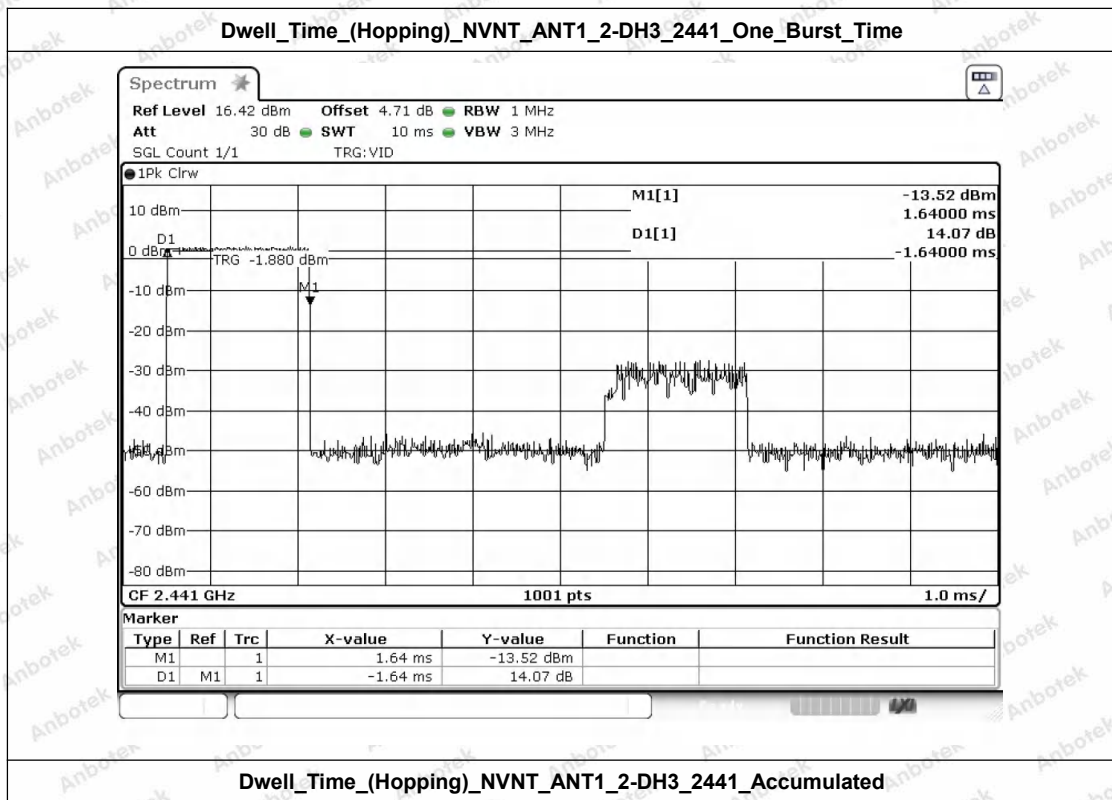
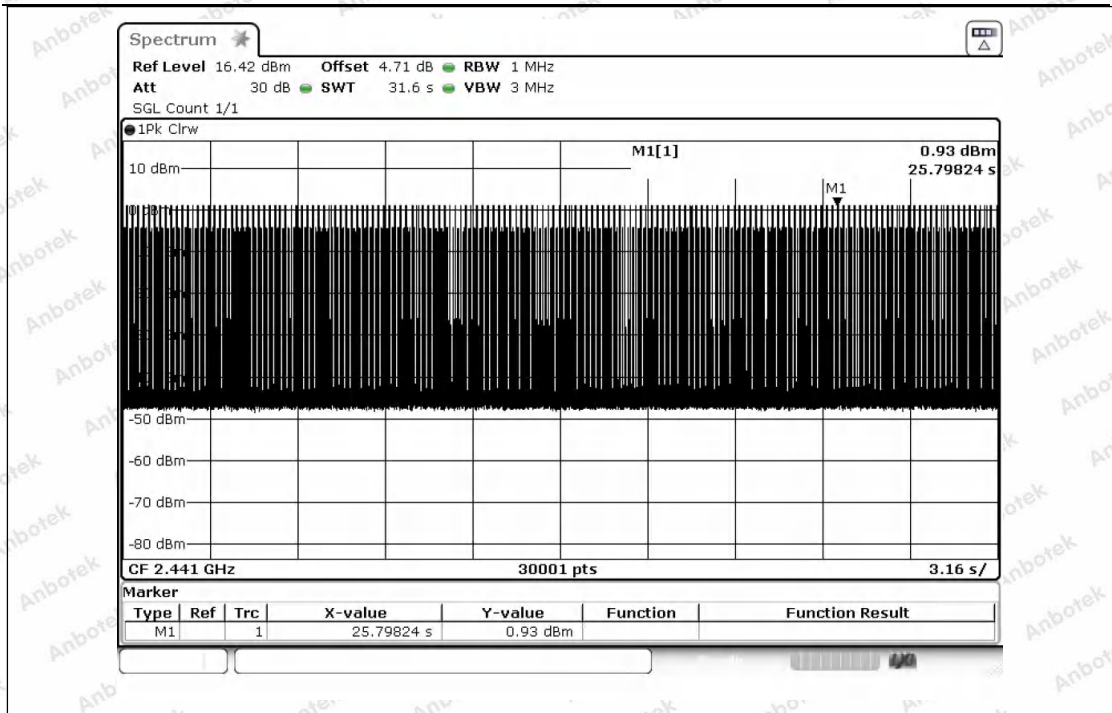

Dwell_Time_(Hopping)_NVNT_ANT1_2-DH3_2441_Accumulated

Shenzhen Anbotek Compliance Laboratory Limited

Address: 1/F., Building D, Sogood Science and Technology Park, Sanwei Community, Hangcheng Street, Bao'an District, Shenzhen, Guangdong, China.
 Tel: (86) 0755-26066440 Fax: (86) 0755-26014772 Email: service@anbotek.com

Hotline
 400-003-0500
 www.anbotek.com.cn



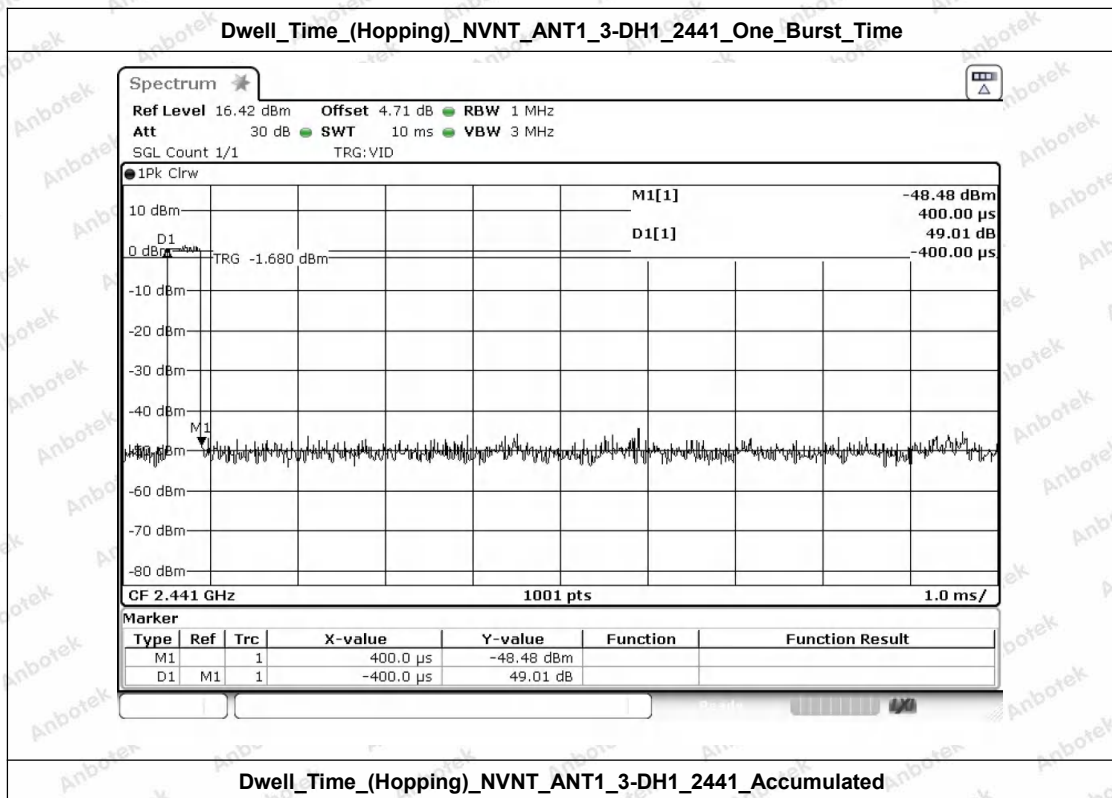
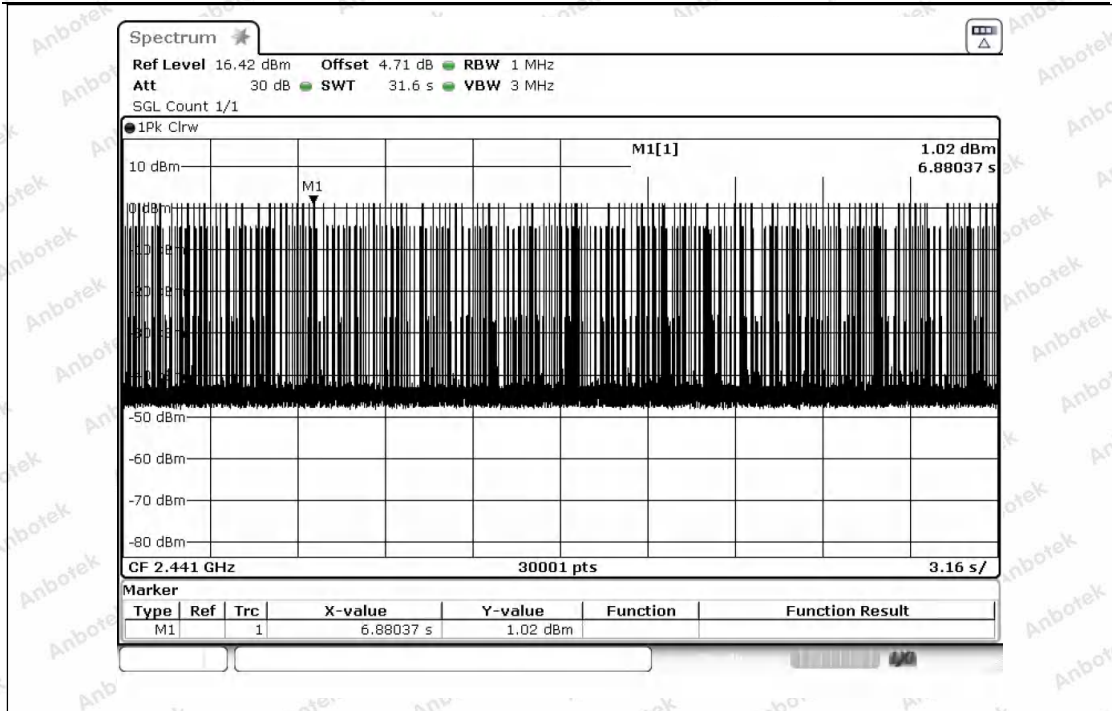

Shenzhen Anbotek Compliance Laboratory Limited

Address: 1/F., Building D, Sogood Science and Technology Park, Sanwei Community, Hangcheng Street, Bao'an District, Shenzhen, Guangdong, China.
 Tel: (86) 0755-26066440 Fax: (86) 0755-26014772 Email: service@anbotek.com

Hotline
 400-003-0500
 www.anbotek.com.cn



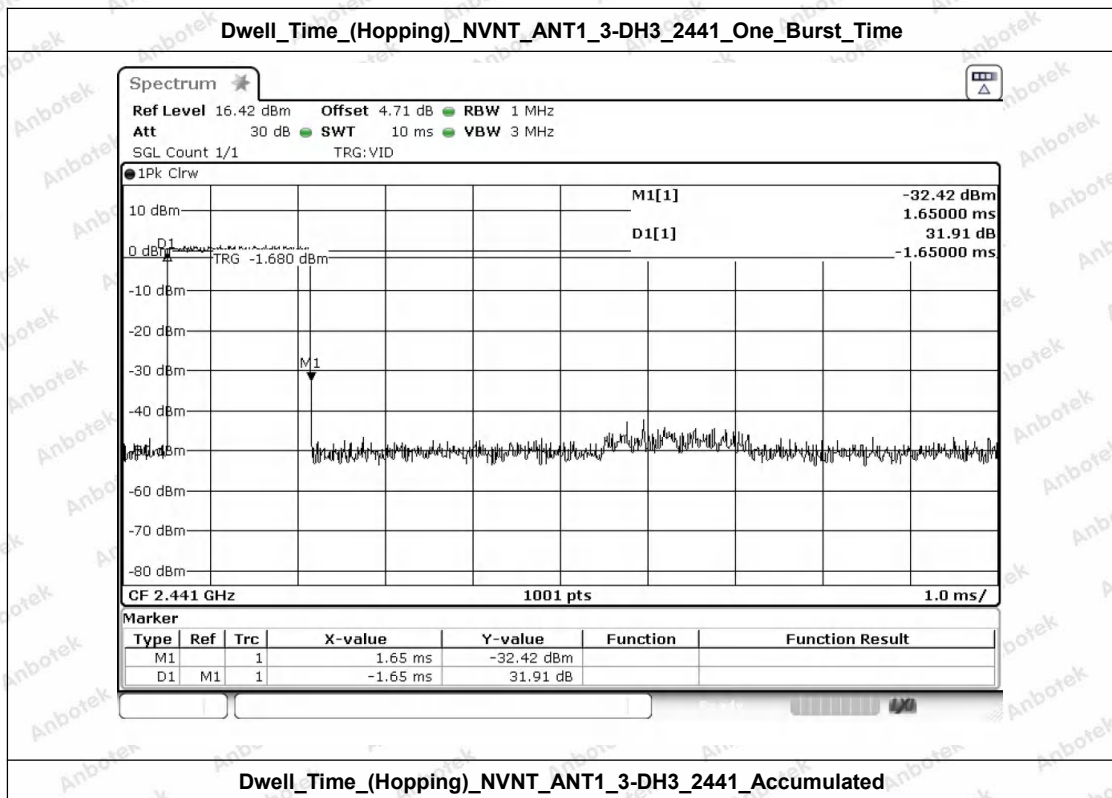
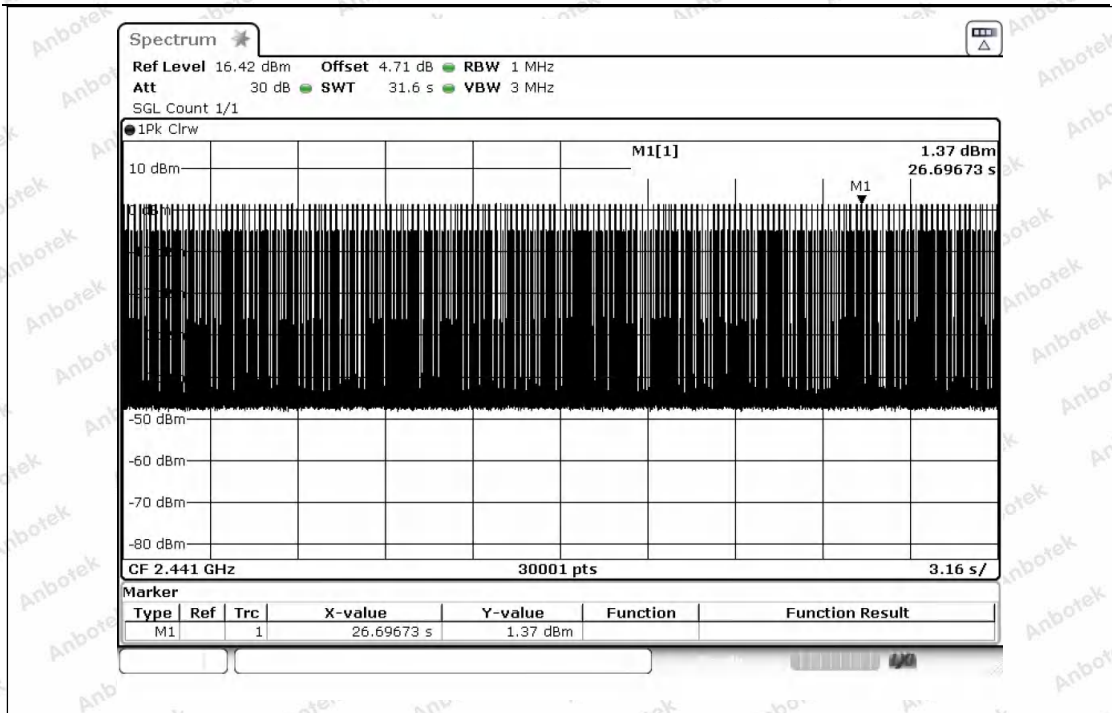

Dwell_Time_(Hopping)_NVNT_ANT1_3-DH3_2441_Accumulated



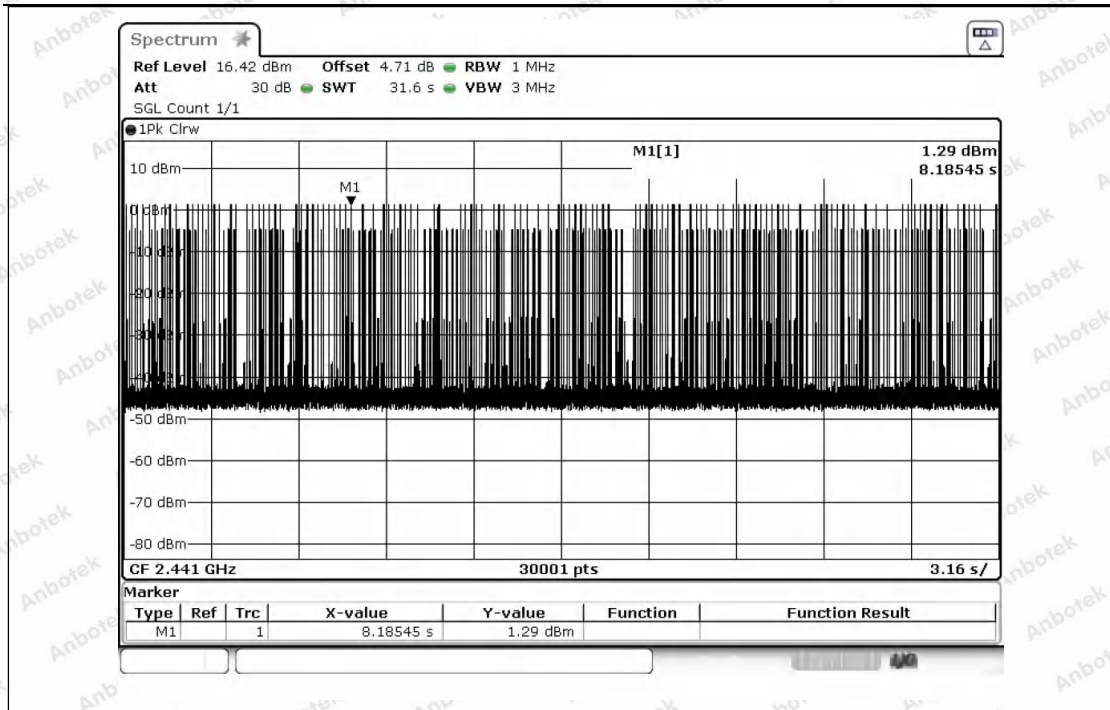

---End---

