

NOUHAUS MASSAGE CHAIR USER MANUAL

NM5
NM-SN500



Life Curation

NOUHAUS



Thank you for purchasing the NOUHAUS Massage Chair.
Please read this manual carefully before using.
Retain this manual for your reference.

This user manual contains the product warranty information.
This product is intended for a home-use only. It is not intended for commercial or industrial purposes. Do not use as such.
The design and/or specifications of this product are subject to change without notice.

NOUHAUS
LIFESTYLE
MASSAGE CHAIR
USER MANUAL

NM5
NM-SN500

CONTENTS

- 01** Safety Precautions
- 02** Components and Descriptions
- 03** Assembly Instructions
- 04** Instructions for Use
- 05** Cleaning and Storage
- 06** Troubleshooting
- 07** FAQ
- 08** Customer Service
- 09** Specification
- 10** Product Warranty
- 11** FCC Warning

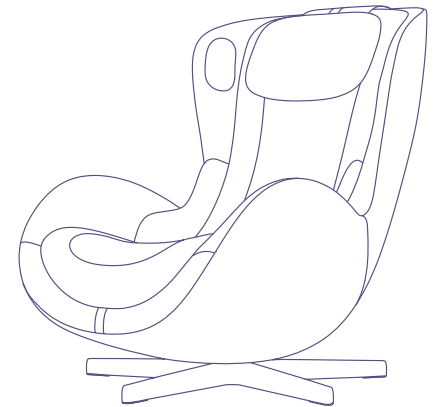

NM5
NM-SN500

The following safety precautions are intended to prevent unexpected danger or damage by ensuring safe and accurate use of the product.

When Installing

Remodeling, disassembly, or repairs should not be performed by anyone other than service personnel.

- Can cause fire or electric shock.

Use the product on a flat surface.

- Can cause product failure or an accident.

Regarding Power

If the product does not work or ceases to function, immediately disconnect the power plug from the outlet and contact the customer center for inspection and repair.

- There is a risk of fire or electrocution due to electric shock or short circuit.

If the cover of the product is torn or peeled off, it may cause a serious accident as clothes or hair can be caught inside. Ensure that there are no issues with the appearance of the product.

- It may cause electric shock or injury.

Instruct children not to touch the power plug.

- There is a risk of electric shock or injury.

Do not bend the power cord too hard and do not place heavy objects on it.

- There is a risk of fire and electric shock.

When using power strip, do not connect multiple devices at the same time.

- There is a risk of fire due to overheating of the outlet.

When unplugging the plug, pull it out of the outlet by grasping the plug.

- If the power cord is damaged, there is a risk of fire and electric shock.

Do not touch the power plug with wet hands, and when you clean or repair the product, disconnect the power plug from the outlet.

- There is a risk of electric shock.

Check the rated voltage of the product and use a grounded outlet.

- There is a risk of fire due to overheating of the outlet.

When using a power strip, use a grounding-type outlet.

- Using a non grounding-type outlet may cause electric shock or injury.

When there is a power outage, immediately turn off the power switch and unplug the power plug from the outlet.

- Can cause electric shock or fire.

While operating the product, avoid pinching the power cord or Remote control line between the center connection support or the five-foot support

- A short circuit may occur if the sheath is damaged, so care should be taken during operation.

When using the product

Due to the risk of safety accidents, refrain from using recliner chairs for those who fall under one of the following conditions:

The following persons should not use this product:

- Those who have been deemed by a medical professional as unable to use the product, e.g those having thrombosis, embolism, severe varicose veins, and/or acute varicose veins
- People with suspected acute cervical sprain (whiplash)
- People with symptoms of a sprain or sudden muscle contraction
- Pregnant women in early pregnancy or immediately after childbirth
- Those who have an abnormality in their spine due to an accident or disease in the past, or those with bent spine (scoliosis)
- Those who have an acute disease of the intestines or severe heart disorder
- Those who use an implantable electronic medical device such as implantable pacemakers
- Those who have a severe seizure symptom or psychogenic disorder (perceptual disorder)

- Those whose temperature sensation is lost due to severe peripheral circulation disorders such as diabetes, etc.
- Those who have a risk of osteomyelitis or rickets
*Rickets: Symptoms of shrinking muscles throughout the body and an inability to stretch arms and legs
- Those who are unable to move their body freely
- Those with or undergoing treatment for symptoms of disc disorders
- Those receiving treatment at a medical institution for any disorder in their body

The following persons must consult a doctor before use:

- Those who have a risk of side effects due to the use of the product, e.g. pregnant women
- Those whose body temperature is higher than normal due to acute inflammation, chills, etc.
- Those with symptoms of acute skin disease, malignant tumor, or other skin disease
- Those who are receiving medical treatment
- Those who feel any bodily abnormalities
- Those who have been instructed by doctor not to undergo massage
- Those whose muscles have weakened or become lean due to old age
- Those who suffer from back pain

Do not use or store the product in a humid place such as a bathroom.

- It may cause electric shock, fire, failure, or mold.

Do not allow your child to play or climb on the massage chair.

- There is a risk of failure or injury.

Do not wear something hard on your head such as hair accessories during use.

- It may cause injury.

If you experience any of the following side effects while using the product, stop using it:

- Abrasions, strains, bruises, stinging/burning, or cuts caused by the product
- Damage to muscles, tendons, nerves, spine, etc. due to excessive use and pressure from the product
- Skin diseases and burns such as fractures, dislocations, sprains, etc.
- Respiratory and digestive disorders including asphyxiation, etc.

When massaging your hips and thighs, first remove any objects in your trouser pockets.

- There is a risk of an accident or injury.

Use the product after checking that the power and remote control wires are in their proper place.

- It may cause an accident or injury or product failure.

Do not disconnect the power plug from the wall outlet or turn the power switch to [OFF] during the massage operation.

- There is a risk of injury.

Do not use near open flames such as stoves or while smoking.

Also, do not use it in combination with a heating apparatus such as an electric pad.

- It may cause fire.

Do not use after drinking alcohol.

- There is a risk of an accident or injury.

Two or more people should never sit on or use the product at the same time.

- It may cause failure or injury.

Please do not use it on your bare skin.

- Direct massage on bare skin may cause skin damage.

Be careful not to get your legs caught in the remote control cable.

- There is a risk of an injury.

When cleaning or servicing the product, disconnect the power plug

- This appliance can be used by children aged from 8 years and above and persons with reduced physical, sensory or mental capabilities or lack of experience and knowledge if they have been given supervision or instruction concerning use of the appliance in a safe way and understand the hazards involved.
- Children shall not play with the appliance.
- Cleaning and user maintenance shall not be made by children unless they are older than 8 and supervision.
- Keep the appliance and its cord out of reach of children less than 8 years.
- If the supply cord is damaged, it must be replaced by a special cord or assembly available from the manufacturer or its service agent.
- The appliance has a heated surface. Persons insensitive to heat must be careful when using the appliance.

GROUNDING INSTRUCTION

This product must be grounded. If it should malfunction or breakdown, grounding provides a path of least resistance for electric current to reduce the risk of electric shock. This product is equipped with a cord having an equipment-grounding conductor and a grounding plug. The plug must be plugged into an appropriate outlet that is properly installed and grounded in accordance with all local codes and ordinances.

DANGER

Improper connection of the equipment-grounding conductor can result in a risk of electric shock. Check with a qualified electrician or serviceman if you are in doubt as to whether the product is properly grounded.

Do not modify the plug provided with the product – if it will not fit the outlet, have a proper outlet installed by a qualified electrician.

This product is for use on a nominal 120-volt circuit, and has a grounding plug that looks like the plug illustrated in sketch A in following figure.

A temporary adapter that looks like the adapter illustrated in sketch B and C may be used to connect this plug to a 2-pole receptacle as shown in sketch B if a properly grounded outlet is not available. The temporary adapter should be used only until a properly grounded outlet (sketch A) can be installed by a qualified electrician. The green colored rigid ear, lug, or the like extending from the adapter must be connected to a permanent ground such as a properly grounded outlet box cover. Whenever the adapter is used, it must be held in place by a metal screw.

IMPORTANT SAFETY INSTRUCTIONS

When using an electrical appliance, basic precautions should always be followed, including the following :

Read all instructions before using this appliance:

DANGER – To reduce the risk of electric shock:
Always unplug this appliance from the electrical outlet immediately after using and before cleaning.

WARNING – To reduce the risk of burns, fire, electric shock, or injury to persons:

1. An appliance should never be left unattended when plugged in. Unplug from outlet when not in use, and before putting on or taking off parts.
2. Do not operate under blanket or pillow. Excessive heating can occur and cause fire, electric shock, or injury to persons.
3. Close supervision is necessary when this appliance is used by, on, or near children, invalids, or disabled persons.
4. Use this appliance only for its intended use as described in this manual. Do not use attachments not recommended by the manufacturer.
5. Never operate this appliance if it has a damaged cord or plug, if it is not working properly, if it has been dropped or damaged, or dropped into water. Return the appliance to a service center for examination and repair.
6. Do not carry this appliance by supply cord or use cord as a handle.
7. Keep the cord away from heated surfaces.
8. Never operate the appliance with the air openings blocked. Keep the air openings free of lint, hair, and the like.
9. Never drop or insert any object into any opening.
10. Do not use outdoors.
11. Do not operate where aerosol (spray) products are being used or where oxygen is being administered.
12. To disconnect, turn all controls to the off position, then remove plug from outlet.

13. Use heated surfaces carefully. May cause serious burns. Do not use over insensitive skin areas or in the presence of poor circulation. The unattended use of heat by children or incapacitated persons may be dangerous.
14. Connect this appliance to a properly grounded outlet only. See Grounding Instructions.

SAVE THESE INSTRUCTIONS

This appliance is intended for household use only

WARNING – This appliance is equipped with a thermal resetting protection device. This is a safety feature to protect the appliance from overheating. If the appliance should suddenly stop and will not start, turn off the main switch and pull the plug off the socket outlet. Do not operate the appliance for at least 30 minutes. Failure to turn the appliance off may result in the appliance starting unexpectedly when the device cools.

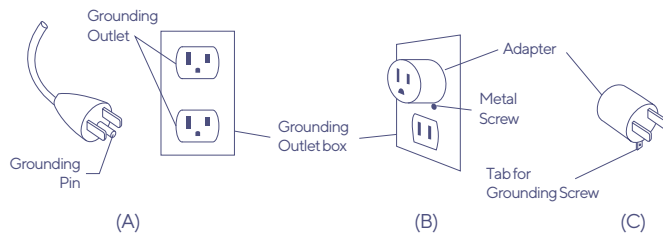

No adapter should be used with this product in Canada

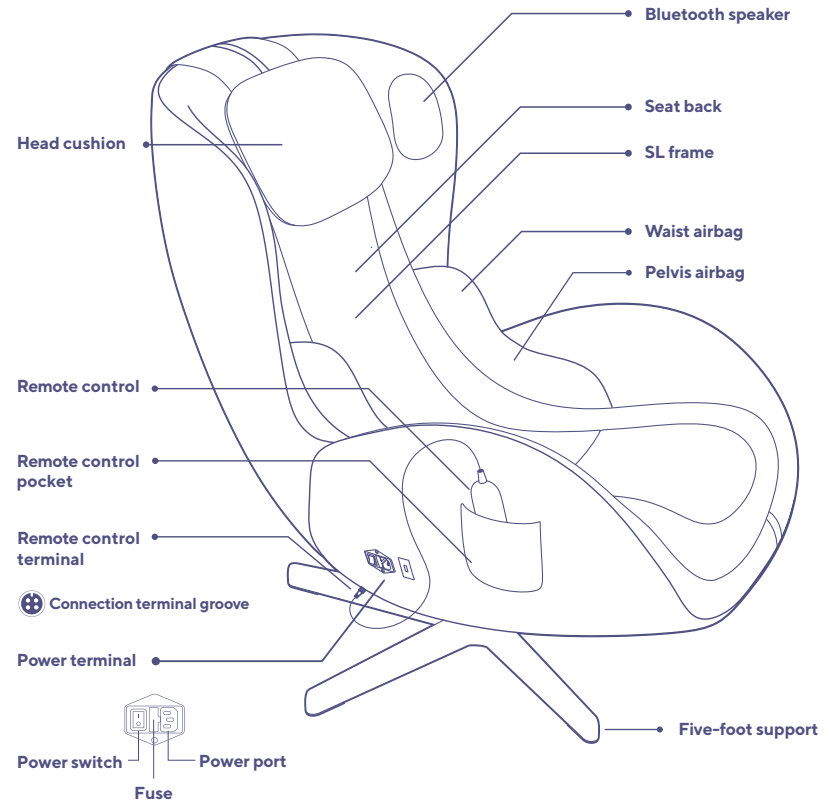

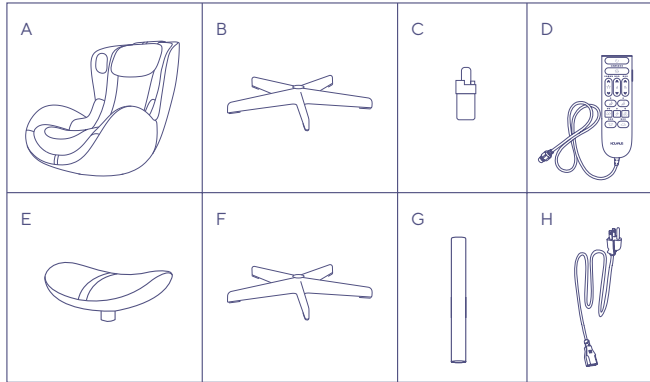

Remove all parts from the box. Check if there are any missing parts. Lay out the foam sheet found in the packaging on a flat surface.

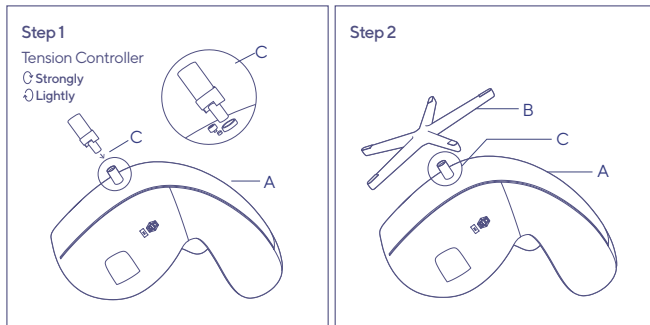

Step 1
Tension Controller
↕ Strongly
↘ Lightly

Place the chair (A) upside down on top of the foam. Insert the Central Connection Support (C) into the Connection Hole under the chair (A).

Step 2
Insert the Five-foot Support (B) onto the Central Connection Support (C).

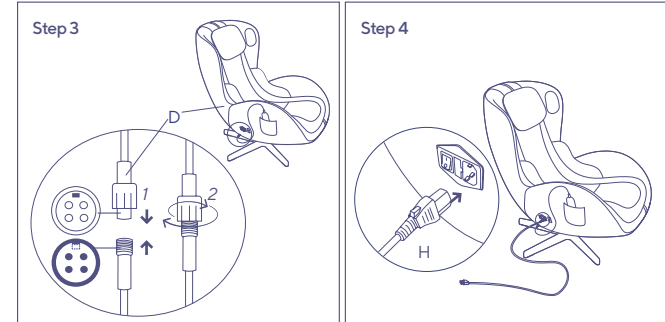

Step 3
Carefully, stand the chair to the upright position. Align the small tooth on each end of the cable and attach the Remote Control (D) and hand tighten. Take care not to over tighten.

Step 4
Insert the Power Cord (H) into the Power Terminal on the side of the chair. Turn switch to 'ON'

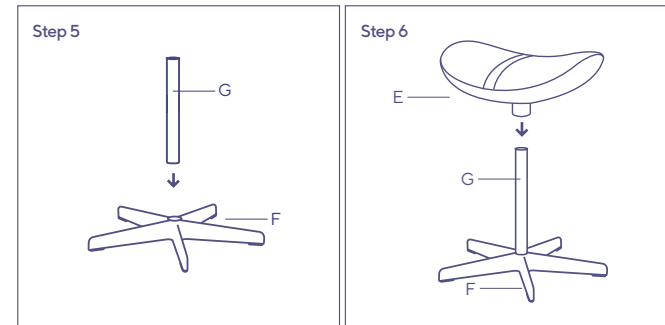

Step 5
Insert the Support Pipe (G) into Ottoman Five-Legged Support (F).

Step 6
Affix the Ottoman Seat (E) onto the Support Pipe (G). Press down on the Ottoman Seat (E) to secure in place.

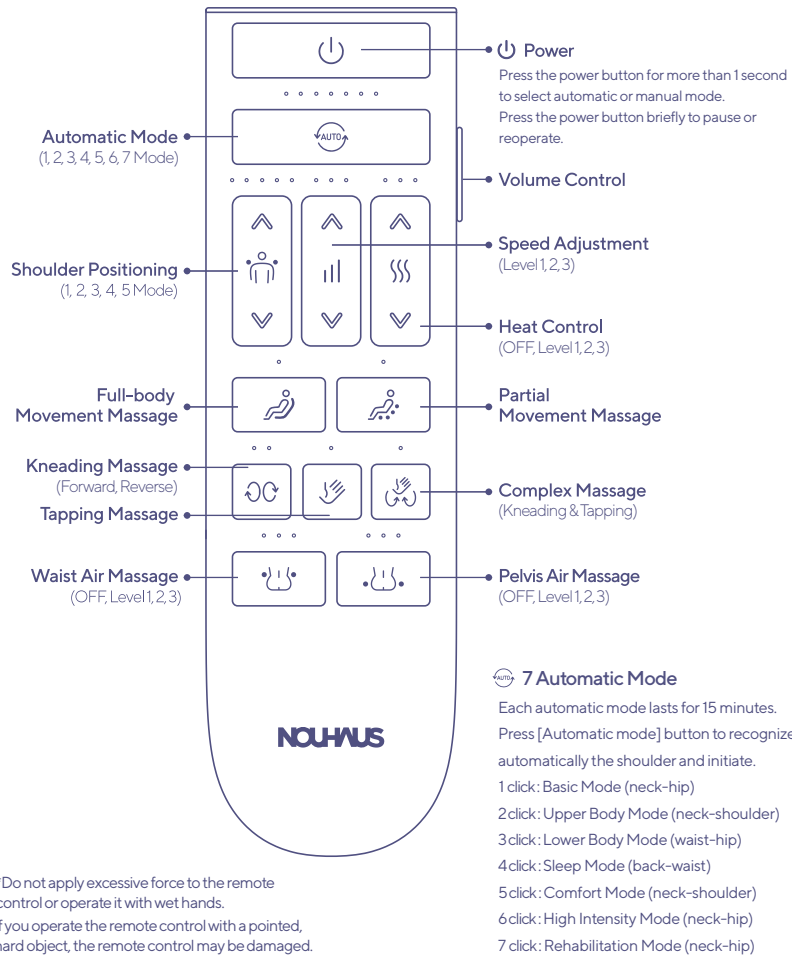

*Do not apply excessive force to the remote control or operate it with wet hands.
If you operate the remote control with a pointed, hard object, the remote control may be damaged.

Shoulder Positioning

Press [^] / [v] button to adjust the position of the shoulder. After automatic shoulder recognition, manually adjust the position of the massage ball in 5 steps to fit the user's sitting height.

Speed Adjustment

Press [^] / [v] button to adjust the speed of the massage.
Level 1: slow
Level 2: medium
Level 3: fast

Heat Control

Press [^] / [v] button to adjust the level of heating function.
Level 1: 35°C
Level 2: 40°C
Level 3: 45°C

Full-body Movement Massage

Press [Full-body] button to move the massage ball over the entire body or fixed range.
1 Click: full body movement massage
(Massage ball moves over the entire body)
2 Click: fixed massage
(The massage ball moves in one fixed range)

Partial Movement Massage

Press [Partial] button to move the massage ball within a certain range or fixed range.
1 Click: partial movement massage
(Massage ball moves within a certain range)
2 Click: fixed massage
(The massage ball moves in one fixed range)

Kneading Massage

Press [kneading] button to select the direction of the kneading
1 Click: normal direction kneading
2 Click: reverse direction kneading
3 Click: OFF

Tapping Massage

Press [tapping] button to activate it
1 Click: tapping
2 Click: OFF

Complex Massage

Press [complex] button to initiate it
1 Click: kneading + tapping
2 Click: OFF

Air Massage

Press [air] button to adjust the strength of waist and pelvis massage
Waist air massage Pelvis air massage
1 click: softly 1 click: softly
2 click: commonly 2 click: commonly
3 click: strongly 3 click: strongly
4 click: OFF 4 click: OFF

Bluetooth

- Select "NM-SN500" on the shown list of available Bluetooth connections
- Insert password "1234"
The Bluetooth speaker can only connect with one device.
- Press the [+] button for more than 5 seconds to reset Bluetooth

Cleaning and Storage Method

When cleaning or maintaining the recliner chair, be sure to disconnect the power plug from the outlet.

Also, Do not touch it with wet hands.

- There is a risk of an electric shock or injury.

Do not wipe with benzene thinner (diluent), alcohol or spray pesticides.

- It may cause discoloration, deterioration or fire.

Continuous exposure to sunlight or UV rays may cause color change, so avoid installation near windows or in places with strong sunlight.

Additional care and storage methods for natural leather products

Do not douse the product with water. Please wipe gently with a leather cleaner which is used for natural leather products.

Never iron the leather finish.

The leather can discolor fabric. So please be cautious when wearing clothes that can easily be discolored.

Information on natural leather

NOUHAUS uses natural cow leather.

It is a natural phenomenon that each natural leather differs in texture and color, and marks such as scars and wrinkles are characteristics of genuine leather.

Due to the features of the natural cowhide, the density of wrinkles and the texture of the skin may vary, so the surface pattern is not uniform, having slight variations.

- Leather is subject to different degrees of dyeing depending on its surface condition.

If any problem occurs while using the product, refer to the following solutions.

Users should never disassemble or repair the product at their own discretion.

NOUHAUS is not responsible for any damage to the product caused by disassembly or repair at the user's discretion.

Problem	Solution
The product does not work.	Check that the main power and power switch are turned on. Check the power plug connection. Check that the correct voltage is used.
You can hear a fricative sound from the massage machine part. You can hear the sound of the motor. Noise increases when using the tapping and kneading function.	Those sounds are generated due to the mechanical structure and are not malfunctions. There may be slight operating sound even during normal operation.
In use, the remote control works, while the massage chair does not work.	When the product is used for a long time, the massage chair automatically switches to overheating prevention mode due to increase in temperature. In this case, turn on the power and wait 30 to 50 minutes for the heat to cool.
Both the remote control and the massage chair do not work.	The automatic mode runs for 15 minutes. It is normal to be turned off automatically after the set time. Press the button again. Please turn the product off and on again.

Q1. Can I get a massage on my back only?

After pressing the kneading / tapping / complex massage button, press the Full-body massage button and press it again when the massage balls reach the targeted area. Then the massage balls will be fixed.

Q2. Is it possible to adjust the tension?

You can adjust the tension using the hexagon wrench provided at the time of installation.

Insert a hexagon wrench into the hole located in the center of the five-foot support at the bottom of the massage chair, and rotate it.

*See tension adjuster on page

Q3. How far does the chair lean back?

It reclines to 121 degrees, from its default angle (106 degrees). When putting your feet on the ottoman, it will naturally become inclined due to the weight. (Reclining degree cannot be fixed)

Q4. I can't connect to Bluetooth Speaker.

After turning the product off and on, delete the NM-SN500 from the device you want to connect to and connect it again.

Or, press and hold the [+] button on the side of the remote control for more than 5 seconds, then the Bluetooth will be disconnected with a notification sound.

Q5. Will it create a lot of inter-floor noise?

Unlike other massage chairs, it barely creates any inter-floor noise because the main body is not attached to the floor.

In addition, you can further reduce the noise by placing a rug under the massage chair.

Q6. Is the leather replaceable?

Only the head cushion, back seat, and airback seat can be replaced. The cost of replacement varies by part.

Q7. The operating sound seems louder than what I heard when trying it out at the store.

At the store, you may not be able to hear the sound of the massage chair due to the ambient noise.

In a relatively quiet residential space, you may hear the machine sound when operating the massage chair, but this is a normal and not a cause for concern.

Q8. Are there body sizes available?

It is recommended for use by those aged 12 or older, and please use it in consideration of the body size below.

Minimum: Height 145cm

Maximum: Height 190cm Weight 120kg

*It is recommended to purchase after experiencing at an offline store as the massage and seating comfort may differ depending on the body type.

Q9. Do you move your product when I move?

Moving service is not provided and you must move yourself.

Q12. How can I hear the speaker sound?

The product can be connected to a mobile phone, tablet or laptop via Bluetooth to play the sound source and listen to the sound.

Bluetooth name : NM-SN500

Bluetooth password : 1234

NOUHAUS massage chairs are warranted for a period of ONE year against

1. Missing materials from the Product at the time of delivery;
2. Defects in the manufacturing of materials used for the Product at the time of delivery;
3. Failure of the Product to correspond with the description in the applicable contract of sale at the time of delivery; and
4. Major defects in the functional department, such as :
 - Skeletal steel frame failure
 - Airbag failure
 - Power failure
 - Remote control failure
 - Massage ball failure
 - Recline tension mechanism failure

Subject to the following:

Any replacement parts shall be sent to the address of the original purchaser, replaced parts may be required to be shipped back to NOUHAUS at its discretion; to benefit under this warranty, NOUHAUS must be notified of any defect within 14 days of the occurrence of such defect via an image or any defect within 14 days of the occurrence of such defect via an image or video of the relevant defect sent electronically to support@nouhaus.com, and after inspection and acceptance by NOUHAUS; to the extent permitted under the applicable Federal and State law of the United States of America, all parts replaced or repaired under this warranty shall be warranted for the remainder of the designated Warranty Period.

What Our Warranty Does Not Cover

All warranties listed on this page exclude the following where permitted under the applicable Federal and State law of the United States of America:

1. Excludes normal wear and tear of surfaces that are not attributable to manufacturing, including but not limited to (a) degradation of upholstery (PU leather / fabric / genuine leather / mesh), top portion of armrests, pillows, casters exterior or mesh stitching, (b) damage to plastic coverings, (c) variance of tightness of mechanisms, and (d) excludes damage from accidents, natural disasters, physical damage from pets, fire and flood, and non-manufacturing incidents covered under insurance policies (regardless of whether you are in possession of the relevant insurance), (e) excludes any variations in dimensions and color;
2. Any claims for indirect, consequential or incidental losses.
3. Damage to a product that has been modified or altered without the written permission of NOUHAUS;
4. Damage caused to all NOUHAUS products during self-assembly due to failure to adhere to the relevant self-assembly manual instructions provided;
5. Minor misalignments, variations arising out of hand-made workmanship. To ensure your product enjoyment and safety, and protection under the "Warranty Period", please ensure you have NOUHAUS assembly and care guidelines for this product, and follow them for the correct assembly and care for your item. Contact our Customer Service Team to obtain these guidelines if you do not have them.

Product Name	NM5(Massage Chair)
Model name	NM-SN500
Size of the chair	W106 x D69 x H100cm
Size of the ottoman	W49 x D39 x H40~52cm
Net weight	36kg(massage chair), 5.05kg(ottoman)
Gross weight (including box)	About 53.8kg
Working voltage	110-120V ~ 50-60Hz
Power consumption	75W
Rated Input Current	1A
FCC ID Number	
ETL Control Number	

For warranty information,
please visit the Warranty page at www.nouhaus.com

Product Information

Product Name	Product Name
Manufacture Date . . .	Manufacture Number
Purchase Store	Purchase Store Contact
Date of Purchase . . .	Order Number
Date of Installation . . .	Warranty Date . . .

Customer Information

Name

Contact

Address

Any changes or modifications not expressly approved by the party responsible for compliance could void the user's authority to operate the equipment.

This device complies with part 15 of the FCC Rules.

Operation is subject to the following two conditions:

1. This device may not cause harmful interference.
2. This device must accept any interference received, including interference that may cause undesired operation.

Note: This equipment has been tested and found to comply with the limits for a Class B digital device, pursuant to part 15 of the FCC Rules. These limits are designed to provide reasonable protection against harmful interference in a residential installation.

This equipment generates uses and can radiate radio frequency energy and, if not installed and used in accordance with the instructions, may cause harmful interference to radio communications. However, there is no guarantee that interference will not occur in a particular installation. If this equipment does cause harmful interference to radio or television reception, which can be determined by turning the equipment off and on, the user is encouraged to try to correct the interference by one or more of the following measures:

- Reorient or relocate the receiving antenna.
- Increase the separation between the equipment and receiver
- Connect the equipment into an outlet on a circuit different from that to which the receiver is connected.
- Consult the dealer or an experienced radio/TV technician for help.

FCC 20cm Statement

This equipment complies with FCC radiation exposure limits set forth for an uncontrolled environment. This equipment should be installed and operated with a minimum distance of 20cm between the radiator and your body. This transmitter must not be co-located or operating in conjunction with any other antenna or transmitter.

Life Curation

NOUHAUS

US Office
NOUHAUS Inc.
10985 Oleander Avenue Fontana, CA 92337

Customer
Service Center
10985 Oleander Avenue Fontana, CA 92337
support@nouhaus.com
+1(888)387-5949

MASSAGE CHAIR USER MANUAL

US Office

NOUHAUS Inc.

10985 Oleander Avenue Fontana, CA 92337

Customer
Service Center

10985 Oleander Avenue Fontana, CA 92337

support@nouhaus.com

+1 (888) 387-5949

Subscribe

 nouhaus.com

 @nouhaus

 @nouhaus

 @nouhausofficial

 @nouhausofficial

 @nouhaus