

Antenna Specification

Specifications Summary

ITEM	SPEC.	
Model Name	IBM 2.4 GHz	
Center Frequency	2402 MHz	2.34 dBi
	2441 MHz	2.07dBi
	2480 MHz	1.45 dBi
MAX. GAIN	2.34 dBi	
Polarization	Horizontal	
Azimuth Beam Pattern	Omni-directional	
Impedance	50 Ω	
Antenna Length	36.0 mm	

Antenna Photo & Length (mm)

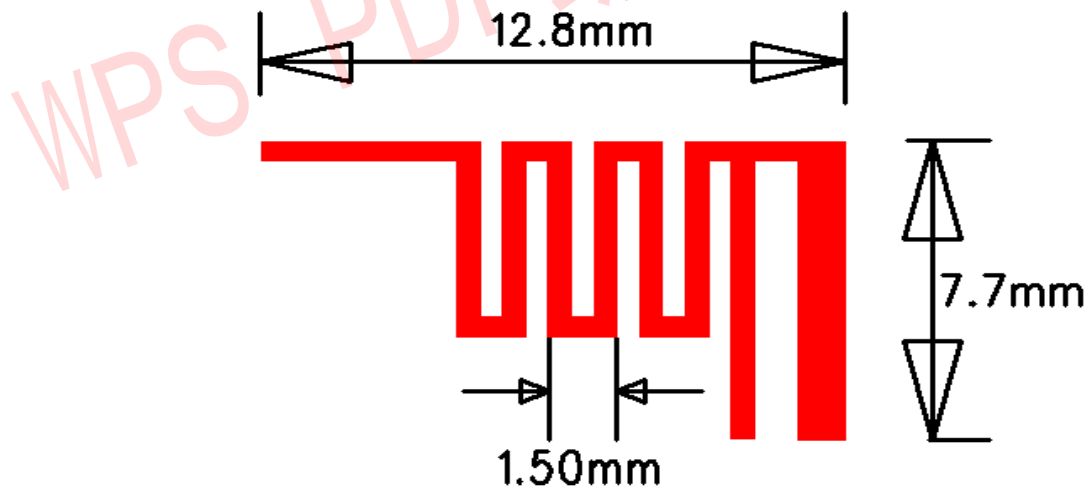

Qingdao Machenike Technology Co., Ltd.

Room 1005, Building 1, No. 169 Binhai Road, Jimo District, Qingdao City, Shandong Province

Test Instrument **vector network analyzer - R&S ZVB20**

1. Main antenna : 2402 MHz

1.1 Horizontal

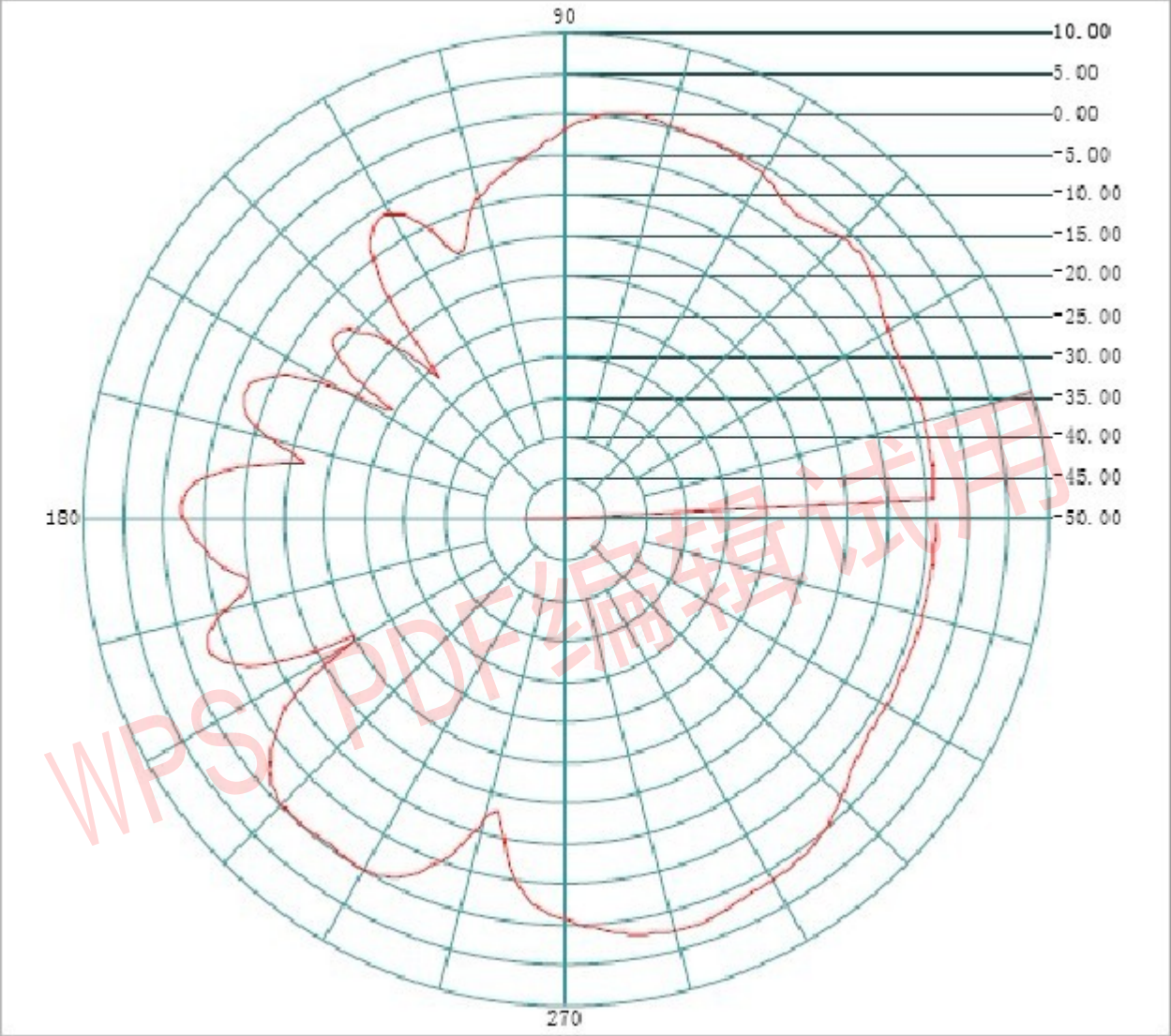

Frequency(MHZ): **2402** Antenna Polarity: **Horizontal**

Maximum Gain(dBi): **'2.54**

Average Gain(dBi) : **-2.48**

Minimum Gain(dBi): **-55.18**

Test Instrument vector network analyzer - R&S ZVB20

1.2 Vertical

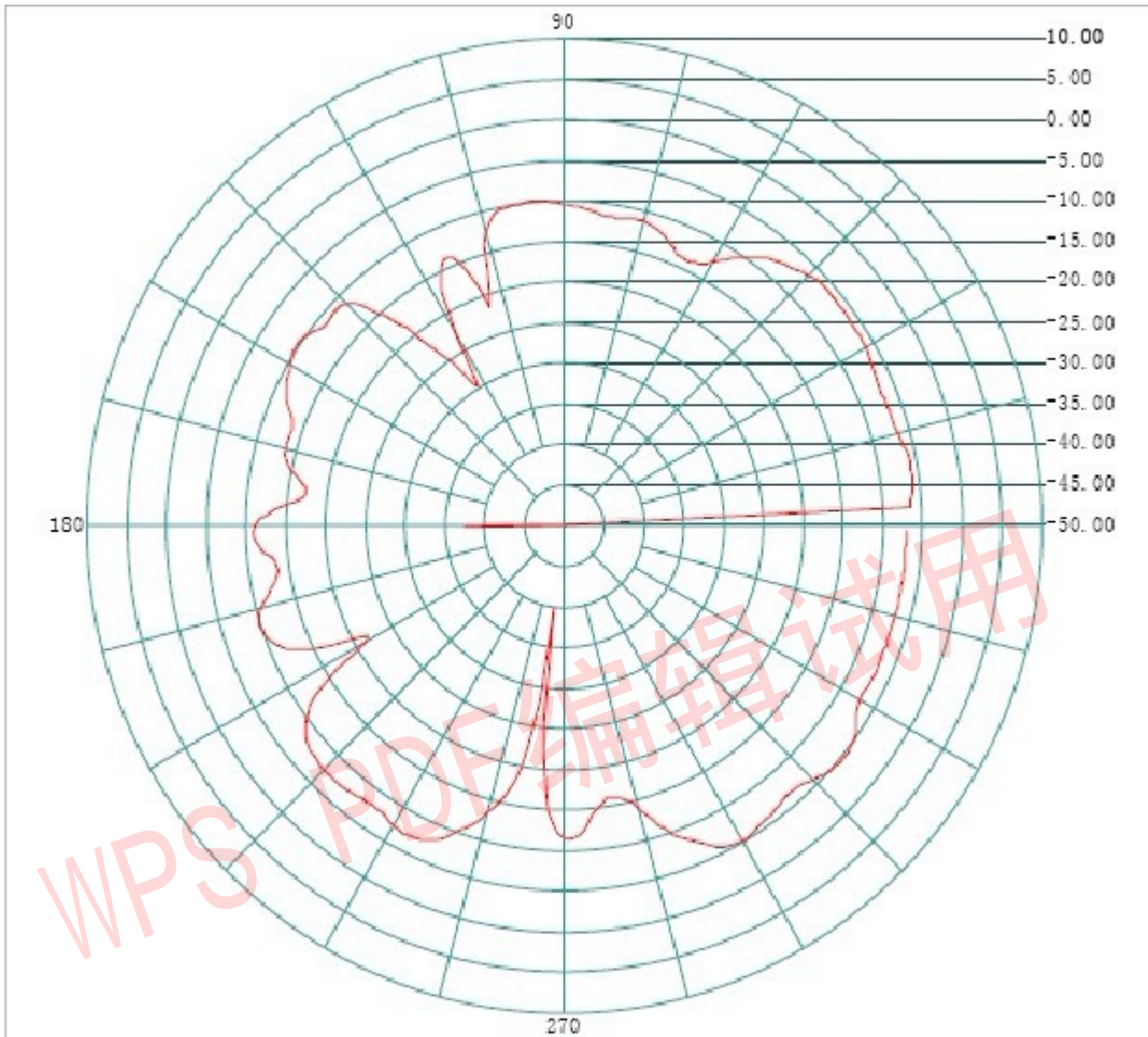

Frequency(MHZ): **2402**

Antenna Polarity: **Vertical**

Maximum Gain(dBi): **4.51**

Average Gain(dBi) : **-8.98**

Minimum Gain(dBi): **-62.3**

2. Main antenna : 2441 MHz

2.1 Horizontal

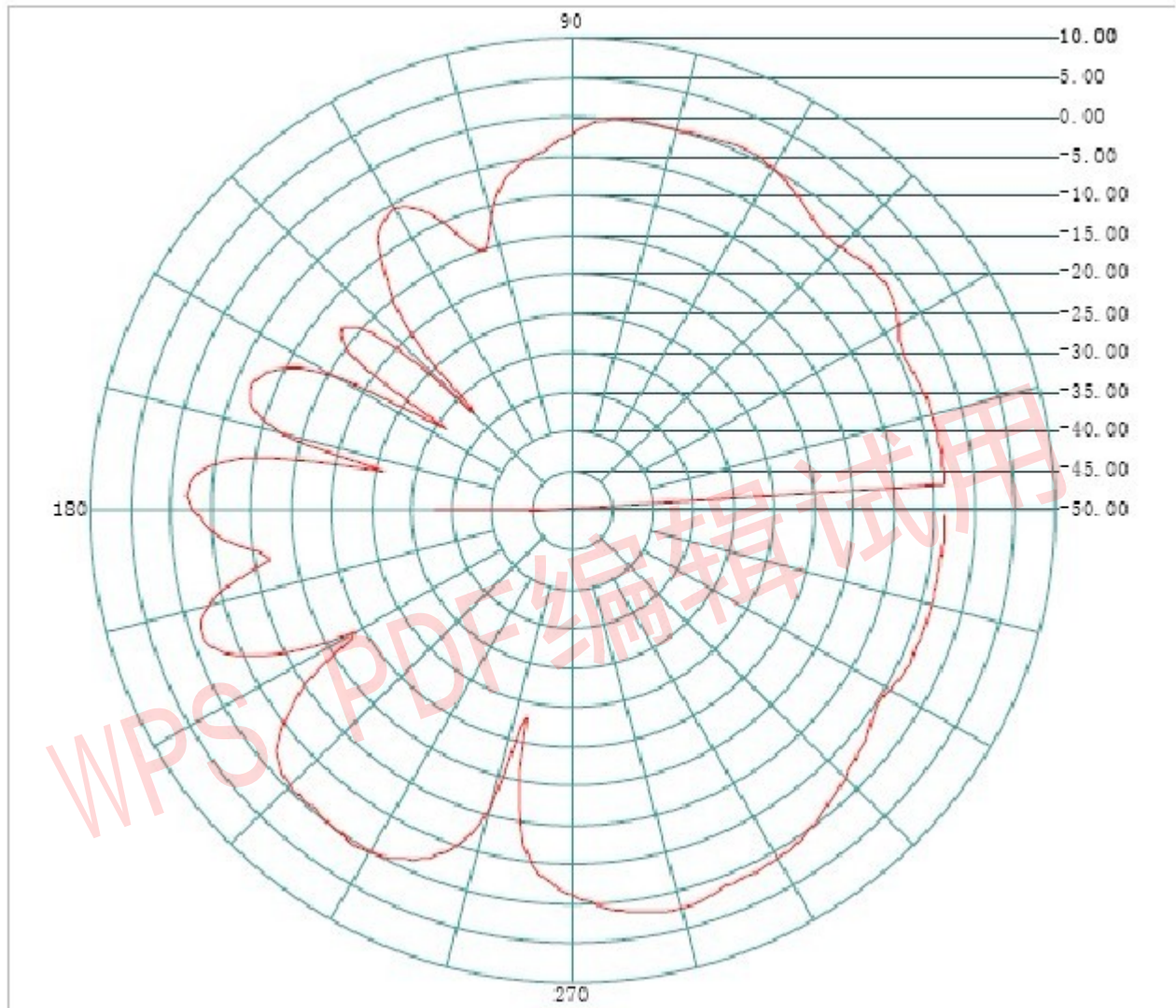

Frequency(MHZ): **2441**

Antenna Polarity: **Horizontal**

Maximum Gain(dBi): **2.07**

Average Gain(dBi) : **-2.54**

Minimum Gain(dBi): **-66.98**

''

2.2 Vertical

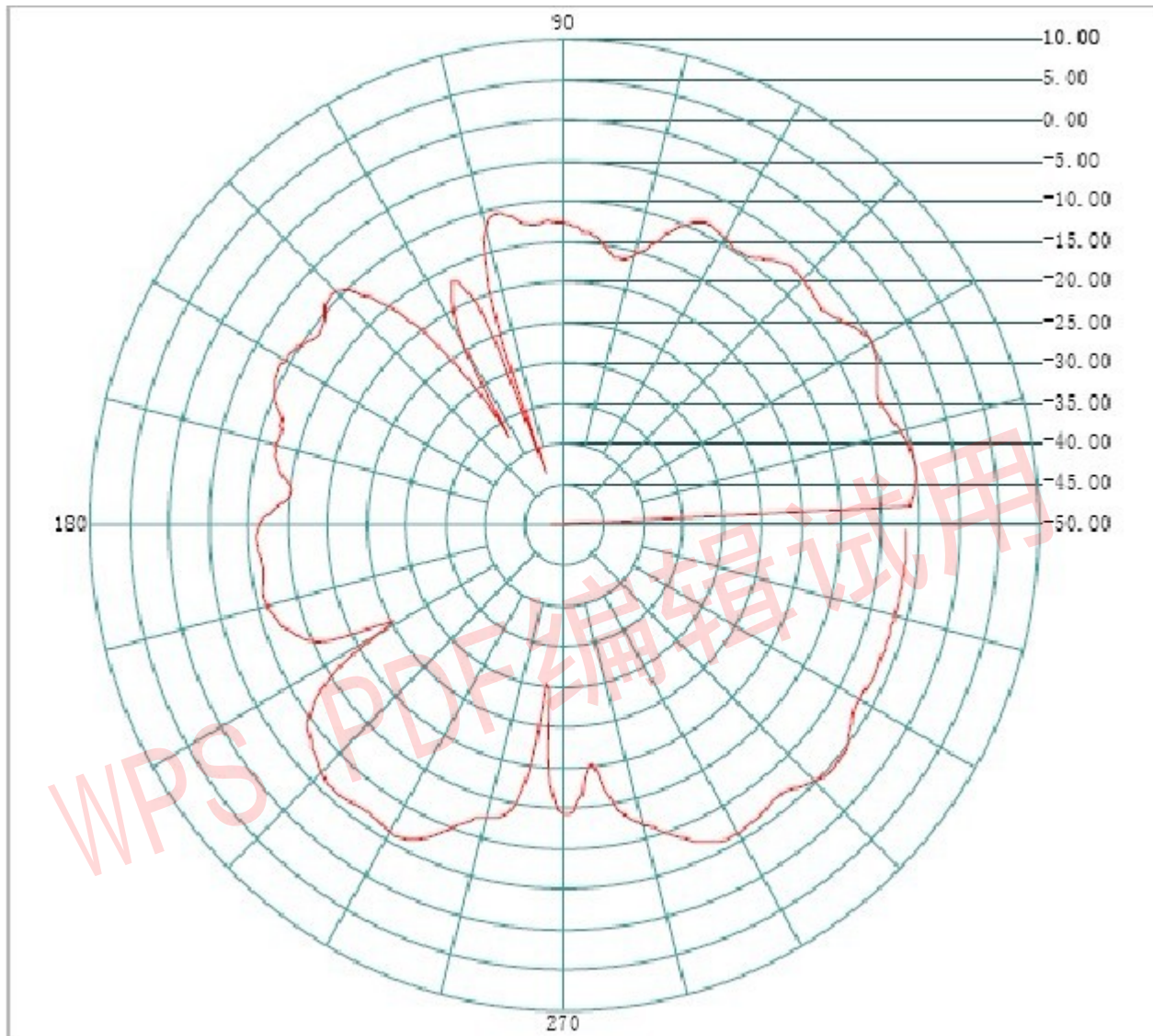

Frequency(MHZ): **2441**

Antenna Polarity: **Vertical**

Maximum Gain(dBi): **-4.29**

Average Gain(dBi) : **-8.81**

Minimum Gain(dBi): **-51.4**

2. Main antenna : 2480 MHz

2.1 Horizontal

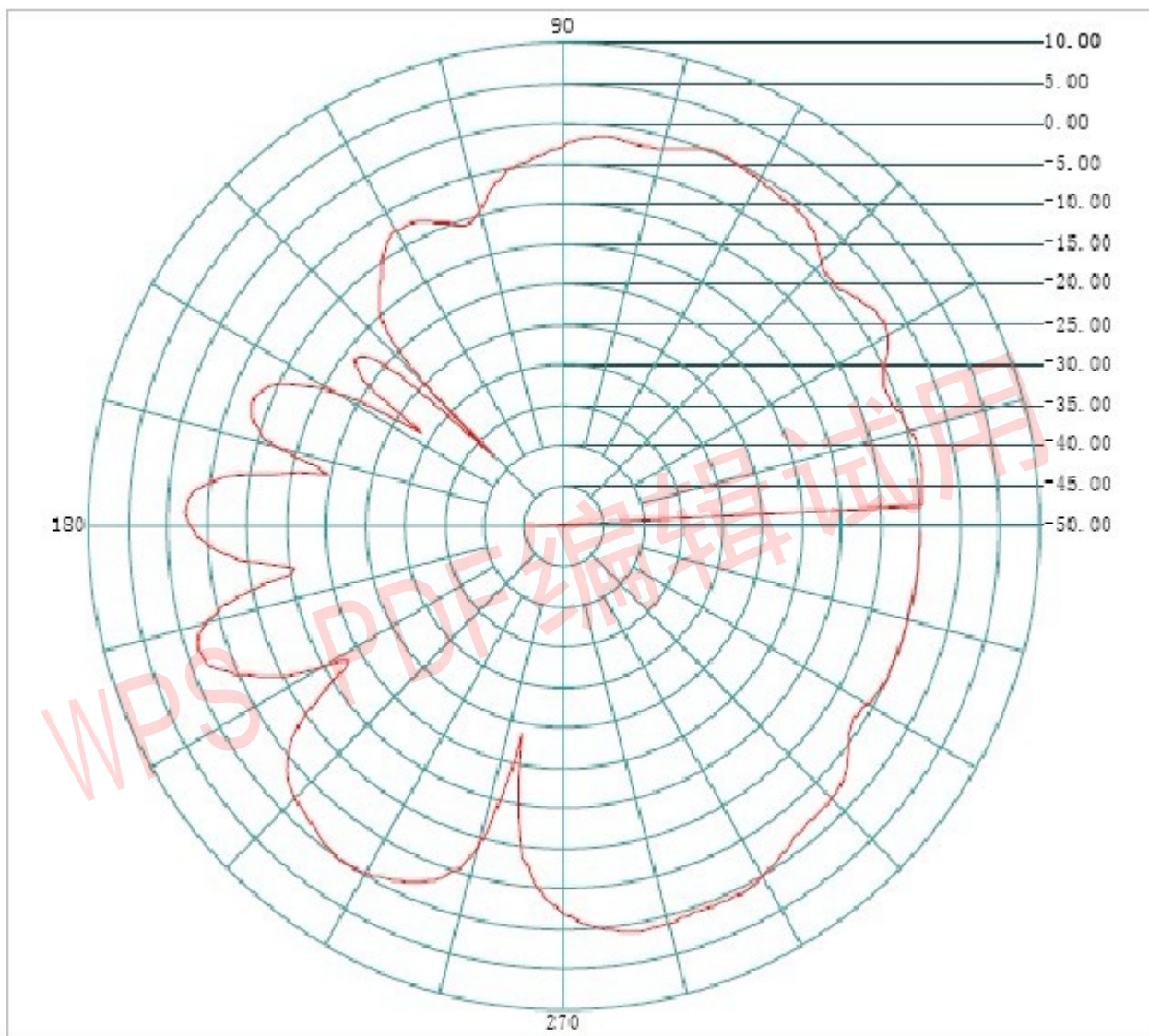

Frequency(MHZ): **2480**

Antenna Polarity: **Horizontal**

Maximum Gain(dBi): **1.45**

Average Gain(dBi) : **-3.34**

Minimum Gain(dBi): **-53.4**

2.2 Vertical

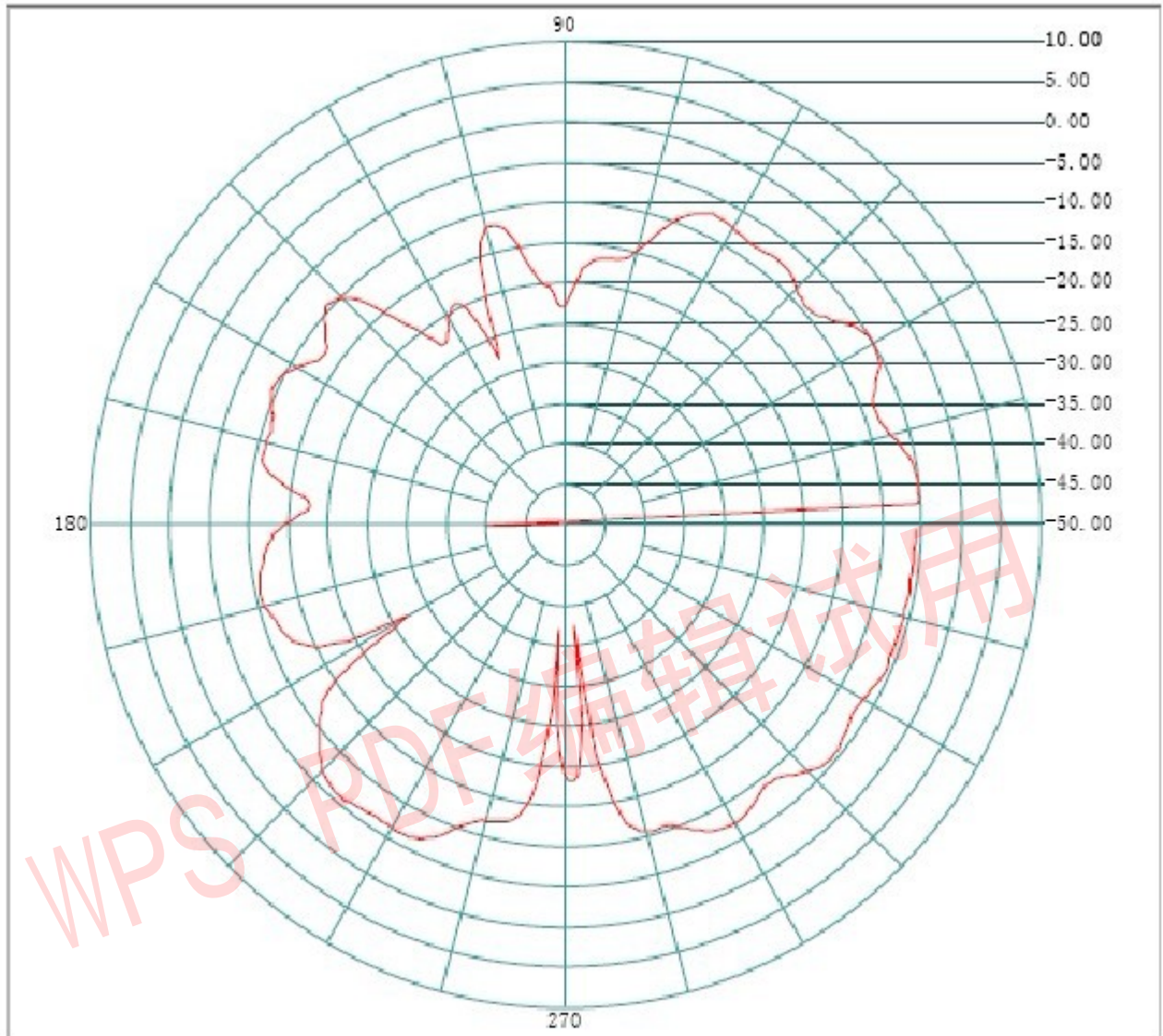

Frequency(MHZ): **2480**

Antenna Polarity: **Vertical**

Maximum Gain(dBi): **-4.95**

Average Gain(dBi) : **-9.06**

Minimum Gain(dBi): **-60.00**