

Electric Vehicle AC Charger Installation Manual

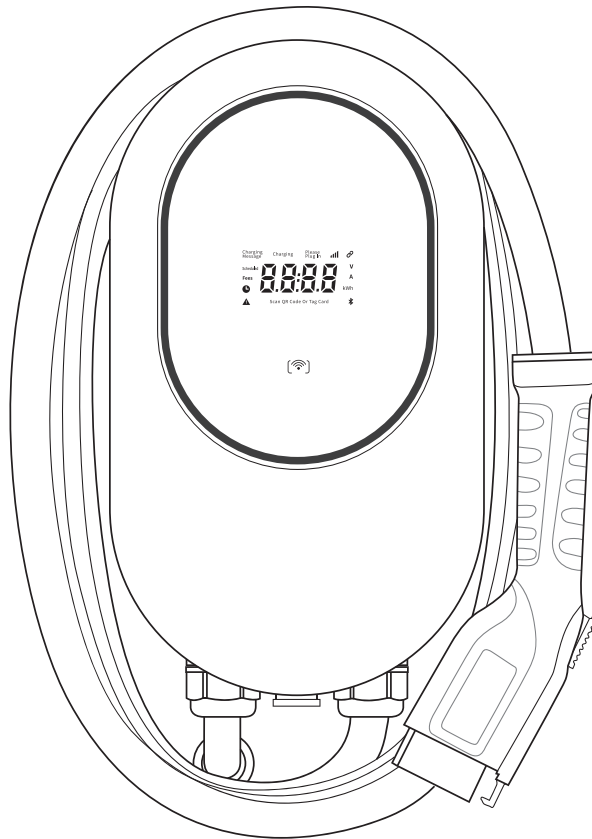

For model: HS100

CONTENTS

1. Safety Instructions	1
1.1. Warnings & Cautions.....	1
1.2. Installation Requirements.....	2
1.3. Daily Maintenance	2
2. Product Introduction	4
2.1. Basic Interface	4
2.2. Basic Dimension	5
2.3. Specifications	6
2.4. Design Standards.....	7
3. Accessories	8
4. Tools for Mounting	9
5. Plan for Mounting	10
6. Operate Your Device	14
6.1. Operating Steps with Plug and Charge.....	14
6.2. Operating Steps with RFID Card	16
7. Light Codes	18
7.1. The Details of Screen	18
7.2. Error and Warning Messages	18
8. FCC STATEMENT	19
9. Warranty and Maintenance	20

1. Safety Instructions

1.1. Warnings & Cautions

WARNING

 To avoid fire, injury or death, read and follow the instructions carefully during installation, operation and maintenance.

DO NOT put fingers into the electric vehicle connector.

DO NOT use this product if the power cord or EV cable is frayed, insulation-broken, or any other signs of damage.

DO NOT use this product if the enclosure or the EV connector is broken, cracked, open, or shows any other indication of damage.

DO NOT remove cover or attempt to open the enclosure because of risk of electric shock.

 This device should be supervised when used around children.

 This device must be grounded.

 To avoid the risk of fire or electric shock, do not use this device with an extension cord.

 The suitability of the use of flexible cord in accordance with CE code, part I, rule 4-012, is to be determined by the local inspection authority.



 To reduce the risk of fire, connect only to a circuit provided branch circuit over-current protection in accordance with the CSA C22. 1 – 15 Canadian Electrical Code, Part 1 (Canada) or NOM-001-SEDE Electrical installations (utility) (Mexico) or ANSI / NFPA 70 National Electrical Code (USA).

Circuit Breaker Options





Output Amperage (A)	16A	32A	40A	48A
Circuit Breaker Options (A)	20A	40A	50A	60A

1.2. Installation Requirements

WARNING



-  Disconnect electrical power prior to installing the charging station.
-  Be sure to preview the user manual and ensure local building and electrical codes are reviewed before installing the AC charger.
-  The AC charger should be installed by a qualified technician according to the user manual and local safety regulations.

CAUTION

-  Use appropriate protection when connecting to the main power distribution cable.
-  Type B, C or D breaker with the rating current for table should be installed in the upstream AC distribution box.
-  Disconnect switch for each ungrounded conductor of AC input shall be provided by others in accordance with the National Electric Code, ANSI/NFPA70.
-  The device shall be mounted at the height between 600 mm and 1200 mm from ground.
-  Please keep the charger in a clean area with low humidity. Not recommended to be installed in coastal environments with high humidity or thick dust.

1.3. Daily Maintenance

CAUTION

-  Avoid moisture or water in the charger. If there is water or moisture ingress in the charger, it is necessary to immediately power off to avoid immediate danger and notify the professionals to carry out maintenance before next use.
-  Please use the charger properly. Do not hit or press hard on the enclosure. If it

is damaged, please contact a professional technician.

- ❗ Avoid placing the charger near hot objects and at high temperature locations and away from dangerous substances such as flammable gases and corrosive materials.
- ❗ To avoid any danger, please do not put any heavy objects on the charger.
- ❗ For 48 Amp installations, we recommend not using a NEMA cable. Instead, we advise a professional electrician hardwire it to the wall, given the high power requirement which could potentially cause electrical issues.
- ❗ For installations of 40 Amps and below, we recommend using a NEMA cable for simple plug-and-play usage.

2. Product Introduction



CAUTION: Avoid placing the charger near hot objects or high temperature locations and away from dangerous substances such as flammable gases and corrosive materials.

2.1. Basic Interface

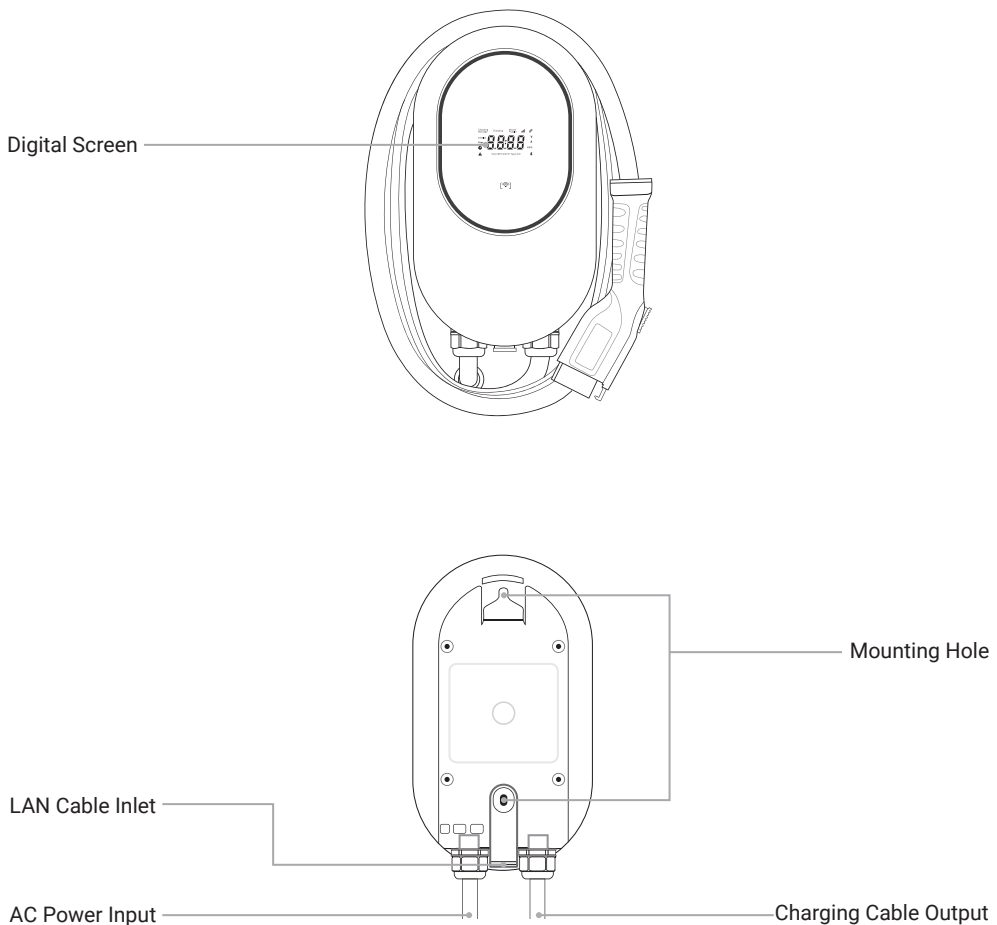

2.2. Basic Dimension

ENCLOSURE

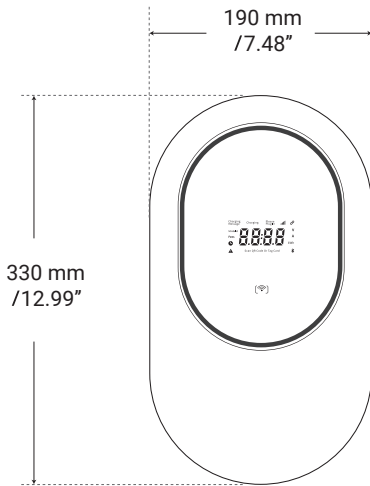

Front View

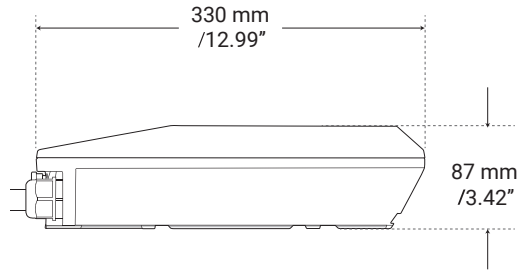

Left View

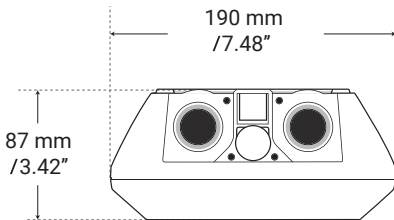

Bottom View

2.3. Specifications

Model Name		HP100-A32	HP100-A40	HP100-A48
Power Specification	Input AC Rating	208-240Vac		
	Max. AC Current	32A	40A	48A
	Frequency	60Hz		
	Max. Output Power	7.4kW	9.6kW	11.5kW
User Interface & Control	Display	2.5" Digital Screen		
	User Authentication	RFID(ISO/IEC 14443 A/B), APP		
	-	-		
	-	-		
Communication	Network Interface	LAN, Wi-Fi and Bluetooth Standard, 3G/4G Optional		
	Communication Protocol	OCPP1.6J Optional		
	-	-		
Environment	Operating Temperature	-22 °F to 122 °F		
	Humidity	5%~95% RH, Non-condensing		
	Altitude	≤6562ft(2000m), No Derating		
	IP/IK Level	IP54/IK10		
Mechanical	Cabinet Dimension (W×D×H)	7.48"×12.99"×3.42"(190mm×330mm×87mm)		
	Weight	11.02lbs(5kgs)		
	Cable Length	18ft(Standard),25ft(Optional)		
Protection	Multiple Protection	OVP(Over Voltage Protection), OCP(Over Current Protection), OTP(Over Temperature Protection), UVP(Under Voltage Protection), SPD(Surge Protection Detection), Grounding Protection, SCP(Short Circuit Protection), Control Pilot Fault, Relay Welding Detection, CCID Self-test		
Regulation	Safety	UL 2594, UL2231-1/-2		
	Certificate	ETL, FCC		
	Charging Interface	SAE J1772 Type 1		

2.4. Design Standards

UL 2594: Electric Vehicle Supply Equipment.

UL 2231-1: UL Personnel Protection Systems for Electric Vehicle (EV) Supply Circuits: General Requirements.

UL 2231: Personnel Protection Systems for Electric Vehicle (EV) Supply Circuits: Particular Requirements for Protection Devices for Use in Charging Systems.

UL 2251: Plugs, Receptacles and Couplers for Electric Vehicles.

UL 62: Flexible Cords and Cables.

UL 991: Tests for Safety-Related Controls Employing Solid-State Devices.

UL 1998: Software in Programmable Components.

NFPA 70 Article 625: National Electrical Code, Electric Vehicle Charging System UL 840 (Clearance and Creepage).

3. Accessories

Check the box to ensure you have this installation guide and these parts:

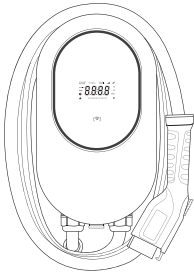

1 AC Charger

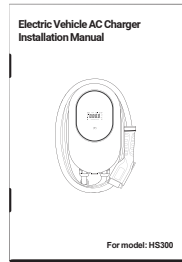

2 User Manual

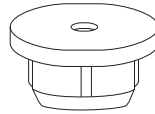

3 Screw Cover

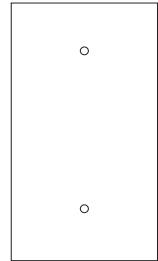

4 Mounting Template

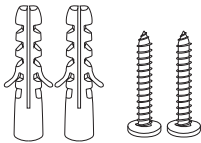

5 M6 Expansion Screws*2

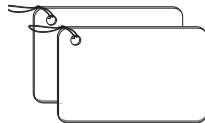

6 Standard RFID Cards*2

No.	Product Name	Quantity	Description
1	AC Charger	1	With attached input power cable and output charging cable.
2	User Manual	1	PDF version available online.
3	Screw Cover	1	For covering screw.
4	Mounting Template	1	For easy drilling of 2 screws holes for AC Charger.
5	M6 Expansion Screws	2	For installing the Mounting Bracket to the wall / structure.
6	Standard RFID Cards	2	To start/stop charger for the unit with RFID reader.

4. Tools for Mounting

Tools required before installing the Wall-mounted charger, gather the following tools:

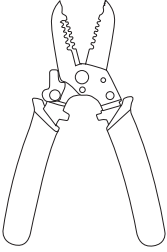

1 Wire stripper

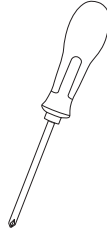

2 Phillips screwdriver

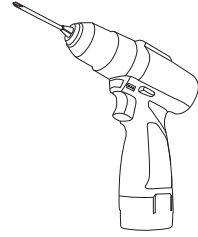

3 Drill

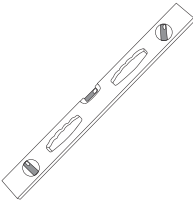

4 Level

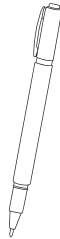

5 Pencil or marker

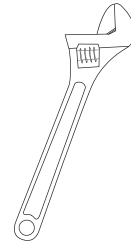

6 Adjustable wrench

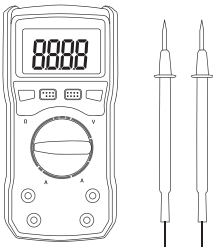

7 Voltmeter or digital multimeter (for measuring AC voltage at the installation site)

NOTE: The above tools are very important, get them ready prior to installation.

5. Plan for Mounting



WARNING: In areas with frequent thunderstorms, add surge protection at the service panel for all circuits. Ensure all power and ground connections, especially those at the breaker and bus bar, are clean and tight.



CAUTION: Not recommended to be installed in coastal environments with high humidity or thick dust.

STEP 1

Select the appropriate mounting location with electrical capacity.

- I. Ensure the owner has chosen a mounting location that allows the charging cable to reach the car's charging port while still providing slack.
- II. The device must be anchored on a solid wall or a stud with the dimensions: 80mm x 130mm.
- III. The device shall be mounted at height between 2 feet (600mm) and 4 feet (1200mm).

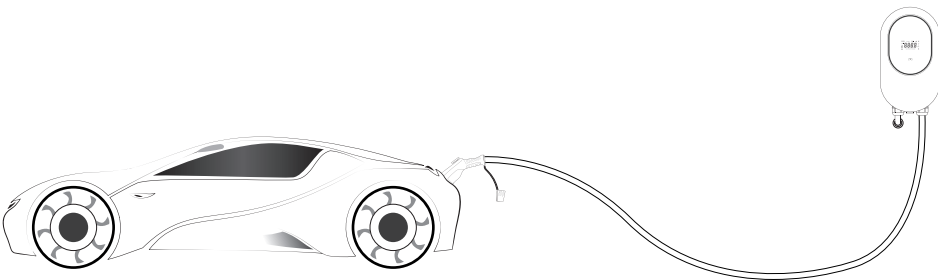

STEP 2

Drill 2 Screw Holes with a diameter of 12mm and a depth of 57mm by using #4 mounting template. Please drill screw holes in the direction of the template arrow.

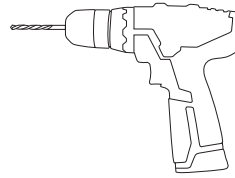
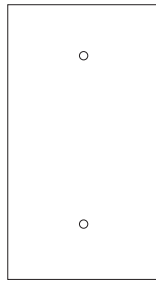

STEP 3

Nail #5 two expansion rubber sleeves into the holes and nail #5 one screw to the top expansion rubber sleeves. The distance between the cover of the screw and the wall is about 5mm.

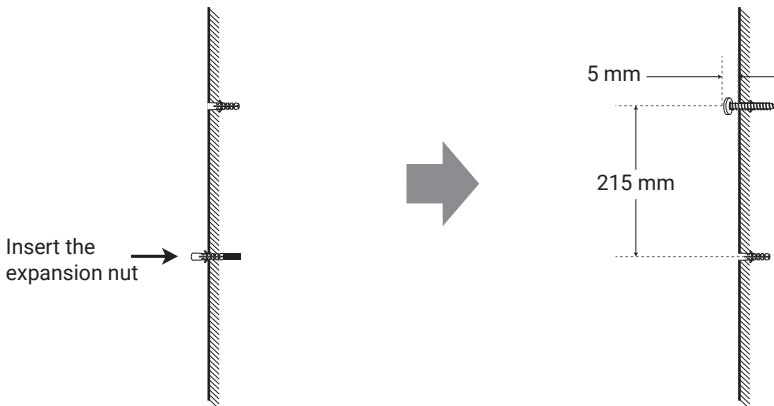

STEP 4

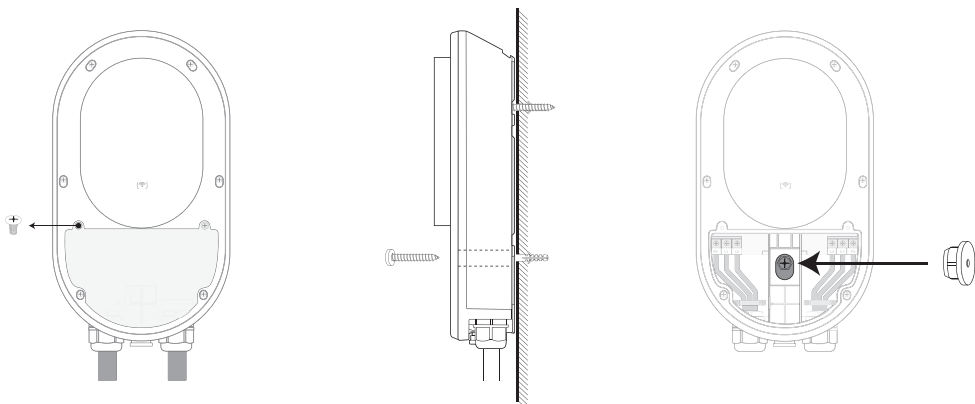

Please unclick the shelf with slotted screwdriver, align the rear notch of charger with the holes and hang the top notch on the top screw, fit the #5 screw to the bottom hole. Cover the screw with #3 screw cover.



STEP 5

Wire the Circuit

WARNING

-  This device must be grounded. Disconnect electrical power prior to installing the charging station.
-  Improper connection of the equipment-grounding conductor would result in a risk of electric shock. Check with a qualified electrician or service man if you are not sure whether the product is properly grounded. Do not modify the plug provided with the product – if it doesn't fit the outlet, have a proper outlet installed by a qualified electrician.

CAUTION

-  Use appropriate protection when connecting to the main power distribution cable.

For the safety purpose, please set circuit breaker protection in the input part of EV Charger. Please follow the instructions below:

Circuit Breaker Options				
Output Amperage (A)	16A	32A	40A	48A
Circuit Breaker Options (A)	20A	40A	50A	60A

STEP 6

Connect L1 with grid L1, L2 with grid L2 and lead the PE to the grid PE. Click back the shelf, and fix the front cover back and tighten with screws at the bottom.

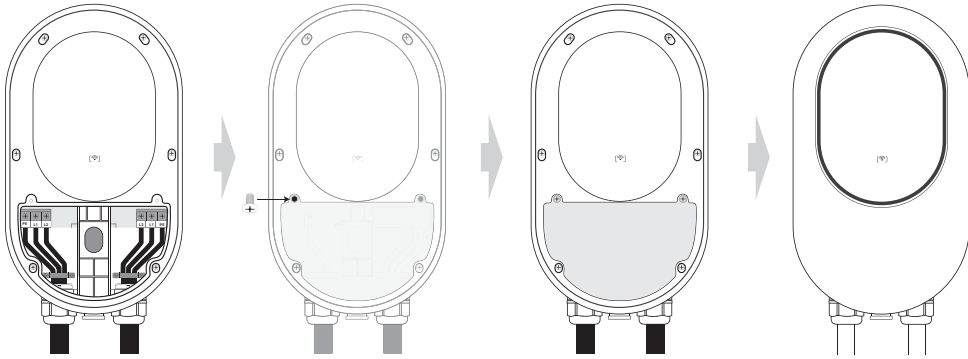

STEP 7

Overall outlook after installation

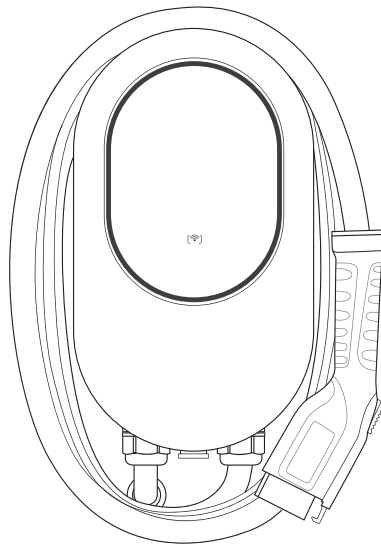

6. Operate Your Device

WARNING

- ⚠ This device should be supervised when used around children.

CAUTION

- ⚠ Please use the charger properly. Do not hit or press hard on the enclosure. If the case is damaged, please contact a professional technician.
- ⚠ To avoid any danger, please do not put any heavy objects on the charger.

6.1. Operating Steps with Plug and Charge

STEP 1

Standby Mode: After the power has been turned on, you will see the sign **"Please Plug In"** on the LED screen.



STEP 2

Plug the Charging Connector: Please plug the charging connector into the vehicle charging inlet.

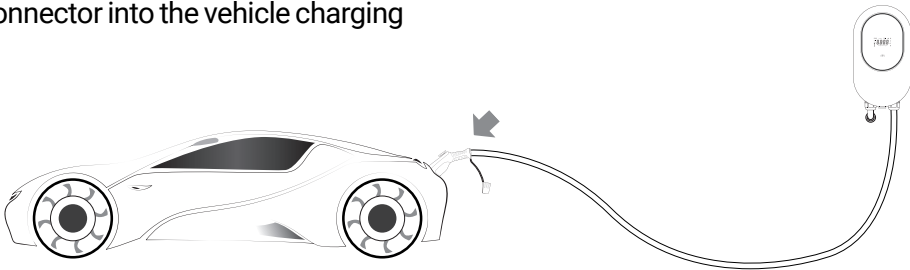

STEP 3

CHARGING: When the charging is going on, You can see "**Charging, circularly voltage, currents and kWh.**" in the LED Screen.

If the sign "⚠" is on, try to plug the vehicle connector again.

If the sign "⚠" continues to be on, please refer to "7.2 Error and warning message".

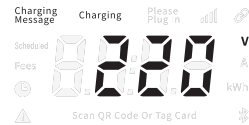

*Figures are for reference only

STEP 4

Charging finished: When the charging is completed, the number of total kWh will be shown. This indicates the total kWh your car has received. Please pull out the charging connector.



*Figures are for reference only

6.2. Operating Steps with RFID Card



CAUTION: Avoid placing the charger near hot objects and at high temperature locations and away from dangerous substances such as flammable gases and corrosive materials.

STEP 1

Standby Mode: After the power has been turned on, you will see the sign “Please Plug In” on the LED screen and the sign “Scan QR Code or Tag Card”.



STEP 2

Ready to charge: Please plug the charging connector into the vehicle charging inlet.

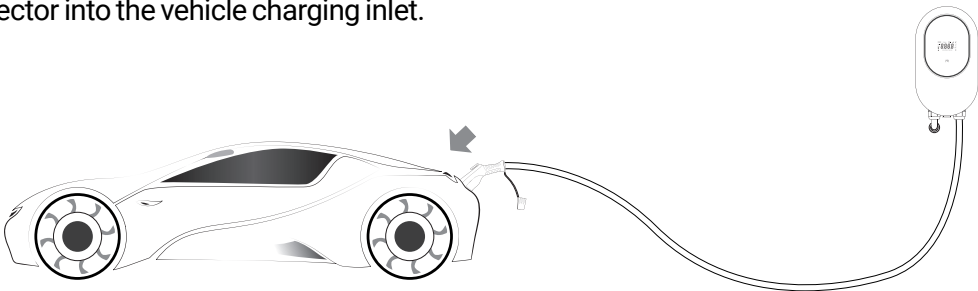

STEP 3

Tap the standard RFID to start/stop charging.



*Figures are for reference only

STEP 4

CHARGING: When the charging is going on, You can see "**Charging, circularly voltage, currents and kWh.**" in the LED Screen.

If the sign "⚠" is on, try to plug the vehicle connector again.

If the sign "⚠" continues to be on, please refer to "7.2 Error and warning message".

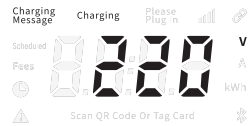

*Figures are for reference only

STEP 5

Charging finished: When you swipe your RFID card to stop charging, the number of total kWh will be shown. This indicates the total kWh your car has received. Please pull out the charging connector.

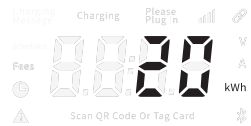

*Figures are for reference only

7. Light Codes

7.1. The Details of Screen

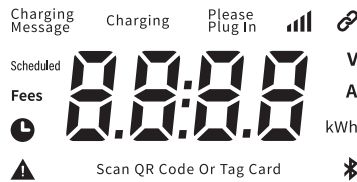

7.2. Error and Warning Messages

Status	Screen Display	Remark
Off Ground	0001	Auto Recover
RCD Abnormal	0002	Auto Recover
Over Current Protection	0004	Auto Recover
Over Voltage Protection	0008	Auto Recover
Under Voltage Protection	0016	Auto Recover
Energy Meter Fault	0032	Contact Customer Service
Control Pilot Fault	0128	Auto Recover
Over Temperature Protection	0256	Auto Recover
Ground Fault	0512	Auto Recover
Ground Self-Test	1024	Auto Recover

8. FCC STATEMENT

This device complies with part 15 of the FCC Rules.

Operation is subject to the following two conditions: This device may not cause harmful interference, and this device must accept any interference received, including interference that may cause undesired operation.

Caution: Changes or modifications to this unit not expressly approved by the party responsible for compliance could void the user's authority to operate the equipment.

Note: This equipment has been tested and found to comply with the limits for a Class A digital device, pursuant to part 15 of the FCC Rules. These limits are designed to provide reasonable protection against harmful interference when the equipment is operated in a commercial environment. This equipment generates, uses, and can radiate radio frequency energy and, if not installed and used in accordance with the instruction manual, may cause harmful interference to radio communications. Operation of this equipment in a residential area is likely to cause harmful interference in which case the user will be required to correct the interference at his own expense.

WIFI module: Contains FCC ID: 2AC7Z-ESP32WROOM32D

LTE module: Contains FCC ID: XMR201909EC25AFX

To satisfy FCC RF exposure requirements, a separation distance of 20cm or more should be maintained between the antenna of this device and persons during device operation. To ensure compliance, operations at closer than this distance is not recommended.

9. Warranty and Maintenance

The warranty period for this charger is two years.

During the warranty period for any malfunction under normal use according to the User Manual and Service Instructions (to be determined by certified maintenance technicians of sellers), the product shall be repaired free of charge. Except for the following situations, the charger shall be subject to the above warranty terms:

1. The warranty certificate cannot be provided or the contents of the warranty certificate are modified or inconsistent with the label indication of the repaired product.
2. Those who are unable to provide valid proof of purchase.
3. Those who exceed the manufacturer's specified warranty period.
4. Those who damage the product due to not following the product service instruction for use, maintenance and storage.
5. Damage or malfunction caused by external object entering.
6. Unauthorized repair, disassembly or modification.
7. Damage caused by force majeure (such as lightning, excessive voltage, earthquake, fire, flood, etc.).
8. Malfunction and damage caused by other unavoidable external factors. Malfunction and damage caused by improper use of equipment, such as water or other solutions entering into the equipment.
9. Malfunction and damage caused by the grid power supply and voltage which is not specified for use with the charger equipment.

The above guarantees shall be made solely, and no other express or implied warranties shall be made (including the implied warranties of merchant ability, particular and applicable reason-ableness and adaptability, etc.) whether in the contract, civil negligence, or other aspects, the Company shall not be responsible for any special, incidental or consequential damages.

