



# FCC Test Report

**Test Report  
On Behalf of  
TRUSTSTONE GROUP, LLC  
For  
3-IN-1 Power Station WIRELESS CHARGING STATION & DIGITAL  
ALARM CLOCK  
Model No.: PY-STCT-MRB, PY-STCT-BLS, PY-STCT-CRM**

**FCC ID: 2BBPLPYSTCT**

**Prepared For :** TRUSTSTONE GROUP, LLC  
1370 Broadway, 9th floor, New York, NY 10018 United States

**Prepared By :** Shenzhen HUAKE Testing Technology Co., Ltd.  
1-2/F., Building B2, Junfeng Zhongcheng Zhizao Innovation Park, Heping,  
Fuhai Street, Bao'an District, Shenzhen, Guangdong, China

**Date of Test:** Aug. 08, 2023 ~ Aug. 16, 2023  
**Date of Report:** Aug. 16, 2023  
**Report Number:** HK2308103615-1E



Test Result Certification

Applicant's Name : TRUSTSTONE GROUP, LLC

Address : 1370 Broadway, 9th floor, New York, NY 10018 United States

Manufacturer's Name : Newbell International Electronic Co.,Ltd.

Address : Room 707-01, Building 3, NO.19 JinPeng Road, Fenggang Town, Dongguan City, Guangdong Province, China

Product Description

Trade Mark : XO POPPY

Product Name : 3-IN-1 Power Station WIRELESS CHARGING STATION & DIGITAL ALARM CLOCK

Model and/or Type Reference : PY-STCT-MRB, PY-STCT-BLS, PY-STCT-CRM

Standards : FCC CFR 47 PART 18

This publication may be reproduced in whole or in part for non-commercial purposes as long as the Shenzhen HUAKE Testing Technology Co., Ltd. is acknowledged as copyright owner and source of the material. Shenzhen HUAKE Testing Technology Co., Ltd. takes no responsibility for and will not assume liability for damages resulting from the reader's interpretation of the reproduced material due to its placement and context.

Date of Test :

Date (s) of Performance of Tests : Aug. 08, 2023 ~ Aug. 16, 2023

Date of Issue : Aug. 16, 2023

Test Result : Pass

Testing Engineer :

Gary Qian

(Gary Qian)

Technical Manager :

Eden Hu

(Eden Hu)

Authorized Signatory :

Jason Zhou

(Jason Zhou)



**Table of Contents**

**Page**

1 . Test Summary	5
1.1 . Test Procedures and Results	5
1.2 . Information of the Test Laboratory	5
1.3 . Measurement Uncertainty	5
2. General Information	6
2.1. General Description of EUT	6
2.2. Carrier Frequency of Channels	7
2.3. Operation of EUT during Testing	7
2.4. Test Mode	7
2.5. Description of Test Setup	8
2.6. Description of Support Units	9
2.7. Measurement Instruments List	10
3. Conducted Emission Test	11
3.1. Block Diagram of Test Setup	11
3.2. Conducted Power Line Emission Limit	11
3.3. Test Procedure	11
3.4. Test Result	12
4. Radiated Emissions	14
4.1. Block Diagram of Test Setup	14
4.2. Rules and Specifications	15
4.3. Test Procedure	15
4.4. Test Result	15
5. Antenna Requirement	20
6. Photographs of Test	21
7. Photos of the EUT	23



**\*\* Modified History \*\***

Revision	Description	Issued Data	Remark
Revision 1.0	Initial Test Report Release	Aug. 16, 2023	Jason Zhou





# 1. Test Summary

## 1.1. Test Procedures and Results

Description of Test	Section Number	Result
Conducted Emissions Test	18.307	COMPLIANT
Radiated Emission Test	18.305	COMPLIANT

**Note:**

1. PASS: Test item meets the requirement.
2. Fail: Test item does not meet the requirement.
3. N/A: Test case does not apply to the test object.
4. The test result judgment is decided by the limit of test standard.

## 1.2. Information of the Test Laboratory

Shenzhen HUAK Testing Technology Co., Ltd.

Add.: 1-2/F., Building B2, Junfeng Zhongcheng Zhizao Innovation Park, Heping, Fuhai Street, Bao'an District, Shenzhen, Guangdong, China

Testing Laboratory Authorization :

A2LA Accreditation Code is 4781.01.

FCC Designation Number is CN1229.

Canada IC CAB identifier is CN0045.

CNAS Registration Number is L9589.

## 1.3. Measurement Uncertainty

Measurement Uncertainty

Conducted Emission Expanded Uncertainty	=	2.71dB, k=2
Radiated emission expanded uncertainty(9kHz-30MHz)	=	3.90dB, k=2
Radiated emission expanded uncertainty(30MHz-1000MHz)	=	3.90dB, k=2
Radiated emission expanded uncertainty(Above 1GHz)	=	4.28dB, k=2



## 2. General Information

### 2.1. General Description of EUT

Equipment:	3-IN-1 Power Station WIRELESS CHARGING STATION & DIGITAL ALARM CLOCK
Model Name:	PY-STCT-MRB
Series Models:	PY-STCT-BLS, PY-STCT-CRM
Model Difference:	All model's the function, software and electric circuit are the same, only with model named different. Test sample model: PY-STCT-MRB.
Trade Mark:	XO POPPY
FCC ID:	<b>2BBPLPYSTCT</b>
Antenna Type:	Coil Antenna
Antenna Gain:	0dBi
Operation Frequency:	112KHz~205KHz
Test Frequency:	Mobile Phone:125KHz Watch: 116KHz
Modulation Type:	ASK
Power Source:	Input: 5VDC, 3A or 9VDC, 3A Earphone wireless Output: 5W Mobile phone wireless Output: 5W or 7.5W or 10W or 15W
Power Rating:	Input: 5VDC, 3A or 9VDC, 3A Earphone wireless Output: 5W Mobile phone wireless Output: 5W or 7.5W or 10W or 15W
Note: The transfer system includes two coils, 2 coils can work individually or can work at the same time. All the situation (full load, half load and empty load) has been tested, only the worst situation (ANT1+ANT2 full load 15W) was recorded in the report.	



### 2.2. Carrier Frequency of Channels

Operation Frequency each of channel	
Channel	Frequency
01	125KHz
02	116KHz

### 2.3. Operation of EUT during Testing

Operating Mode  
 The mode is used: Transmitting mode

### 2.4. Test Mode

EUT Mode		Description
Working	ANT 1	Full Load
		Half Load
		No Load
	ANT 2	Full Load
		Half Load
		No Load
	ANT 1+ ANT 2	Full Load
		Half Load
		No Load

Note: All modes have been tested, and the report only reflects the worst case data.



### 2.5. Description of Test Setup

Operation of EUT during Testing:

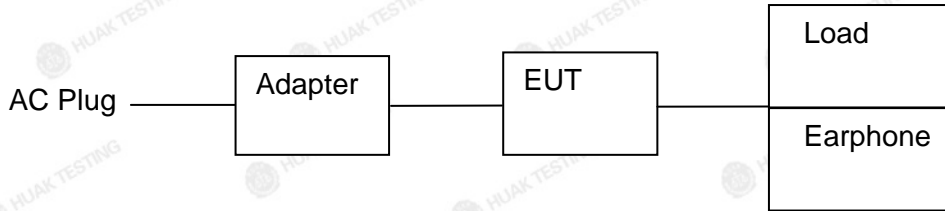

The sample was placed (0.8m (30MHz~1GHz), 0.8m (9KHz~30MHz)) above the ground plane of 3m chamber. Measurements in both horizontal and vertical polarities were performed. During the test, each emission was maximized by: having the EUT continuously working, investigated all operating modes, rotated about all 3 axis (X, Y & Z) and considered typical configuration to obtain worst position, manipulating interconnecting cables, rotating the turntable, varying antenna height from 1m to 4m in both horizontal and vertical polarizations. The emissions worst-case are shown in Test Results of the following pages. The worst case is X position.





**2.6. Description of Support Units**

The EUT has been tested as an independent unit together with other necessary accessories or support units. The following support units or accessories were used to form a representative test configuration during the tests.

Item	Equipment	Trade Mark	Model/Type No.	Specification	Remark
1	3-IN-1 Power Station WIRELESS CHARGING STATION & DIGITAL ALARM CLOCK	XO POPPY	PY-STCT-MRB	N/A	EUT
2	USB Cable	N/A	N/A	1.0m	Accessory
3	Adapter	N/A	CD289	Input: AC100-240V, 50/60Hz, 2A Max USB-C1 Output: DC5V/3A, 9V/3A, 12V/3A, 15V/3A, 20V/5A, 28V/5A 140W MAX USB-C2 Output: DC5V/3A, 9V/3A, 12V/3A, 15V/3A, 20V/5A 100W MAX USB-A Output: DC5V/4.5A, 4.5V/5A, 5V/3A, 9V/2A, 12V/1.5A 22.5W MAX Total Output: 140W Max	Peripheral
5	Load	YBZ	N/A	15W Max	Peripheral
6	Earphone	N/A	N/A	5W	Peripheral

**Note:**

1. All the equipment/cables were placed in the worst-case configuration to maximize the emission during the test.
2. Grounding was established in accordance with the manufacturer's requirements and conditions for the intended use.
3. For conducted measurements (Output Power, 6dB Emission Bandwidth, Power Spectral Density, Spurious Emissions), the antenna of EUT is connected to the test equipment via temporary antenna connector, the antenna connector is soldered on the antenna port of EUT, and the temporary antenna connector is listed in the Test Instruments.



**2.7. Measurement Instruments List**

Item	Equipment	Manufacturer	Model No.	Serial No.	Last Cal.	Cal. Interval
1.	L.I.S.N. Artificial Mains Network	R&S	ENV216	HKE-002	Feb. 17, 2023	1 Year
2.	Receiver	R&S	ESR-7	HKE-005	Feb. 17, 2023	1 Year
3.	RF automatic control unit	Tonscend	JS0806-2	HKE-060	Feb. 17, 2023	1 Year
4.	Spectrum analyzer	R&S	FSP40	HKE-025	Feb. 17, 2023	1 Year
5.	Spectrum analyzer	Agilent	N9020A	HKE-048	Feb. 17, 2023	1 Year
6.	Preamplifier	Schwarzbeck	BBV 9743	HKE-006	Feb. 17, 2023	1 Year
7.	EMI Test Receiver	Rohde & Schwarz	ESR-7	HKE-010	Feb. 17, 2023	1 Year
8.	Bilog Broadband Antenna	Schwarzbeck	VULB9163	HKE-012	Feb. 17, 2023	1 Year
9.	Loop Antenna	Schwarzbeck	FMZB 1519 B	HKE-014	Feb. 17, 2023	1 Year
10.	Horn Antenna	Schwarzbeck	9120D	HKE-013	Feb. 17, 2023	1 Year
11.	Pre-amplifier	EMCI	EMC051845 SE	HKE-015	Feb. 17, 2023	1 Year
12.	Pre-amplifier	Agilent	83051A	HKE-016	Feb. 17, 2023	1 Year
13.	EMI Test Software EZ-EMC	Tonscend	JS1120-B Version	HKE-083	N/A	N/A
14.	Power Sensor	Agilent	E9300A	HKE-086	Feb. 17, 2023	1 Year
15.	Spectrum analyzer	Agilent	N9020A	HKE-048	Feb. 17, 2023	1 Year
16.	Signal generator	Agilent	N5182A	HKE-029	Feb. 17, 2023	1 Year
17.	Signal Generator	Agilent	83630A	HKE-028	Feb. 17, 2023	1 Year
18.	Shielded room	Shiel Hong	4*3*3	HKE-039	Dec. 09, 2021	3 Year
19.	10dB Attenuator	Schwarzbeck	VTSD9561F	HKE-153	Feb. 17, 2023	1 Year



### 3. Conducted Emission Test

#### 3.1. Block Diagram of Test Setup

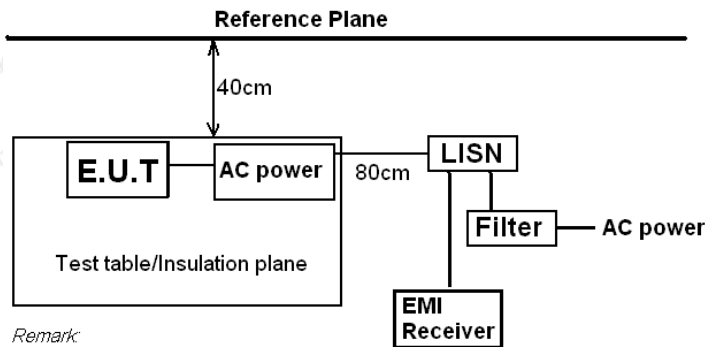

Remark  
 E.U.T: Equipment Under Test  
 LISN: Line Impedance Stabilization Network  
 Test table height=0.8m

#### 3.2. Conducted Power Line Emission Limit

According to FCC Part 18.307(b)

Frequency (MHz)	Maximum RF Line Voltage (dBμV)			
	CLASS A		CLASS B	
	Q.P.	Ave.	Q.P.	Ave.
0.15 - 0.50	79	66	66-56*	56-46*
0.50 - 5.00	73	60	56	46
5.00 - 30.0	73	60	60	50

\* Decreasing linearly with the logarithm of the frequency

For intentional device, according to §18.307 Line Conducted Emission Limit is same as above table.

#### 3.3. Test Procedure

1. The equipment was set up as per the test configuration to simulate typical actual usage per the user's manual. The EUT is a tabletop system, a wooden table with a height of 0.8 meters is used and is placed on the ground plane as per ANSI C63.10.
2. Support equipment, if needed, was placed as per ANSI C63.10.
3. All I/O cables were positioned to simulate typical actual usage as per ANSI C63.10.
4. If a EUT received DC power from the USB Port of Notebook PC, the PC's adapter received AC120V/60Hz power through a Line Impedance Stabilization Network (LISN) which supplied power source and was grounded to the ground plane.
5. All support equipments received AC power from a second LISN, if any.
6. The EUT test program was started. Emissions were measured on each current carrying line of the EUT using a spectrum Analyzer / Receiver connected to the LISN powering the EUT. The LISN has two monitoring points: Line 1 (Hot Side) and Line 2 (Neutral Side). Two scans were taken: one with Line 1 connected to Analyzer / Receiver and Line 2 connected to a 50 ohm load; the second scan had Line 1 connected to a 50 ohm load and Line 2 connected to the Analyzer / Receiver.
7. Analyzer / Receiver scanned from 150 KHz to 30MHz for emissions in each of the test modes.





### 3.4. Test Result

PASS

All the test modes completed for test. Only the worst result (ANT 1+ ANT 2) was reported as below:

Test Specification: Line

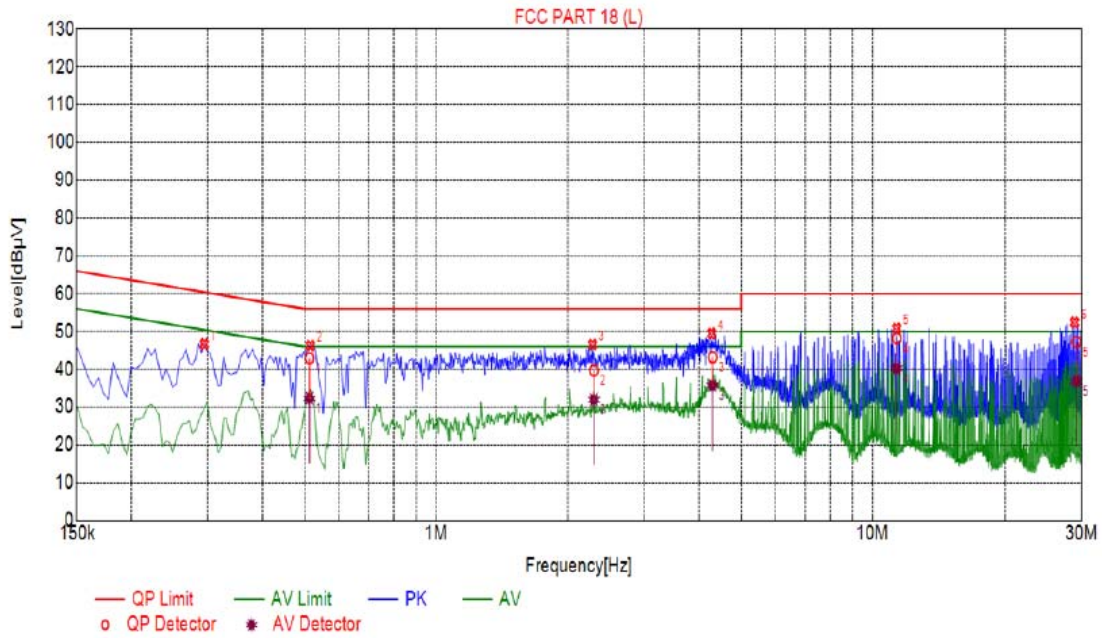

Suspected List								
NO.	Freq. [MHz]	Level [dBµV]	Factor [dB]	Limit [dBµV]	Margin [dB]	Reading [dBµV]	Detector	Type
1	0.2940	46.65	20.03	60.41	13.76	26.62	PK	L
2	0.5145	46.26	20.04	56.00	9.74	26.22	PK	L
3	2.2830	46.52	20.18	56.00	9.48	26.34	PK	L
4	4.2765	49.45	20.25	56.00	6.55	29.20	PK	L
5	11.3595	50.77	20.00	60.00	9.23	30.77	PK	L
6	28.8780	52.41	20.26	60.00	7.59	32.15	PK	L

Final Data List											
NO.	Freq. [MHz]	Correction factor [dB]	QP Value [dBµV]	QP Limit [dBµV]	QP Margin [dB]	QP Reading [dBµV]	AV Value [dBµV]	AV Limit [dBµV]	AV Margin [dB]	AV Reading [dBµV]	Type
1	0.5119	20.04	42.92	56.00	13.08	22.88	32.32	46.00	13.68	12.28	L
2	2.3004	20.18	39.68	56.00	16.32	19.50	31.94	46.00	14.06	11.76	L
3	4.3003	20.25	43.19	56.00	12.81	22.94	35.71	46.00	10.29	15.46	L
4	11.3634	20.00	48.24	60.00	11.76	28.24	40.24	50.00	9.76	20.24	L
5	29.1363	20.26	47.27	60.00	12.73	27.01	36.83	50.00	13.17	16.57	L

Remark: Margin = Limit - Level

Correction factor = Cable lose + LISN insertion loss

Level=Test receiver reading + correction factor

The results shown in this test report refer only to the sample(s) tested unless otherwise stated and the sample(s) are retained for 30 days only. The document is issued by HUAK, this document cannot be reproduced except in full with our prior written permission. The more details and the authenticity of the report will be confirmed at <http://www.cer-mark.com>.

TEL : +86-755 2302 9901 FAX : +86-755 2302 9901 E-mail : service@cer-mark.com

Add: 1-2F., Building B2, Junfeng Zhongcheng Zhizao Innovation Park, Heping Community, Fuhai Street, Bao'an District, Shenzhen, Guangdong, China





Test Specification: Neutral

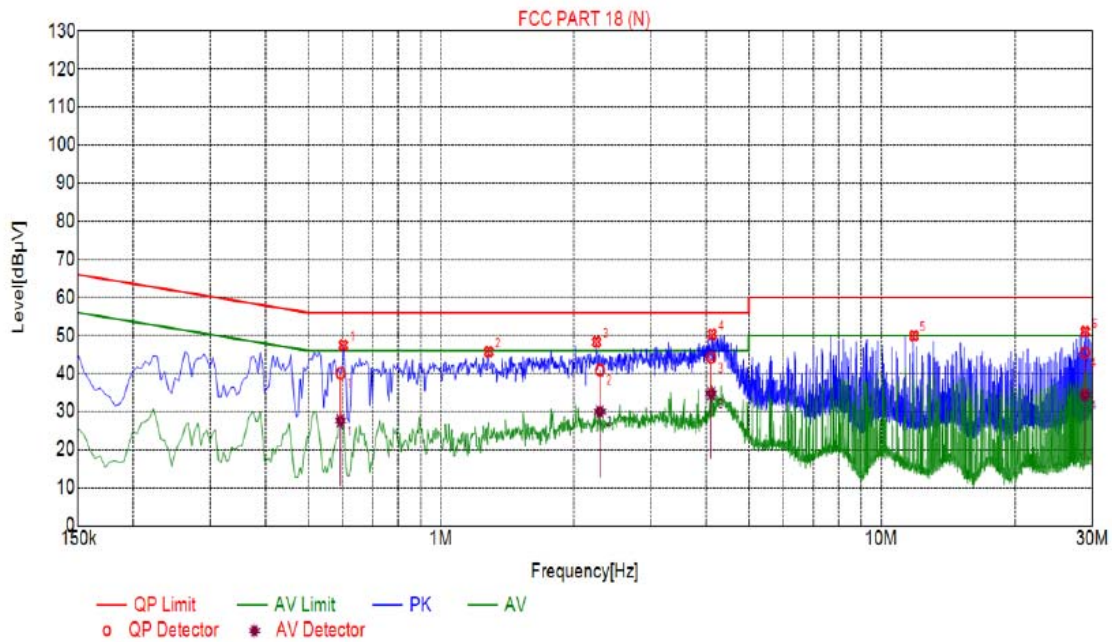

### Suspected List

NO.	Freq. [MHz]	Level [dBµV]	Factor [dB]	Limit [dBµV]	Margin [dB]	Reading [dBµV]	Detector	Type
1	0.6000	47.47	20.05	56.00	8.53	27.42	PK	N
2	1.2840	45.73	20.09	56.00	10.27	25.64	PK	N
3	2.2560	48.29	20.18	56.00	7.71	28.11	PK	N
4	4.1280	50.34	20.25	56.00	5.66	30.09	PK	N
5	11.8680	49.92	19.99	60.00	10.08	29.93	PK	N
6	28.8780	51.02	20.26	60.00	8.98	30.76	PK	N

### Final Data List

NO.	Freq. [MHz]	Correction factor [dB]	QP Value [dBµV]	QP Limit [dBµV]	QP Margin [dB]	QP Reading [dBµV]	AV Value [dBµV]	AV Limit [dBµV]	AV Margin [dB]	AV Reading [dBµV]	Type
1	0.5910	20.05	40.09	56.00	15.91	20.04	27.58	46.00	18.42	7.53	N
2	2.2980	20.18	40.86	56.00	15.14	20.68	29.96	46.00	16.04	9.78	N
3	4.1064	20.25	44.17	56.00	11.83	23.92	34.71	46.00	11.29	14.46	N
4	28.8518	20.26	45.42	60.00	14.58	25.16	34.37	50.00	15.63	14.11	N

Remark: Margin = Limit - Level

Correction factor = Cable lose + LISN insertion loss

Level=Test receiver reading + correction factor

## 4. Radiated Emissions

### 4.1. Block Diagram of Test Setup

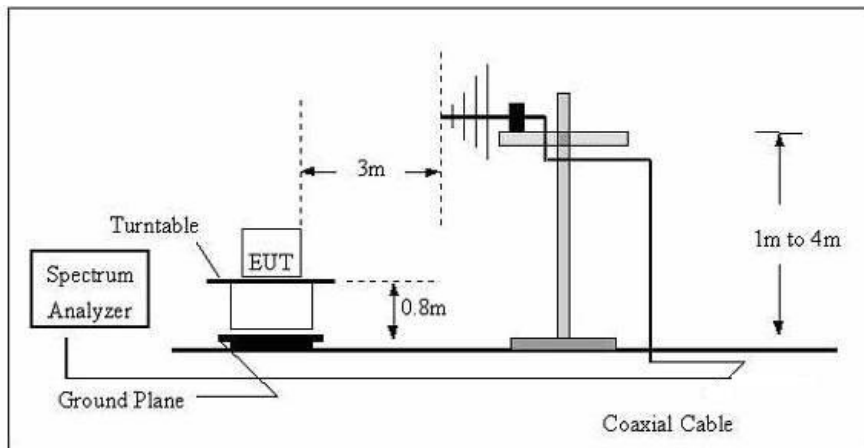
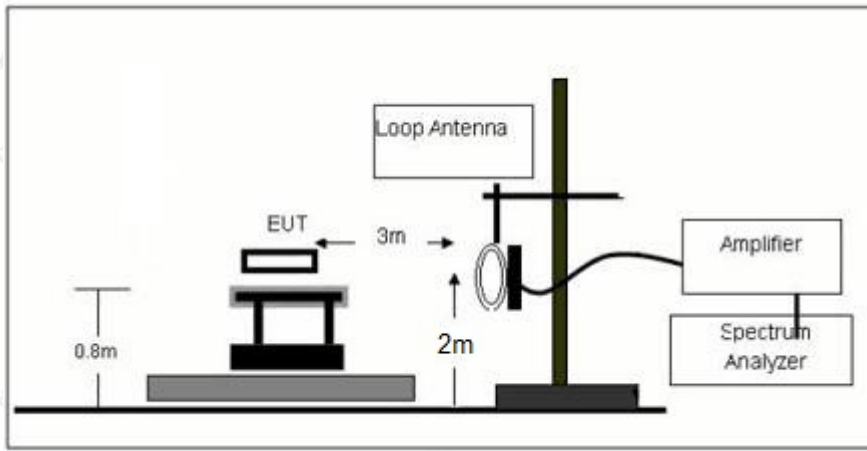



### 4.2. Rules and Specifications

Except as provided elsewhere in this Subpart 18.305 (b), the field strength levels of emissions which lie outside the bands specified in §18.301, unless otherwise indicated, shall not exceed the following table:

Equipment	Operating frequency	RF Power generated by equipment (watts)	Field strength limit (uV/m)	Distance (meters)
(miscellaneous)				
	Any non-ISM frequency	Below 500 500 or more	15 15 × SQRT(power/500)	300 1300

Remark:

- (1) Emission level dBuV/m for 0.009~30MHz = 20log (15) + 40log (300/3) dBuV/m;
- (2) Calculated according FCC 18.305.
- (3) The smaller limit shall apply at the cross point between two frequency bands.
- (4) Distance is the distance in meters between the measuring instrument, antenna and the closest point of any part of the device or system.

### 4.3. Test Procedure

Measurement distance 3m

For the measurement range up to 30MHz in the following plots the field strength result from 3m Distance measurements are extrapolated to 300m and 30m distance respectively, by 40dB/decade, Per antenna factor scaling.

Measurements below 1000MHz are performed with a peak detector and compared to average limits, Measurements with an average detector are not required.

Note:

For battery operated equipment, the equipment tests shall be performed using a new battery.

### 4.4. Test Result

**PASS**

Note: All the test modes completed for test. Only the worst result (ANT 1+ ANT 2) was reported as below:





Mobile phone:

For 9KHz - 30MHz

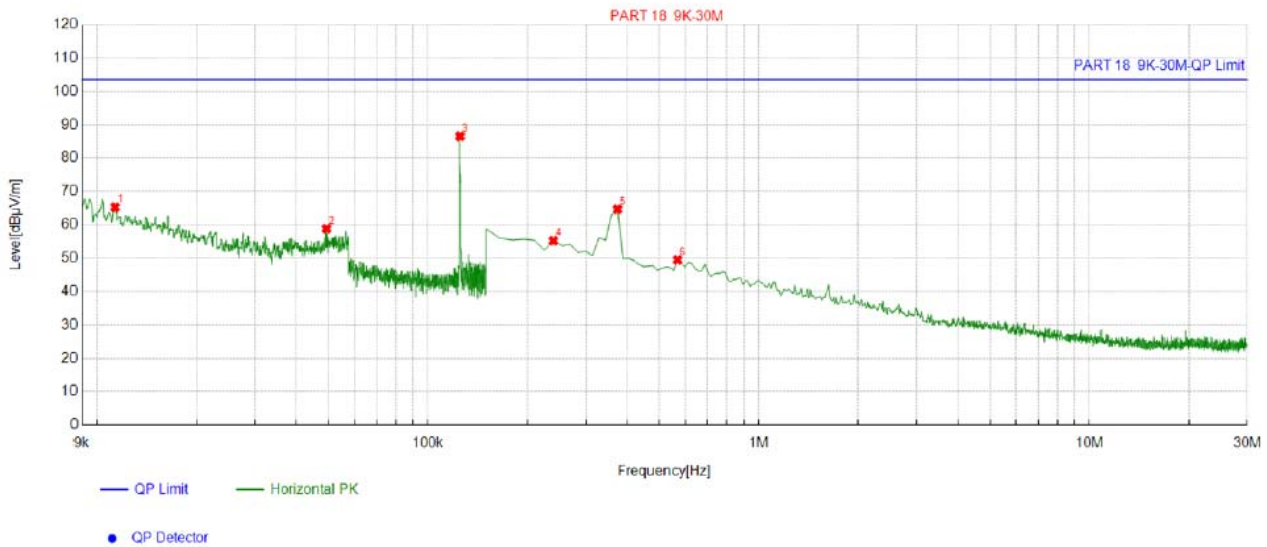

Suspected List						
NO.	Freq. [MHz]	Factor [dB]	Reading [dBµV/m]	Level [dBµV/m]	Limit [dBµV/m]	Margin [dB]
1	0.011328	16.39	48.90	65.29	103.50	38.21
2	0.049346	13.95	44.88	58.83	103.50	44.67
3	0.12496	13.78	72.77	86.55	103.50	16.95
4	0.239595	13.68	41.57	55.25	103.50	48.25
5	0.373987	13.76	50.93	64.69	103.50	38.81
6	0.568109	13.72	35.79	49.51	103.50	53.99

Remark: Factor = Cable loss + Antenna factor – Preamplifier; Level = Reading + Factor; Margin = Limit – Level;





Watch:

For 9KHz - 30MHz

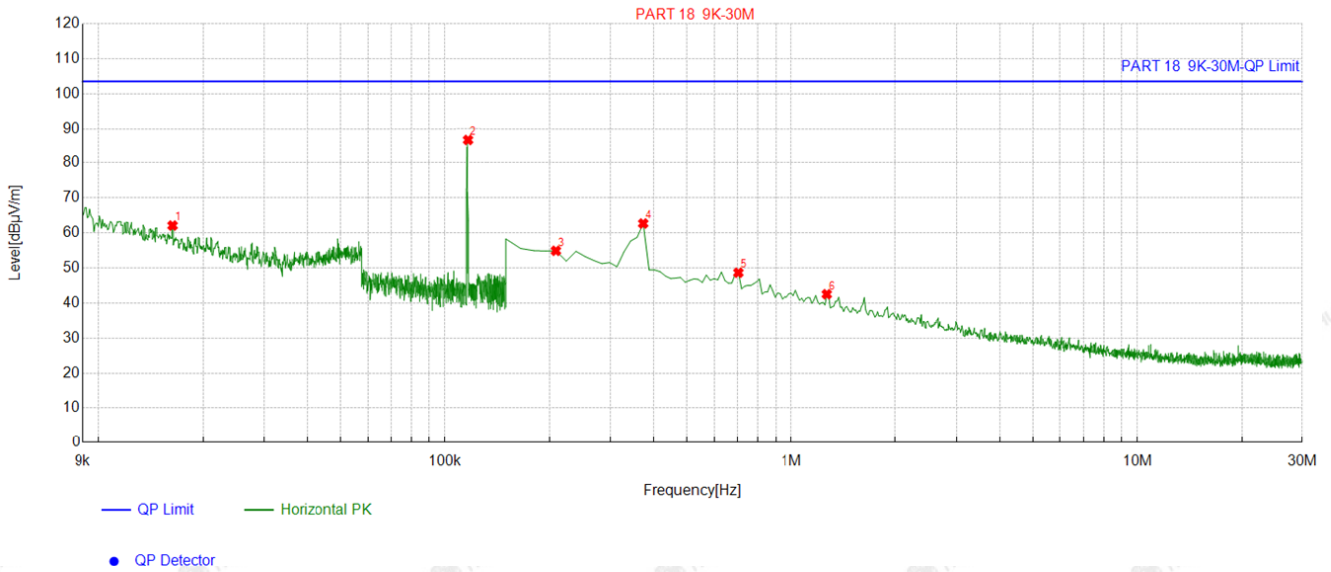

Suspected List						
NO.	Freq. [MHz]	Factor [dB]	Reading [dBµV/m]	Level [dBµV/m]	Limit [dBµV/m]	Margin [dB]
1	0.016336	15.32	46.79	62.11	103.50	41.39
2	0.116425	13.80	73.14	86.94	103.50	16.56
3	0.20973	13.66	41.25	54.91	103.50	48.59
4	0.373987	13.76	48.93	62.69	103.50	40.81
5	0.702501	13.81	34.84	48.65	103.50	54.85
6	1.269935	14.23	28.28	42.51	103.50	60.99

Remark: Factor = Cable loss + Antenna factor – Pre-amplifier; Level = Reading + Factor; Margin = Limit – Level;



For 30MHz-1GHz

Antenna polarity: H



Suspected List									
NO.	Freq. [MHz]	Factor [dB]	Reading [dBµV/m]	Level [dBµV/m]	Limit [dBµV/m]	Margin [dB]	Height [cm]	Angle [°]	Polarity
1	130.91363	-17.35	43.83	26.48	63.50	37.02	100	1	Horizontal
2	190.10336	-17.08	51.36	34.28	63.50	29.22	100	308	Horizontal
3	233.12104	-13.64	54.97	41.33	63.50	22.17	100	299	Horizontal
4	291.66388	-12.26	55.63	43.37	63.50	20.13	100	183	Horizontal
5	323.03767	-11.64	53.79	42.15	63.50	21.35	100	54	Horizontal
6	375.43514	-10.85	47.18	36.33	63.50	27.17	100	348	Horizontal

Remark: Factor = Cable loss + Antenna factor – Preamplifier; Level = Reading + Factor; Margin = Limit – Level;



Antenna polarity: V

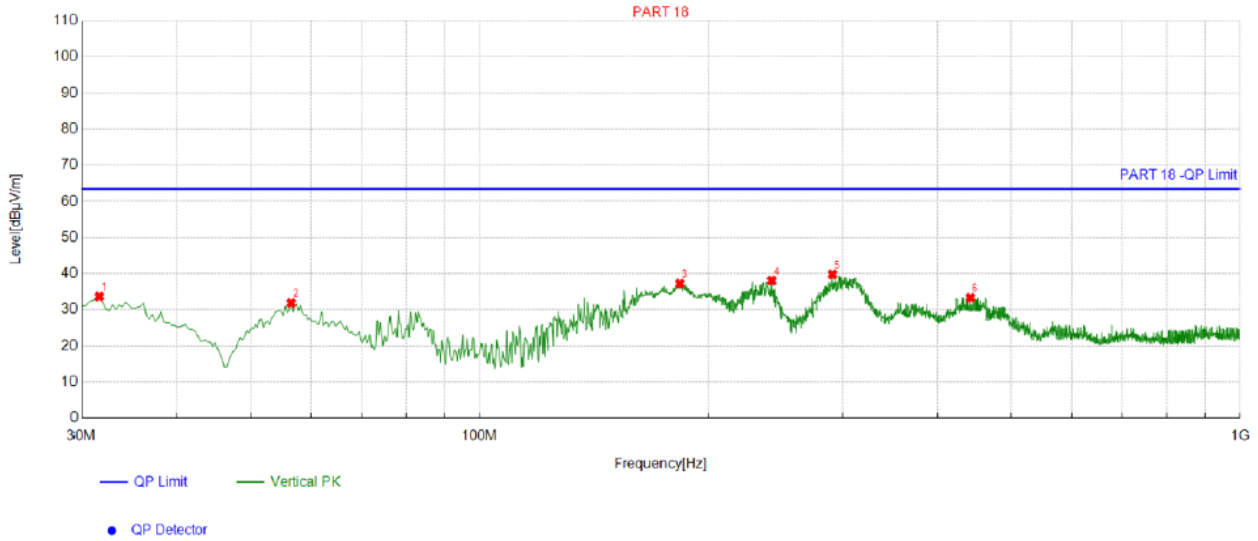

Suspected List									
NO.	Freq. [MHz]	Factor [dB]	Reading [dBµV/m]	Level [dBµV/m]	Limit [dBµV/m]	Margin [dB]	Height [cm]	Angle [°]	Polarity
1	31.617206	-16.65	50.34	33.69	63.50	29.81	100	205	Vertical
2	56.522174	-14.40	46.27	31.87	63.50	31.63	100	219	Vertical
3	183.31110	-16.66	53.92	37.26	63.50	26.24	100	225	Vertical
4	242.17739	-13.29	51.37	38.08	63.50	25.42	100	182	Vertical
5	291.01700	-12.29	52.08	39.79	63.50	23.71	100	282	Vertical
6	441.74058	-8.47	41.82	33.35	63.50	30.15	100	22	Vertical

Remark: Factor = Cable loss + Antenna factor – Preamplifier; Level = Reading + Factor; Margin = Limit – Level;



## 5. Antenna Requirement

### Refer to statement below for compliance.

The manufacturer may design the unit so that the user can replace a broken antenna, but the use of a standard antenna jack or electrical connector is prohibited. Further, this requirement does not apply to intentional radiators that must be professionally installed.

### Antenna Connected Construction

The antenna used in this product is a Coil Antenna, which permanently attached. It conforms to the standard requirements. The directional gains of antenna used for transmitting is 0dBi.

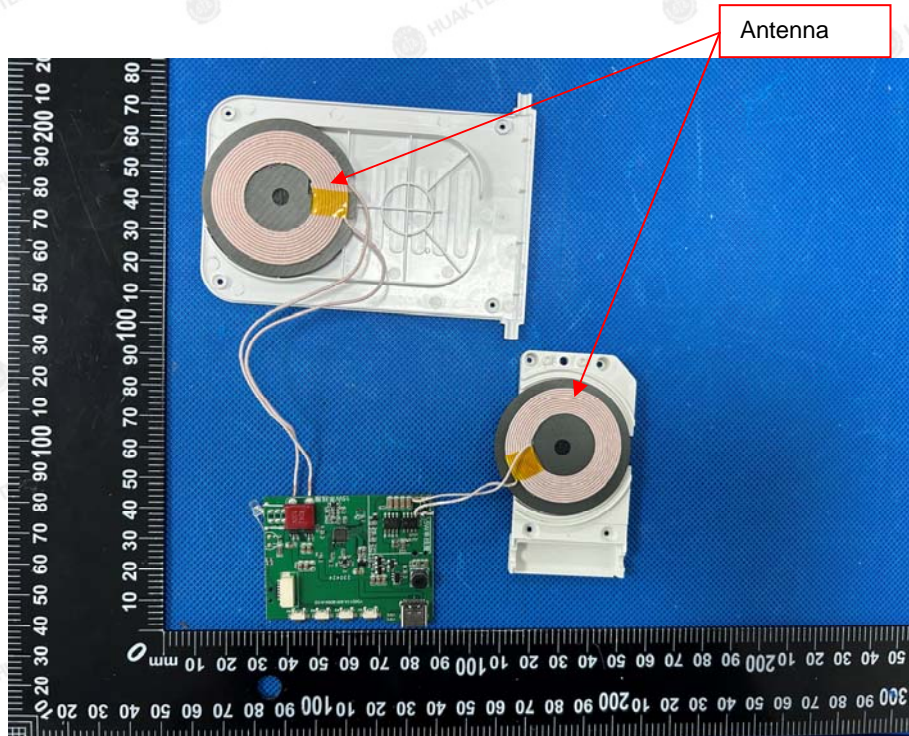





## 6. Photographs of Test

### Radiated Emission

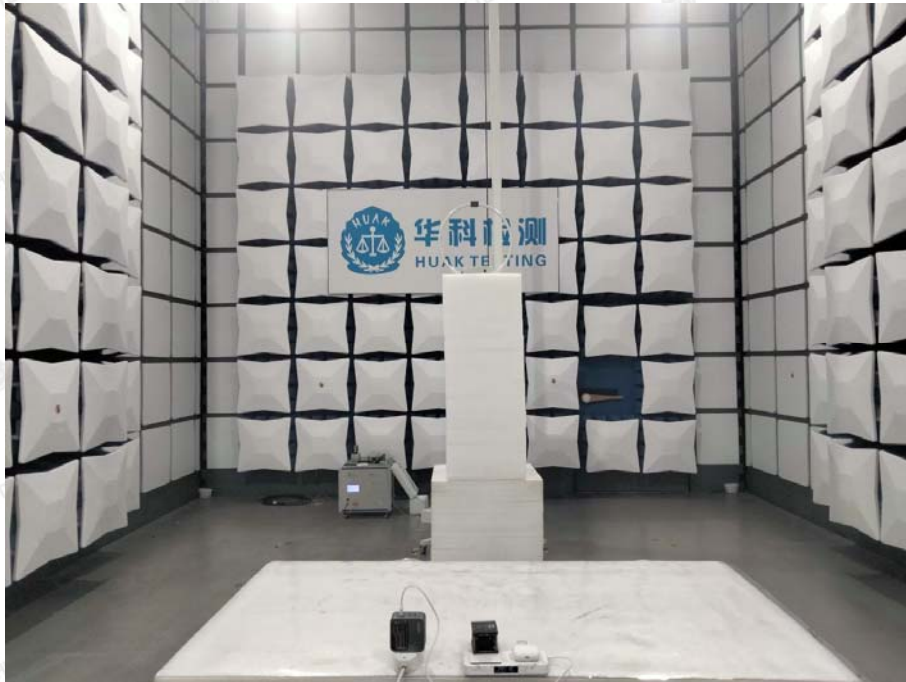
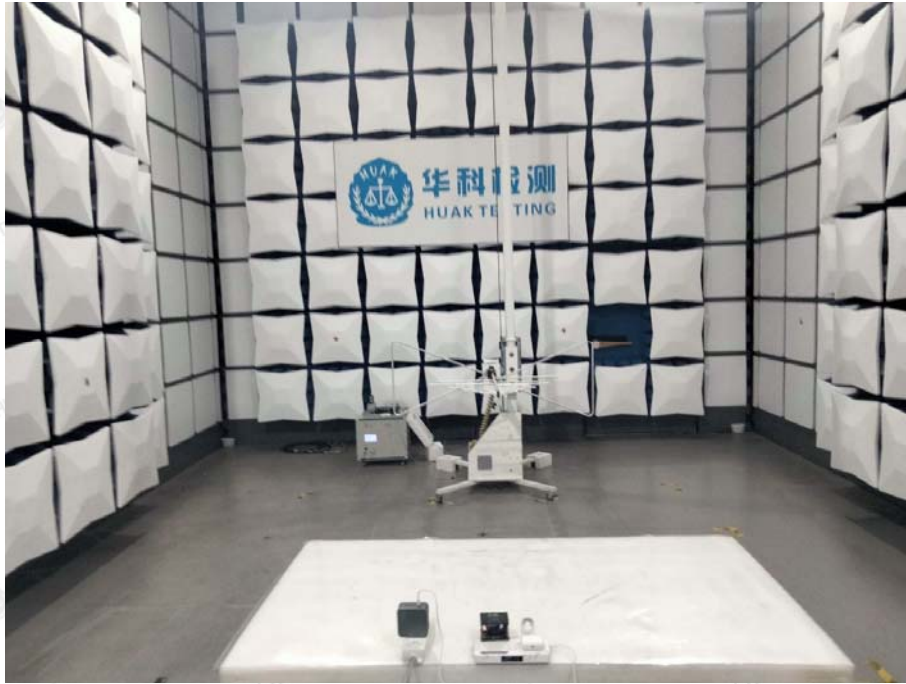

The results shown in this test report refer only to the sample(s) tested unless otherwise stated and the sample(s) are retained for 30 days only. The document is issued by HUAK, this document cannot be reproduced except in full with our prior written permission. The more details and the authenticity of the report will be confirmed at <http://www.cer-mark.com>.

TEL : +86-755 2302 9901 FAX : +86-755 2302 9901 E-mail : [service@cer-mark.com](mailto:service@cer-mark.com)

Addr: 1-2F., Building B2, Junfeng Zhongcheng Zhizao Innovation Park, Heping Community, Fuhai Street, Bao'an District, Shenzhen, Guangdong, China



### Conducted Emission

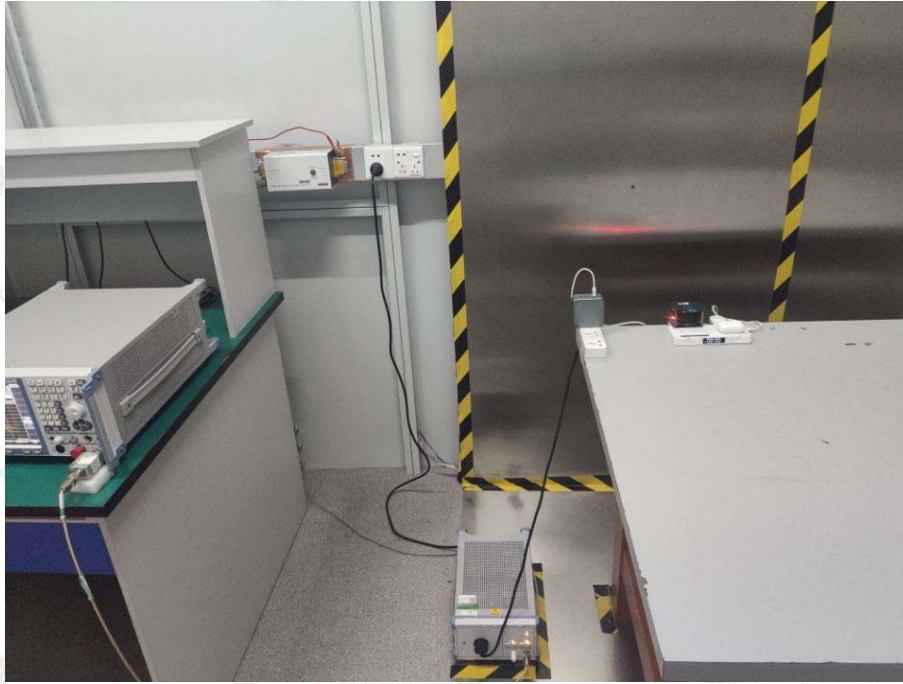

The results shown in this test report refer only to the sample(s) tested unless otherwise stated and the sample(s) are retained for 30 days only. The document is issued by HUAK, this document cannot be reproduced except in full with our prior written permission. The more details and the authenticity of the report will be confirmed at <http://www.cer-mark.com>.

TEL : +86-755 2302 9901    FAX : +86-755 2302 9901    E-mail : [service@cer-mark.com](mailto:service@cer-mark.com)

Addr: 1-2F., Building B2, Junfeng Zhongcheng Zhizao Innovation Park, Heping Community, Fuhai Street, Bao'an District, Shenzhen, Guangdong, China



## 7. Photos of the EUT

Reference to the report: ANNEX A of external photos and ANNEX B of internal photos.

-----End of test report-----

QUALIFICATION