

TEST REPORT



Applicant:	Huizhou huayusi Technology Co., Ltd		
Address:	No.02,6th Floor, Technology Center Building, Lixin Road, Zhongkai High-tech Zone, Huizhou city ,Guangdong, China		
Manufacturer:	Huizhou huayusi Technology Co., Ltd		
Address:	No.02,6th Floor, Technology Center Building, Lixin Road, Zhongkai High-tech Zone, Huizhou city ,Guangdong, China		
Factory:	Huizhou Coomaer Technology Co., Ltd		
Address:	3 Floor B block, Number 5 building,East of first road, Industrial base of tongqiao town,Zhongkai high-tech area,Huizhou city Guangdong China.		
E.U.T.:	SOUNDBAR		
Model Number:	ST-61, ST-63		
Test Model:	ST-61		
Trade mark:	COOMAER		
FCC ID:	2BBOI-ST61		
Date of Receipt:	Feb 27, 2024	Date of Test:	Feb 27, 2024- Mar 08, 2024
Test Specification:	FCC 47 CFR Part 15, Subpart C		
Test Result:	The equipment under test was found to be compliance with the requirements of the standards applied.		
Prepared by:	Approved & Authorized Signer:		
			
Jerry Hu/ Engineer	Frank Shen/ Manager		
	Issue Date: March 12, 2024		
This test report is based on a single evaluation of one sample of above mentioned products. It is not permitted to be duplicated in extracts without written approval of Dongguan Lepont Service Co., Ltd.			

TABLE OF CONTENTS

1. GENERAL PRODUCT INFORMATION	4
1.1. PRODUCT FUNCTION.....	4
1.2. EUT TECHNICAL DESCRIPTION.....	4
1.3. INDEPENDENT OPERATION MODES	5
2. TEST STANDARDS AND SITES	6
2.1. DESCRIPTION OF STANDARDS AND RESULTS.....	6
2.2. LIST OF TEST AND MEASUREMENT INSTRUMENTS	7
2.3. MEASUREMENT UNCERTAINTY	8
2.4. TEST FACILITY.....	8
3. SETUP OF EQUIPMENT UNDER TEST	9
3.1. RADIO FREQUENCY TEST SETUP 1	9
3.2. RADIO FREQUENCY TEST SETUP 2.....	9
3.3. CONDUCTED EMISSION TEST SETUP.....	11
3.4. BLOCK DIAGRAM CONFIGURATION OF TEST SYSTEM	11
3.5. SUPPORT EQUIPMENT	12
4. TEST RESULTS AND MEASUREMENT DATA	13
4.1. 20DB BANDWIDTH	13
4.2. CARRIER FREQUENCY SEPARATION	19
4.3. NUMBER OF HOPPING FREQUENCIES	25
4.4. AVERAGE TIME OF OCCUPANCY (DWELL TIME).....	28
4.5. MAXIMUM PEAK CONDUCTED OUTPUT POWER	36
4.6. RADIATED SPURIOUS EMISSION.....	42
4.7. CONDUCTED EMISSION TEST	59
4.8. ANTENNA APPLICATION	63

1. GENERAL PRODUCT INFORMATION

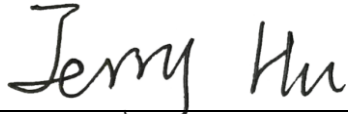
1.1. PRODUCT FUNCTION

Refer to Technical Construction Form and User Manual.

1.2. EUT TECHNICAL DESCRIPTION

Product Name:	SOUNDBAR
Model No.:	ST-61,ST-63
Test Model No:	ST-61
<i>Remark: All above models are identical in the same PCB layout, interior structure and electrical circuits. The differences are model name for commercial purpose.</i>	
Test sample(s) ID:	LP23080282C01-05-S009
Sample(s) Status	Engineer sample
Operation Frequency:	2402MHz-2480MHz
Channel numbers:	79
Channel separation:	1MHz
Modulation type:	GFSK, $\pi/4$ -DQPSK, 8DPSK
Antenna Type:	PCB Antenna
Antenna gain:	-0.58dBi
Power supply:	DC 5V From Charging; DC 3.7V From Battery

1.3. INDEPENDENT OPERATION MODES

The EUT has been tested under its typical operating condition.

The EUT configuration for testing is installed on RF field strength measurement to meet the Commissions requirement and operating in a manner which intends to maximize its emission characteristics in a continuous normal application.

The Transmitter was operated in the normal operating mode. The TX frequency was fixed which was for the purpose of the measurements.

Test of channel included the lowest and middle and highest frequency to perform the test, then record on this report.

Those data rates (1Mbps for GFSK modulation; 2Mbps for pi/4-DQPSK modulation; 3Mbps for 8DPSK modulation) were used for all test.

Pre-defined engineering program for regulatory testing used to control the EUT for staying in continuous transmitting and receiving mode is programmed.

The report shows only the worst data

Frequency and Channel list:

Channel No.	Frequency (MHz)	Channel No.	Frequency (MHz)	Channel No.	Frequency (MHz)	Channel No.	Frequency (MHz)
1	2402	2	2403	3	2404	4	2405
5	2406	6	2407	7	2408	8	2409
9	2410	10	2411	11	2412	12	2413
13	2414	14	2415	15	2416	16	2417
17	2418	18	2419	19	2420	20	2421
21	2422	22	2423	23	2424	24	2425
25	2426	26	2427	27	2428	28	2429
29	2430	30	2431	31	2432	32	2433
33	2434	34	2435	35	2436	36	2437
37	2438	38	2439	39	2440	40	2441
41	2442	42	2443	43	2444	44	2445
45	2446	46	2447	47	2448	48	2449
49	2450	50	2451	51	2452	52	2453
53	2454	54	2455	55	2456	56	2457
57	2458	58	2459	59	2460	60	2461
61	2462	62	2463	63	2464	64	2465
65	2466	66	2467	67	2468	68	2469
69	2470	70	2471	71	2472	72	2473
73	2474	74	2475	75	2476	76	2477
77	2478	78	2479	79	2480	-	-

2. TEST STANDARDS AND SITES

2.1. DESCRIPTION OF STANDARDS AND RESULTS

The EUT have been tested according to the applicable standards as referenced below.

FCC Part Clause	Test Parameter	Verdict	Remark
15.247(a)(1)	20 dB Bandwidth	PASS	
15.247(a)(1)	Carrier Frequency Separation	PASS	
15.247(a)(1)	Number of Hopping Frequencies	PASS	
15.247(a)(1)	Average Time of Occupancy (Dwell Time)	PASS	
15.247(b)(1)	Maximum Peak Conducted Output Power	PASS	
15.247(d) 15.209	Radiated Spurious Emissions	PASS	
15.207	Conducted Emission	PASS	
15.203	Antenna Application	PASS	
15.247 (a) (1)/g/h	Frequency Hopping System	PASS	

NOTE1: N/A (Not Applicable)

NOTE2: According to FCC KDB 558074 D01 15.247 Meas Guidance v05r02, the report use radiated measurements in the restricted frequency bands. In addition, the radiated test is also performed to ensure the emissions emanating from the device cabinet also comply with the applicable limits.

RELATED SUBMITTAL(S) / GRANT(S):

This submittal(s) (test report) is intended for FCC ID: 2BBOI-ST61 filing to comply with Section 15.247 of the FCC Part 15, Subpart C Rules.

2.2. LIST OF TEST AND MEASUREMENT INSTRUMENTS

For radiated(9K-30M) emission test(966 Chamber 1)							
Equipment	Manufacturer	Model No.	Serial No.	Last Cal.	Cal. Interval	Lab No.	Remark
EMI Test Receiver	Rohde & Schwarz	ESR 3	101849	Feb. 14, 2024	1 Year	LEP-E006	<input type="checkbox"/>
Loop Antenna	Schwarzbeck	FMZB1519B	1519B-036	Feb. 14, 2024	3 Year	LEP-E068	<input type="checkbox"/>
966 Chamber 1	MR	MR-L02	LEP-E051	Nov. 17, 2022	3 Year	LEP-E051	<input type="checkbox"/>
Test software	EZ-EMC	Fala	EMEC-3A1	N/A	N/A	N/A	<input type="checkbox"/>
For radiated(30M-1G) emission test(966 Chamber 1)							
Equipment	Manufacturer	Model No.	Serial No.	Last Cal.	Cal. Interval	Lab No.	Remark
EMI Test Receiver	Rohde & Schwarz	ESR 3	101849	Feb. 14, 2024	1 Year	LEP-E006	<input checked="" type="checkbox"/>
TRILOG Broadband Antenna	Schwarzbeck	VULB 9163	743	Nov. 20, 2022	3 Year	LEP-E005	<input checked="" type="checkbox"/>
Signal Amplifier	HP	8447D	1726A01222	Feb. 14, 2024	1 Year	LEP-E007	<input checked="" type="checkbox"/>
6dB Attenuator	RswTech	5W 6dB	LEP-E084	Feb. 14, 2024	1 Year	LEP-E084	<input checked="" type="checkbox"/>
966 Chamber 1	MR	MR-L02	LEP-E051	Nov. 17, 2022	3 Year	LEP-E051	<input checked="" type="checkbox"/>
Test software	EZ-EMC	Fala	EMEC-3A1	N/A	N/A	N/A	<input checked="" type="checkbox"/>
For radiated(1-18G) emission test(966 Chamber 1)							
Equipment	Manufacturer	Model No.	Serial No.	Last Cal.	Cal. Interval	Lab No.	Remark
Spectrum analyzer	Rohde & Schwarz	FSV40	101412	Feb. 14, 2024	1 Year	LEP-E076	<input checked="" type="checkbox"/>
Spectrum analyzer	Agilent	N9020A	MY49100060	Feb. 14, 2024	1 Year	LEP-E020	<input checked="" type="checkbox"/>
Horn antenna	Schwarzbeck	BBHA 9120D	01875	Nov. 20, 2022	3 Year	LEP-E024	<input checked="" type="checkbox"/>
Preamplifier	Schwarzbeck	BBN 9718B	00010	Mar. 06, 2024	1 Year	LEP-E025	<input checked="" type="checkbox"/>
966 Chamber 1	MR	MR-L02	LEP-E051	Nov. 17, 2022	3 Year	LEP-E051	<input checked="" type="checkbox"/>
Test software	EZ-EMC	Fala	EMEC-3A1	N/A	N/A	N/A	<input checked="" type="checkbox"/>
For radiated(18-40G) emission test(966 Chamber 1)							
Equipment	Manufacturer	Model No.	Serial No.	Last Cal.	Cal. Interval	Lab No.	Remark
Spectrum analyzer	Rohde & Schwarz	FSV40	101412	Feb. 14, 2024	1 Year	LEP-E076	<input checked="" type="checkbox"/>
Horn antenna+Preamplifier	COM-POWER	AH840	10100020	Sep. 05, 2022	3 Year	LEP-E075	<input checked="" type="checkbox"/>
966 Chamber 1	MR	MR-L02	LEP-E051	Nov. 17, 2022	3 Year	LEP-E051	<input checked="" type="checkbox"/>
Test software	EZ-EMC	Fala	EMEC-3A1	N/A	N/A	N/A	<input checked="" type="checkbox"/>
For radiated(30M-1G) emission test(966 Chamber 2)							
Equipment	Manufacturer	Model No.	Serial No.	Last Cal.	Cal. Interval	Lab No.	Remark
EMI Test Receiver	Rohde & Schwarz	ESPI 3	101059	Feb. 14, 2024	1 Year	LEP-E054	<input type="checkbox"/>
TRILOG Broadband Antenna	Schwarzbeck	VULB 9163	743	Nov. 20, 2022	3 Year	LEP-E049	<input type="checkbox"/>
966 Chamber 2	MR	MR-L06	LEP-E052	Nov. 17, 2022	3 Year	LEP-E052	<input type="checkbox"/>
Test software	EZ-EMC	Fala	EMEC-3A1	N/A	N/A	N/A	<input type="checkbox"/>
For RF test							
Equipment	Manufacturer	Model No.	Serial No.	Last Cal.	Cal. Interval	Lab No.	Remark
Spectrum analyzer	Rohde & Schwarz	FSV40	101412	Feb. 14, 2024	1 Year	LEP-E076	<input checked="" type="checkbox"/>
Spectrum analyzer	Agilent	N9020A	MY49100060	Feb. 14, 2024	1 Year	LEP-E020	<input checked="" type="checkbox"/>
Vector source	Agilent	N5182A	MY47420382	Feb. 14, 2024	1 Year	LEP-E021	<input checked="" type="checkbox"/>
Analog signal source	Agilent	N5171B	MY51350292	Feb. 14, 2024	1 Year	LEP-E022	<input checked="" type="checkbox"/>
All instrument	Rohde & Schwarz	CMW 500	1201.002K50	Feb. 14, 2024	1 Year	LEP-E019	<input checked="" type="checkbox"/>
High and low temperature chamber	Math-mart	MT-1202-40	LEP-E041	Feb. 14, 2024	1 Year	LEP-E041	<input checked="" type="checkbox"/>
control unit	Tonscend	JS0806-2	10165	Feb. 14, 2024	1 Year	LEP-E034	<input checked="" type="checkbox"/>
Testing software	Tonscend	JSTS1120-3	Ver 2.6.77.0518	N/A	N/A	N/A	<input checked="" type="checkbox"/>

2.3. MEASUREMENT UNCERTAINTY

The following measurement uncertainty levels have been estimated for tests performed on the apparatus:

Parameter	Uncertainty
Radio Frequency	$\pm 1 \times 10^{-5}$
Maximum Peak Output Power Test	$\pm 1.0\%$
Conducted Emissions Test	$\pm 3.08\text{dB}$
Radiated Emission Test	$\pm 4.60\text{dB}$
Power Density	$\pm 0.9\%$
Occupied Bandwidth Test	$\pm 2.3\%$
Band Edge Test	$\pm 1.2\%$
Antenna Port Emission	$\pm 3\text{dB}$
Temperature	$\pm 3.2\%$
Humidity	$\pm 2.5\%$
Measurement Uncertainty for a level of Confidence of 95%	

2.4. TEST FACILITY

EMC Lab. : The Laboratory has been assessed and proved to be in compliance with CNAS/CL01
The Certificate Registration Number is L10100.
The Laboratory has been assessed and proved to be in compliance with A2LA
The Certificate Registration Number is 6901.01
FCC Designation No.: CN1351
Test Firm Registration No.: 397428
ISED CAB identifier: CN0151
Test Firm Registration No.: 20133

Test Location : Dongguan Lepont Testing Service Co., Ltd.

Address : Room 102, Building 11, No.7, Houjie Science And Technology Avenue, Houjie, Dongguan, Guangdong, China

3. SETUP OF EQUIPMENT UNDER TEST

3.1. RADIO FREQUENCY TEST SETUP 1

The Bluetooth V5.1 component's antenna ports(s) of the EUT are connected to the measurement instrument per an appropriate attenuator. The EUT is controlled by PC/software to emit the specified signals for the purpose of measurements.

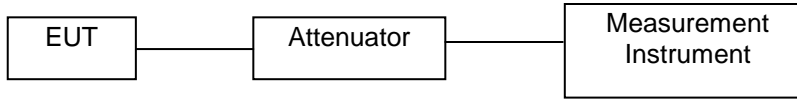

3.2. RADIO FREQUENCY TEST SETUP 2

The test site semi-anechoic chamber has met the requirement of NSA tolerance 4 dB according to the standards: ANSI C63.10. The test distance is 3m. The setup is according to the requirements in Section 13.1.4.1 of ANSI C63.10-2013 and CAN/CSA-CEI/IEC CISPR 32.

Below 30MHz:

The EUT is placed on a turntable 0.8meters above the ground in the chamber, 3 meter away from the antenna (loop antenna). The Antenna should be positioned with its plane vertical at the specified distance from the EUT and rotated about its vertical axis for maximum response at each azimuth about the EUT. The center of the loop shall be 1 m above the ground. For certain applications, the loop antenna plane may also need to be positioned horizontally at the specified distance from the EUT.

Above 30MHz:

The EUT is placed on a turntable 0.8meters above the ground in the chamber, 3 meter away from the antenna. The maximal emission value is acquired by adjusting the antenna height, polarisation and turntable azimuth. Normally, the height range of antenna is 1 m to 4 m, the azimuth range of turntable is 0° to 360°, and the receive antenna has two polarizations Vertical (V) and Horizontal (H).

Above 1GHz:

(Note: the FCC's permission to use 1.5m as an alternative per TCBC Conf call of Dec. 2, 2014.)

The EUT is placed on a turntable 1.5 meters above the ground in the chamber, 3 meter away from the antenna. The maximal emission value is acquired by adjusting the antenna height, polarisation and turntable azimuth. Normally, the height range of antenna is 1 m to 4 m, the azimuth range of turntable is 0° to 360°, and the receive antenna has two polarizations Vertical (V) and Horizontal (H).

(a) Radiated Emission Test Set-Up, Frequency Below 30MHz

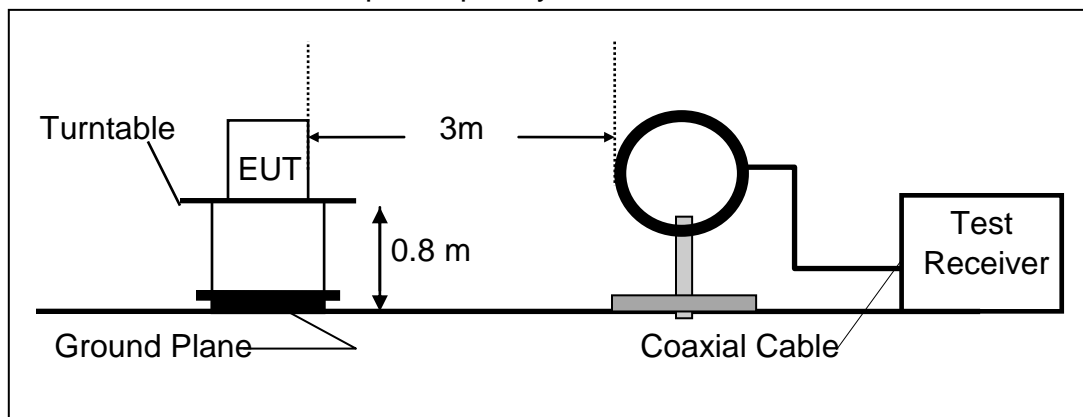

(b) Radiated Emission Test Set-Up, Frequency Below 1000MHz

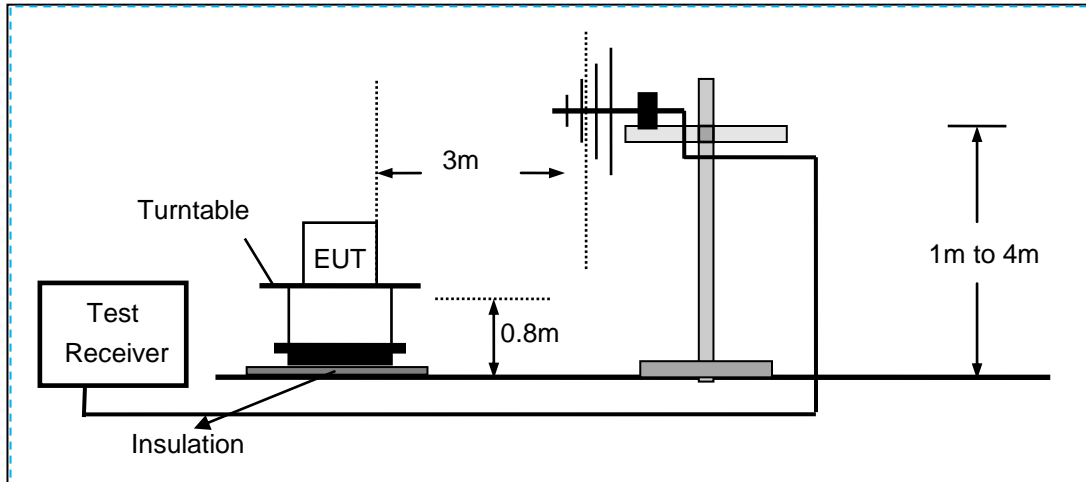

(c) Radiated Emission Test Set-Up, Frequency above 1000MHz

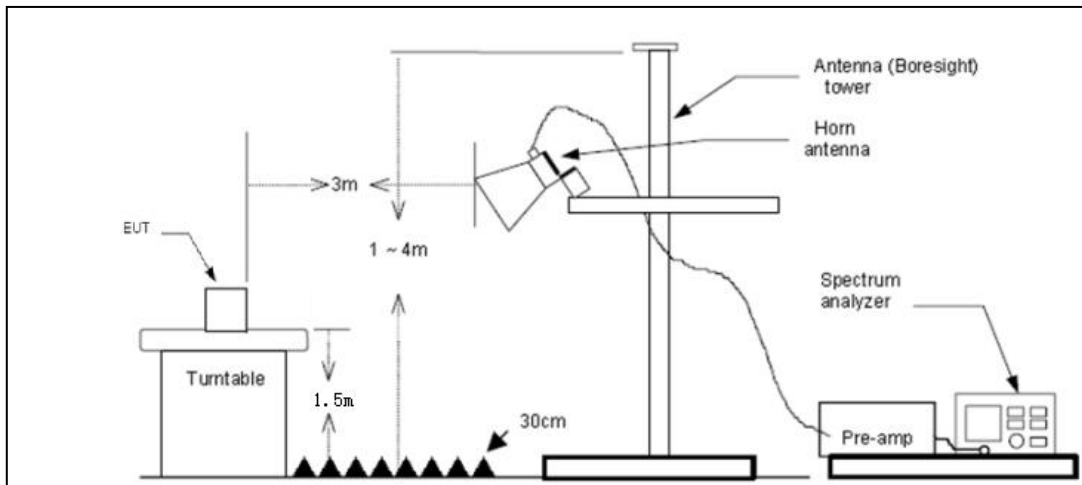

3.3. CONDUCTED EMISSION TEST SETUP

The mains cable of the EUT (Perfect Share Mini) must be connected to LISN. The LISN shall be placed 0.8m from the boundary of EUT and bonded to a ground reference plane for LISN mounted on top of the ground reference plane. This distance is between the closest points of the LISN and the EUT. All other units of the EUT and associated equipment shall be at least 0.8m from the LISN.

Ground connections, where required for safety purposes, shall be connected to the reference ground point of the LISN and, where not otherwise provided or specified by the manufacturer, shall be of same length as the mains cable and run parallel to the mains connection at a separation distance of not more than 0.8m.

According to the requirements in Section 13.1.4.1 of ANSI C63.10-2013 Conducted emissions from the EUT measured in the frequency range between 0.15 MHz and 30 MHz using CISPR Quasi-Peak and average detector mode.

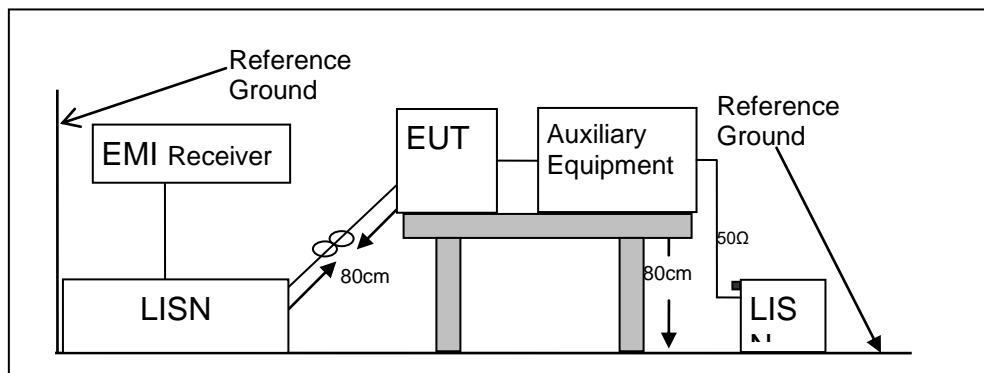

3.4. BLOCK DIAGRAM CONFIGURATION OF TEST SYSTEM

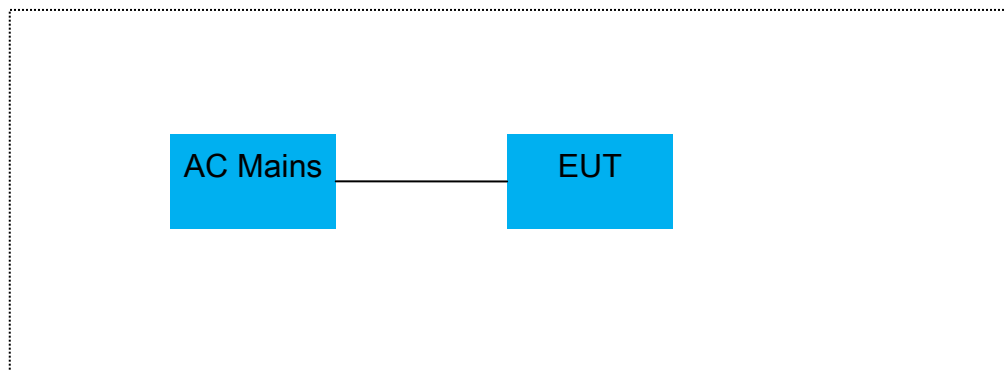

3.5. SUPPORT EQUIPMENT

EUT Cable List and Details			
Cable Description	Length (m)	Shielded/Unshielded	With / Without Ferrite

Auxiliary Cable List and Details			
Cable Description	Length (m)	Shielded/Unshielded	With / Without Ferrite

Auxiliary Equipment List and Details			
Description	Manufacturer	Model	Serial Number
Laptop computer	Lenovo	Xiaoxin Pro IA5HR	PF490VB0
ADAPTER	Xiao mi	/	5V2A

Notes:

- 1.All the equipment/cables were placed in the worst-case configuration to maximize the emission during the test.*
- 2.Grounding was established in accordance with the manufacturer's requirements and conditions for the intended use.*

4. TEST RESULTS AND MEASUREMENT DATA

4.1. 20DB BANDWIDTH

4.1.1. Applicable Standard

According to FCC Part 15.247(a)(1) and KDB 558074 D01 15.247 MEAS GUIDANCE v05r02.

4.1.2. Conformance Limit

No limit requirement.

4.1.3. Test Configuration

Test according to clause 6.1 radio frequency test setup 1

4.1.4. Test Procedure

The EUT was operating in Bluetooth V5.1 mode and controlled its channel. Printed out the test result from the spectrum by hard copy function.

The RF output of EUT was connected to the spectrum analyzer by RF cable and attenuator. The path loss was compensated to the results for each measurement.

Set to the maximum power setting and enable the EUT transmit continuously

Set RBW = 30 kHz.

Set the video bandwidth (VBW) =100 kHz.

Set Span= approximately 2 to 3 times the 20 dB bandwidth

Set Detector = Peak.

Set Trace mode = max hold.

Set Sweep = auto couple.

The EUT should be transmitting at its maximum data rate. Allow the trace to stabilize. Use the marker-to-peak function to set the marker to the peak of the emission. Use the marker-delta function to measure 20 dB down one side of the emission. Reset the markerdelta function, and move the marker to the other side of the emission, until it is (as close as possible to) even with the reference marker level. The marker-delta reading at this point is the 20 dB bandwidth of the emission.

If this value varies with different modes of operation (e.g., data rate, modulation format, etc.), repeat this test for each variation.

Measure and record the results in the test report.

Test Results:

Modulation Mode	Channel Number	Channel Frequency (MHz)	Measurement Bandwidth (MHz)	Limit (MHz)	Verdict
GFSK	1	2402	0.861	N/A	PASS
	40	2441	0.859	N/A	PASS
	79	2480	0.851	N/A	PASS
8DPSK	1	2402	1.213	N/A	PASS
	40	2441	1.211	N/A	PASS
	79	2480	1.212	N/A	PASS

Note: N/A (Not Applicable) Through Pre-scan, find the DH5 of data type is the worst case of GFSK modulation type, 3-DH5 of data type is the worst case of 8DPSK modulation type. Only the worst case is recorded in the report.

Test Model 20dB Bandwidth
Channel 1: 2402MHz GFSK Modulation

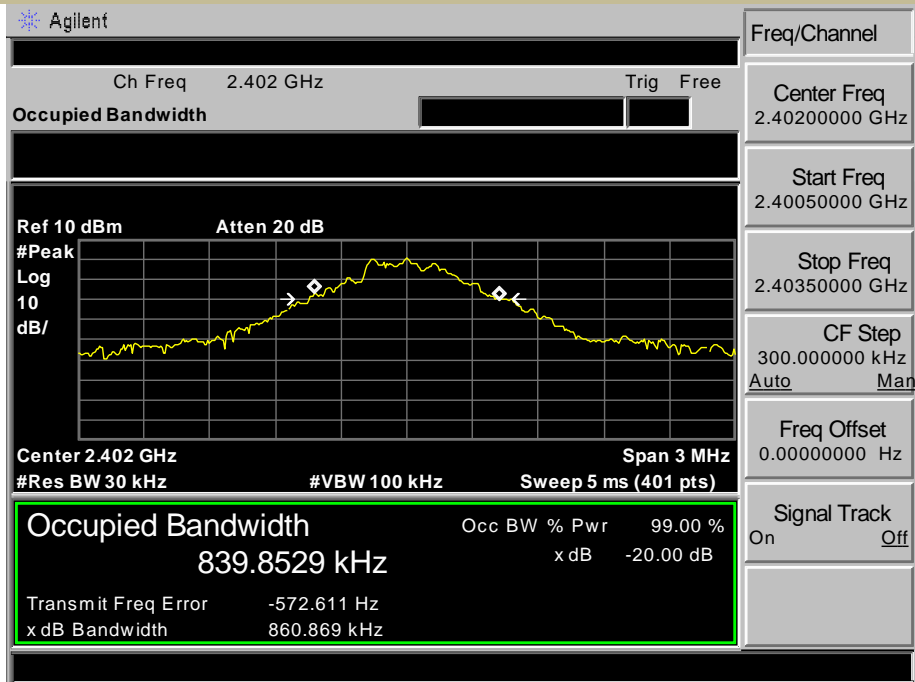

Test Model 20dB Bandwidth
Channel 40: 2441MHz GFSK Modulation

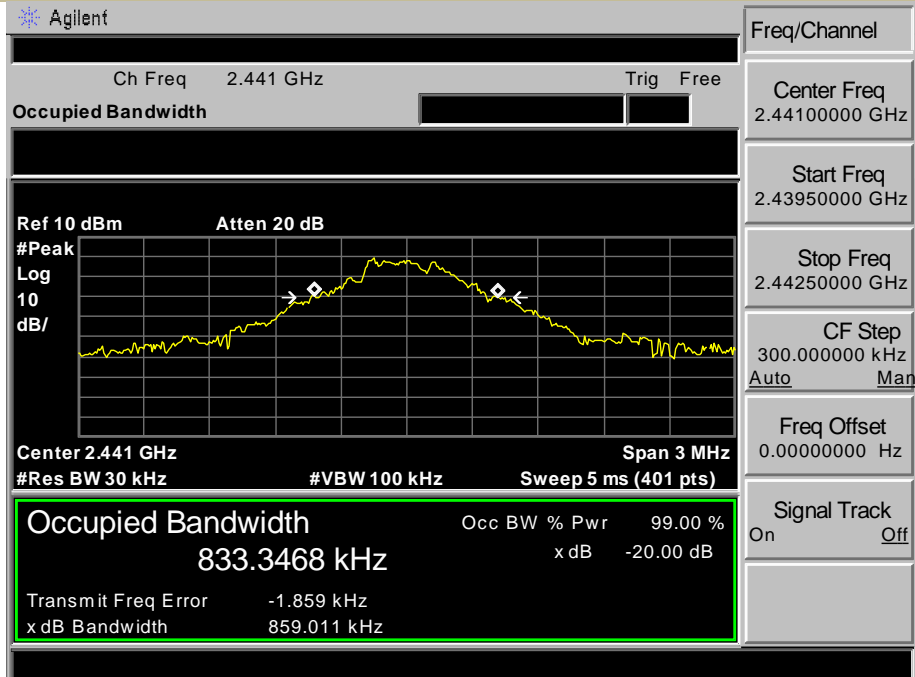

Test Model 20dB Bandwidth
Channel 79: 2480MHz GFSK Modulation

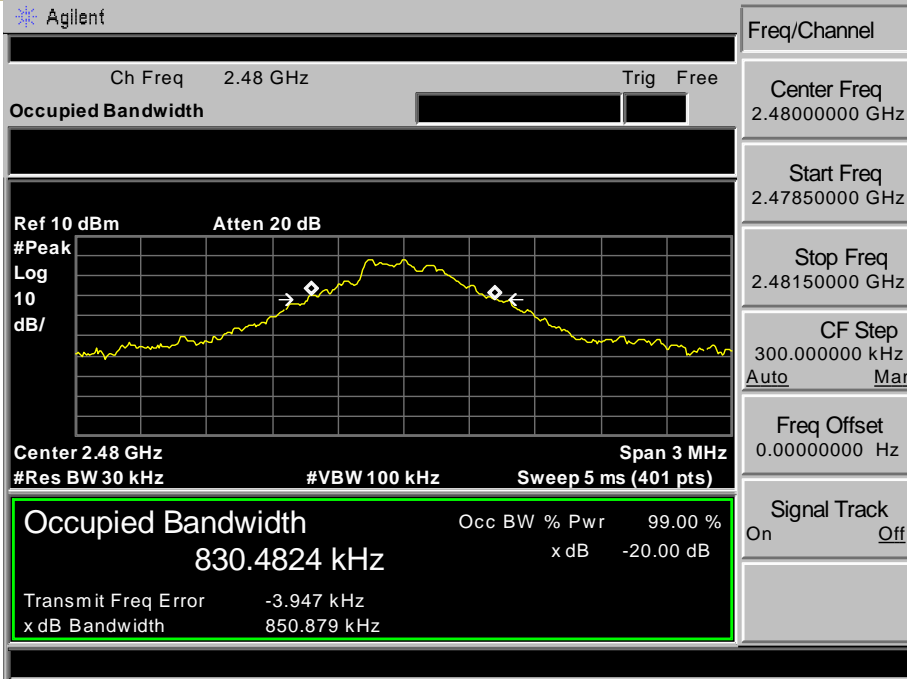

Test Model 20dB Bandwidth
Channel 1: 2402MHz 8DPSK Modulation

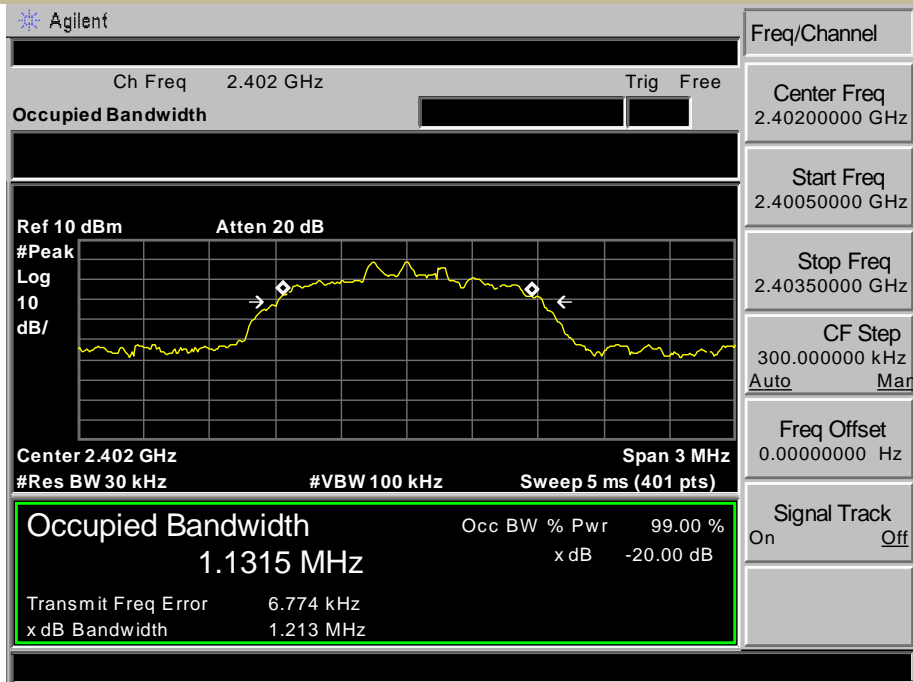

Test Model 20dB Bandwidth
Channel 40: 2441MHz 8DPSK Modulation

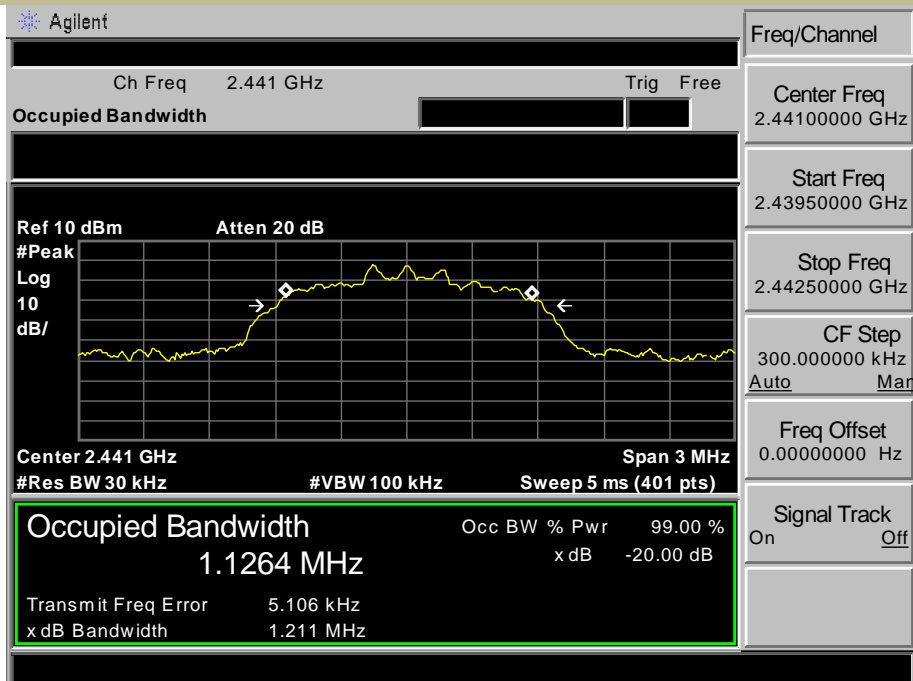

Test Model 20dB Bandwidth
Channel 79: 2480MHz 8DPSK Modulation

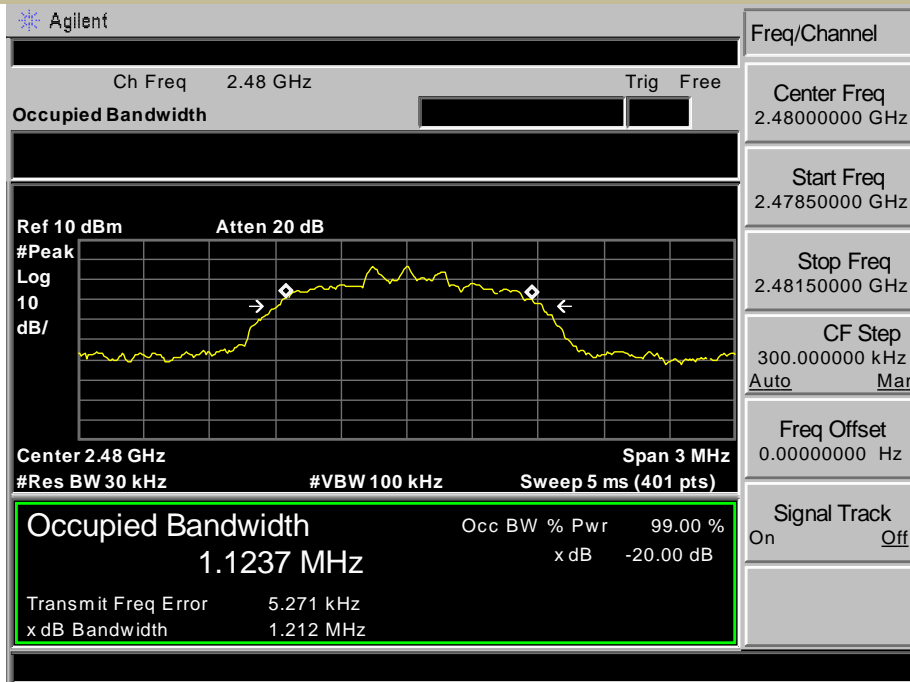

4.2. CARRIER FREQUENCY SEPARATION

4.2.1. Applicable Standard

According to FCC Part 15.247(a)(1) and KDB 558074 D01 15.247
MEAS GUIDANCE v05r02

4.2.2. Conformance Limit

Frequency hopping systems operating in the 2400-2483.5MHz band shall have hopping channel carrier frequencies separated by a minimum of 25kHz or the 20dB bandwidth of the hopping channel, whichever is greater.

In case of an output power less than 125mW, the frequency hopping system may have channels separated by a minimum of 25kHz or two-thirds of the 20dB bandwidth of the hopping channel, whichever is greater.

4.2.3. Test Configuration

Test according to clause 6.1 radio frequency test setup 1

4.2.4. Test Procedure

■ According to FCC Part15.247(a)(1)

The EUT must have its hopping function enabled. Use the following spectrum analyzer settings:

Set the RBW =30kHz. Set VBW =100kHz.

Set the span = wide enough to capture the peaks of two adjacent channels

Set Sweep time = auto couple.

Set Detector = peak. Set Trace mode = max hold.

Allow the trace to stabilize. Use the marker-delta function to determine the separation between the peaks of the adjacent channels. The limit is specified in one of the subparagraphs of this Section. Submit this plot.

Test Results:

Modulation Mode	Channel Number	Channel Frequency (MHz)	Measurement Bandwidth (MHz)	Limit (MHz)	Verdict
GFSK	1	2402	0.999	0.861	PASS
	40	2441	0.995	0.859	PASS
	79	2480	0.957	0.851	PASS
8DPSK	1	2402	0.899	> 2/3 of the 20dB Bandwidth or 25[kHz](whichever is greater)	PASS
	40	2441	0.989		PASS
	79	2480	0.896		PASS

Note: Limit = 20dB bandwidth * 2/3

Through Pre-scan, find the DH5 of data type is the worst case of GFSK modulation type, 3-DH5 of data type is the worst case of 8DPSK modulation type.

Only the worst case is recorded in the report.

Carrier Frequency Separation
Test Model
Channel 1: 2402MHz GFSK Modulation

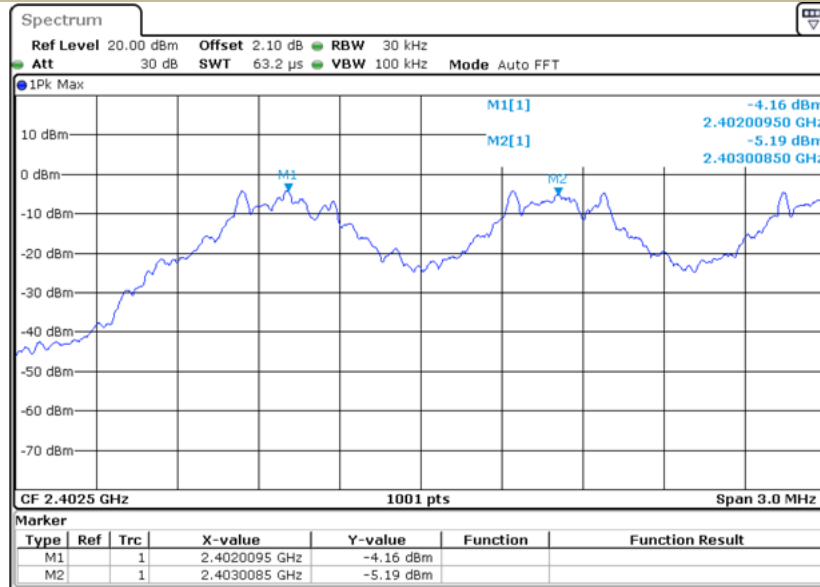

Carrier Frequency Separation
Test Model
Channel 40: 2441MHz GFSK Modulation

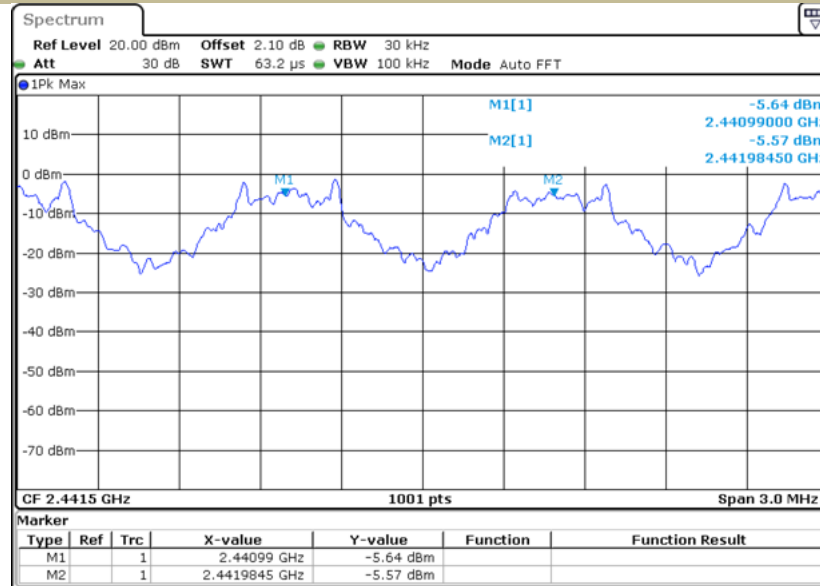

Carrier Frequency Separation
Test Model Channel 79: 2480MHz GFSK Modulation

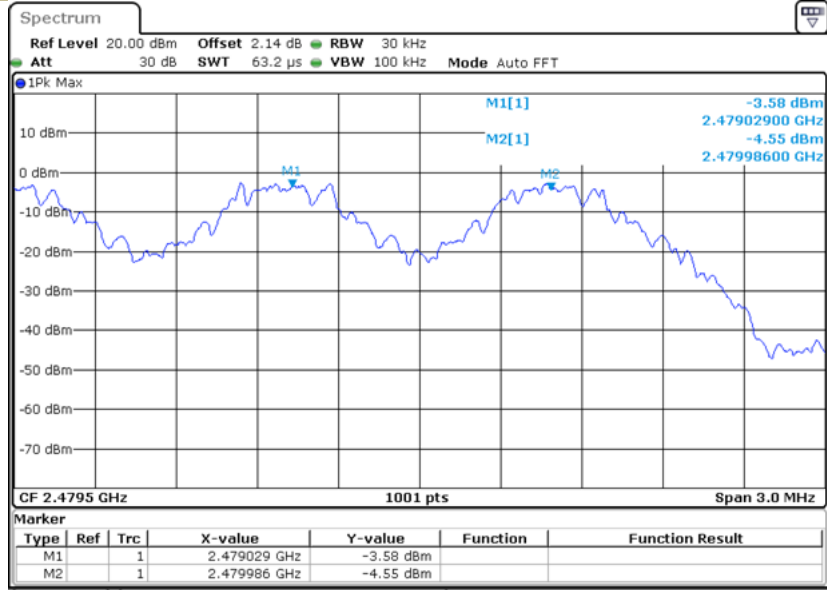

Carrier Frequency Separation
Test Model
Channel 1: 2402MHz 8DPSK Modulation

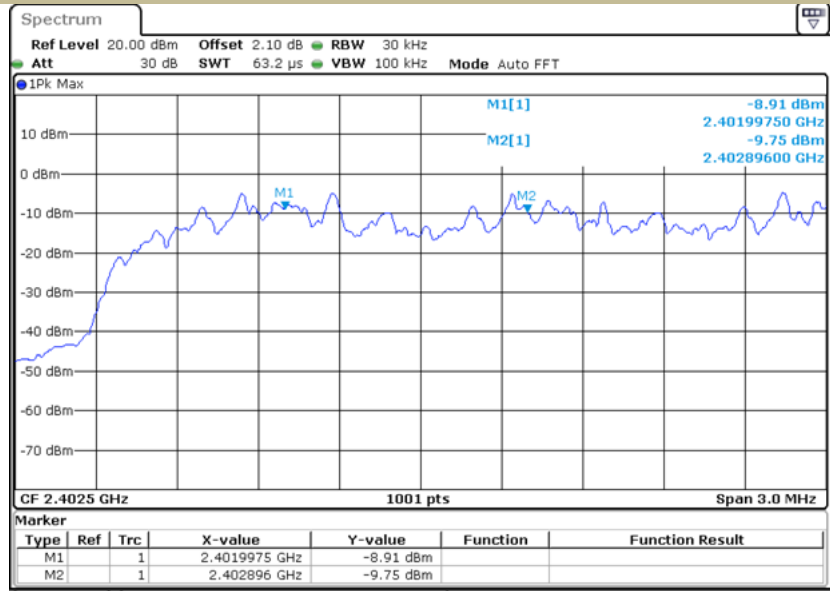

Carrier Frequency Separation
Test Model
Channel 40: 2441MHz 8DPSK Modulation

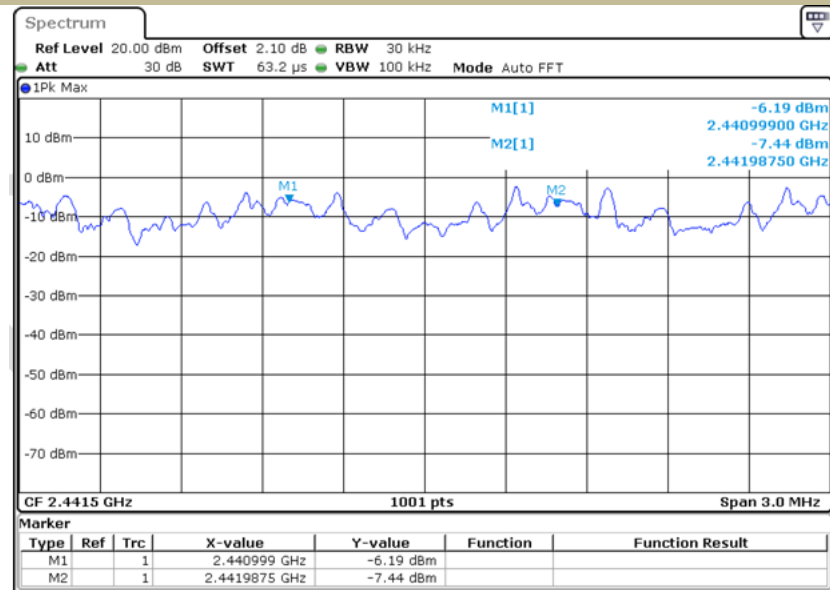

Carrier Frequency Separation
Test Model
Channel 79: 2480MHz 8DPSK Modulation

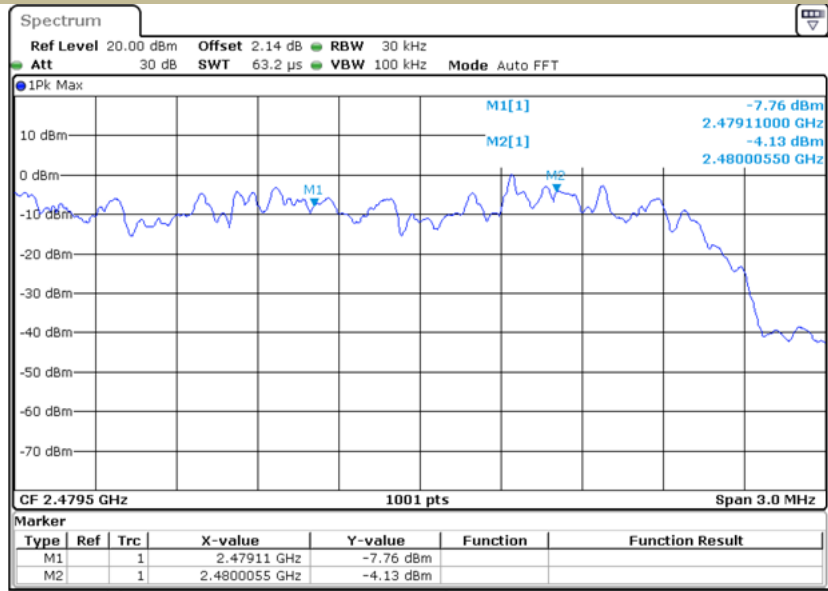

4.3. NUMBER OF HOPPING FREQUENCIES

4.3.1. Applicable Standard

According to FCC Part 15.247(a)(1) (iii) and KDB 558074 D01 15.247
MEAS GUIDANCE v05r02

4.3.2. Conformance Limit

Frequency hopping systems operating in the 2400-2483.5MHz band shall use
at least 15 channels.

4.3.3. Test Configuration

Test according to clause 6.1 radio frequency test setup 1

4.3.4. Test Procedure

- According to FCC Part 15.247(a)(1)(iii)

The EUT must have its hopping function enabled. Use the following spectrum analyzer
settings:

Span = the frequency band of operation (2400-2483.5MHz)

RBW \geq 100KHz

VBW \geq RBW

Sweep = auto

Detector function = peak

Trace = max hold

Allow the trace to stabilize. It may prove necessary to break the span up to sections, in
order to clearly show all of the hopping frequencies.

Test Results:

Modulation Mode	Hopping Channel Frequency Range	Quantity of Hopping Channel	Quantity of Hopping Channel limit
GFSK	2402-2480	79	> 15
8DPSK	2402-2480	79	> 15

Through Pre-scan, find the DH5 of data type is the worst case of GFSK modulation type, 3-DH5 of data type is the worst case of 8DPSK modulation type. Only the worst case is recorded in the report.

Test Model Number Of Hopping Frequencies
GFSK Modulation

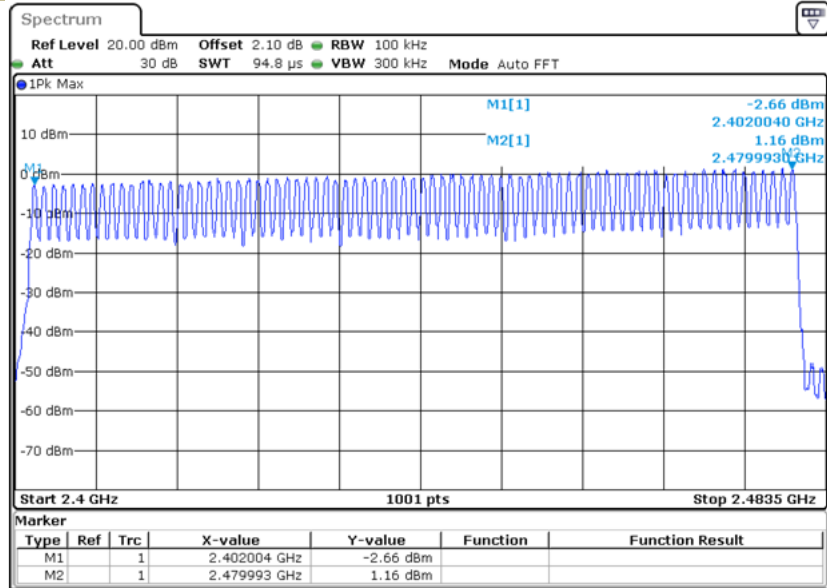

Test Model Number Of Hopping Frequencies
8DPSK Modulation

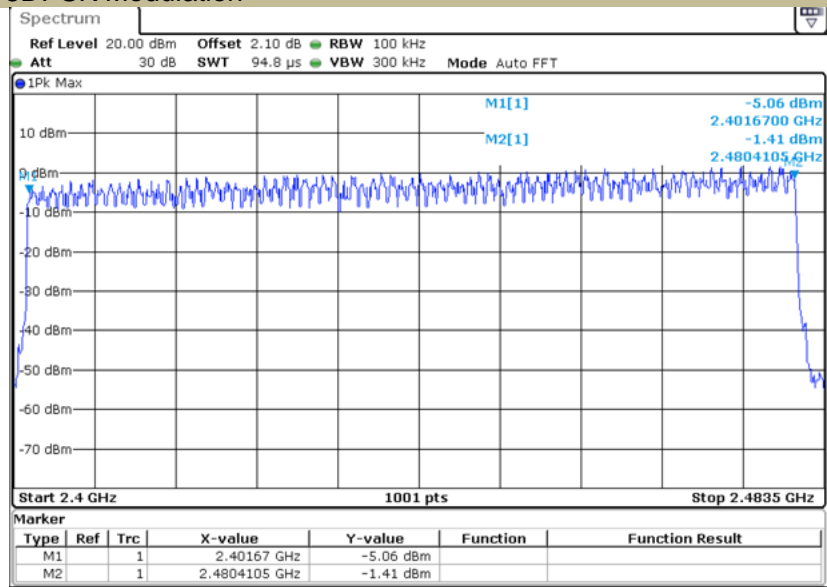

4.4. AVERAGE TIME OF OCCUPANCY (DWELL TIME)

4.4.1. Applicable Standard

According to FCC Part 15.247(a)(1)(iii) and KDB 558074 D01 15.247 MEAS GUIDANCE v05r02

4.4.2. Conformance Limit

For frequency hopping systems operating in the 2400-2483.5MHz band, the average time of occupancy on any channel shall not be greater than 0.4s within a period of 0.4s multiplied by the number of hopping channels employed.

4.4.3. Test Configuration

Test according to clause 6.1 radio frequency test setup 1

4.4.4. Test Procedure

- According to FCC Part 15.247(a)(1)(iii)

The EUT must have its hopping function enabled. Use the following spectrum analyzer settings:

Span = zero span, centered on a hopping channel

RBW = 1 MHz

VBW \geq RBW

Sweep = as necessary to capture the entire dwell time per hopping channel

Detector function = peak

Trace = max hold

If possible, use the marker-delta function to determine the dwell time. If this value varies with different modes of operation (e.g., data rate, modulation format, etc.), repeat this test for each variation. The limit is specified in one of the subparagraphs of this Section.

Test Results:

Mode	Dwell time (ms)	Limit	Conclusion
GFSK DH1	130.07	<400ms	PASS
GFSK DH3	260.89	<400ms	PASS
GFSK DH5	306.20	<400ms	PASS
8-DPSK 3DH1	127.41	<400ms	PASS
8-DPSK 3DH3	259.37	<400ms	PASS
8-DPSK 3DH5	321.25	<400ms	PASS

Remark:

GFSK DH1 : $49\text{hop}/5\text{s} * 0.4 * 79 * 0.42\text{ms} = 130.07$

GFSK DH3 : $24\text{hop}/5\text{s} * 0.4 * 79 * 1.72\text{ms} = 260.89$

GFSK DH5 : $17\text{hop}/5\text{s} * 0.4 * 79 * 2.85\text{ms} = 306.20$

8-DPSK 3DH1 : $48\text{hop}/5\text{s} * 0.4 * 79 * 0.42\text{ms} = 127.41$

8-DPSK 3DH3 : $24\text{hop}/5\text{s} * 0.4 * 79 * 1.71\text{ms} = 259.37$

8-DPSK 3DH5 : $17\text{hop}/5\text{s} * 0.4 * 79 * 2.99\text{ms} = 321.25$

Average Time Of Occupancy (Dwell Time)
Test Model
GFSK DH1

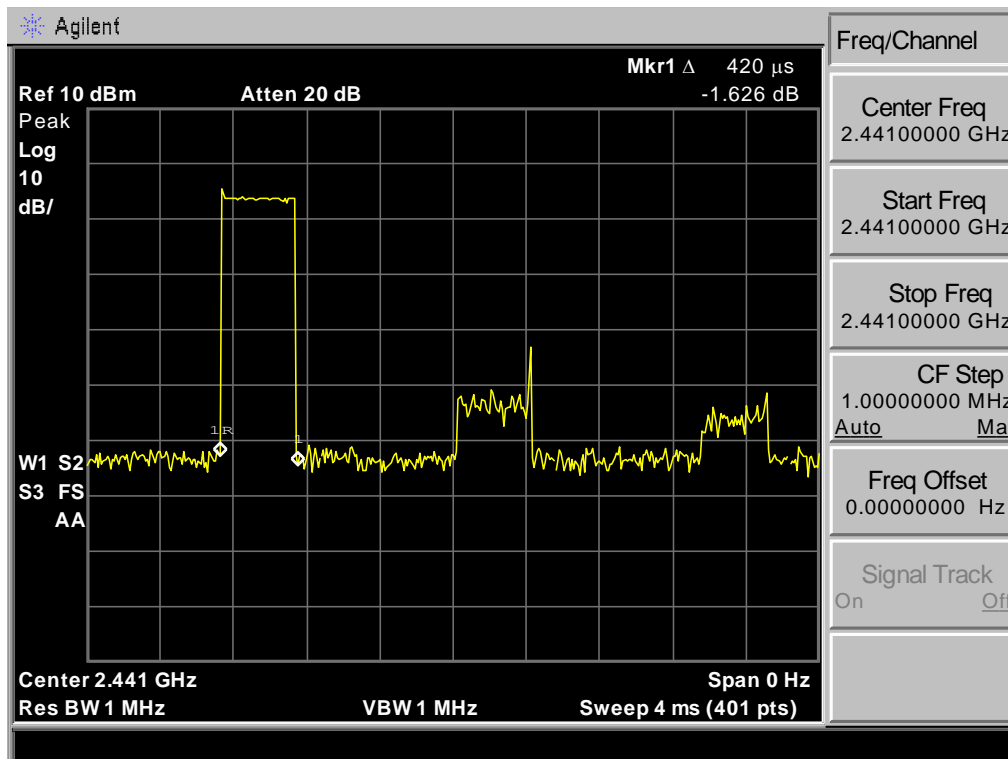
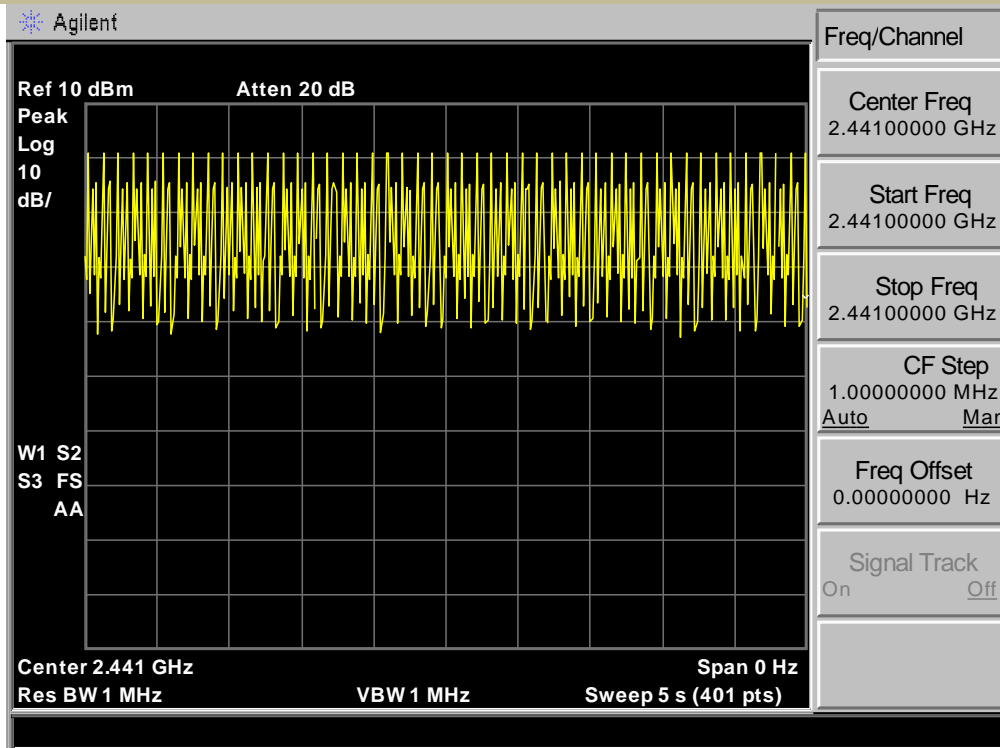

Average Time Of Occupancy (Dwell Time)
Test Model
GFSK DH3

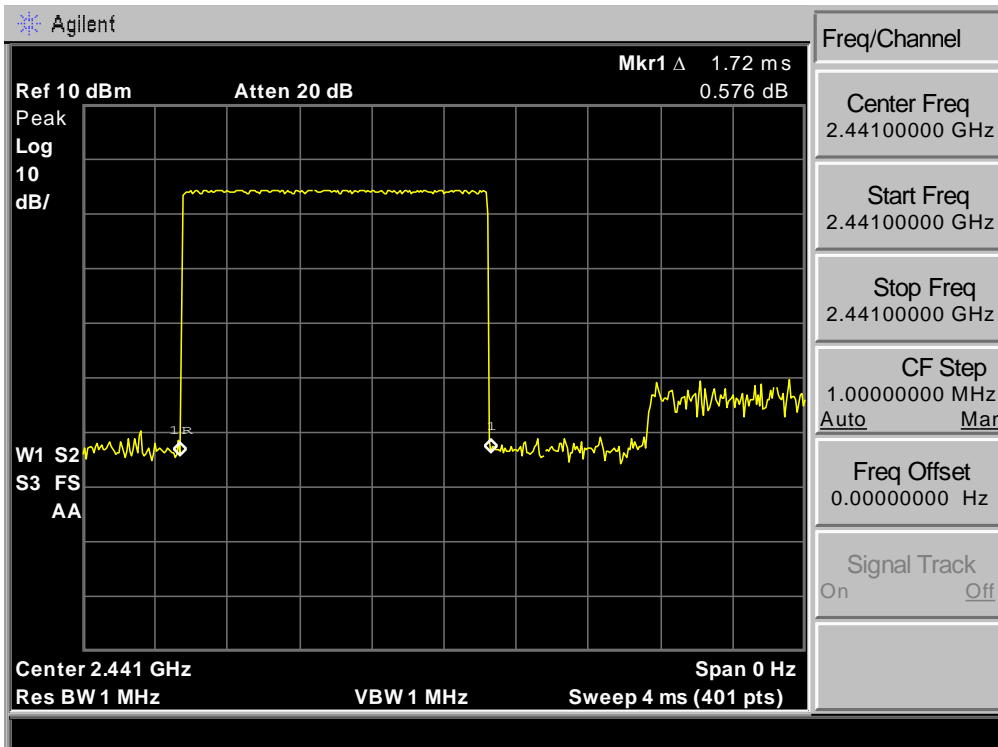
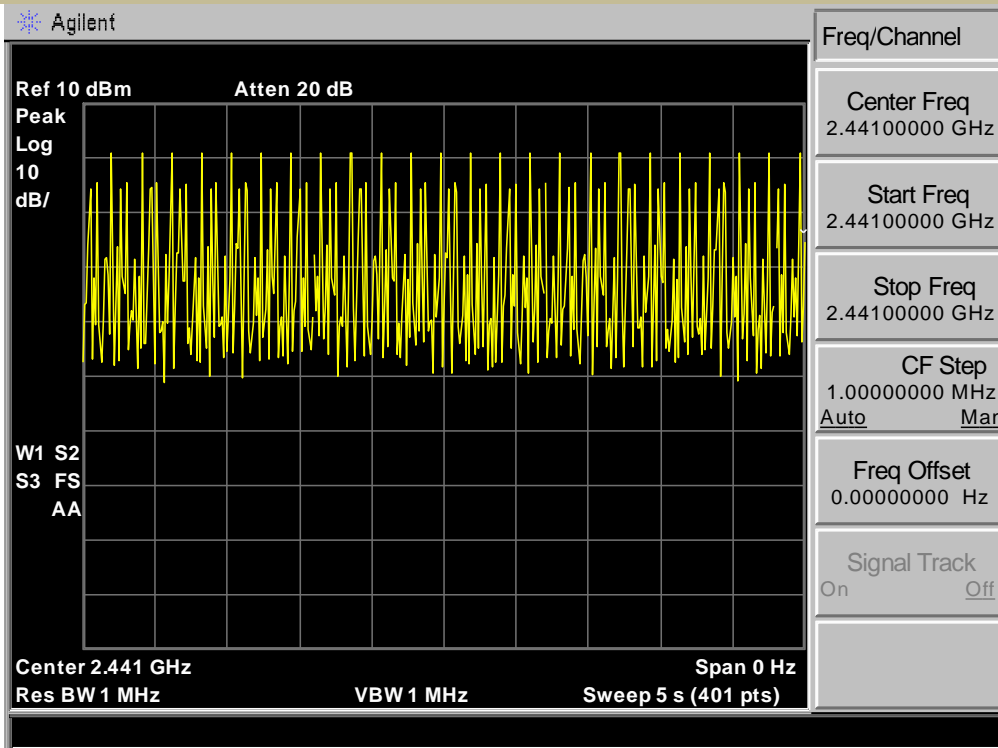

Average Time Of Occupancy (Dwell Time)
Test Model GFSK DH5

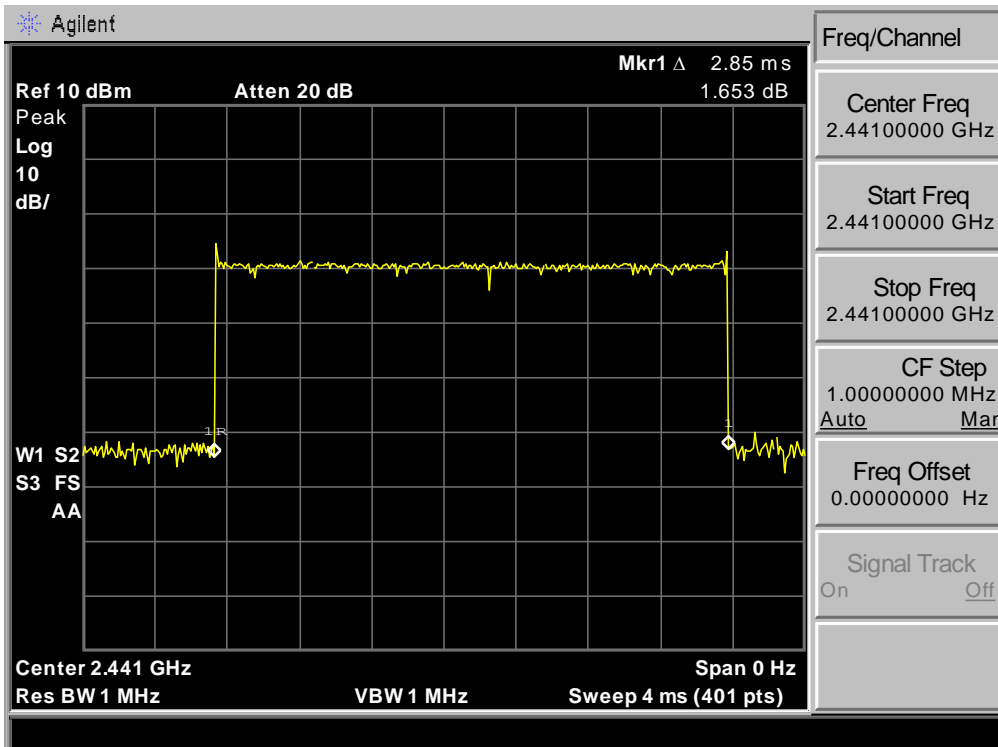
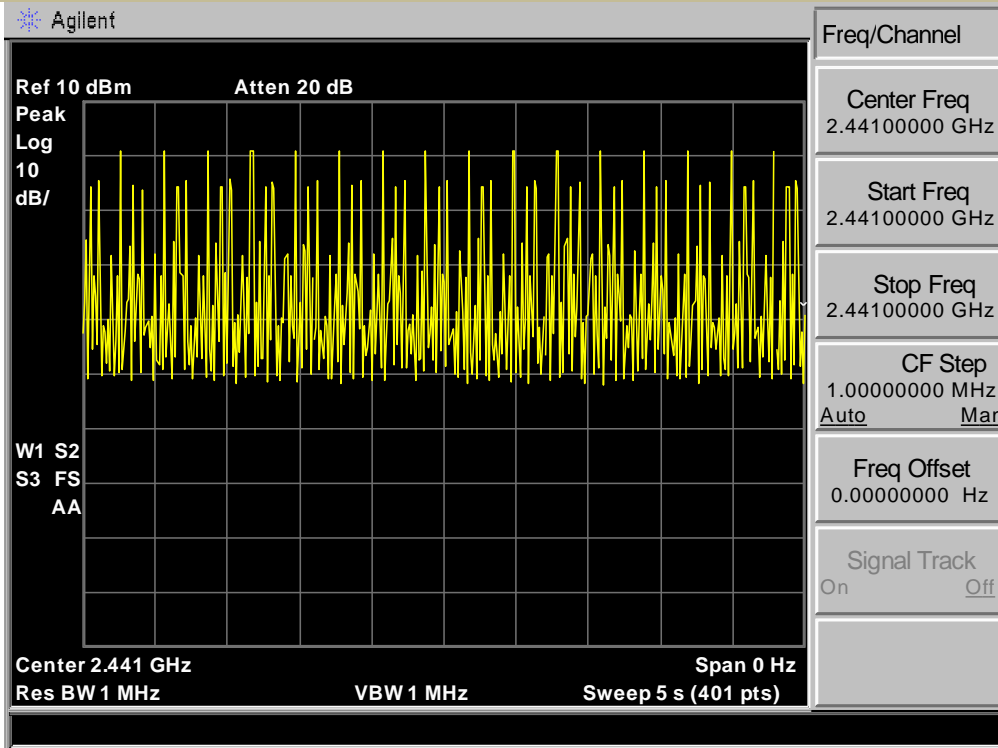

Average Time Of Occupancy (Dwell Time)
Test Model
8DPSK 3DH1

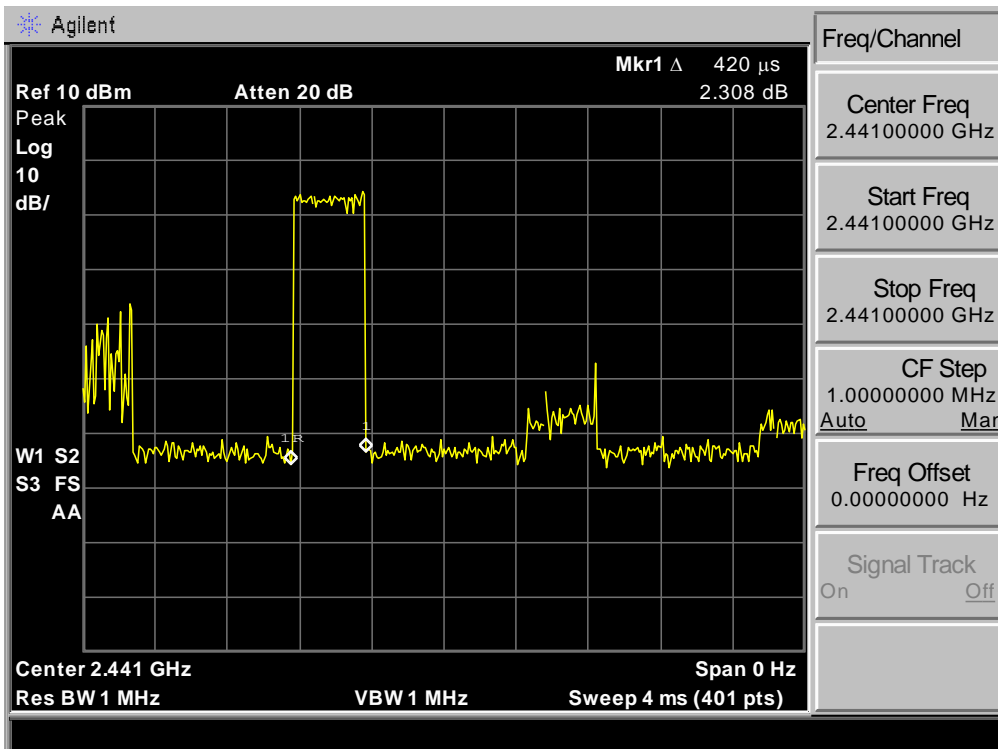
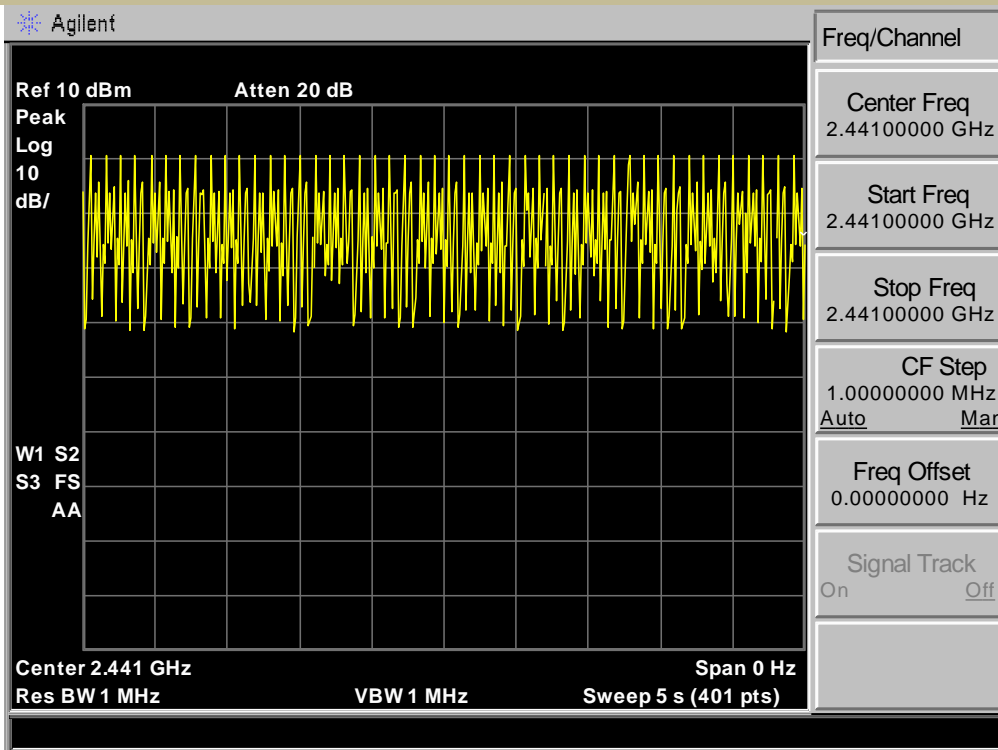

Average Time Of Occupancy (Dwell Time)
Test Model 8DPSK 3DH3

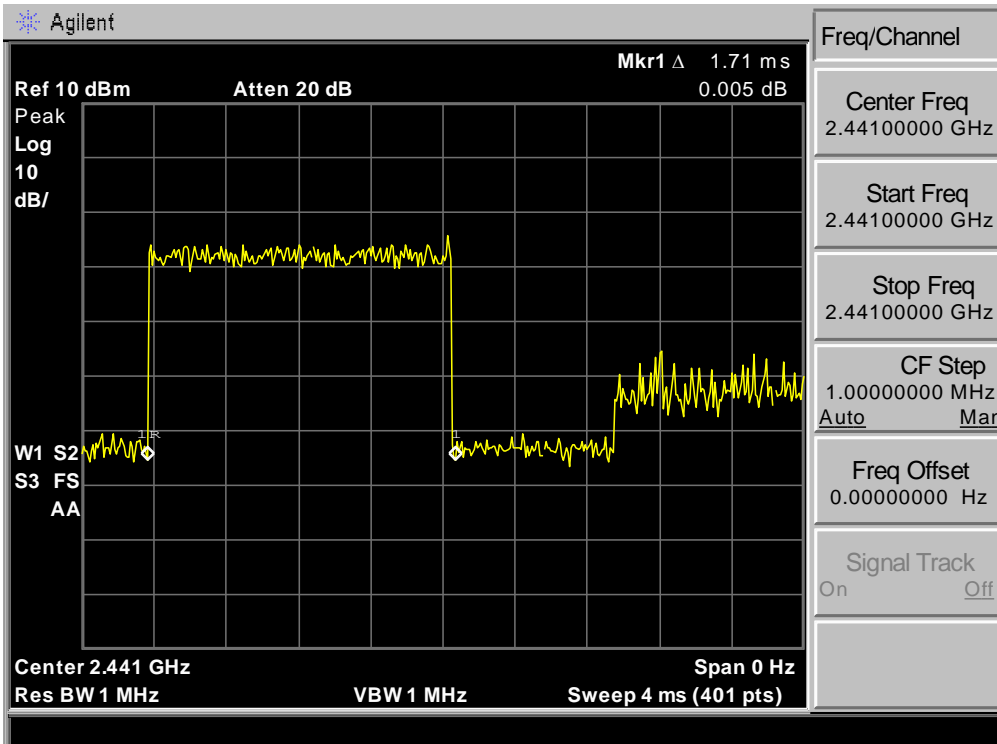
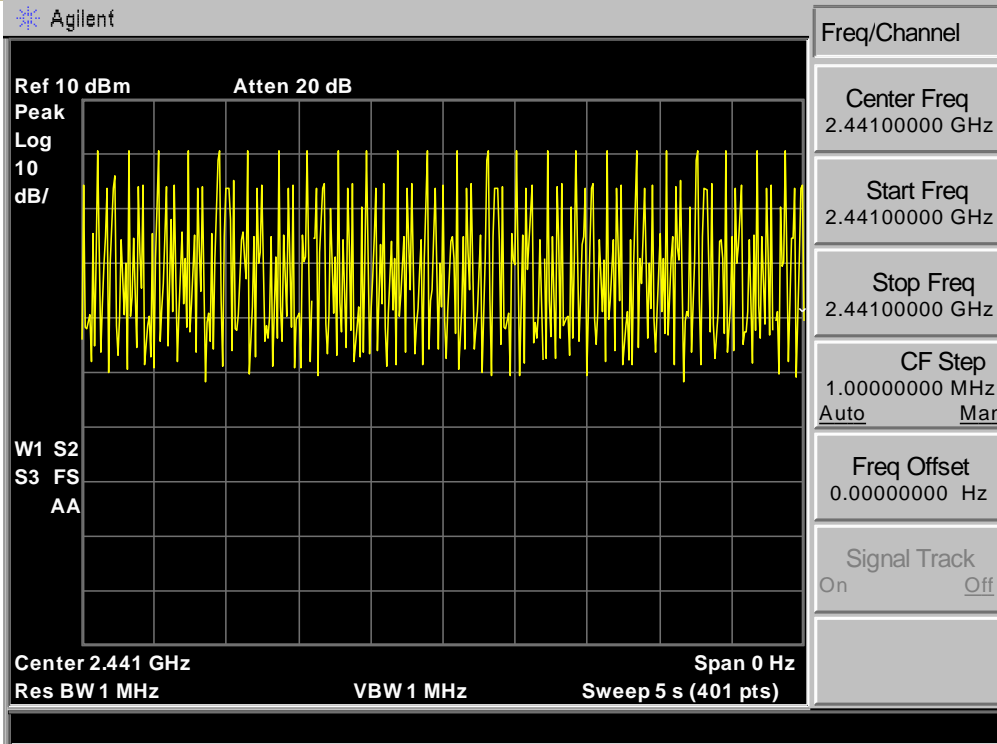

Average Time Of Occupancy (Dwell Time)
Test Model
8DPSK 3DH5

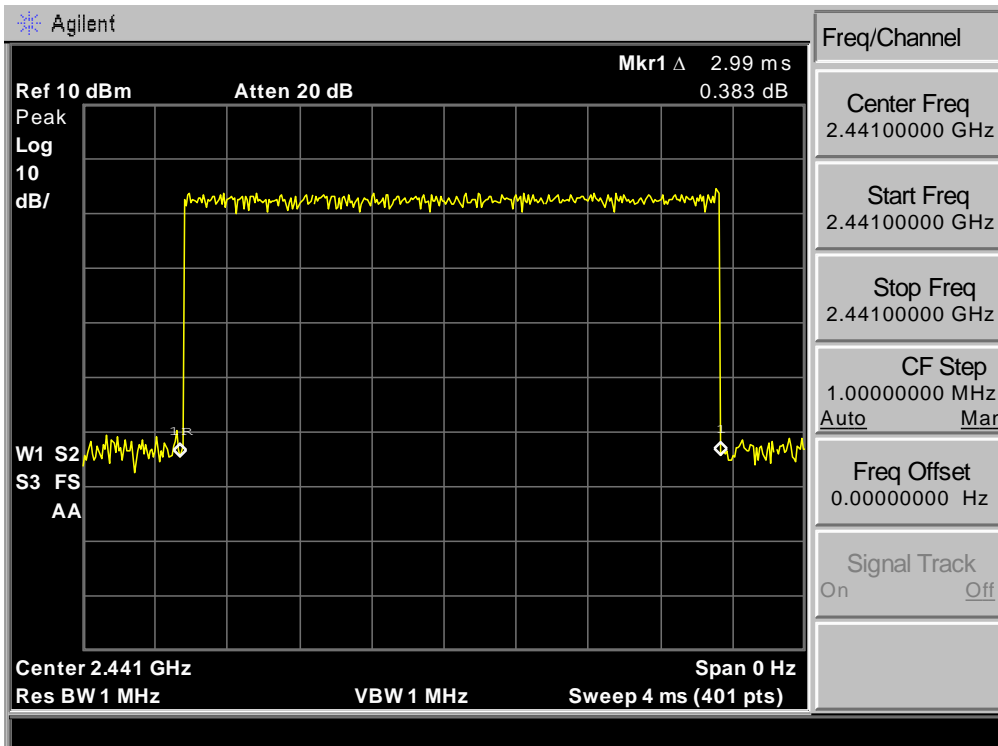
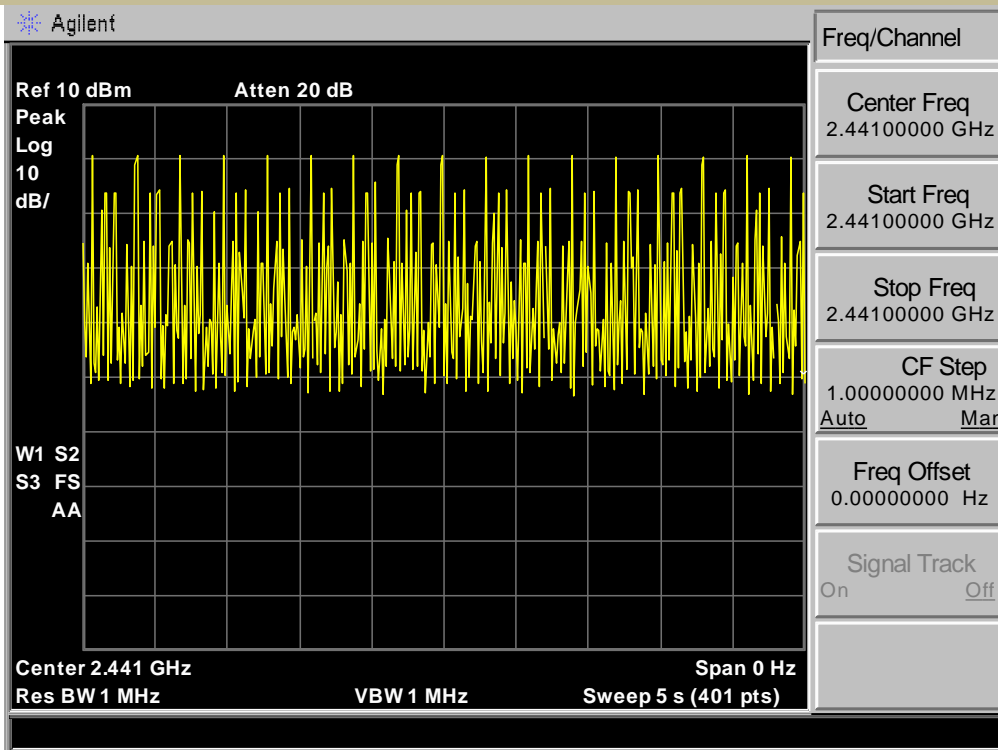

4.5. MAXIMUM PEAK CONDUCTED OUTPUT POWER

4.5.1. Applicable Standard

According to FCC Part 15.247(b)(1) and KDB 558074 D01 15.247
MEAS GUIDANCE v05r02

4.5.2. Conformance Limit

The max For frequency hopping systems operating in the 2400-2483.5 MHz band employing at least 75 non-overlapping hopping channels: 1 watt. For all other frequency hopping systems in the 2400-2483.5 MHz band: 0.125 watts.

4.5.3. Test Configuration

Test according to clause 6.1 radio frequency test setup 1

4.5.4. Test Procedure

■ According to FCC Part 15.247(b)(1)

As an alternative to a peak power measurement, compliance with the limit can be based on a measurement of the maximum conducted output power.

Use the following spectrum analyzer settings:

Set Span = approximately 5 times the 20 dB bandwidth, centered on a hopping channel (about 10MHz)

Set RBW > the 20 dB bandwidth of the emission being measured (about 3MHz)

Set VBW ≥ RBW

Set Sweep = auto

Set Detector function = peak

Set Trace = max hold

Allow the trace to stabilize. Use the marker-to-peak function to set the marker to the peak of the emission to determine the peak amplitude level.

Test Results

Operation Mode	Channel Number	Channel Frequency (MHz)	Measurement Level (dBm)	Limit (dBm)	Verdict
GFSK	1	2402	-1.889	30	PASS
	40	2441	0.061	30	PASS
	79	2480	1.869	30	PASS
8DPSK	1	2402	-0.934	30	PASS
	40	2441	0.974	30	PASS
	79	2480	2.952	30	PASS

Note: N/A

Through Pre-scan, find the DH5 of data type is the worst case of GFSK modulation type, 3-DH5 of data type is the worst case of 8DPSK modulation type. Only the worst case is recorded in the report.

Test Model Maximum Peak Conducted Output Power
Channel 1: 2402MHz GFSK

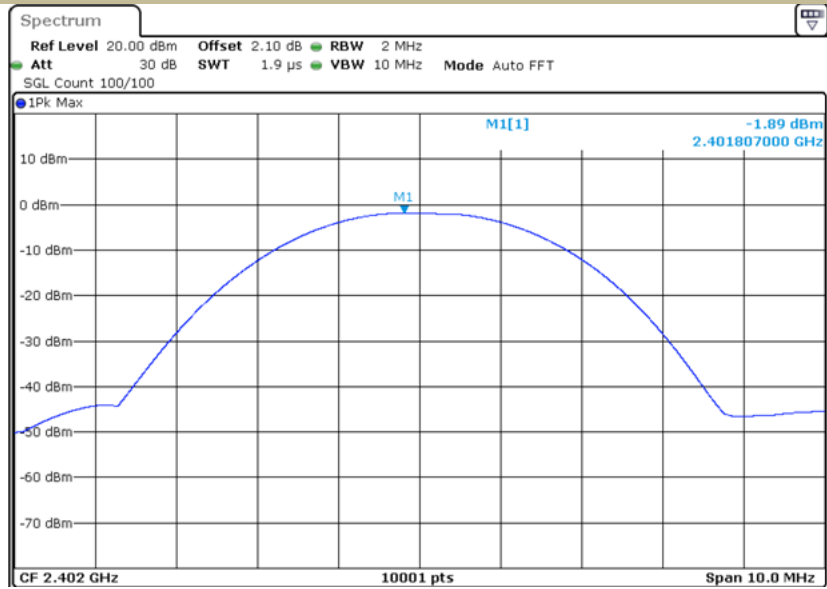

Test Model Maximum Peak Conducted Output Power
Channel40: 2441MHz GFSK

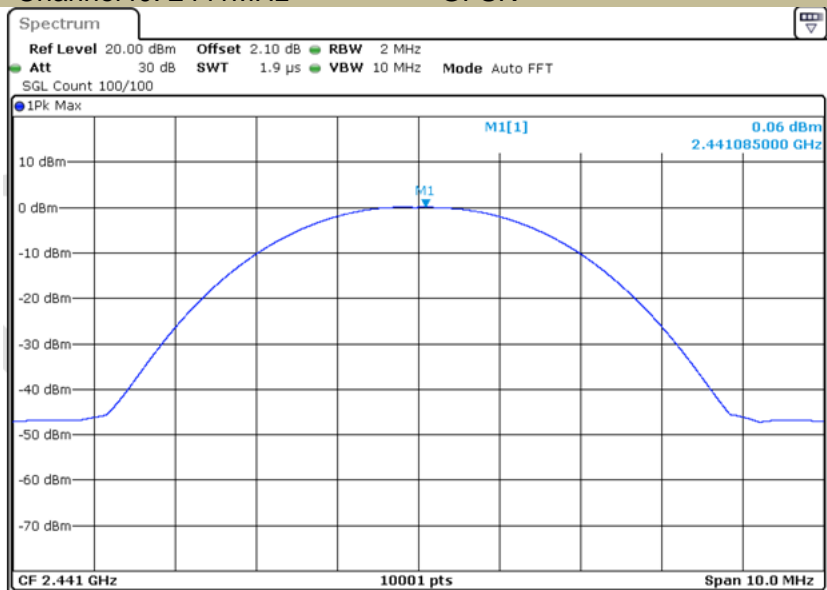

Maximum Peak Conducted Output Power
Test Model
Channel 79: 2480MHz GFSK

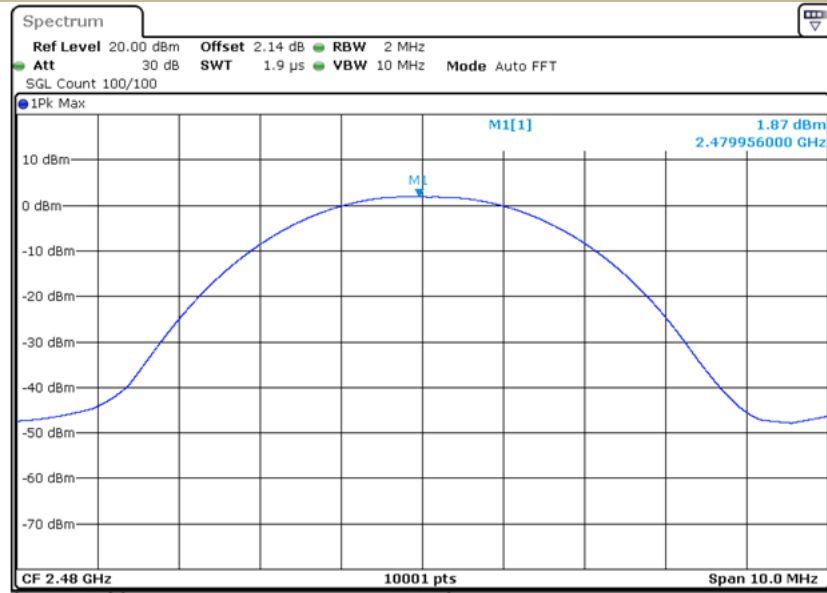

Test Model Maximum Peak Conducted Output Power
Channel 1: 2402MHz 8DPSK

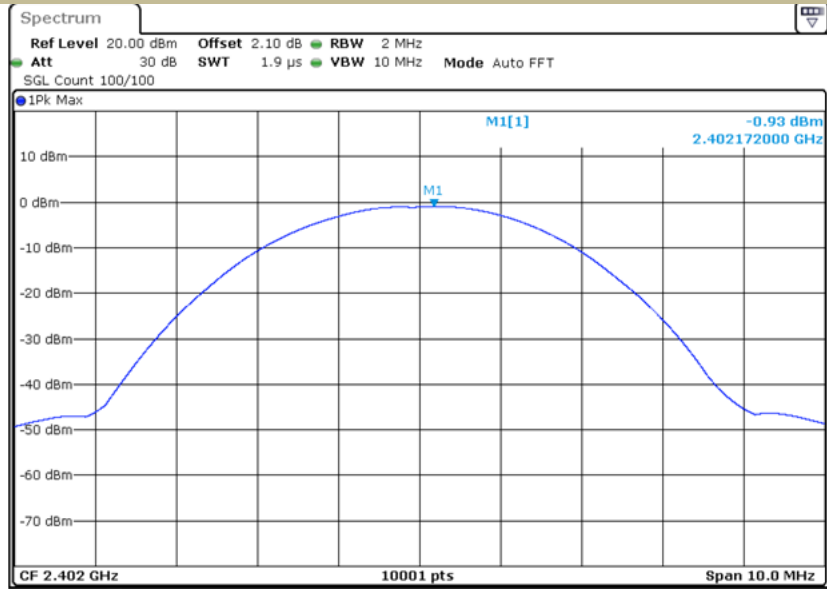

Test Model Maximum Peak Conducted Output Power
Channel 40: 2441MHz 8DPSK

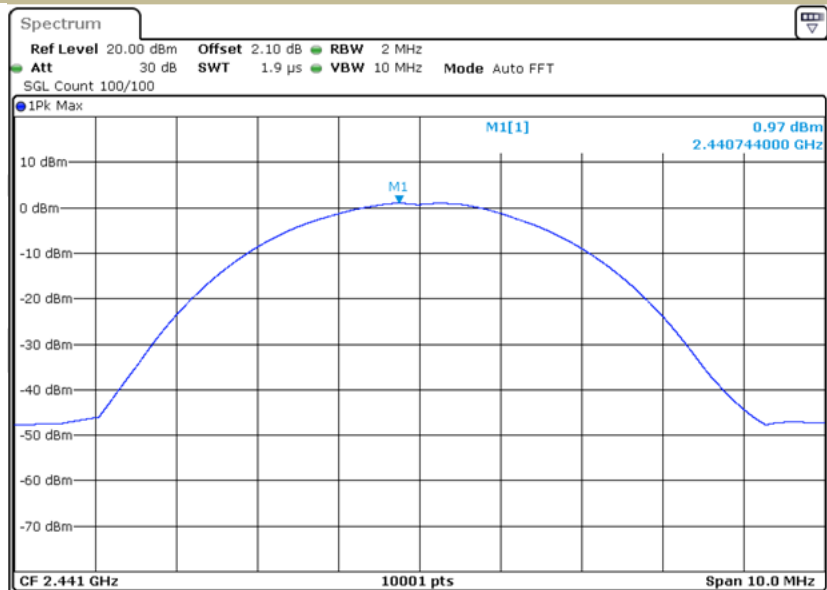

Maximum Peak Conducted Output Power
Test Model
Channel 79: 2480MHz 8DPSK

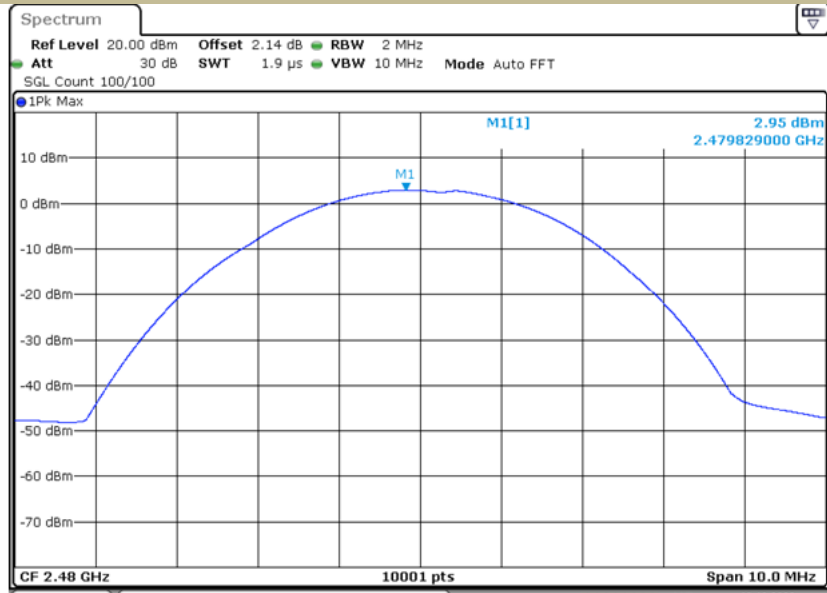

4.6. RADIATED SPURIOUS EMISSION

4.6.1. Applicable Standard

According to FCC Part 15.247(d) and 15.209 and KDB 558074 D01
15.247 MEAS GUIDANCE v05r02

4.6.2. Conformance Limit

According to FCC Part 15.247(d): radiated emissions which fall in the restricted bands, as defined in §15.205(a), must also comply with the radiated emission limits specified in §15.209(a) (see §15.205(c)).

According to FCC Part 15.205, Restricted bands

MHz	MHz	MHz	GHz
0.090-0.110	16.42-16.423	399.9-410	4.5-5.15
10.495-0.505	16.69475-16.69525	608-614	5.35-5.46
2.1735-2.1905	16.80425-16.80475	960-1240	7.25-7.75
4.125-4.128	25.5-25.67	1300-1427	8.025-8.5
4.17725-4.17775	37.5-38.25	1435-1626.5	9.0-9.2
4.20725-4.20775	73-74.6	1645.5-1646.5	9.3-9.5
6.215-6.218	74.8-75.2	1660-1710	10.6-12.7
6.26775-6.26825	123-138	2200-2300	14.47-14.5
8.291-8.294	149.9-150.05	2310-2390	15.35-16.2
8.362-8.366	156.52475-156.5252 5	2483.5-2500	17.7-21.4
8.37625-8.38675	156.7-156.9	2690-2900	22.01-23.12
8.41425-8.41475	162.0125-167.17	3260-3267	23.6-24.0
12.29-12.293	167.72-173.2	3332-3339	31.2-31.8
12.51975-12.52025	240-285	3345.8-3358	36.43-36.5
12.57675-12.57725	322-335.4	3600-4400	(2)
13.36-13.41			

According to FCC Part 15.205, the level of any transmitter spurious emission in Restricted bands shall not exceed the level of the emission specified in the following table

Restricted Frequency(MHz)	Field Strength ($\mu\text{V}/\text{m}$)	Field Strength ($\text{dB}\mu\text{V}/\text{m}$)	Measurement Distance
0.009-0.490	2400/F(KHz)	20 log ($\mu\text{V}/\text{m}$)	300
0.490-1.705	24000/F(KHz)	20 log ($\mu\text{V}/\text{m}$)	30
1.705-30	30	29.5	30
30-88	100	40	3
88-216	150	43.5	3
216-960	200	46	3
Above 960	500	54	3

4.6.3. Test Configuration

Test according to clause 6.2 radio frequency test setup 2

4.6.4. Test Procedure

This test is required for any spurious emission that falls in a Restricted Band, as defined in Section 15.205. It must be performed with the highest gain of each type of antenna proposed for use with the EUT. Use the following spectrum analyzer settings:

For Above 1GHz:

The EUT was placed on a turn table which is 1.5m above ground plane.

Maximum procedure was performed on the highest emissions to ensure EUT compliance.

Span = wide enough to fully capture the emission being measured

RBW = 1 MHz

VBW \geq RBW

Sweep = auto

Detector function = peak

Trace = max hold

For Below 1GHz:

The EUT was placed on a turn table which is 0.8m above ground plane.

Maximum procedure was performed on the highest emissions to ensure EUT compliance.

Span = wide enough to fully capture the emission being measured

RBW = 100 kHz

VBW \geq RBW

Sweep = auto

Detector function = peak

Trace = max hold

For Below 30MHz:

The EUT was placed on a turn table which is 0.8m above ground plane.

Maximum procedure was performed on the highest emissions to ensure EUT compliance.

Span = wide enough to fully capture the emission being measured

RBW = 9kHz

VBW \geq RBW

Sweep = auto

Detector function = peak

Trace = max hold

For Below 150KHz:

The EUT was placed on a turn table which is 0.8m above ground plane.

Maximum procedure was performed on the highest emissions to ensure EUT compliance.

Span = wide enough to fully capture the emission being measured

RBW = 200Hz

VBW \geq RBW

Sweep = auto

Detector function = peak

Trace = max hold

Follow the guidelines in ANSI C63.10-2013 with respect to maximizing the emission by rotating the EUT, measuring the emission while the EUT is situated in three orthogonal planes (if appropriate), adjusting the measurement antenna height and polarization, etc. A pre-amp and a high pass filter are required for this test, in order to provide the measuring system with sufficient sensitivity. Allow the trace to stabilize. The peak reading of the emission, after being corrected by the antenna factor, cable loss, pre-amp gain, etc., is the peak field strength, which must comply with the limit specified in Section 15.35(b). Submit this data.

Now set the VBW to 10 Hz, while maintaining all of the other instrument settings. This peak level, once corrected, must comply with the limit specified in Section 15.209. If the dwell time per channel of the hopping signal is less than 100 ms, then the reading obtained with the 10 Hz VBW may be further adjusted by a "duty cycle correction factor", derived from $20\log(\text{dwell time}/100 \text{ ms})$, in an effort to demonstrate compliance with the 15.209 limit. Submit this data.

Repeat above procedures until all frequency measured was complete.

Test Results:

■ Spurious Emission below 30MHz (9KHz to 30MHz)

Note: the amplitude of spurious emission that is attenuated by more than 20dB below the permissible

limit has no need to be reported.

Distance extrapolation factor = $40\log(\text{Specific distance}/\text{test distance})$ (dB);

Limit line = Specific limits (dBuV) + distance extrapolation factor

■ Spurious Emission Above 1GHz (1GHz to 25GHz)

Bluetooth (GFSK, pi/4-DQPSK, 8DPSK) mode have been tested, and the worst result(GFSK ,8DPSK) was report as below:

Worse case mode:		FGSK(DH5)		Test channel:		Lowest	
Frequency	Meter Reading	Factor	Emission Level	Limits	Over	Detector Type	Ant. Pol.
(MHz)	(dBμV)	(dB)	(dBμV/m)	(dBμV/m)	(dB)		H/V
4804	62.23	-4.12	58.11	74	-15.89	peak	H
4804	50.12	-4.12	46.00	54	-8.00	AVG	H
7206	54.11	1.46	55.57	74	-18.43	peak	H
7206	41.45	1.46	42.91	54	-11.09	AVG	H
4804	60.99	-4.12	56.87	74	-17.13	peak	V
4804	51.09	-4.12	46.97	54	-7.03	AVG	V
7206	49.88	1.46	51.34	74	-22.66	peak	V
7206	40.00	1.46	41.46	54	-12.54	AVG	V

Worse case mode:		FGSK(DH5)		Test channel:		Lowest	
Frequency	Meter Reading	Factor	Emission Level	Limits	Over	Detector Type	Ant. Pol.
(MHz)	(dBμV)	(dB)	(dBμV/m)	(dBμV/m)	(dB)		H/V
4882	62.11	-4.03	58.08	74	-15.92	peak	H
4882	50.02	-4.03	45.99	54	-8.01	AVG	H
7323	51.91	1.66	53.57	74	-20.43	peak	H
7323	41.06	1.66	42.72	54	-11.28	AVG	H
4882	62.00	-4.03	57.97	74	-16.03	peak	V
4882	51.23	-4.03	47.20	54	-6.80	AVG	V
7323	49.41	1.66	51.07	74	-22.93	peak	V
7323	39.87	1.66	41.53	54	-12.47	AVG	V

Worse case mode:		FGSK(DH5)		Test channel:		Lowest	
Frequency	Meter Reading	Factor	Emission Level	Limits	Over	Detector Type	Ant. Pol.
(MHz)	(dB μ V)	(dB)	(dB μ V/m)	(dB μ V/m)	(dB)		H/V
4960	62.55	-4.26	58.29	74	-15.71	peak	H
4960	50.91	-4.26	46.65	54	-7.35	AVG	H
7440	51.56	1.18	52.74	74	-21.26	peak	H
7440	41.77	1.18	42.95	54	-11.05	AVG	H
4960	61.91	-4.26	57.65	74	-16.35	peak	V
4960	50.05	-4.26	45.79	54	-8.21	AVG	V
7440	51.23	1.18	52.41	74	-21.59	peak	V
7440	40.46	1.18	41.64	54	-12.36	AVG	V

Worse case mode:		8DPSK(DH5)		Test channel:		Lowest	
Frequency	Meter Reading	Factor	Emission Level	Limits	Over	Detector Type	Ant. Pol.
(MHz)	(dB μ V)	(dB)	(dB μ V/m)	(dB μ V/m)	(dB)		H/V
4804	61.03	-4.03	57.00	74	-17.00	peak	H
4804	50.45	-4.03	46.42	54	-7.58	AVG	H
7206	53.06	1.66	54.72	74	-19.28	peak	H
7206	40.04	1.66	41.70	54	-12.30	AVG	H
4804	60.36	-4.12	56.24	74	-17.76	peak	V
4804	50.01	-4.12	45.89	54	-8.11	AVG	V
7206	49.11	1.46	50.57	74	-23.43	peak	V
7206	39.86	1.46	38.40	54	-15.60	AVG	V

Worse case mode:		8DPSK(DH5)		Test channel:		Middle	
Frequency	Meter Reading	Factor	Emission Level	Limits	Over	Detector Type	Ant. Pol.
(MHz)	(dB μ V)	(dB)	(dB μ V/m)	(dB μ V/m)	(dB)		H/V
4882	61.39	-4.26	57.13	74	-16.87	peak	H
4882	49.77	-4.26	45.51	54	-8.49	AVG	H
7323	53.11	1.18	54.29	74	-19.71	peak	H
7323	42.01	1.18	43.19	54	-10.81	AVG	H
4882	60.96	-4.26	56.70	74	-17.30	peak	V
4882	46.79	-4.26	42.53	54	-11.47	AVG	V
7323	51.33	1.18	52.51	74	-21.49	peak	V
7323	39.66	1.18	40.84	54	-13.16	AVG	V

Worse case mode:		8DPSK(DH5)		Test channel:		Highest	
Frequency	Meter Reading	Factor	Emission Level	Limits	Over	Detector Type	Ant. Pol.
(MHz)	(dBμV)	(dB)	(dBμV/m)	(dBμV/m)	(dB)		H/V
4960	61.39	-4.26	57.13	74	-16.87	peak	H
4960	49.77	-4.26	45.51	54	-8.49	AVG	H
7440	53.11	1.18	54.29	74	-19.71	peak	H
7440	42.01	1.18	43.19	54	-10.81	AVG	H
4960	59.99	-4.03	55.96	74	-18.04	peak	V
4960	42.86	-4.03	38.83	54	-15.17	AVG	V
7440	48.69	1.66	50.35	74	-23.65	peak	V
7440	36.40	1.66	38.06	54	-15.94	AVG	V

Remark:

- The field strength is calculated by adding the Antenna Factor, Cable Factor & Preamplifier. The basic equation with a sample calculation is as follows:
Final Test Level = Receiver Reading + Antenna Factor + Cable Factor – Preamplifier Factor
- Scan from 9kHz to 25GHz, the disturbance above 10GHz and below 30MHz was very low. As shown in this section, for frequencies above 1GHz, the field strength limits are based on average limits. However, the peak field strength of any emission shall not exceed the maximum permitted average limits specified above by more than 20 dB under any condition of modulation. So, only the peak measurements were shown in the report.

■ Spurious Emission in Restricted Band 2300-2410MHz and 2470-2500MHz
Bluetooth (GFSK, pi/4-DQPSK, 8DPSK, Hopping) mode have been tested, and the worst result(GFSK) was report as below:

Test mode: 8DPSK	2402MHz	Test channel:	Lowest	Polarization	Horizontal
------------------	---------	---------------	--------	--------------	------------

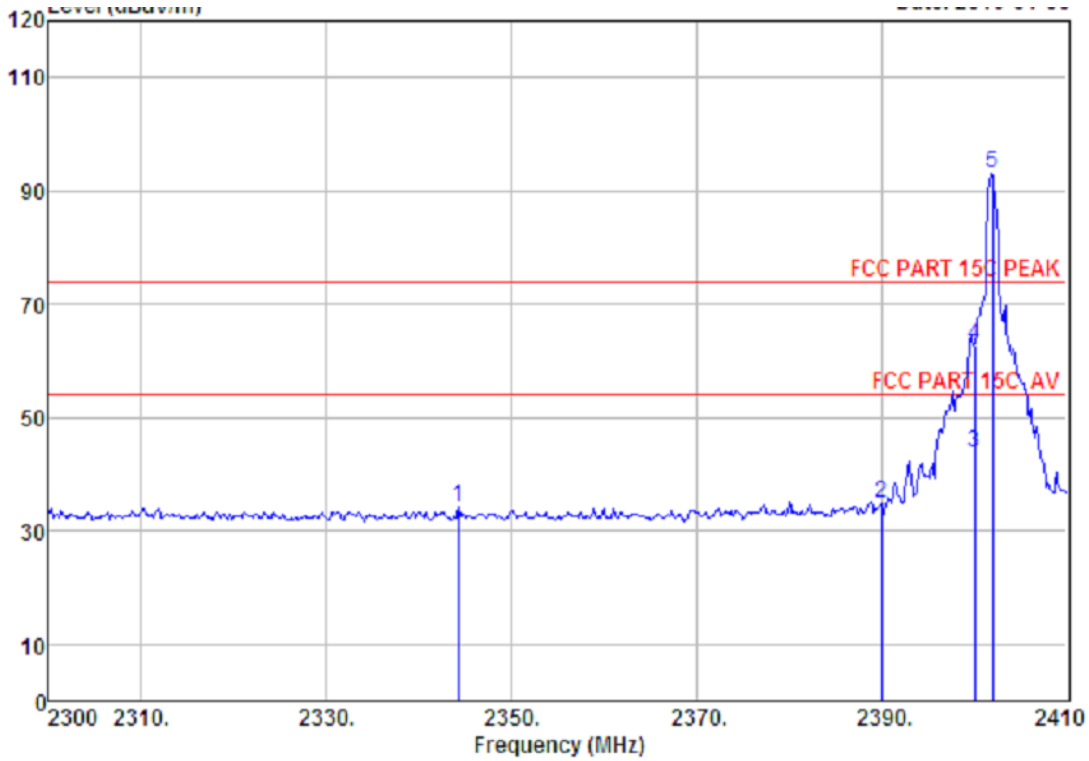

Freq. (MHz)	Ant. Factor (dB/m)	Cable Loss (dB)	Amp Factor (dB)	Reading (dBuV)	Emission Level (dBuV/m)	Limits (dBuV/m)	Margin (dB)	Remark
1	27.70	6.56	34.59	34.57	34.24	74.00	39.76	Peak
2	27.64	6.62	34.62	35.10	34.74	74.00	39.26	Peak
3	27.61	6.62	34.64	44.31	43.90	54.00	10.10	Average
4	27.61	6.62	34.64	63.23	62.82	74.00	11.18	Peak
5	27.61	6.62	34.64	93.49	93.08	74.00	-19.08	Peak

Remarks: 1. Emission Level= Antenna Factor + Cable Loss - Amp Factor + Reading.
2. The emission levels that are 20dB below the official limit are not reported.

Test mode: 8DPSK	2402MHz	Test channel:	Lowest	Polarization	Vertical
------------------	---------	---------------	--------	--------------	----------

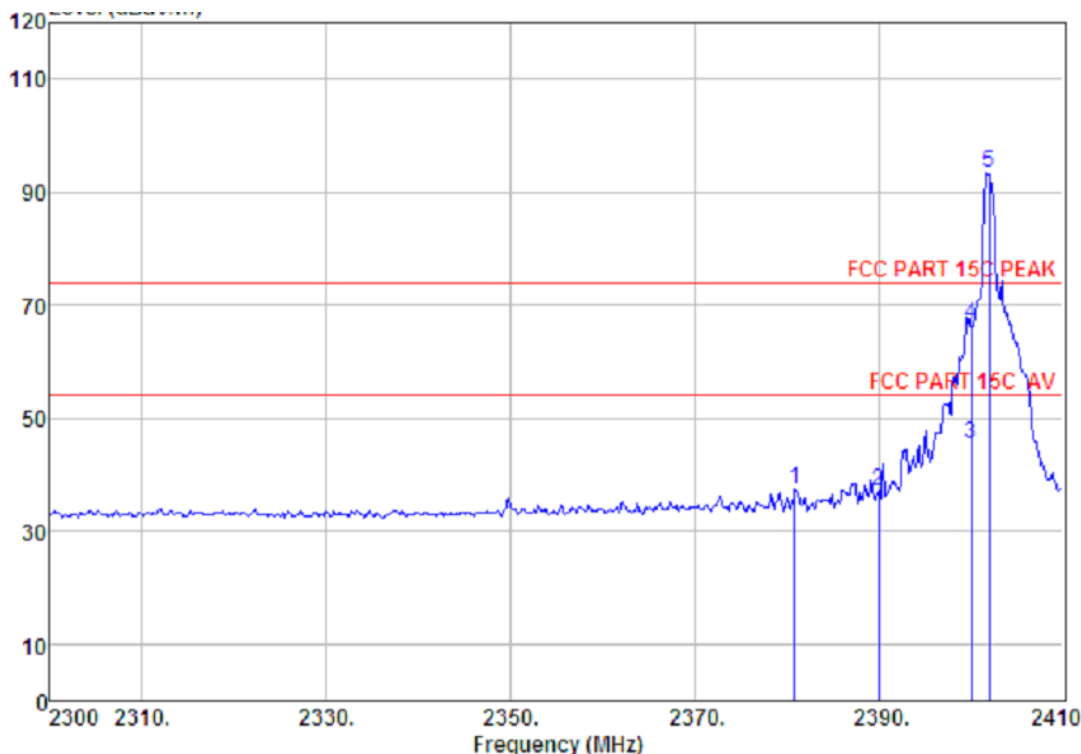

	Freq. (MHz)	Ant. Factor (dB/m)	Cable Loss (dB)	Amp Factor (dB)	Reading (dBuV)	Emission Level (dBuV/m)	Limits (dBuV/m)	Margin (dB)	Remark
1	2380.85	27.64	6.60	34.59	37.68	37.33	74.00	36.67	Peak
2	2390.00	27.64	6.62	34.62	37.51	37.15	74.00	36.85	Peak
3	2400.00	27.61	6.62	34.64	45.91	45.50	54.00	8.50	Average
4	2400.00	27.61	6.62	34.64	67.01	66.60	74.00	7.40	Peak
5	2402.00	27.61	6.62	34.64	93.99	93.58	74.00	-19.58	Peak

Remarks: 1. Emission Level= Antenna Factor + Cable Loss - Amp Factor + Reading.
2. The emission levels that are 20dB below the official limit are not reported.

Test mode: 8DPSK	2480MHz	Test channel:	Highest	Polarization	Horizontal
------------------	---------	---------------	---------	--------------	------------

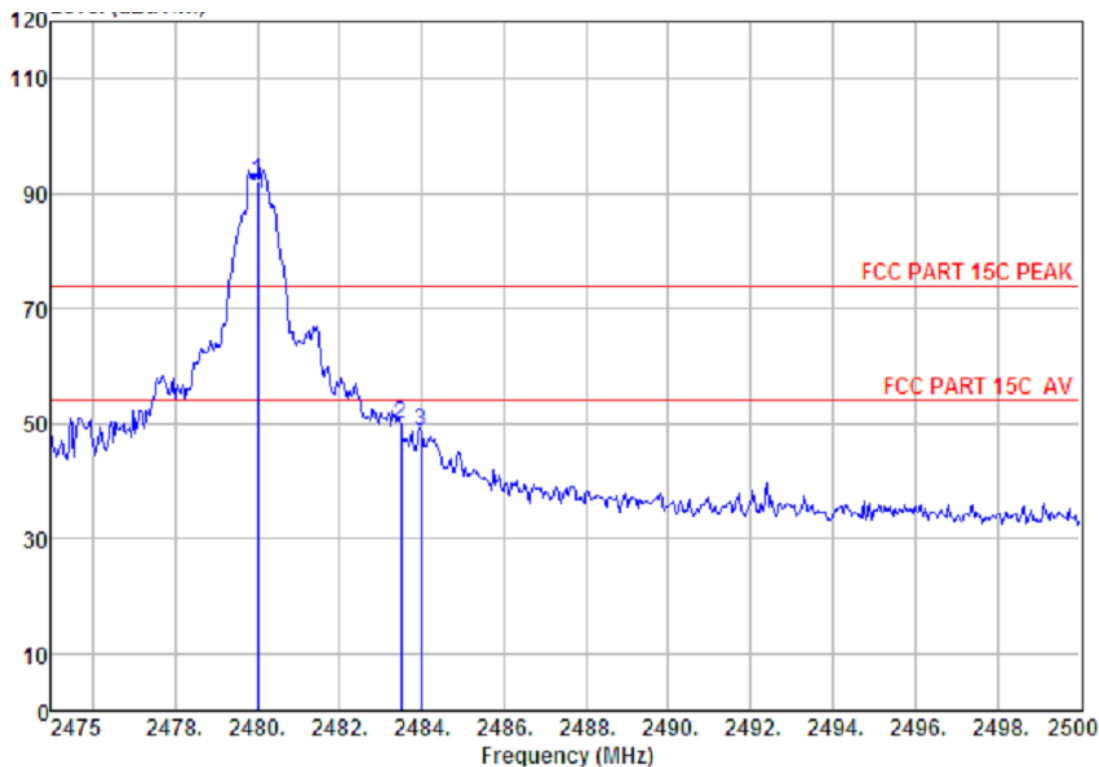

	Freq. (MHz)	Ant. Factor (dB/m)	Cable Loss (dB)	Amp Factor (dB)	Reading (dBuV)	Emission Level (dBuV/m)	Limits (dBuV/m)	Margin (dB)	Remark
1	2480.00	27.58	6.71	35.11	92.82	92.00	74.00	-18.00	Peak
2	2483.50	27.58	6.71	35.11	50.67	49.85	74.00	24.15	Peak
3	2483.98	27.58	6.71	35.11	49.46	48.64	74.00	25.36	Peak

Remarks: 1. Emission Level= Antenna Factor + Cable Loss - Amp Factor + Reading.
2. The emission levels that are 20dB below the official limit are not reported.

Test mode: 8DPSK	2480MHz	Test channel:	Highest	Polarization	Vertical
------------------	---------	---------------	---------	--------------	----------

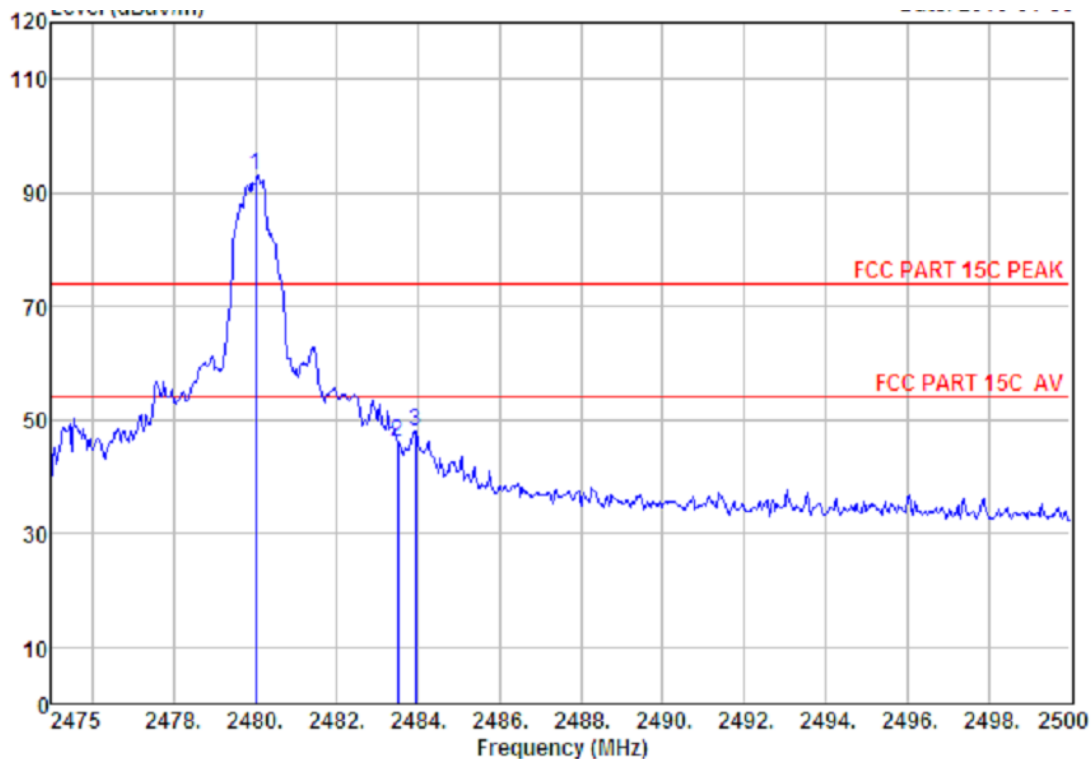

	Freq. (MHz)	Ant. Factor (dB/m)	Cable Loss (dB)	Amp Factor (dB)	Reading (dBuV)	Emission Level (dBuV/m)	Limits (dBuV/m)	Margin (dB)	Remark
1	2480.00	27.58	6.71	35.11	93.87	93.05	74.00	-19.05	Peak
2	2483.50	27.58	6.71	35.11	46.80	45.98	74.00	28.02	Peak
3	2483.95	27.58	6.71	35.11	48.74	47.92	74.00	26.08	Peak

Remarks: 1. Emission Level= Antenna Factor + Cable Loss - Amp Factor + Reading.
2. The emission levels that are 20dB below the official limit are not reported.

Test mode : GFSK(DH5)	2402MHz	Test channel:	Lowest	Polarization	Horizontal
Hopping on					

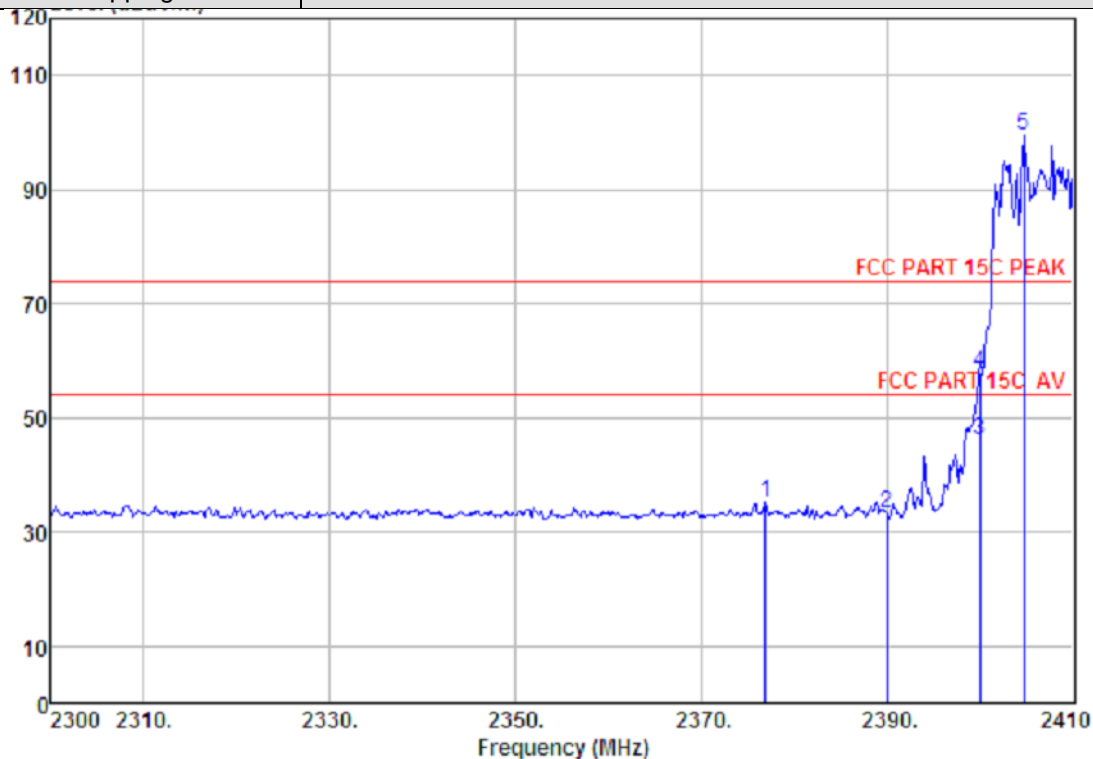

	Freq. (MHz)	Ant. Factor (dB/m)	Cable Loss (dB)	Amp Factor (dB)	Reading (dBuV)	Emission Level (dBuV/m)	Limits (dBuV/m)	Margin (dB)	Remark
1	2377.00	27.64	6.60	34.59	35.61	35.26	74.00	38.74	Peak
2	2390.00	27.64	6.62	34.62	33.62	33.26	74.00	40.74	Peak
3	2400.00	27.61	6.62	34.64	46.44	46.03	54.00	7.97	Average
4	2400.00	27.61	6.62	34.64	58.33	57.92	74.00	16.08	Peak
5	2404.72	27.61	6.64	34.64	99.83	99.44	74.00	-25.44	Peak

Remarks: 1. Emission Level= Antenna Factor + Cable Loss - Amp Factor + Reading.
2. The emission levels that are 20dB below the official limit are not reported.

Test mode : GFSK(DH5)	2402MHz	Test channel:	Lowest	Polarization	vertical
Hopping on					

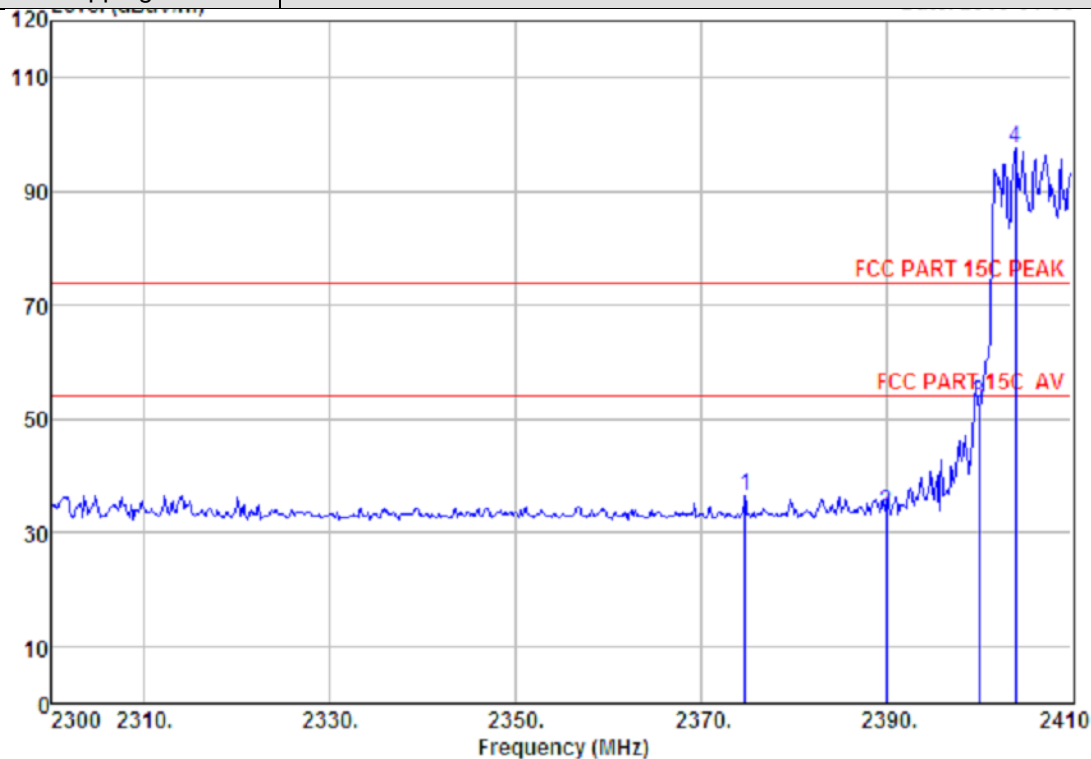

	Freq. (MHz)	Ant. Factor (dB/m)	Cable Loss (dB)	Amp Factor (dB)	Reading (dBuV)	Emission Level (dBuV/m)	Limits (dBuV/m)	Margin (dB)	Remark
1	2374.80	27.64	6.60	34.59	36.72	36.37	74.00	37.63	Peak
2	2390.00	27.64	6.62	34.62	33.97	33.61	74.00	40.39	Peak
3	2400.00	27.61	6.62	34.64	53.20	52.79	74.00	21.21	Peak
4	2403.95	27.61	6.64	34.64	97.87	97.48	74.00	-23.48	Peak

Remarks: 1. Emission Level= Antenna Factor + Cable Loss - Amp Factor + Reading.
2. The emission levels that are 20dB below the official limit are not reported.

Test mode: GFSK(DH5)	2480MHz	Test channel:	Highest	Polarization	vertical
Hopping on					

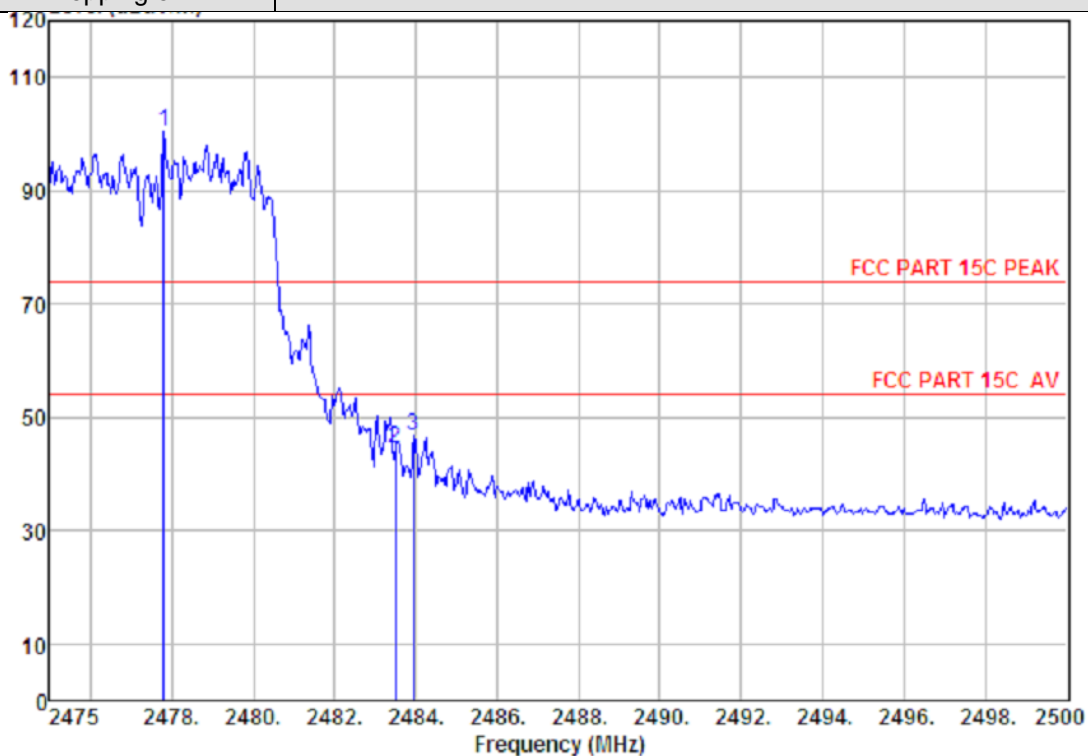

	Freq. (MHz)	Ant. Factor (dB/m)	Cable Loss (dB)	Amp Factor (dB)	Reading (dBuV)	Emission Level (dBuV/m)	Limits (dBuV/m)	Margin (dB)	Remark
1	2477.80	27.58	6.71	35.11	101.38	100.56	74.00	-26.56	Peak
2	2483.50	27.58	6.71	35.11	45.20	44.38	74.00	29.62	Peak
3	2483.95	27.58	6.71	35.11	47.48	46.66	74.00	27.34	Peak

Remarks: 1. Emission Level= Antenna Factor + Cable Loss - Amp Factor + Reading.
2. The emission levels that are 20dB below the official limit are not reported.

Test mode: GFSK(DH5)	2480MHz	Test channel:	Highest	Polarization	Horizontal
Hopping on					

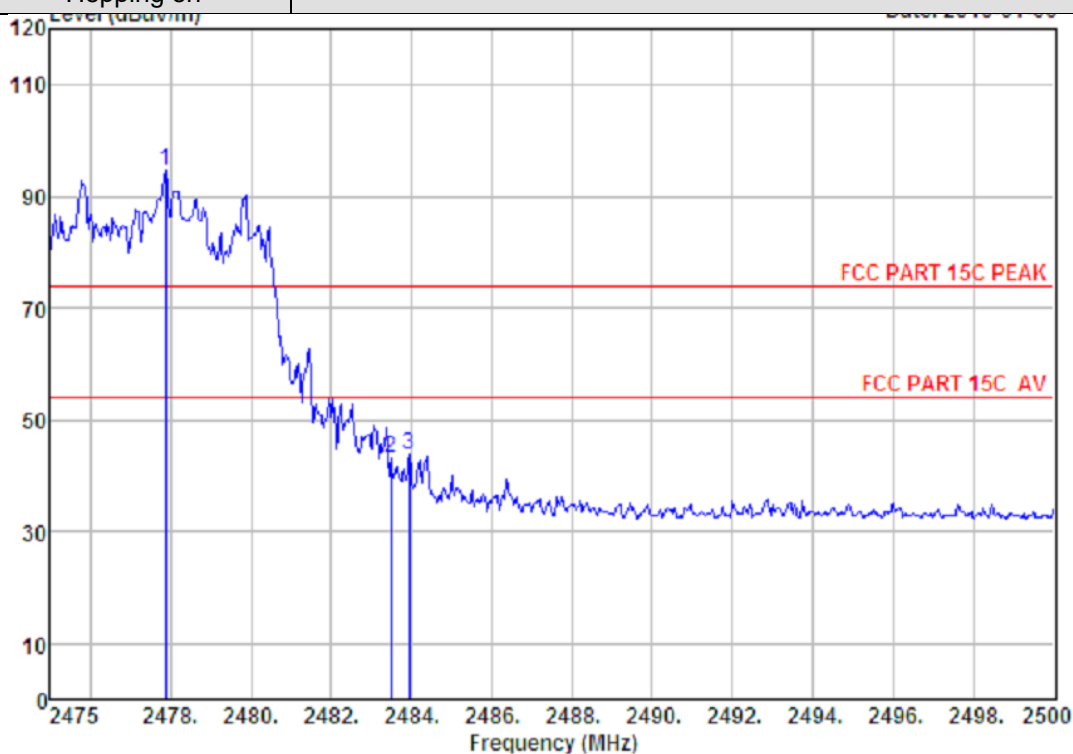

	Freq. (MHz)	Ant. Factor (dB/m)	Cable Loss (dB)	Amp Factor (dB)	Reading (dBuV)	Emission Level (dBuV/m)	Limits (dBuV/m)	Margin (dB)	Remark
1	2477.88	27.58	6.71	35.11	95.65	94.83	74.00	-20.83	Peak
2	2483.50	27.58	6.71	35.11	44.00	43.18	74.00	30.82	Peak
3	2483.95	27.58	6.71	35.11	44.75	43.93	74.00	30.07	Peak

Remarks: 1. Emission Level= Antenna Factor + Cable Loss - Amp Factor + Reading.
2. The emission levels that are 20dB below the official limit are not reported.

■ Spurious Emission below 1GHz (30MHz to 1GHz)

Only the worst case is recorded in the report.:

Test mode:	Transmitting	Vertical
------------	--------------	----------

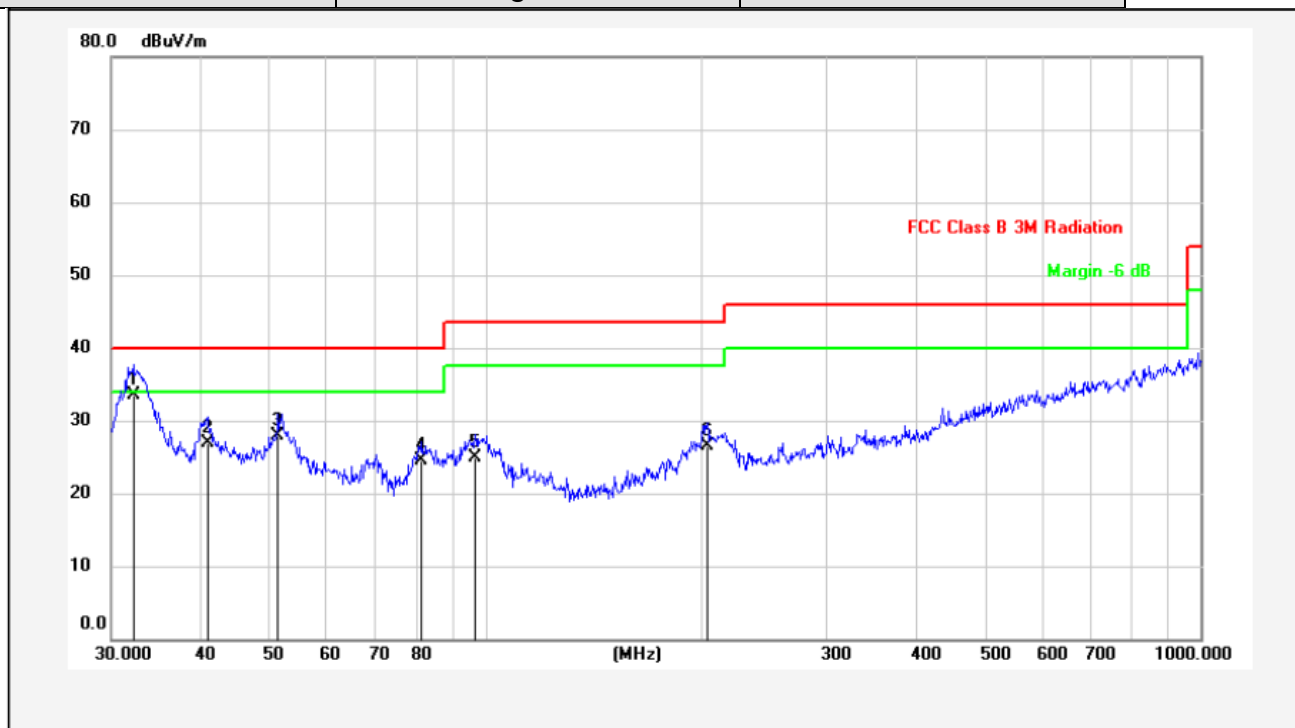

No.	Frequency (MHz)	Reading (dBuV/m)	Antenna (dB/m)	Cable (dB)	Result (dBuV/m)	Limit (dBuV/m)	Margin (dB)	Detector
1	32.1795	20.18	12.01	1.31	33.50	40.00	-6.50	QP
2	40.8445	12.12	13.5	1.38	27.00	40.00	-13.00	QP
3	51.3004	12.48	13.9	1.52	27.90	40.00	-12.10	QP
4	81.4969	14.00	8.65	1.85	24.50	40.00	-15.50	QP
5	96.7749	11.12	11.86	2.02	25.00	43.50	-18.50	QP
6	204.2376	12.09	11.54	2.87	26.50	43.50	-17.00	QP

Remarks: 1. Result=Reading+Antenna+Cable

2. If Peak Result complies with QP Limit, QP Result is deemed to comply with QP Limit.

Test mode:	Transmitting	Horizontal
------------	--------------	------------

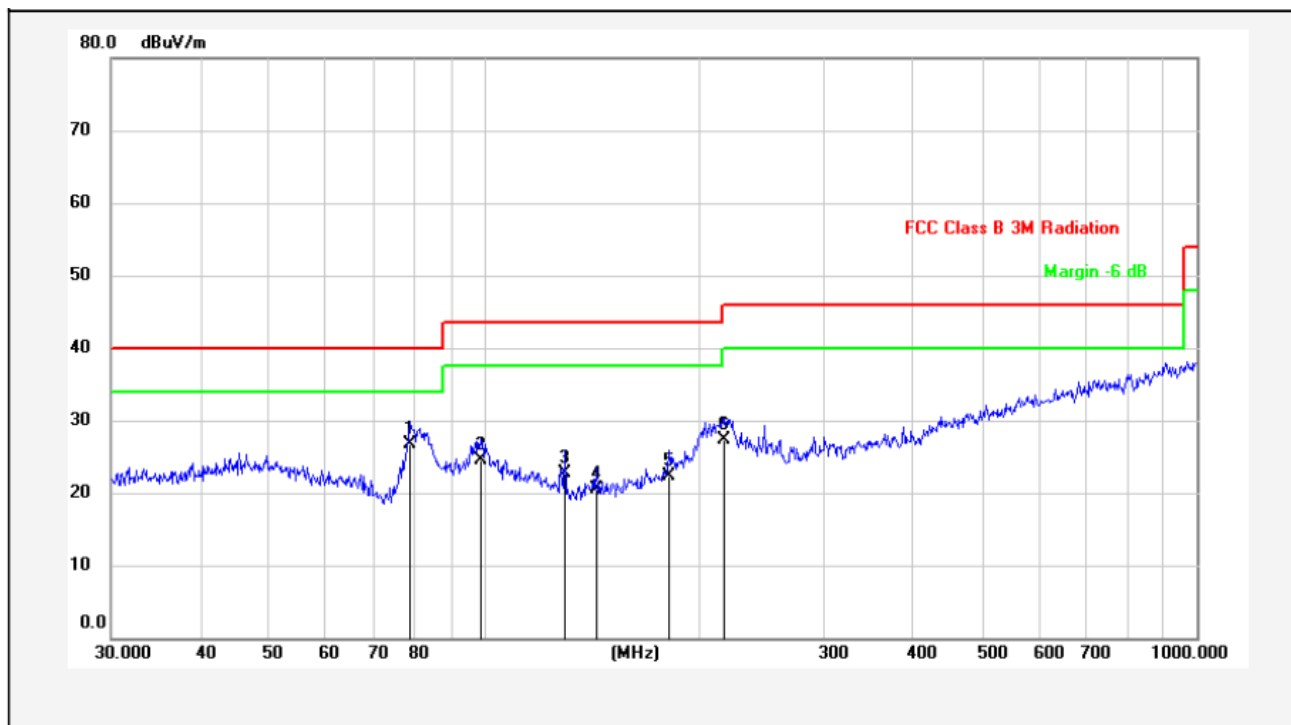

No.	Frequency (MHz)	Reading (dBuV/m)	Antenna (dB/m)	Cable (dB)	Result (dBuV/m)	Limit (dBuV/m)	Margin (dB)	Detector
1	78.6888	16.47	8.53	1.8	26.80	40.00	-13.20	QP
2	99.1796	9.95	12.49	2.06	24.50	43.50	-19.00	QP
3	129.9225	11.07	9.42	2.31	22.80	43.50	-20.70	QP
4	143.8294	8.84	9.15	2.51	20.50	43.50	-23.00	QP
5	181.9201	9.44	10.15	2.71	22.30	43.50	-21.20	QP
6	216.7828	12.52	11.84	2.94	27.30	46.00	-18.70	QP

Remarks: 1. Result=Reading+Antenna+Cable
2. If Peak Result complies with QP Limit, QP Result is deemed to comply with QP Limit.

4.7. CONDUCTED EMISSION TEST

4.7.1. Applicable Standard

According to FCC Part 15.207(a)

4.7.2. Conformance Limit

Conducted Emission Limit		
Frequency(MHz)	Quasi-peak	Average
0.15-0.5	66-56	56-46
0.5-5.0	56	46
5.0-30.0	60	50

Note: 1. The lower limit shall apply at the transition frequencies
2. The limit decreases in line with the logarithm of the frequency in the range of 0.15 to 0.50MHz.

Remark: Test results were obtained from the following equation:

$$\text{Measurement (dB}\mu\text{V)} = \text{LISN Factor (dB)} + \text{Cable Loss (dB)} + \text{Reading (dB}\mu\text{V)}$$

$$\text{Margin (dB)} = \text{Measurement (dB}\mu\text{V)} - \text{Limit (dB}\mu\text{V)}$$

4.7.3. Test Configuration

Test according to clause 6.3 conducted emission test setup

4.7.4. Test Procedure

The EUT was placed on a table which is 0.8m above ground plane.

Maximum procedure was performed on the highest emissions to ensure EUT compliance.

Repeat above procedures until all frequency measured were complete.

Test Results :

M/N	:	ST-61		
Test Mode	:	Charging		
Test Phase	:	Power Line; Live		
Test Voltage	:	DC 5V From Adapter Input AC 120V/60Hz (worse data)		
Temperature (°C):	24	Relative Humidity (%): 52	Atmospheric Pressure(kPa) :	101.7

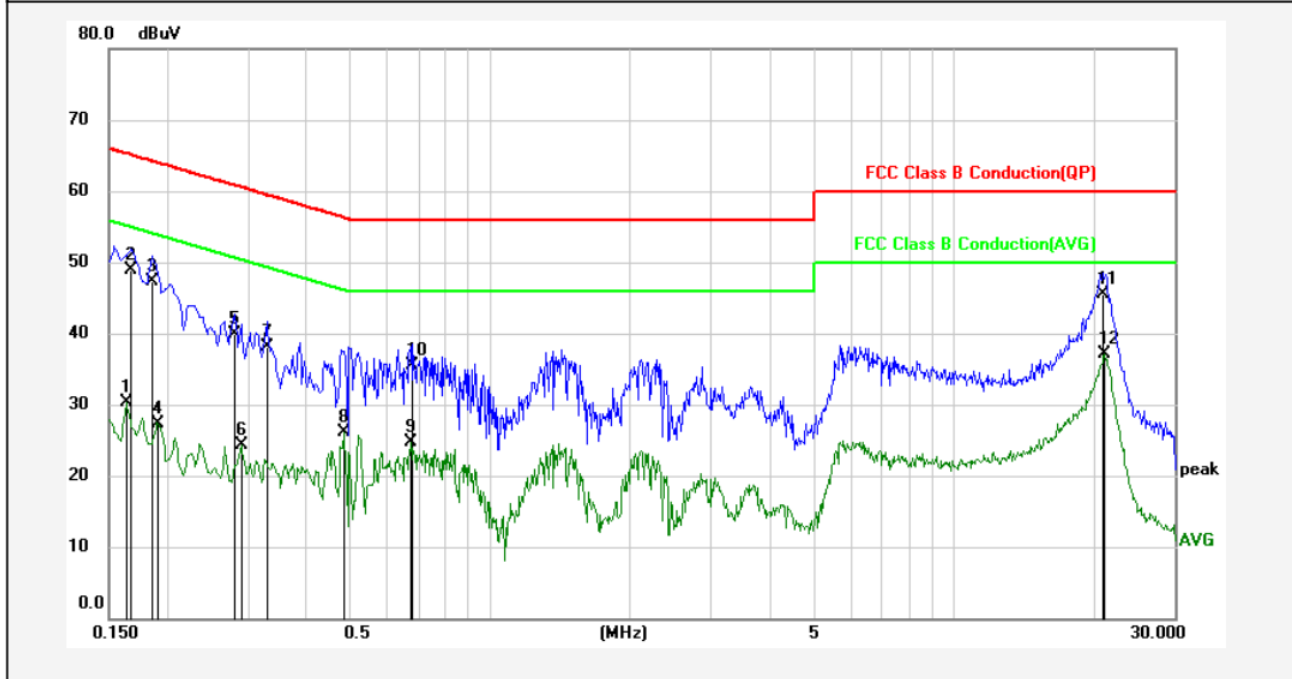

No.	Frequency (MHz)	Reading (dBuV)	Lisn/Isn (dB)	Cab_L (dB)	Result (dBuV)	Limit dBuV	Margin (dB)	Detector	Remark
1	0.1635	20.45	9.6	0.22	30.27	55.28	-25.01	AVG	
2	0.1680	39.08	9.6	0.22	48.90	65.06	-16.16	QP	
3	0.1859	37.48	9.6	0.22	47.30	64.22	-16.92	QP	
4	0.1912	17.38	9.6	0.23	27.21	53.98	-26.77	AVG	
5	0.2805	30.06	9.6	0.24	39.90	60.80	-20.90	QP	
6	0.2894	14.56	9.6	0.24	24.40	50.54	-26.14	AVG	
7	0.3300	28.36	9.6	0.24	38.20	59.45	-21.25	QP	
8	0.4829	16.37	9.57	0.24	26.18	46.29	-20.11	AVG	
9	0.6719	14.88	9.55	0.23	24.66	46.00	-21.34	AVG	
10	0.6808	25.72	9.55	0.23	35.50	56.00	-20.50	QP	
11	21.0839	35.48	9.82	0.2	45.50	60.00	-14.50	QP	
12	21.1920	27.06	9.82	0.2	37.08	50.00	-12.92	AVG	

Remarks: 1. Result=Reading+Lisn+Cab_L
 2. If the average limit is met when using a quasi-peak detector, the EUT shall be deemed to meet both limits and measurement with average detector is unnecessary.

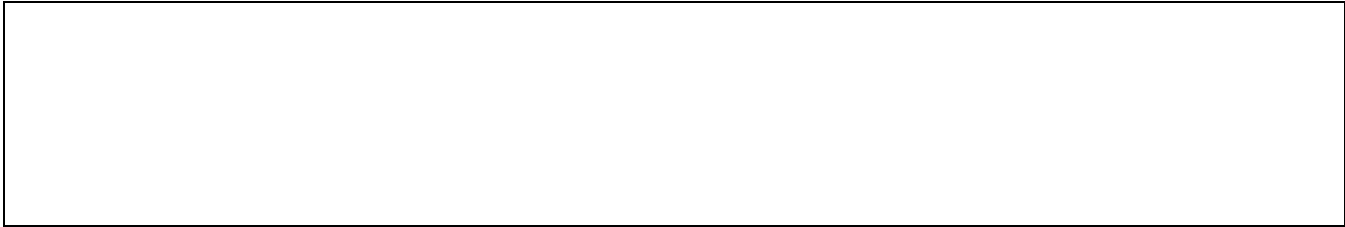

M/N	:	ST-61	
Test Mode	:	Charging	
Test Phase	:	Power Line; Neutral	
Test Voltage	:	DC 5V From Adapter Input AC 120V/60Hz (worse data)	
Temperature (°C):	24	Relative Humidity (%): 52	Atmospheric Pressure(kPa): 101.7

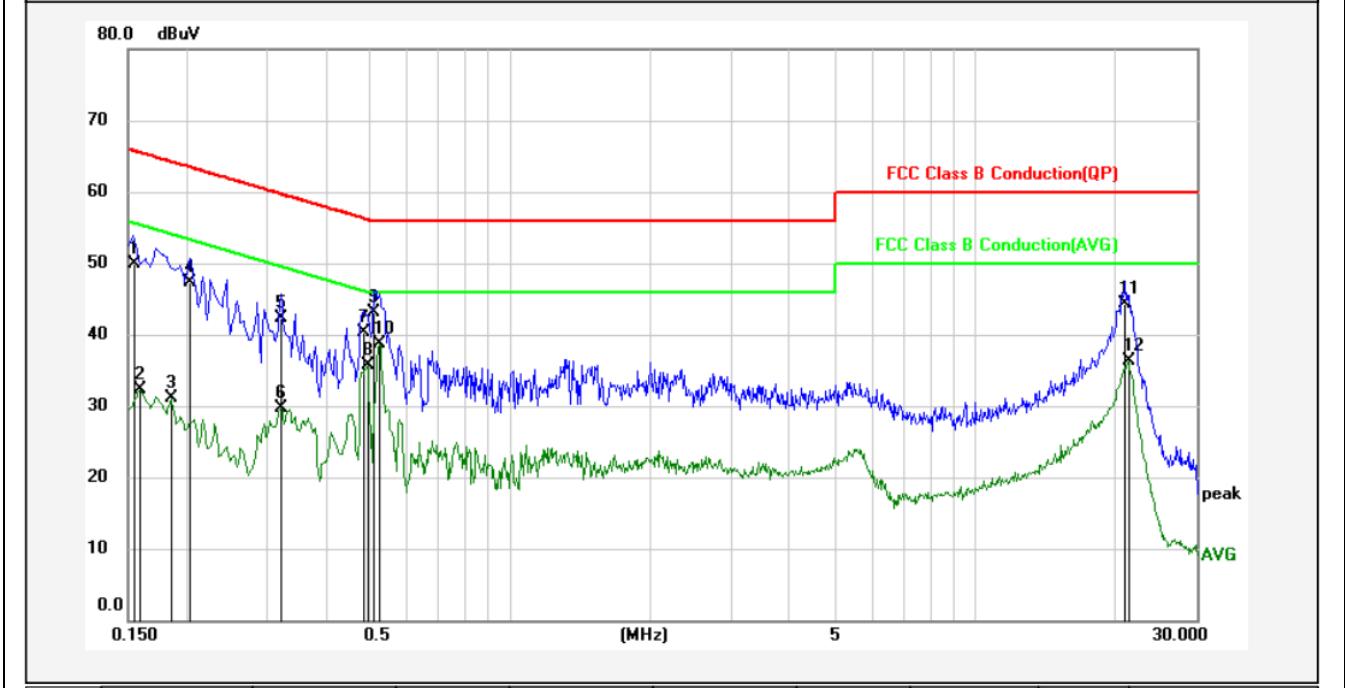

No.	Frequency (MHz)	Reading (dBuV)	Lisn/Isn (dB)	Cab_L (dB)	Result (dBuV)	Limit dBuV	Margin (dB)	Detector	Remark
1	0.1556	40.08	9.6	0.22	49.90	65.70	-15.80	QP	
2	0.1590	22.57	9.6	0.22	32.39	55.52	-23.13	AVG	
3	0.1859	21.28	9.6	0.22	31.10	54.22	-23.12	AVG	
4	0.2039	37.47	9.6	0.23	47.30	63.45	-16.15	QP	
5	0.3209	32.46	9.6	0.24	42.30	59.68	-17.38	QP	
6	0.3209	19.95	9.6	0.24	29.79	49.68	-19.89	AVG	
7	0.4829	30.49	9.57	0.24	40.30	56.29	-15.99	QP	
8	0.4919	25.92	9.57	0.24	35.73	46.14	-10.41	AVG	
9	0.5100	33.29	9.57	0.24	43.10	56.00	-12.90	QP	
10	0.5233	28.83	9.57	0.24	38.64	46.00	-7.36	AVG	
11	21.1155	34.38	9.82	0.2	44.40	60.00	-15.60	QP	
12	21.3810	26.19	9.83	0.2	36.22	50.00	-13.78	AVG	

Remarks: 1. Result=Reading+Lisn+Cab_L
 2. If the average limit is met when using a quasi-peak detector.
 the EUT shall be deemed to meet both limits and measurement
 with average detector is unnecessary.

4.8. ANTENNA APPLICATION

4.8.1. Antenna Requirement

Standard	Requirement
FCC CRF Part 15.203	An intentional radiator shall be designed to ensure that no antenna other than that furnished by the responsible party shall be used with the device. The use of a permanently attached antenna or of an antenna that uses a unique coupling to the intentional radiator shall be considered sufficient to comply with the provisions of this section. The manufacturer may design the unit so that a broken antenna can be replaced by the user, but the use of a standard antenna jack or electrical connector is prohibited. This requirement does not apply to carrier current devices or to devices operated under the provisions of §15.211, §15.213, §15.217, §15.219, or §15.221. Further, this requirement does not apply to intentional radiators that must be professionally installed, such as perimeter protection systems and some field disturbance sensors, or to other intentional radiators which, in accordance with §15.31(d), must be measured at the installation site. However, the installer shall be responsible for ensuring that the proper antenna is employed so that the limits in this part are not exceeded.

For intentional device, according to FCC 47 CFR Section 15.203, an intentional radiator shall be designed to ensure that no antenna other than that furnished by the responsible party shall be used with the device. And according to FCC 47 CFR Section 15.247 (b), if transmitting antennas of directional gain greater than 6dBi are used, the power shall be reduced by the amount in dB that the directional gain of the antenna exceeds 6dBi.

4.8.2. Result

PASS.

The EUT has 1 antenna: PCB antenna the gain is -0.58 dBi;

- Antenna use a permanently attached antenna which is not replaceable. Note:
- Not using a standard antenna jack or electrical connector for antenna replacement
- The antenna has to be professionally installed (please provide method of installation)

which in accordance to section 15.203, please refer to the internal photos.

Note:

which in accordance to section 15.203, please refer to the internal photos.

----- END OF REPORT -----