

产品规格说明书
PRODUCT SPECIFICATION

产品名称: G3
PRODUCT NAME

产品编码: G3
PRODUCT NUMBER

客户编码:
CUSTOMER NUMBER

编写: 曾庆雄

校对: 曾庆雄

批准: 张强

日期: 2023.06.15

深圳恒信达通信科技有限公司
SHENZHEN HXD COMMUNICATION TECH CO., LTD.
TEL:0755-61123122 FAX:0755-61123480

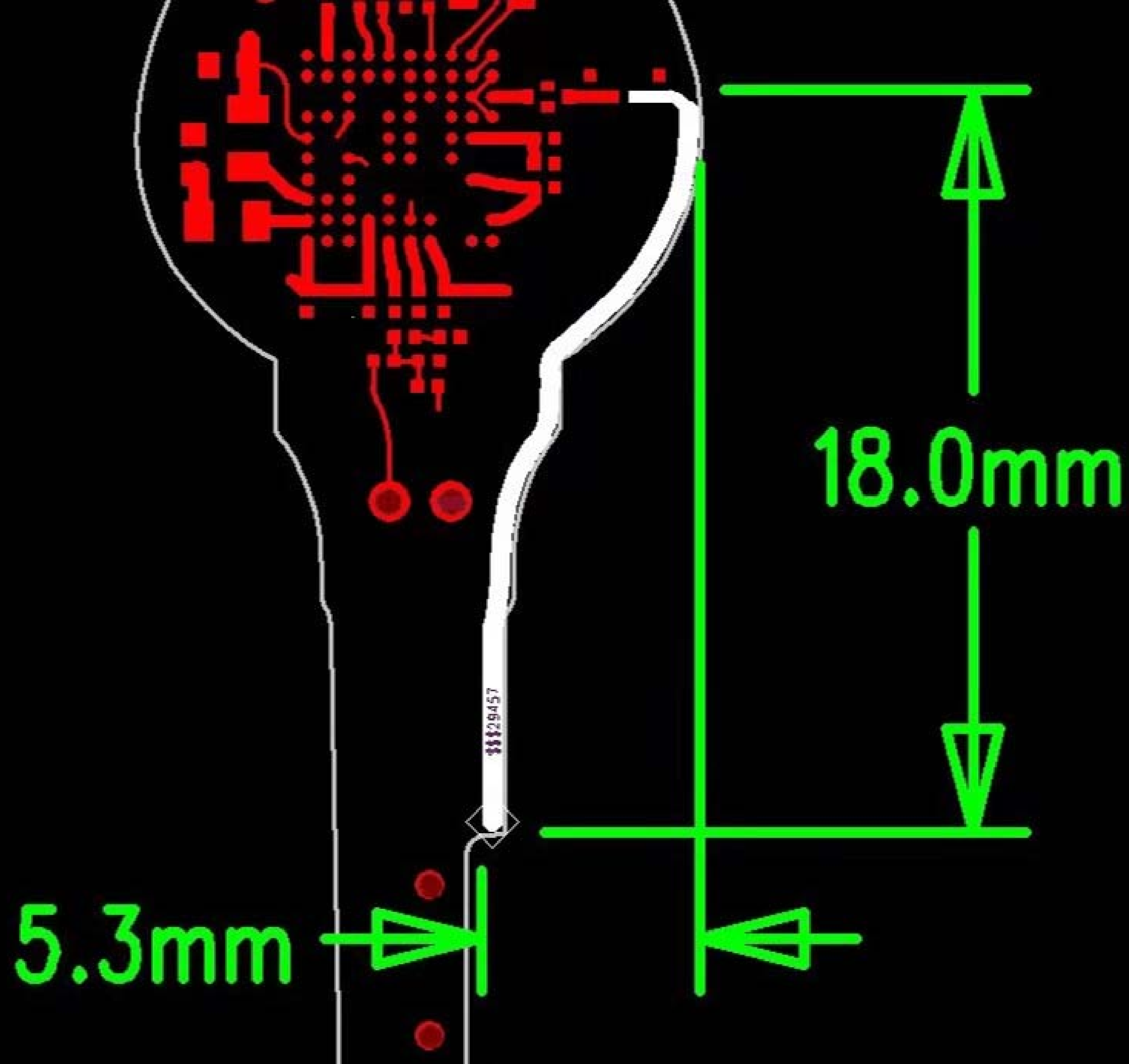

Antenna Specifications

BLUE TOOTH ANTENNA

匹配电路

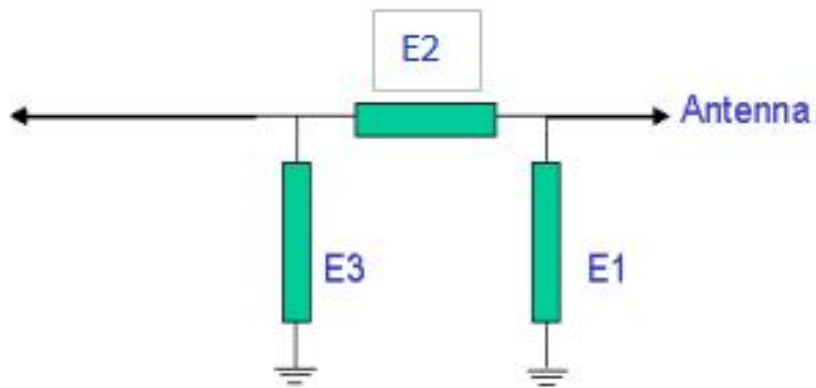

E1	NC	/
E2	0欧	/
E3	2PF	/

Antenna Specifications

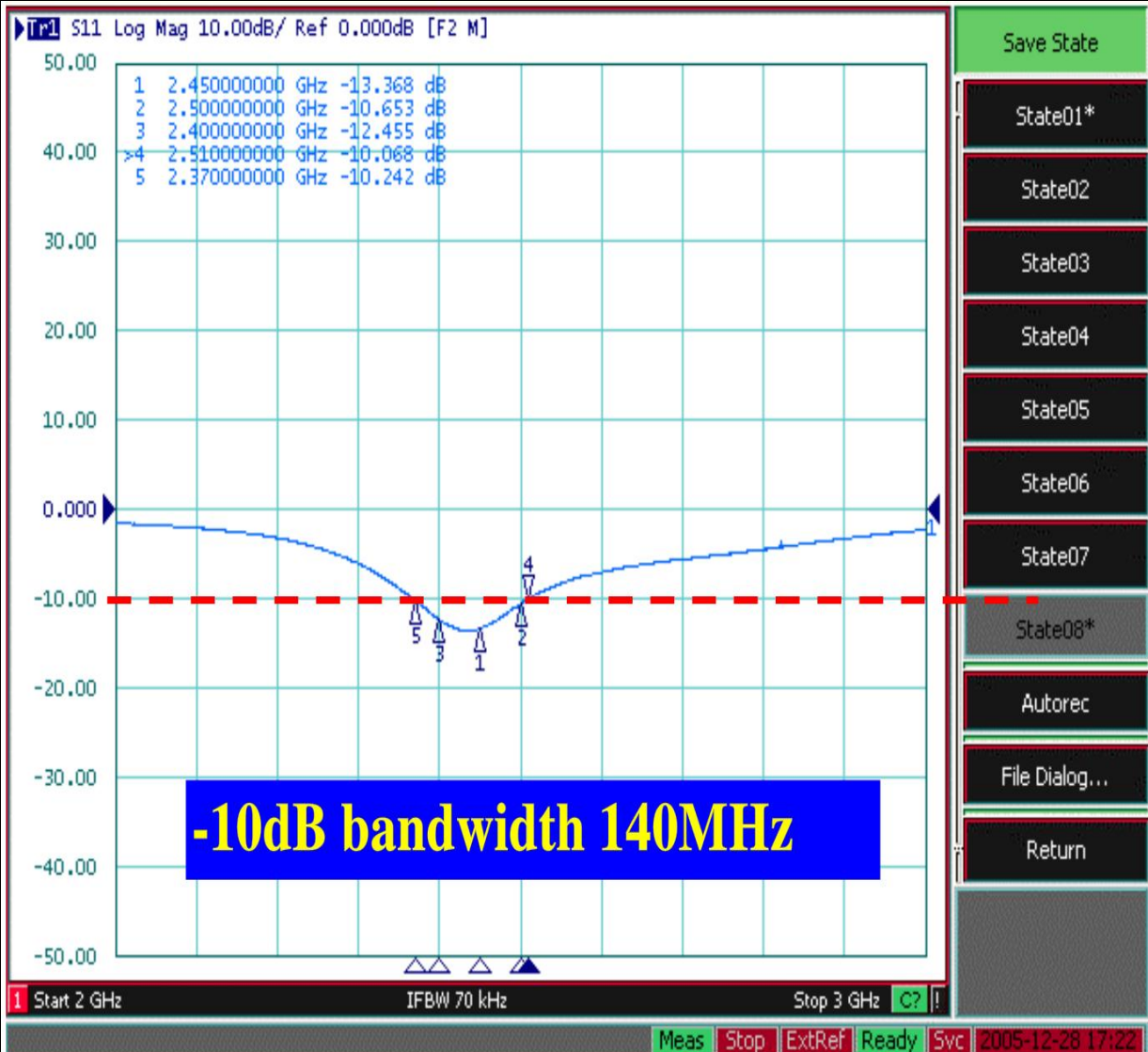

RETURN LOSS

Antenna Specifications

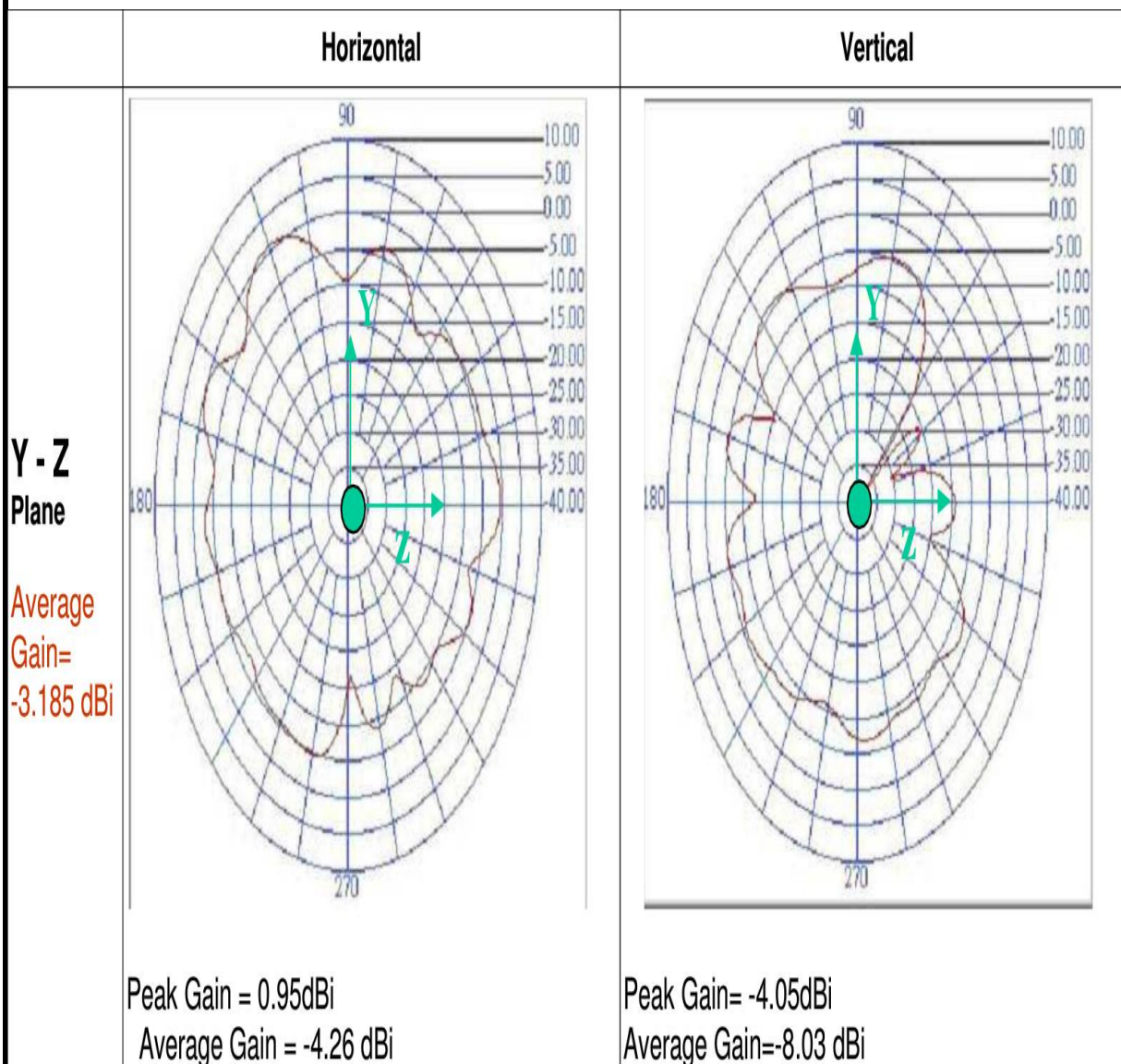

Y-Z PLANE

Antenna Specifications

X - Y
Plane

Average
Gain=
-1.543 dBi

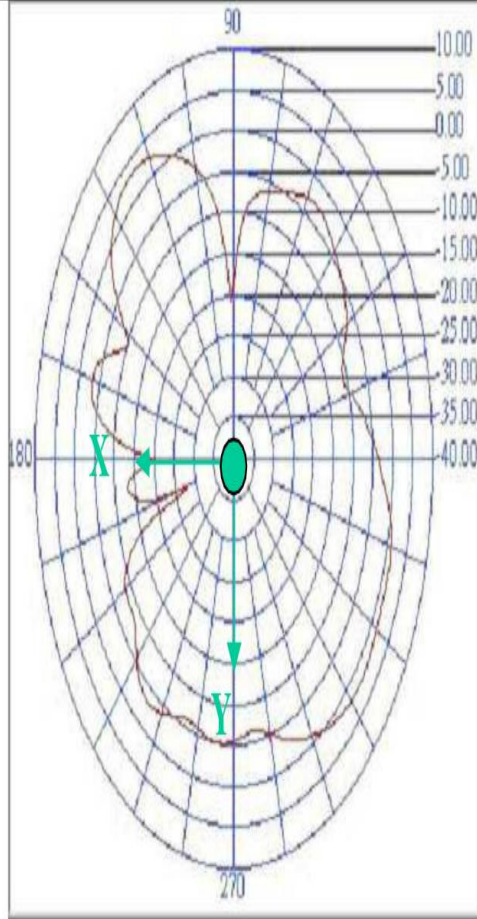

Peak Gain= 3.19 dBi
Average Gain= -2.65 dBi

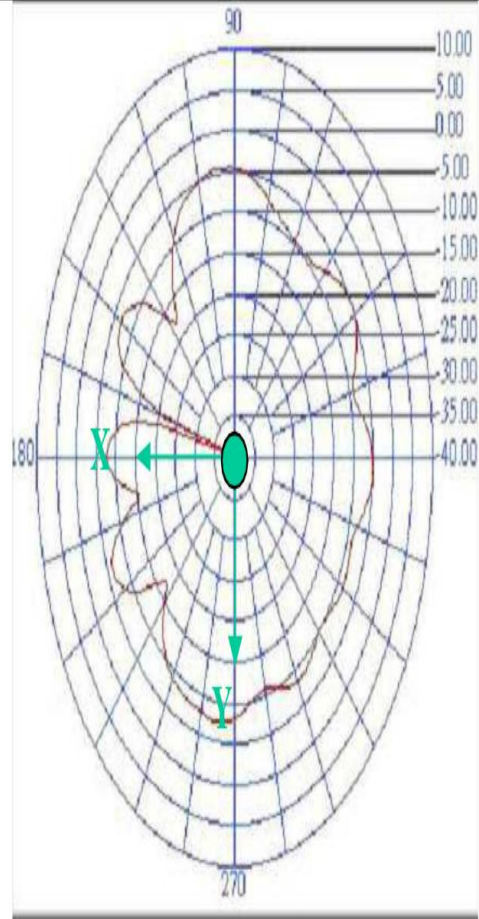

Peak Gain= -4.48 dBi
Average Gain= -8.02 dBi

X-Y PLANE

Antenna Specifications

**X - Z
Plane**

Average
Gain=
-0.99 dBi

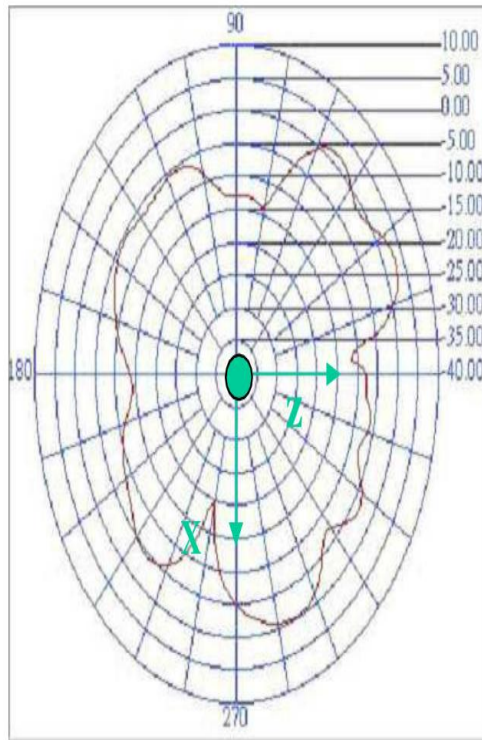

Peak Gain= 3.05 dBi
Average Gain= -4.10dBi

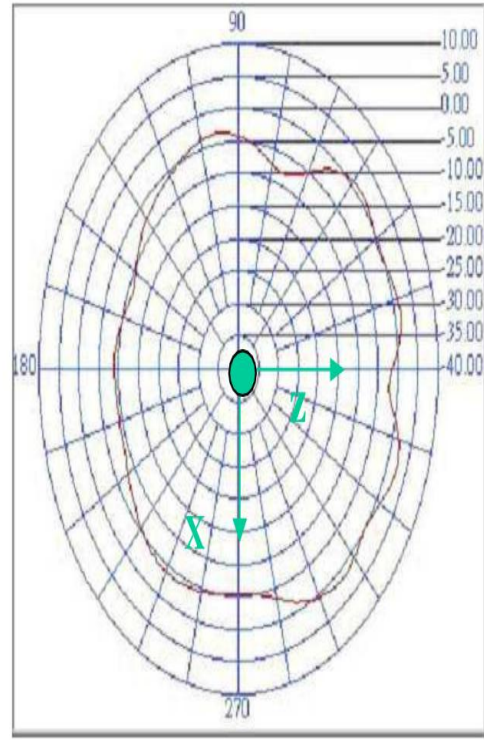

Peak Gain= 2.49 dBi
Average Gain= -2.47 dBi

X-Z PLANE