

JOYVOLT

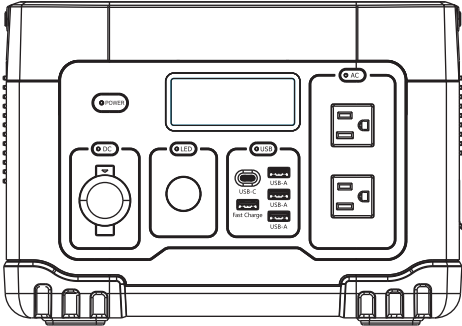

User Manual

JV600

Please read this manual carefully before use
Please keep this manual properly for future review

Thank you for choosing us.

This product manual is intend to provide the latest product security information at the time of publication.

Actual AC outlet, AC output voltage and frequency vary by country or region.

Before use, please read the user manual of this product carefully, to ensure the safe operation after full understanding. Once using this product, you are deemed to have understood, recognized and accepted all the terms and content of this document.

The user undertakes to be responsible for his own actions and all consequences arising therefrom.

The Company reserves the right of final interpretation of this document and all related documents of this product.

NOTICE

All the illustrations in this manual are based on the JV600 515Wh

CONTENTS

I . Safety Instructions	1
II. Specifications	2
III. Product Use	
3.1 Appearance	3
3.2 Display Instructions	3-4
3.3 Product Use	4-7
3.4 AC Charging	7
3.5 Solar Charging	7
3.6 Car Charging	7
IV. Fault Display and Troubles Shooting	8-10
V. Common Problem	10
VI. Accessories	11
VII. Maintenance	11

I、Safety Instructions

Indicative explanation of the regulation on the management of the recycling and disposal of waste electrical and electronic products



In order to better care and protect the Earth, when users no longer need this product or when the product's lifespan ends, please comply with the relevant laws and regulations on the recycling and disposal of discarded electrical and electronic products, and hand it over to a local manufacturer with nationally recognized recycling and disposal qualifications for recycling and disposal. Improper use or disposal may have an impact on the environment and human health.

Important Safety Information



Warning-The following basic precautions must always be observed when using this product:

- ★ The optimal ambient storage temperature of this product should be kept at 10-35°C (50°F-95°F).
- ★ Repair shall only be carried out by qualified personnel of the Company.
- ★ Do not put any part of your fingers, palms, or body into the product.
- ★ The use of non-recommended accessories may cause fire, electric shock or personal injury.
- ★ Do not place this product near chemicals or where chemicals may leak.
- ★ When the product needs maintenance or repair, do not dismantle the products by yourself. Please deliver the products to our qualified service provider. The wrong disassembly method may cause a risk of fire or electric shock.
- ★ When the product fails, in order to reduce the risk of electric shock, please remove the products from the socket before conducting any guided maintenance operation.
- ★ Please charge the battery in a well-ventilated place to ensure the product air cooling system works well.
- ★ Do not place heavy objects on this product.
- ★ Do not expose the product to environment of high humidity, corrosive gas or flame.
- ★ Close supervision is required when using this product near children.

II、Specifications

General

Model	JV600	
Capacity	515Wh 22.2V	
Size	294*188*207mm	L * W * H
Weight	Gross Weight~8.5Kg	N.W.~6Kg

Input

AC Input Voltage	90~260Vac	Voltage over this range will cause charging failure.
AC Input Power	100W Max	
Solar Input	200W Max	
Car Charge input	13Vdc 10A	

Output

AC (×2)	120Vac 60Hz 600W Rated	
USB-A (×3)	5Vdc 2.4A 12W Max per port	
USB-A Fast Charge (×1)	5Vdc 3A/9Vdc 2A/12 Vdc 1.5A 18W Max.	
Type-C Fast Charge (×1)	5Vdc 3A/9Vdc 3A/12Vdc 3A/15Vdc 3A/20Vdc 3.25A 65W	
Cigarette Lighter (1)	13Vdc 10A	
Wireless	10W	

Others

Cell Type	NCM	
Circle Life	500 cycles to 80% capacity, @25°C charge and discharge environment	
Protection	Overcharge protection, high temperature protection, low temperature protection, overdischarge protection, overload protection, short circuit protection, overcurrent protection, battery fault protection	
Charging Temperature	6~40°C(42.8°F-104°F)	
Discharge Temperature	-10~45°C(14°F-113°F)	
Working Humidity	0% -90% (Non-condensate)	
Product Expansion	N/A	

Accessories

Power station*1, AC adapter*1,
Car charging cable*1, User manual*1 Warranty Card*1

III、Product Use

3.1 Appearance Display

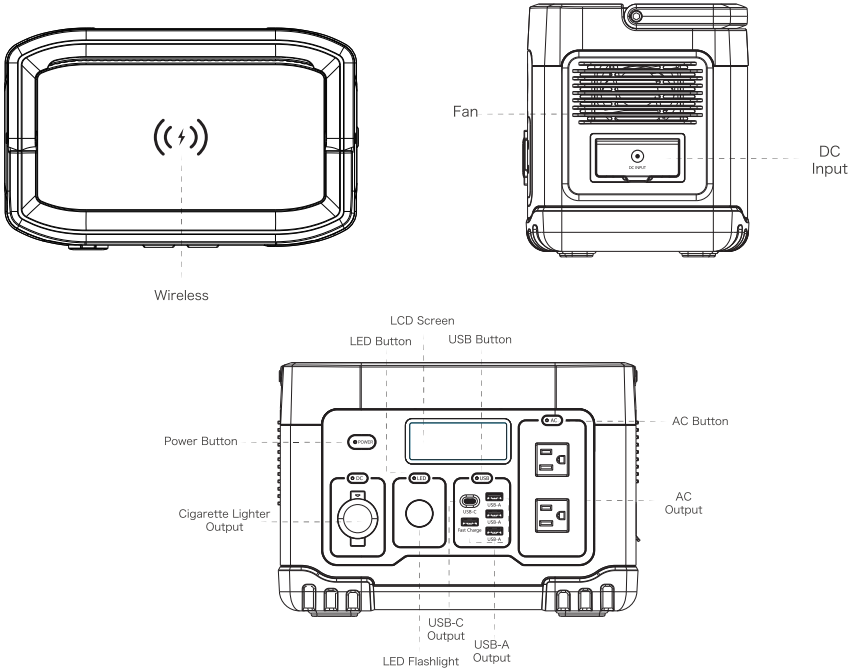

3.2 Display Screen Introduction

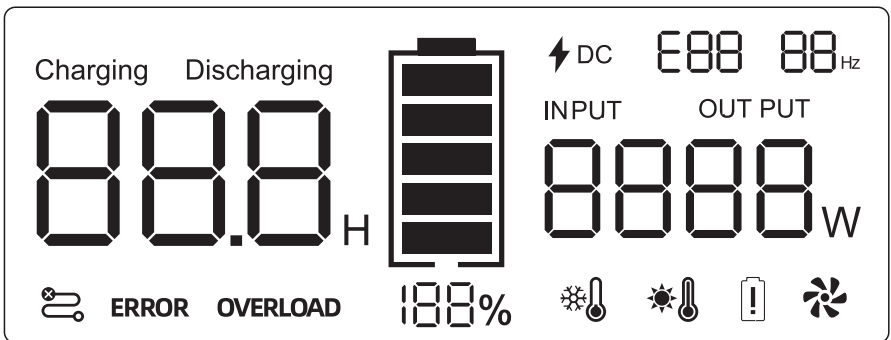

88.8. displays the remaining charge / discharge time.

8888_w displays the current charge / discharge power.

Charging indicates remaining charging time.

Discharging indicates remaining discharge time.

 indicates communication failure, you can contact after-sales service company.

ERROR indicates errors besides the battery pack.

OVERLOAD indicates the overload / overcurrent occurs in the process of use. The load power needs to be checked, which cannot be greater than the rated output power.

H means time is measured in hours

 shows the current battery capacity level.

 DC shows current charging.

EEB Shows faults such as overtemperature, overcurrent and so on.

 displays the current AC output frequency.

INPUT shows the current input power.

OUT PUT shows current output power.

W means Watt

 % shows the current battery power ratio.

 indicates the power station is protected from low temperature. Please stop use and maintain it in appropriate temperature .

 indicates that the machine is protected from high temperature. Please stop use and maintain it in appropriate temperature.

indicates battery pack fails due to the low / high temperature of the battery pack.

 Please put the power station at room temperature at least for 2 hours and then switch it on again. If it still doesn't work, please contact the after-service of the company.

***For more fault display and handling information, please refer to the fourth section of this manual.**

3.3 Product Use

Turn on/off and display

★ Press the power switch for about 2.5 seconds to turn on the entire machine. After turning on, the display screen will light up.

★ When the product continues for 5 minutes without any operation, it enters a sleep state and the screen automatically closes. Press any button to turn on the LCD display. Warm reminder: When activating the LCD screen, except for the power button and LED lighting

button, when using other buttons to activate, the LCD screen will first light up. After opening the LCD screen, when you press the button again, the corresponding function port will open. When the port is closed, the corresponding function port will be closed when the LCD screen is opened. Be careful and safe!

- ★ When the product has buttons and warnings, the display screen will automatically light up.
- ★ Press the power switch again for about 2.5 seconds to turn off this product (it is normal to not turn it off while charging).
- ★ The default standby time of this product is 120 minutes. If other power switches are not turned on and the product cannot be accessed or charged, the product will automatically shut down after 120 minutes.

POWER button logic and functions

- ★ In the shutdown state, press the POWER button for about 2.5s, the display screen will turn on, and the product will enter the startup state.
- ★ When the display screen is turned on during startup, the device starts to power on. After initialization for about 5 seconds, it will display normally. Other key functions can only be operated and used normally after initialization is completed.
- ★ Press the POWER button again in the power on state, hold it down for about 2.5 seconds, the display screen will turn off, and the device will enter the power off state, but the product will not shut down in the charging state. All functions of the device cannot be used while it is turned off. When the device first enters the shutdown state, if other button functions have been turned on, due to the presence of energy storage components in the circuit, the button indicator light will continue for several seconds before turning off.
- ★ If you need to turn off the screen immediately, please briefly press the POWER button.

USB button logic and functions

- ★ When the display screen is turned on and the power is on, short press the USB button to turn on/off the USB-A, QC3.0, and PD output ports. When the display screen is in a closed state, short press the USB button to turn on the display screen first, and then short press the USB button again to turn on/off the USB-A, QC3.0, and PD output ports.

- ★ When the USB power is turned on, the system defaults to turning on the display screen, displaying the current battery level of the product, and the light on the USB button will also be lit.
- ★ If there is no output power within 120 minutes after the USB is turned on, it will automatically turn off the USB.

AC button logic and function

- ★ In the power on state and with the display screen turned on, briefly press the AC button to turn on/off the AC output port. When the display screen is turned off, briefly press the AC button to turn on the display screen, and then press the AC button again to turn on/off the DC cigarette lighter output port.
- ★ When the AC power is turned on, the system defaults to opening the display screen, displaying the current battery level and corresponding fixed symbols of the product.
- ★ If there is no output power within 60 minutes after AC is turned on, AC will automatically turn off.

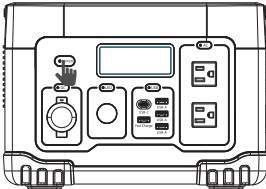

Press POWER switch

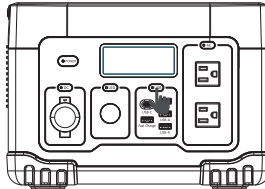

Short press USB power switch

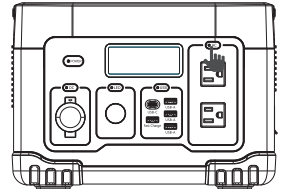

Short press AC power switch

DC button logic and function

- ★ In the power on state and with the display screen turned on, briefly press the DC button to turn on/off the DC cigarette lighter output port. When the display screen is turned off, briefly press the DC button to turn on the display screen, and then press the DC button again to turn on/off the DC cigarette lighter output port.
- ★ When the DC power is turned on, the system defaults to opening the display screen, displaying the current battery level of the product, and the light on the DC button will also be lit.
- ★ If there is no output power within 120 minutes after the DC is turned on, it will automatically turn off the DC.

LED button logic and function

- ★ In the power on state, short press the LED power switch to turn on LED lighting.
- ★ Turn on low light mode when turning on LED lighting for the first time; Press again in low light mode to switch to high light mode; Press again in high light mode to enter SOS mode; Press again in SOS mode to turn off the LED lighting function.

3.4 AC Charging

This product comes standard with a 100W AC adapter for AC charging, with an input power of up to 100W. Please always use the standard adapter model of this product (as shown in the figure above), and do not use adapters of other models. It will take about 4 hours to fully charge. Please use the standard charger to avoid damaging the device or charger!

When this product is charged and discharged simultaneously, the charging power and discharge power are displayed in a cycle. The cycle time is 5 seconds for the charging power display, and then it is switched to 5 seconds for the discharge power display to cycle.

3.5 Solar Charging





Please use the solar panels directly or in series within 200W to charge the product according to the diagram below. (The following figure P8)

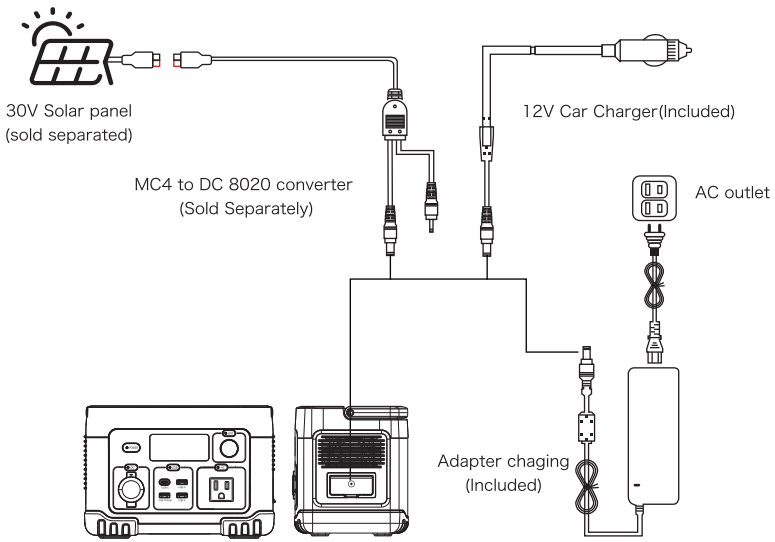

3.6 Car Charging

This power station can be charged by car. It supports 12V/24V 10A car charging.. It is better to use the car to charge after start, so as not to cause the car battery power loss. At the same time, please connect the car charge cable with your car cigarette lighter outlet well. We assume no liability for damage caused by user's fault operations.



IV、Fault Display and Trouble Shooting

Icon	Fault Description	Fault Type	Trouble Shooting
E00	 The icon flashes with three times buzzer alarm	Low temperature warning for charge	Please use the product in the recommended environment. The fault will remove automatically when the temperature changes to normal
E01	 The icon flashes with three times buzzer alarm	High temperature warning for charge	Please use the product in the recommended environment, continue to run the cooling fan, and check whether the cooling air outlet is blocked. The fault will remove after the temperature turn to normal
E09	 The icon flashes with three times buzzer alarm	Low temperature warning for discharge	Please use the product in the recommended environment. The fault will remove automatically when the temperature changes to normal
E10	 The icon flashes with three times buzzer alarm	High temperature warning for discharge	Please use the product in the recommended environment, continue to run the cooling fan, and check whether the cooling air outlet is blocked. The fault will remove after the temperature turn to normal

E11	The icon ERROR flashes with three times buzzer alarm and  will be displayed, the fan may stop working.	Discharge low voltage protection alarm	Perform charging operation and automatically recover when the battery level exceeds 1%.
E16	The icon ERROR flashes, OVERLOAD bright gets up with three times buzzer alarm	AC output overcurrent protection alarm	Check whether the AC port is overloaded
E17	The icon ERROR flashes with three times buzzer alarm	High temperature warning for inverter	Check whether the cooling outlet is blocked. The fault will remove after the temperature changes to normal
E22	The icon ERROR flashes with three times buzzer alarm	Short-circuit warning for inverter	Check whether AC load is short-circuited
E24	 The icon flashes with three times buzzer alarm	Abnormal communication warning between main control and inverter	Contact after-sales service
E33	The icon ERROR flashes, OVERLOAD bright gets up with three times buzzer alarm	Overcurrent warning for car cigarette lighter	Please check whether the cigarette lighter port is overloaded. Restart the products after the overload is removed
E35	The icon ERROR flashes with three times buzzer alarm	Short circuit warning for car cigarette lighter	Please check whether the cigarette lighter port is overloaded. Restart the products after the overload is removed
E45	The icon ERROR flashes with three times buzzer alarm and the discharge time displays abnormally	Short circuit or overcurrent warning for USB	Check whether USB port is overload or short circuit. Remove overload and the fault remove
E49	The icon ERROR flashes with three times buzzer alarm and the discharge time displays abnormally	Short circuit or overcurrent warning for QC 3.0	Check whether QC 3.0 port is overload or short circuit. Remove overload and the fault remove
E85	The icon ERROR flashes with three times buzzer alarm and the fan may stop working.	Prohibit the use of AC output function as the battery level is below 5%	Perform charging operation, automatically recover when the battery level exceeds 7%, and the AC function can be started to use at the same time.

If the warning occurs during the use, the alarm icon does not disappear after you restart the power station, please stop using it immediately (do not try to charge and discharge).

*** If the above information can not solve your problem, please contact the customer service for consultation.**

V、FAQ(Frequently Asked Questions)

1. How to use this product after I just received it?

★ The battery capacity of the delivered product is about 30%, and we recommended you to charge the product up to 100% capacity before use. It can be fully charged by standard charger in about 3.5h. Please use original charger, solar panel and car charging cable. When charging with solar panels, the charge time depends on the sunshine exposure condition.

2. What kind of battery is used for this product? How long is the life span?

★ The cell type is NCM. It can reach 500 full cycles to 80% capacity.

3. What devices can the output ports of this product adapt to?

★ Our product has a wide range of DC output ports, with 6 ports for charging devices such as mobile phones, drones, and laptops. There are two AC output ports, with a rated power of up to 600W and a peak power of up to 1200W, which can supply power to most household appliances. Before use, it is recommended to confirm that the power of the appliance is less than the rated power of this product.

4. How can I confirm how long this product will last?

★ The screen shows the rest of hours of capacity life based on current load.

5. Can it be charged and discharged at the same time?

★ Yes, it supports pass through charging. If the discharge power is less than the charging power, the power source is from the charging.

6. How to store this product?

- ★ For short-term, please charge the power station to 50% power level before storage. If the power station won't be used for a long period of time, it should be recharged every 3-6 months and keep the power above 60%. Please always keep it in a cool and dry place.

7. How long is the warranty of this product?

- ★ Two years . Within 2 years, No-man-made quality problem can be repaired by us without charge. About freight, We pay for the back and forth freight for the first half year. After that, you will need to pay for return freight.

8. Other instructions for this product

- ★ This product is non-waterproof. Do not carry it on the plane. And repair must be carried by professional service.

VI. Product accessories

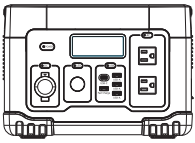

Power Station 600W

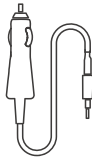

Car Charger Cable

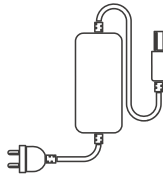

AC Adapter



User Manual



Warranty Card

VII. Maintenance

- ★ The best storage environment temperature of this product should be kept at 10°C-35°C (50°F-95°F).
- ★ When the product is stored for a long time, it is recommended to be fully recharged every 3-6 months and keep the power above 60% to prolong the service life of the product.
- ★ If the product runs out of battery after long-term storage, just plug in the charger to charge it.
- ★ In wet season, please pay more attention to maintain the product, use water-proof bag to keep it from water and check before every use.

FCC Warning

This device complies with part 15 of the FCC Rules. Operation is subject to the following two conditions: (1) This device may not cause harmful interference, and (2) this device must accept any interference received, including interference that may cause undesired operation.

Any Changes or modifications not expressly approved by the party responsible for compliance could void the user's authority to operate the equipment.

Note: This equipment has been tested and found to comply with the limits for a Class B digital device, pursuant to part 15 of the FCC Rules. These limits are designed to provide reasonable protection against harmful interference in a residential installation. This equipment generates uses and can radiate radio frequency energy and, if not installed and used in accordance with the instructions, may cause harmful interference to radio communications. However, there is no guarantee that interference will not occur in a particular installation. If this equipment does cause harmful interference to radio or television reception, which can be determined by turning the equipment off and on, the user is encouraged to try to correct the interference by one or more of the following measures:

- Reorient or relocate the receiving antenna.
- Increase the separation between the equipment and receiver.
- Connect the equipment into an outlet on a circuit different from that to which the receiver is connected.
- Consult the dealer or an experienced radio/TV technician for help.

This equipment complies with FCC radiation exposure limits set forth for an uncontrolled environment. This equipment should be installed and operated with minimum distance 20cm between the radiator & your body.

JOYVOLT



设计	大乔	23.05.15
校对	伯约 王	23.05.15
审核		
工艺		
标准化		
批准		
品名	锂电池便携储能电源产品说明书	
物料描述	说明书_Rp600_JOYVOLT_美规_ 封面157g铜版纸, 内页80g双胶纸_骑马钉	
料号	614-00008-01	
尺寸	210*140mm	
材质	封面157g铜版纸, 内页80g双胶纸_骑马钉	
公差	±3mm	
单位	mm	
比例	1:1	
版本	V1	