

**ELECTROMAGNETIC EMISSIONS COMPLIANCE REPORT  
INTENTIONAL RADIATOR CERTIFICATION TO  
FCC PART 15 SUBPART C REQUIREMENT**

*OF*

**Portable Outdoor Power Supply**

**Model No.: JV2000**

**Trademark: **

**FCC ID: 2BBM4-JV2000**

**Report No.: E01A23060151F00501**

**Issue Date: July 11, 2023**

*Prepared for*

**Chongqing Radiance Energy Technology Co., Ltd**

**No. 27-3 Fengsheng Road, Jiu Long Po District, Chongqing City, China**

*Prepared by*

**Dong Guan Anci Electronic Technology Co., Ltd.**

**1-2 Floor, Building A, No.11, Headquarters 2 Road, Songshan, Lake  
Hi-tech Industrial Development Zone, Dongguan City, Guangdong Pr.,  
China.**

**This report shall not be reproduced, except in full, without the written approval of  
Dong Guan Anci Electronic Technology Co., Ltd.**

**VERIFICATION OF COMPLIANCE**

Applicant:	Chongqing Radiance Energy Technology Co., Ltd No. 27-3 Fengsheng Road, Jiu Long Po District, Chongqing City, China
Manufacturer	Chongqing Radiance Energy Technology Co., Ltd No. 27-3 Fengsheng Road, Jiu Long Po District, Chongqing City, China
Product Description:	Portable Outdoor Power Supply
Trade Mark:	N/A
Model Number:	JV2000

**We hereby certify that:**

The above equipment was tested by Dong Guan Anci Electronic Technology Co., Ltd. The test data, data evaluation, test procedures, and equipment configurations shown in this report were made in accordance with the procedures given in ANSI C63.10-2013 and the energy emitted by the sample EUT tested as described in this report is in compliance with conducted and radiated emission limits of FCC Rules Part 15.209(2020).

Date of Test : June 14, 2023 to June 26, 2023

Prepared by : Duke Liu  
Duke Liu / Editor

Reviewer &  
Authorized Signer : Tiger Xu  
Tiger Xu / Supervisor



## Modified Information

Version	Summary	Revision Date	Report No.
Ver.1.0	Original Report	/	E01A23060151F00501

## Table of Contents

<b>1 GENERAL INFORMATION .....</b>	<b>5</b>
1.1 PRODUCT DESCRIPTION .....	5
1.2 RELATED SUBMITTAL(S) / GRANT(S) .....	6
1.3 TEST METHODOLOGY .....	6
1.4 SPECIAL ACCESSORIES .....	6
1.5 EQUIPMENT MODIFICATIONS .....	6
1.6 TEST FACILITY.....	6
<b>2 SYSTEM TEST CONFIGURATION.....</b>	<b>7</b>
2.1 EUT CONFIGURATION .....	7
2.2 EUT EXERCISE .....	7
2.3 TEST PROCEDURE .....	7
2.4 CONFIGURATION OF TESTED SYSTEM.....	8
<b>3 SUMMARY OF TEST RESULTS.....</b>	<b>8</b>
<b>4 TEST SYSTEM UNCERTAINTY.....</b>	<b>9</b>
<b>5 CONDUCTED EMISSIONS TEST .....</b>	<b>10</b>
5.1 MEASUREMENT PROCEDURE .....	10
5.2 TEST SET-UP (BLOCK DIAGRAM OF CONFIGURATION) .....	10
5.3 MEASUREMENT EQUIPMENT USED.....	10
5.4 CONDUCTED EMISSION LIMIT .....	10
5.5 MEASUREMENT RESULT .....	11
5.6 CONDUCTED MEASUREMENT PHOTO.....	14
<b>6 RADIATED EMISSION TEST.....</b>	<b>15</b>
6.1 MEASUREMENT PROCEDURE .....	15
6.2 TEST SET-UP (BLOCK DIAGRAM OF CONFIGURATION) .....	15
6.3 MEASUREMENT EQUIPMENT USED.....	16
6.4 RADIATED EMISSION LIMIT .....	16
6.5 MEASUREMENT RESULT .....	18
6.6 RADIATED MEASUREMENT PHOTOS.....	24
<b>7 20DB BANDWIDTH.....</b>	<b>25</b>
7.1 20DB BANDWIDTH LIMIT .....	25
7.2 TEST INSTRUMENTS.....	25
7.3 TEST PROCEDURE .....	25
7.4 TEST SETUP.....	25
7.5 TEST RESULT.....	25
<b>8 ANTENNA APPLICATION .....</b>	<b>27</b>
8.1 ANTENNA REQUIREMENT .....	27
8.2 RESULT .....	27

## 1 General Information

### 1.1 Product Description

Characteristics	Description
Product Name	Portable Outdoor Power Supply
Model number	JV2000
Operation Mode	Wireless Charging
Input Rating	110Vac, 60Hz, 1650W Max
Power Supply	AC110V/60Hz
Operating Frequency	110-205KHz
Wireless Charging Power	15W Max. + 15W Max.
Modulation Technique	FSK
Antenna Type	Induction coil

## 1.2 Related Submittal(s) / Grant(s)

This submittal(s) (test report) is intended for FCC ID: 2BBM4-JV2000 filing to comply with the FCC Part 15, Subpart C Rules.

## 1.3 Test Methodology

Both conducted and radiated testing was performed according to the procedures in ANSI C63.10 (2013). Radiated testing was performed at an antenna to EUT distance 3 meters.

## 1.4 Special Accessories

Not available for this EUT intended for grant.

## 1.5 Equipment Modifications

Not available for this EUT intended for grant.

## 1.6 Test Facility

Site Description  
EMC Lab. : Accredited by CNAS, 2017.06.26  
The certificate is valid until 2022.10.28  
The Laboratory has been assessed and proved to be in compliance with  
CNAS-CL01:2006 (identical to ISO/IEC 17025:2005)  
The Certificate Registration Number is L6214.

Accredited by A2LA, 2018.03.15  
The Certificate Number is 4422.01.

Name of Firm : Dong Guan Anci Electronic Technology Co., Ltd.  
Site Location : 1-2 Floor, Building A, No.11, Headquarters 2 Road, Songshan, Lake  
Hi-tech Industrial Development Zone, Dongguan City, development Zone,  
Dongguan City, Guangdong Pr., China.

## 2 System Test Configuration

### 2.1 EUT Configuration

The EUT configuration for testing is installed on RF field strength measurement to meet the Commissions requirement and operating in a manner which intends to maximize its emission characteristics in a continuous normal application.

### 2.2 EUT Exercise

The Transmitter was operated in the normal operating mode. The TX frequency was fixed which was for the purpose of the measurements.

### 2.3 Test Procedure

#### 2.3.1 Conducted Emissions

The EUT is placed on a turn table which is 0.8 m above ground plane. According to the requirements in Section 13.1.4.1 of ANSI C63.10-2013 Conducted emissions from the EUT measured in the frequency range between 0.15 MHz and 30 MHz using CISPR Quasi-Peak and average detector mode.

#### 2.3.2 Radiated Emissions

The EUT is placed on a turn table which is 0.8 m above ground plane. The turn table shall rotate 360 degrees to determine the position of maximum emission level. EUT is set 3m away from the receiving antenna which varied from 1m to 4m to find out the highest emission. And also, each emission was to be maximized by changing the polarization of receiving antenna both horizontal and vertical. In order to find out the max. emission, the fixed in a particular direction according to the requirements in Section 13.1.4.1 of ANSI C63.10-2013.

## 2.4 onfiguration of Tested System

**Fig. 2-1 Configuration of Tested System**

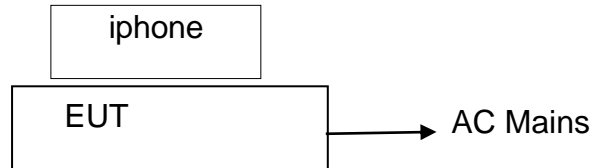

**Table 2-1 Equipment Used in Tested System**

Item	Equipment	Trade Mark	Model No.	FCC ID	Note
1.	Portable Outdoor Power Supply	N/A	JV2000	2BBM4-JV2000	EUT
3.	iphone	Apple	A2404	N/A	<i>Support Equipment</i>

**Note:**

- (1) Unless otherwise denoted as EUT in 『Remark』 column, device(s) used in tested system is a support equipment.

## 3 Summary of Test Results

FCC Rules	Description Of Test	Result
§15.207	AC Power Conducted Emission	Compliant
§15.209	Radiated Emission	Compliant
§2.1049	20dB Bandwidth	Compliant
§15.203	Antenna Requirement	Compliant



## 4 TEST SYSTEM UNCERTAINTY

The following measurement uncertainty levels have been estimated for tests performed on the apparatus:

Parameter	Uncertainty
Conducted Emissions Test	$\pm 2.0\text{dB}$
Radiated Emission Test	$\pm 2.0\text{dB}$
Temperature	$\pm 0.5^{\circ}\text{C}$
Humidity	$\pm 3\%$

Remark: The coverage Factor ( $k=2$ ), and measurement Uncertainty for a level of Confidence of 95%

## 5 Conducted Emissions Test

### 5.1 Measurement Procedure

1. The EUT was placed on a table which is 0.8m above ground plane.
2. Maximum procedure was performed on the six highest emissions to ensure EUT compliance.
3. Repeat above procedures until all frequency measured was complete.

### 5.2 Test SET-UP (Block Diagram of Configuration)

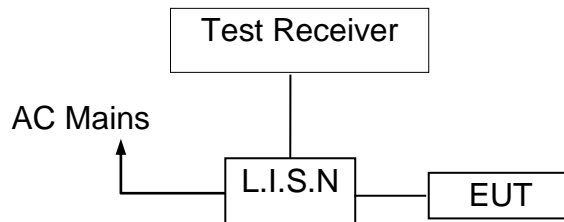

### 5.3 Measurement Equipment Used

EQUIPMENT TYPE	MFR	MODEL NUMBER	SERIAL NUMBER	Calibrated until
L.I.S.N	SCHWARZBECK	NSLK 8127	8127-669	2024-05-09
10 db attenuator	JFW	50FP-010-H4	4360846-427-1	2024-05-09
RF Cable	N/A	N/A	2#	2024-05-09
EMI Test Receiver	ROHDE&SCHWARZ	ESCI	101358	2024-05-09

### 5.4 Conducted Emission Limit

#### Conducted Emission

Frequency(MHz)	Quasi-peak	Average
0.15-0.5	66-56	56-46
0.5-5.0	56	46
5.0-30.0	60	50

**Note:** 1. The lower limit shall apply at the transition frequencies

2. The limit decreases in line with the logarithm of the frequency in the range of 0.15 to 0.50MHz.

## 5.5 Measurement Result

Operation Mode:	TX	Test Date :	2023-06-20
Frequency Range:	0.15MHz~30MHz	Temperature :	22°C
Test Result:	PASS	Humidity :	55 %
Test By:	Best		

Pass

We pretested modes (Wireless Charging 15W+15W ) for EUT. The worst test data see follow the table.

**Test mode: Wireless Charging 15W+15W**

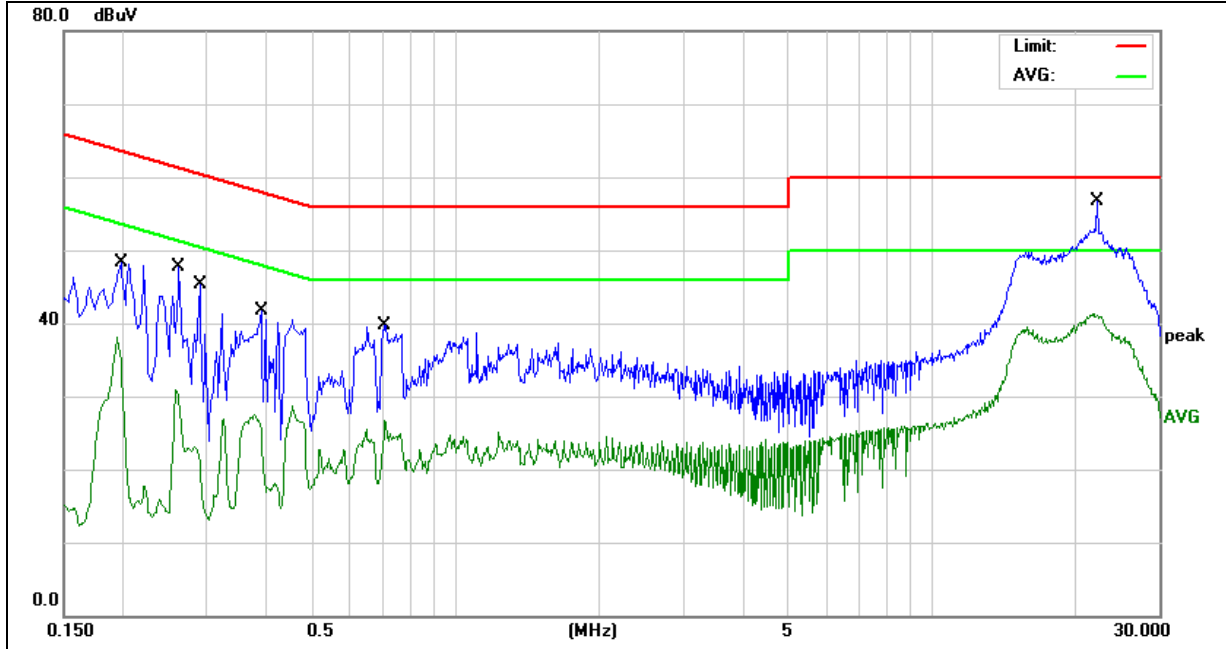

<b>Site:</b>	843	<b>Phase:</b> L1	<b>Temperature(C):</b> 22
<b>Limit:</b>	FCC Part 15 C Conduction(QP)		<b>Humidity(%):</b> 55
<b>EUT:</b>	Portable Outdoor Power Supply	<b>Test Time:</b>	2023/01/10
<b>M/N.:</b>	JV2000	<b>Power Rating:</b>	AC 120V/60Hz
<b>Mode:</b>	Wireless Charging 15W+15W	<b>Test Engineer:</b>	Jack
<b>Note:</b>			

No.	Frequency (MHz)	Reading Level(dBuV)	Factor (dB)	Measurement(dBuV)	Limit (dBuV)	Over (dB)	Detector	Comment
1	0.1980	27.68	10.21	37.89	63.69	-25.80	QP	
2	0.1980	22.84	10.21	33.05	53.69	-20.64	AVG	
3	0.2620	23.59	10.20	33.79	61.36	-27.57	QP	
4	0.2620	18.00	10.20	28.20	51.36	-23.16	AVG	
5	0.2900	18.06	10.20	28.26	60.52	-32.26	QP	
6	0.2900	7.25	10.20	17.45	50.52	-33.07	AVG	
7	0.3899	19.92	10.16	30.08	58.06	-27.98	QP	
8	0.3899	14.09	10.16	24.25	48.06	-23.81	AVG	
9	0.7060	24.71	10.14	34.85	56.00	-21.15	QP	
10	0.7060	14.70	10.14	24.84	46.00	-21.16	AVG	
11	22.2020	35.51	10.81	46.32	60.00	-13.68	QP	
12	22.2020	26.07	10.81	36.88	50.00	-13.12	AVG	

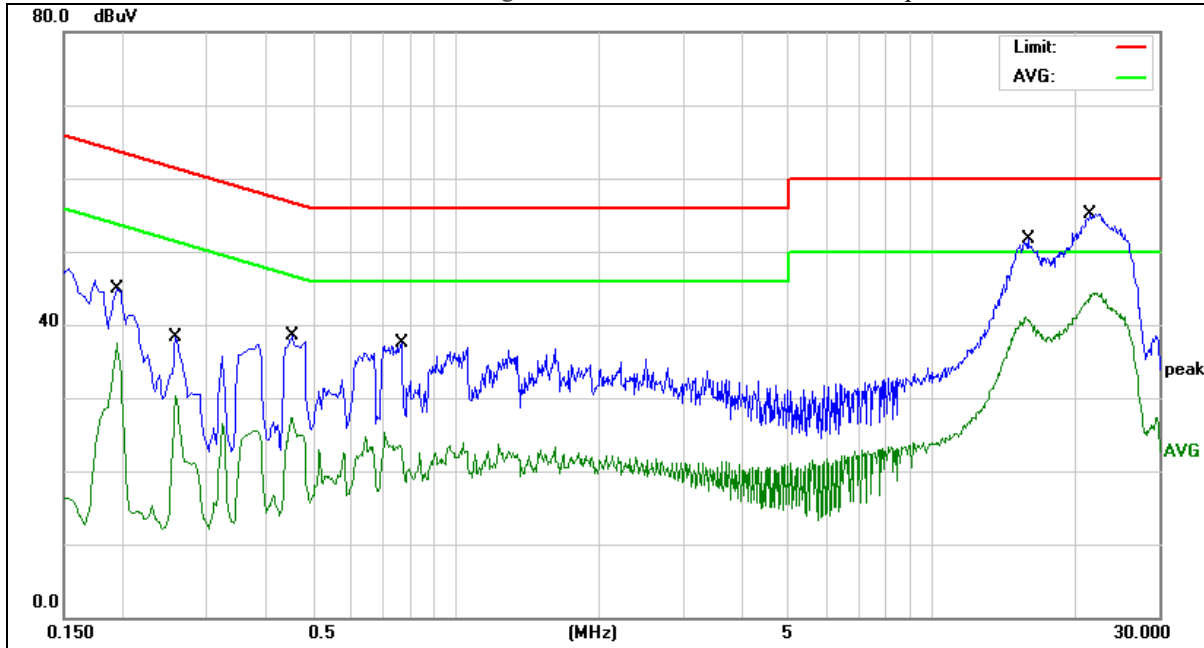

<b>Site:</b>	<b>843</b>	<b>Phase:</b>	<b>N</b>	<b>Temperature(C):</b>	<b>22</b>
<b>Limit:</b>	<b>FCC Part 15 C Conduction(QP)</b>			<b>Humidity(%):</b>	<b>55</b>
<b>EUT:</b>	<b>Portable Outdoor Power Supply</b>	<b>Test Time:</b>	<b>2023-06-20</b>		
<b>M/N.:</b>	<b>JV2000</b>	<b>Power Rating:</b>	<b>AC 120V/60Hz</b>		
<b>Mode:</b>	<b>Wireless Charging 15W+15W</b>	<b>Test Engineer:</b>	<b>Jack</b>		
<b>Note:</b>					

No.	Frequency (MHz)	Reading Level(dBuV)	Factor (dB)	Measurement(dBuV)	Limit (dBuV)	Over (dB)	Detector	Comment
1	0.1940	31.34	10.20	41.54	63.86	-22.32	QP	
2	0.1940	26.61	10.20	36.81	53.86	-17.05	AVG	
3	0.2580	25.58	10.20	35.78	61.49	-25.71	QP	
4	0.2580	19.55	10.20	29.75	51.49	-21.74	AVG	
5	0.4540	26.09	10.17	36.26	56.80	-20.54	QP	
6	0.4540	16.91	10.17	27.08	46.80	-19.72	AVG	
7	0.7700	24.80	10.14	34.94	56.00	-21.06	QP	
8	0.7700	12.39	10.14	22.53	46.00	-23.47	AVG	
9	15.9540	35.35	10.61	45.96	60.00	-14.04	QP	
10	15.9540	27.40	10.61	38.01	50.00	-11.99	AVG	
11	21.5100	38.90	10.79	49.69	60.00	-10.31	QP	
12	21.5100	29.42	10.79	40.21	50.00	-9.79	AVG	

### 5.6 Conducted Measurement Photo



## 6 Radiated Emission Test

### 6.1 Measurement Procedure

1. The EUT was placed on a turn table which is 0.8m above ground plane.
2. Maximum procedure was performed on the six highest emissions to ensure EUT compliance.
3. And also, each emission was to be maximized by changing the polarization of receiving antenna both horizontal and vertical.
4. Repeat above procedures until all frequency measured were complete.

### 6.2 Test SET-UP (Block Diagram of Configuration)

(A) Radiated Emission Test Set-Up, Frequency Below 30MHz

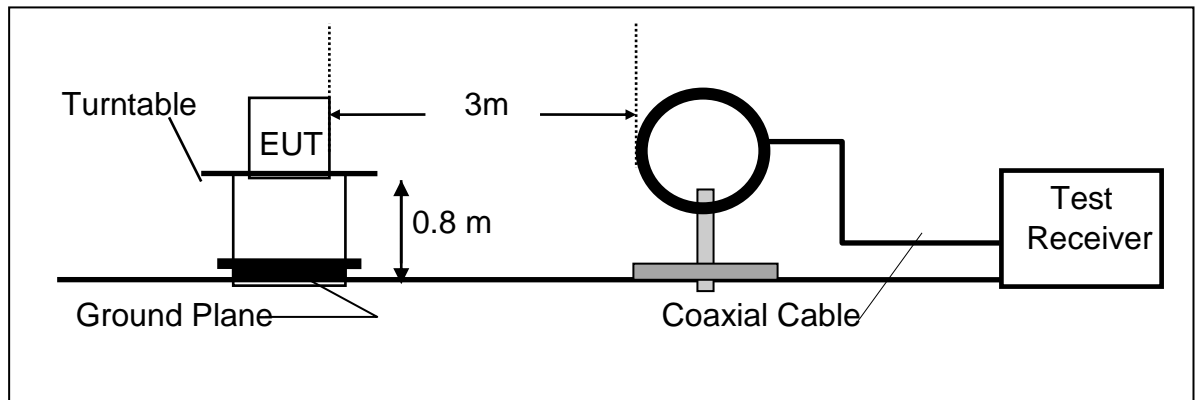

(B) Radiated Emission Test Set-Up, Frequency Below 1000MHz

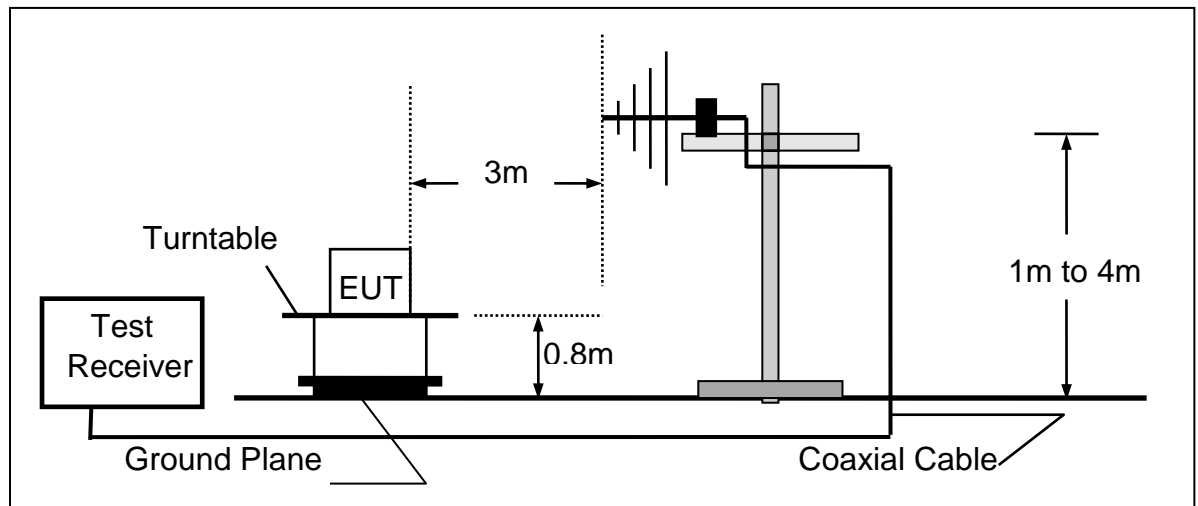

### 6.3 Measurement Equipment Used

Item	Equipment	Manufacturer	Model No.	Serial No.	Calibrated until
1.	EMI Test Receiver	Rohde & Schwarz	ESPI	100502	2023-10-07
2.	Pre-Amplifier	HP	8447D	2727A06172	2024-05-09
3.	Bilog Antenna	Schwarzbeck	VULB9163	VULB9163-588	2024-05-09
4.	Loop Antenna	Schwarzbeck	FMZB 1516	1516-141	2023-10-07
5.	RF Cable	Gigalink Microwave	ZT40-2.92J-2.92 J-2m	N/A	2023-10-07
6.	RF Cable	Gigalink Microwave	ZT40-2.92J-2.92 J-0.3m	N/A	2023-10-07
7.	RF Cable	N/A	N/A	6#	2024-05-09
8.	3m Semi-anechoic Chamber	chengyu	9m*6m*6m	N/A	2024-11-11
9.	Test Software	Farad	EZ-EMC Ver:ANCI-3A1	N/A	N/A

### 6.4 Radiated Emission Limit

The emissions from an intentional radiator shall not exceed the field strength levels specified in the following table 15.209(a):

FCC Part 15.209				
Frequency (MHz)	Field Strength Limitation		Field Strength Limitation Frequency tion at 3m Measurement Dist	
	(uV/m)	Dist	(uV/m)	(dBuV/m)
0.009 – 0.490	$2400 / F(\text{KHz})$	300m	$10000 * 2400/F(\text{KHz})$	$20\log 2400/F(\text{KHz}) + 80$
0.490 – 1.705	$24000 / F(\text{KHz})$	30m	$100 * 24000/F(\text{KHz})$	$20\log 24000/F(\text{KHz}) + 40$
1.705 – 30.00	30	30m	$100 * 30$	$20\log 30 + 40$
30.0 – 88.0	100	3m	100	$20\log 100$
88.0 – 216.0	150	3m	150	$20\log 150$
216.0 – 960.0	200	3m	200	$20\log 200$
Above 960.0	500	3m	500	$20\log 500$



## 15.205 Restricted bands of operation

MHz	MHz	MHz	GHz
0.090 - 0.110	16.42 - 16.423	399.9 - 410	4.5 - 5.15
<sup>1</sup> 0.495 - 0.505	16.69475 - 16.69525	608 - 614	5.35 - 5.46
2.1735 - 2.1905	16.80425 - 16.80475	960 - 1240	7.25 - 7.75
4.125 - 4.128	25.5 - 25.67	1300 - 1427	8.025 - 8.5
4.17725 - 4.17775	37.5 - 38.25	1435 - 1626.5	9.0 - 9.2
4.20725 - 4.20775	73 - 74.6	1645.5 - 1646.5	9.3 - 9.5
6.215 - 6.218	74.8 - 75.2	1660 - 1710	10.6 - 12.7
6.26775 - 6.26825	108 - 121.94	1718.8 - 1722.2	13.25 - 13.4
6.31175 - 6.31225	123 - 138	2200 - 2300	14.47 - 14.5
8.291 - 8.294	149.9 - 150.05	2310 - 2390	15.35 - 16.2
8.362 - 8.366	156.52475 - 156.52525	2483.5 - 2500	17.7 - 21.4
8.37625 - 8.38675	156.7 - 156.9	2690 - 2900	22.01 - 23.12
8.41425 - 8.41475	162.0125 - 167.17	3260 - 3267	23.6 - 24.0
12.29 - 12.293	167.72 - 173.2	3332 - 3339	31.2 - 31.8
12.51975 - 12.52025	240 - 285	3345.8 - 3358	36.43 - 36.5
12.57675 - 12.57725	322 - 335.4	3600 - 4400	( <sup>2</sup> )

- Remark:
1. Emission level in dBuV/m=20 log (uV/m)
  2. Measurement was performed at an antenna to the closed point of EUT distance of meters.
  3. Only spurious frequency is permitted to locate within the Restricted Bands specified in provision of  $\xi$  15.205, and the emissions located in restricted bands also comply with 15.209 limit.

### 6.5 Measurement Result

We pretested modes (Wireless Charging 15W+15W ) for EUT. The worst mode test data see follow the table.

**Test mode: Wireless Charging 15W+15W**

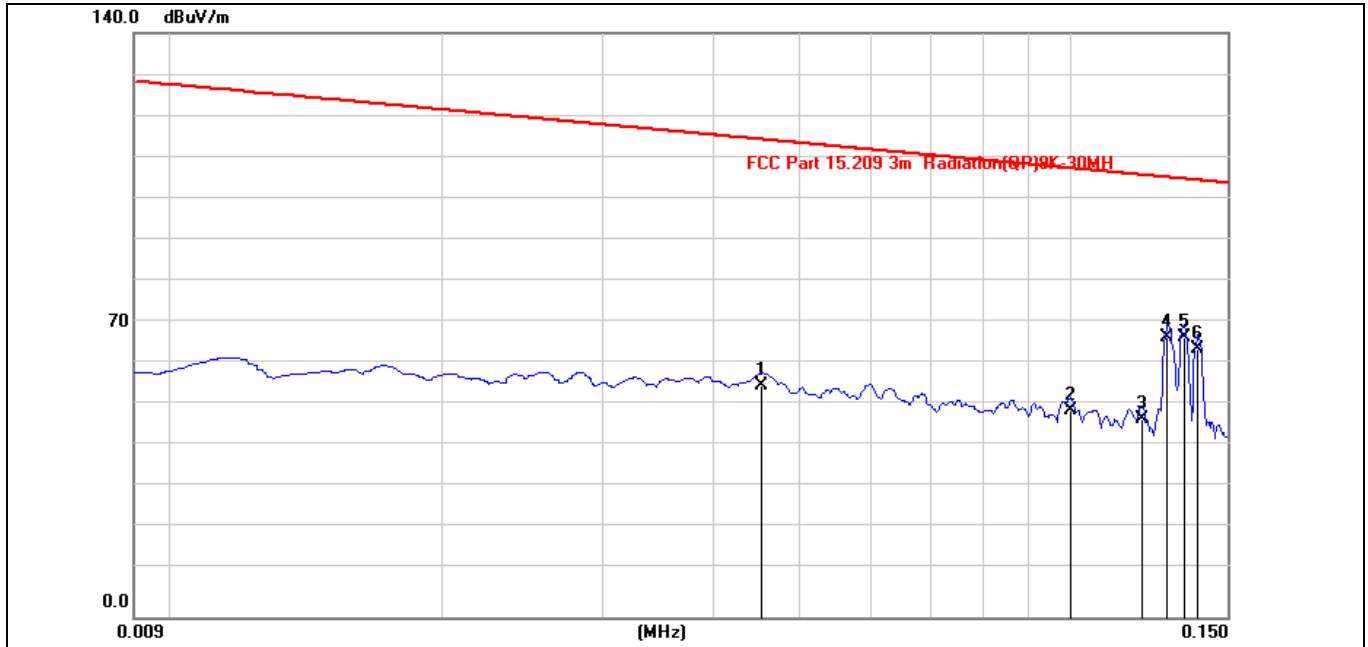

<b>Site:</b>	<b>LAB</b>	<b>Antenna: Vertical</b>	<b>Temperature(C): 23.4(C)</b>
<b>Limit:</b>	<b>FCC Part 15C 3m Radiation(QP)</b>	<b>Test Time:</b>	<b>Humidity(%): 56.7%</b>
<b>EUT:</b>	<b>Portable Outdoor Power Supply</b>	<b>Power Rating:</b>	<b>AC 120V/60Hz</b>
<b>M/N.:</b>	<b>JV2000</b>	<b>Test Engineer:</b>	<b>sunshine</b>
<b>Mode:</b>	<b>Wireless Charging 15W+15W</b>		
<b>Note:</b>			

No.	Frequency (MHz)	Reading (dBuV)	Factor (dB/m)	Level (dBuV/m)	Limit (dBuV/m)	Margin (dB)	Det.	Remark
1	0.0321	38.18	20.12	58.30	117.46	-59.16	QP	
2	0.0552	34.64	19.86	54.50	112.75	-58.25	QP	
3	0.1001	36.78	19.64	56.42	107.59	-51.17	QP	
4	0.1293	53.88	19.64	73.52	105.37	-31.85	QP	
5	0.1341	57.06	19.64	76.70	105.05	-28.35	QP	
6	0.1392	55.66	19.64	75.30	104.73	-29.43	QP	

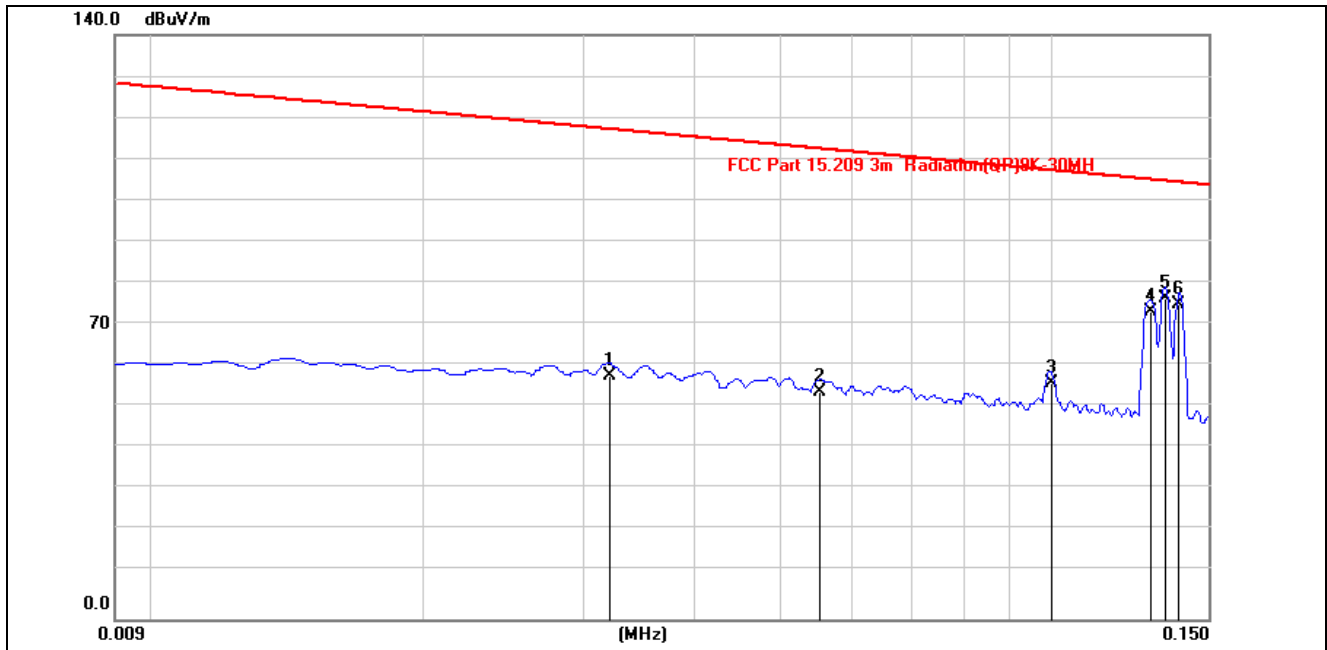

<b>Site:</b>	<b>LAB</b>	<b>Antenna:Horizontal</b>	<b>Temperature(C):23.4(C)</b>
<b>Limit:</b>	<b>FCC Part 15C 3m Radiation(QP)</b>	<b>Test Time:</b>	<b>Humidity(%):56.7%</b>
<b>EUT:</b>	<b>Portable Outdoor Power Supply</b>	<b>Power Rating:</b>	<b>AC 120V/60Hz</b>
<b>M/N.:</b>	<b>JV2000</b>	<b>Test Engineer:</b>	<b>sunshine</b>
<b>Mode:</b>	<b>Wireless Charging 15W+15W</b>		
<b>Note:</b>			

No.	Frequency (MHz)	Reading (dBuV)	Factor (dB/m)	Level (dBuV/m)	Limit (dBuV/m)	Margin (dB)	Det.	Remark
1	0.0321	38.18	20.12	58.30	117.46	-59.16	QP	
2	0.0552	34.64	19.86	54.50	112.75	-58.25	QP	
3	0.1001	36.78	19.64	56.42	107.59	-51.17	QP	
4	0.1293	53.88	19.64	73.52	105.37	-31.85	QP	
5	0.1341	57.06	19.64	76.70	105.05	-28.35	QP	
6	0.1392	55.66	19.64	75.30	104.73	-29.43	QP	

- Note:**
- (1) All Readings are Peak Value.
  - (2) Emission Level= Reading Level+Probe Factor +Cable Loss.
  - (3) The average measurement was not performed when the peak measured data under the limit of average detection.
  - (4) EUT lying on the table position is the worst case result in the report.

**Test mode: Wireless Charging 15W+15W**

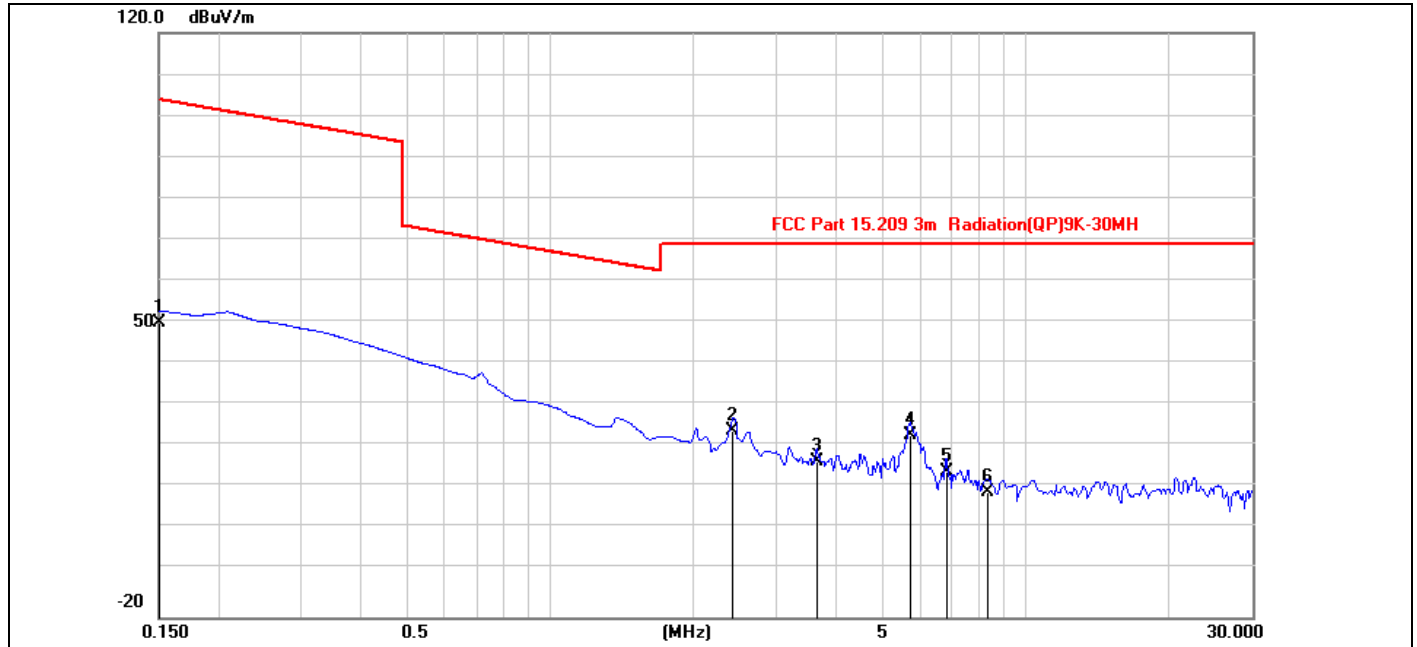

<b>Site:</b>	<b>LAB</b>	<b>Antenna::</b>	<b>Vertical</b>	<b>Temperature(C):</b>	<b>23.4(C)</b>
<b>Limit:</b>	<b>FCC Part 15C 3m Radiation(QP)</b>			<b>Humidity(%):</b>	<b>56.7%</b>
<b>EUT:</b>	<b>Portable Outdoor Power Supply</b>	<b>Test Time:</b>			<b>2023-06-20</b>
<b>M/N.:</b>	<b>JV2000</b>	<b>Power Rating:</b>			<b>AC 120V/60Hz</b>
<b>Mode:</b>	<b>Wireless Charging 15W+15W</b>	<b>Test Engineer:</b>			<b>sunshine</b>
<b>Note:</b>					

No.	Frequency (MHz)	Reading (dBuV)	Factor (dB/m)	Level (dBuV/m)	Limit (dBuV/m)	Margin (dB)	Det.	Remark
1	0.1500	30.80	19.64	50.44	104.08	-53.64	QP	
2	2.4186	5.18	19.57	24.75	69.50	-44.75	QP	
3	3.6425	-2.24	19.69	17.45	69.50	-52.05	QP	
4	5.7320	3.91	19.74	23.65	69.50	-45.85	QP	
5	6.8066	-4.81	19.63	14.82	69.50	-54.68	QP	
6	8.2991	-9.63	19.73	10.10	69.50	-59.40	QP	

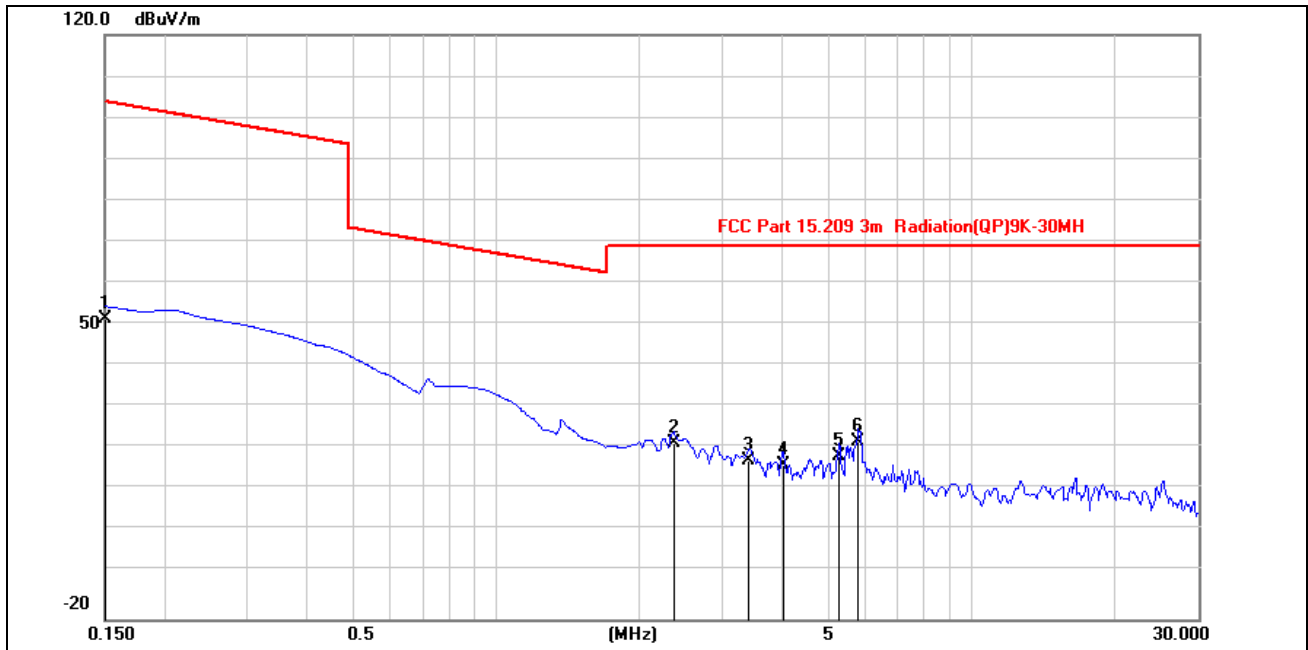

Site:	LAB	Antenna::	Horizontal	Temperature(C):	23.4(C)
Limit:	FCC Part 15C 3m Radiation(QP)	Test Time:	2023-06-20	Humidity(%):	56.7%
EUT:	Portable Outdoor Power Supply	Power Rating:	AC 120V/60Hz		
M/N.:	JV2000	Test Engineer:	sunshine		
Mode:	Wireless Charging 15W+15W				
Note:					

No.	Frequency (MHz)	Reading (dBuV)	Factor (dB/m)	Level (dBuV/m)	Limit (dBuV/m)	Margin (dB)	Det.	Remark
1	0.1500	32.31	19.64	51.95	104.08	-52.13	QP	
2	2.3589	2.56	19.57	22.13	69.50	-47.37	QP	
3	3.4037	-1.77	19.67	17.90	69.50	-51.60	QP	
4	4.0305	-2.63	19.73	17.10	69.50	-52.40	QP	
5	5.2544	-0.74	19.79	19.05	69.50	-50.45	QP	
6	5.7917	2.89	19.73	22.62	69.50	-46.88	QP	

- Note:**
- (1) All Readings are Peak Value.
  - (2) Emission Level= Reading Level+Probe Factor +Cable Loss.
  - (3) The average measurement was not performed when the peak measured data under the limit of average detection.
  - (4) EUT lying on the table position is the worst case result in the report.

We pretested modes (Wireless Charging 15W+15W ) for EUT. The worst test data see follow the table.

**Test mode: Wireless Charging 15W+15W**

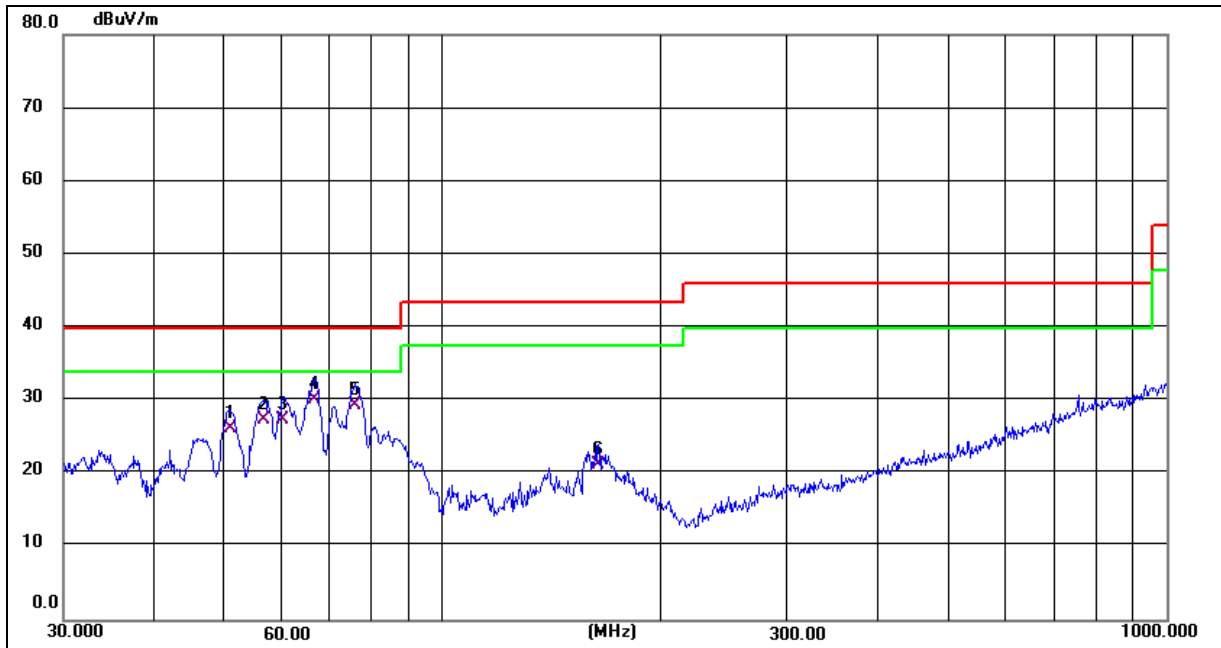

<b>Site:</b>	<b>LAB</b>	<b>Antenna::</b> Vertical	<b>Temperature(C):</b> 23.4(C)
<b>Limit:</b>	<b>FCC Part 15 Class B 3m Radiation(QP)</b>		<b>Humidity(%):</b> 56.7%
<b>EUT:</b>	<b>Portable Outdoor Power Supply</b>	<b>Test Time:</b>	<b>2023-06-20</b>
<b>M/N.:</b>	<b>JV2000</b>	<b>Power Rating:</b>	<b>AC 120V/60Hz</b>
<b>Mode:</b>	<b>Wireless Charging 15W+15W</b>	<b>Test Engineer:</b>	<b>sunshine</b>
<b>Note:</b>			

No.	Frequency (MHz)	Reading (dBuV)	Factor (dB/m)	Level (dBuV/m)	Limit (dBuV/m)	Margin (dB)	Det.	Remark
1	50.9420	38.98	-12.68	26.30	40.00	-13.70	QP	
2	56.7917	39.99	-12.59	27.40	40.00	-12.60	QP	
3	60.2801	39.92	-12.52	27.40	40.00	-12.60	QP	
4	66.9669	42.62	-12.42	30.20	40.00	-9.80	QP	
5	75.9773	41.66	-12.26	29.40	40.00	-10.60	QP	
6	164.3301	33.02	-11.82	21.20	43.50	-22.30	QP	

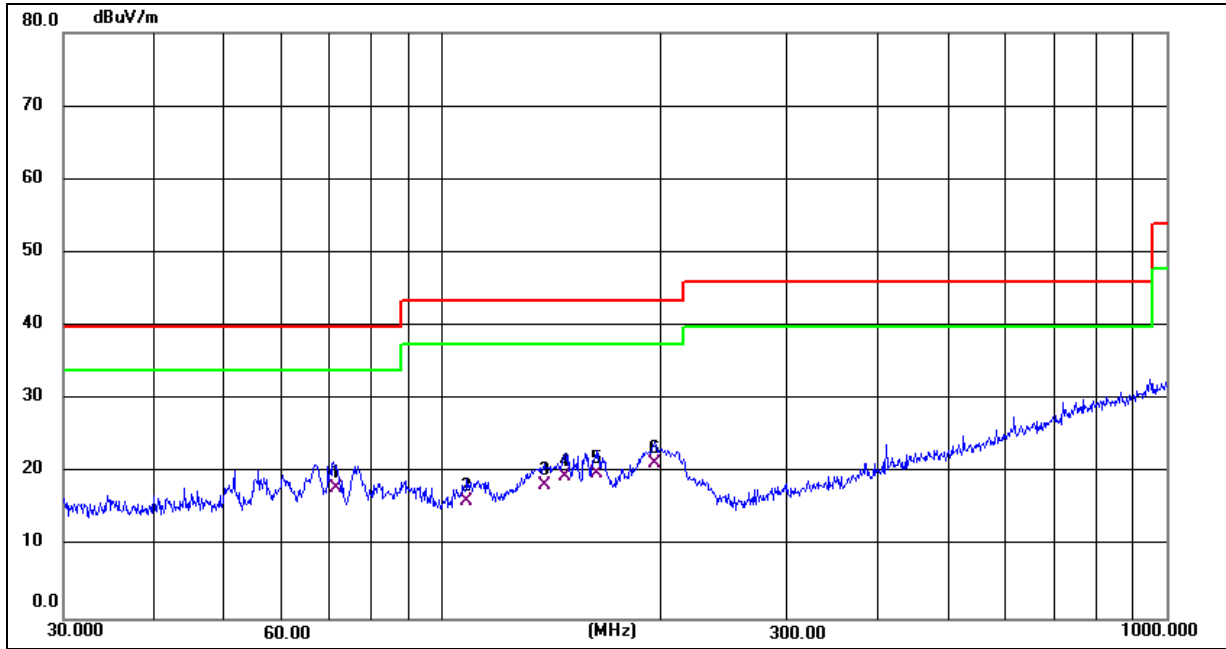

<b>Site:</b>	<b>LAB</b>	<b>Antenna::Horizontal</b>	<b>Temperature(C):23.4(C)</b>
<b>Limit:</b>	<b>FCC Part 15 Class B 3m Radiation(QP)</b>	<b>Test Time:</b>	<b>Humidity(%):56.7%</b>
<b>EUT:</b>	<b>Portable Outdoor Power Supply</b>	<b>Power Rating:</b>	<b>AC 120V/60Hz</b>
<b>M/N.:</b>	<b>JV2000</b>	<b>Test Engineer:</b>	<b>sunshine</b>
<b>Mode:</b>	<b>Wireless Charging 15W+15W</b>		
<b>Note:</b>			

No.	Frequency (MHz)	Reading (dBuV)	Factor (dB/m)	Level (dBuV/m)	Limit (dBuV/m)	Margin (dB)	Det.	Remark
1	71.5806	30.24	-12.34	17.90	40.00	-22.10	QP	
2	108.2667	27.36	-11.16	16.20	43.50	-27.30	QP	
3	138.3873	29.76	-11.46	18.30	43.50	-25.20	QP	
4	147.9214	31.35	-11.75	19.60	43.50	-23.90	QP	
5	163.1818	31.70	-11.80	19.90	43.50	-23.60	QP	
6	196.5098	34.16	-12.96	21.20	43.50	-22.30	QP	

### 6.6 Radiated Measurement Photos





## 7 20db Bandwidth

### 7.1 20dB Bandwidth Limit

None: for reporting purposed only.

### 7.2 Test Instruments

Refer a test equipment and calibration data table in this test report.

### 7.3 Test Procedure

The bandwidth of the fundamental frequency was measured by spectrum analyzer with 1KHz RBW and 3KHz VBW. The 20dB bandwidth is defined as the total spectrum the power of which is higher than peak power minus 20dB.

### 7.4 Test Setup

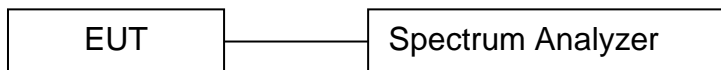

### 7.5 Test Result

Charging Mode	Frequency (KHz)	20dB Bandwidth (KHz)	Results
iPhone	134.41	3.299	PASS

### 20 dB Bandwidth Test plot

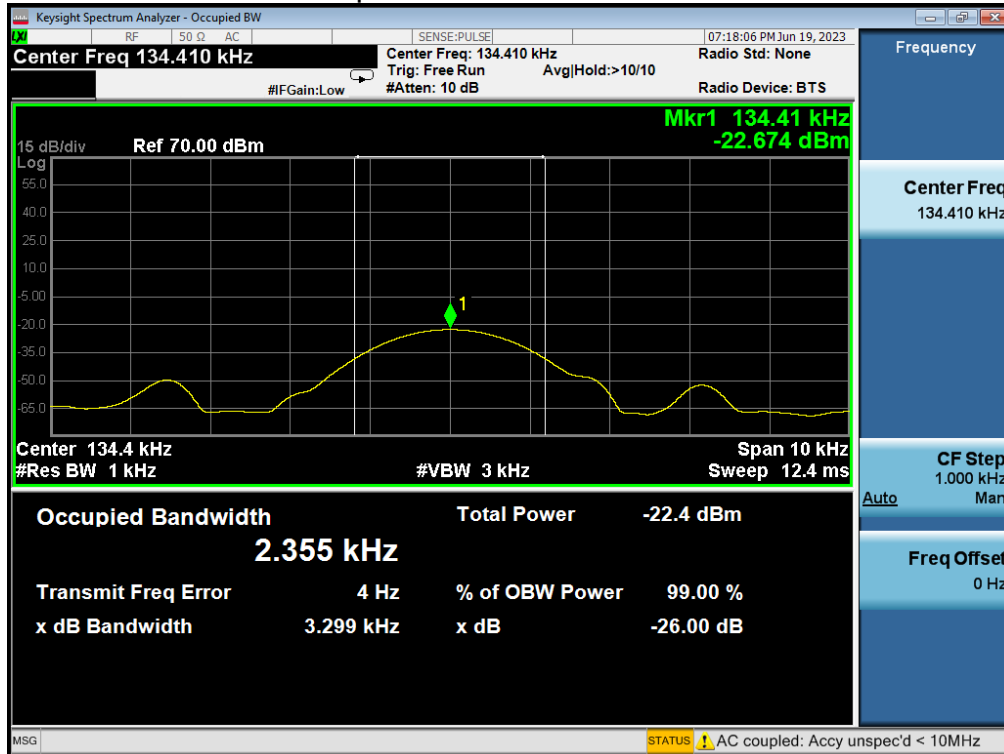

Wireless Charging for iPhone

## **8 Antenna Application**

### **8.1 Antenna requirement**

For intentional device, according to FCC 47 CFR Section 15.203, an intentional radiator shall be designed to ensure that no antenna other than that furnished by the responsible party shall be used with the device.

### **8.2 Result**

The EUT's antenna, permanent attached antenna, used an Induction coil and integrated on PCB, The antenna's gain meets the requirement.

## APPENDIX (Photos of EUT)

**External Photos**







**Internal Photos**

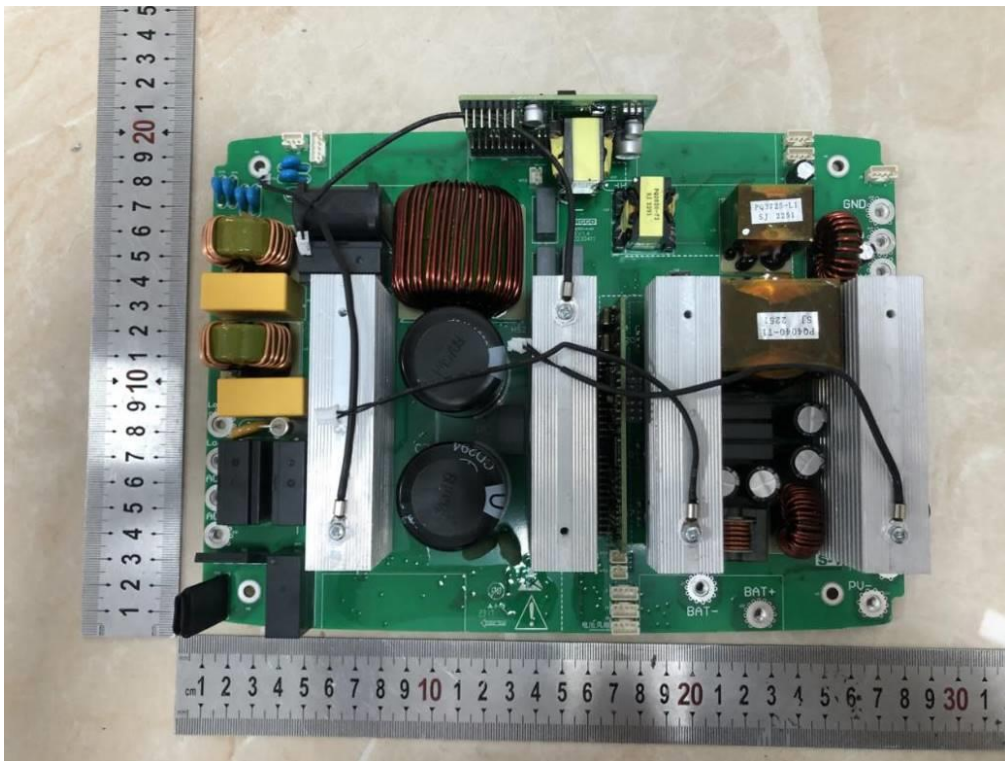



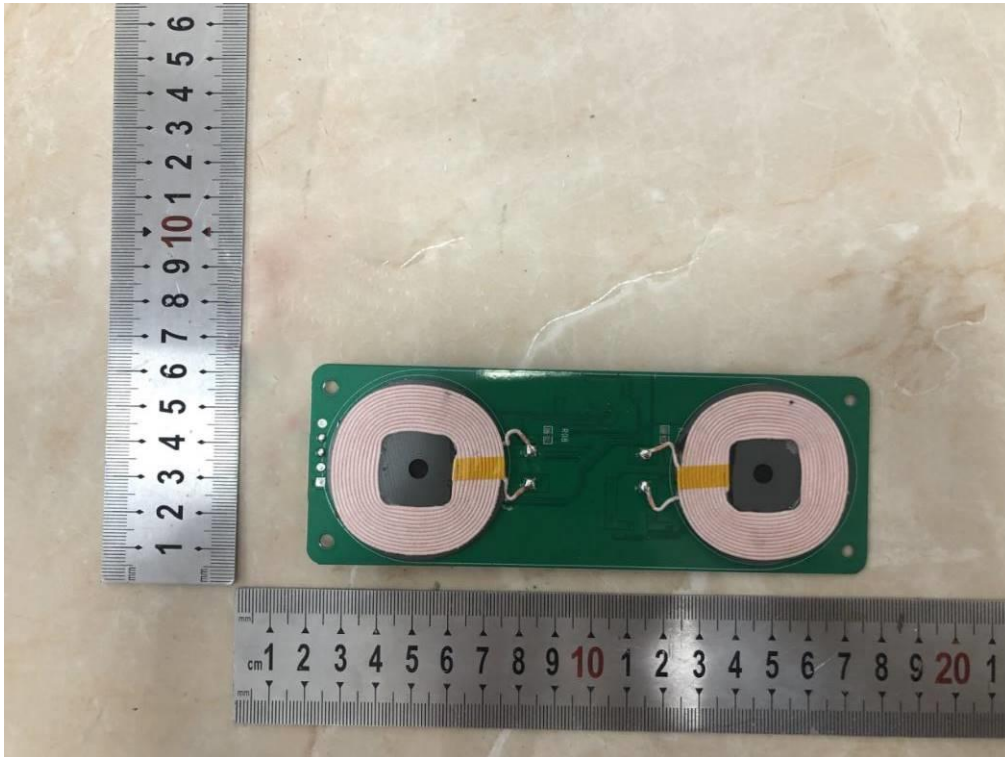
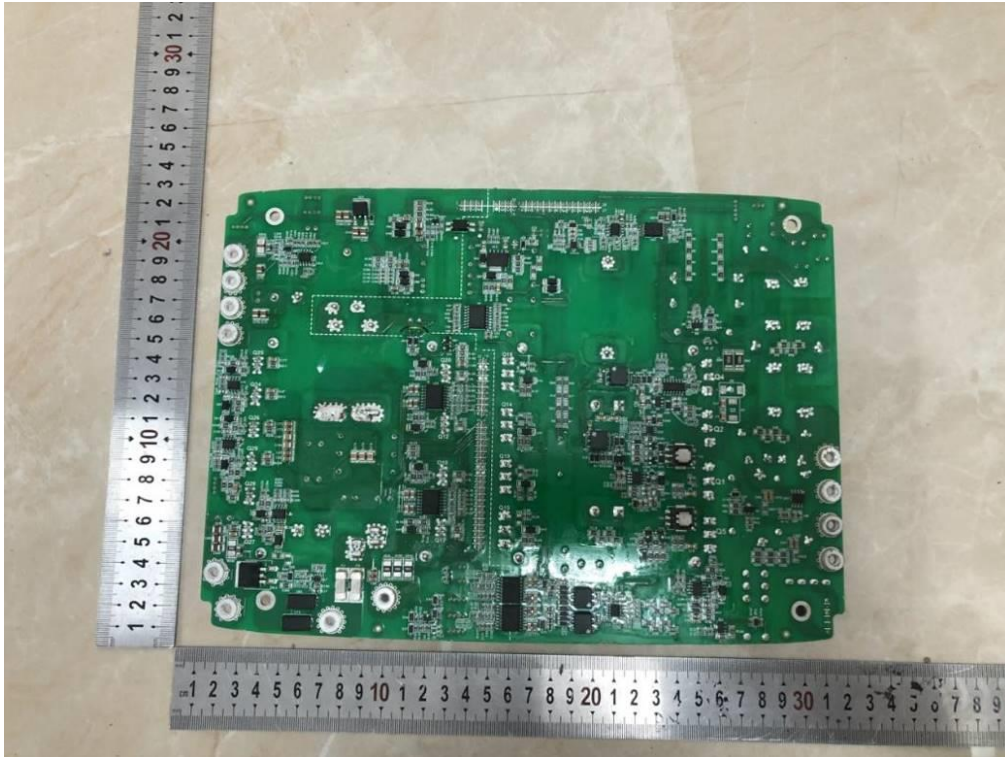

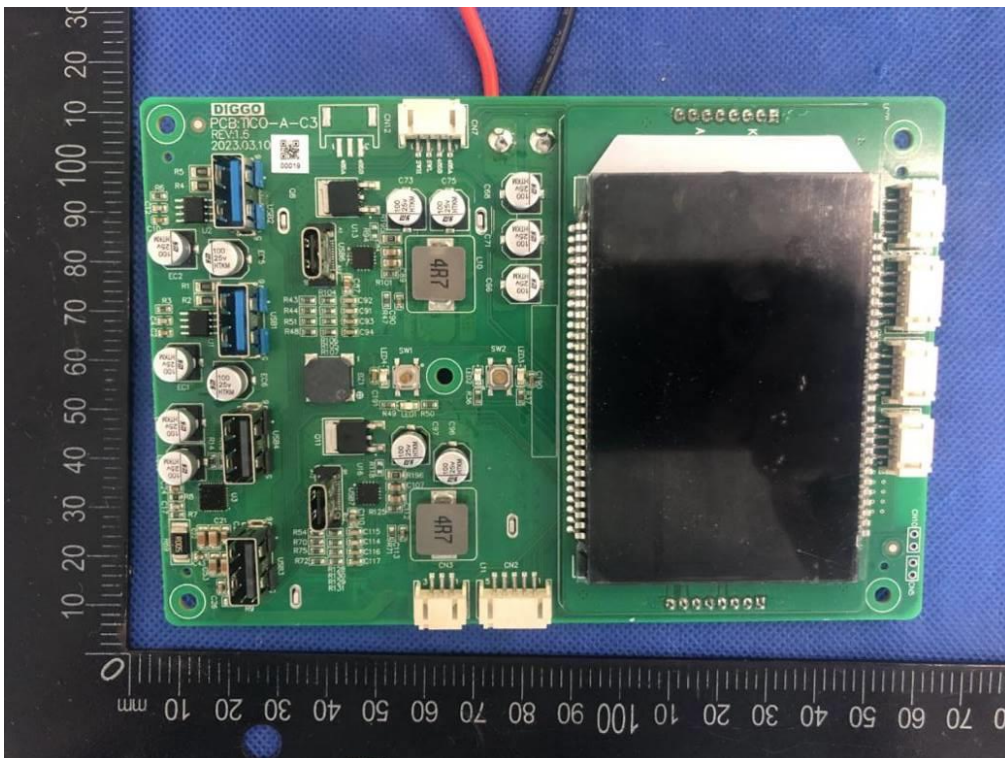
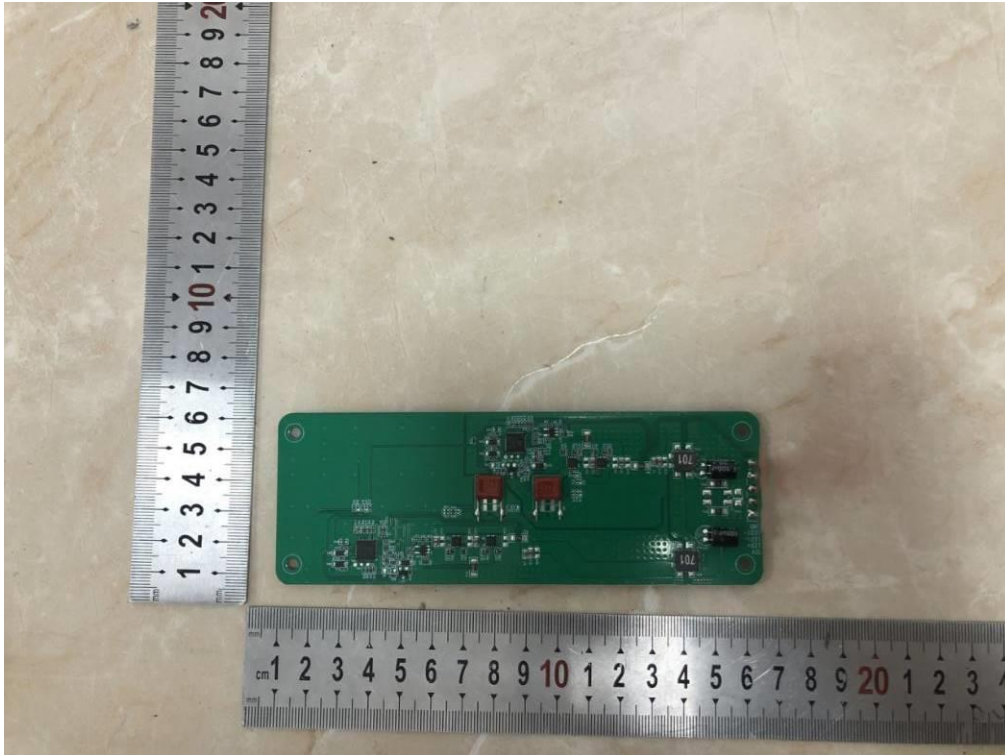

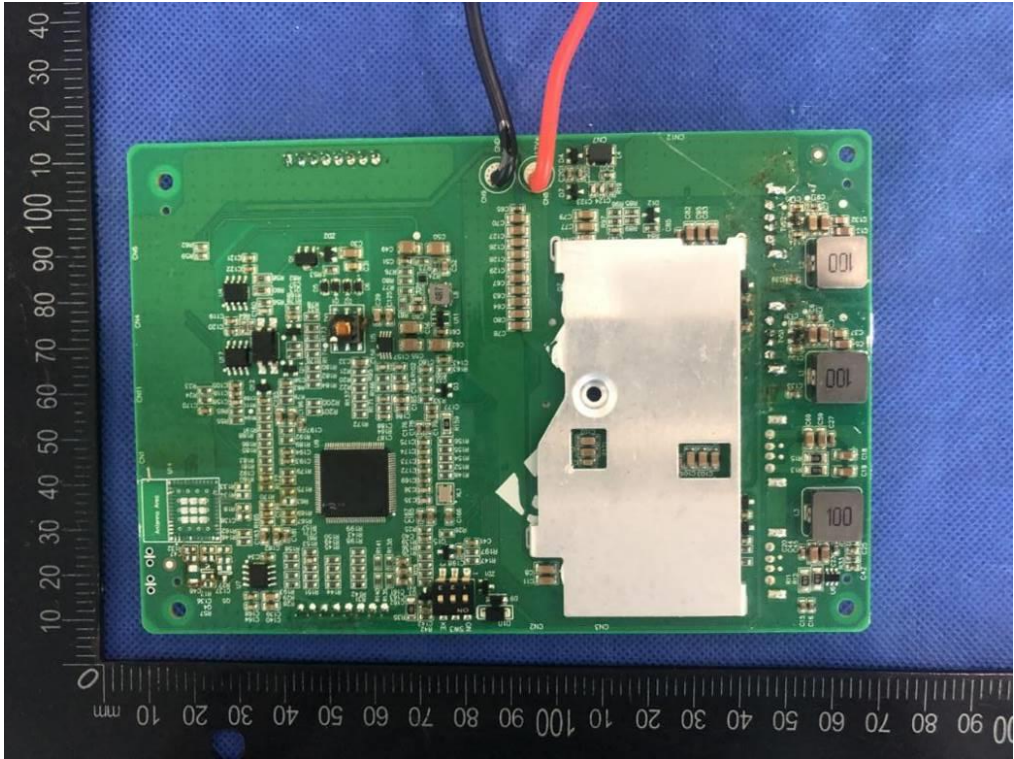

-----The end-----