

ENGINEUNITY

Portable Power Station

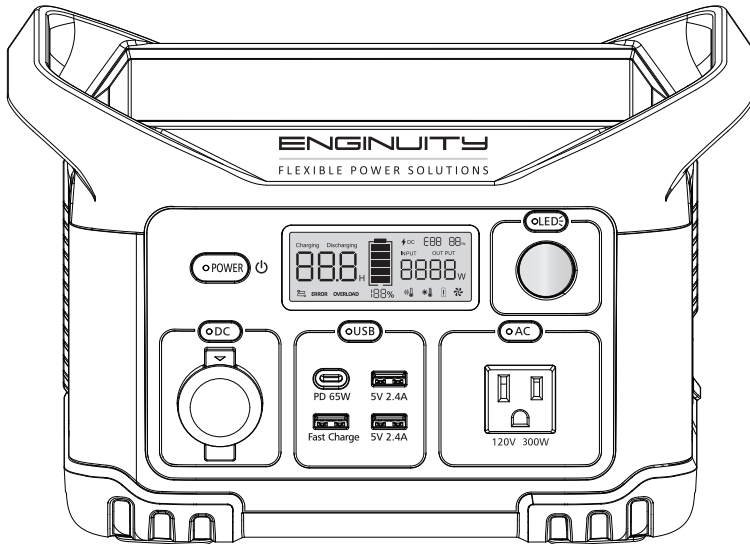

E300

Power Station / User Manual Central Eléctrica / Manual de Usuario

WARNING:

This manual contains important information to ensure the safe operation, handling and storage of this product. To reduce the risk of injury read and understand this manual prior to use. Save the manual for future reference.

ADVERTENCIA:

Este manual contiene información importante para garantizar la operación, manipulación y almacenamiento seguros de este producto. Para reducir el riesgo de lesiones, lea y comprenda este manual antes de usarlo. Guarde el manual para futuras consultas.

IMPORTANT SAFETY RULES

WARNING:

Risk of Electric Shock. If misused, the voltage generated by this power station can be deadly. Always use common sense and adhere to the manufacturer's instructions when using this product.

WARNING:

Explosion Hazard. Do not burn or incinerate the power station. Do not expose this unit to temperatures above 140°F (60°C). Exposure to fire and extreme temperatures can cause an explosion resulting in property damage, personal injury, and death.

WARNING:

Prior to using the DC charging feature, consult the vehicle operator's manual or the manufacturer's website to obtain the vehicle fuse ratings. Verify that the vehicle's electrical system and fuses can safely supply the energy required to charge the power station. If a fuse opens repeatedly during charging, disconnect the power station and determine the cause of the overload. Do not replace the fuse with a fuse rated higher than the vehicle manufacturer's recommendation or attempt to circumvent the safety features of the fuse. Doing so could create a risk of fire.

SAVE THESE INSTRUCTIONS

- Follow the manufacturer's instructions when using this product. Misuse can reduce the protection provided by this equipment.
- Do not use this device to power life support devices or other necessary medical equipment.
- Do not overload the power station. Exceeding the unit's wattage/ampere capacity can damage the unit and/or electrical devices connected to it.
- Risk of electric shock. This tool does not provide an electrical path to earth ground when used with a grounded appliance.
- Do not operate, store or handle the power station in wet conditions. Do not submerge the power station. Water entering the power station will increase the risk of electric shock.
- To reduce the risk of electric shock and property damage, the power station should only be used in dry locations.
- Always use the power station in well-ventilated areas. Do not use it in areas where flammable fumes or gases can accumulate, such as an inadequately vented bilge of a boat or near propane tanks.
- Always closely supervise this product when it is used near children.
- Do not insert fingers, hands, or foreign objects into the product.
- To avoid overheating the power station, do not obstruct the unit's vents. If the power station becomes too hot, it will automatically shut off.
- Keep power station cool. Do not place the unit near heat sources or expose it to excessive heat.
- Keep the power station away from fire or extreme temperatures. Exposure to fire or temperatures may cause an explosion.
- Do not operate or store the power station in locations colder than 4°F (-15.5°C) or hotter than 113°F (45°C). This product should not be stored outside or in your vehicle.
- Do not use the power station or its charger if it has been dropped or received a sharp blow. A damaged power station will increase the risk of fire and electric shock.
- Do not charge the power station with a damaged cord, plug, or adapter.
- The power station should only be charged using the power sources listed in the product specifications.
- To avoid damaging the unit, only use cords that are provided or approved by the manufacturer to charge the power station.
- Do not attempt to modify this product or use it with accessories that are not recommended or sold by the product manufacturer. Using incompatible accessories may result in a risk of fire, electric shock, property damage, or injury to persons.
- Be careful when connecting/disconnecting the power station from an outlet or connecting/disconnecting loads from the power station. Do not force the power station's plug into an outlet. Do not force plugs into the power station.
- Do not force a polarized plug (one prong larger than the other) into this product. Flip plug over and retry.
- When disconnecting loads, pull the plug instead of the cord. Pulling the cord may damage the cord or the plug.
- Do not power items with damaged or frayed power cords.
- Do not disassemble the power station. All repairs should be performed by the manufacturer or authorized service person. Using an incorrectly reassembled power station may create a risk of fire or electric shock.
- Do not store the power station near fertilizers, gasoline, or other chemicals.
- Store the product indoors in a dry secure location away from children.
- To avoid damaging the internal battery, the power station should be stored in a partially charged state.

SPECIFICATIONS

GENERAL

Model	E300
Capacity	258Wh (22.2V)
Size	9.7 in. (246 mm) [L] x 6.1 in. (154 mm) [W] x 6.7 in. (170 mm) [H]
Net Weight	6.6 lbs (3.3 kg)

INPUT

DC Input	12-30V DC, 8.5A Max Charge time is approximately 5-6 hours
----------	---

OUTPUT

AC (x2)	120V AC, 60Hz, 300W Max Rated
USB-A (x3)	5V DC, 2.4A, 12W Max Per Port
USB-A Fast Charge (x1)	5V DC, 3A/9V DC, 2A/12 V DC, 1.5A 18W Max
Type-C Fast Charge (x1)	5V DC, 3A/9V DC, 3A/12 V DC, 3A/15V DC, 3A/20V DC, 3.25A 65W
DC Output	13V DC, 10A
Wireless	10W

OTHERS

Cell Type	NCM
Cycle Life	500 cycles to 80% capacity @25°C charge and discharge environment 0.5C charge (1.45A per cell), 1 C discharge (2.9A per cell)
Protection	Overcharge protection, high temperature protection, low temperature protection, over-discharge protection, overload protection, short circuit protection, over-current protection, battery fault protection
Charging Temperature	42.8°F to 104°F (6 to 40°C)
Discharge Temperature	14°F to 104°F (-10 to 40°C)
Working Humidity	0% to 90% (non-condensate)
Product Expansion	N/A

PACKING LIST

The following products and accessories are included with your purchase:



POWER STATION

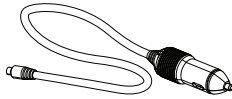

CAR CHARGER CABLE

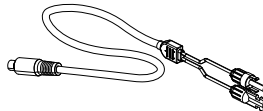

MC4 ADAPTER CABLE



AC ADAPTER CABLE

PRODUCT FEATURES

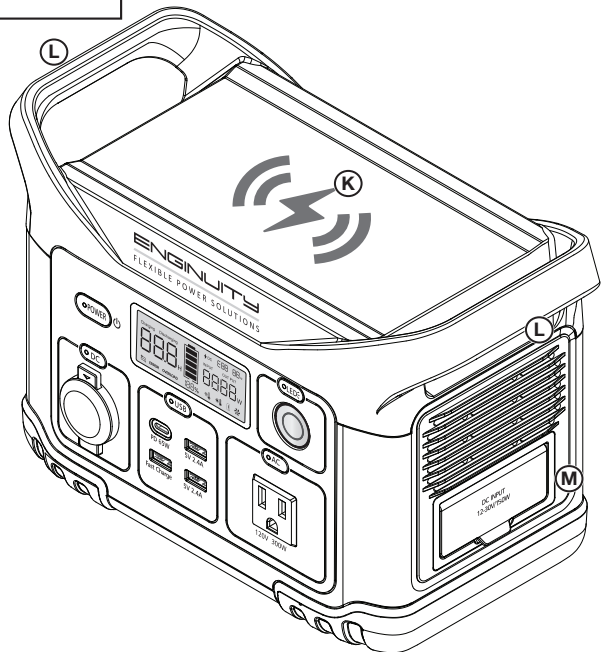
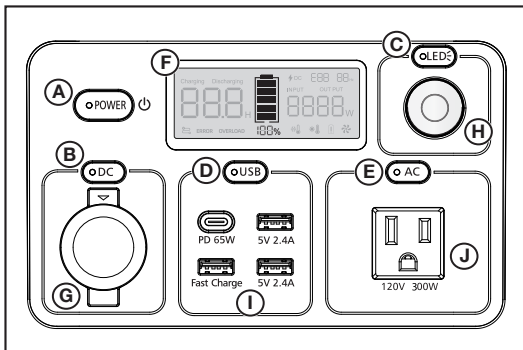

- A. Power Button
- B. DC Button
- C. LED Button
- D. USB Button
- E. AC Button
- F. LCD Screen
- G. DC Output
- H. LED Light
- I. USB Output
- J. AC Output
- K. Wireless Charging Pad
- L. Carrying Handles
- M. DC Input Port

LCD SCREEN DETAILS

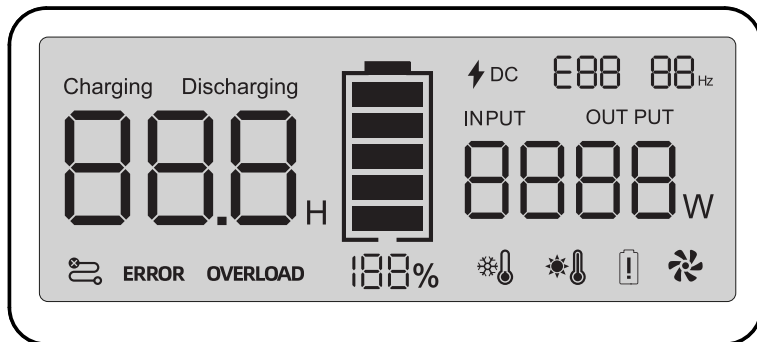

ICON	DESCRIPTION
	Displays the remaining discharge time (in hours). The discharge time will vary depending on the load and battery charge level. When the unit is charging and discharging simultaneously, the display will alternate between the discharge and charge time remaining.
	Displays the remaining charge time (in hours). The charge time will vary depending on the input source and the battery charge level. When the unit is charging and discharging simultaneously, the display will alternate between the discharge and charge time remaining.
	Shows the battery charge level.
	Indicates a communication failure. Contact customer service for details.
ERROR	Indicates errors that are not related to the internal battery.

ICON	DESCRIPTION
OVERLOAD	Indicates an overload condition. To avoid this fault, verify that the power requirements for the connected device(s) do not exceed the unit's load capacity.
	Indicates that the power station is connected to a DC charging source.
	Indicates errors that are related to the internal battery such as over-temperature, over-current, etc.
	Displays the AC output frequency (in hertz).
	Displays the input charging power (in watts).
	Displays the load output (in watts).
	Indicates that the power station is operating outside of normal temperature thresholds. Remove loads and/or disconnect cables (if applicable). Allow product to cool or warm to normal operating temperature.
	Indicates that the cooling fan is running.

For more fault display and handling information, please refer to the troubleshooting section later in this manual.

CHARGING YOUR POWER STATION

The power station is shipped in a low charge condition. Using the AC adapter, fully charge the power station before first use. The initial charge could take between 5 and 6 hours. Subsequent charge times will vary.

To avoid damaging the unit, only use cords that are provided or approved by the manufacturer to charge the power station. If desired, the power station can be used to power other devices while it is being charged. When the unit is charging and discharging simultaneously, the display will alternate between the discharge and charge time remaining.

AC CHARGING:

- Plug the AC adapter cable into the power station's DC input port and then connect it to an AC power supply.
NOTE: The input voltage must be between 90 - 260V AC. Voltage over this range will cause charging failure.
- The LCD screen will display the remaining charge time and battery charge level.

DC CHARGING:

- Start the vehicle in a well-ventilated area that is a safe distance away from bystanders.
- Plug the car charger cable into the power station's DC input port and then connect it to the vehicle's 12V DC outlet.
NOTE: The provided car charger cable should only be used to charge the power station. Do not attempt to power other devices by using this cable.
- The LCD screen will display the remaining charge time and battery charge level.

SOLAR CHARGING:

- Plug the Mc4 adapter cable into the DC input port and then connect it to a solar panel or series of panels.
- The LCD screen will display the remaining charge time and battery charge level.

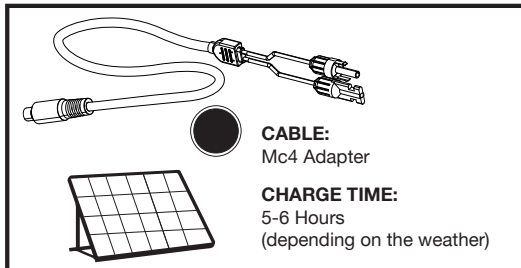
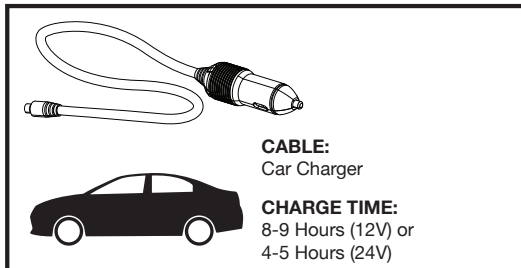
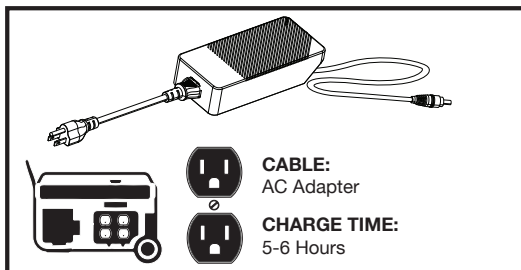
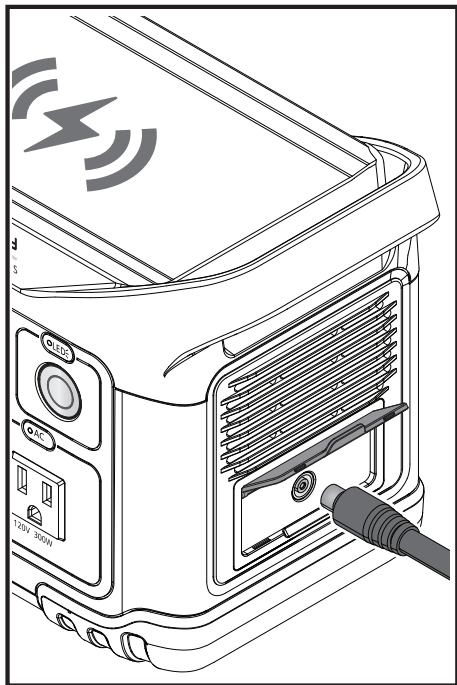

USING YOUR POWER STATION

Once your power station is charged or while your power station is charging, it can be used to power other devices. Routinely monitor the power station's battery charge level, discharge time, and load output during use.

WARNING:

Do not overload the power station. Check the power requirements for all devices before connecting them to the power station. Power requirements are often listed on a device's data label or nameplate. Exceeding the unit's wattage/amperage capacity can damage the unit and/or electrical devices connected to it.

TO TURN THE POWER STATION ON/OFF

- Press and hold the power button for two seconds to turn the unit on. This will activate the LCD screen and allow the DC port, AC receptacles, USB ports and LED light to be used.

NOTE: If the unit is inactive for five minutes, it will go into sleep mode and the LCD screen will turn off. Press any button to wake the unit.

NOTE: If the unit is inactive for two hours, it will automatically turn off.

- To turn the unit off, press and hold the power button again.

NOTE: The unit can not be turned off while it is being charged.

TO USE THE LED LIGHT

- Turn the unit on and wait five seconds for the unit to initialize.
- Press the LED button to turn the LED light on. Press the button again to cycle between Low, High, SOS, and Off.

TO USE THE DC OUTPUT

- Turn the unit on and wait five seconds for the unit to initialize.
- Press and release the DC button to turn on DC power.
- Plug the device you want to power or charge into the power station's DC output port.
- Press and release the DC button to turn off DC power. DC power will automatically turn off in two hours if no load is detected.

TO USE THE USB PORTS

- Turn the unit on and wait five seconds for the unit to initialize.
- Press and release the USB button to turn on USB power.
- Plug the device or devices you want to power or charge into the power station's USB ports.

NOTE: The fast charge USB ports can charge and power most compatible electronic devices, including tablets and smartphones.

- Press and release the USB button to turn off USB power. USB power will automatically turn off in two hours if no load is detected.

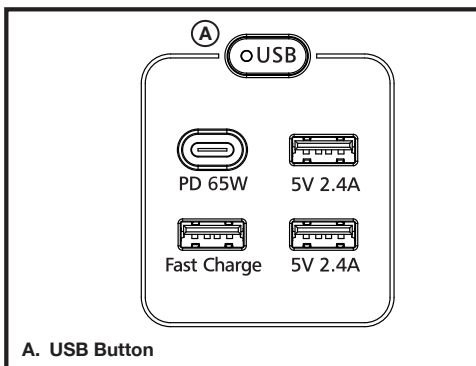
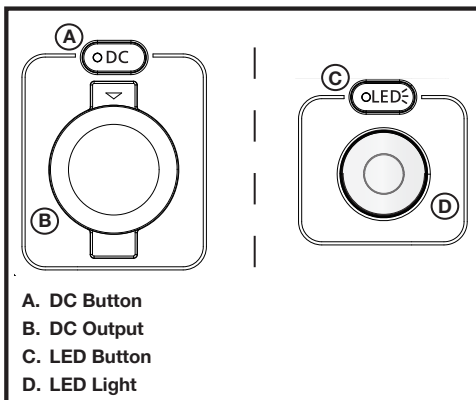
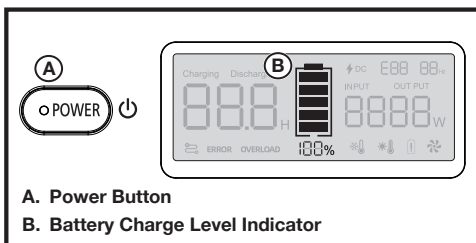

USING YOUR POWER STATION

TO USE THE AC RECEPTACLE

- Turn the unit on and wait five seconds for the unit to initialize.
- Press and release the AC button to turn on AC power.
- Plug the device or devices you want to power or charge into the power station's AC receptacles.
- Press and release the AC button to turn off AC power. AC power will automatically turn off in one hour if no load is detected.

TO USE WIRELESS CHARGING

- Turn the unit on and wait five seconds for the unit to initialize.
- Place a compatible device on the wireless charging pad to begin charging. The pad activates automatically when a device is placed on top of the unit and deactivates when it is removed.

OVERLOAD RESET

Do not overload the power station! Monitor the power station's output. If the unit is nearing overload, turn the power station off. Remove one or more connected devices to decrease the load and resume normal operation.

If the load is not reduced, the unit will reach an overload condition. To extend the life of the power station, avoid running the unit near capacity.

If the unit is overloaded or if there is a short circuit in a connected device, the ERROR and/or OVERLOAD icons will appear in the display and the power station will automatically stop discharging.

To restore electrical output:

- Remove all connected devices and turn the unit off.
- Turn the unit on and wait five seconds for the unit to initialize.
- Check the power requirements for the devices you want to power or charge. Ensure that the power requirements do not exceed the unit's load capacity.
- Connect and charge devices as previously described.

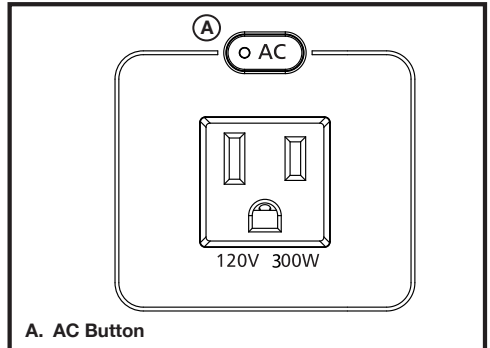

A. AC Button

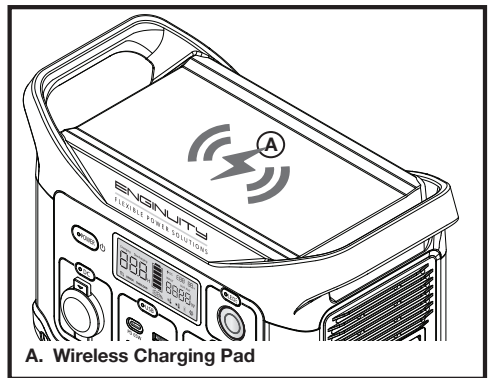



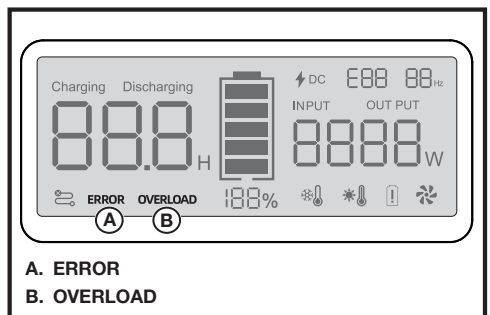

A. Wireless Charging Pad





A. ERROR

B. OVERLOAD

TROUBLESHOOTING AND ERRORS

ERROR	DESCRIPTION	PROBLEM	SOLUTION
E00	 <p>Icons flash Alarm beeps 3 times</p>	Low Temperature (While Charging)	Remove loads and/or disconnect cables (if applicable). Allow product to warm to normal operating temperature.
E01	 <p>Icons flash Alarm beeps 3 times</p>	High Temperature (While Charging)	Remove loads and/or disconnect cables (if applicable). Allow product to cool to normal operating temperature.
E09	 <p>Icons flash Alarm beeps 3 times</p>	Low Temperature (While Discharging)	Remove loads and allow product to warm to normal operating temperature.
E10	 <p>Icons flash Alarm beeps 3 times</p>	High Temperature (While Discharging)	Remove loads and allow product to cool to normal operating temperature.
E11	<p>ERROR </p> <p>Icons flash Alarm beeps 3 times Fan stops working</p>	Battery Charge Level is Low	Remove loads and connect the unit to a power source for charging.
E12		Battery Charge Level is Low And the Unit Won't Discharge In Low Temperatures	Remove loads and connect the unit to a power source for charging.
E16	<p>ERROR OVERLOAD</p> <p>Icons flash Alarm beeps 3 times</p>	Overload Detected At AC Outlets	Turn off the unit. Remove all connected devices. Wait 5 seconds, turn the unit on, and activate AC power. Verify power requirements for your device(s) do not exceed the unit's load capacity.
E17	<p>ERROR</p> <p>Icon flashes Alarm beeps 3 times</p>	High Temperature Warning	Verify that the vents on the side of the unit are not blocked. Remove loads and allow product to cool to normal operating temperature.

TROUBLESHOOTING AND ERRORS

ERROR	DESCRIPTION	PROBLEM	SOLUTION
E22	ERROR Icon flashes Alarm beeps 3 times	Short Circuit Detected At AC Outlets	Turn off the unit. Remove all connected devices. Check AC devices for short circuit. Do not connect damaged equipment to the power station.
E24	 Icon flashes Alarm beeps 3 times	Abnormal Communication Between Main Controller and Inverter	Contact customer support
E33	ERROR OVERLOAD Icons flash Alarm beeps 3 times	Over-current/Overload Detected At DC Output	Turn off the unit. Remove all connected devices. Wait 5 seconds, turn the unit on, and activate DC power. Verify power requirements for your device(s) do not exceed the unit's load capacity.
E35	ERROR Icon flashes Alarm beeps 3 times	Short Circuit Detected At DC Output	Turn off the unit. Remove all connected devices. Check DC device for short circuit. Do not connect damaged equipment to the power station.
E45	ERROR Icon flashes Unusual discharge time Alarm beeps 3 times	Short Circuit/Over-current Detected At USB ports	Turn off the unit. Remove all connected devices. Check USB device(s) for short circuit. Do not connect damaged equipment to the power station.
E49	ERROR Icon flashes Unusual discharge time Alarm beeps 3 times	Short Circuit/Over-current Detected At "Fast Charge" USB Port	Turn off the unit. Remove all connected devices. Check USB device for short circuit. Do not connect damaged equipment to the power station.
E77		Battery Surface Temperature Exceeds 140°F (60°C) AC Output is Reduced to 50% of the Unit's Max Rating.	Reduce or remove loads and allow product to cool to normal operating temperature.
E78		Battery Surface Temperature Exceeds 147°F (64°C) AC and DC Power is Turned Off.	Remove loads and allow product to cool to normal operating temperature.
E85	ERROR Icon flashes Alarm beeps 3 times Fan stops working	Battery Charge Level is Below 5% AC Power is Turned Off	Remove loads and connect the unit to a power source for charging. AC power will be available once charge level exceeds 7%.

TROUBLESHOOTING AND ERRORS

ERROR	DESCRIPTION	PROBLEM	SOLUTION
E88		Initial Voltage Output Reduced Due to Cold Temperature	Remove loads and only connect devices that are rated below 65% of the power station's load capacity
If the error remains after trying the solutions listed above and restarting the unit, contact customer service for assistance.			

MAINTAINING AND STORING THE UNIT

GENERAL MAINTENANCE

- Routinely clean the unit's exterior and vents. Turn the unit off. Use a clean cloth or soft bristle brush to remove dirt, oil, grease, etc. **Do not use water or solvents and never submerge the unit.**
- Inspect the unit for broken parts, damaged ports/receptacles, loose screws, etc. **NEVER disassemble or attempt to service the power station.** If the unit is damaged, contact customer service for assistance.

STORING THE POWER STATION

- Store the product indoors in a dry secure location away from children.
- Do not store the power station near fertilizers, gasoline, or other chemicals.
- Do not operate or store the power station in locations colder than 4°F (-15.5°C) or hotter than 113°F (45°C). This product should not be stored outside or in your vehicle.
- To avoid damaging the internal battery, the power station should be stored in a partially charged state.
 - When storing the unit for less than three months (short-term storage), charge the unit to 50% .
 - When storing the unit for more than three months (long-term storage), charge the unit to 60% and add additional charge periodically.

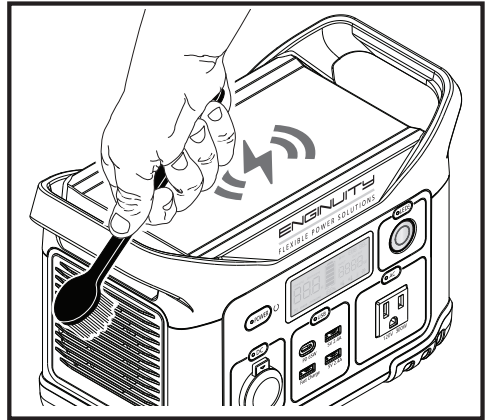

FCC WARNING

This device complies with part 15 of the FCC Rules. Operation is subject to the following two conditions: (1) This device may not cause harmful interference, and (2) this device must accept any interference received, including interference that may cause undesired operation.

Any changes or modifications not expressly approved by the party responsible for compliance could void the user's authority to operate the equipment.

NOTE: This equipment has been tested and found to comply with the limits for a Class B digital device, pursuant to part 15 of the FCC Rules. These limits are designed to provide reasonable protection against harmful interference in a residential installation. This equipment generates uses and can radiate radio frequency energy and, if not installed and used in accordance with the instructions, may cause harmful interference to radio communications. However, there is no guarantee that interference will not occur in a particular installation. If this equipment does cause harmful interference to radio or television reception, which can be determined by turning the equipment off and on, the user is encouraged to try to correct the interference by one or more of the following measures:

- Reorient or relocate the receiving antenna.
- Increase the separation between the equipment and receiver.
- Connect the equipment into an outlet on a circuit different from that to which the receiver is connected.
- Consult the dealer or an experienced radio/TV technician for help.

This equipment complies with FCC radiation exposure limits set forth for an uncontrolled environment. This equipment should be installed and operated with minimum distance 20cm between the radiator and your body.

WARRANTY INFORMATION

LIMITED WARRANTY STATEMENT

Enginuity Power Systems warrants to the original retail purchaser that this product is free from defects in workmanship and materials for two years from the date of purchase. Keep a copy of your purchase receipt as proof of purchase

This warranty is non-transferable and does not cover damages from normal wear and tear, modifications, abuse, misuse, accidents, neglect, improper storage and maintenance, non-authorized servicing, or acts of God. The warranty is limited to the power station and the original purchaser. Enginuity Power Systems is not liable for any third party claims, property damage, data loss, financial hardship, etc. arising from the use of this product.

The product, and any defective parts, must be returned to Enginuity Power Systems or an authorized service repairer within the warranty period. At the discretion of Enginuity Power Systems, the owner may be responsible for some or all of the shipping and delivery costs. In respect to claims, Enginuity Power Systems is only responsible for repairing or replacing defective items.

This warranty provides specific legal rights; additional rights may differ by state. For more information, contact customer service at service@eflexps.com.

- English: "

This device complies with Industry Canada licence-exempt RSS standard(s).

Operation is subject to the following two conditions:

(1) this device may not cause interference, and

(2) this device must accept any interference, including interference that may cause undesired operation of the device."

- French:"

Le présent appareil est conforme aux CNR d'Industrie Canada applicables aux appareils radio exempts de licence. L'exploitation est autorisée aux deux conditions suivantes :

(1) l'appareil n' doit pas produire de brouillage, et

(2) l'utilisateur de l'appareil doit accepter tout brouillage radioélectrique subi, même si le brouillage est susceptible d'en compromettre le fonctionnement."

Le présent appareil est conforme. Après examen de ce matériel aux conformités ou aux limites d'intensité de champ RF, les utilisateurs peuvent sur l'exposition aux radiofréquences et compliance d'acquérir les informations correspondantes. La distance minimale du corps à utiliser le dispositif est de 20cm.

The device is compliance with RF exposure guidelines, users can obtain Canadian information on RF exposure and compliance. The minimum distance from body to use the device is 20cm.

ENGINEUNITY

FLEXIBLE POWER SOLUTIONS

E300

**Power Station / User Manual
Central Eléctrica / Manual de Usuario**

**CUSTOMER SERVICE
SERVICIO AL CLIENTE**

SERVICE@EFLEXP.S.COM

© 2024 Enginuity Power Systems. All Rights Reserved.
730 S. Washington St., Alexandria, VA 22314

REV 01 - 04/25/24