

FCC Test Report

Applicant : **Chongqing Radiance Energy Technology Co.,Ltd.**

Address : **No.27-3 Feng Sheng Road, Jiu Long Po District, Chongqing City,China.**

Product Name : **Portable Power Station**

Report Date : **Jun. 18, 2024**

Shenzhen Anbotek Compliance Laboratory Limited



Shenzhen Anbotek Compliance Laboratory Limited

Address: 1/F., Building D, Sogood Science and Technology Park, Sanwei Community, Hangcheng Street, Bao'an District, Shenzhen, Guangdong, China.
Tel: (86) 0755-26066440 Fax: (86) 0755-26014772 Email: service@anbotek.com

Code: AB-RF-05-b



Hotline

400-003-0500

www.anbotek.com.cn



Contents

1. General Information.....	5
1.1. Client Information.....	5
1.2. Description of Device (EUT).....	5
1.3. Auxiliary Equipment Used During Test.....	6
1.4. Description of Test Modes.....	6
1.5. Description Of Test Setup.....	8
1.6. Test Equipment List.....	9
1.7. Measurement Uncertainty.....	10
1.8. Description of Test Facility.....	10
1.9. Disclaimer.....	10
2. Summary of Test Results.....	11
3. Conducted Emission Test.....	12
3.1. Test Standard and Limit.....	12
3.2. Test Setup.....	12
3.3. Test Procedure.....	12
3.4. Test Data.....	12
4. Radiation Spurious Emission.....	15
4.1. Test Standard and Limit.....	15
4.2. Test Setup.....	15
4.3. Test Procedure.....	16
4.4. Test Data.....	16
5. Antenna Requirement.....	21
5.1. Test Standard and Requirement.....	21
5.2. Antenna Connected Construction.....	21
APPENDIX I -- TEST SETUP PHOTOGRAPH.....	22
APPENDIX II -- EXTERNAL PHOTOGRAPH.....	22
APPENDIX III -- INTERNAL PHOTOGRAPH.....	22



TEST REPORT

Applicant : Chongqing Radiance Energy Technology Co.,Ltd.
Manufacturer : Chongqing Radiance Energy Technology Co.,Ltd.
Product Name : Portable Power Station
Test Model No. : E1000
Reference Model No. : N/A
Trade Mark : N/A
Rating(s) : Please refer to page 6
Test Standard(s) : 47 CFR Part 15 Subpart C
Test Method(s) : ANSI C63.10: 2020

The device described above is tested by Shenzhen Anbotek Compliance Laboratory Limited to determine the maximum emission levels emanating from the device and the severe levels of the device can endure and its performance criterion. The measurement results are contained in this test report and Shenzhen Anbotek Compliance Laboratory Limited is assumed full of responsibility for the accuracy and completeness of these measurements. Also, this report shows that the EUT (Equipment Under Test) is technically compliant with the 47 CFR Part 15 Subpart C requirements.

This report applies to above tested sample only and shall not be reproduced in part without written approval of Shenzhen Anbotek Compliance Laboratory Limited.

Date of Receipt

May 09, 2024

Date of Test

May 09~ Jun. 12, 2024

Prepared By

Tu Tu Hong

(TuTu Hong)

Approved & Authorized Signer

Edward Pan

(Edward Pan)



Revision History

Report Version	Description	Issued Date
R00	Original Issue.	Jun. 18, 2024



1. General Information

1.1. Client Information

Applicant	:	Chongqing Radiance Energy Technology Co.,Ltd.
Address	:	No.27-3 Feng Sheng Road, Jiu Long Po District, Chongqing City,China.
Manufacturer	:	Chongqing Radiance Energy Technology Co.,Ltd.
Address	:	No.27-3 Feng Sheng Road, Jiu Long Po District, Chongqing City,China.
Factory	:	Chongqing Radiance Energy Technology Co.,Ltd.
Address	:	No.27-3 Feng Sheng Road, Jiu Long Po District, Chongqing City,China.

1.2. Description of Device (EUT)

Product Name	:	Portable Power Station
Test Model No.	:	E1000
Reference Model No.	:	N/A
Trade Mark	:	N/A
Test Power Supply	:	AC 120V/60Hz for adapter
Test Sample No.	:	1-2-1(Normal Sample), 1-2-2(Engineering Sample)
Adapter	:	Model: HKA12024050-7B Input: 100-240V~60/50Hz, 2.0A Output: 24.0V= 5.0A, 120.0W

RF Specification

Operation Frequency	:	111-205KHz
Modulation Type	:	ASK
Antenna Type	:	Inductive loop coil Antenna
Antenna Gain(Peak)	:	0 dBi (Provided by customer)

Remark: 1) All of the RF specification are provided by customer. 2) For a more detailed features description, please refer to the manufacturer's specifications or the User's Manual.



Rating(s):

Product Name: Portable Power Station
Model: E1000
Capacity: 907Wh 21.6V 42Ah
USB-C Output: 65W 5V=3A, 9V=3A, 12V=3A, 15V=3A, 20V=3.25A
 100W 5V=3A, 9V=3A, 12V=3A, 15V=3A, 20V=5A
USB Output: USB-A(x2) 5V=2.4A
 USB-A Fast Charge(x2) :5V=3A, 9V=2A, 12V=1.5A 18W max
AC Output(x3): 1000W 120VAC 60Hz
DC Output: 13V=10A
DC Input: 12V-30V=8.5A (max)
Wireless: 10W
 Discharging temperature: 14°F-104°F(-10°C-40°C)
 Charging temperature: 42.8°F-104°F(6°C-40°C)
DC Total output: 365W
AC output: 1000W
FCC ID: 2BBM4-E1000
IC ID: 32411-E1000

ENGINELITY
 FLEXIBLE POWER SOLUTIONS

To ensure safe and proper use of the power station, always follow the manufacturer's instructions as improper use can increase risks.

CALIFORNIA PROPOSITION
 ⚠️ 65 WARNING ⚠️

WARNING: This product contains chemicals known to the State of California to cause cancer and birth defects or other reproductive harm.
ADVERTENCIA: Este producto contiene productos químicos reconocidos por el estado de California que provocan cáncer, defectos de nacimiento u otros daños reproductivos.

For more information:
www.P65Warnings.ca.gov









1.3. Auxiliary Equipment Used During Test

Description	Rating(s)
Wireless charging load	M/N: CD2577 Power: 5W/7.5W/10W/15W

1.4. Description of Test Modes

To investigate the maximum EMI emission characteristics generates from EUT, the test system was pre-scanning tested base on the consideration of following EUT operation mode or test configuration mode which possible have effect on EMI emission level. Each of these EUT operation mode(s) or test configuration mode(s) mentioned above was evaluated respectively.

Pretest Mode	Description
Mode 1	WTP Mode (10W 1% Load)
Mode 2	WTP Mode (10W 50% Load)
Mode 3	WTP Mode (10W 99% Load)

For Conducted Emission	
Final Test Mode	Description
Mode 1	WTP Mode (10W 1% Load)
Mode 2	WTP Mode (10W 50% Load)
Mode 3	WTP Mode (10W 99% Load)



For Radiated Emission	
Final Test Mode	Description
Mode 1	WTP Mode (10W 1% Load)
Mode 2	WTP Mode (10W 50% Load)
Mode 3	WTP Mode (10W 99% Load)

Note:

(1) Test channel is 0.1408MHz.

(2) All the situation(full load, half load and empty load) has been tested,only the worst situation (Mode 3) was recorded in the report.



1.5. Description Of Test Setup

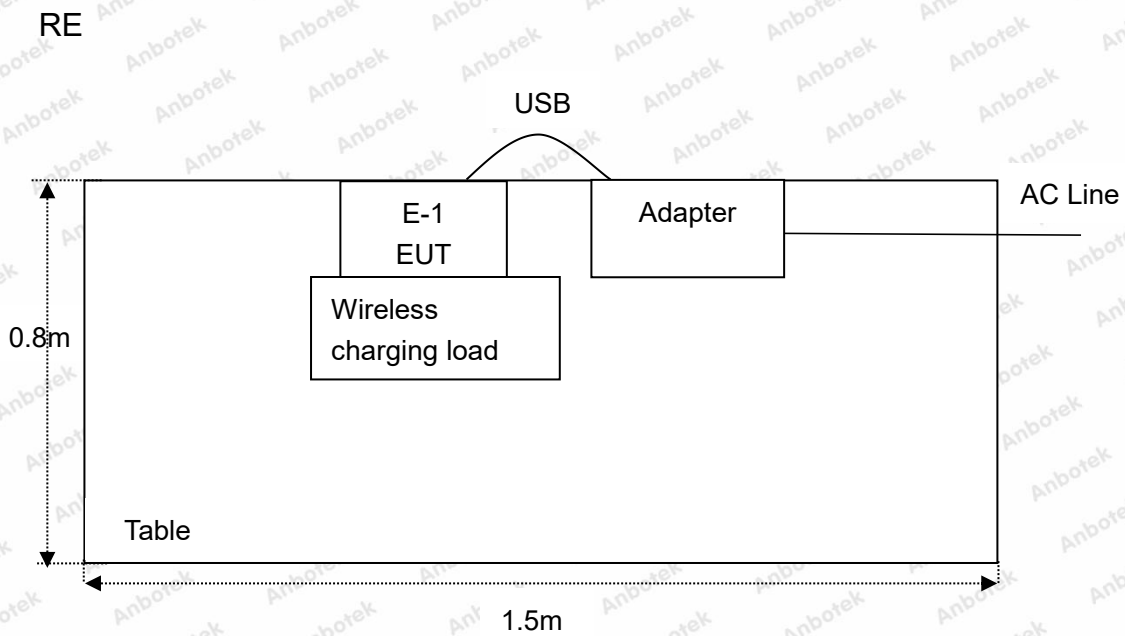
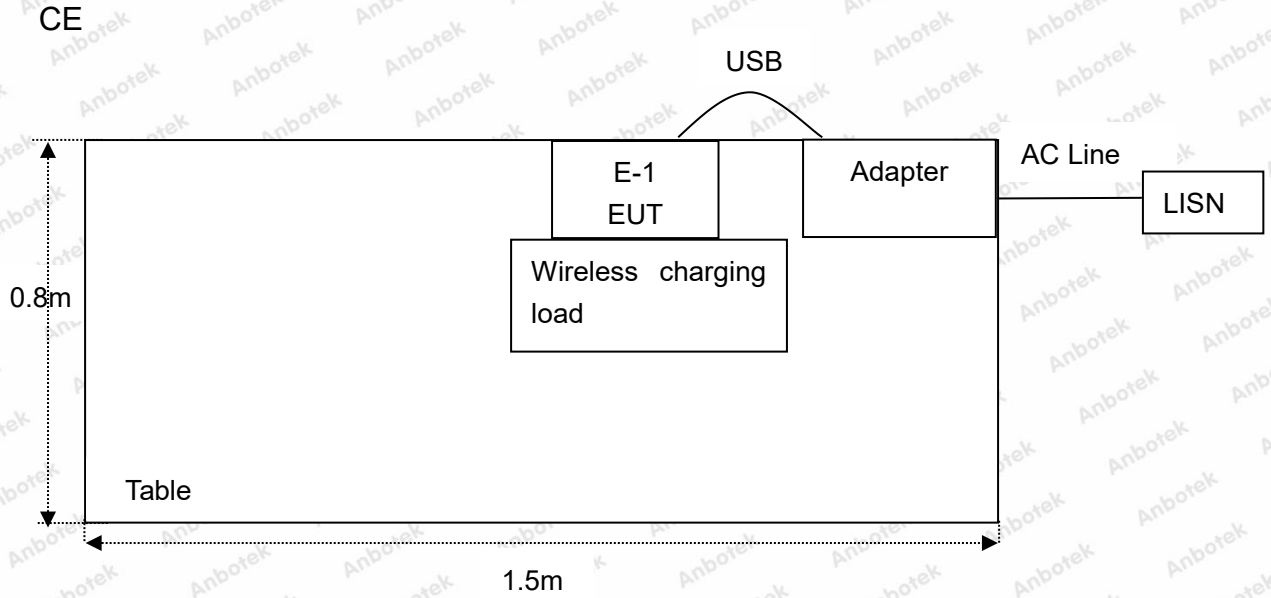

1.6. Test Equipment List

Item	Equipment	Manufacturer	Model No.	Serial No.	Last Cal.	Cal. Interval
1.	L.I.S.N. Artificial Mains Network	Rohde & Schwarz	ENV216	100055	Jan. 18, 2024	1 Year
2.	Three Phase V-type Artificial Power Network	CYBERTEK	EM5040DT	E215040DT001	Jan. 18, 2024	1 Year
3.	EMI Test Receiver	Rohde & Schwarz	ESCI	100627	Oct. 12, 2023	1 Year
4.	EMI Test Receiver	Rohde & Schwarz	ESR26	101481	Jan. 23, 2024	1 Year
5.	MXA Spectrum Analysis	Agilent	N9020A	MY51170037	Oct. 12, 2023	1 Year
6.	EMI Preamplifier	SKET Electronic	LNPA-0118G -45	SKET-PA-002	Jan. 17, 2024	1 Year
7.	Double Ridged Horn Antenna	SCHWARZBECK	BBHA 9120D	02555	Oct. 16, 2022	3 Year
8.	Bilog Broadband Antenna	Schwarzbeck	VULB9163	345	Oct. 23, 2022	3 Year
9.	Loop Antenna	Schwarzbeck	FMZB1519B	00053	Oct. 12, 2023	1 Year
10.	Horn Antenna	A-INFO	LB-180400- KF	J211060628	Oct. 12, 2023	1 Year
11.	Pre-amplifier	SONOMA	310N	186860	Jan. 17, 2024	1 Year
12.	EMI Test Software EZ-EMC	SHURPLE	N/A	N/A	N/A	N/A
13.	MXA Spectrum Analysis	KEYSIGHT	N9020A	MY53280032	Oct. 12, 2023	1 Year
14.	MXG RF Vector Signal Generator	Agilent	N5182A	MY48180656	Oct. 12, 2023	1 Year
15.	Signal Generator	Agilent	E4421B	MY41000743	Oct. 12, 2023	1 Year
16.	DC Power Supply	IVYTECH	IV3605	1804D360510	Oct. 20, 2023	1 Year
17.	Constant Temperature Humidity Chamber	ZHONGJIAN	ZJ-KHWS80 B	N/A	Oct. 16, 2023	1 Year
18.	Spectrum Analyzer	Rohde & Schwarz	FSV40-N	102150	May. 06, 2024	1 Year



1.7. Measurement Uncertainty

Parameter	Uncertainty
Conducted emissions (AMN 150kHz~30MHz)	3.8dB
Radiated spurious emissions (Below 30MHz)	3.53dB
Radiated spurious emissions (30MHz~1GHz)	Horizontal: 3.92dB; Vertical: 4.52dB
The measurement uncertainty and decision risk evaluated according to AB/WI-RF-F-032. This uncertainty represents an expanded uncertainty expressed at approximately the 95% confidence level using a coverage factor of k=2.	

1.8. Description of Test Facility

The test facility is recognized, certified, or accredited by the following organizations:

FCC-Registration No.: 434132

Shenzhen Anbotek Compliance Laboratory Limited, EMC Laboratory has been registered and fully described in a report filed with the (FCC) Federal Communications Commission. The acceptance letter from the FCC is maintained in our files. Registration No. 434132.

ISED-Registration No.: 8058A

Shenzhen Anbotek Compliance Laboratory Limited, EMC Laboratory has been registered and fully described in a report filed with the (ISED) Innovation, Science and Economic Development Canada. The acceptance letter from the ISED is maintained in our files. Registration 8058A.

Test Location

Shenzhen Anbotek Compliance Laboratory Limited.

1/F, Building D, Sogood Science and Technology Park, Sanwei community, Hangcheng Street, Bao'an District, Shenzhen, Guangdong, China.

1.9. Disclaimer

1. The test report is invalid if not marked with the signatures of the persons responsible for preparing and approving the test report.
2. The test report is invalid if there is any evidence and/or falsification.
3. The results documented in this report apply only to the tested sample, under the conditions and modes of operation as described herein.
4. This document may not be altered or revised in any way unless done so by Anbotek and all revisions are duly noted in the revisions section.
5. Content of the test report, in part or in full, cannot be used for publicity and/or promotional purposes without prior written approval from the laboratory.
6. The authenticity of the information provided by the customer is the responsibility of the customer and the laboratory is not responsible for its authenticity.

The laboratory is only responsible for the data released by the laboratory, except for the part provided by the applicant.

Shenzhen Anbotek Compliance Laboratory Limited

Address: 1/F, Building D, Sogood Science and Technology Park, Sanwei Community, Hangcheng Street, Bao'an District, Shenzhen, Guangdong, China.
Tel: (86) 0755-26066440 Fax: (86) 0755-26014772 Email: service@anbotek.com

Code: AB-RF-05-b



Hotline

400-003-0500

www.anbotek.com.cn



2. Summary of Test Results

Standard Section	Test Item	Result
15.203	Antenna Requirement	PASS
15.207	Conducted Emission Test	PASS
15.205/15.209	Spurious Emission	PASS



3. Conducted Emission Test

3.1. Test Standard and Limit

Test Standard	FCC Part15 Section 15.207		
	Frequency	Maximum RF Line Voltage (dBuV)	
		Quasi-peak Level	Average Level
Test Limit	150kHz~500kHz	66 ~ 56 *	56 ~ 46 *
	500kHz~5MHz	56	46
	5MHz~30MHz	60	50

Remark: (1) *Decreasing linearly with logarithm of the frequency.
 (2) The lower limit shall apply at the transition frequency.

3.2. Test Setup

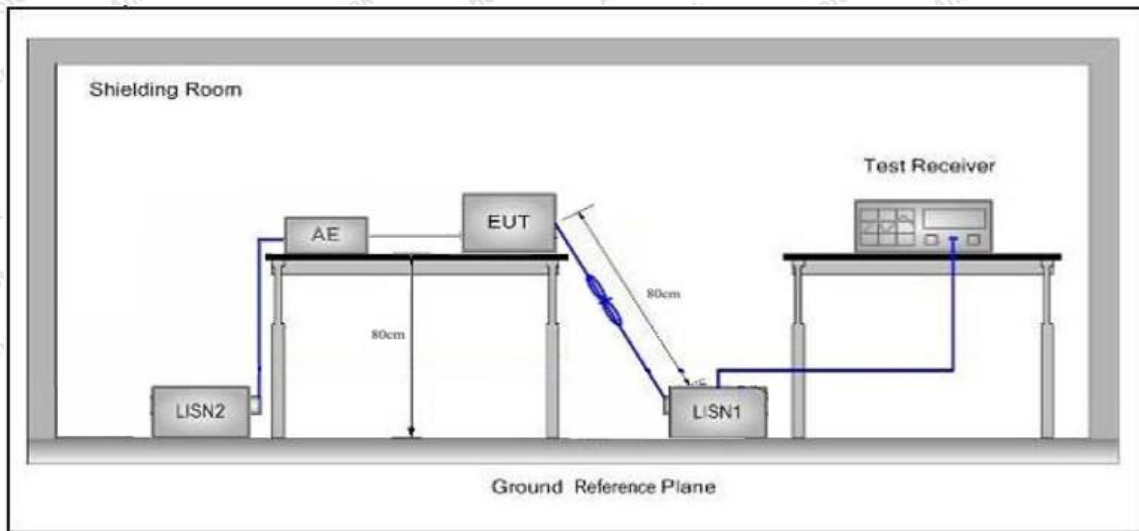

3.3. Test Procedure

The EUT system is connected to the power mains through a line impedance stabilization network (L.I.S.N.). This provides a 50ohm coupling impedance for the EUT system. Please refer the block diagram of the test setup and photographs. Both sides of AC line are checked to find out the maximum conducted emission. In order to find the maximum emission levels, the relative positions of equipment and all of the interface cables shall be changed according to FCC ANSI C63.10: 2020 on Conducted Emission Measurement.

The bandwidth of test receiver (ESCI) set at 9kHz.

The frequency range from 150kHz to 30MHz is checked.

3.4. Test Data

AC conducted emission pre-test at both at AC 120V/60Hz and AC 240V/60Hz modes, recorded worst case AC 120V/60Hz.

Please to see the following pages.



Conducted Emission Test Data

Test Site: 1# Shielded Room
 Operating Condition: Mode 1
 Test Specification: AC 120V, 60Hz for adapter
 Comment: Live Line
 Temp.(°C)/Hum.(%RH): 24.5°C/68%RH

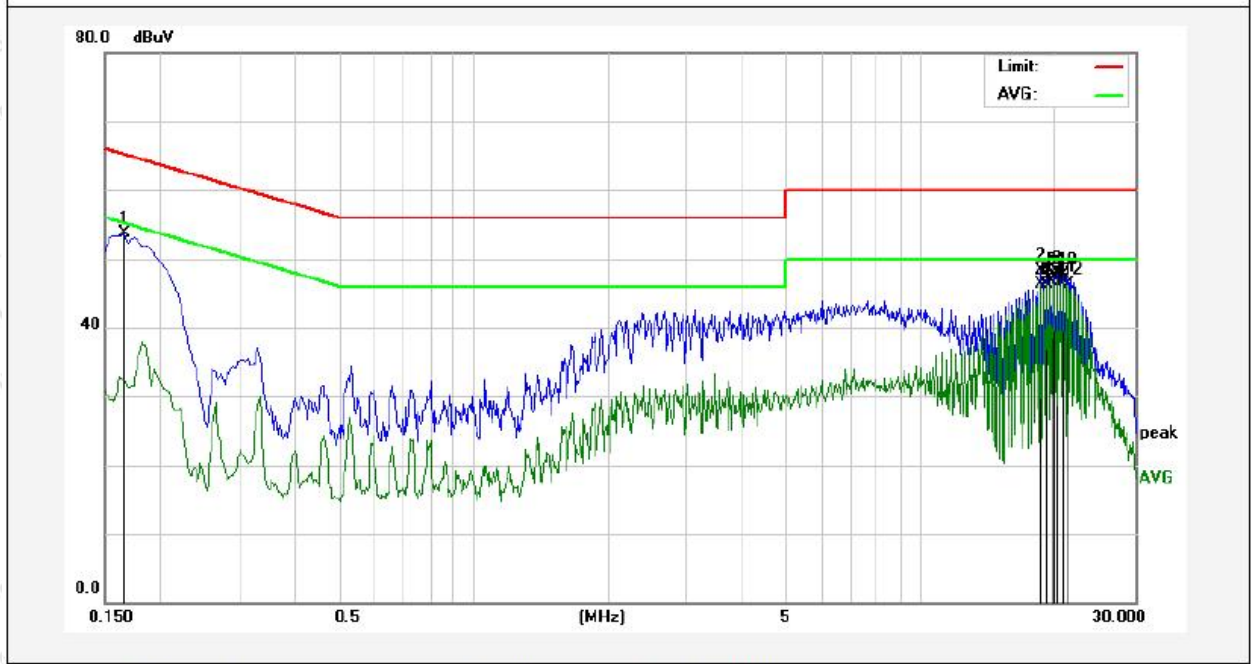

No.	Freq. (MHz)	Reading (dBuV)	Factor (dB)	Result (dBuV)	Limit (dBuV)	Over Limit (dB)	Detector	Remark
1	0.1660	34.66	18.98	53.64	65.15	-11.51	QP	
2	18.4540	29.42	18.85	48.27	60.00	-11.73	QP	
3	18.4540	27.52	18.85	46.37	50.00	-3.63	AVG	
4	19.0260	27.43	18.85	46.28	50.00	-3.72	AVG	
5	19.5980	28.90	18.86	47.76	60.00	-12.24	QP	
6	19.5980	27.81	18.86	46.67	50.00	-3.33	AVG	
7	19.8860	28.43	18.86	47.29	60.00	-12.71	QP	
8	20.1700	28.99	18.86	47.85	60.00	-12.15	QP	
9	20.1700	27.97	18.86	46.83	50.00	-3.17	AVG	
10	20.7420	28.90	18.86	47.76	60.00	-12.24	QP	
11	20.7420	27.91	18.86	46.77	50.00	-3.23	AVG	
12	21.3140	27.41	18.85	46.26	50.00	-3.74	AVG	



Conducted Emission Test Data

Test Site: 1# Shielded Room
 Operating Condition: Mode 1
 Test Specification: AC 120V, 60Hz for adapter
 Comment: Neutral Line
 Temp.(°C)/Hum.(%RH): 24.5°C/68%RH

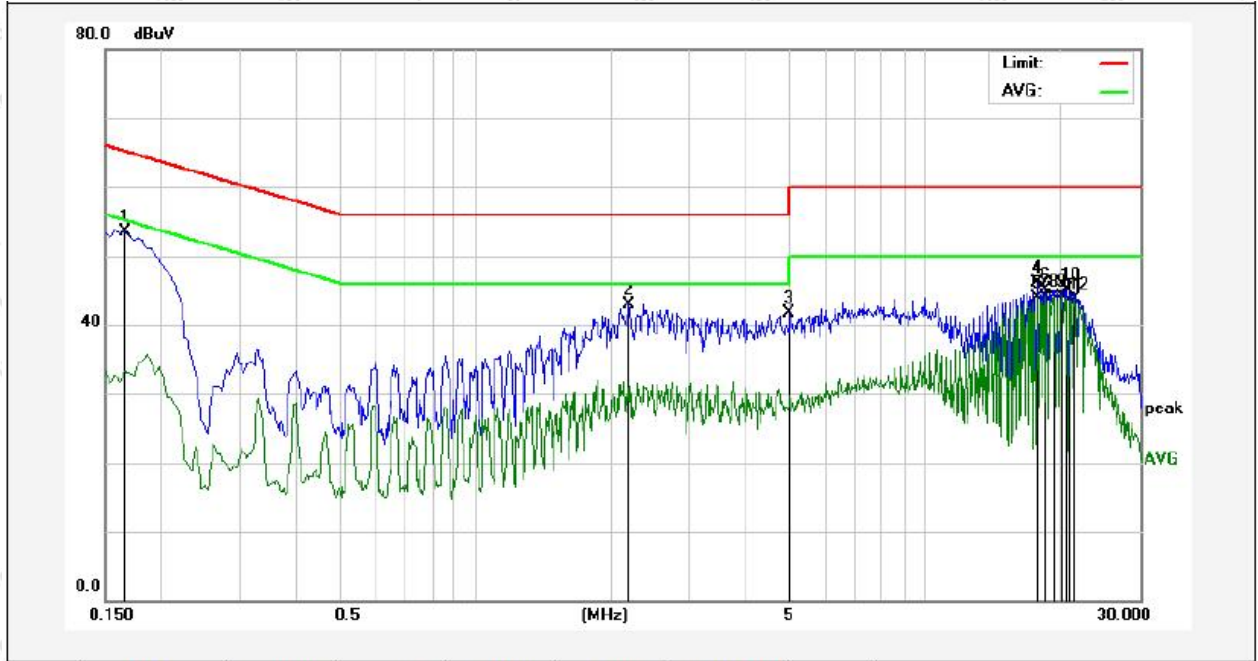

No.	Freq. (MHz)	Reading (dBuV)	Factor (dB)	Result (dBuV)	Limit (dBuV)	Over Limit (dB)	Detector	Remark
1	0.1660	34.51	18.98	53.49	65.15	-11.66	QP	
2	2.1940	24.05	18.88	42.93	56.00	-13.07	QP	
3	4.9860	22.97	18.80	41.77	56.00	-14.23	QP	
4	17.6980	27.17	18.85	46.02	60.00	-13.98	QP	
5	17.6980	25.01	18.85	43.86	50.00	-6.14	AVG	
6	18.5540	26.25	18.85	45.10	60.00	-14.90	QP	
7	18.5540	25.19	18.85	44.04	50.00	-5.96	AVG	
8	19.4100	25.19	18.86	44.05	50.00	-5.95	AVG	
9	20.2660	25.30	18.86	44.16	50.00	-5.84	AVG	
10	20.6940	26.31	18.86	45.17	60.00	-14.83	QP	
11	20.8380	24.74	18.85	43.59	50.00	-6.41	AVG	
12	21.5500	24.82	18.85	43.67	50.00	-6.33	AVG	



4. Radiation Spurious Emission

4.1. Test Standard and Limit

Test Standard	FCC Part15 C Section 15.209 and 15.205				
Test Limit	Frequency (MHz)	Field strength (microvolt/meter)	Limit (dBuV/m)	Remark	Measurement distance (m)
	0.009MHz~0.490MHz	2400/F(kHz)	-	-	300
	0.490MHz-1.705MHz	24000/F(kHz)	-	-	30
	1.705MHz-30MHz	30	-	-	30
	30MHz~88MHz	100	40.0	Quasi-peak	3
	88MHz~216MHz	150	43.5	Quasi-peak	3
	216MHz~960MHz	200	46.0	Quasi-peak	3
	960MHz~1000MHz	500	54.0	Quasi-peak	3
	Above 1000MHz	500	54.0	Average	3
-		-	74.0	Peak	3

Remark:

(1)The lower limit shall apply at the transition frequency.

(2) 15.35(b), Unless otherwise specified, the limit on peak radio frequency emissions is 20dB above the maximum permitted average emission limit applicable to the equipment under test. This peak limit applies to the total peak emission level radiated by the device.

4.2. Test Setup

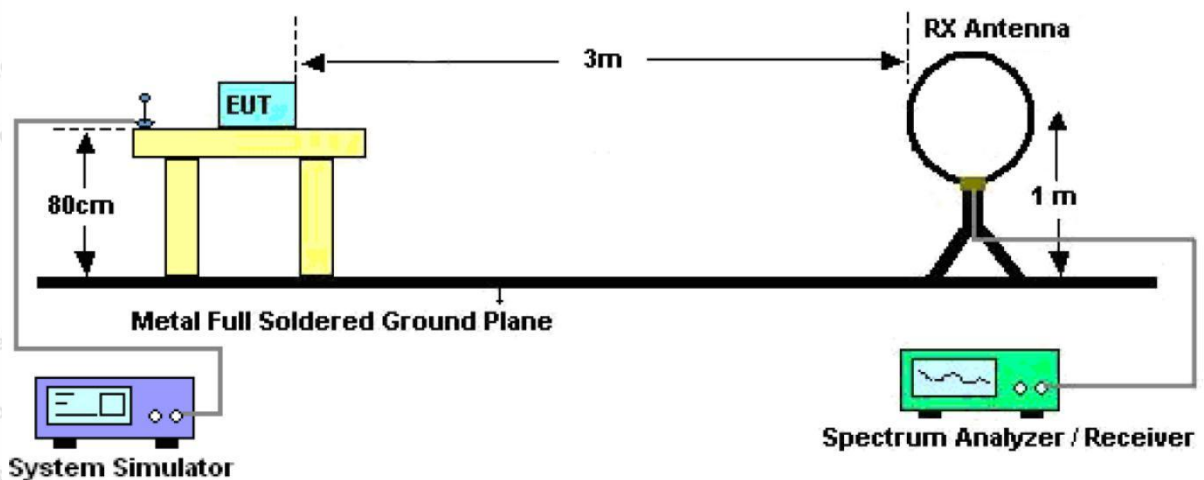

Figure 1. Below 30MHz



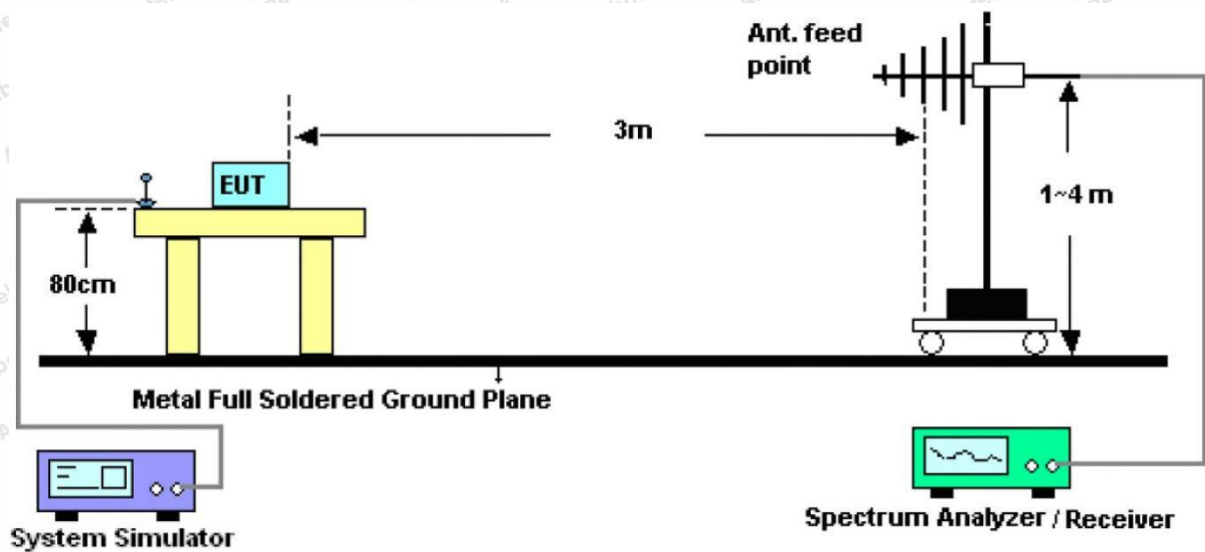

Figure 2. 30MHz to 1GHz

4.3. Test Procedure

For below 1GHz: The EUT is placed on a turntable, which is 0.8m above the ground plane.

The turn table can rotate 360 degrees to determine the position of the maximum emission level. The EUT is set 3 meters away from the receiving antenna which is mounted on a antenna tower. The antenna can be moved up and down from 1 to 4 meters to find out the maximum emission level. Rotated the EUT through three orthogonal axes to determine the maximum emissions, both horizontal and vertical polarization of the antenna are set on test. The EUT is tested in 9*6*6 Chamber. The device is evaluated in xyz orientation.

For 9kHz to 150kHz, Set the spectrum analyzer as:

RBW = 200Hz, VBW = 1kHz, Detector= Quasi-Peak, Trace mode= Max hold, Sweep- auto couple.

For 150kHz to 30MHz, Set the spectrum analyzer as:

RBW = 9KHz, VBW = 30kHz, Detector= Quasi-Peak, Trace mode= Max hold, Sweep- auto couple.

For 30MHz to 1000MHz, Set the spectrum analyzer as:

RBW = 100kHz, VBW = 300kHz, Detector= Quasi-Peak, Trace mode= Max hold, Sweep- auto couple.

4.4. Test Data

PASS

During the test, Pre-scan all kind of the place mode (X-axis, Y-axis, Z-axis), and found the X-axis is the worst case.



Test Results (Between 9KHz – 150KHz)

Test Mode: Mode 1
 Distance: 3m
 Power Source: AC 120V, 60Hz for adapter
 Temp.(°C)/Hum.(%RH): 23.5°C/49%RH

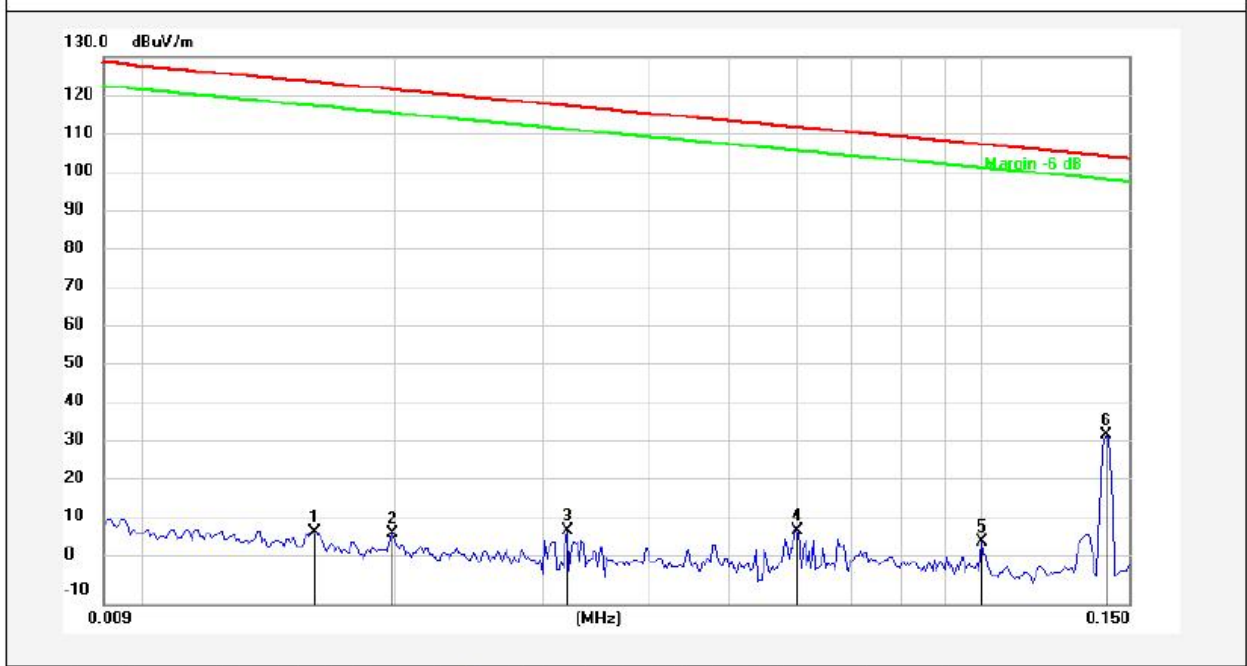

No.	Freq. (MHz)	Reading (dBuV)	Factor (dB)	Result (dBuV/m)	Limit (dBuV/m)	Over Limit (dB)	Detector	Height (cm)	degree (deg)	Remark
1	0.0160	-11.83	20.30	8.47	123.42	-114.95	QP			
2	0.0198	-12.16	20.29	8.13	121.58	-113.45	QP			
3	0.0320	-11.99	20.56	8.57	117.42	-108.85	QP			
4	0.0600	-11.48	20.37	8.89	111.98	-103.09	QP			
5	0.1000	-14.30	20.29	5.99	107.56	-101.57	QP			
6	0.1408	12.94	20.33	33.27	104.60	-71.33	QP			



Test Results (Between 0.15MHz – 30MHz)

Test Mode: Mode 1
 Distance: 3m
 Power Source: AC 120V, 60Hz for adapter
 Temp.(°C)/Hum.(%RH): 23.5°C/49%RH

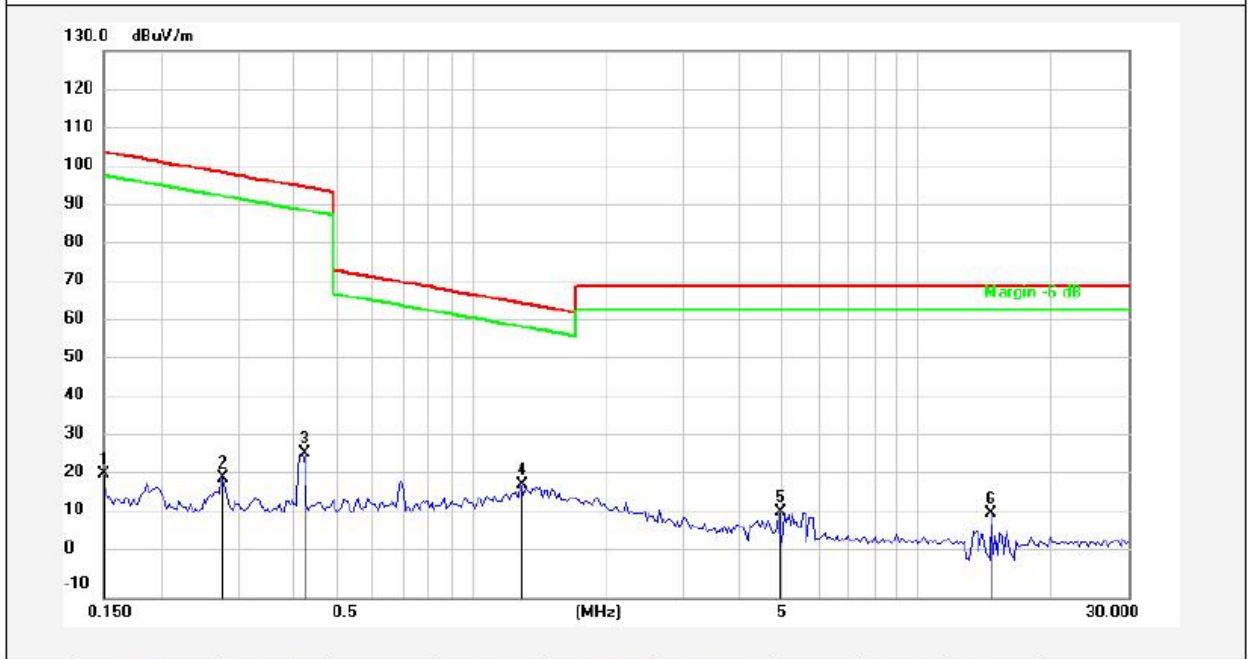

No.	Freq. (MHz)	Reading (dBuV)	Factor (dB)	Result (dBuV/m)	Limit (dBuV/m)	Over Limit (dB)	Detector	Height (cm)	degree (deg)	Remark
1	0.1500	1.19	20.33	21.52	104.05	-82.53	QP			
2	0.2773	0.47	20.31	20.78	98.73	-77.95	QP			
3	0.4193	6.60	20.27	26.87	95.15	-68.28	QP			
4	1.2892	-1.39	20.26	18.87	65.42	-46.55	QP			
5	4.8997	-8.50	20.41	11.91	69.50	-57.59	QP			
6	14.7497	-9.05	20.54	11.49	69.50	-58.01	QP			

Remark: According to FCC PART 15.209 (d), the emission limits for the frequency bands 9–90 kHz, 110–490 kHz and above 1000 MHz, Radiated emission limits in these three bands are based on measurements employing an average detector.



Test Results (Between 30MHz –1000 MHz)

Test Mode: Mode 1
 Distance: 3m
 Power Source: AC 120V, 60Hz for adapter
 Polarization: Horizontal
 Temp.(°C)/Hum.(%RH): 20.3°C/46%RH



No.	Freq. (MHz)	Reading (dBuV)	Factor (dB/m)	Result (dBuV/m)	Limit (dBuV/m)	Over Limit (dB)	Detector	Height (cm)	degree (deg)	Remark
1	55.2207	37.84	-17.62	20.22	40.00	-19.78	QP			
2	191.7450	50.65	-22.68	27.97	43.50	-15.53	QP			
3	264.7457	47.91	-20.21	27.70	46.00	-18.30	QP			
4	362.9844	44.45	-16.03	28.42	46.00	-17.58	QP			
5	638.3686	36.65	-10.63	26.02	46.00	-19.98	QP			
6	903.3094	33.48	-6.19	27.29	46.00	-18.71	QP			



Test Mode: Mode 1
 Distance: 3m
 Power Source: AC 120V, 60Hz for adapter
 Polarization: Vertical
 Temp.(°C)/Hum.(%RH): 20.3°C/46%RH



No.	Freq. (MHz)	Reading (dBuV)	Factor (dB/m)	Result (dBuV/m)	Limit (dBuV/m)	Over Limit (dB)	Detector	Height (cm)	degree (deg)	Remark
1	49.7068	40.23	-15.73	24.50	40.00	-15.50	QP			
2	103.4421	49.22	-17.12	32.10	43.50	-11.40	QP			
3	134.0882	47.40	-21.76	25.64	43.50	-17.86	QP			
4	191.7450	47.61	-20.05	27.56	43.50	-15.94	QP			
5	645.1195	36.86	-10.65	26.21	46.00	-19.79	QP			
6	848.0563	35.31	-7.52	27.79	46.00	-18.21	QP			



5. Antenna Requirement

5.1. Test Standard and Requirement

Test Standard	FCC Part15 Section 15.203
Requirement	1) 15.203 requirement: An intentional radiator shall be designed to ensure that no antenna other than that furnished by the responsible party shall be used with the device. The use of a permanently attached antenna or of an antenna that uses a unique coupling to the intentional radiator, the manufacturer may design the unit so that a broken antenna can be replaced by the user, but the use of a standard antenna jack or electrical connector is prohibited.

5.2. Antenna Connected Construction

The antenna is a Inductive loop coil Antenna which permanently attached, and the best case gain of the antenna is 0 dBi. It complies with the standard requirement.



APPENDIX I -- TEST SETUP PHOTOGRAPH

Please refer to separated files Appendix I -- Test Setup Photograph_RF

APPENDIX II -- EXTERNAL PHOTOGRAPH

Please refer to separated files Appendix II -- External Photograph

APPENDIX III -- INTERNAL PHOTOGRAPH

Please refer to separated files Appendix III -- Internal Photograph

----- End of Report -----

