

TEST REPORT

Report No..... : KD2401S0542E02
FCC ID..... : 2BBKS-PW
Applicant..... : PETGUGU TECHNOLOGY PTE. LTD.
Address..... : 12 Eu Tong Sen Street #04-171 Singapore 059819
Manufacturer..... : Shenzhen USEER Robotics Co.,Ltd.
Address..... : Building 2, Fashion Brand Industrial Park, E'Bu Town, Shenzhen-Shanwei
Special Cooperation Zone, Shenzhen, Guangdong, China.
Product Name..... : Smart Cat Litter Box Toilet
Trademark..... : petgugu
Model/Type reference..... : PW5, PW*,PW**,PW***(*=9-0 or A-Z,represent different color/accessories)
Standard..... : 47 CFR Part 15.247
Date of Receipt..... : February 30, 2024
Date of Test Date..... : February 30, 2024 to March 28, 2024
Date of issue..... : March 28, 2024
Test result..... : Pass

Conclusion..... : The submitted sample was found to COMPLY with the standards above.

Prepared by:
(Printed name + Signature) Pai Zheng



Approved by:
(Printed name + Signature) Sky Dong

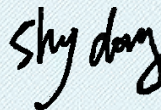

Testing Laboratory Name...: KSIGN(Guangdong) Testing Co., Ltd.

Address..... : West Side of 1/F., Building C, Zone A, Fuyuan New Factory, Jiujiu Industrial
Park, Minzhu, Shatou, Shajing, Bao'an District, Shenzhen, Guangdong,
China

TABLE OF CONTENTS**Page**

1. TEST SUMMARY	3
1.1. Test Standards	3
1.2. Report Version	3
1.3. Test Description	4
1.4. Test Facility	5
1.5. Measurement Uncertainty	5
2. GENERAL INFORMATION	6
2.1. General Description Of EUT	6
2.2. Accessory Equipment Information	6
2.3. Description of Test Modes	6
2.4. Operation channel list	7
2.5. Measurement Instruments List	8
3. Evaluation Results (Evaluation)	10
3.1. Antenna requirement	10
4. Radio Spectrum Matter Test Results (RF)	10
4.1. Conducted Emission at AC power line	10
4.2. Occupied Bandwidth	14
4.3. Maximum Conducted Output Power	15
4.4. Power Spectral Density	16
4.5. Emissions in non-restricted frequency bands	17
4.6. Band edge emissions (Radiated)	18
4.7. Emissions in frequency bands (below 1GHz)	23
4.8. Emissions in frequency bands (above 1GHz)	26
5. EUT TEST PHOTOS	33
6. PHOTOGRAPHS OF EUT CONSTRUCTIONAL	35
Appendix	36
6.1. Appendix A: DTS Bandwidth	37
6.2. Appendix B: Occupied Channel Bandwidth	41
6.3. Appendix C: Maximum conducted output power	45
6.4. Appendix D: Maximum power spectral density	48
6.5. ppendix E: Reference level measurement	52
6.6. Appendix F: Band edge measurements	56
6.7. Appendix G: Conducted Spurious Emission	59
6.8. Appendix H: Duty Cycle	65

1. TEST SUMMARY

1.1. Test Standards

The tests were performed according to following standards:

47 CFR Part 15.247: Operation within the bands 902-928 MHz, 2400-2483.5 MHz, and 5725-5850 MHz

ANSI C63.10-2013: American National Standard of Procedures for Compliance Testing of Unlicensed Wireless Devices.

KDB 558074 D01 15.247 Meas Guidance v05r02: Guidance for compliance measurements on digital transmission system, frequency hopping spread spectrum system, and hybrid system devices operating under section 15.247 of the FCC rules.

1.2. Report Version

Revised No.	Date of issue	Description
01	March 28, 2024	Original

1.3. Test Description

Test Item	Standard	Requirement	Result
Antenna requirement	47 CFR Part 15.247	47 CFR 15.203	Pass
Conducted Emission at AC power line	47 CFR Part 15.247	47 CFR 15.207(a)	Pass
Occupied Bandwidth	47 CFR Part 15.247	47 CFR 15.247(a)(2)	Pass
Maximum Conducted Output Power	47 CFR Part 15.247	47 CFR 15.247(b)(3)	Pass
Power Spectral Density	47 CFR Part 15.247	47 CFR 15.247(e)	Pass
Emissions in non-restricted frequency bands	47 CFR Part 15.247	47 CFR 15.247(d), 15.209, 15.205	Pass
Band edge emissions (Radiated)	47 CFR Part 15.247	47 CFR 15.247(d), 15.209, 15.205	Pass
Emissions in frequency bands (below 1GHz)	47 CFR Part 15.247	47 CFR 15.247(d), 15.209, 15.205	Pass
Emissions in frequency bands (above 1GHz)	47 CFR Part 15.247	47 CFR 15.247(d), 15.209, 15.205	Pass

TRF RF_R1

Add: West Side of 1/F., Building C, Zone A, Fuyuan New Factory, Jiujiu Industrial Park, Minzhu, Shatou, Shajing, Bao'an District, Shenzhen, Guangdong, China

Tel: +(86) 0755-2985 2678 Fax: +(86) 0755-2985 2397 E-mail: info@gdkesign.cn Web: www.gdkesign.com

1.4. Test Facility

KSIGN(Guangdong) Testing Co., Ltd.

West Side of 1/F., Building C, Zone A, Fuyuan New Factory, Jiujiu Industrial Park, Minzhu, Shatou, Shajing, Bao'an District, Shenzhen, Guangdong, China

The test facility is recognized, certified, or accredited by the following organizations:

CNAS-Lab Code: L13261

KSIGN(Guangdong) Testing Co., Ltd. has been assessed and proved to be in Compliance with CNAS-CL01 Accreditation Criteria for Testing and Calibration Laboratories (identical to ISO/IEC17025: 2017 General Requirements) for the Competence of Testing and Calibration Laboratories.

A2LA-Lab Cert. No.: 5457.01

KSIGN(Guangdong) Testing Co., Ltd. EMC Laboratory has been accredited by A2LA for technical competence in the field of electrical testing, and proved to be in compliance with ISO/IEC 17025:2017 General Requirements for the Competence of Testing and Calibration Laboratories and any additional program requirements in the identified field of testing

ISED#: 25693 CAB identifier.: CN0096

KSIGN(Guangdong) Testing Co., Ltd. has been listed by Innovation, Science and Economic Development Canada to perform electromagnetic emission measurement.

FCC-Registration No.: 294912 Designation Number: CN1328

KSIGN(Guangdong) Testing Co., Ltd. EMC Laboratory has been listed on the US Federal Communications Commission list of test facilities recognized to perform electromagnetic emissions measurements.

1.5. Measurement Uncertainty

Test Items	Measurement Uncertainty
Conducted Emission (150k-30MHz)	± 3.34dB
Output Power, Conducted	± 1.4dB
PSD, Conducted	± 1.0dB
Spurious Emissions, Conducted	± 3.3dB
RSE (1-18GHz)	± 4.68dB
RSE (30-1000MHz)	± 5.7dB
RSE (18-40GHz)	± 5.18dB

The reported uncertainty of measurement $y \pm U$, where expanded uncertainty U is based on a standard uncertainty multiplied by a coverage factor of $k=2$, providing a level of confidence of approximately 95 %. Otherwise required by the applicant or Product Regulations. Decision Rule in this report did not consider the uncertainty.

2. GENERAL INFORMATION

2.1. General Description Of EUT

Test Sample Number:	1-1(Normal Sample), 1-2(Engineering Sample)
Product Name:	Smart Cat Litter Box Toilet
Trademark:	petgugu
Model / Type reference:	PW5, PW*,PW**,PW***(*=9-0 or A-Z,represent different color/accessories)
Model Difference:	The difference product models are models name and represent different color of appearance. Different model names are available to meet market demands. Other power supply methods, internal structures, circuits and key components are the same, and do not affect safety and electromagnetic compatibility performance.According to the above information, all tests were performed on PW5.
Power Supply:	AC 120V
Operation Frequency:	2402MHz to 2480MHz
Number of Channels:	40
Modulation Type:	GFSK
Antenna Type:	PCB
Antenna Gain:	1.70dBi
Max TX Power:	-0.24dBm
Hardware Version:	E351308
Software Version:	V1.5

2.2. Accessory Equipment Information

The EUT was tested as an independent device.

2.3. Description of Test Modes

No.	Title	Description of Mode
Test Mode1	TX mode	Keep the EUT connect to AC power line and works in continuously transmitting mode with GFSK modulation.

2.4. Operation channel list

Channel	Frequency (MHz)	Channel	Frequency (MHz)	Channel	Frequency (MHz)	Channel	Frequency (MHz)
0	2402	10	2422	20	2442	30	2462
1	2404	11	2424	21	2444	31	2464
2	2406	12	2426	22	2446	32	2466
3	2408	13	2428	23	2448	33	2468
4	2410	14	2430	24	2450	34	2470
5	2412	15	2432	25	2452	35	2472
6	2414	16	2434	26	2454	36	2474
7	2416	17	2436	27	2456	37	2476
8	2418	18	2438	28	2458	38	2478
9	2420	19	2440	29	2460	39	2480

TRF RF_R1

Add: West Side of 1/F., Building C, Zone A, Fuyuan New Factory, Jiujiu Industrial Park, Minzhu, Shatou, Shajing, Bao'an District, Shenzhen, Guangdong, China

Tel: +(86) 0755-2985 2678 Fax: +(86) 0755-2985 2397 E-mail: info@gdkesign.cn Web: www.gdkesign.com

2.5. Measurement Instruments List

Conducted Emission at AC power line				
Test Equipment	Manufacturer	Model No.	Serial No.	Cal. Until
LISN	R&S	ENV432	1326.6105.02	2025-01-21
EMI Test Receiver	R&S	ESR	102524	2025-01-21
Manual RF Switch	JS TOYO	/	MSW-01/002	2025-01-21
ISN CAT6	Schwarzbeck	CAT5 8158	227	2025-01-21
Color Signal Generator	Philips	PM5418	672926	2025-01-21
Power Absorbing Clamp	R&S	MDS-21	100925	2025-01-22
TV Tuner	SUNLIGHT	ST5075	/	2024-12-12
Artificial power network	EVERFINE	LS-5	G657431CD14311 12	2025-01-21

Emissions in non-restricted frequency bands Occupied Bandwidth Maximum Conducted Output Power Power Spectral Density				
Test Equipment	Manufacturer	Model No.	Serial No.	Cal. Until
Wideband Radio Communication Tester	R&S	CMU200	115297	2025-01-19
Audio Analyzer	R&S	UPL16	100001	2025-01-19
Shielding box	Gxiong	GX-5915A	2201113	2025-01-19
High Pass Filter	COM-MW Technology Co., Ltd	ZHPF-M1.2-9G-1 87	09203403	2025-01-19
Band Stop Filter	COM-MW Technology Co., Ltd	ZBSF6-C820-920 -188	09203401	2025-01-19
Splitter	COM-MW Technology Co., Ltd	ZPD-M1-8-2103	09203407	2025-01-19
Coaxial Cable	BEBES	A40-2.92M2.92F- 4.5M	1907021	2025-01-19
Hygrothermograph	Anymetre	JB913	/	2025-01-19
Climate Chamber	Angul	AGNH80L	1903042120	2025-01-19
Spectrum Analyzer	HP	8593E	3831U02087	2025-01-19
Dual Output DC Power Supply	Agilent	E3646A	MY40009992	2025-01-19
RF Control Unit	Tonscend	JS0806-2	/	2025-01-19
Analog Signal Generator	HP	83752A	3344A00337	2025-01-19
Vector Signal Generator	Agilent	N5182A	MY50142520	2025-01-19
Wideband Radio Communication Tester	R&S	CMW500	157282	2025-01-19
Spectrum Analyzer	R&S	FSV40-N	101798	2025-01-19

TRF RF_R1

Add: West Side of 1/F., Building C, Zone A, Fuyuan New Factory, Jiujiu Industrial Park, Minzhu, Shatou, Shajing, Bao'an District, Shenzhen, Guangdong, China

Tel: +(86) 0755-2985 2678 Fax: +(86) 0755-2985 2397 E-mail: info@gdkesign.cn Web: www.gdkesign.com

Band edge emissions (Radiated)				
Emissions in frequency bands (below 1GHz)				
Emissions in frequency bands (above 1GHz)				
Test Equipment	Manufacturer	Model No.	Serial No.	Cal. Until
Color Signal Generator	Philips	PM5418	672926	2025-01-21
Log Periodic Antenna	Schwarzbeck	VULB 9163	1230	2025-01-29
Pre-Amplifier	Schwarzbeck	BBV 9745	9745#129	2025-01-21
Broadcast Television Signal Generator	R&S	SFE100	141038	2025-01-21
Analog Signal Generator	Agilent	8648A	3847M00445	2025-01-21
EMI Test Receiver	R&S	ESR	102525	2025-01-21
Loop Antenna	Beijin ZHINAN	ZN30900C	18050	2025-01-29
Horn Antenna	Schwarzbeck	BBHA 9120 D	2023	2025-01-22
Pre-Amplifier	EMCI	EMC051835SE	980662	2025-01-21
Spectrum Analyzer	Keysight	N9020A	MY46471971	2025-01-21

TRF RF_R1

Add: West Side of 1/F., Building C, Zone A, Fuyuan New Factory, Jiujiu Industrial Park, Minzhu, Shatou, Shajing, Bao'an District, Shenzhen, Guangdong, China

Tel: +(86) 0755-2985 2678 Fax: +(86) 0755-2985 2397 E-mail: info@gdkesign.cn Web: www.gdkesign.com

3. Evaluation Results (Evaluation)

3.1. Antenna requirement

Test Requirement:	Refer to 47 CFR Part 15.203, an intentional radiator shall be designed to ensure that no antenna other than that furnished by the responsible party shall be used with the device. The use of a permanently attached antenna or of an antenna that uses a unique coupling to the intentional radiator shall be considered sufficient to comply with the provisions of this section.
Conclusion:	The directional gain of the antenna less than 6dBi, please refer to the EUT internal photographs antenna photo.

4. Radio Spectrum Matter Test Results (RF)

4.1. Conducted Emission at AC power line

Test Requirement:	Refer to 47 CFR 15.207(a), Except as shown in paragraphs (b)and (c)of this section, for an intentional radiator that is designed to be connected to the public utility (AC) power line, the radio frequency voltage that is conducted back onto the AC power line on any frequency or frequencies, within the band 150 kHz to 30 MHz, shall not exceed the limits in the following table, as measured using a 50 μH/50 ohms line impedance stabilization network (LISN).		
Test Limit:	Frequency of emission (MHz)	Conducted limit (dBμV)	
		Quasi-peak	Average
	0.15-0.5	66 to 56*	56 to 46*
	0.5-5	56	46
	5-30	60	50
	*Decreases with the logarithm of the frequency.		
Test Method:	ANSI C63.10-2013 section 6.2		
Procedure:	Refer to ANSI C63.10-2013 section 6.2, standard test method for ac power-line conducted emissions from unlicensed wireless devices		

4.1.1. E.U.T. Operation:

Operating Environment:	
Temperature:	25.3 °C
Humidity:	54.8 %
Atmospheric Pressure:	101 kPa
Final test mode:	Test Mode1

4.1.2. Test Setup Diagram:

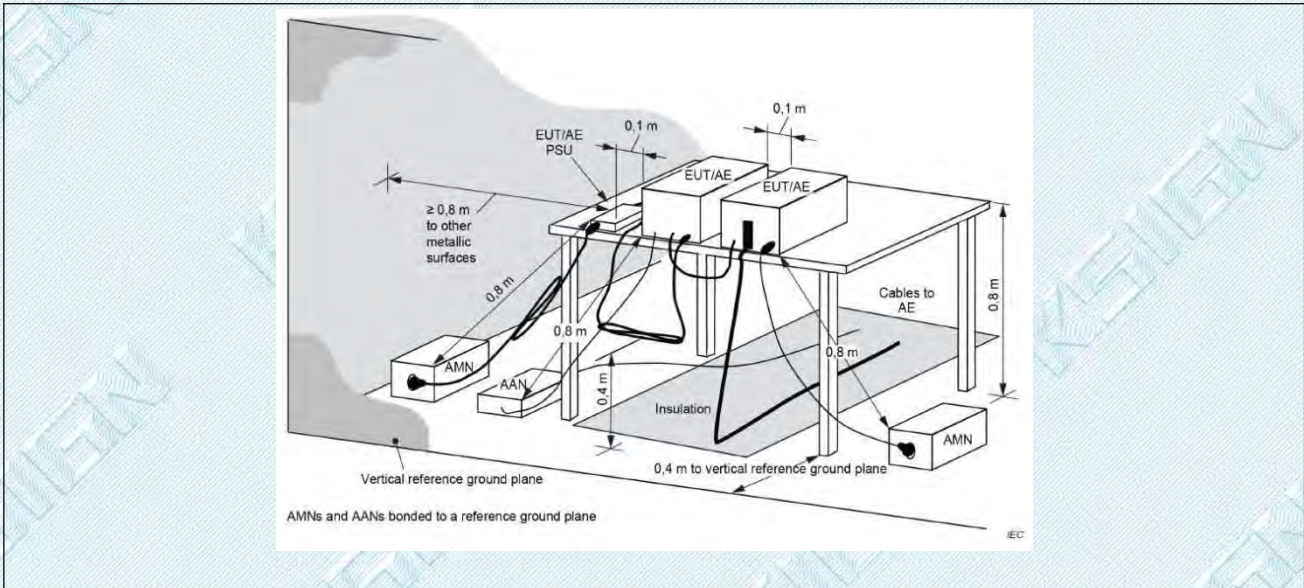

4.1.3. Test Data:

Test Mode1 / Line: Line

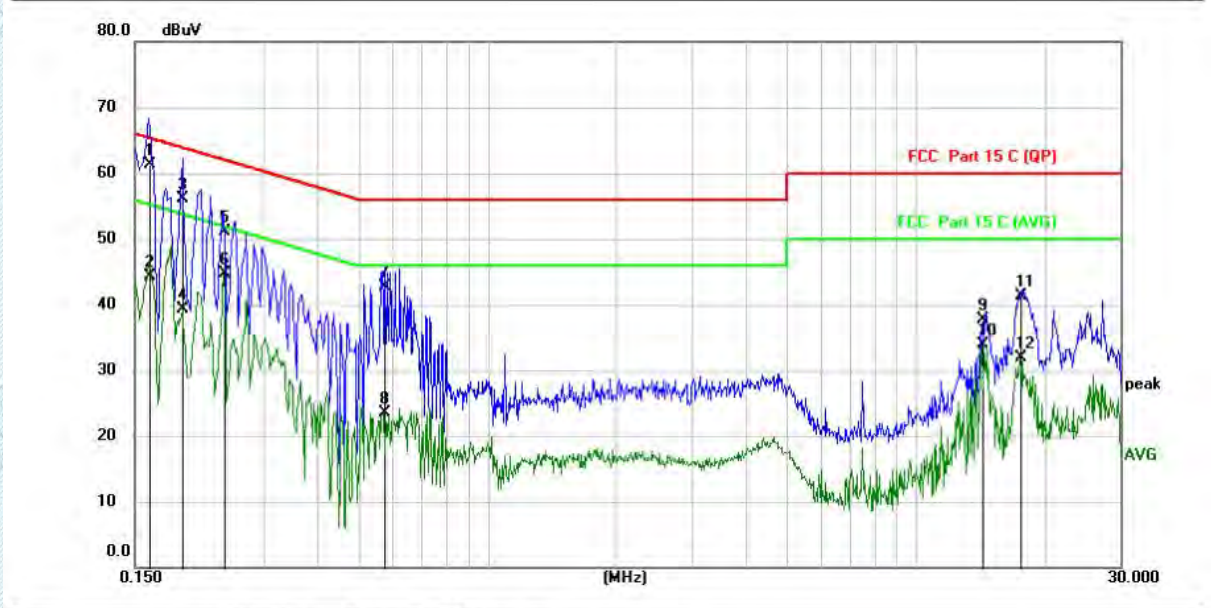

No. Mk.	Freq. MHz	Reading Level dBuV	Correct Factor dB	Measurement dBuV	Limit dBuV	Over dB	Detector	Comment
1 *	0.1620	50.87	10.41	61.28	65.36	-4.08	QP	
2	0.1620	33.88	10.41	44.29	55.36	-11.07	AVG	
3	0.1940	45.79	10.41	56.20	63.86	-7.66	QP	
4	0.1940	28.91	10.41	39.32	53.86	-14.54	AVG	
5	0.2419	40.77	10.41	51.18	62.03	-10.85	QP	
6	0.2419	34.36	10.41	44.77	52.03	-7.26	AVG	
7	0.5735	32.17	10.45	42.62	56.00	-13.38	QP	
8	0.5735	13.02	10.45	23.47	46.00	-22.53	AVG	
9	14.2619	26.77	10.99	37.76	60.00	-22.24	QP	
10	14.2619	22.90	10.99	33.89	50.00	-16.11	AVG	
11	17.5335	30.12	11.23	41.35	60.00	-18.65	QP	
12	17.5335	20.69	11.23	31.92	50.00	-18.08	AVG	

TRF RF_R1

Add: West Side of 1/F., Building C, Zone A, Fuyuan New Factory, Jiujiu Industrial Park, Minzhu, Shatou, Shajing, Bao'an District, Shenzhen, Guangdong, China

Tel: +(86) 0755-2985 2678 Fax: +(86) 0755-2985 2397 E-mail: info@gdkesign.cn Web: www.gdkesign.com

Test Mode1 / Line: Neutral

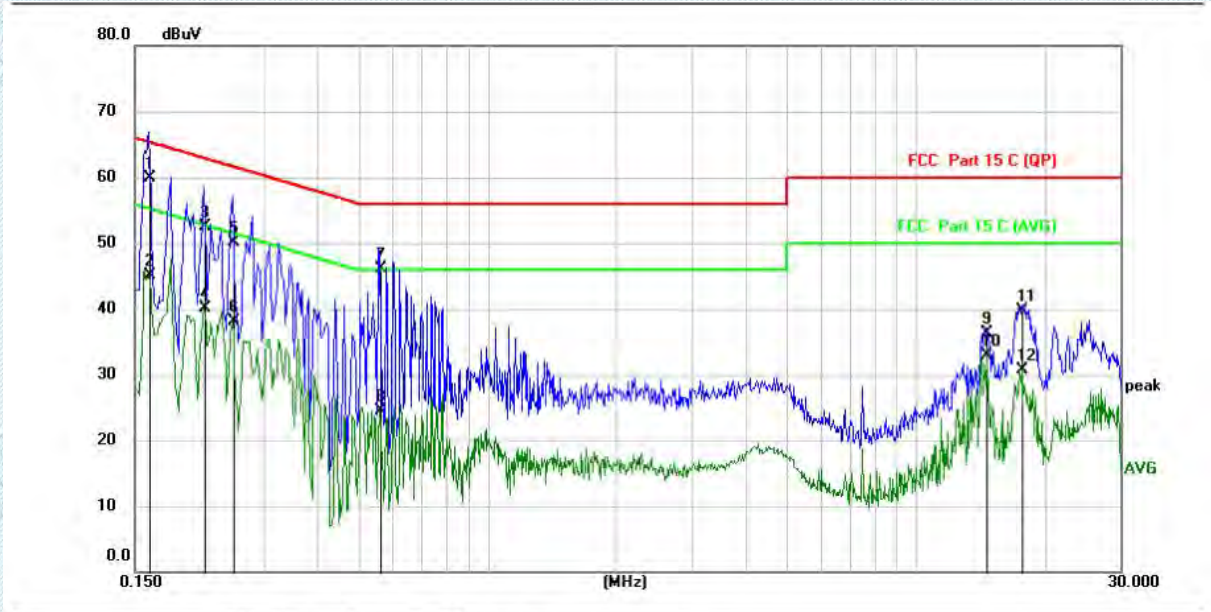

No. Mk.	Freq. MHz	Reading Level dBuV	Correct Factor dB	Measurement dBuV	Limit dBuV	Over dB	Detector	Comment
1 *	0.1620	49.62	10.38	60.00	65.36	-5.36	QP	
2	0.1620	34.80	10.38	45.18	55.36	-10.18	AVG	
3	0.2179	42.04	10.38	52.42	62.90	-10.48	QP	
4	0.2179	29.68	10.38	40.06	52.90	-12.84	AVG	
5	0.2540	39.66	10.38	50.04	61.63	-11.59	QP	
6	0.2540	27.78	10.38	38.16	51.63	-13.47	AVG	
7	0.5620	35.70	10.42	46.12	56.00	-9.88	QP	
8	0.5620	14.18	10.42	24.60	46.00	-21.40	AVG	
9	14.6339	25.31	10.97	36.28	60.00	-23.72	QP	
10	14.6339	21.97	10.97	32.94	50.00	-17.06	AVG	
11	17.7454	28.40	11.21	39.61	60.00	-20.39	QP	
12	17.7454	19.40	11.21	30.61	50.00	-19.39	AVG	

Remark:

1. Both 120 VAC, 50/60 Hz power supply have been tested, only the worst result of 120 VAC, 60 Hz was reported as below.
2. Measurement = Reading Level+ Correct Factor
3. Over = Measurement -Limit

TRF RF_R1

Add: West Side of 1/F., Building C, Zone A, Fuyuan New Factory, Jiujiu Industrial Park, Minzhu, Shatou, Shajing, Bao'an District, Shenzhen, Guangdong, China

Tel: +(86) 0755-2985 2678 Fax: +(86) 0755-2985 2397 E-mail: info@gdkesign.cn Web: www.gdkesign.com

4.2. Occupied Bandwidth

Test Requirement:	47 CFR 15.247(a)(2)
Test Limit:	Refer to 47 CFR 15.247(a)(2), Systems using digital modulation techniques may operate in the 902-928 MHz, and 2400-2483.5 MHz bands. The minimum 6 dB bandwidth shall be at least 500 kHz.
Test Method:	ANSI C63.10-2013, section 11.8 KDB 558074 D01 15.247 Meas Guidance v05r02
Procedure:	<ul style="list-style-type: none"> a) Set RBW = 100 kHz. b) Set the VBW \geq [3 × RBW]. c) Detector = peak. d) Trace mode = max hold. e) Sweep = auto couple. f) Allow the trace to stabilize. g) Measure the maximum width of the emission that is constrained by the frequencies associated with the two outermost amplitude points (upper and lower frequencies) that are attenuated by 6 dB relative to the maximum level measured in the fundamental emission.

4.2.1. E.U.T. Operation:

Operating Environment:	
Temperature:	25.3 °C
Humidity:	54.8 %
Atmospheric Pressure:	101 kPa
Final test mode:	Test Mode1

4.2.2. Test Setup Diagram:

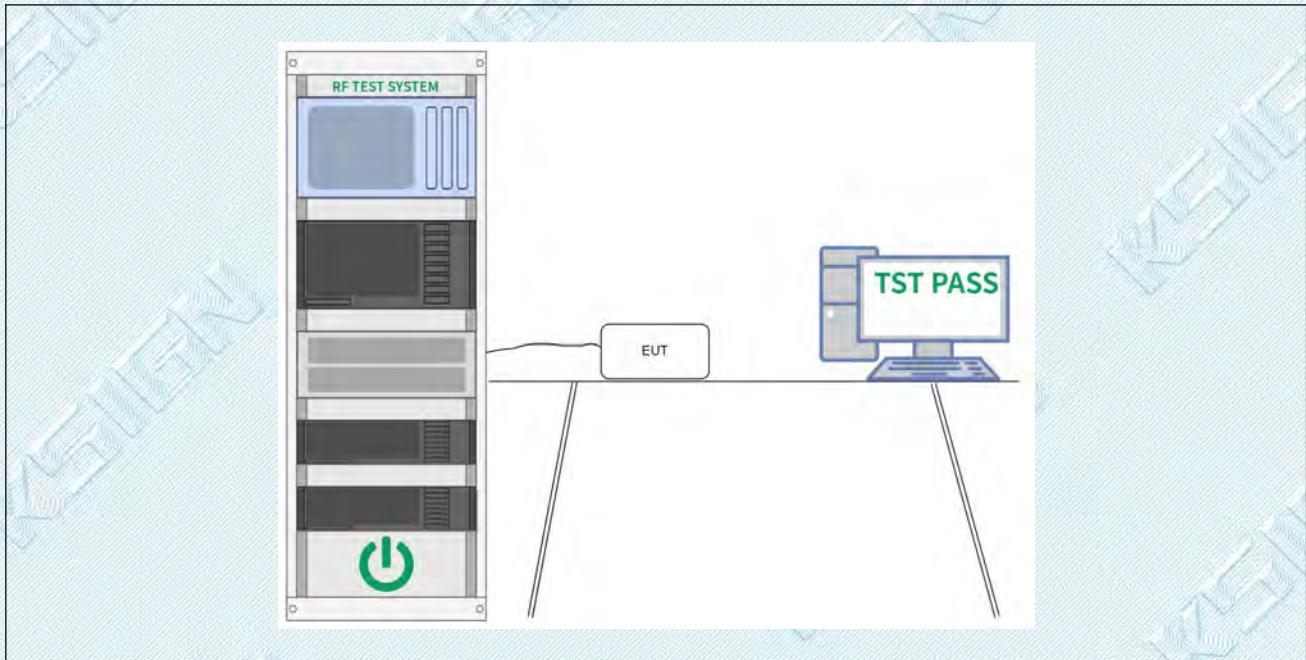

4.2.3. Test Data:

Please Refer to Appendix for Details.

4.3. Maximum Conducted Output Power

Test Requirement:	47 CFR 15.247(b)(3)
Test Limit:	Refer to 47 CFR 15.247(b)(3), For systems using digital modulation in the 902-928 MHz, 2400-2483.5 MHz, and 5725-5850 MHz bands: 1 Watt. As an alternative to a peak power measurement, compliance with the one Watt limit can be based on a measurement of the maximum conducted output power. Maximum Conducted Output Power is defined as the total transmit power delivered to all antennas and antenna elements averaged across all symbols in the signaling alphabet when the transmitter is operating at its maximum power control level. Power must be summed across all antennas and antenna elements. The average must not include any time intervals during which the transmitter is off or is transmitting at a reduced power level. If multiple modes of operation are possible (e.g., alternative modulation methods), the maximum conducted output power is the highest total transmit power occurring in any mode.
Test Method:	ANSI C63.10-2013, section 11.9.1 KDB 558074 D01 15.247 Meas Guidance v05r02
Procedure:	ANSI C63.10-2013, section 11.9.1 Maximum peak conducted output power

4.3.1. E.U.T. Operation:

Operating Environment:	
Temperature:	25.3 °C
Humidity:	54.8 %
Atmospheric Pressure:	101 kPa
Final test mode:	Test Mode1

4.3.2. Test Setup Diagram:

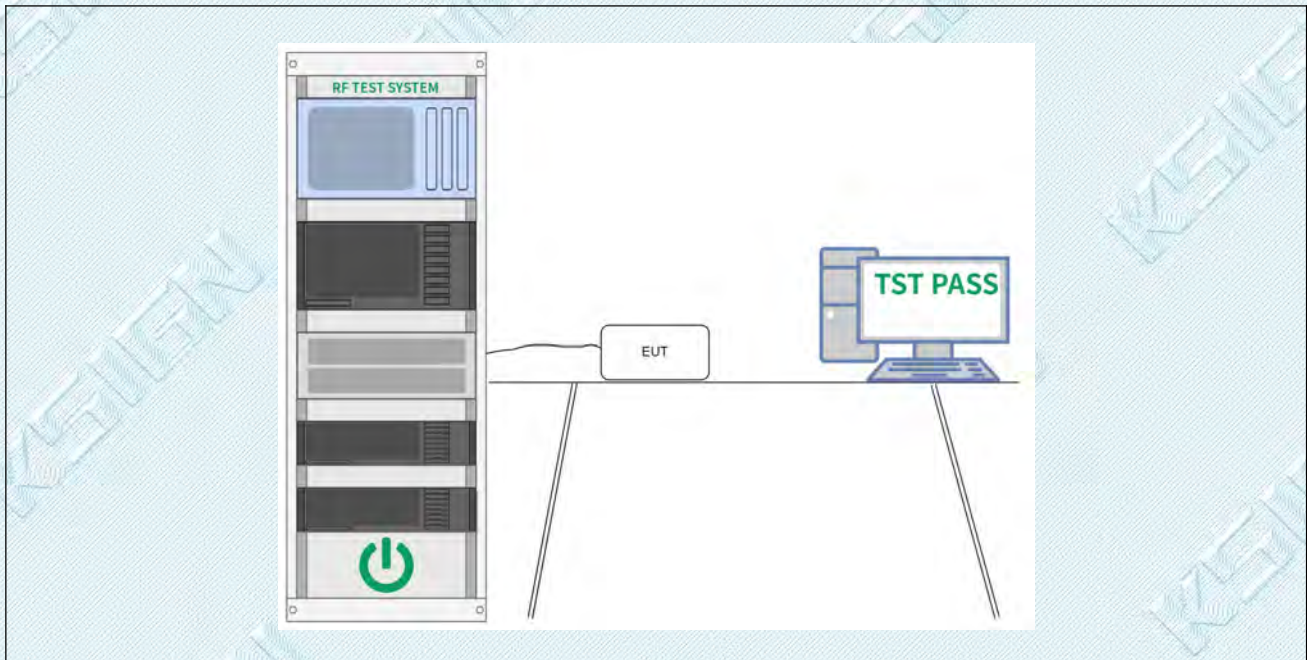

4.3.3. Test Data:

Please Refer to Appendix for Details.

4.4. Power Spectral Density

Test Requirement:	47 CFR 15.247(e)
Test Limit:	Refer to 47 CFR 15.247(e), For digitally modulated systems, the power spectral density conducted from the intentional radiator to the antenna shall not be greater than 8 dBm in any 3 kHz band during any time interval of continuous transmission. This power spectral density shall be determined in accordance with the provisions of paragraph (b) of this section. The same method of determining the conducted output power shall be used to determine the power spectral density.
Test Method:	ANSI C63.10-2013, section 11.10 KDB 558074 D01 15.247 Meas Guidance v05r02
Procedure:	ANSI C63.10-2013, section 11.10, Maximum power spectral density level in the fundamental emission

4.4.1. E.U.T. Operation:

Operating Environment:	
Temperature:	25.3 °C
Humidity:	54.8 %
Atmospheric Pressure:	101 kPa
Final test mode:	Test Mode 1

4.4.2. Test Setup Diagram:

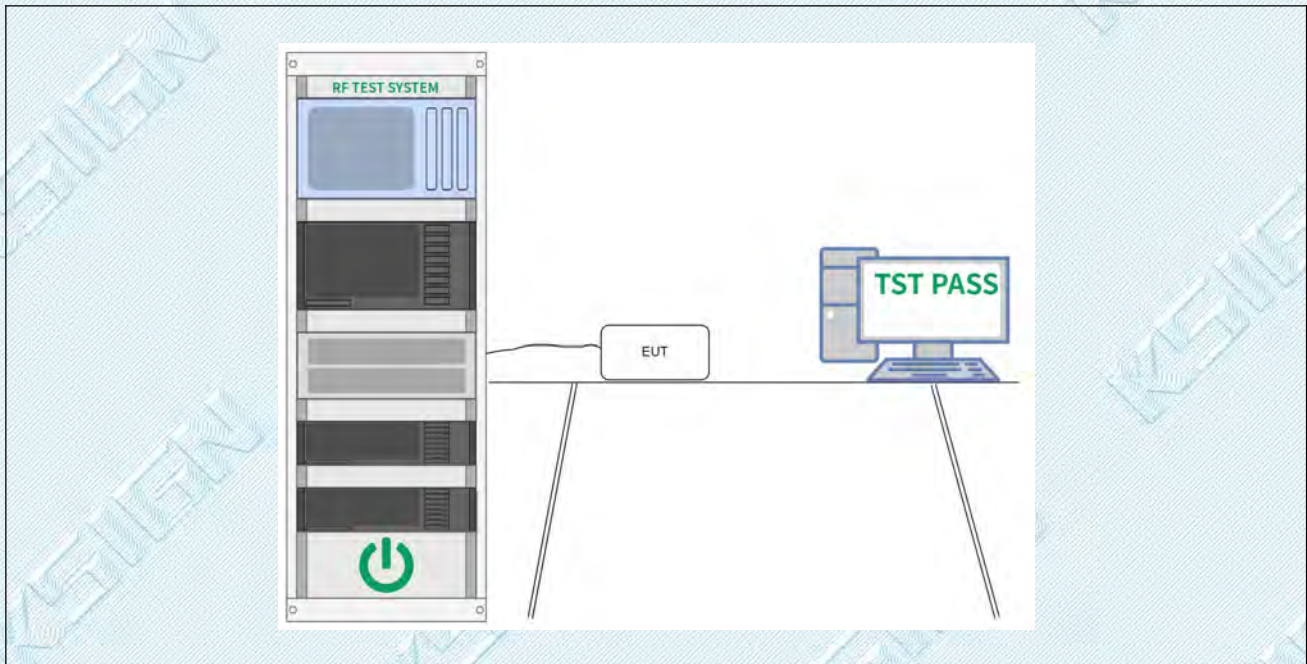

4.4.3. Test Data:

Please Refer to Appendix for Details.

4.5. Emissions in non-restricted frequency bands

Test Requirement:	47 CFR 15.247(d), 15.209, 15.205
Test Limit:	Refer to 47 CFR 15.247(d), In any 100 kHz bandwidth outside the frequency band in which the spread spectrum or digitally modulated intentional radiator is operating, the radio frequency power that is produced by the intentional radiator shall be at least 20 dB below that in the 100 kHz bandwidth within the band that contains the highest level of the desired power, based on either an RF conducted or a radiated measurement, provided the transmitter demonstrates compliance with the peak conducted power limits. If the transmitter complies with the conducted power limits based on the use of RMS averaging over a time interval, as permitted under paragraph (b)(3) of this section, the attenuation required under this paragraph shall be 30 dB instead of 20 dB. Attenuation below the general limits specified in § 15.209(a) is not required.
Test Method:	ANSI C63.10-2013 section 11.11 KDB 558074 D01 15.247 Meas Guidance v05r02
Procedure:	ANSI C63.10-2013 Section 11.11.1, Section 11.11.2, Section 11.11.3

4.5.1. E.U.T. Operation:

Operating Environment:	
Temperature:	25.3 °C
Humidity:	54.8 %
Atmospheric Pressure:	101 kPa
Final test mode:	Test Mode1

4.5.2. Test Setup Diagram:

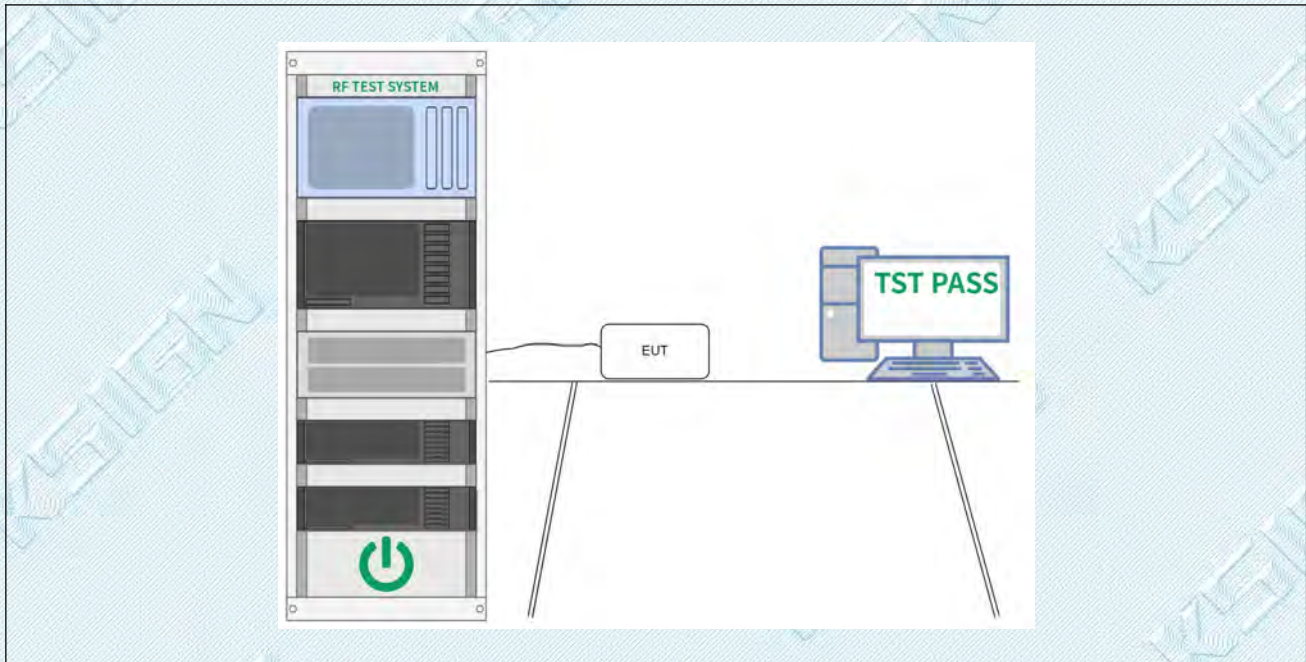

4.5.3. Test Data:

Please Refer to Appendix for Details.

4.6. Band edge emissions (Radiated)

Test Requirement:	Refer to 47 CFR 15.247(d), In addition, radiated emissions which fall in the restricted bands, as defined in § 15.205(a), must also comply with the radiated emission limits specified in § 15.209(a)(see § 15.205(c)).		
Test Limit:	Frequency (MHz)	Field strength (microvolts/meter)	Measurement distance (meters)
	0.009-0.490	2400/F(kHz)	300
	0.490-1.705	24000/F(kHz)	30
	1.705-30.0	30	30
	30-88	100 **	3
	88-216	150 **	3
	216-960	200 **	3
	Above 960	500	3
	<p>** Except as provided in paragraph (g), fundamental emissions from intentional radiators operating under this section shall not be located in the frequency bands 54-72 MHz, 76-88 MHz, 174-216 MHz or 470-806 MHz. However, operation within these frequency bands is permitted under other sections of this part, e.g., §§ 15.231 and 15.241.</p> <p>In the emission table above, the tighter limit applies at the band edges.</p> <p>The emission limits shown in the above table are based on measurements employing a CISPR quasi-peak detector except for the frequency bands 9-90 kHz, 110-490 kHz and above 1000 MHz. Radiated emission limits in these three bands are based on measurements employing an average detector.</p>		
Test Method:	ANSI C63.10-2013 section 6.10 KDB 558074 D01 15.247 Meas Guidance v05r02		
Procedure:	ANSI C63.10-2013 section 6.10.5.2		

4.6.1. E.U.T. Operation:

Operating Environment:	
Temperature:	25.3 °C
Humidity:	54.8 %
Atmospheric Pressure:	101 kPa
Final test mode:	Test Mode 1

4.6.2. Test Setup Diagram:

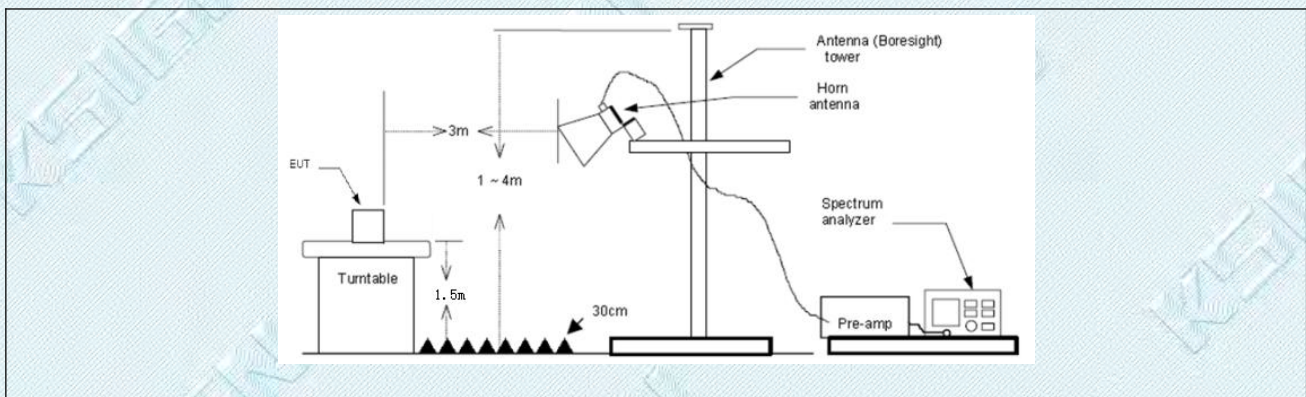

4.6.3. Test Data:

Test Mode1 / Polarization: Horizontal CH: L

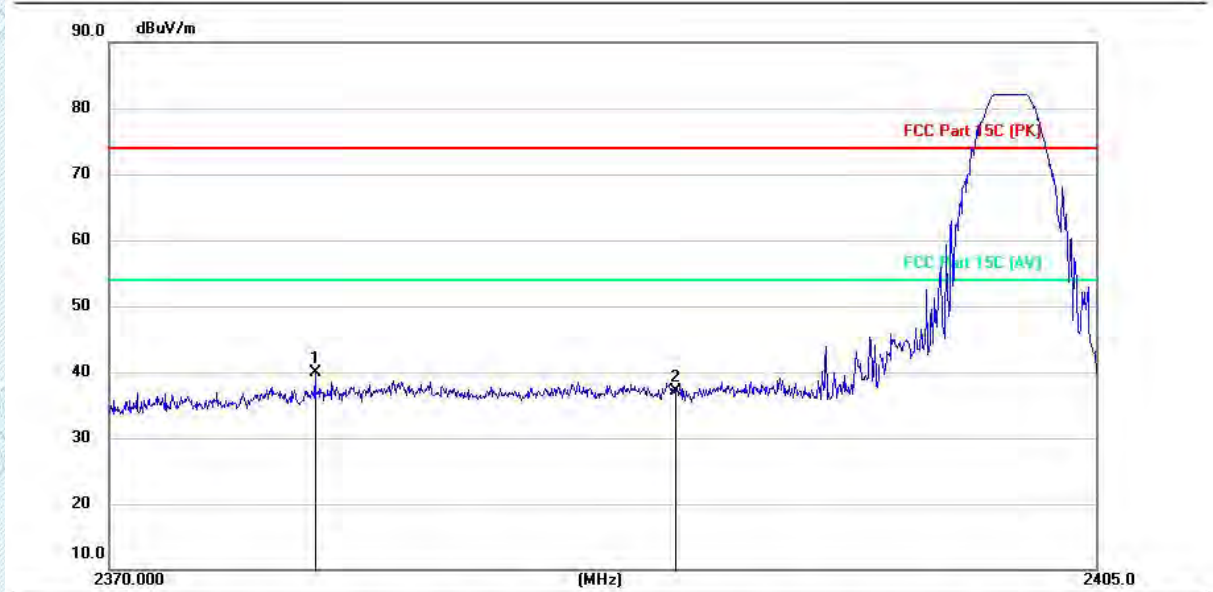

No.	Mk.	Freq. MHz	Reading Level (dBuV)	Correct Factor (dB/m)	Measurement (dBuV/m)	Limit (dBuV/m)	Over (dB)	Detector
1	*	2377.256	50.85	-10.93	39.92	74.00	-34.08	peak
2		2390.000	47.97	-10.92	37.05	74.00	-36.95	peak

TRF RF_R1

Add: West Side of 1/F., Building C, Zone A, Fuyuan New Factory, Jiujiu Industrial Park, Minzhu, Shatou, Shajing, Bao'an District, Shenzhen, Guangdong, China

Tel: +(86) 0755-2985 2678 Fax: +(86) 0755-2985 2397 E-mail: info@gdkesign.cn Web: www.gdkesign.com

Test Mode1 / Polarization: Vertical / CH: L

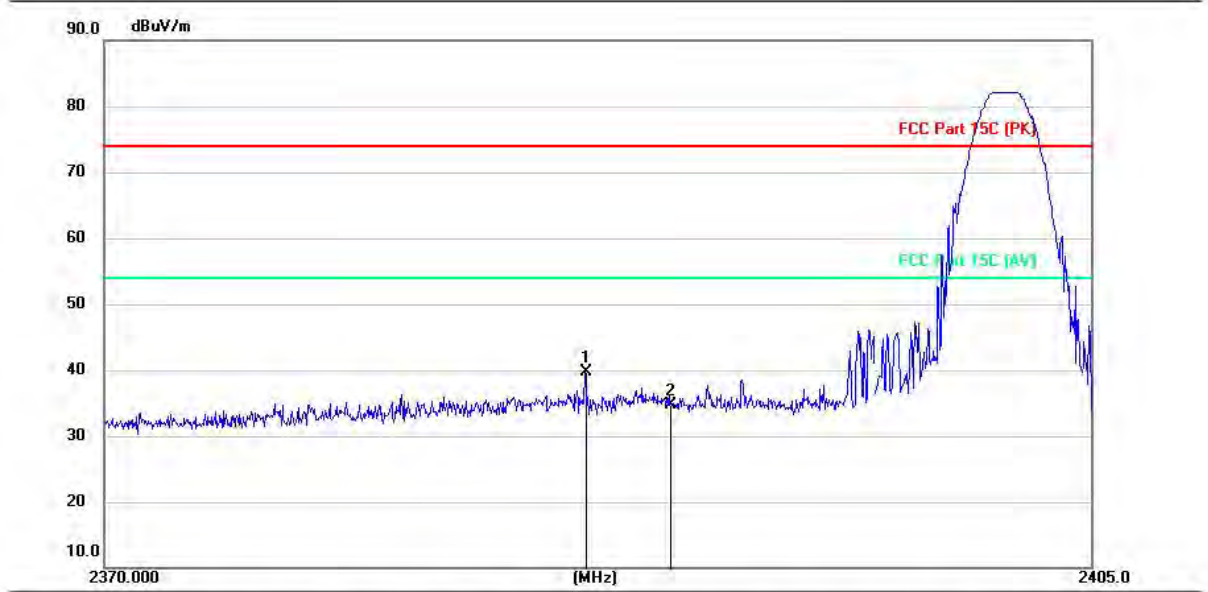

No.	Mk.	Freq. MHz	Reading Level (dBuV)	Correct Factor (dB/m)	Measurement (dBuV/m)	Limit (dBuV/m)	Over (dB)	Detector
1	*	2386.982	50.68	-10.92	39.76	74.00	-34.24	peak
2		2390.000	45.66	-10.92	34.74	74.00	-39.26	peak

TRF RF_R1

Add: West Side of 1/F., Building C, Zone A, Fuyuan New Factory, Jiujiu Industrial Park, Minzhu, Shatou, Shajing, Bao'an District, Shenzhen, Guangdong, China

Tel: +(86) 0755-2985 2678 Fax: +(86) 0755-2985 2397 E-mail: info@gdkesign.cn Web: www.gdkesign.com

Test Mode1 / Polarization: Horizontal / CH: H

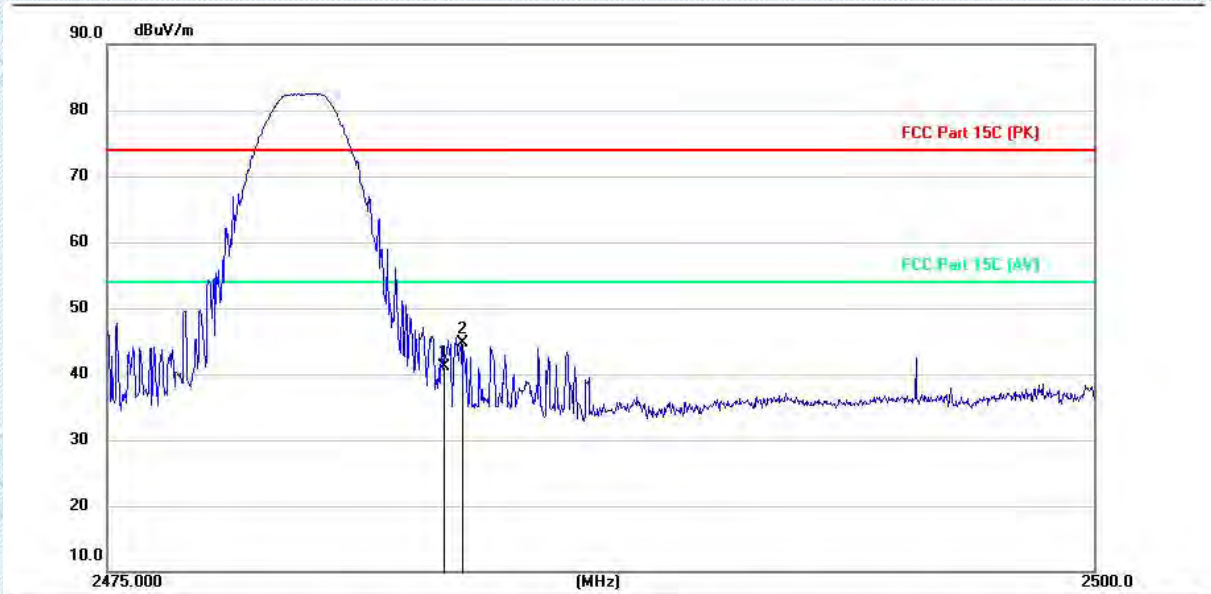

No.	Mk.	Freq. MHz	Reading Level (dBuV)	Correct Factor (dB/m)	Measurement (dBuV/m)	Limit (dBuV/m)	Over (dB)	Detector
1		2483.500	51.95	-10.88	41.07	74.00	-32.93	peak
2	*	2483.948	55.49	-10.88	44.61	74.00	-29.39	peak

TRF RF_R1

Add: West Side of 1/F., Building C, Zone A, Fuyuan New Factory, Jiujiu Industrial Park, Minzhu, Shatou, Shajing, Bao'an District, Shenzhen, Guangdong, China

Tel: +(86) 0755-2985 2678 Fax: +(86) 0755-2985 2397 E-mail: info@gdkesign.cn Web: www.gdkesign.com

Test Mode1 / Polarization: Vertical / CH: H

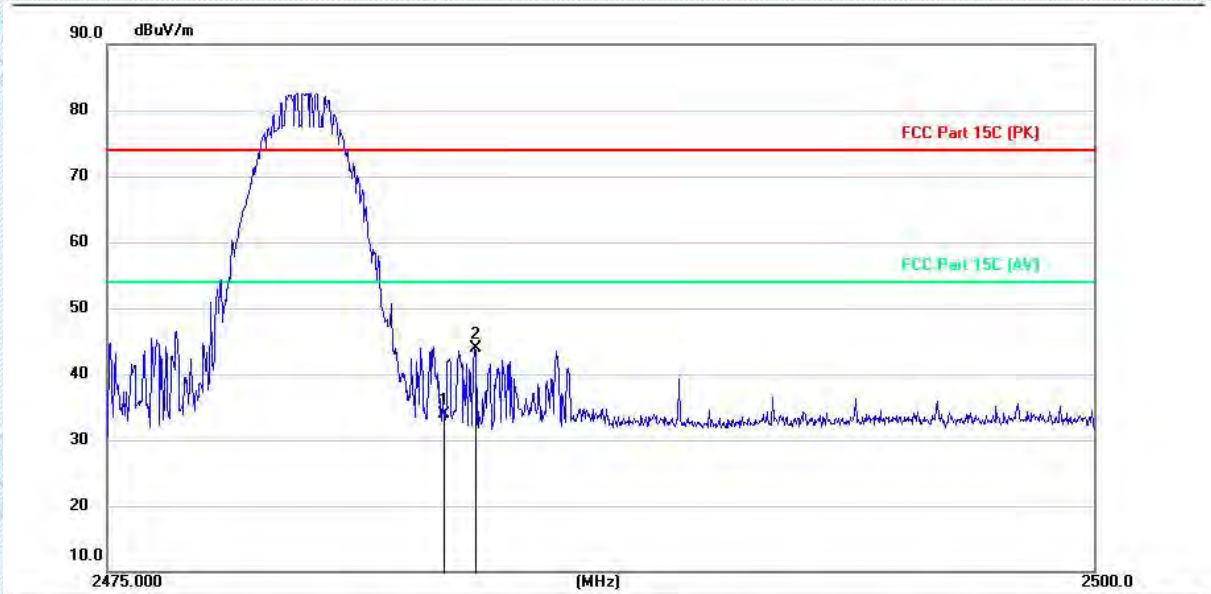

No.	Mk.	Freq. MHz	Reading Level (dBuV)	Correct Factor (dB/m)	Measurement (dBuV/m)	Limit (dBuV/m)	Over (dB)	Detector
1		2483.500	44.88	-10.88	34.00	74.00	-40.00	peak
2	*	2484.307	54.88	-10.88	44.00	74.00	-30.00	peak

Note:

1.Measurement = Reading level + Correct Factor

Correct Factor=Antenna Factor + Cable Loss - Preamplifier Factor

2.Pre-scan BLE 1M and BLE 2M mode, and found the BLE 1M mode which it is worse case, so only show the test data for worse case.

3. Since the peak value is less than the limit of the AVG value, there is no AVG data.

4.7. Emissions in frequency bands (below 1GHz)

Test Requirement:	Refer to 47 CFR 15.247(d), In addition, radiated emissions which fall in the restricted bands, as defined in § 15.205(a), must also comply with the radiated emission limits specified in § 15.209(a)(see § 15.205(c)).		
Test Limit:	Frequency (MHz)	Field strength (microvolts/meter)	Measurement distance (meters)
	0.009-0.490	2400/F(kHz)	300
	0.490-1.705	24000/F(kHz)	30
	1.705-30.0	30	30
	30-88	100 **	3
	88-216	150 **	3
	216-960	200 **	3
	Above 960	500	3
	<p>** Except as provided in paragraph (g), fundamental emissions from intentional radiators operating under this section shall not be located in the frequency bands 54-72 MHz, 76-88 MHz, 174-216 MHz or 470-806 MHz. However, operation within these frequency bands is permitted under other sections of this part, e.g., §§ 15.231 and 15.241.</p> <p>In the emission table above, the tighter limit applies at the band edges.</p> <p>The emission limits shown in the above table are based on measurements employing a CISPR quasi-peak detector except for the frequency bands 9–90 kHz, 110–490 kHz and above 1000 MHz. Radiated emission limits in these three bands are based on measurements employing an average detector.</p>		
Test Method:	ANSI C63.10-2013 section 6.6.4 KDB 558074 D01 15.247 Meas Guidance v05r02		
Procedure:	ANSI C63.10-2013 section 6.6.4		

4.7.1. E.U.T. Operation:

Operating Environment:	
Temperature:	25.3 °C
Humidity:	54.8 %
Atmospheric Pressure:	101 kPa
Final test mode:	Test Mode 1

4.7.2. Test Setup Diagram:

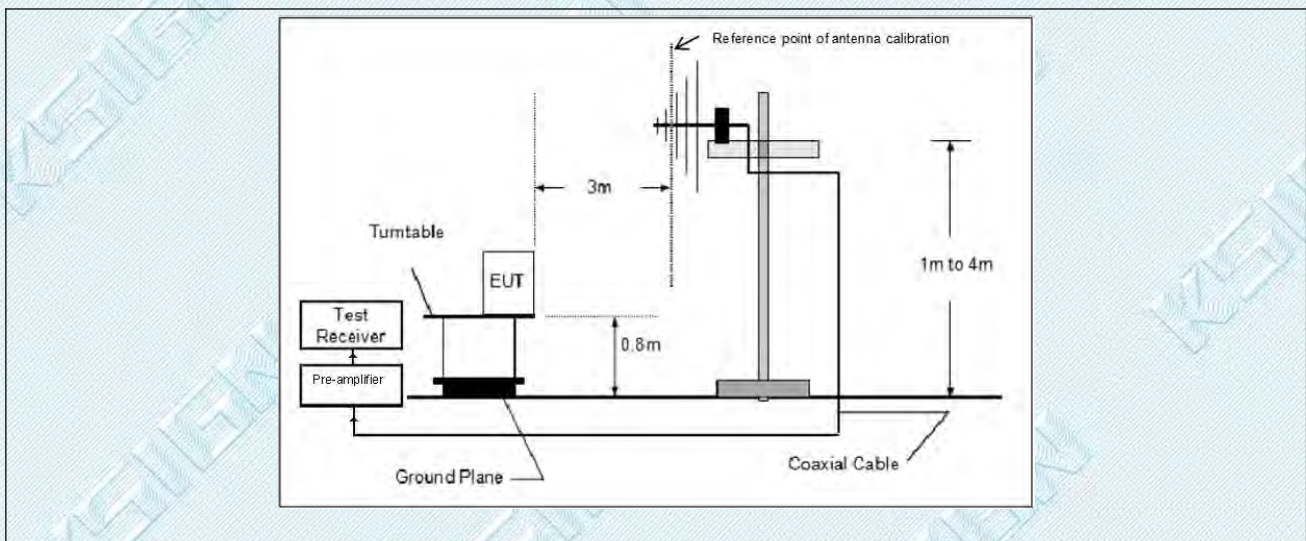

4.7.3. Test Data:

Test Mode1 / Polarization: Horizontal



No.	Mk.	Freq. MHz	Reading Level (dBuV)	Correct Factor (dB/m)	Measurement (dBuV/m)	Limit (dBuV/m)	Over (dB)	Detector
1		56.5929	45.17	-16.26	28.91	40.00	-11.09	QP
2		90.4103	50.29	-20.18	30.11	43.50	-13.39	QP
3		129.4677	49.75	-20.33	29.42	43.50	-14.08	QP
4		171.2724	51.26	-20.04	31.22	43.50	-12.28	QP
5		594.0901	42.92	-7.64	35.28	46.00	-10.72	QP
6	*	650.1154	45.73	-7.13	38.60	46.00	-7.40	QP

Test Mode1 / Polarization: Vertical



No.	Mk.	Freq. MHz	Reading Level (dBuV)	Correct Factor (dB/m)	Measurement (dBuV/m)	Limit (dBuV/m)	Over (dB)	Detector
1		35.7238	46.98	-17.66	29.32	40.00	-10.68	QP
2		216.0235	49.66	-18.67	30.99	46.00	-15.01	QP
3		250.0380	51.51	-17.33	34.18	46.00	-11.82	QP
4	*	349.9854	48.40	-12.56	35.84	46.00	-10.16	QP
5		456.0656	44.73	-9.88	34.85	46.00	-11.15	QP
6		990.2296	37.69	-3.80	33.89	54.00	-20.11	QP

9 KHz - 30 MHz:

The amplitude of spurious emissions which are attenuated by more than 20dB below the permissible value has no need to be reported.

Note:

1.Pre-scan BLE1M and BLE 2M modulation, and found the BLE 1M modulation which it is 2402MHz channel which it is worse case for below 1GHz, so only show the test data for worse case.

2. Measurement = Reading level + Correct Factor

3. Correct Factor=Antenna Factor + Cable Loss - Preamplifier Factor

TRF RF_R1

Add: West Side of 1/F., Building C, Zone A, Fuyuan New Factory, Jiujiu Industrial Park, Minzhu, Shatou, Shajing, Bao'an District, Shenzhen, Guangdong, China

Tel: +(86) 0755-2985 2678 Fax: +(86) 0755-2985 2397 E-mail: info@gdkesign.cn Web: www.gdkesign.com

4.8. Emissions in frequency bands (above 1GHz)

Test Requirement:	In addition, radiated emissions which fall in the restricted bands, as defined in § 15.205(a), must also comply with the radiated emission limits specified in § 15.209(a)(see § 15.205(c)).		
Test Limit:	Frequency (MHz)	Field strength (microvolts/meter)	Measurement distance (meters)
	0.009-0.490	2400/F(kHz)	300
	0.490-1.705	24000/F(kHz)	30
	1.705-30.0	30	30
	30-88	100 **	3
	88-216	150 **	3
	216-960	200 **	3
	Above 960	500	3
	<p>** Except as provided in paragraph (g), fundamental emissions from intentional radiators operating under this section shall not be located in the frequency bands 54-72 MHz, 76-88 MHz, 174-216 MHz or 470-806 MHz. However, operation within these frequency bands is permitted under other sections of this part, e.g., §§ 15.231 and 15.241.</p> <p>In the emission table above, the tighter limit applies at the band edges.</p> <p>The emission limits shown in the above table are based on measurements employing a CISPR quasi-peak detector except for the frequency bands 9-90 kHz, 110-490 kHz and above 1000 MHz. Radiated emission limits in these three bands are based on measurements employing an average detector.</p>		
Test Method:	ANSI C63.10-2013 section 6.6.4 KDB 558074 D01 15.247 Meas Guidance v05r02		
Procedure:	ANSI C63.10-2013 section 6.6.4		

4.8.1. E.U.T. Operation:

Operating Environment:	
Temperature:	25.3 °C
Humidity:	54.8 %
Atmospheric Pressure:	101 kPa
Final test mode:	Test Mode 1

4.8.2. Test Setup Diagram:

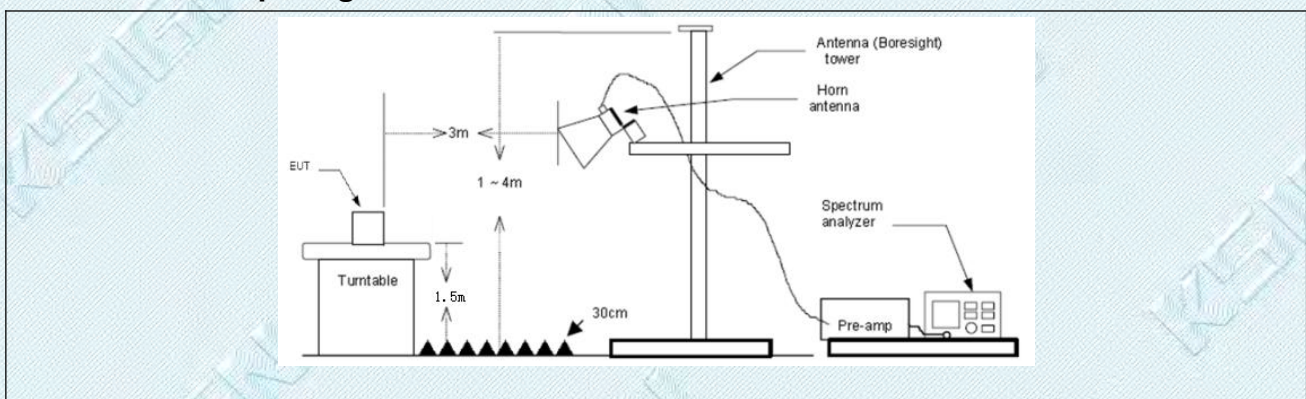

4.8.3. Test Data:

Test Mode1 / Polarization: Horizontal / CH: L

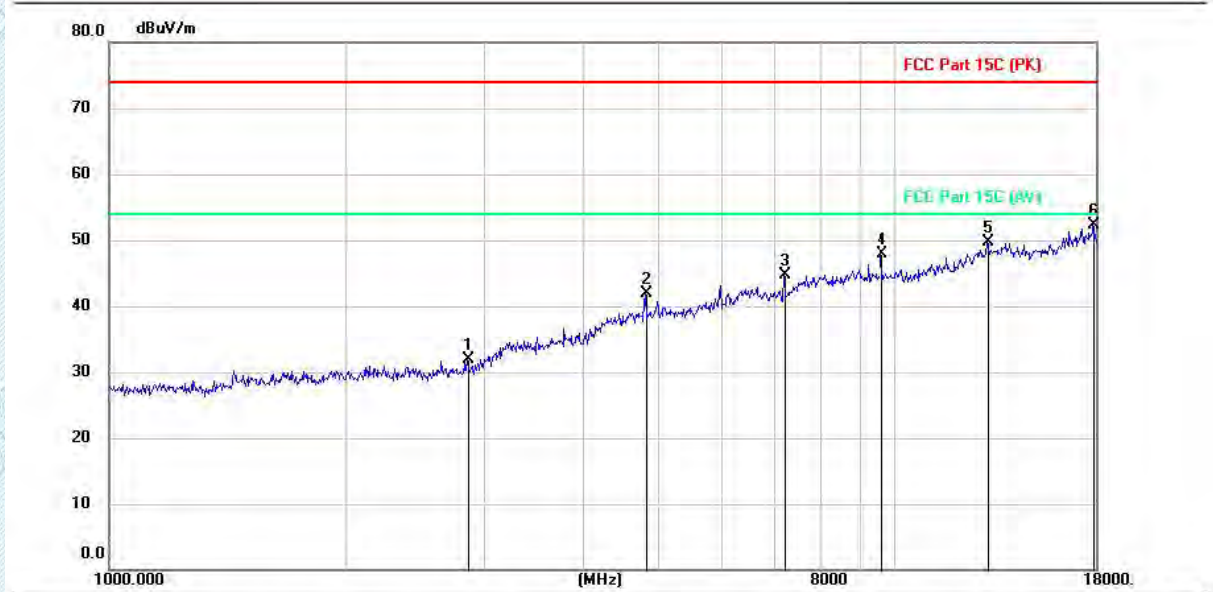

No.	Mk.	Freq. MHz	Reading Level (dBuV)	Correct Factor (dB/m)	Measurement (dBuV/m)	Limit (dBuV/m)	Over (dB)	Detector
1		2859.800	42.53	-10.67	31.86	74.00	-42.14	peak
2		4804.600	47.77	-5.92	41.85	74.00	-32.15	peak
3		7206.700	44.69	-0.07	44.62	74.00	-29.38	peak
4		9607.100	44.67	3.20	47.87	74.00	-26.13	peak
5		13112.500	39.72	10.08	49.80	74.00	-24.20	peak
6	*	17845.300	38.74	13.55	52.29	74.00	-21.71	peak

TRF RF_R1

Add: West Side of 1/F., Building C, Zone A, Fuyuan New Factory, Jiujiu Industrial Park, Minzhu, Shatou, Shajing, Bao'an District, Shenzhen, Guangdong, China

Tel: +(86) 0755-2985 2678 Fax: +(86) 0755-2985 2397 E-mail: info@gdkesign.cn Web: www.gdkesign.com

Test Mode1 / Polarization: Vertical / CH: L

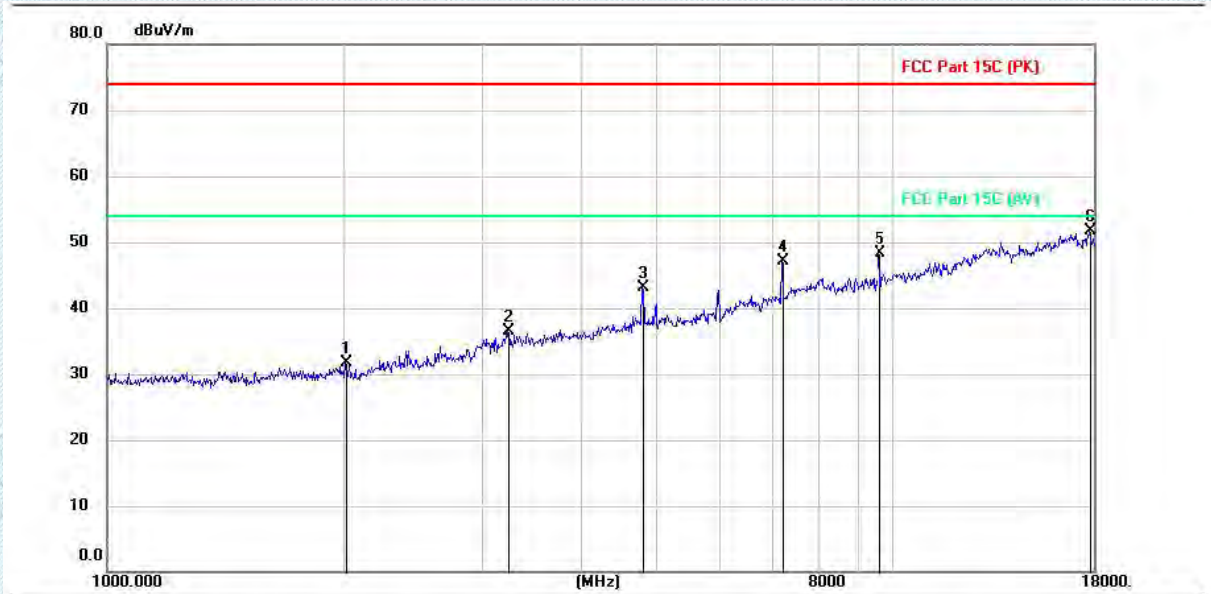

No.	Mk.	Freq. MHz	Reading Level (dBuV)	Correct Factor (dB/m)	Measurement (dBuV/m)	Limit (dBuV/m)	Over (dB)	Detector
1		2016.600	42.67	-11.06	31.61	74.00	-42.39	peak
2		3235.500	46.70	-10.16	36.54	74.00	-37.46	peak
3		4802.900	48.96	-5.92	43.04	74.00	-30.96	peak
4		7206.700	47.24	-0.07	47.17	74.00	-26.83	peak
5		9607.100	45.08	3.20	48.28	74.00	-25.72	peak
6	*	17758.600	38.20	13.51	51.71	74.00	-22.29	peak

TRF RF_R1

Add: West Side of 1/F., Building C, Zone A, Fuyuan New Factory, Jiujiu Industrial Park, Minzhu, Shatou, Shajing, Bao'an District, Shenzhen, Guangdong, China

Tel: +(86) 0755-2985 2678 Fax: +(86) 0755-2985 2397 E-mail: info@gdkesign.cn Web: www.gdkesign.com

Test Mode1 / Polarization: Horizontal / CH: M

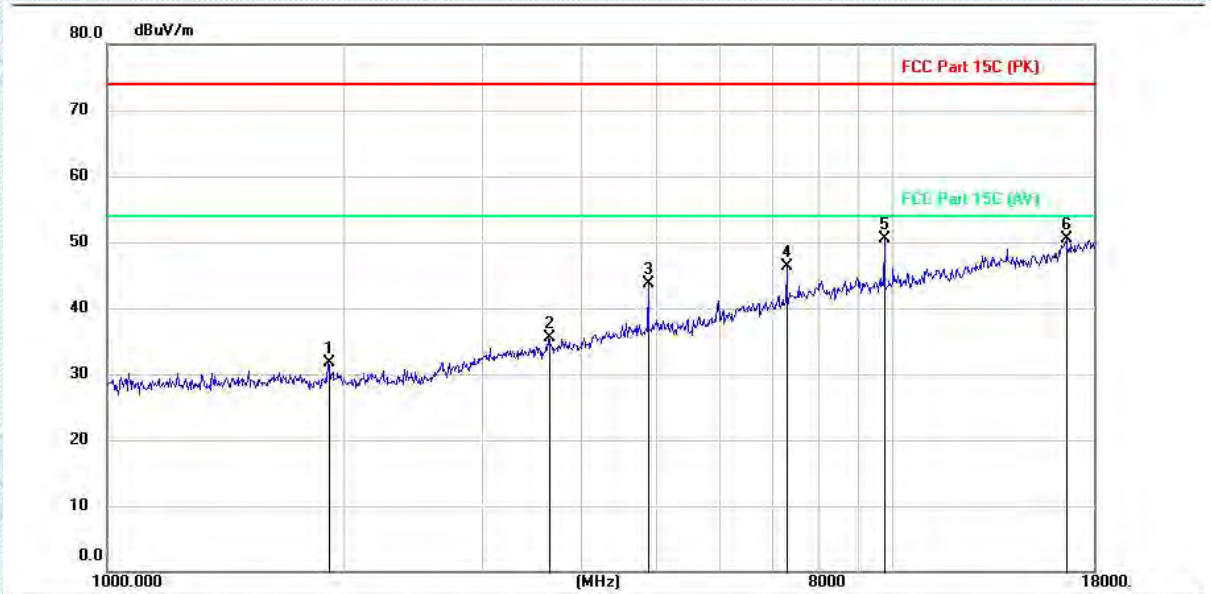

No.	Mk.	Freq. MHz	Reading Level (dBuV)	Correct Factor (dB/m)	Measurement (dBuV/m)	Limit (dBuV/m)	Over (dB)	Detector
1		1909.500	42.81	-11.14	31.67	74.00	-42.33	peak
2		3645.200	44.90	-9.32	35.58	74.00	-38.42	peak
3		4881.100	49.36	-5.71	43.65	74.00	-30.35	peak
4		7320.600	46.05	0.27	46.32	74.00	-27.68	peak
5	*	9760.100	47.03	3.54	50.57	74.00	-23.43	peak
6		16607.700	36.92	13.64	50.56	74.00	-23.44	peak

TRF RF_R1

Add: West Side of 1/F., Building C, Zone A, Fuyuan New Factory, Jiujiu Industrial Park, Minzhu, Shatou, Shajing, Bao'an District, Shenzhen, Guangdong, China

Tel: +(86) 0755-2985 2678 Fax: +(86) 0755-2985 2397 E-mail: info@gdkesign.cn Web: www.gdkesign.com

Test Mode1 / Polarization: Vertical / CH: M

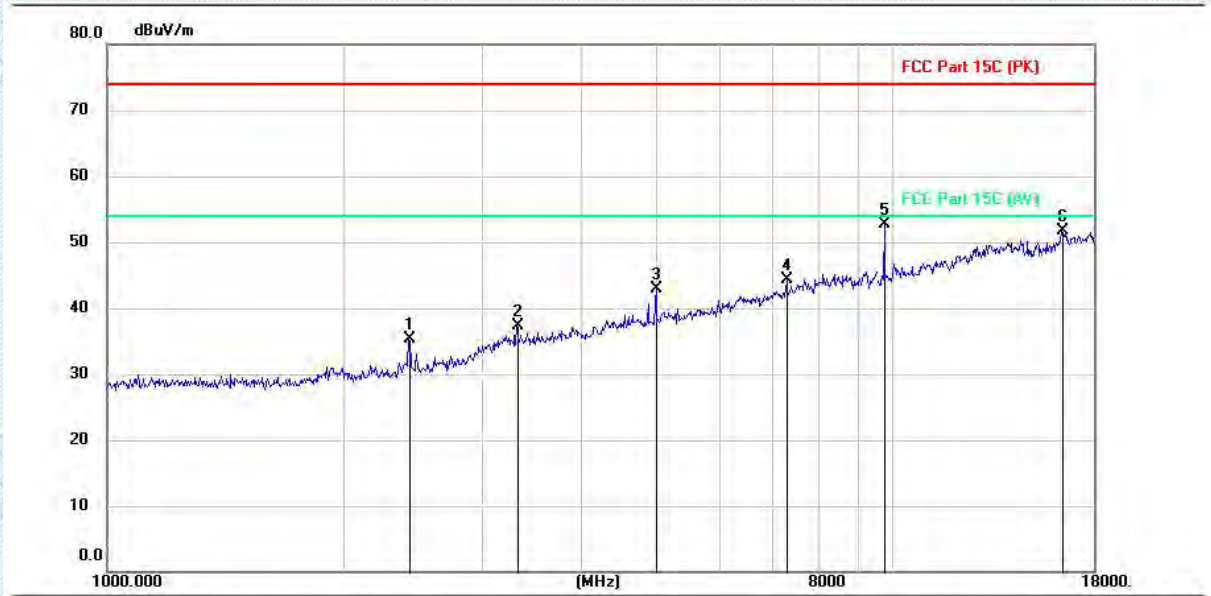

No.	Mk.	Freq. MHz	Reading Level (dBuV)	Correct Factor (dB/m)	Measurement (dBuV/m)	Limit (dBuV/m)	Over (dB)	Detector
1		2426.300	46.13	-10.90	35.23	74.00	-38.77	peak
2		3322.200	47.34	-10.01	37.33	74.00	-36.67	peak
3		4989.900	48.33	-5.42	42.91	74.00	-31.09	peak
4		7318.900	44.02	0.27	44.29	74.00	-29.71	peak
5	*	9760.100	49.21	3.54	52.75	74.00	-21.25	peak
6		16362.900	38.17	13.48	51.65	74.00	-22.35	peak

TRF RF_R1

Add: West Side of 1/F., Building C, Zone A, Fuyuan New Factory, Jiujiu Industrial Park, Minzhu, Shatou, Shajing, Bao'an District, Shenzhen, Guangdong, China

Tel: +(86) 0755-2985 2678 Fax: +(86) 0755-2985 2397 E-mail: info@gdkesign.cn Web: www.gdkesign.com

Test Mode1 / Polarization: Horizontal / CH: H

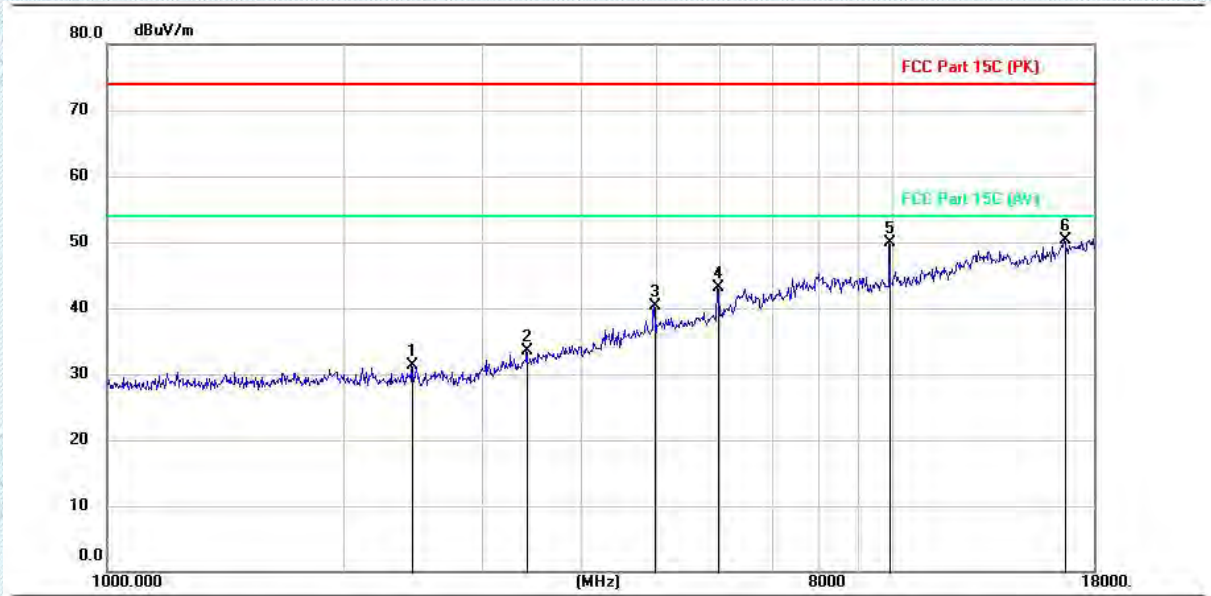

No.	Mk.	Freq. MHz	Reading Level (dBuV)	Correct Factor (dB/m)	Measurement (dBuV/m)	Limit (dBuV/m)	Over (dB)	Detector
1		2445.000	42.29	-10.90	31.39	74.00	-42.61	peak
2		3417.400	43.35	-9.83	33.52	74.00	-40.48	peak
3		4961.000	45.71	-5.50	40.21	74.00	-33.79	peak
4		5982.700	46.95	-3.84	43.11	74.00	-30.89	peak
5		9919.900	46.07	3.89	49.96	74.00	-24.04	peak
6	*	16507.400	36.43	13.80	50.23	74.00	-23.77	peak

TRF RF_R1

Add: West Side of 1/F., Building C, Zone A, Fuyuan New Factory, Jiujiu Industrial Park, Minzhu, Shatou, Shajing, Bao'an District, Shenzhen, Guangdong, China

Tel: +(86) 0755-2985 2678 Fax: +(86) 0755-2985 2397 E-mail: info@gdkesign.cn Web: www.gdkesign.com

Test Mode1 / Polarization: Vertical / CH: H

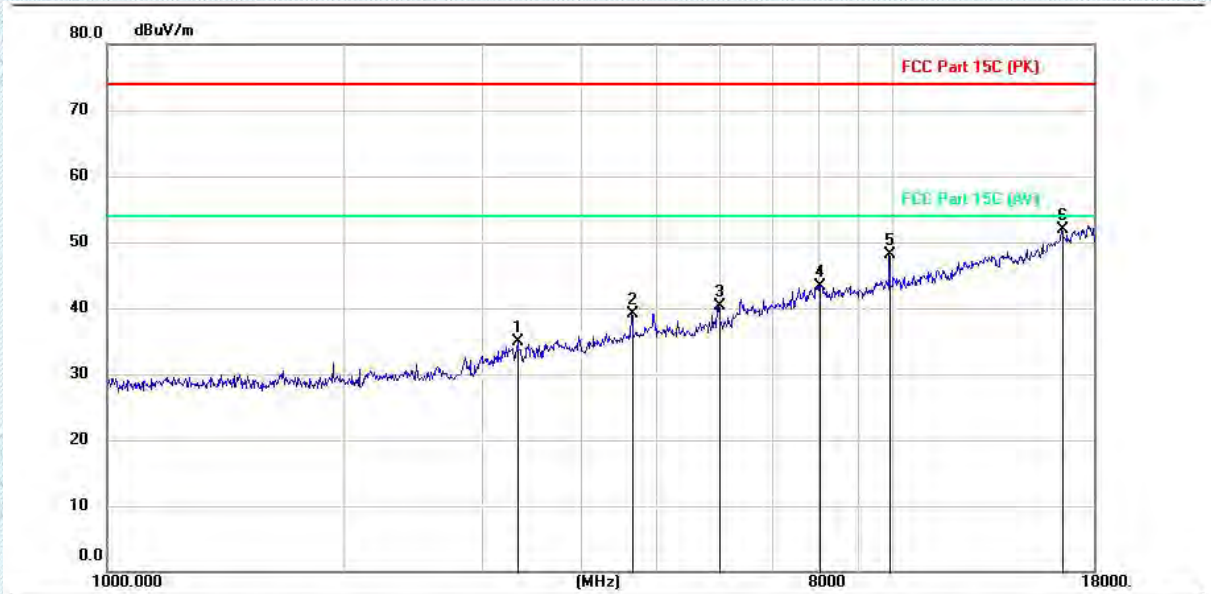

No.	Mk.	Freq. MHz	Reading Level (dBuV)	Correct Factor (dB/m)	Measurement (dBuV/m)	Limit (dBuV/m)	Over (dB)	Detector
1		3329.000	44.96	-9.99	34.97	74.00	-39.03	peak
2		4649.900	45.53	-6.34	39.19	74.00	-34.81	peak
3		5992.900	44.13	-3.81	40.32	74.00	-33.68	peak
4		8038.000	41.28	2.06	43.34	74.00	-30.66	peak
5		9919.900	44.12	3.89	48.01	74.00	-25.99	peak
6	*	16371.400	38.36	13.50	51.86	74.00	-22.14	peak

Note:

1. Measurement = Reading level + Correct Factor
2. Correct Factor = Antenna Factor + Cable Loss - Preamplifier Factor
3. Pre-scan BLE 1M and BLE 2M mode, and found the BLE 1M mode which it is worse case, so only show the test data for worse case.
4. From 18GHz to 26.5GHz, the amplitude of spurious emissions which are attenuated by more than 20dB below the permissible value has no need to be reported.
5. Since the peak value is less than the limit of the AVG value, there is no AVG data.

TRF RF_R1

Add: West Side of 1/F., Building C, Zone A, Fuyuan New Factory, Jiujiu Industrial Park, Minzhu, Shatou, Shajing, Bao'an District, Shenzhen, Guangdong, China

Tel: +(86) 0755-2985 2678 Fax: +(86) 0755-2985 2397 E-mail: info@gdkesign.cn Web: www.gdkesign.com

5. EUT TEST PHOTOS

Conducted Emission at AC power line



Emissions in frequency bands (below 1GHz)



Emissions in frequency bands (above 1GHz)



RF Conducted



TRF RF_R1

Add: West Side of 1/F., Building C, Zone A, Fuyuan New Factory, Jiujiu Industrial Park, Minzhu, Shatou, Shajing, Bao'an District, Shenzhen, Guangdong, China

Tel: +(86) 0755-2985 2678 Fax: +(86) 0755-2985 2397 E-mail: info@gdkesign.cn Web: www.gdkesign.com

6. PHOTOGRAPHS OF EUT CONSTRUCTIONAL

Refer to Appendix - EUT Photos for KD2401S0542E.

Appendix

TRF RF_R1

Add: West Side of 1/F., Building C, Zone A, Fuyuan New Factory, Jiujiu Industrial Park, Minzhu, Shatou, Shajing, Bao'an District, Shenzhen, Guangdong, China

Tel: +(86) 0755-2985 2678 Fax: +(86) 0755-2985 2397 E-mail: info@gdkesign.cn Web: www.gdkesign.com

6.1. Appendix A: DTS Bandwidth

6.1.1. Test Result

TestMode	Antenna	Freq[MHz]	DTS BW [MHz]	FL[MHz]	FH[MHz]	Limit[MHz]	Verdict
BLE_1M	Ant1	2402	0.74	2401.62	2402.36	0.5	PASS
		2440	0.73	2439.62	2440.35	0.5	PASS
		2480	0.74	2479.62	2480.36	0.5	PASS
BLE_2M	Ant1	2402	1.23	2401.35	2402.58	0.5	PASS
		2440	1.23	2439.35	2440.58	0.5	PASS
		2480	1.22	2479.35	2480.58	0.5	PASS

6.1.2. Test Graphs



TRF RF_R1

Add: West Side of 1/F., Building C, Zone A, Fuyuan New Factory, Jiujiu Industrial Park, Minzhu, Shatou, Shajing, Bao'an District, Shenzhen, Guangdong, China

Tel: +(86) 0755-2985 2678 Fax: +(86) 0755-2985 2397 E-mail: info@gdkesign.cn Web: www.gdkesign.com

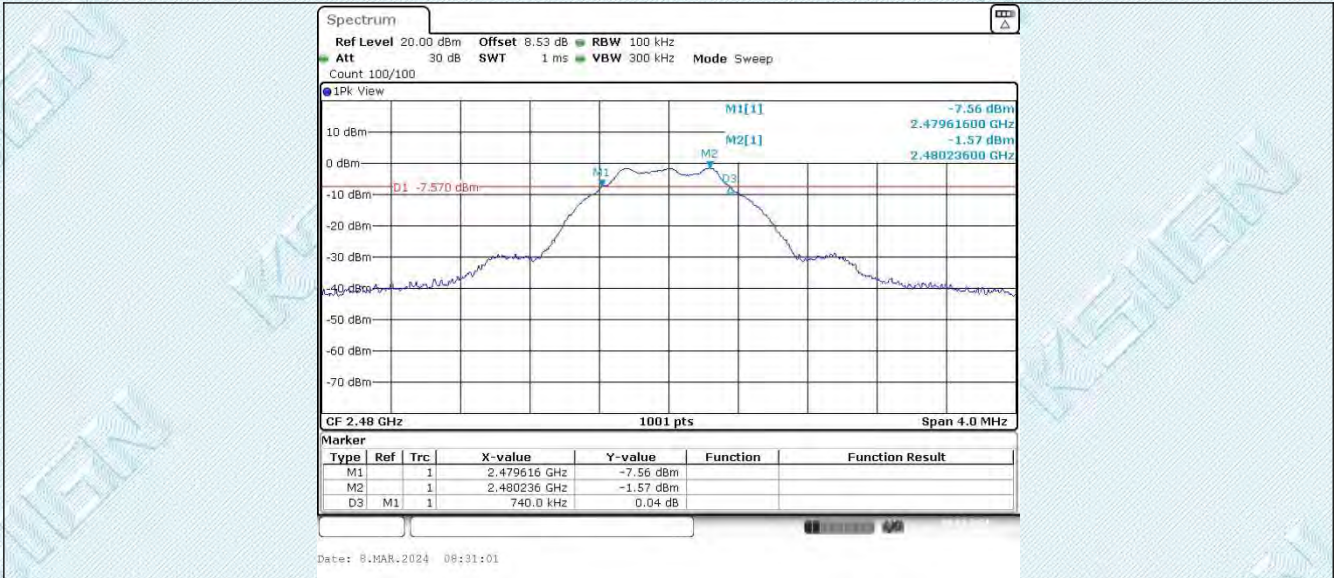

BLE_2M_Ant1_2402

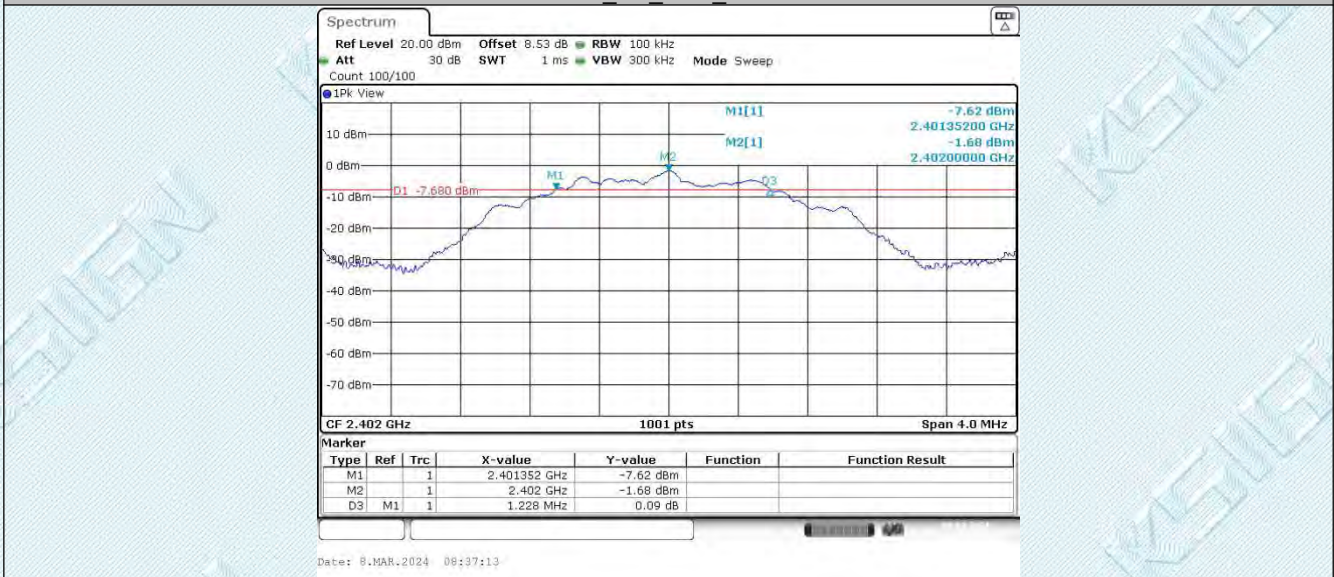

BLE_2M_Ant1_2440

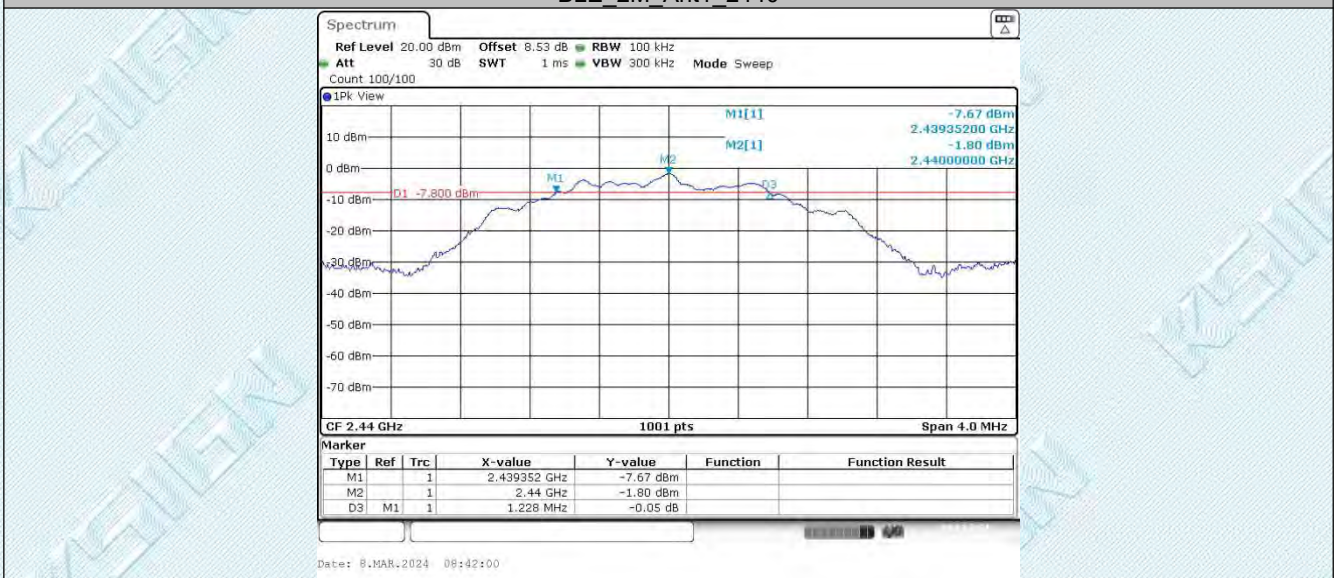

BLE_2M_Ant1_2480

TRF_RF_R1

Add: West Side of 1/F., Building C, Zone A, Fuyuan New Factory, Jiujiu Industrial Park, Minzhu, Shatou, Shajing, Bao'an District, Shenzhen, Guangdong, China

Tel: +(86) 0755-2985 2678 Fax: +(86) 0755-2985 2397 E-mail: info@gdkesign.cn Web: www.gdkesign.com

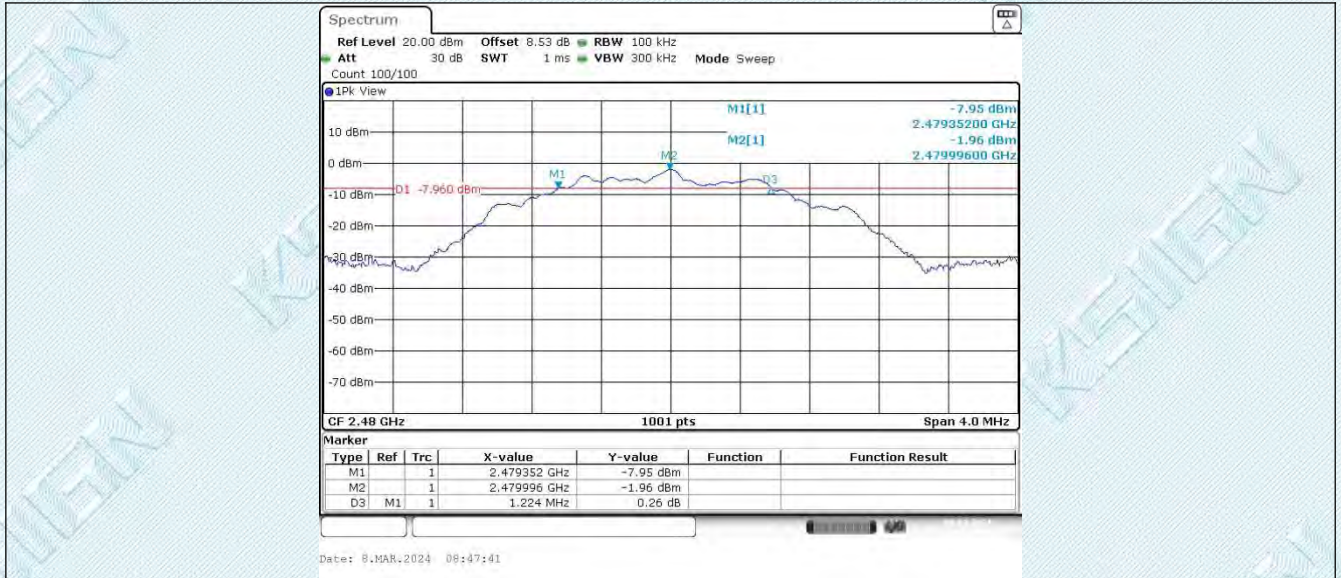

TRF RF_R1

Add: West Side of 1/F., Building C, Zone A, Fuyuan New Factory, Jiujiu Industrial Park, Minzhu, Shatou, Shajing, Bao'an District, Shenzhen, Guangdong, China

Tel: +(86) 0755-2985 2678 Fax: +(86) 0755-2985 2397 E-mail: info@gdksign.cn Web: www.gdksign.com

6.2. Appendix B: Occupied Channel Bandwidth

6.2.1. Test Result

TestMode	Antenna	Freq[MHz]	OCB [MHz]	FL[MHz]	FH[MHz]	Limit[MHz]	Verdict
BLE_1M	Ant1	2402	1.063	2401.469	2402.531	---	PASS
		2440	1.067	2439.465	2440.531	---	PASS
		2480	1.067	2479.465	2480.531	---	PASS
BLE_2M	Ant1	2402	2.142	2400.937	2403.079	---	PASS
		2440	2.126	2438.949	2441.075	---	PASS
		2480	2.13	2478.945	2481.075	---	PASS

6.2.2. Test Graphs

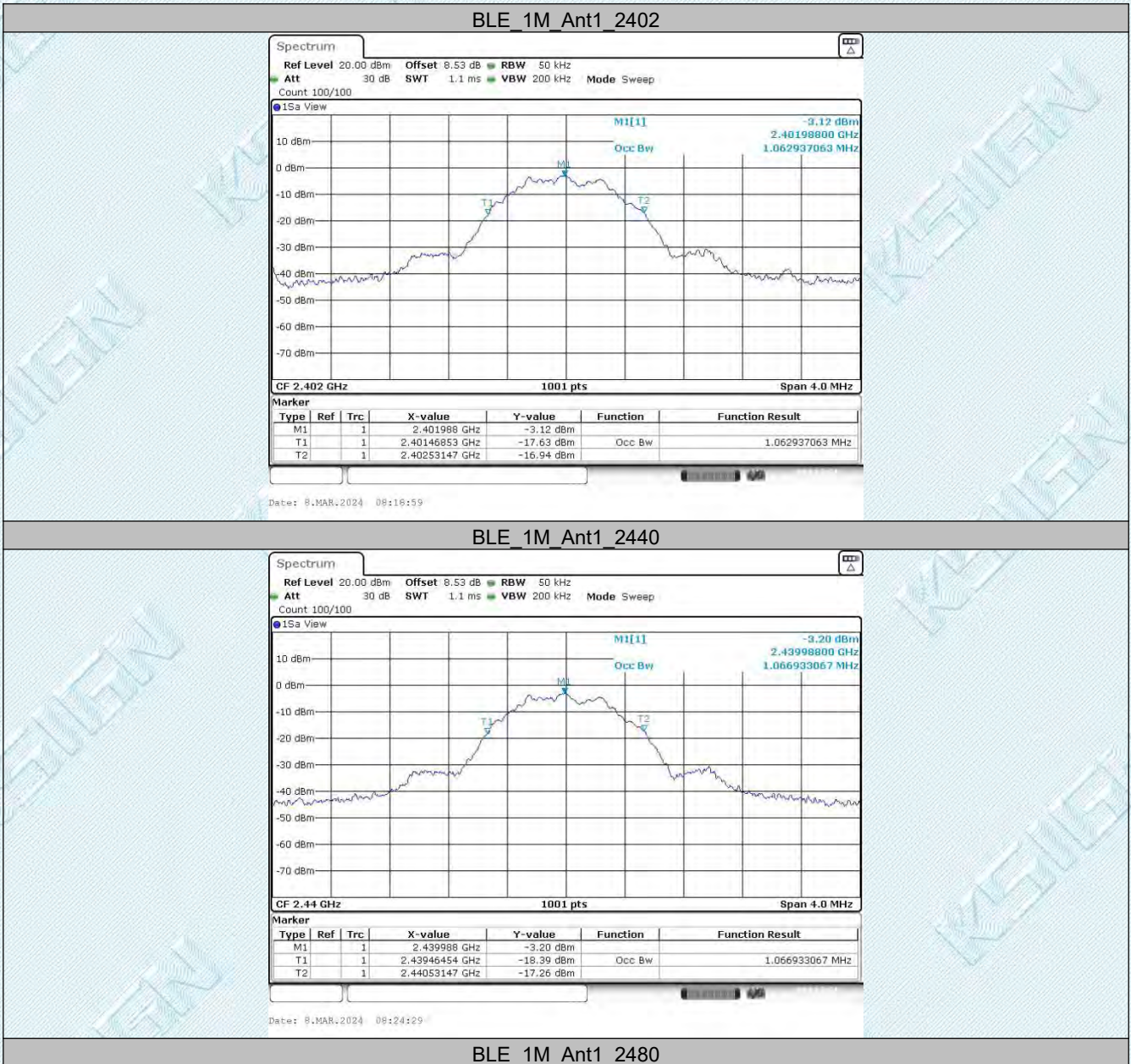

TRF RF_R1

Add: West Side of 1/F., Building C, Zone A, Fuyuan New Factory, Jiujiu Industrial Park, Minzhu, Shatou, Shajing, Bao'an District, Shenzhen, Guangdong, China

Tel: +(86) 0755-2985 2678 Fax: +(86) 0755-2985 2397 E-mail: info@gdkesign.cn Web: www.gdkesign.com



BLE_2M_Ant1_2402



BLE_2M_Ant1_2440

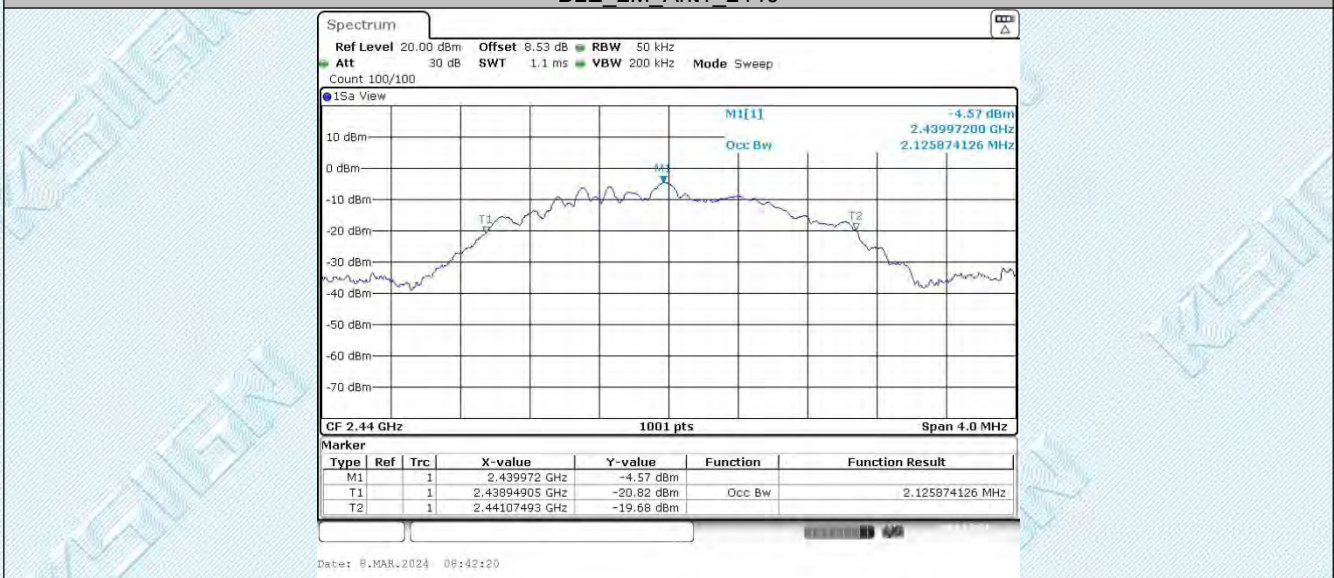

BLE_2M_Ant1_2480

TRF RF_R1

Add: West Side of 1/F., Building C, Zone A, Fuyuan New Factory, Jiujiu Industrial Park, Minzhu, Shatou, Shajing, Bao'an District, Shenzhen, Guangdong, China

Tel: +(86) 0755-2985 2678 Fax: +(86) 0755-2985 2397 E-mail: info@gdkesign.cn Web: www.gdkesign.com

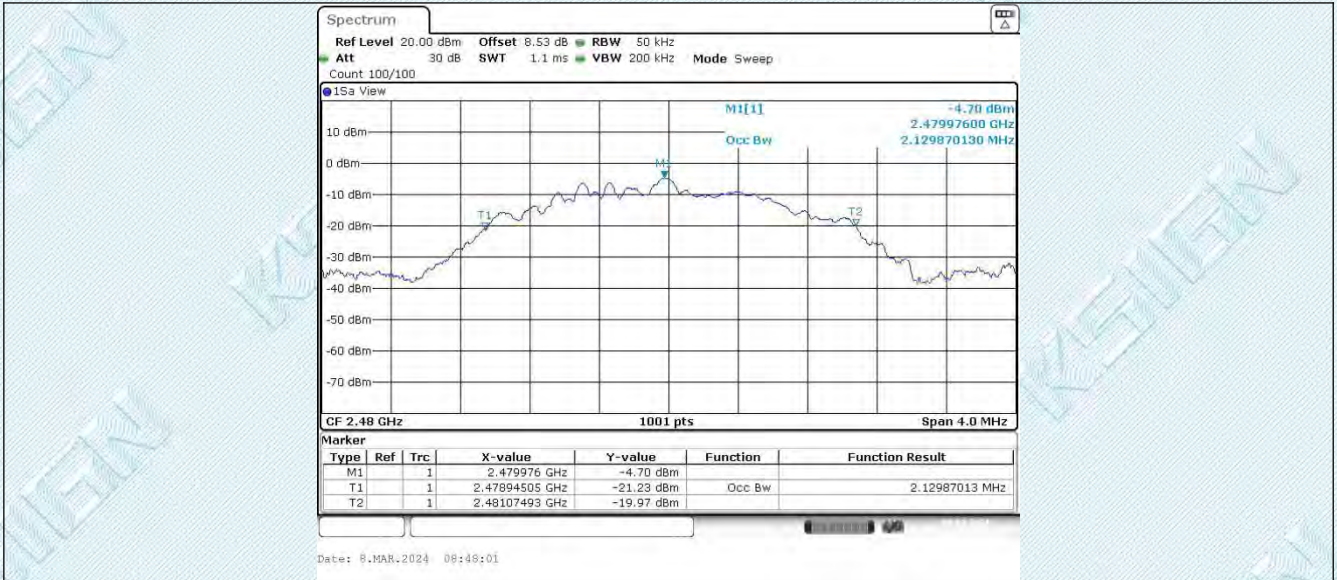

TRF RF_R1

Add: West Side of 1/F., Building C, Zone A, Fuyuan New Factory, Jiujiu Industrial Park, Minzhu, Shatou, Shajing, Bao'an District, Shenzhen, Guangdong, China

Tel: +(86) 0755-2985 2678 Fax: +(86) 0755-2985 2397 E-mail: info@gdkesign.cn Web: www.gdkesign.com

6.3. Appendix C: Maximum conducted output power

6.3.1. Test Result

TestMode	Antenna	Freq.[MHz]	Conducted Power[dBm]	Conducted Limit[dBm]
BLE_1M	Ant1	2402	-0.24	≤30
		2440	-0.42	≤30
		2480	-0.48	≤30
BLE_2M	Ant1	2402	-0.25	≤30
		2440	-0.42	≤30
		2480	-0.62	≤30

6.3.2. Test Graphs



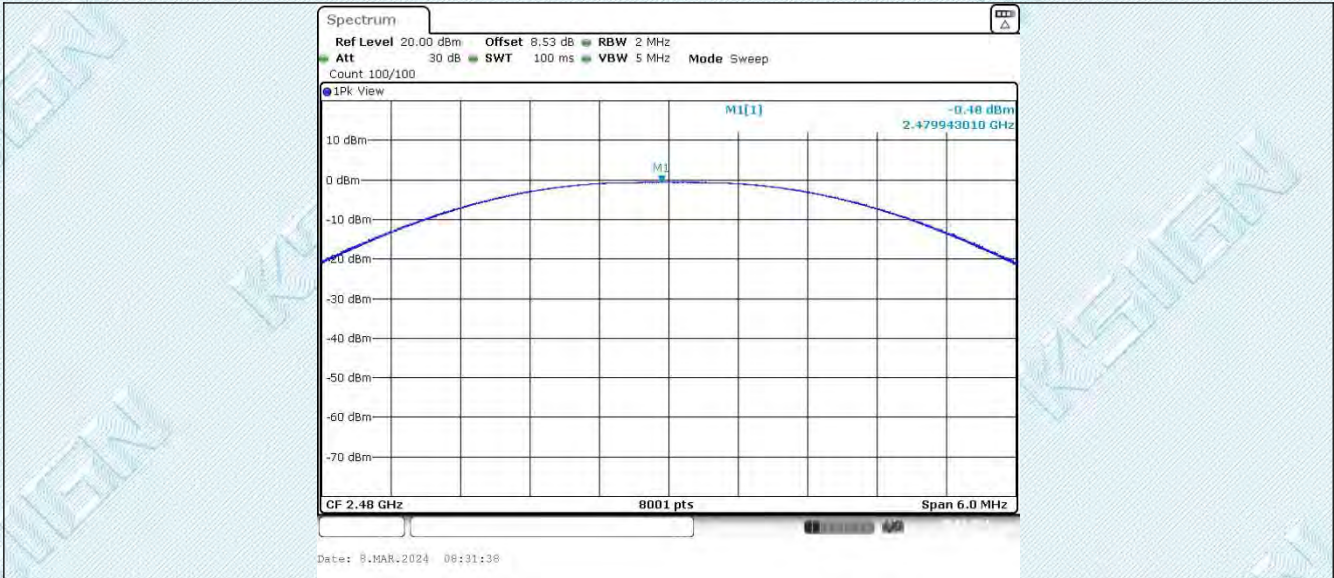

BLE_2M_Ant1_2402



BLE_2M_Ant1_2440



BLE_2M_Ant1_2480

TRF RF_R1

Add: West Side of 1/F., Building C, Zone A, Fuyuan New Factory, Jiujiu Industrial Park, Minzhu, Shatou, Shajing, Bao'an District, Shenzhen, Guangdong, China

Tel: +(86) 0755-2985 2678 Fax: +(86) 0755-2985 2397 E-mail: info@gdkesign.cn Web: www.gdkesign.com

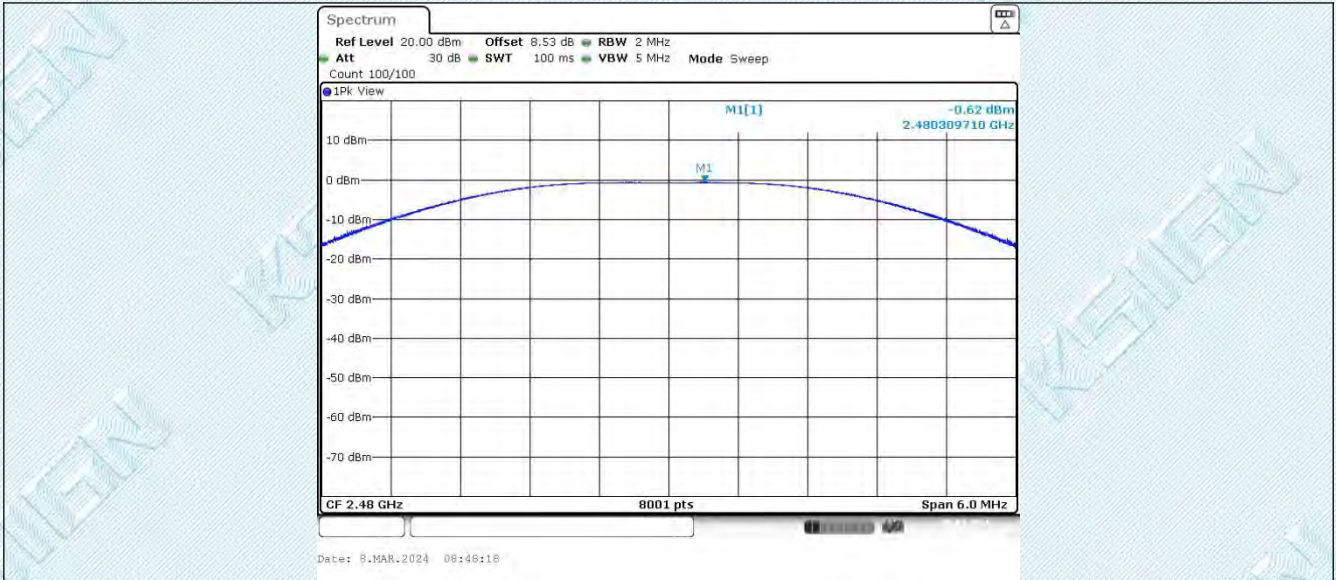

TRF RF_R1

Add: West Side of 1/F., Building C, Zone A, Fuyuan New Factory, Jiujiu Industrial Park, Minzhu, Shatou, Shajing, Bao'an District, Shenzhen, Guangdong, China

Tel: +(86) 0755-2985 2678 Fax: +(86) 0755-2985 2397 E-mail: info@gdkesign.cn Web: www.gdkesign.com

6.4. Appendix D: Maximum power spectral density

6.4.1. Test Result

TestMode	Antenna	Freq[MHz]	Result[dBm/3kHz]	Limit[dBm/3kHz]	Verdict
BLE_1M	Ant1	2402	-15.52	≤8.00	PASS
		2440	-15.55	≤8.00	PASS
		2480	-15.66	≤8.00	PASS
BLE_2M	Ant1	2402	-17.26	≤8.00	PASS
		2440	-17.24	≤8.00	PASS
		2480	-17.41	≤8.00	PASS

6.4.2. Test Graphs

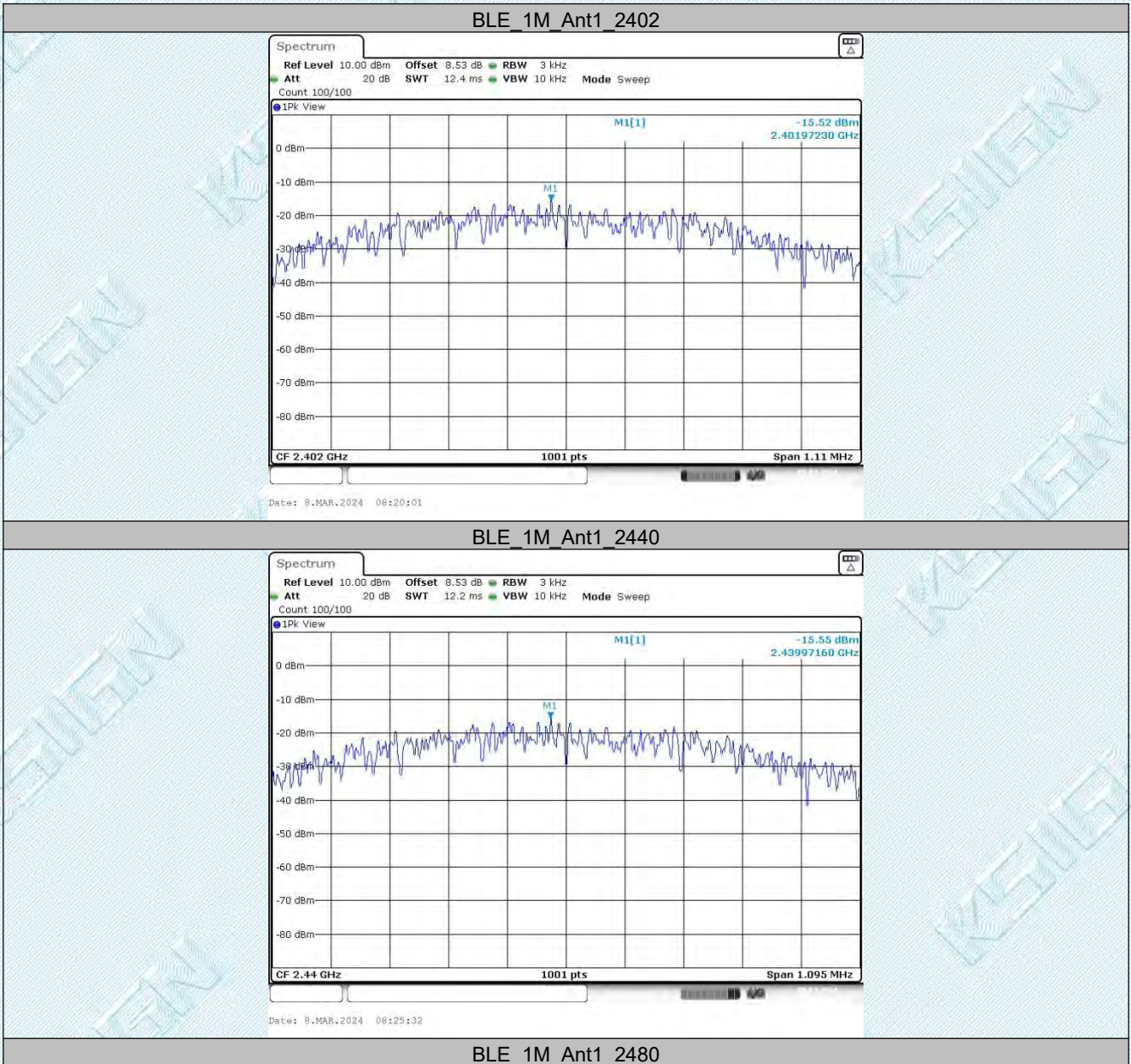

TRF RF_R1

Add: West Side of 1/F., Building C, Zone A, Fuyuan New Factory, Jiujiu Industrial Park, Minzhu, Shatou, Shajing, Bao'an District, Shenzhen, Guangdong, China

Tel: +(86) 0755-2985 2678 Fax: +(86) 0755-2985 2397 E-mail: info@gdkesign.cn Web: www.gdkesign.com

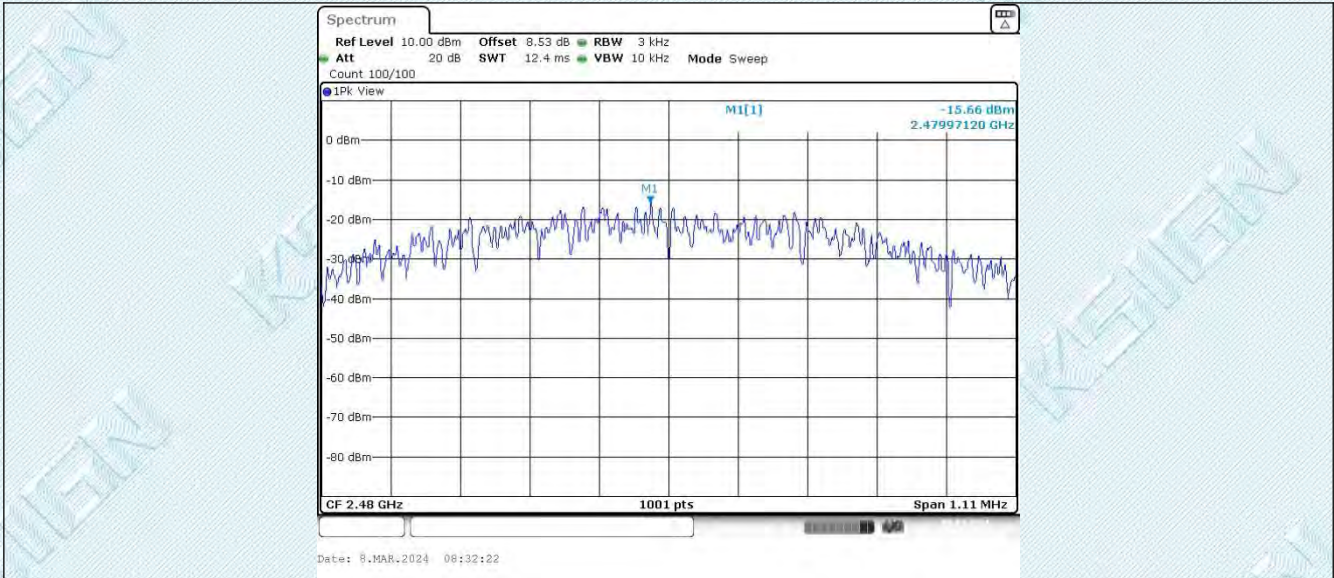

BLE_2M_Ant1_2402

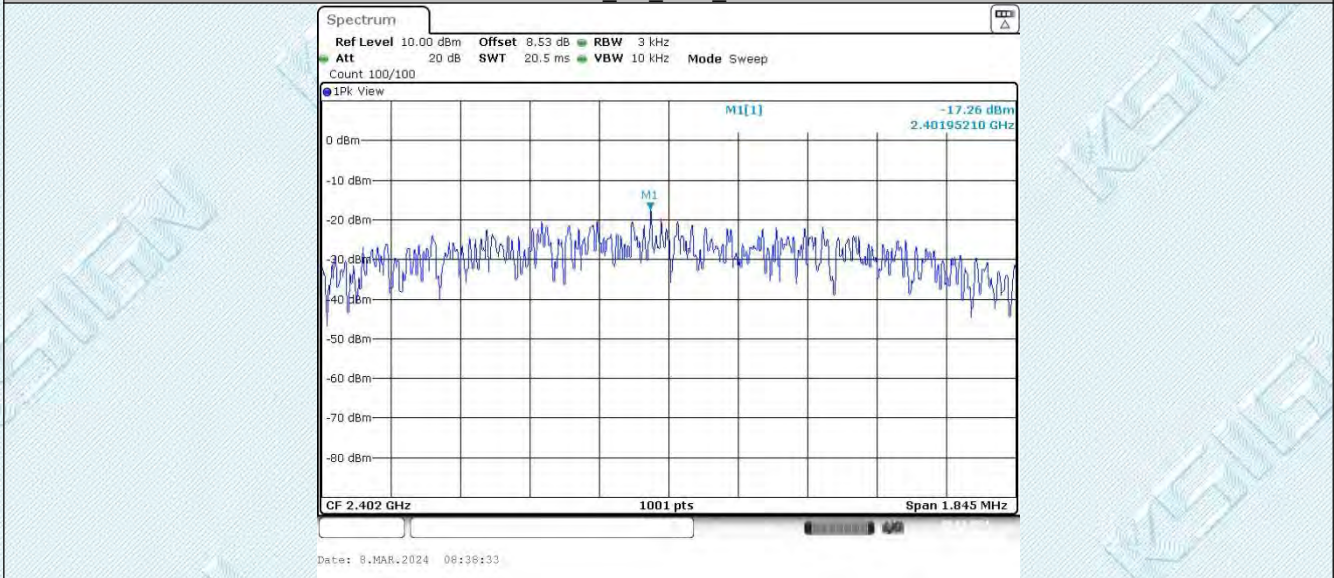

BLE_2M_Ant1_2440

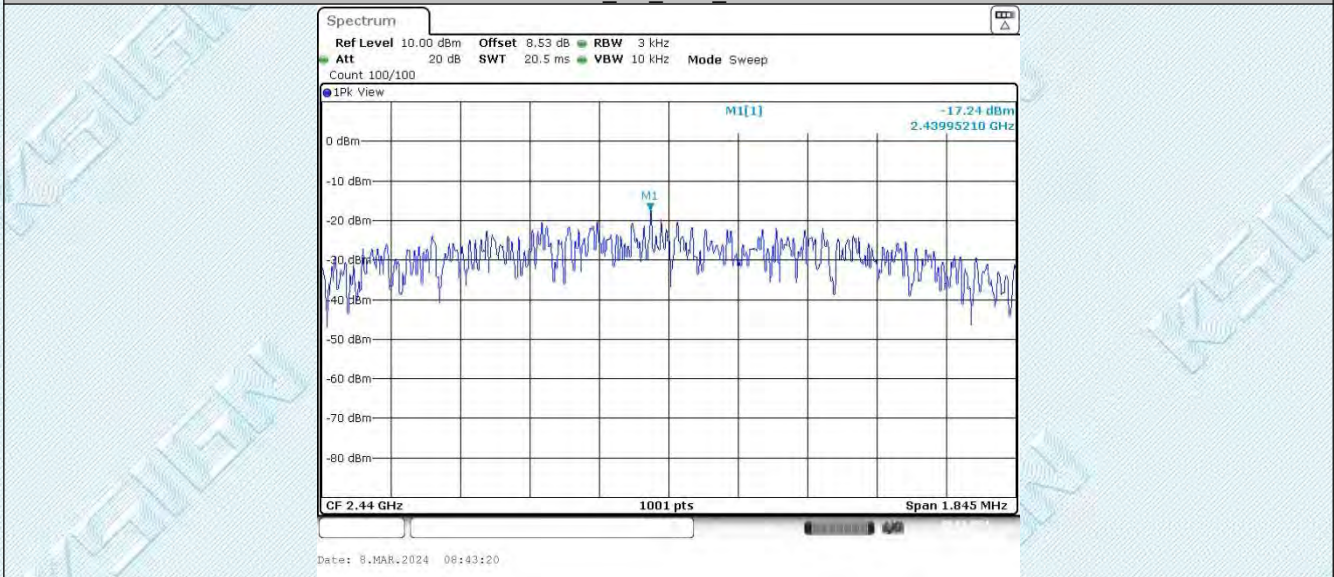

BLE_2M_Ant1_2480

TRF RF_R1

Add: West Side of 1/F., Building C, Zone A, Fuyuan New Factory, Jiujiu Industrial Park, Minzhu, Shatou, Shajing, Bao'an District, Shenzhen, Guangdong, China

Tel: +(86) 0755-2985 2678 Fax: +(86) 0755-2985 2397 E-mail: info@gdkesign.cn Web: www.gdkesign.com

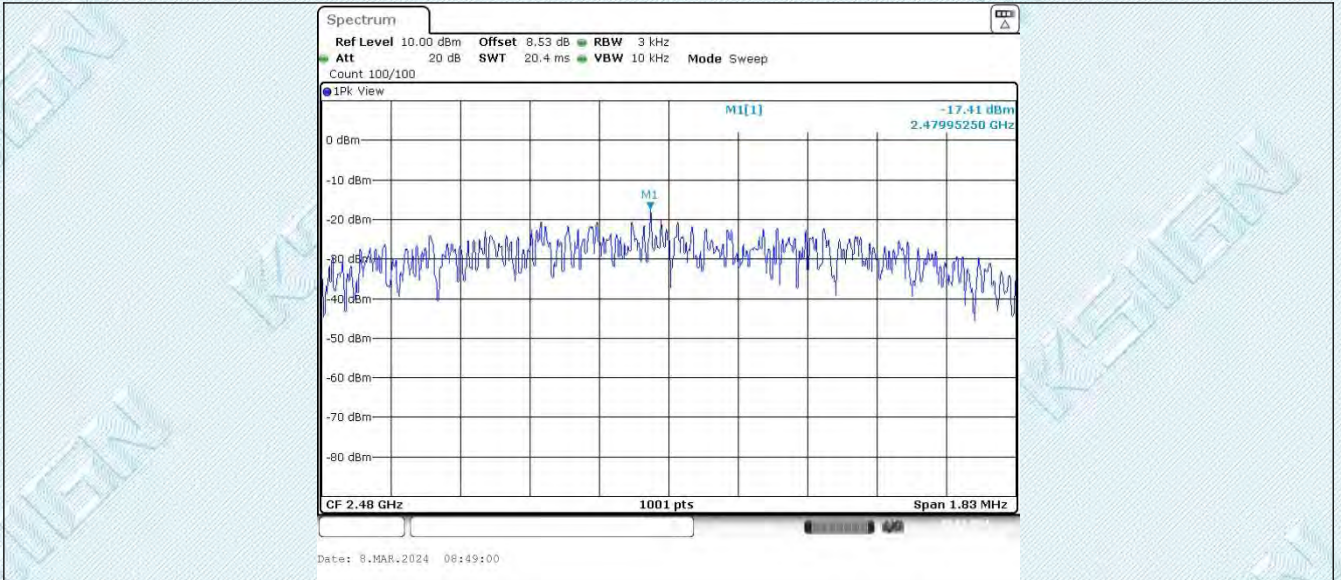

TRF RF_R1

Add: West Side of 1/F., Building C, Zone A, Fuyuan New Factory, Jiujiu Industrial Park, Minzhu, Shatou, Shajing, Bao'an District, Shenzhen, Guangdong, China

Tel: +(86) 0755-2985 2678 Fax: +(86) 0755-2985 2397 E-mail: info@gdkesign.cn Web: www.gdkesign.com

6.5. ppendix E: Reference level measurement

6.5.1. Test Result

TestMode	Antenna	Freq[MHz]	Max.Point[MHz]	Result[dBm]
BLE_1M	Ant1	2402	2402.23	-1.24
		2440	2440.23	-1.43
		2480	2480.23	-1.53
BLE_2M	Ant1	2402	2402.00	-1.61
		2440	2439.99	-1.70
		2480	2480.00	-1.90

6.5.2. Test Graphs

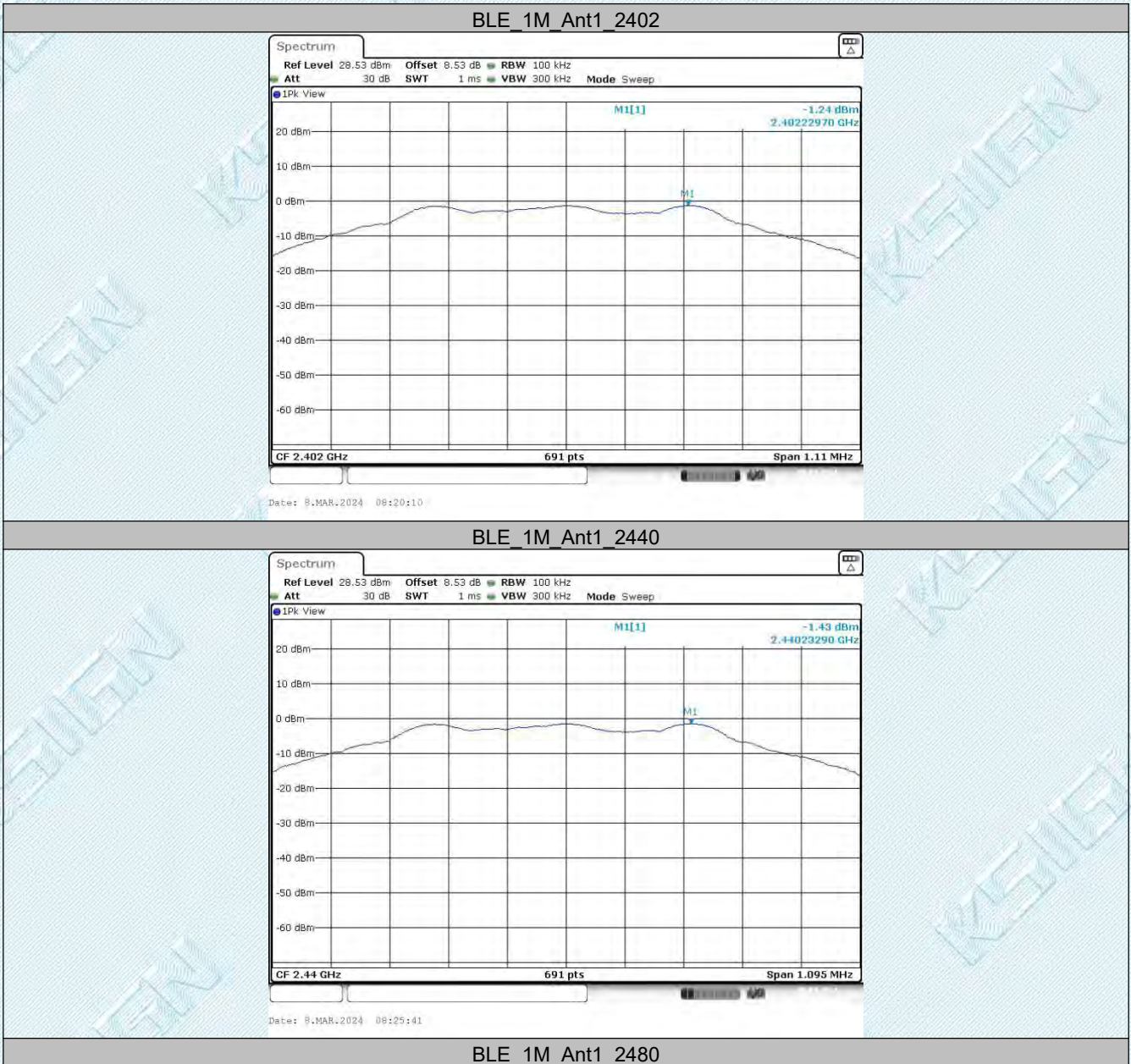

TRF RF_R1

Add: West Side of 1/F., Building C, Zone A, Fuyuan New Factory, Jiujiu Industrial Park, Minzhu, Shatou, Shajing, Bao'an District, Shenzhen, Guangdong, China

Tel: +(86) 0755-2985 2678 Fax: +(86) 0755-2985 2397 E-mail: info@gdkesign.cn Web: www.gdkesign.com



BLE_2M_Ant1_2402

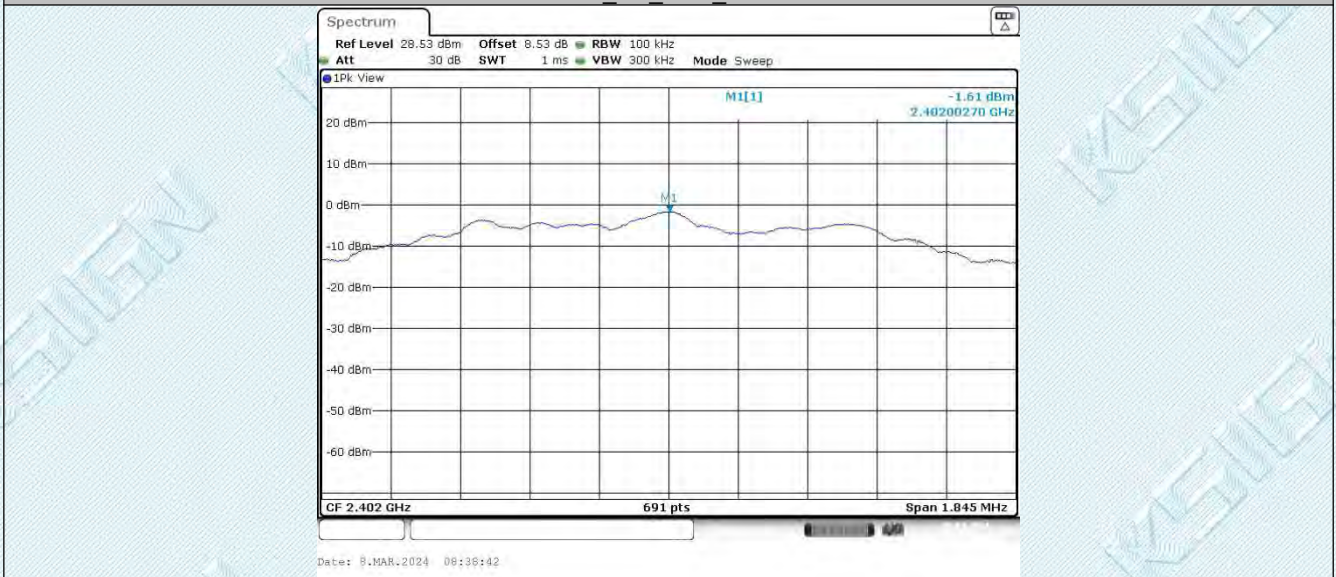

BLE_2M_Ant1_2440

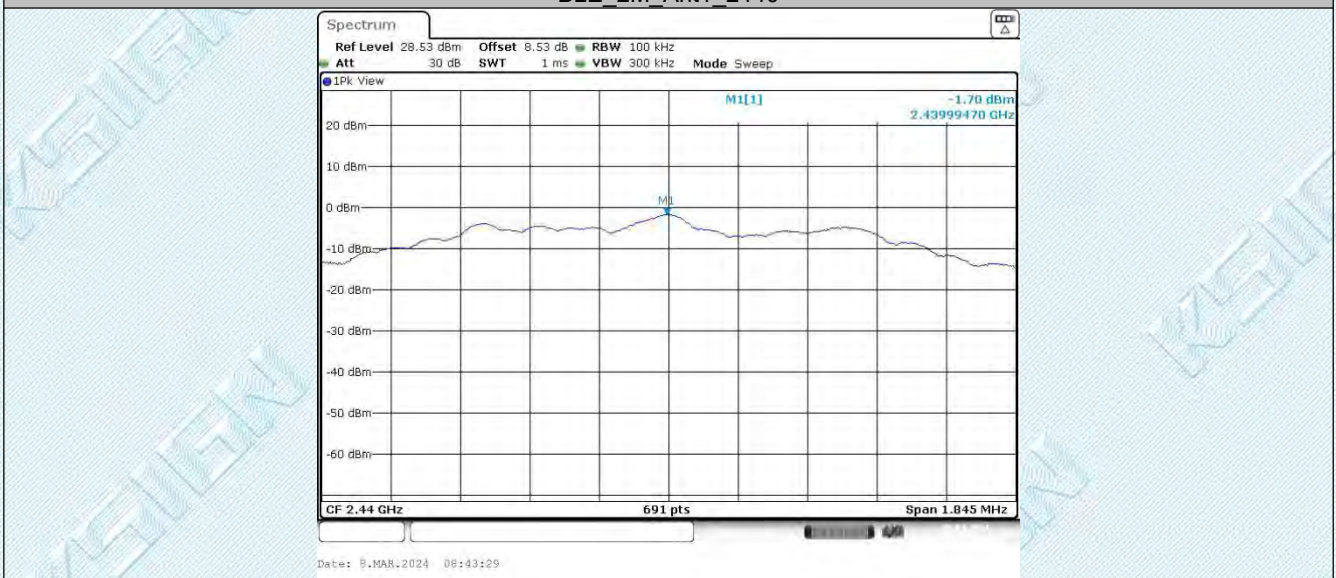

BLE_2M_Ant1_2480

TRF RF_R1

Add: West Side of 1/F., Building C, Zone A, Fuyuan New Factory, Jiujiu Industrial Park, Minzhu, Shatou, Shajing, Bao'an District, Shenzhen, Guangdong, China

Tel: +(86) 0755-2985 2678 Fax: +(86) 0755-2985 2397 E-mail: info@gdkesign.cn Web: www.gdkesign.com

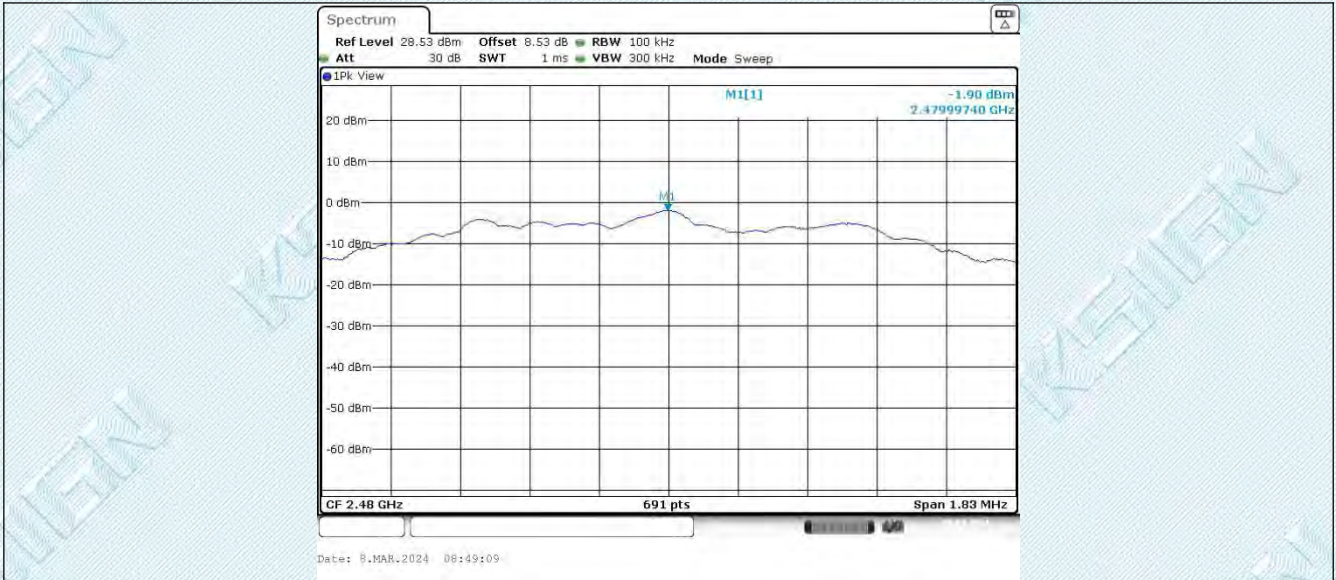

TRF RF_R1

Add: West Side of 1/F., Building C, Zone A, Fuyuan New Factory, Jiujiu Industrial Park, Minzhu, Shatou, Shajing, Bao'an District, Shenzhen, Guangdong, China

Tel: +(86) 0755-2985 2678 Fax: +(86) 0755-2985 2397 E-mail: info@gdkesign.cn Web: www.gdkesign.com

6.6. Appendix F: Band edge measurements

6.6.1. Test Result

TestMode	Antenna	ChName	Freq[MHz]	RefLevel[dBm]	Result[dBm]	Limit[dBm]	Verdict
BLE_1M	Ant1	Low	2402	-1.24	-36.98	≤ -21.24	PASS
		High	2480	-1.53	-41.1	≤ -21.53	PASS
BLE_2M	Ant1	Low	2402	-1.61	-27.51	≤ -21.61	PASS
		High	2480	-1.90	-40.97	≤ -21.9	PASS

6.6.2. Test Graphs

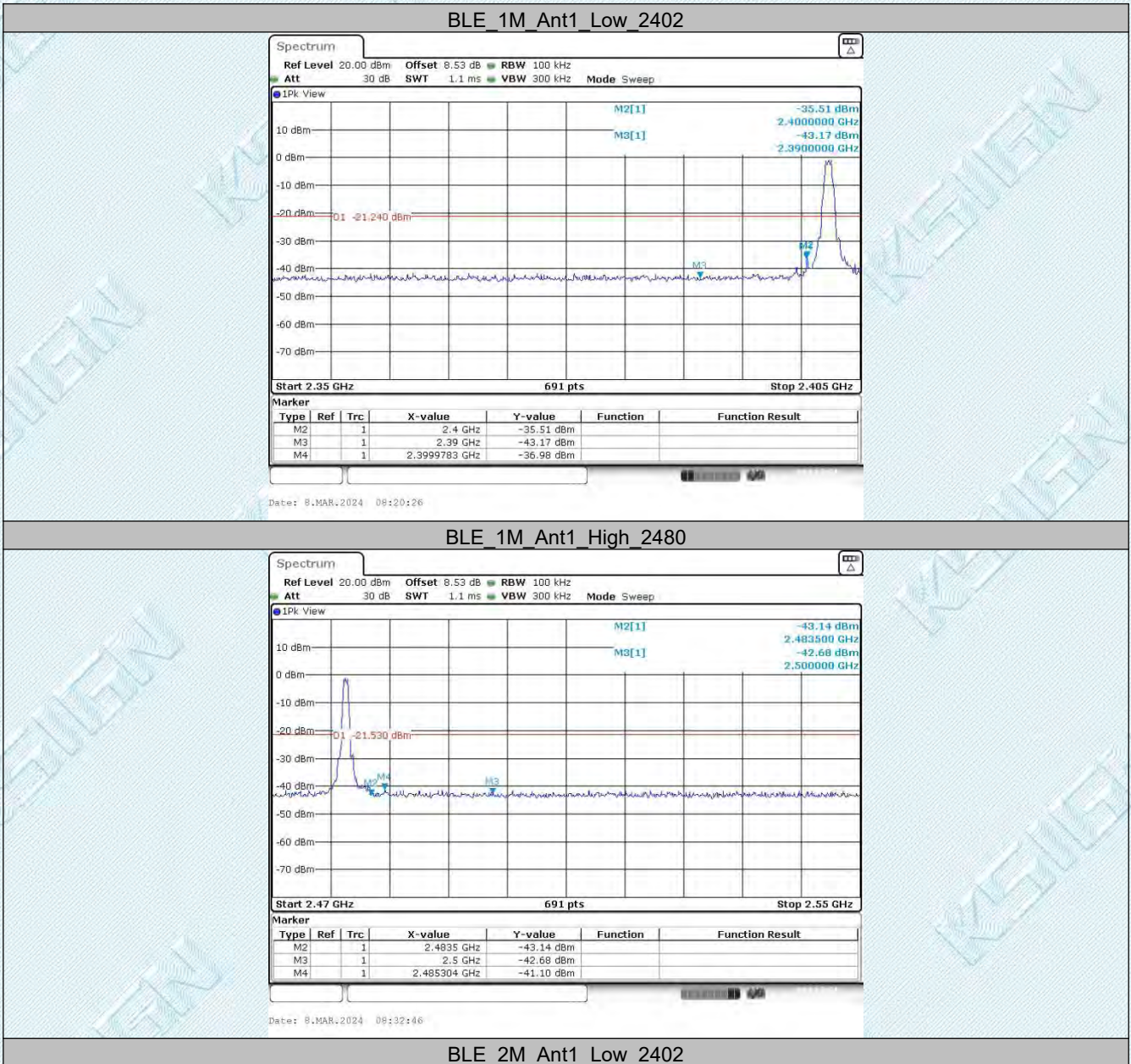

TRF RF_R1

Add: West Side of 1/F., Building C, Zone A, Fuyuan New Factory, Jiujiu Industrial Park, Minzhu, Shatou, Shajing, Bao'an District, Shenzhen, Guangdong, China

Tel: +(86) 0755-2985 2678 Fax: +(86) 0755-2985 2397 E-mail: info@gdkesign.cn Web: www.gdkesign.com

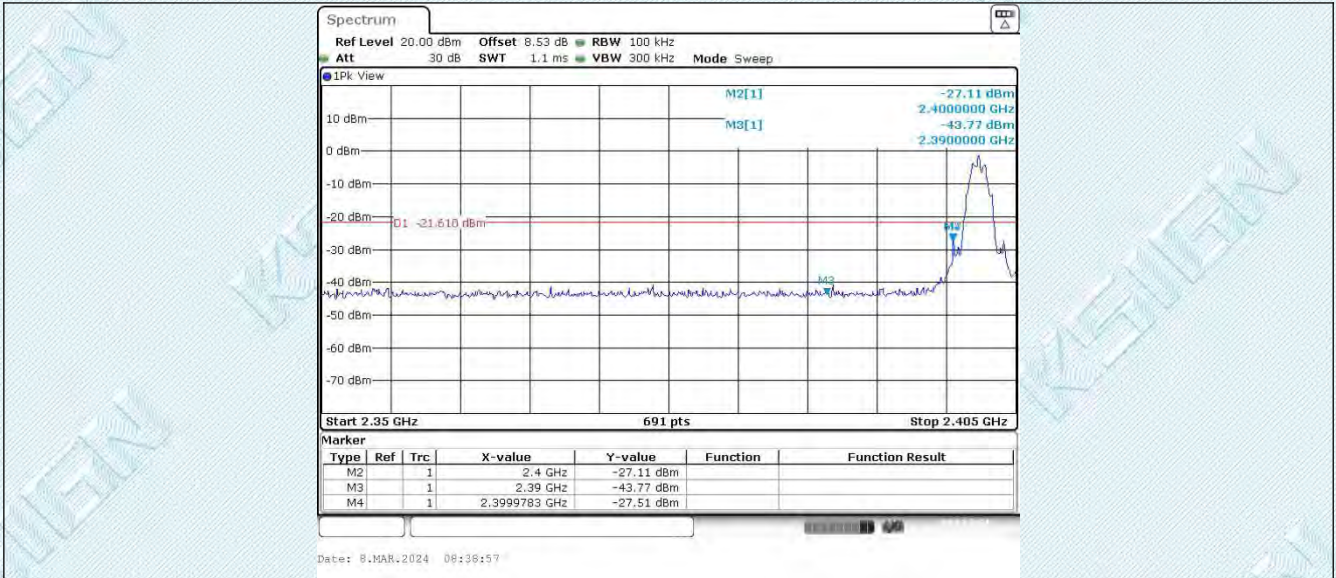

BLE 2M Ant1 High 2480

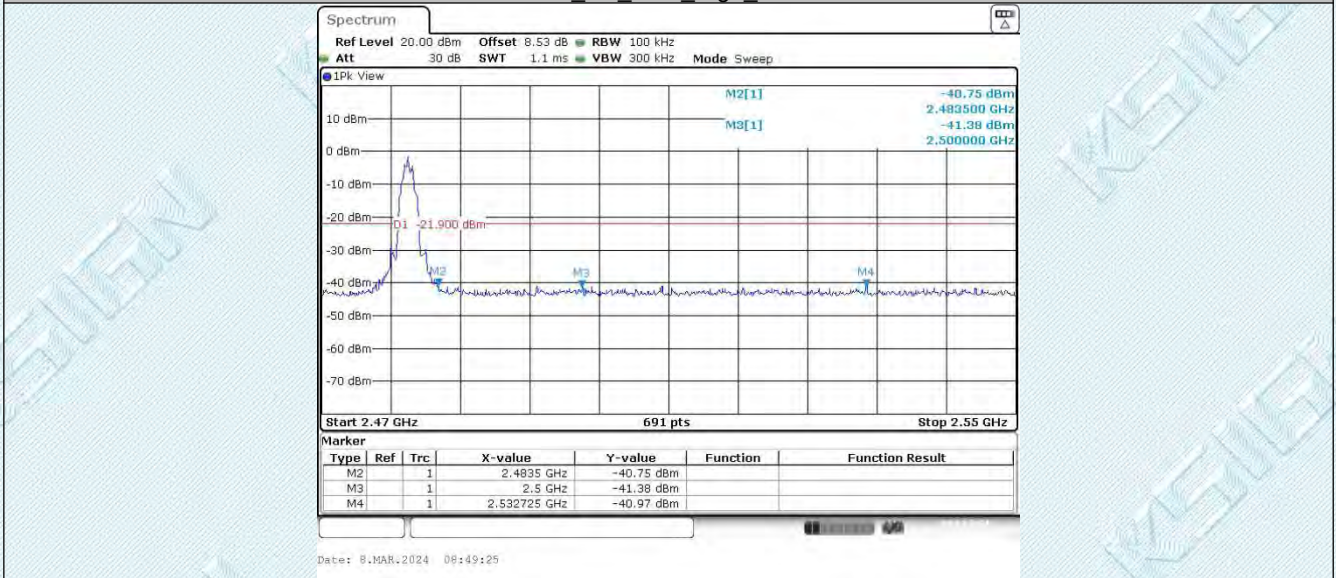

TRF RF_R1

Add: West Side of 1/F., Building C, Zone A, Fuyuan New Factory, Jiujiu Industrial Park, Minzhu, Shatou, Shajing, Bao'an District, Shenzhen, Guangdong, China

Tel: +(86) 0755-2985 2678 Fax: +(86) 0755-2985 2397 E-mail: info@gdkesign.cn Web: www.gdkesign.com

6.7. Appendix G: Conducted Spurious Emission

6.7.1. Test Result

TestMode	Antenna	Freq[MHz]	FreqRange [MHz]	RefLevel [dBm]	Result[dBm]	Limit[dBm]	Verdict
BLE_1M	Ant1	2402	30~1000	-1.24	-52.95	≤-21.24	PASS
			1000~26500	-1.24	-41.93	≤-21.24	PASS
		2440	30~1000	-1.43	-52.52	≤-21.43	PASS
			1000~26500	-1.43	-43.2	≤-21.43	PASS
		2480	30~1000	-1.53	-52.68	≤-21.53	PASS
			1000~26500	-1.53	-44.2	≤-21.53	PASS
BLE_2M	Ant1	2402	30~1000	-1.61	-51.99	≤-21.61	PASS
			1000~26500	-1.61	-42.69	≤-21.61	PASS
		2440	30~1000	-1.70	-52.52	≤-21.7	PASS
			1000~26500	-1.70	-45.04	≤-21.7	PASS
		2480	30~1000	-1.90	-52.69	≤-21.9	PASS
			1000~26500	-1.90	-46.36	≤-21.9	PASS

6.7.2. Test Graphs

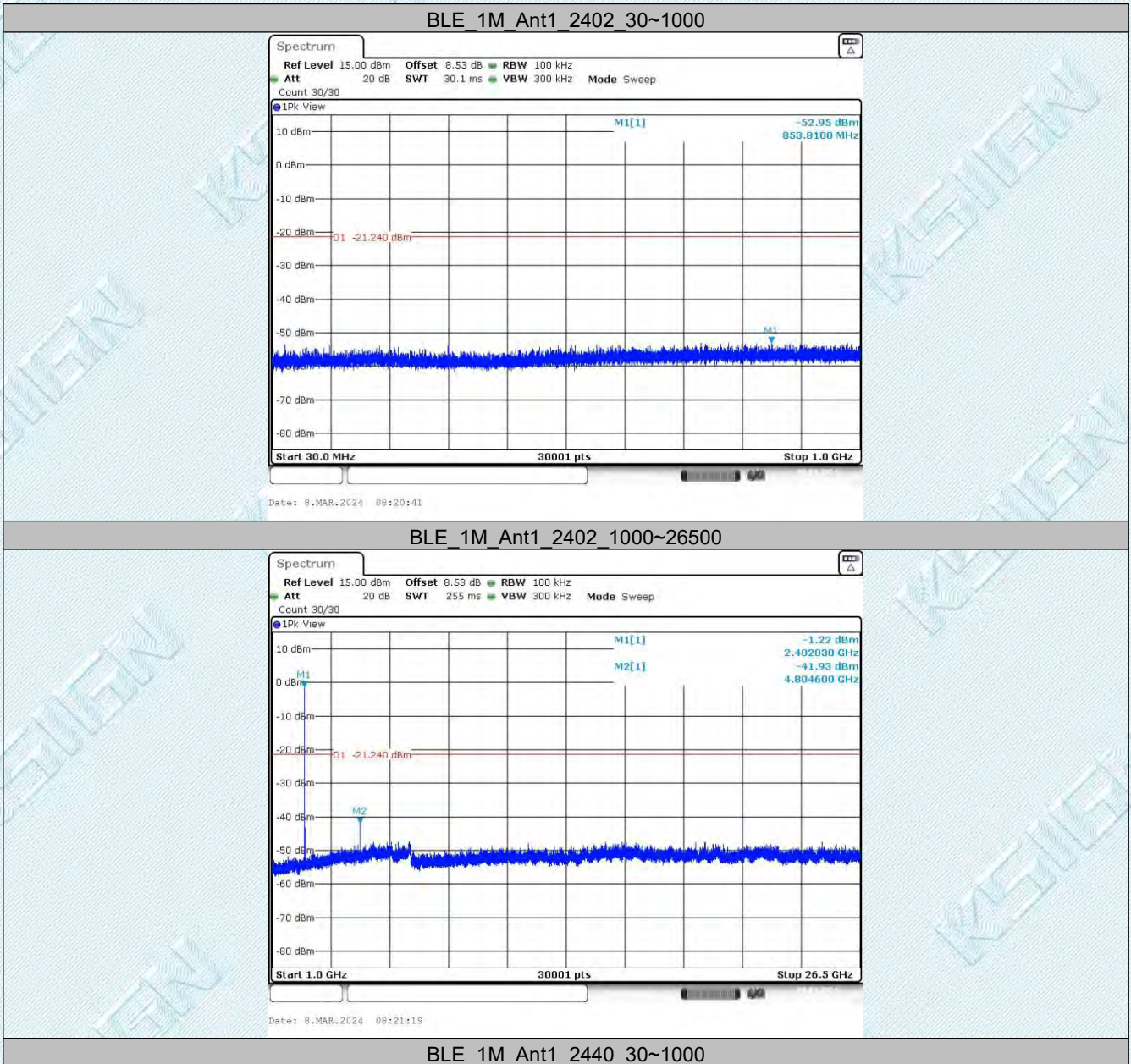

TRF RF_R1

Add: West Side of 1/F., Building C, Zone A, Fuyuan New Factory, Jiujiu Industrial Park, Minzhu, Shatou, Shajing, Bao'an District, Shenzhen, Guangdong, China

Tel: +(86) 0755-2985 2678 Fax: +(86) 0755-2985 2397 E-mail: info@gdkesign.cn Web: www.gdkesign.com

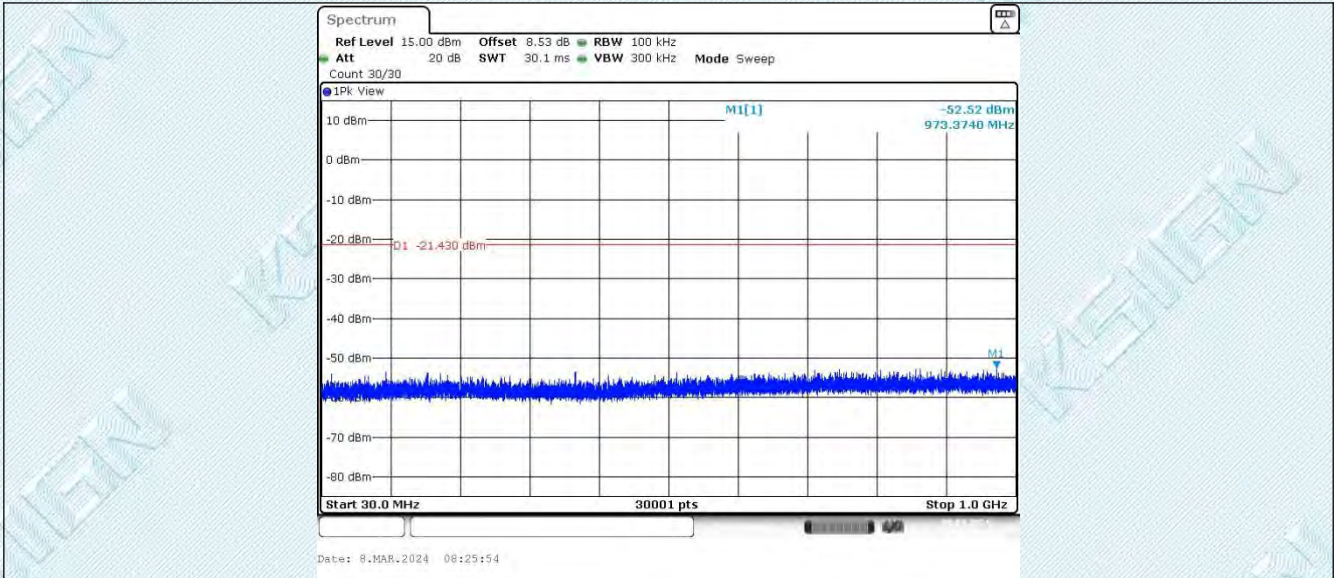

BLE_1M_Ant1_2440_1000~26500

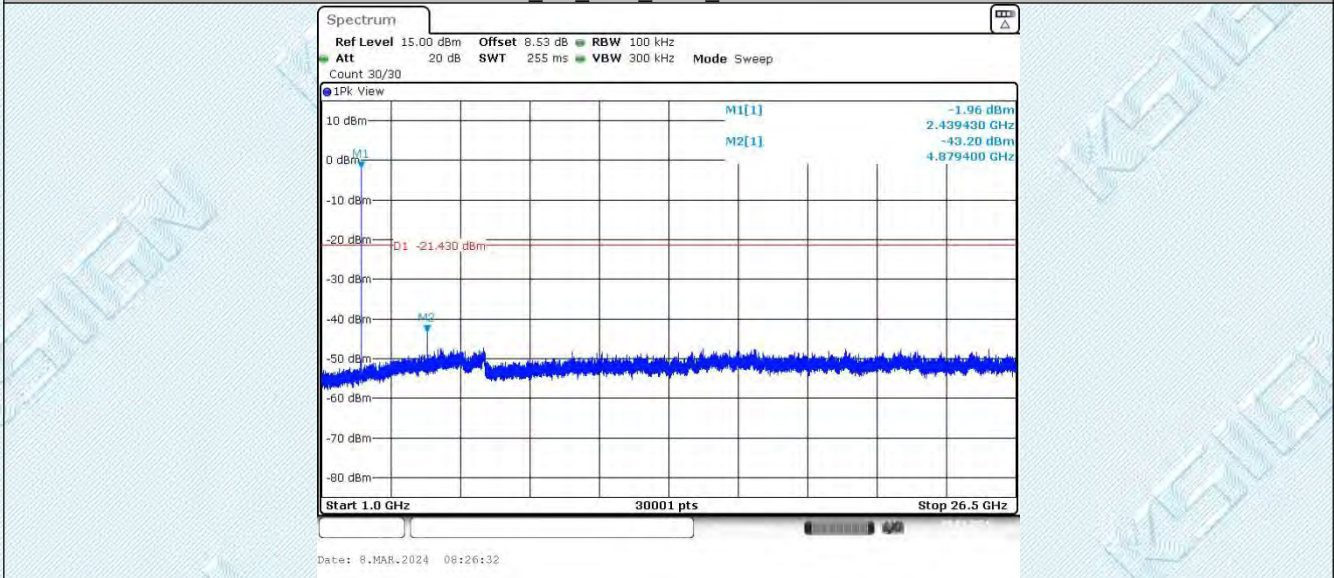

BLE_1M_Ant1_2480_30~1000

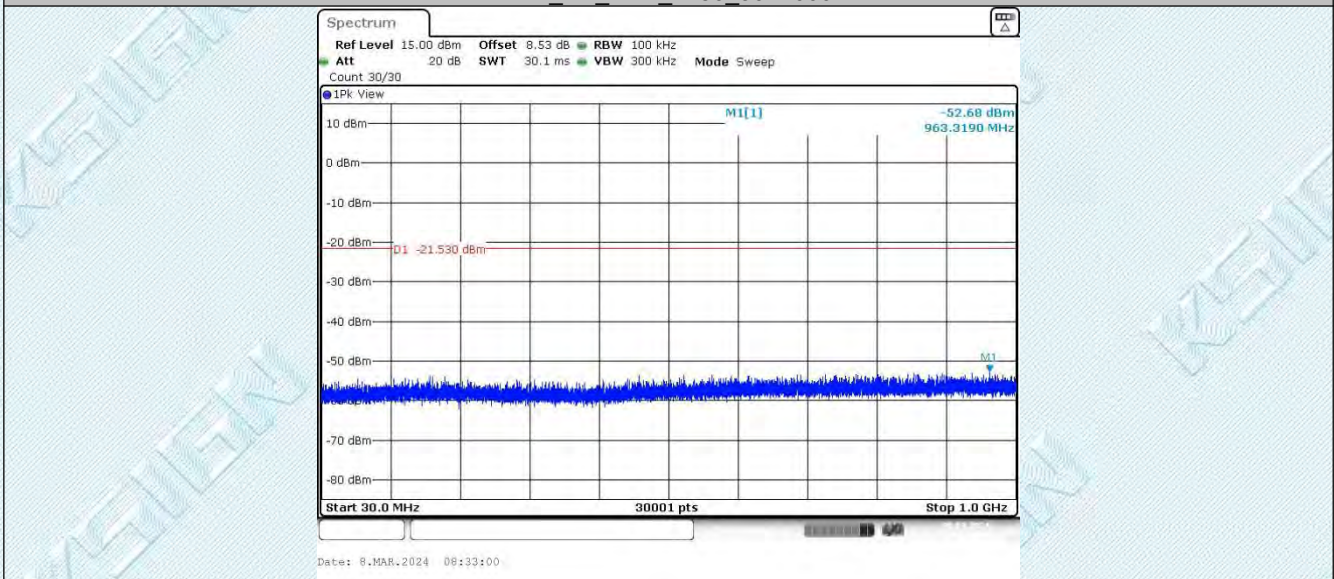

BLE_1M_Ant1_2480_1000~26500

TRF RF_R1

Add: West Side of 1/F., Building C, Zone A, Fuyuan New Factory, Jiujiu Industrial Park, Minzhu, Shatou, Shajing, Bao'an District, Shenzhen, Guangdong, China

Tel: +(86) 0755-2985 2678 Fax: +(86) 0755-2985 2397 E-mail: info@gdkesign.cn Web: www.gdkesign.com

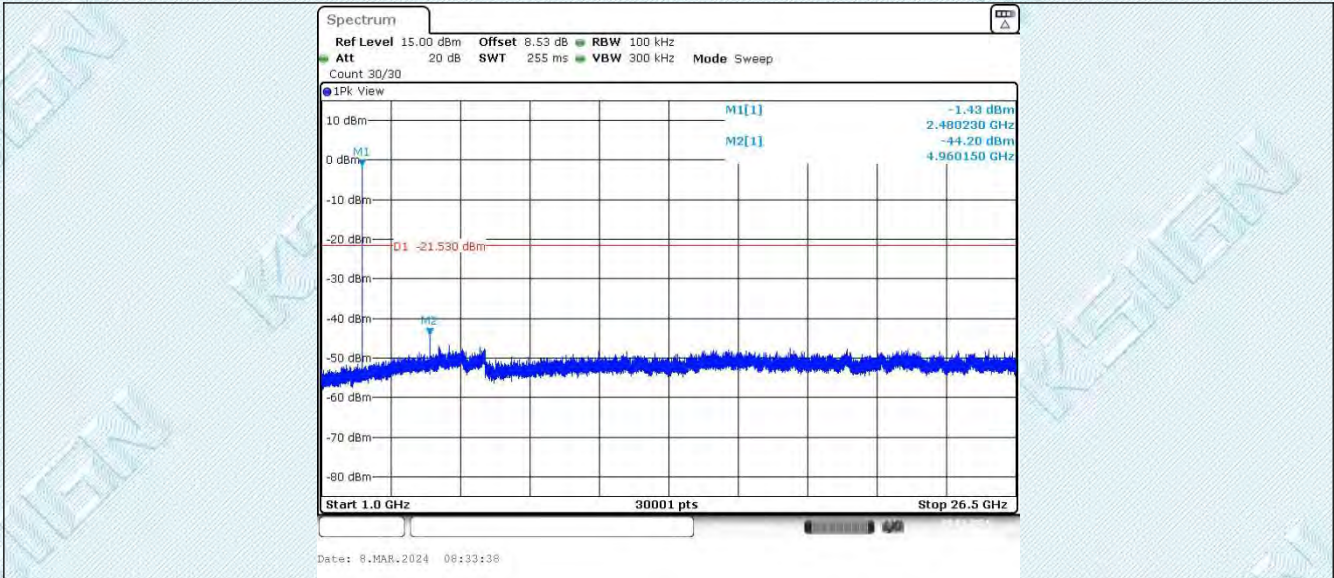

BLE_2M_Ant1_2402_30~1000

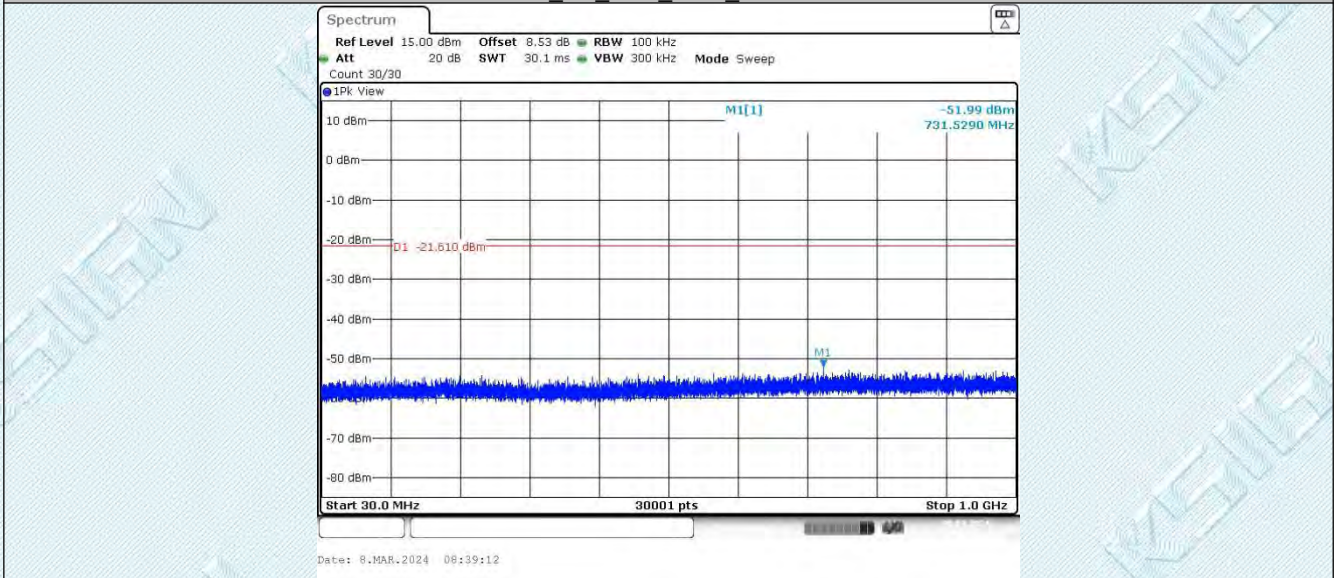

BLE_2M_Ant1_2402_1000~26500

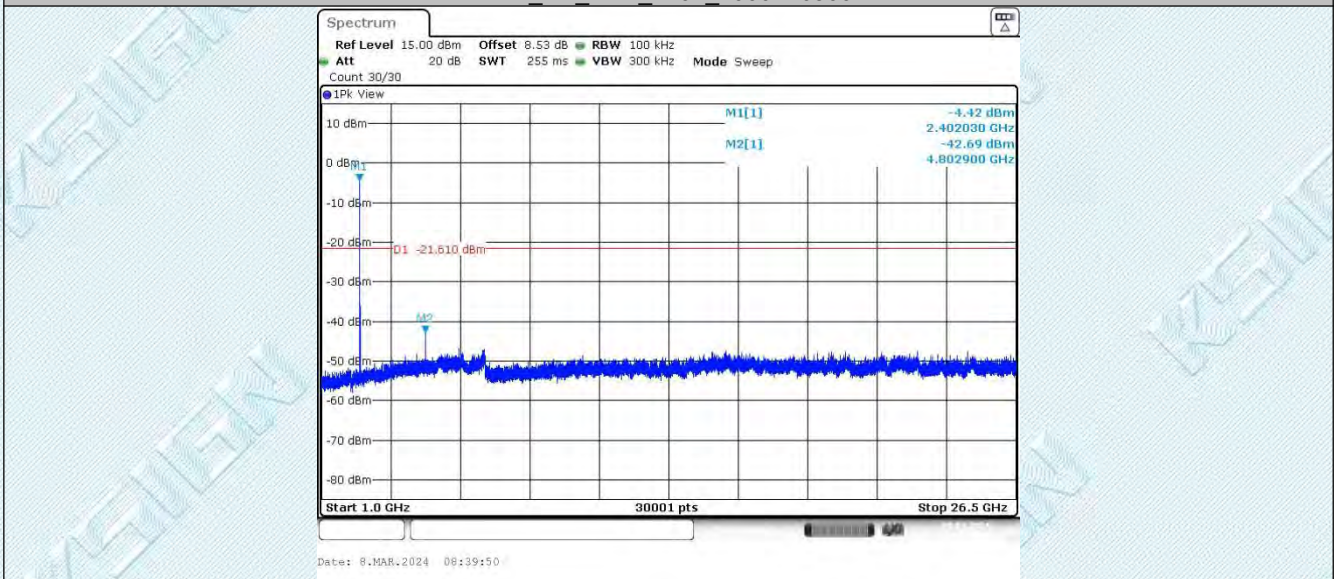

BLE_2M_Ant1_2440_30~1000

TRF RF_R1

Add: West Side of 1/F., Building C, Zone A, Fuyuan New Factory, Jiujiu Industrial Park, Minzhu, Shatou, Shajing, Bao'an District, Shenzhen, Guangdong, China

Tel: +(86) 0755-2985 2678 Fax: +(86) 0755-2985 2397 E-mail: info@gdkesign.cn Web: www.gdkesign.com

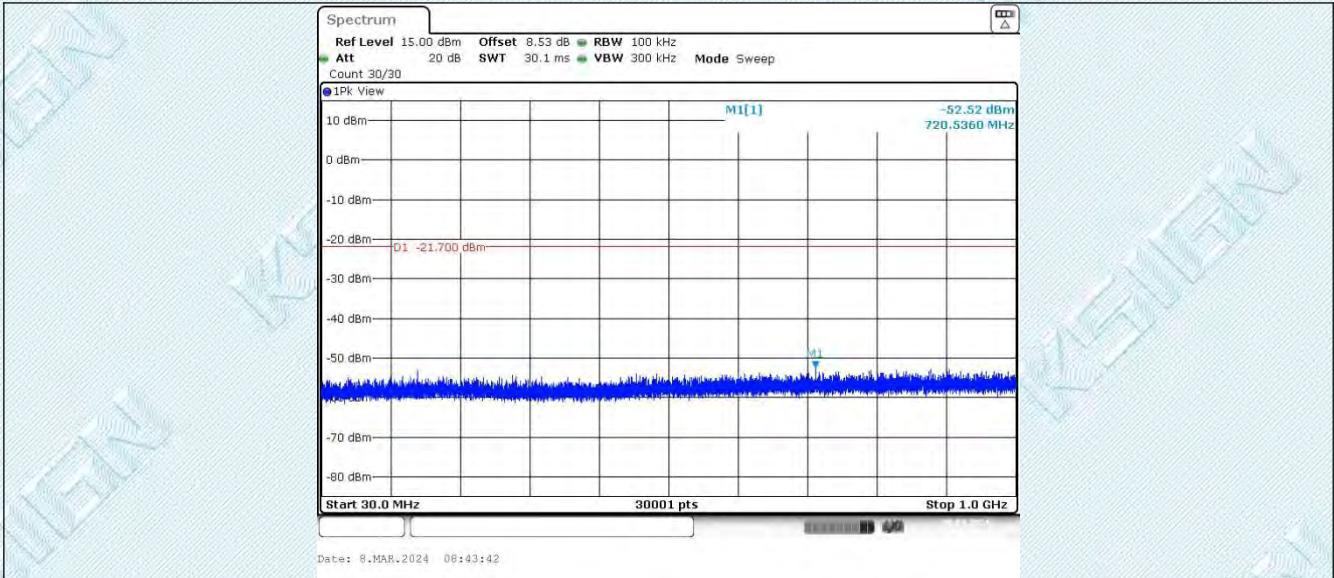

BLE_2M_Ant1_2440_1000~26500

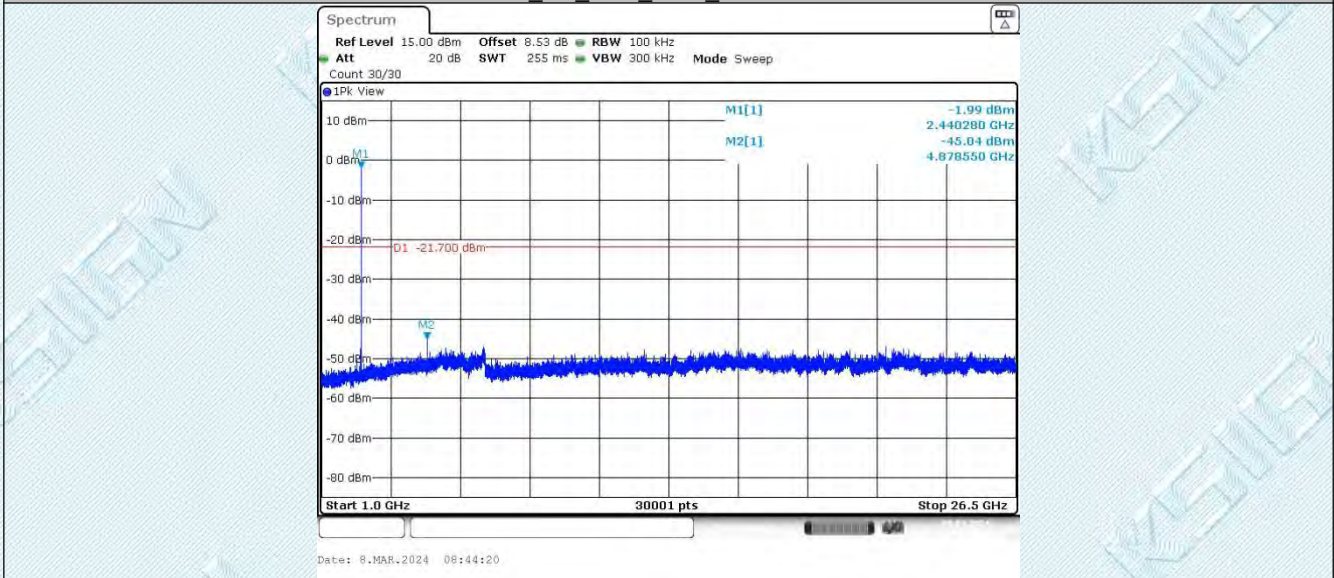

BLE_2M_Ant1_2480_30~1000

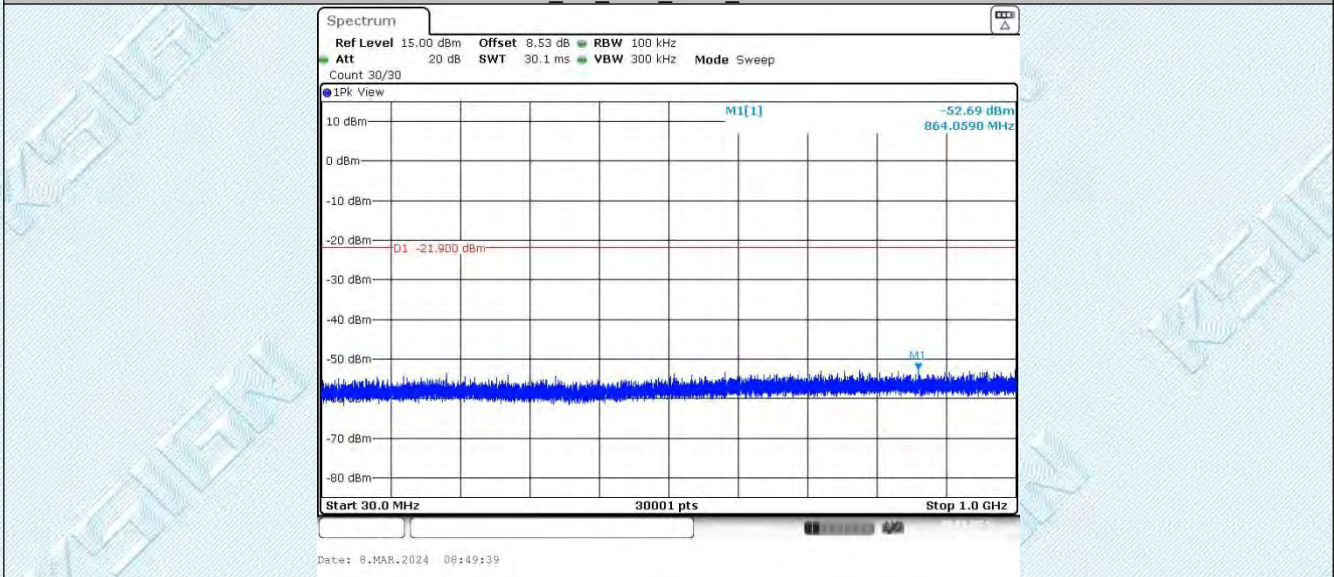

BLE_2M_Ant1_2480_1000~26500

TRF RF_R1

Add: West Side of 1/F., Building C, Zone A, Fuyuan New Factory, Jiujiu Industrial Park, Minzhu, Shatou, Shajing, Bao'an District, Shenzhen, Guangdong, China

Tel: +(86) 0755-2985 2678 Fax: +(86) 0755-2985 2397 E-mail: info@gdkesign.cn Web: www.gdkesign.com

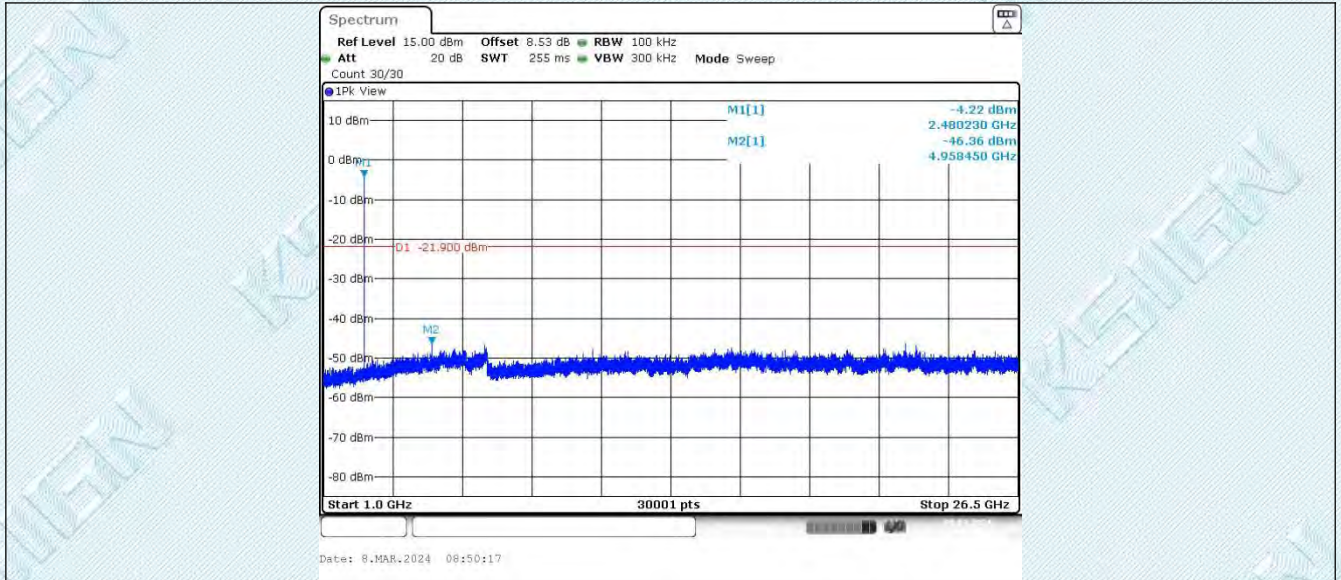

TRF RF_R1

Add: West Side of 1/F., Building C, Zone A, Fuyuan New Factory, Jiujiu Industrial Park, Minzhu, Shatou, Shajing, Bao'an District, Shenzhen, Guangdong, China

Tel: +(86) 0755-2985 2678 Fax: +(86) 0755-2985 2397 E-mail: info@gdkesign.cn Web: www.gdkesign.com

6.8. Appendix H: Duty Cycle

6.8.1. Test Result

TestMode	Antenna	Freq[MHz]	ON Time [ms]	Period [ms]	DC [%]	Limit	Verdict
BLE_1M	Ant1	2402	0.39	0.63	61.90	---	PASS
		2440	0.39	0.63	61.90	---	PASS
		2480	0.39	0.63	61.90	---	PASS
BLE_2M	Ant1	2402	0.20	0.63	31.75	---	PASS
		2440	0.20	0.63	31.75	---	PASS
		2480	0.20	0.63	31.75	---	PASS

DC=ON Time/Period*100%

6.8.2. Test Graphs

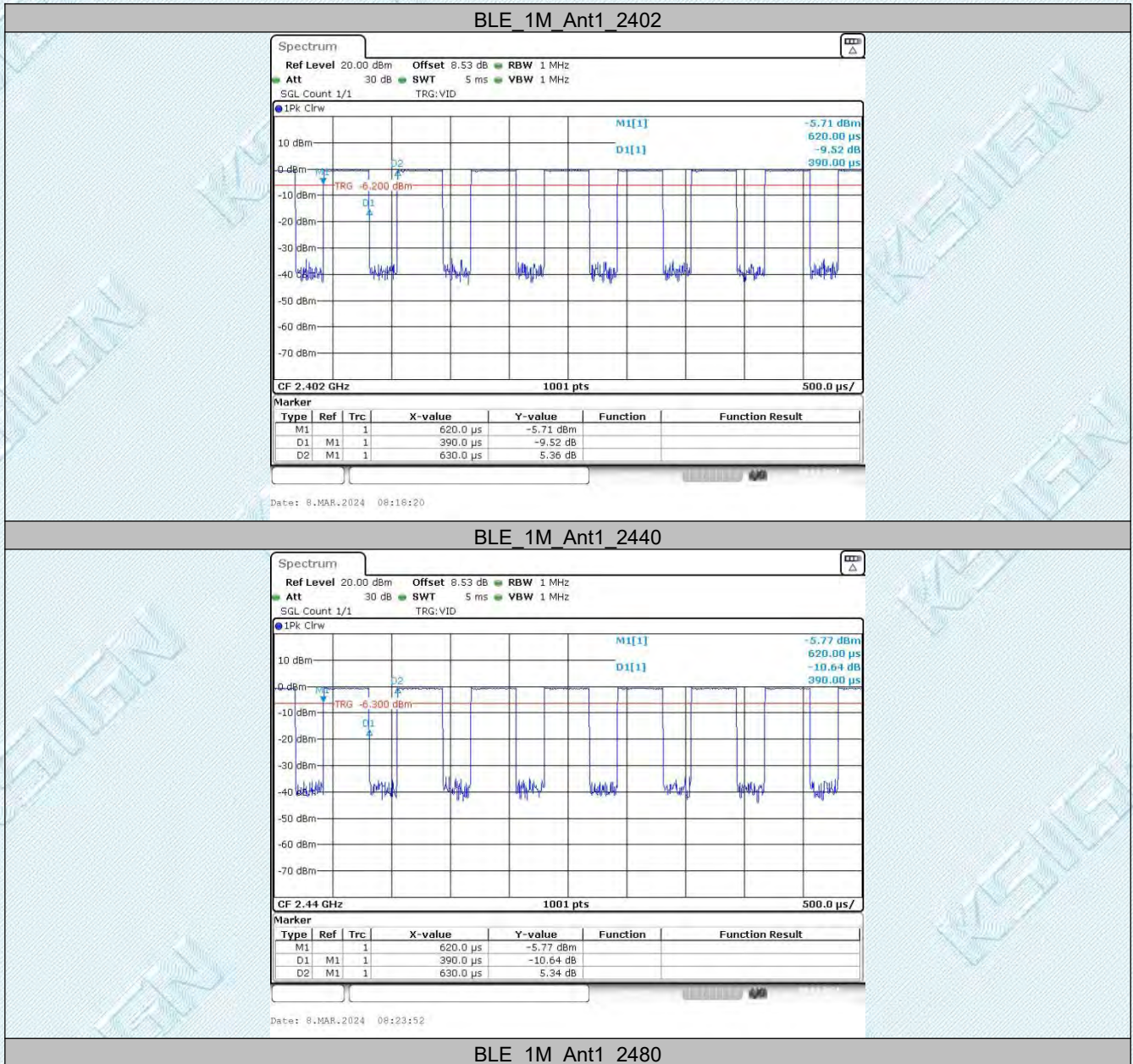

TRF RF_R1

Add: West Side of 1/F., Building C, Zone A, Fuyuan New Factory, Jiujiu Industrial Park, Minzhu, Shatou, Shajing, Bao'an District, Shenzhen, Guangdong, China

Tel: +(86) 0755-2985 2678 Fax: +(86) 0755-2985 2397 E-mail: info@gdkesign.cn Web: www.gdkesign.com

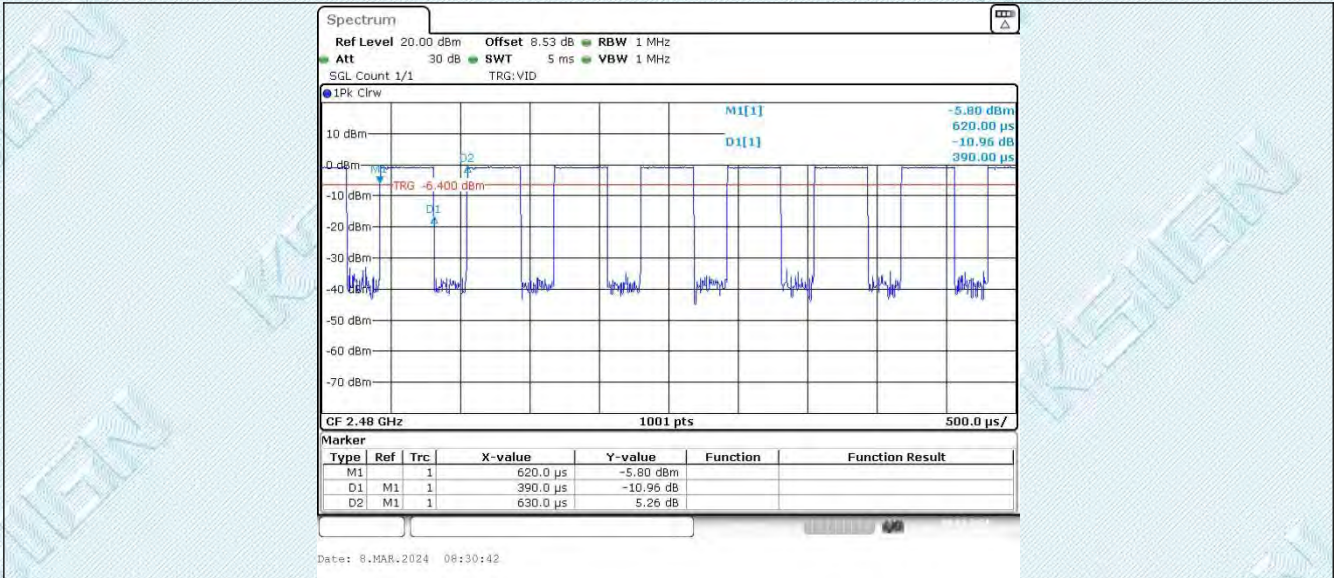

BLE_2M_Ant1_2402

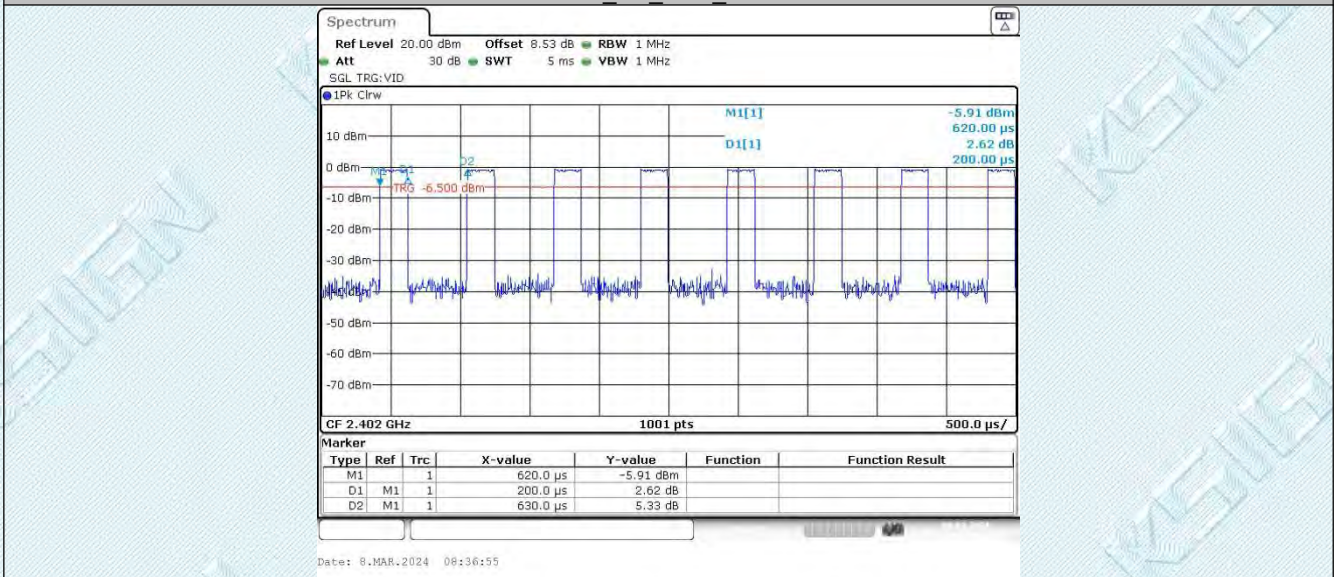

BLE_2M_Ant1_2440

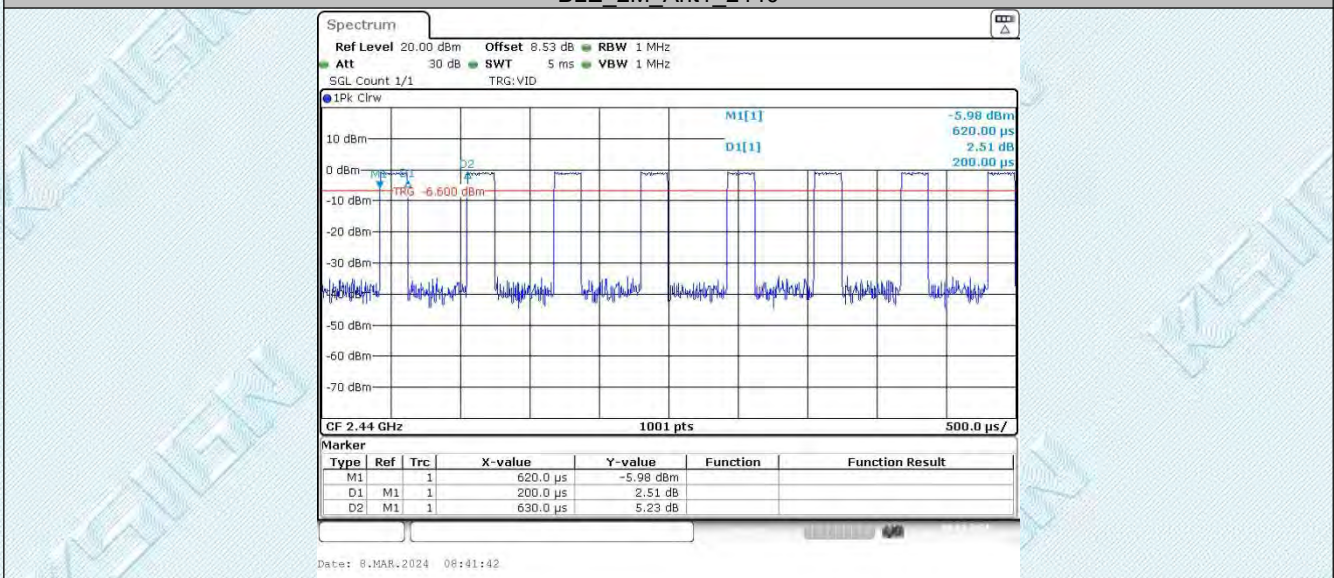

BLE_2M_Ant1_2480

TRF_RF_R1

Add: West Side of 1/F., Building C, Zone A, Fuyuan New Factory, Jiujiu Industrial Park, Minzhu, Shatou, Shajing, Bao'an District, Shenzhen, Guangdong, China

Tel: +(86) 0755-2985 2678 Fax: +(86) 0755-2985 2397 E-mail: info@gdkesign.cn Web: www.gdkesign.com

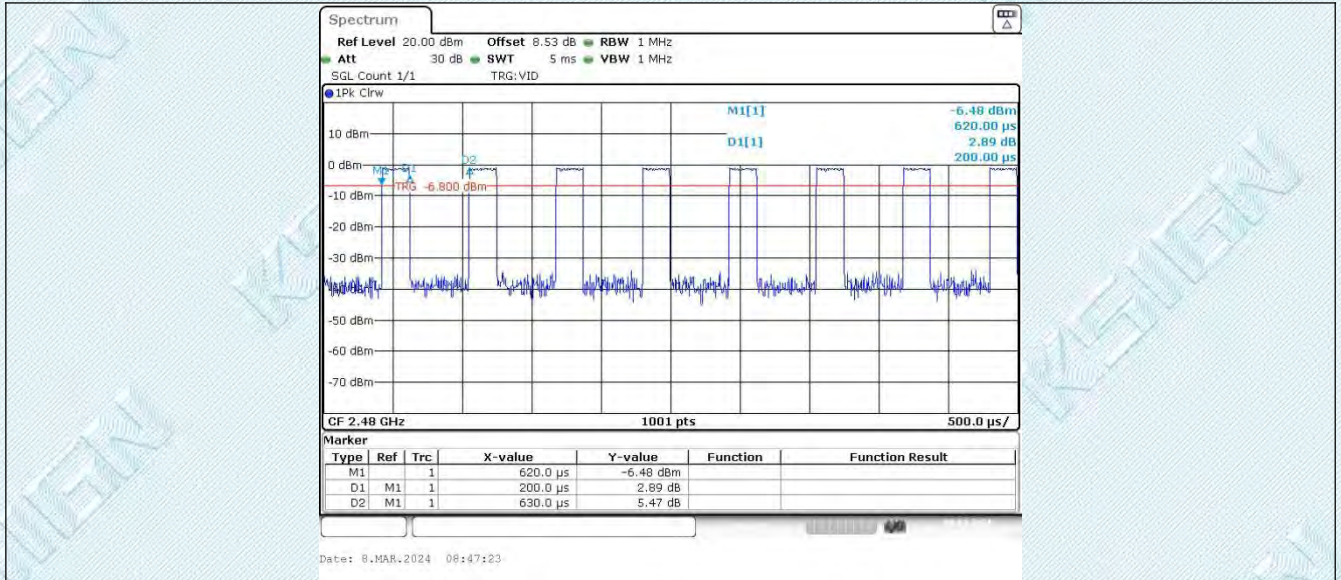

--THE END--

Important Notice

1.	The results are valid only for the samples submitted.
2.	The report is invalid without the "APPROVED" and the "seal for riding".
3.	The test report is invalid without the signatures of Approver, Reviewer and Testing engineer.
4.	The test report can not be partially copied unless prior written approval is issued from our lab.
5.	If the report is not stamped with the CMA seal, it indicates that the report does not have the role of proof for society.
6.	Product information, customer information and sample sources are provided by the client, and we are not responsible for their authenticity;
7.	The test basis or test items marked ★ are not within the scope of CNAS accreditation and CMA accreditation of our laboratory.
8.	The report is invalid when anything of following happens – illegal transfer, reproduce, embezzlement, imposture, modification or tampering in any media form.
9.	If there is any objection to report, the client should inform issuing laboratory within 15 days from the date of.
10.	For cases where compliance is determined based on test values, when relevant specifications, standards, documents, and customers have no relevant requirements and no other special instructions, the test report issued by this laboratory is carried out in full value and adopts ILAC-G8:09 /2019 "Simple Acceptance Rule" for judgment.