

**CFR 47 FCC PART 15 SUBPART C
ISED RSS-247 ISSUE 2 (DTS)**

TEST REPORT

For

portable power station

MODEL NUMBER: SYZ-R2000

Trademark: BougeRV

REPORT NUMBER: E01A23030327F00101

ISSUE DATE: Jun 19, 2023

FCC ID: 2BBH5-SYZ-R2000

IC: 30706-SYZR2000

Prepared for

**Guangzhou Boju Information Technology Co.,Ltd
Unit L3A01-2 No.31, XiCha Road, Baiyun District, Guangzhou, 510407 Guangdong,
CN**

Prepared by

Dong Guan Anci Electronic Technology Co., Ltd.

**1-2 Floor, Building A, No.11, Headquarters 2 Road, Songshan, Lake Hi-
tech Industrial Development Zone, Dongguan City, Guangdong Pr.,
China.**

**This report shall not be reproduced, except in full, without the written approval of
Dong Guan Anci Electronic Technology Co., Ltd.**

Revision History

<u>Rev.</u>	<u>Issue Date</u>	<u>Revisions</u>	<u>Revised By</u>
<u>V0</u>	<u>Jun 19, 2023</u>	<u>Initial Issue</u>	<u>Duke</u>

Summary of Test Results			
Test Item	Clause	Limit/Requirement	Result
Antenna Requirement	N/A	FCC Part 15.203/15.247 (c) RSS-GEN Clause 6.8	Pass
AC Power Line Conducted Emission	ANSI C63.10-2013, Clause 6.2	FCC Part 15.207 RSS-GEN Clause 8.8	Pass
Conducted Output Power	ANSI C63.10-2013, Clause 11.9.1.3	FCC Part 15.247 (b)(3) RSS-247 Clause 5.4 (d)	Pass
6dB Bandwidth and 99% Occupied Bandwidth	ANSI C63.10-2013, Clause 11.8.1	FCC Part 15.247 (a)(2) RSS-247 Clause 5.2 (a) ISED RSS-Gen Clause 6.7	Pass
Power Spectral Density	ANSI C63.10-2013, Clause 11.10.2	FCC Part 15.247 (e) RSS-247 Clause 5.2 (b)	Pass
Conducted Band edge and spurious emission	ANSI C63.10-2013, Clause 11.11	FCC Part 15.247(d) RSS-247 Clause 5.5	Pass
Radiated Band edge and Spurious Emission	ANSI C63.10-2013, Clause 11.11 & Clause 11.12	FCC Part 15.247 (d) FCC Part 15.205/15.209 RSS-247 Clause 5.5 RSS-GEN Clause 8.9	Pass
Duty Cycle	ANSI C63.10-2013, Clause 11.6	None; for reporting purposes only.	Pass

*The measurement result for the sample received is <Pass> according to <CFR 47 FCC PART 15 SUBPART C ISED RSS-247 ISSUE 2 (DTS)> when <Accuracy Method> decision rule is applied.

CONTENTS

1. ATTESTATION OF TEST RESULTS.....	5
2. TEST METHODOLOGY.....	6
3. FACILITIES AND ACCREDITATION.....	6
4. CALIBRATION AND UNCERTAINTY	7
4.1. <i>MEASURING INSTRUMENT CALIBRATION</i>	<i>7</i>
4.2. <i>MEASUREMENT UNCERTAINTY.....</i>	<i>7</i>
5. EQUIPMENT UNDER TEST	8
5.1. <i>DESCRIPTION OF EUT</i>	<i>8</i>
5.2. <i>CHANNEL LIST</i>	<i>8</i>
5.3. <i>Maximum Conducted Output Power.....</i>	<i>9</i>
5.4. <i>TEST CHANNEL CONFIGURATION.....</i>	<i>9</i>
5.5. <i>THE WORSE CASE POWER SETTING PARAMETER.....</i>	<i>9</i>
5.6. <i>DESCRIPTION OF AVAILABLE ANTENNAS</i>	<i>9</i>
5.7. <i>SUPPORT UNITS FOR SYSTEM TEST.....</i>	<i>10</i>
5.8. <i>SETUP DIAGRAM</i>	<i>10</i>
6. MEASURING EQUIPMENT AND SOFTWARE USED.....	11
7. ANTENNA PORT TEST RESULTS	13
7.1. <i>Conducted Output Power.....</i>	<i>13</i>
7.2. <i>6dB Bandwidth and 99% Occupied Bandwidth</i>	<i>14</i>
7.3. <i>Power Spectral Density.....</i>	<i>16</i>
7.4. <i>Conducted Band edge and spurious emission</i>	<i>17</i>
7.5. <i>Duty Cycle</i>	<i>19</i>
8. RADIATED TEST RESULTS	20
9. ANTENNA REQUIREMENT	32
10. AC POWER LINE CONDUCTED EMISSION	33
11. ST DATA	36
APPENDIX: PHOTOGRAPHS OF TEST CONFIGURATION	37
APPENDIX: PHOTOGRAPHS OF THE EUT	39

1. ATTESTATION OF TEST RESULTS

Applicant Information

Company Name: Guangzhou Boju Information Technology Co.,Ltd
Address: Unit L3A01-2 No.31, XiCha Road, Baiyun District, Guangzhou, 510407 Guangdong, CN

Manufacturer Information

Company Name: Guangzhou Boju Information Technology Co.,Ltd
Address: Unit L3A01-2 No.31, XiCha Road, Baiyun District, Guangzhou, 510407 Guangdong, CN

EUT Information

EUT Name: portable power station
Model: SYZ-R2000
Brand: BougeRV
Sample Received Date: Jun 08, 2023
Sample Status: Normal
Sample ID: A23030327 001
Date of Tested: Jun 08, 2023 to Jun 19, 2023

APPLICABLE STANDARDS	
STANDARD	TEST RESULTS
CFR 47 FCC PART 15 SUBPART C ISED RSS-247 ISSUE 2 (DTS)	Pass

Prepared By:



Duke
Project Engineer

Checked By:



Dyson
Project Engineer

Approved By:

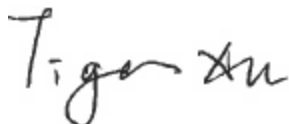

Tiger
Laboratory Supervisor

2. TEST METHODOLOGY

All tests were performed in accordance with the standard CFR 47 FCC PART 15 SUBPART C ISED RSS-247 ISSUE 2 (DTS), SS

3. FACILITIES AND ACCREDITATION

Site Description

Name of Firm : Dong Guan Anci Electronic Technology Co., Ltd.
Site Location : 1-2 Floor, Building A, No.11, Headquarters 2 Road, Songshan,
Lake Hi-tech Industrial Development Zone, Dongguan
City, evelopment Zone, Dongguan City, Guangdong Pr., China.

4. CALIBRATION AND UNCERTAINTY

4.1. MEASURING INSTRUMENT CALIBRATION

The measuring equipment utilized to perform the tests documented in this report has been calibrated in accordance with the manufacturer's recommendations and is traceable to recognized national standards.

4.2. MEASUREMENT UNCERTAINTY

Where relevant, the following measurement uncertainty levels have been estimated for tests performed on the apparatus:

Where relevant, the following measurement uncertainty levels have been estimated for tests performed on the apparatus:

Test Item	Measurement Frequency Range	K	U(dB)
Conducted emissions from the AC mains power ports	0.009 MHz ~ 0.15 MHz	2	4.00
Conducted emissions from the AC mains power ports	0.15 MHz ~ 30 MHz	2	3.62
Radiated emissions	9kHz ~ 30MHz	2	2.20
Radiated emissions	30 MHz ~ 1 GHz	2	3.16
Radiated emissions	1 GHz ~ 18 GHz	2	5.64

Note: This uncertainty represents an expanded uncertainty expressed at approximately the 95% confidence level using a coverage factor of k=2.

5. EQUIPMENT UNDER TEST

5.1. DESCRIPTION OF EUT

EUT Name		portable power station
Model		SYZ-R2000
Hardware Version		V1.2
Software Version		V0.01
Ratings		Capacity: 2008Wh Battery Type: Semi-Solid State AC Input: 90-140V 20A Max AC Charge: 37.6V/40A, 1500W Max Solar Charge: 11V-100V/30A,1500W Max AC Output: 50Hz/60Hz, 2200W Max USB-A Qc3.0: 9V/2A, 18W USB-C Output: 20V/5A, 100W Cigarette Port Output & DC5521(x2): 13.6V/10A,136W Total
Power Supply	AC	120V /60Hz

Frequency Band:	2400 MHz to 2483.5 MHz
Frequency Range:	2402 MHz to 2480 MHz
Bluetooth Version:	Bluetooth 5.2
Bluetooth Mode:	Bluetooth LE/2LE
Type of Modulation:	GFSK, 2GFSK
Number of Channels:	40
Channel Separation:	2 MHz
Maximum Peak Power:	Bluetooth LE: -2.82dBm, Bluetooth 2LE: -2.82dBm
Antenna Type:	PCB Antenna
Antenna Gain:	3.08dBi
Normal Test Voltage:	5 Vdc
EUT Test software:	PhyPlusKit

5.2. CHANNEL LIST

Channel	Frequency (MHz)	Channel	Frequency (MHz)	Channel	Frequency (MHz)	Channel	Frequency (MHz)
0	2402	11	2424	22	2446	33	2468
1	2404	12	2426	23	2448	34	2470
2	2406	13	2428	24	2450	35	2472
3	2408	14	2430	25	2452	36	2474
4	2410	15	2432	26	2454	37	2476
5	2412	16	2434	27	2456	38	2478
6	2414	17	2436	28	2458	39	2480
7	2416	18	2438	29	2460	/	/
8	2418	19	2440	30	2462	/	/

9	2420	20	2442	31	2464	/	/
10	2422	21	2444	32	2468	/	/

5.3. MAXIMUM CONDUCTED OUTPUT POWER

Test Mode	Frequency (MHz)	Channel Number	Maximum Peak Output Power (dBm)	Maximum EIRP (dBm)
LE 1M	2402 ~ 2480	0-39[40]	-2.82	0.26
LE 2M	2402 ~ 2480	0-39[40]	-2.82	0.26

5.4. TEST CHANNEL CONFIGURATION

Test Mode	Test Channel	Frequency
LE 1M	CH 0(Low Channel), CH 19(MID Channel), CH 39(High Channel)	2402 MHz, 2440 MHz, 2480 MHz
LE 2M	CH 0(Low Channel), CH 19(MID Channel), CH 39(High Channel)	2402 MHz, 2440 MHz, 2480 MHz

5.5. THE WORSE CASE POWER SETTING PARAMETER

The Worse Case Power Setting Parameter under 2400 ~ 2483.5MHz Band				
Test Software Version		PhyPlusKit		
Modulation Type	Transmit Antenna Number	Test Software setting value		
		CH 0	CH 19	CH 39
GFSK(1Mbps)	1	default	default	default
GFSK(2Mbps)	1	default	default	default

5.6. DESCRIPTION OF AVAILABLE ANTENNAS

Antenna	Frequency (MHz)	Antenna Type	MAX Antenna Gain (dBi)
1	2402-2480	PCB	3.08

Test Mode	Transmit and Receive Mode	Description
LE 1M	<input checked="" type="checkbox"/> 1TX, 1RX	Antenna 1 can be used as transmitting/receiving antenna.
LE 2M	<input checked="" type="checkbox"/> 1TX, 1RX	Antenna 1 can be used as transmitting/receiving antenna.

5.7. SUPPORT UNITS FOR SYSTEM TEST

Equipment	Manufacturer	Model No.
Test prototype	Boju	SYZ-R2000
PC	Lenovo	T14

5.8. SETUP DIAGRAM

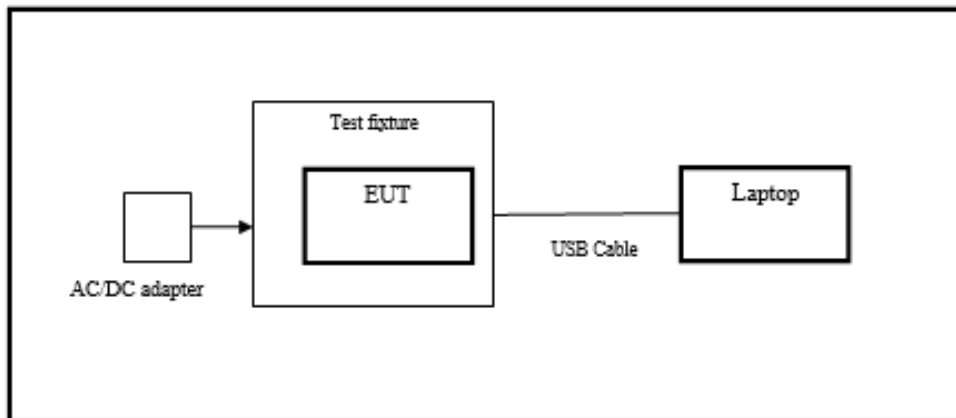

6. MEASURING EQUIPMENT AND SOFTWARE USED

Test Equipment of Conducted RF					
Equipment	Manufacturer	Model No.	Serial No.	Last Cal.	Due Date
Spectrum Analyzer	Rohde & Schwarz	FSV40	US40240623	2022-10-29	2023-10-28
RF Test Software	MWRF-test	MTS 8310	N/A	N/A	N/A
Radio Frequency control box	MWRF-test	MW200-RFCB	MW220111 ANCI	2023/05/10	2024/05/09
Radio Frequency control box	MWRF-test	MW200-RFCB 2#	/	2023/05/10	2024/05/09
Test Equipment of Radiated emissions below 1GHz					
Equipment	Manufacturer	Model No.	Serial No.	Last Cal.	Due Date
EMI Test Receiver	ROHDE&SCHWARZ	ESCI	100302	2023/05/10	2024/05/09
Bilog Antenna	Schwarzbeck	VULB9163	VULB9163-1290	2022/12/12	2023/12/11
RF Cable	ZKJC	ZT06S-NJ-NJ-11M	19060398	2023/05/10	2024/05/09
RF Cable	ZKJC	ZT06S-NJ-NJ-0.5M	19060400	2023/05/10	2024/05/09
RF Cable	ZKJC	ZT06S-NJ-NJ-2.5M	19060404	2023/05/10	2024/05/09
EMI Test Receiver	ROHDE&SCHWARZ	ESPI7	100502	2022/10/8	2023/10/7
3m Semi-anechoic Chamber	Keysight	9m*6m*6m	N/A	2021/11/13	2024/11/12
Test Equipment of Radiated emissions above 1GHz					
Equipment	Manufacturer	Model No.	Serial No.	Last Cal.	Due Date
Low noise Amplifiers	A-INFO	LA1018N4009	J1013130524001	2023/05/10	2024/05/09
Horn antenna	A-INFO	LB-10180-SF	J2031090612123	2023/05/10	2024/05/09
RF Cable	ZKJC	ZT26-NJ-NJ-11M	19060401	2023/05/10	2024/05/09
RF Cable	ZKJC	ZT26-NJ-NJ-2.5M	19060402	2023/05/10	2024/05/09
RF Cable	ZKJC	ZT26-NJ-NJ-0.5M	19060403	2023/05/10	2024/05/09
Spectrum Analyzer	Rohde & Schwarz	FSV40	US40240623	2022-10-29	2023-10-28
3m Semi-anechoic Chamber	Keysight	9m*6m*6m	N/A	2021/11/13	2024/11/12
Test Software	Farad	EZ-EMC (Ver.FA-03A2RE)	N/A	N/A	N/A
Test Equipment of Conducted emissions					

Equipment	Manufacturer	Model No.	Serial No.	Last Cal.	Due Date
EMI Test Receiver	ROHDE&SCHWARZ	ESCI	101358	2023/05/10	2024/05/09
1# Shielded Room	chengyu	8m*4m*3.3m	N/A	2022/11/22	2025/11/21
LISN	ROHDE&SCHWARZ	ENV216	101413	2022/10/8	2023/10/7
Test Software	Farad	EZ-EMC (Ver.ANCI-3A1)	N/A	N/A	N/A
RF Cable	N/A	ZT06S-NJ-NJ-2.5M	19044022	2023/05/10	2024/05/09

7. ANTENNA PORT TEST RESULTS

7.1. CONDUCTED OUTPUT POWER

LIMITS

CFR 47 FCC Part15 (15.247) Subpart C ISED RSS-247 ISSUE 2			
Section	Test Item	Limit	Frequency Range (MHz)
CFR 47 FCC 15.247(b)(3) ISED RSS-247 5.4 (d)	Peak Conduct Output Power	1 watt or 30 dBm	2400-2483.5

TEST PROCEDURE

Connect the EUT to a low loss RF cable from the antenna port to the power sensor (video bandwidth is greater than the occupied bandwidth).

Measure peak emission level, the indicated level is the peak output power, after any corrections for external attenuators and cables.

TEST ENVIRONMENT

Temperature	23.6°C	Relative Humidity	53%
Atmosphere Pressure	101kPa		

TEST RESULTS

Please refer to section "Test Data" - Appendix B

7.2. 6DB BANDWIDTH AND 99% OCCUPIED BANDWIDTH

LIMITS

CFR 47 FCC Part15 (15.247) Subpart C ISED RSS-247 ISSUE 2			
Section	Test Item	Limit	Frequency Range (MHz)
CFR 47 FCC 15.247(a)(2) ISED RSS-247 5.2 (a)	6 dB Bandwidth	≥ 500 kHz	2400-2483.5
ISED RSS-Gen Clause 6.7	99 % Occupied Bandwidth	For reporting purposes only.	2400-2483.5

TEST PROCEDURE

Refer to ANSI C63.10-2013 clause 11.8 for DTS bandwidth and clause 6.9 for Occupied Bandwidth.

Connect the EUT to the spectrum analyser and use the following settings:

Center Frequency	The center frequency of the channel under test
Frequency Span	For 6 dB Bandwidth: Enough to capture all products of the modulation carrier emission For 99 % Occupied Bandwidth: Between 1.5 times and 5.0 times the OBW
Detector	Peak
RBW	For 6 dB Bandwidth: 100 kHz For 99 % Occupied Bandwidth: 1 % to 5 % of the occupied bandwidth
VBW	For 6 dB Bandwidth: $\geq 3 \times$ RBW For 99 % Occupied Bandwidth: $\geq 3 \times$ RBW
Trace	Max hold
Sweep	Auto couple

a) Use the 99 % power bandwidth function of the instrument, allow the trace to stabilize and report the measured bandwidth.

b) Allow the trace to stabilize and measure the maximum width of the emission that is constrained by the frequencies associated with the two outermost amplitude points (upper and lower frequencies) that are attenuated by 6 dB relative to the maximum level measured in the fundamental emission.

TEST ENVIRONMENT

Temperature	23.6°C	Relative Humidity	53%
Atmosphere Pressure	101kPa		

TEST RESULTS

Please refer to section "Test Data" - Appendix B

7.3. POWER SPECTRAL DENSITY

LIMITS

CFR 47 FCC Part15 (15.247) Subpart C ISED RSS-247 ISSUE 2			
Section	Test Item	Limit	Frequency Range (MHz)
CFR 47 FCC §15.247 (e) ISED RSS-247 5.2 (b)	Power Spectral Density	8 dBm in any 3 kHz band	2400-2483.5

TEST PROCEDURE

Refer to ANSI C63.10-2013 clause 11.10.

Connect the EUT to the spectrum analyser and use the following settings:

Center Frequency	The center frequency of the channel under test
Detector	PEAK
RBW	$3 \text{ kHz} \leq \text{RBW} \leq 100 \text{ kHz}$
VBW	$\geq 3 \times \text{RBW}$
Span	1.5 x DTS bandwidth
Trace	Max hold
Sweep time	Auto couple

Allow trace to fully stabilize and use the peak marker function to determine the maximum amplitude level within the RBW.

If measured value exceeds limit, reduce RBW (no less than 3 kHz) and repeat.

TEST ENVIRONMENT

Temperature	23.6°C	Relative Humidity	53%
Atmosphere Pressure	101kPa		

TEST RESULTS

Please refer to section "Test Data" - Appendix B

7.4. CONDUCTED BAND EDGE AND SPURIOUS EMISSION

LIMITS

CFR 47 FCC Part15 (15.247) Subpart C ISED RSS-247 ISSUE 2		
Section	Test Item	Limit
CFR 47 FCC §15.247 (d) ISED RSS-247 5.5	Conducted Bandedge and Spurious Emissions	at least 20 dB below that in the 100 kHz bandwidth within the band that contains the highest level of the desired power

TEST PROCEDURE

Refer to ANSI C63.10-2013 clause 11.11 and 11.13.

Connect the EUT to the spectrum analyser and use the following settings for reference level measurement:

Center Frequency	The center frequency of the channel under test
Detector	Peak
RBW	100 kHz
VBW	$\geq 3 \times \text{RBW}$
Span	1.5 x DTS bandwidth
Trace	Max hold
Sweep time	Auto couple.

Allow trace to fully stabilize and use the peak marker function to determine the maximum PSD level.

Change the settings for emission level measurement:

Span	Set the center frequency and span to encompass frequency range to be measured
Detector	Peak
RBW	100 kHz
VBW	$\geq 3 \times \text{RBW}$
measurement points	$\geq \text{span}/\text{RBW}$
Trace	Max hold
Sweep time	Auto couple.

Allow trace to fully stabilize and use the peak marker function to determine the maximum PSD level. Ensure that the amplitude of all unwanted emissions outside of the authorized frequency band (excluding restricted frequency bands) is attenuated by at least the minimum requirements specified in 11.11.

TEST ENVIRONMENT

Temperature	23.6°C	Relative Humidity	53%
Atmosphere Pressure	101kPa		

TEST RESULTS

Please refer to section "Test Data" - Appendix B

7.5. DUTY CYCLE

LIMITS

None; for reporting purposes only.

TEST PROCEDURE

Refer to ANSI C63.10-2013 clause 11.6 Zero – Span Spectrum Analyzer method.

TEST ENVIRONMENT

Temperature	23.6°C	Relative Humidity	53%
Atmosphere Pressure	101kPa		

TEST RESULTS

Please refer to section "Test Data" - Appendix B

8. RADIATED TEST RESULTS

LIMITS

Please refer to CFR 47 FCC §15.205 and §15.209.

Please refer to ISED RSS-GEN Clause 8.9 and Clause 8.10.

Radiation Disturbance Test Limit for FCC (Class B) (9 kHz ~ 1 GHz)

Emissions radiated outside of the specified frequency bands above 30 MHz			
Frequency Range (MHz)	Field Strength Limit (uV/m) at 3 m	Field Strength Limit (dBuV/m) at 3 m	
		Quasi-Peak	
30 - 88	100	40	
88 - 216	150	43.5	
216 - 960	200	46	
Above 960	500	54	
Above 1000	500	Peak	Average
		74	54

FCC Emissions radiated outside of the specified frequency bands below 30 MHz		
Frequency (MHz)	Field strength (microvolts/meter)	Measurement distance (meters)
0.009-0.490	2400/F(kHz)	300
0.490-1.705	24000/F(kHz)	30
1.705-30.0	30	30

ISED General field strength limits at frequencies below 30 MHz

Table 6 – General field strength limits at frequencies below 30 MHz		
Frequency	Magnetic field strength (H-Field) (µA/m)	Measurement distance (m)
9 - 490 kHz ^{Note 1}	6.37/F (F in kHz)	300
490 - 1705 kHz	63.7/F (F in kHz)	30
1.705 - 30 MHz	0.08	30

Note 1: The emission limits for the ranges 9-90 kHz and 110-490 kHz are based on measurements employing a linear average detector.

ISED Restricted bands please refer to ISED RSS-GEN Clause 8.10

Table 7 – Restricted frequency bands ^{Note 1}		
MHz	MHz	GHz
0.090 - 0.110	149.9 - 150.05	9.0 - 9.2
0.495 - 0.505	156.52475 - 156.52525	9.3 - 9.5
2.1735 - 2.1905	156.7 - 156.9	10.6 - 12.7
3.020 - 3.026	162.0125 - 167.17	13.25 - 13.4
4.125 - 4.128	167.72 - 173.2	14.47 - 14.5
4.17725 - 4.17775	240 - 285	15.35 - 16.2
4.20725 - 4.20775	322 - 335.4	17.7 - 21.4
5.677 - 5.683	399.9 - 410	22.01 - 23.12
6.215 - 6.218	608 - 614	23.6 - 24.0
6.26775 - 6.26825	960 - 1427	31.2 - 31.8
6.31175 - 6.31225	1435 - 1626.5	36.43 - 36.5
8.291 - 8.294	1645.5 - 1646.5	Above 38.6
8.362 - 8.366	1660 - 1710	
8.37625 - 8.38675	1718.8 - 1722.2	
8.41425 - 8.41475	2200 - 2300	
12.29 - 12.293	2310 - 2390	
12.51975 - 12.52025	2483.5 - 2500	
12.57675 - 12.57725	2655 - 2900	
13.36 - 13.41	3260 - 3267	
16.42 - 16.423	3332 - 3339	
16.80475 - 16.80525	3345.8 - 3358	
16.80425 - 16.80475	3500 - 4400	
25.5 - 25.67	4500 - 5150	
37.5 - 38.25	5350 - 5460	
73 - 74.6	7250 - 7750	
74.8 - 75.2	8025 - 8500	
108 - 138		

Note 1: Certain frequency bands listed in table 7 and in bands above 38.6 GHz are designated for licence-exempt applications. These frequency bands and the requirements that apply to related devices are set out in the 200 and 300 series of RSSs.

FCC Restricted bands of operation refer to FCC §15.205 (a):

MHz	MHz	MHz	GHz
0.090-0.110	16.42-16.423	399.9-410	4.5-5.15
¹ 0.495-0.505	16.69475-16.69525	608-614	5.35-5.46
2.1735-2.1905	16.80425-16.80475	960-1240	7.25-7.75
4.125-4.128	25.5-25.67	1300-1427	8.025-8.5
4.17725-4.17775	37.5-38.25	1435-1626.5	9.0-9.2
4.20725-4.20775	73-74.6	1645.5-1646.5	9.3-9.5
6.215-6.218	74.8-75.2	1660-1710	10.6-12.7
6.26775-6.26825	108-121.94	1718.8-1722.2	13.25-13.4
6.31175-6.31225	123-138	2200-2300	14.47-14.5
8.291-8.294	149.9-150.05	2310-2390	15.35-16.2
8.362-8.366	156.52475-156.52525	2483.5-2500	17.7-21.4
8.37625-8.38675	156.7-156.9	2690-2900	22.01-23.12
8.41425-8.41475	162.0125-167.17	3260-3267	23.6-24.0
12.29-12.293	167.72-173.2	3332-3339	31.2-31.8
12.51975-12.52025	240-285	3345.8-3358	36.43-36.5
12.57675-12.57725	322-335.4	3600-4400	(²)
13.36-13.41			

Note: ¹Until February 1, 1999, this restricted band shall be 0.490-0.510 MHz.

²Above 38.6c

TEST PROCEDURE

Below 30 MHz

The setting of the spectrum analyser

RBW	200 Hz (From 9 kHz to 0.15 MHz)/ 9 kHz (From 0.15 MHz to 30 MHz)
VBW	200 Hz (From 9 kHz to 0.15 MHz)/ 9 kHz (From 0.15 MHz to 30 MHz)
Sweep	Auto

1. The testing follows the guidelines in ANSI C63.10-2013 clause 6.4.
2. The EUT was arranged to its worst case and then turntable (from 0 degree to 360 degrees) to find the maximum reading. A pre-amp and a high pass filter are used for the test in order to get better signal level. Both Horizontal, Face-on and Face-off polarizations of the antenna are set to make the measurement.
3. The EUT was placed on a turntable with 80 cm above ground.
4. The EUT was set 3 meters from the interference receiving antenna, which was mounted on the top of a 1 m height antenna tower.
5. The radiated emission limits are based on measurements employing a CISPR quasi-peak detector except for the frequency bands 9-90 kHz, 110-490 kHz and above 1000 MHz Radiated emission limits in these three bands are based on measurements employing an average detector.
6. For measurement below 1 GHz, the initial step in collecting conducted emission data is a spectrum analyzer peak detector mode pre-scanning the measurement frequency range. Significant peaks are then marked and then Quasi Peak and average detector mode re-measured. If the emission level of the EUT measured by the peak detector is 3 dB lower than the applicable limit, the peak emission level will be reported. Otherwise, the emission measurement will be repeated using the quasi-peak and average detector and reported.
7. Although these tests were performed other than open field site, adequate comparison measurements were confirmed against 30m open field site. Therefore sufficient tests were made to demonstrate that the alternative site produces results that correlate with the ones of tests made in an open field site based on KDB 414788.
8. The limits in CFR 47, Part 15, Subpart C, paragraph 15.209 (a), are identical to those in RSS-GEN Section 8.9, Table 6, since the measurements are performed in terms of magnetic field strength and converted to electric field strength levels (as reported in the table) using the free space impedance of 377Ω . For example, the measurement frequency X KHz resulted in a level of Y dBuV/m, which is equivalent to $Y-51.5 = Z$ dBuA/m, which has the same margin, W dB, to the corresponding RSS-GEN Table 6 limit as it has to be 15.209(a) limit.

Below 1 GHz and above 30 MHz

The setting of the spectrum analyser

RBW	120 kHz
VBW	300 kHz
Sweep	Auto
Detector	Peak/QP
Trace	Max hold

1. The testing follows the guidelines in ANSI C63.10-2013 clause 6.5.

2. The EUT was arranged to its worst case and then tune the antenna tower (from 1 m to 4 m) and turntable (from 0 degree to 360 degrees) to find the maximum reading. A pre-amp and a high pass filter are used for the test in order to get better signal level. Both horizontal and vertical polarizations of the antenna are set to make the measurement.
3. The EUT was placed on a turntable with 80 cm above ground.
4. The EUT was set 3 meters from the interference receiving antenna, which was mounted on the top of a variable height antenna tower.
5. For measurement below 1 GHz, the initial step in collecting conducted emission data is a spectrum analyzer peak detector mode pre-scanning the measurement frequency range. Significant peaks are then marked and then Quasi Peak detector mode re-measured. If the emission level of the EUT measured by the peak detector is 3 dB lower than the applicable limit, the peak emission level will be reported. Otherwise, the emission measurement will be repeated using the quasi-peak detector and reported.

Above 1G

The setting of the spectrum analyser

RBW	1 MHz
VBW	PEAK: 3 MHz AVG: see note 6
Sweep	Auto
Detector	Peak
Trace	Max hold

1. The testing follows the guidelines in ANSI C63.10-2013 clause 6.6.
2. The EUT was arranged to its worst case and then tune the antenna tower (from 1 m to 4 m) and turntable (from 0 degree to 360 degrees) to find the maximum reading. A pre-amp and a high pass filter are used for the test in order to get better signal level. Both horizontal and vertical polarizations of the antenna are set to make the measurement.
3. The EUT was placed on a turntable with 1.5 m above ground.
4. The EUT was set 3 meters from the interference receiving antenna, which was mounted on the top of a variable height antenna tower.
5. For measurement above 1 GHz, the emission measurement will be measured by the peak detector. This peak level, once corrected, must comply with the limit specified in Section 15.209.
6. For measurements above 1 GHz the resolution bandwidth is set to 1 MHz, then the video bandwidth is set to 3 MHz for peak measurements and 1 MHz resolution bandwidth with 1/T video bandwidth with peak detector for average measurements. For the Duty Cycle please refer to clause 7.1.ON TIME AND DUTY CYCLE.

X axis, Y axis, Z axis positions:

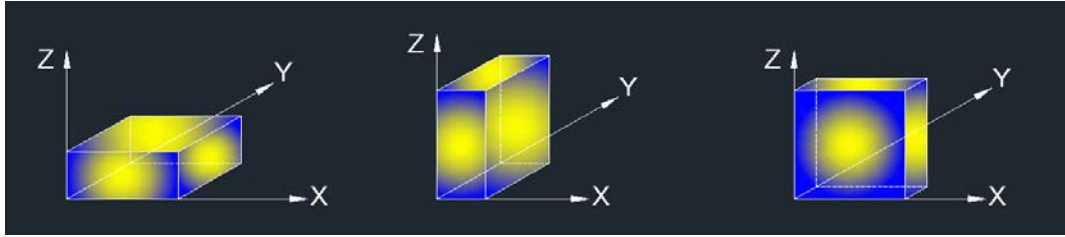

Note 1: For all radiated test, EUT in each of three orthogonal axis emissions had been tested, but only the worst case (X axis) data recorded in the report.

TEST ENVIRONMENT

Temperature	23.6°C	Relative Humidity	53%
Atmosphere Pressure	101kPa		

TEST RESULTS

Radiated Spurious Emission :

The data of the mode (GFSK 2402MHz) are recorded in the following pages.

The worst result as bellow:

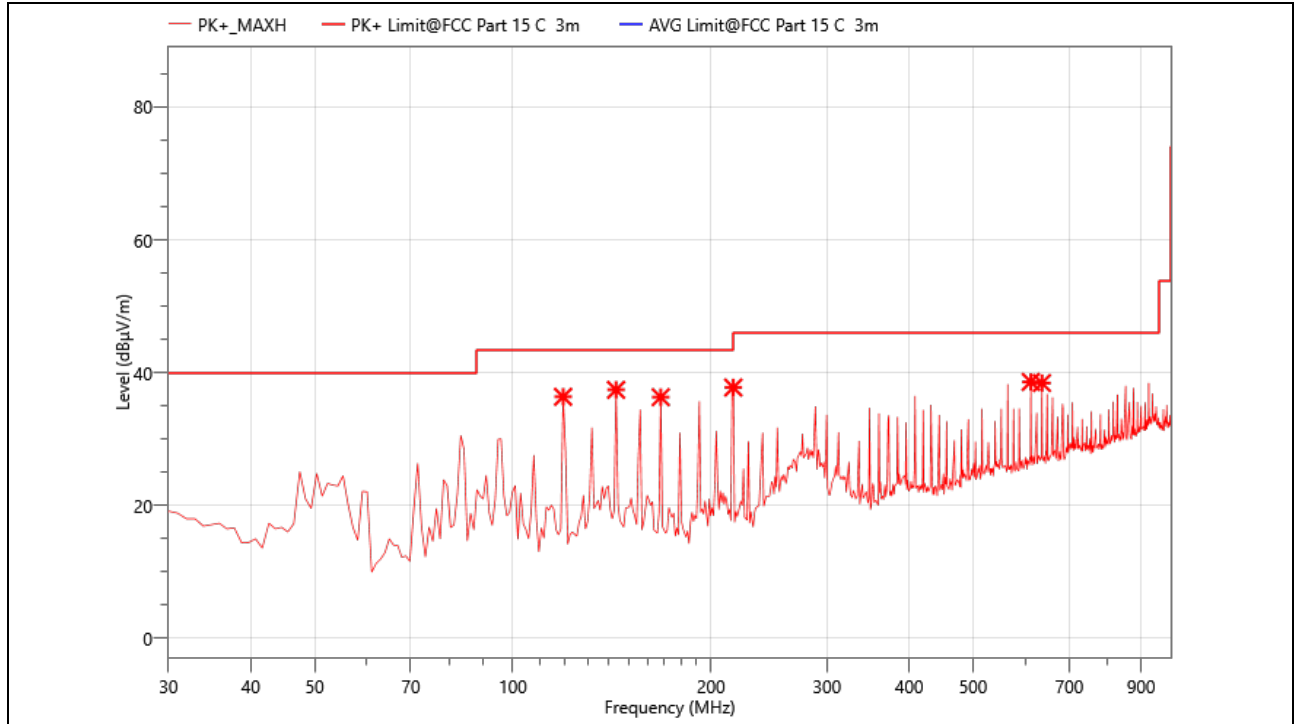

Site:		Antenna: Horizontal	Temperature(C): 24.3°C
Limit:	FCC Part 15 C 3m Radiation(QP)		Humidity(%):54%
EUT:	Portable power station	Test Time:	2023-06-10
M/N.:	SYZ-R2000	Power Rating:	DC 5V
Mode:	TX2402	Test Engineer:	Big
Note:			

No.	Freq. (MHz)	Reading (dBµV)	Meas. (dBµV/m)	Limit (dBµV/m)	Margin (dBµV/m)	Det.	Pol.	Corr. (dB)
1	119.240	54.83	36.38	43.50	7.12	QP	H	-18.45
2	143.490	54.34	37.43	43.50	6.07	QP	H	-16.91
3	167.740	52.52	36.32	43.50	7.18	QP	H	-16.2
4	216.240	52.41	37.78	46.00	8.22	QP	H	-14.63
5	612.000	41.56	38.62	46.00	7.38	QP	H	-2.94
6	636.250	40.81	38.45	46.00	7.55	QP	H	-2.36

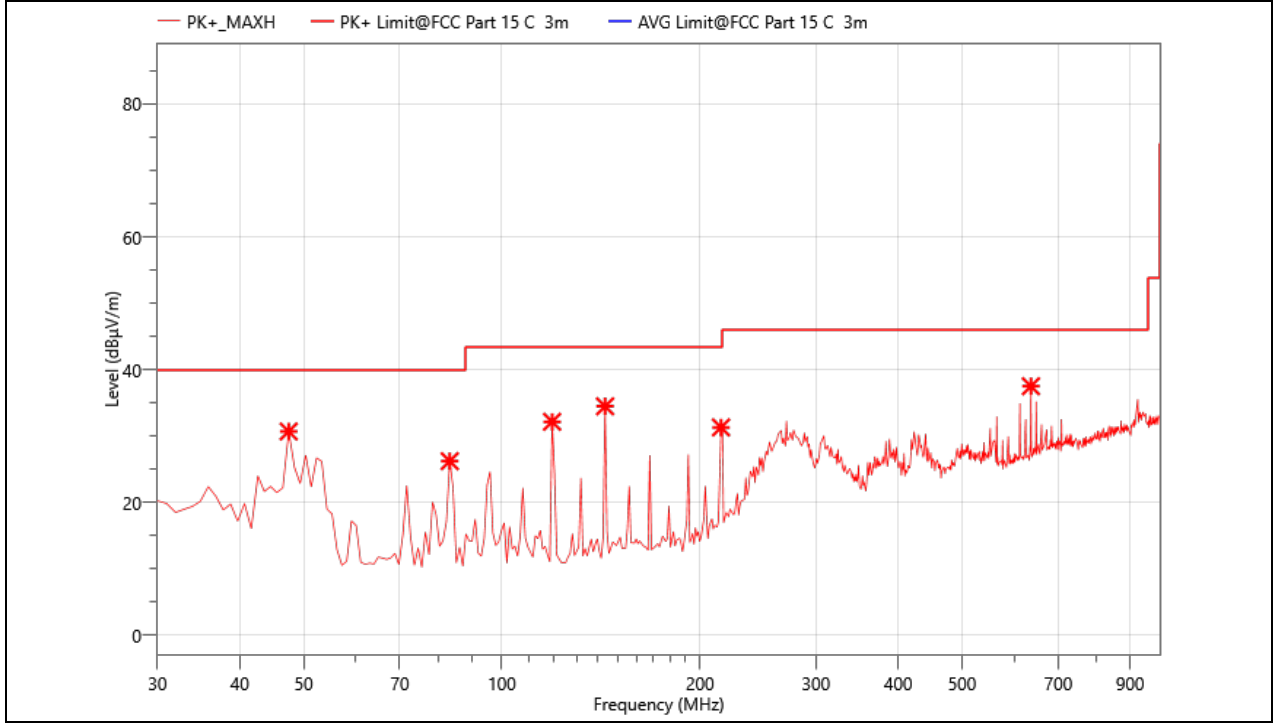

Site:	ChamberA-2	Antenna: Vertical	Temperature(C): 24.3(C)
Limit:	FCC Part 15 C 3m Radiation(QP)	Test Time:	Humidity(%): 54%
EUT:	Portable power station	Power Rating:	DC 5V
M/N.:	SYZ-R2000	Test Engineer:	Big
Mode:	TX2402		
Note:			

No.	Freq. (MHz)	Reading (dBµ V)	Meas. (dBµ V/m)	Limit (dBµ V/m)	Margin (dBµ V/m)	Det.	Pol.	Corr. (dB)
1	47.460	47.86	30.71	40.00	9.29	QP	V	-17.15
2	83.350	45.49	26.24	40.00	13.76	QP	V	-19.25
3	119.240	50.61	32.16	43.50	11.34	QP	V	-18.45
4	143.490	51.41	34.50	43.50	9.00	QP	V	-16.91
5	215.270	46.05	31.32	43.50	12.18	QP	V	-14.73
6	636.250	39.88	37.52	46.00	8.48	QP	V	-2.36

Note: 1. Result Level = Read Level+ Antenna Factor+ Cable Loss- Amp. Factor

Above 1000MHz~10th Harmonics:

Operation Mode: TX Mode (2402MHz) Test Date : 2023-06-10
 Frequency Range: 1-18GHz Temperature : 24.3°C
 Test Result: PASS Humidity : 54 %
 Measured Distance: 3m Test By: Big

Freq. (MHz)	Reading (dB μ V)	Meas. (dB μ V/m)	Limit (dB μ V/m)	Margin (dB μ V/m)	Det.	Pol.	Corr. (dB)
2132.000	55.09	46.04	74.00	27.96	PK+	V	-9.05
2918.000	53.91	46.28	74.00	27.72	PK+	V	-7.63
4804.500	60.54	49.20	74.00	24.80	PK+	V	-11.34
7206.000	57.01	50.60	74.00	23.40	PK+	V	-6.41
11622.000	50.56	49.38	74.00	24.62	PK+	V	-1.18
17437.500	47.05	53.70	74.00	20.30	PK+	V	6.65
2370.000	56.79	48.33	74.00	25.67	PK+	H	-8.46
2532.000	56.80	48.19	74.00	25.81	PK+	H	-8.61
4804.500	63.87	52.53	74.00	21.47	PK+	H	-11.34
6372.000	52.58	45.90	74.00	28.10	PK+	H	-6.68
7206.000	59.78	53.37	74.00	20.63	PK+	H	-6.41
13180.500	49.49	49.13	74.00	24.87	PK+	H	-0.36

Other harmonics emissions are lower than 20dB below the allowable limit.

Note: (1) All Readings are Peak Value and AV.

(2) Emission Level= Reading Level+ Probe Factor +Cable Loss.

(3) The average measurement was not performed when the peak measured data under the limit of average detection.

(4) Measuring frequencies from 1GHz to 25GHz.

Operation Mode: TX Mode (2440MHz) Test Date : 2023-06-10
 Frequency Range: 1-18GHz Temperature : 24.3°C
 Test Result: PASS Humidity : 54 %
 Measured Distance: 3m Test By: Big

Freq. (MHz)	Reading (dB μ V)	Meas. (dB μ V/m)	Limit (dB μ V/m)	Margin (dB μ V/m)	Det.	Pol.	Corr. (dB)
2308.000	52.99	44.19	74.00	29.81	PK+	V	-8.8
2830.000	53.39	45.63	74.00	28.37	PK+	V	-7.76
4804.500	61.12	49.78	74.00	24.22	PK+	V	-11.34
7207.500	57.13	50.74	74.00	23.26	PK+	V	-6.39
10446.000	51.14	48.27	74.00	25.73	PK+	V	-2.87
11214.000	49.04	48.52	74.00	25.48	PK+	V	-0.52
2388.000	56.21	47.68	74.00	26.32	PK+	H	-8.53
2910.000	53.11	45.42	74.00	28.58	PK+	H	-7.69
4804.500	63.25	51.91	74.00	22.09	PK+	H	-11.34
6211.500	52.67	45.32	74.00	28.68	PK+	H	-7.35
7206.000	59.91	53.50	74.00	20.50	PK+	H	-6.41
11097.000	50.06	49.24	74.00	24.76	PK+	H	-0.82

Other harmonics emissions are lower than 20dB below the allowable limit.

Note: (1) All Readings are Peak Value and AV.

(2) Emission Level= Reading Level+ Probe Factor +Cable Loss.

(3) The average measurement was not performed when the peak measured data under the limit of average detection.

(4) Measuring frequencies from 1GHz to 25GHz.

Operation Mode: TX Mode (2480MHz) Test Date : 2023-06-10
 Frequency Range: 1-18GHz Temperature : 24.3°C
 Test Result: PASS Humidity : 54 %
 Measured Distance: 3m Test By: Big

Freq. (MHz)	Reading (dB μ V)	Meas. (dB μ V/m)	Limit (dB μ V/m)	Margin (dB μ V/m)	Det.	Pol.	Corr. (dB)
2142.000	54.10	45.05	74.00	28.95	PK+	V	-9.05
2504.000	53.55	45.14	74.00	28.86	PK+	V	-8.41
2942.000	52.66	45.19	74.00	28.81	PK+	V	-7.47
4804.500	60.21	48.87	74.00	25.13	PK+	V	-11.34
7207.500	57.35	50.96	74.00	23.04	PK+	V	-6.39
11202.000	49.00	48.23	74.00	25.77	PK+	V	-0.77
2388.000	56.57	48.04	74.00	25.96	PK+	H	-8.53
2978.000	52.99	45.97	74.00	28.03	PK+	H	-7.02
4804.500	62.79	51.45	74.00	22.55	PK+	H	-11.34
7206.000	59.78	53.37	74.00	20.63	PK+	H	-6.41
11385.000	50.14	49.41	74.00	24.59	PK+	H	-0.73
12316.500	50.38	49.88	74.00	24.12	PK+	H	-0.5

Other harmonics emissions are lower than 20dB below the allowable limit.

- Note:** (1) All Readings are Peak Value and AV.
 (2) Emission Level= Reading Level+ Probe Factor +Cable Loss.
 (3) The average measurement was not performed when the peak measured data under the limit of average detection.
 (4) Measuring frequencies from 1GHz to 25GHz.

Band edge:
 TX Mode (2402MHz)

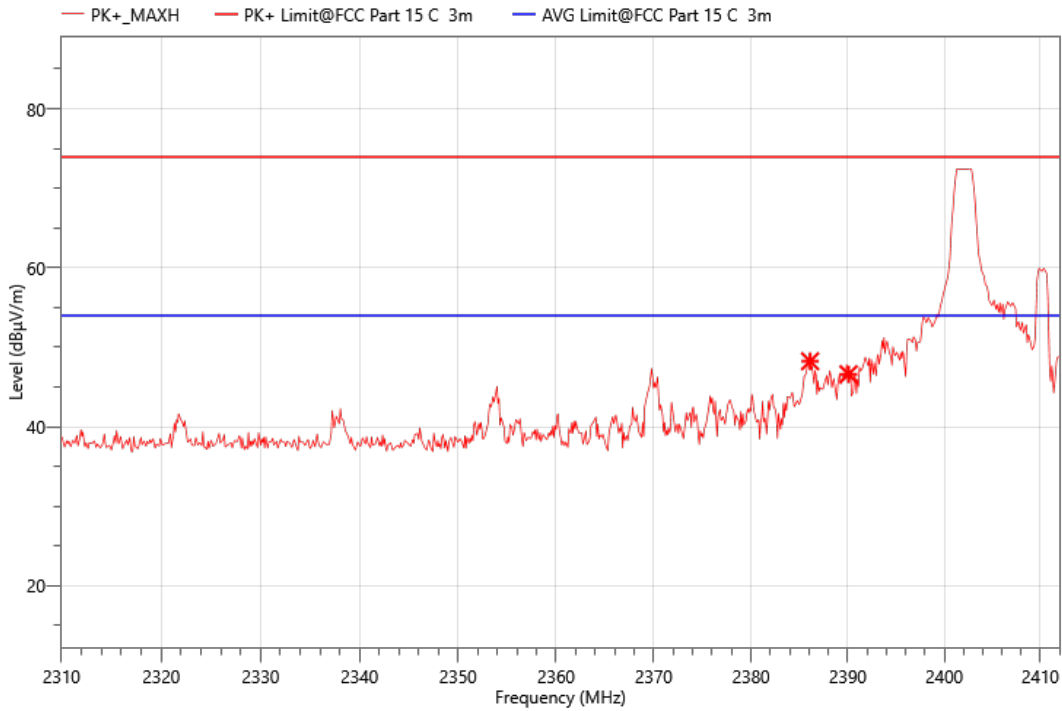

Freq. (MHz)	Reading (dBµV)	Meas. (dBµV/m)	Limit (dBµV/m)	Margin (dBµV/m)	Det.	Pol.	Corr. (dB)
2386.092	66.24	48.24	74.00	25.76	PK+	H	-18
2390.070	64.59	46.60	74.00	27.40	PK+	H	-17.99

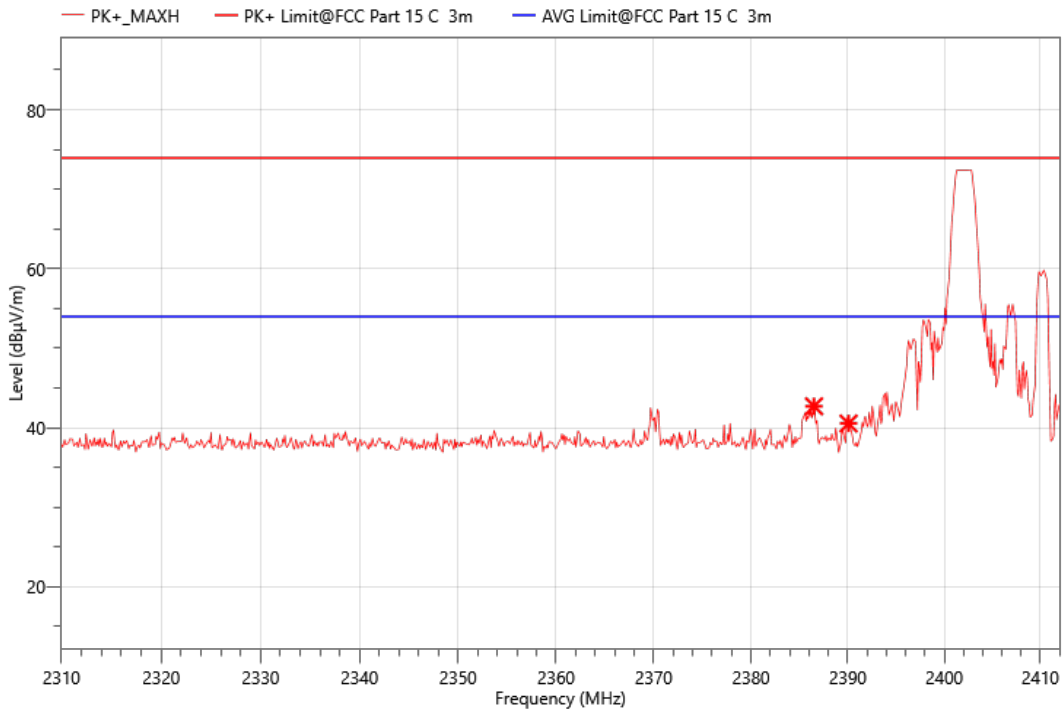

Freq. (MHz)	Reading (dBµV)	Meas. (dBµV/m)	Limit (dBµV/m)	Margin (dBµV/m)	Det.	Pol.	Corr. (dB)
2386.500	60.70	42.70	74.00	31.30	PK+	V	-18
2390.070	58.53	40.54	74.00	33.46	PK+	V	-17.99

Battery 3.7V

TX Mode (2480MHz)



Freq. (MHz)	Reading (dBµV)	Meas. (dBµV/m)	Limit (dBµV/m)	Margin (dBµV/m)	Det.	Pol.	Corr. (dB)
2483.390	61.99	44.28	74.00	29.72	PK+	V	-17.71
2492.084	63.96	46.27	74.00	27.73	PK+	V	-17.69

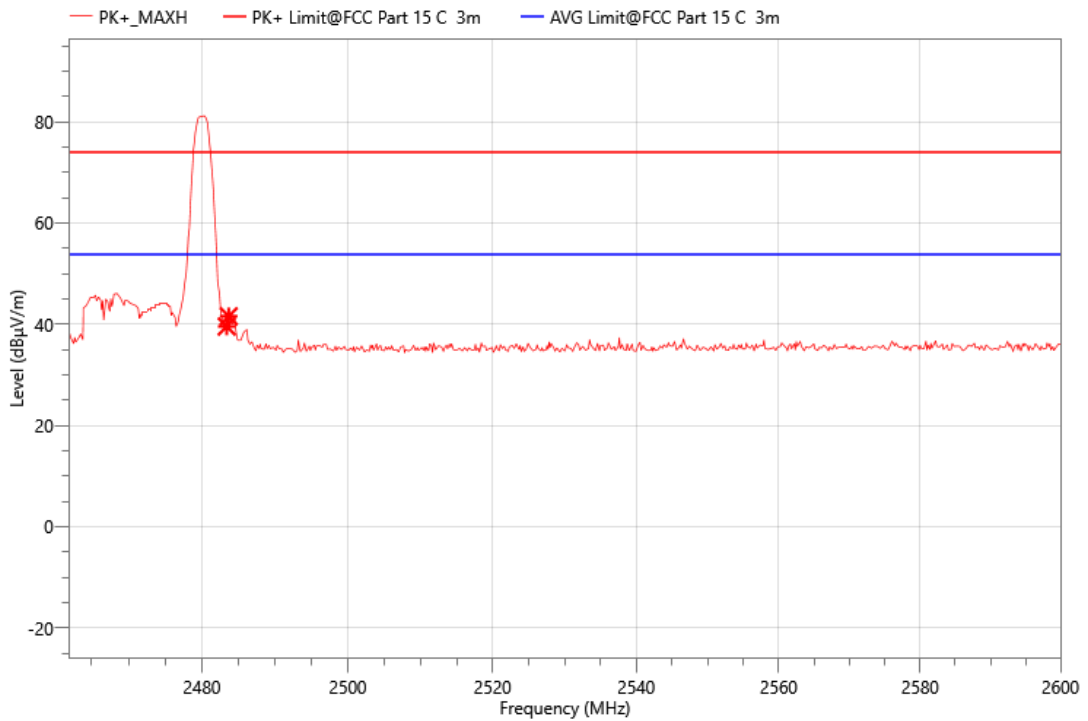

Freq. (MHz)	Reading (dBµV)	Meas. (dBµV/m)	Limit (dBµV/m)	Margin (dBµV/m)	Det.	Pol.	Corr. (dB)
2483.390	57.25	39.54	74.00	34.46	PK+	H	-17.71
2483.666	59.27	41.56	74.00	32.44	PK+	H	-17.71

9. ANTENNA REQUIREMENT

REQUIREMENT

The EUT'S antenna is met the requirement of FCC part 15C section 15.203 and 15.247 and RSS-Gen issue 5 6.8.

FCC part 15C section 15.247 and RSS 247 requirements:

Systems operating in the 2402-2480MHz band that are used exclusively for fixed, point-to-point operations may employ transmitting antennas with directional gain greater than 6dBi provided the maximum peak output power of the intentional radiator is reduced by 1dB for every 3dB that the directional gain of the antenna exceeds 6dBi.

DESCRIPTION

Pass

10. AC POWER LINE CONDUCTED EMISSION

LIMITS

Please refer to CFR 47 FCC §15.207 (a) and ISED RSS-Gen Clause 8.8

FREQUENCY (MHz)	Quasi-peak	Average
0.15 -0.5	66 - 56 *	56 - 46 *
0.50 -5.0	56.00	46.00
5.0 -30.0	60.00	50.00

TEST PROCEDURE

The EUT is put on a table of non-conducting material that is 80 cm high. The vertical conducting wall of shielding is located 40 cm to the rear of the EUT. The power line of the EUT is connected to the AC mains through a Artificial Mains Network (A.M.N.). A EMI Measurement Receiver (R&S Test Receiver ESR3) is used to test the emissions from both sides of AC line. According to the requirements in Section 6.2 of ANSI C63.10-2013. Conducted emissions from the EUT measured in the frequency range between 0.15 MHz and 30 MHz using CISPR Quasi-Peak and average detector mode. The bandwidth of EMI test receiver is set at 9 kHz.

The arrangement of the equipment is installed to meet the standards and operating in a manner, which tends to maximize its emission characteristics in a normal application.

TEST ENVIRONMENT

Temperature	23.5°C	Relative Humidity	52.6%
Atmosphere Pressure	101kPa		

TEST RESULTS

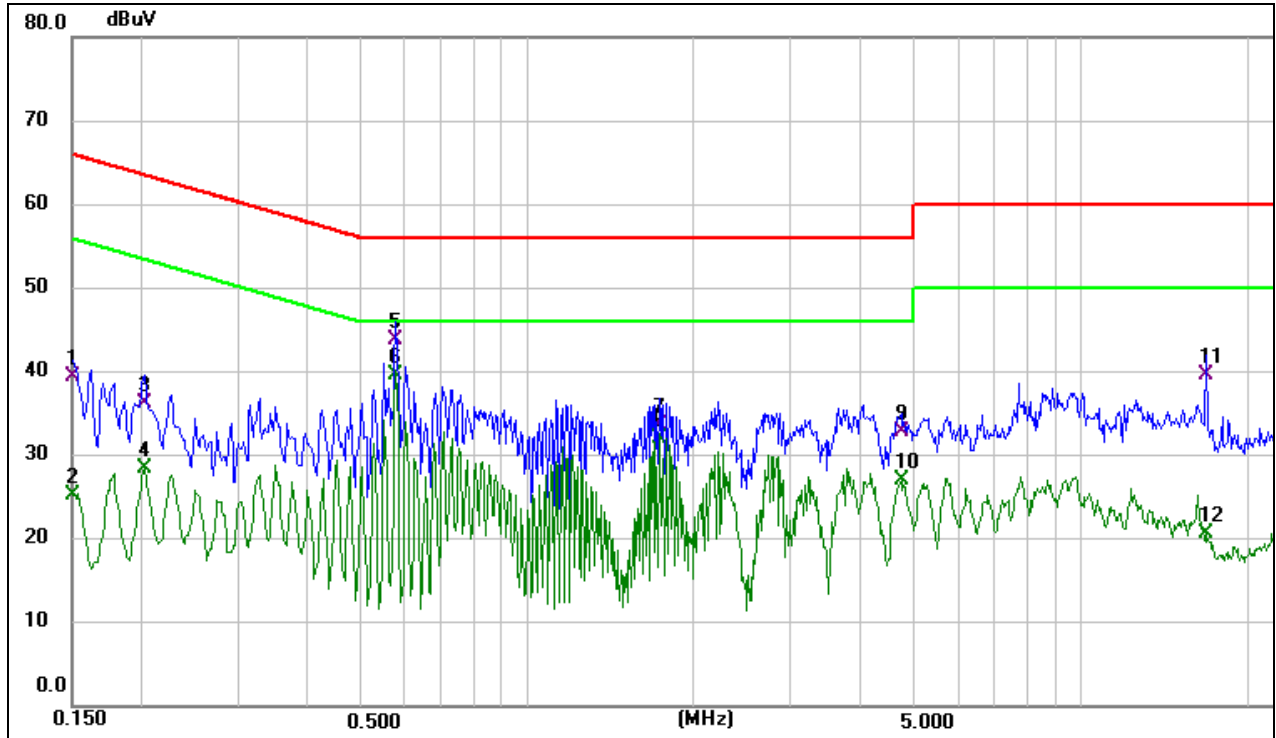

Site:		Phase:L1	Temperature(C):23.5(C)
Limit:	FCC Part 15 B Conduction(QP)	Test Time:	Humidity(%):52.6%
EUT:	portable power station	Power Rating:	2023/6/13 21:10:19
M/N.:	SYZ-R2000	Test Engineer:	AC 120V/60Hz
Mode:	BLE 2402MHz		Aiden
Note:			

No.	Frequency (MHz)	Reading Level(dBuV)	Factor (dB)	Measurement(dBuV)	Limit (dBuV)	Margin (dB)	Detector	Comment
1	0.1500	28.79	10.61	39.40	66.00	-26.60	QP	
2	0.1500	14.61	10.61	25.22	56.00	-30.78	AVG	
3	0.2020	25.47	10.73	36.20	63.53	-27.33	QP	
4	0.2020	17.65	10.73	28.38	53.53	-25.15	AVG	
5	0.5780	32.19	11.51	43.70	56.00	-12.30	QP	
6 *	0.5780	28.15	11.51	39.66	46.00	-6.34	AVG	
7	1.7300	23.20	10.40	33.60	56.00	-22.40	QP	
8	1.7300	21.60	10.40	32.00	46.00	-14.00	AVG	
9	4.7380	22.33	10.47	32.80	56.00	-23.20	QP	
10	4.7380	16.62	10.47	27.09	46.00	-18.91	AVG	
11	16.8620	28.77	10.93	39.70	60.00	-20.30	QP	
12	16.8620	9.63	10.93	20.56	50.00	-29.44	AVG	

*:Maximum data x:Over limit !:over margin

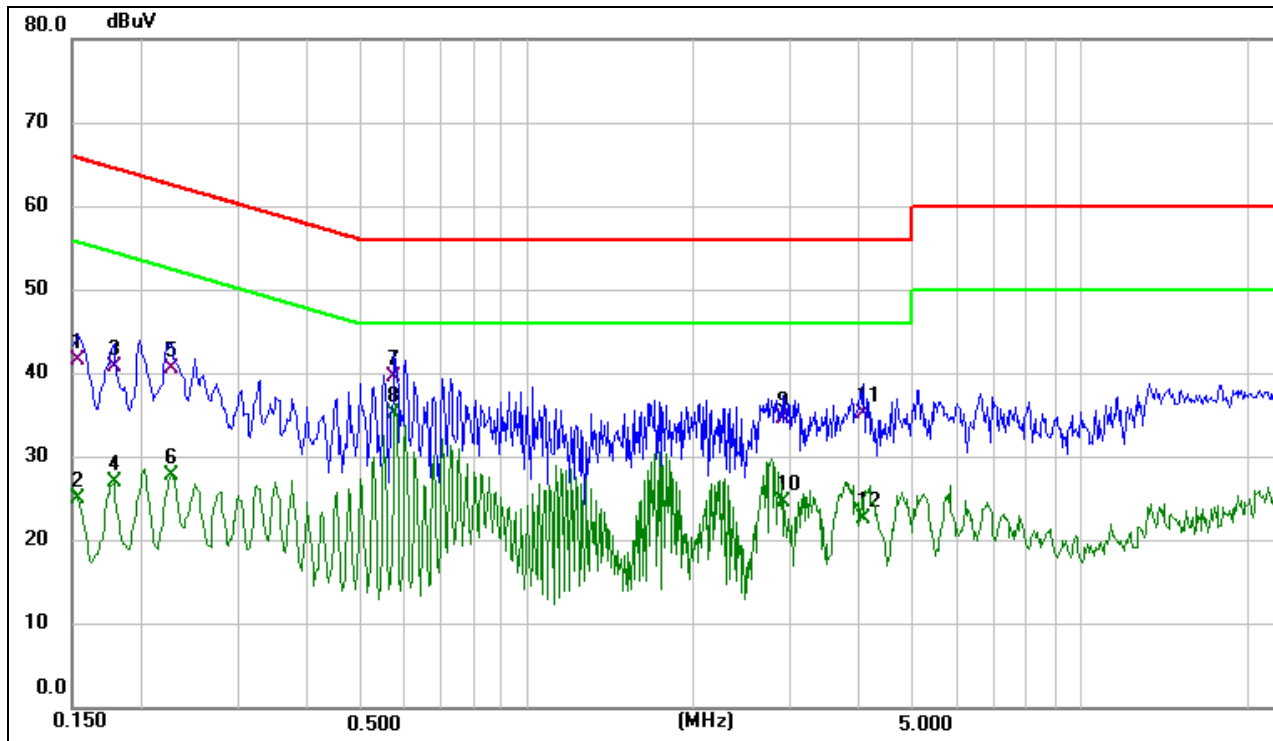

Site:		Phase: N	Temperature(C): 23.5(C)
Limit:	FCC Part 15 B Conduction(QP)		Humidity(%): 52.6%
EUT:	portable power station	Test Time:	2023/6/13 21:14:22
M/N.:	SYZ-R2000	Power Rating:	AC 120V/60Hz
Mode:	BLE 2402MHz	Test Engineer:	Aiden
Note:			

No.	Frequency (MHz)	Reading Level(dBuV)	Factor (dB)	Measurement(dBuV)	Limit (dBuV)	Margin (dB)	Detector	Comment
1	0.1539	30.94	10.56	41.50	65.79	-24.29	QP	
2	0.1539	14.57	10.56	25.13	55.79	-30.66	AVG	
3	0.1780	30.18	10.62	40.80	64.58	-23.78	QP	
4	0.1780	16.40	10.62	27.02	54.58	-27.56	AVG	
5	0.2260	29.87	10.73	40.60	62.60	-22.00	QP	
6	0.2260	17.18	10.73	27.91	52.60	-24.69	AVG	
7	0.5740	28.18	11.42	39.60	56.00	-16.40	QP	
8 *	0.5740	23.82	11.42	35.24	46.00	-10.76	AVG	
9	2.9020	24.34	10.36	34.70	56.00	-21.30	QP	
10	2.9020	14.23	10.36	24.59	46.00	-21.41	AVG	
11	4.0300	24.81	10.39	35.20	56.00	-20.80	QP	
12	4.0300	12.22	10.39	22.61	46.00	-23.39	AVG	

*:Maximum data x:Over limit !:over margin

Note: 1. Result = Reading + Correct Factor.

2. If QP Result complies with AV limit, AV Result is deemed to comply with AV limit.

3. Test setup: RBW: 200 Hz (9 kHz ~ 150 kHz), 9 kHz (150 kHz ~ 30 MHz).

4. Step size: 80 Hz (0.009 MHz ~ 0.15 MHz), 4 kHz (0.15 MHz ~ 30 MHz), Scan time: auto.

Note: All the modes have been tested, only the worst data was recorded in the report.

11. ST DATA

Please refer to section "Test Data" - Appendix B

APPENDIX: PHOTOGRAPHS OF TEST CONFIGURATION

AC Power Line Conducted Emission



Radiated Band edge and Spurious Emission





APPENDIX: PHOTOGRAPHS OF THE EUT

External







Internal

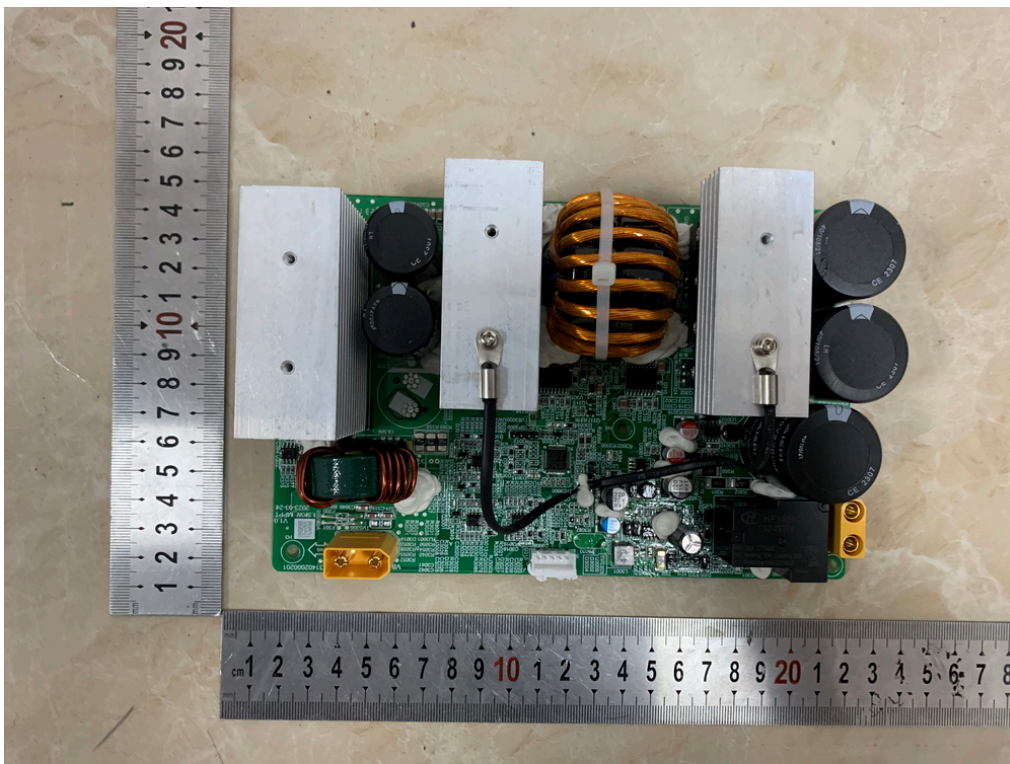

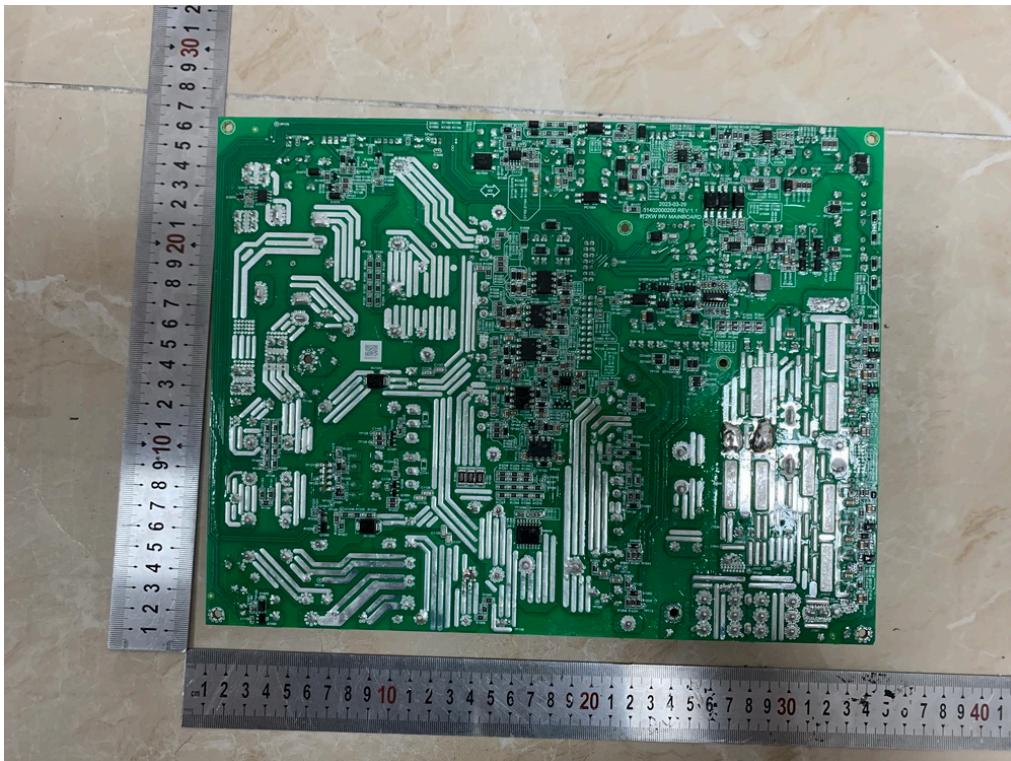
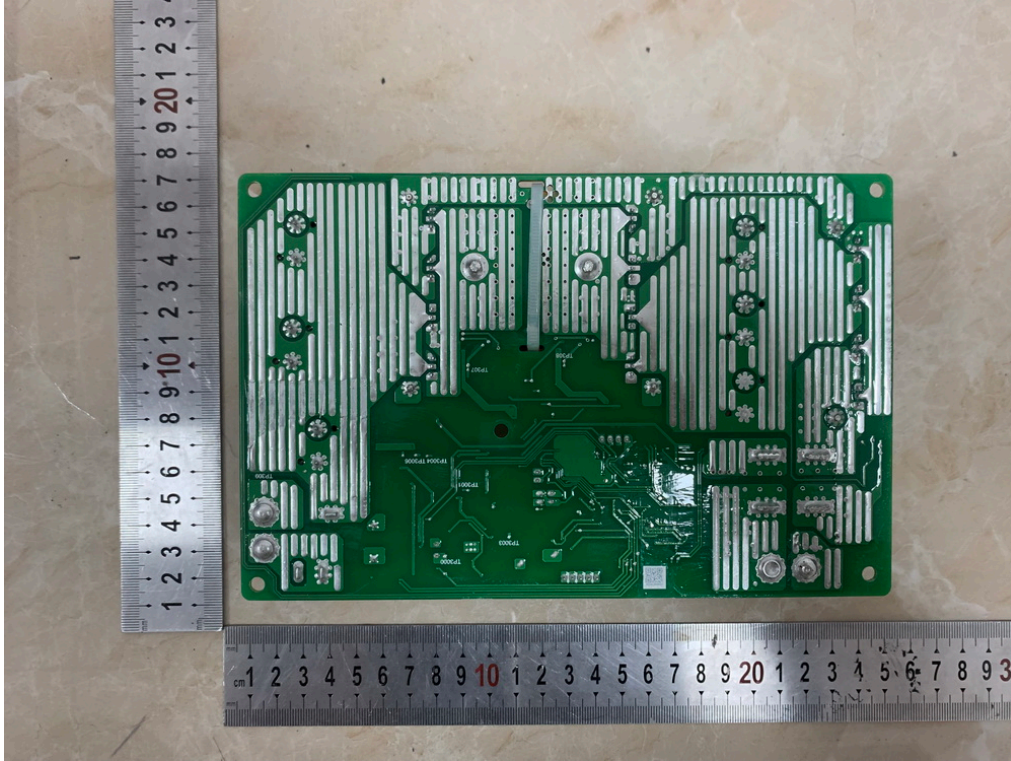

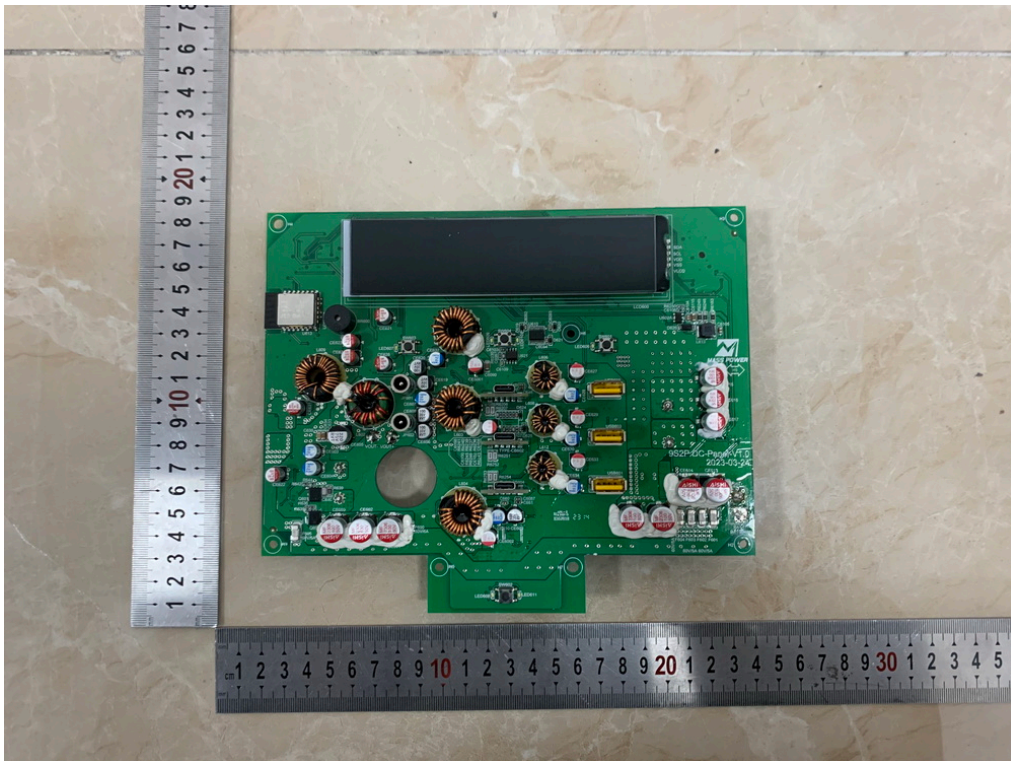
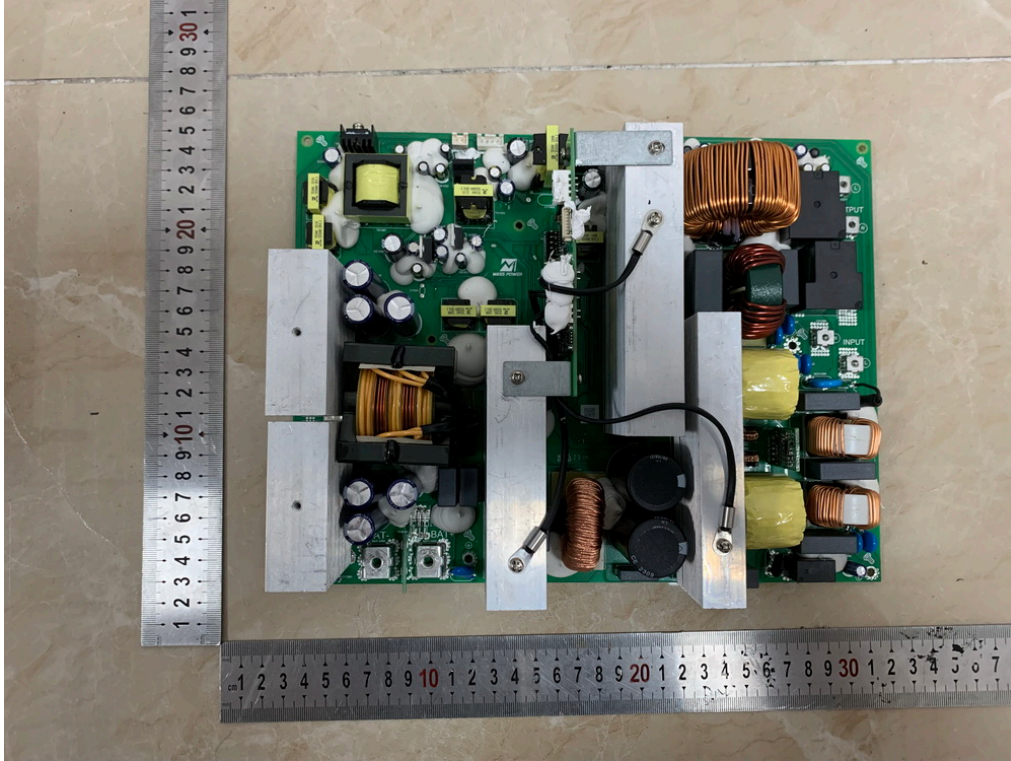

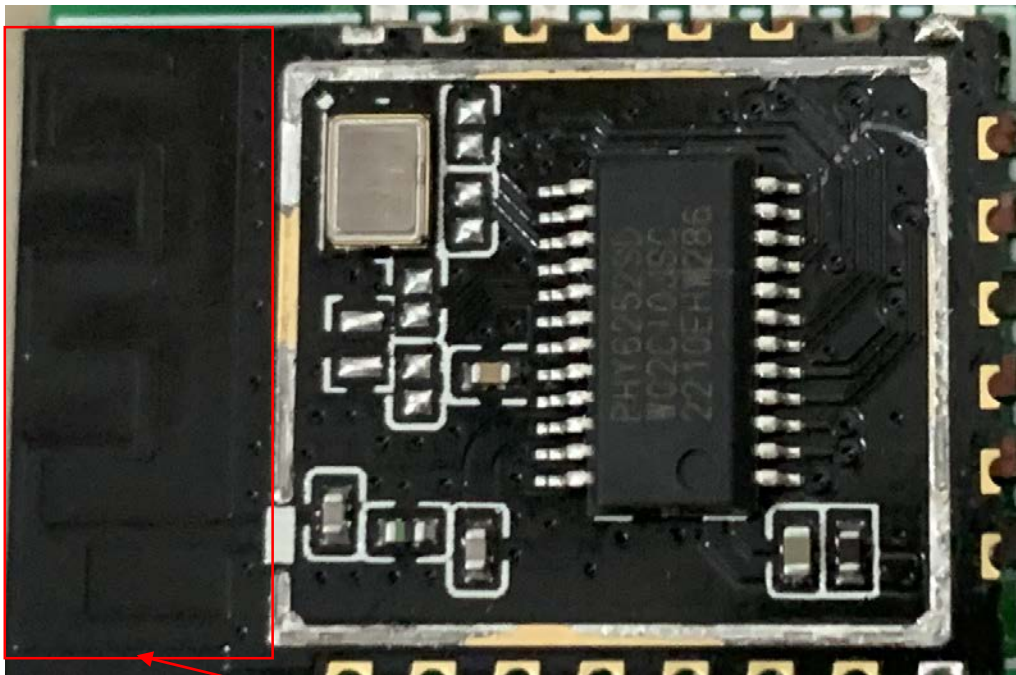
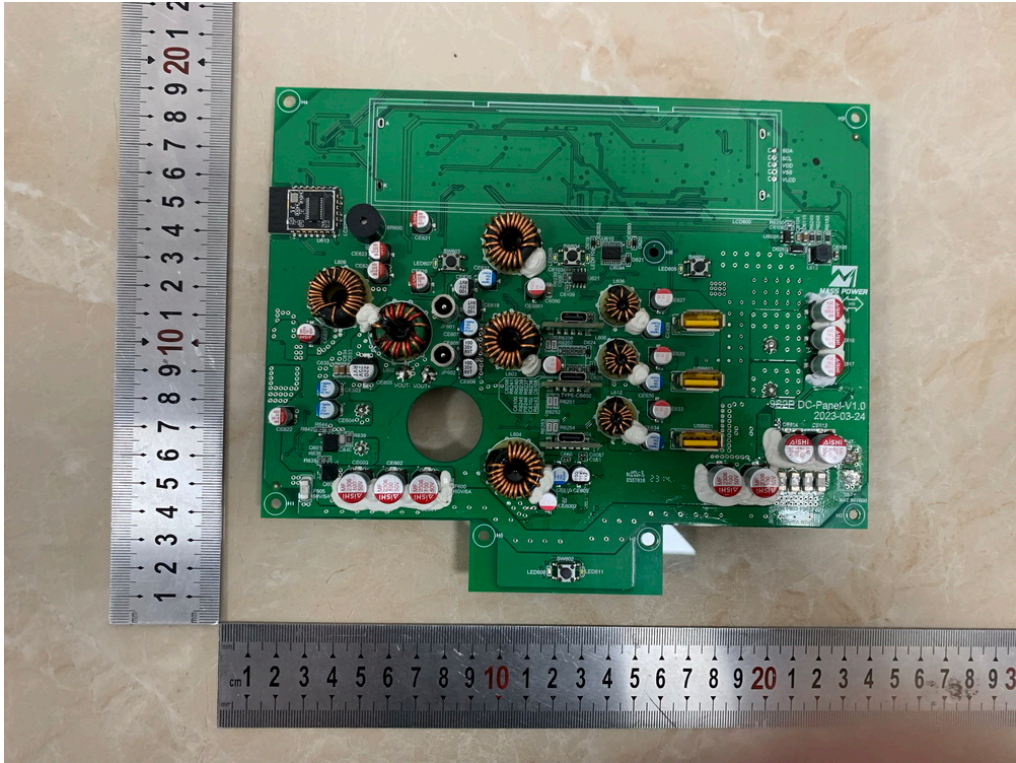

Antenna

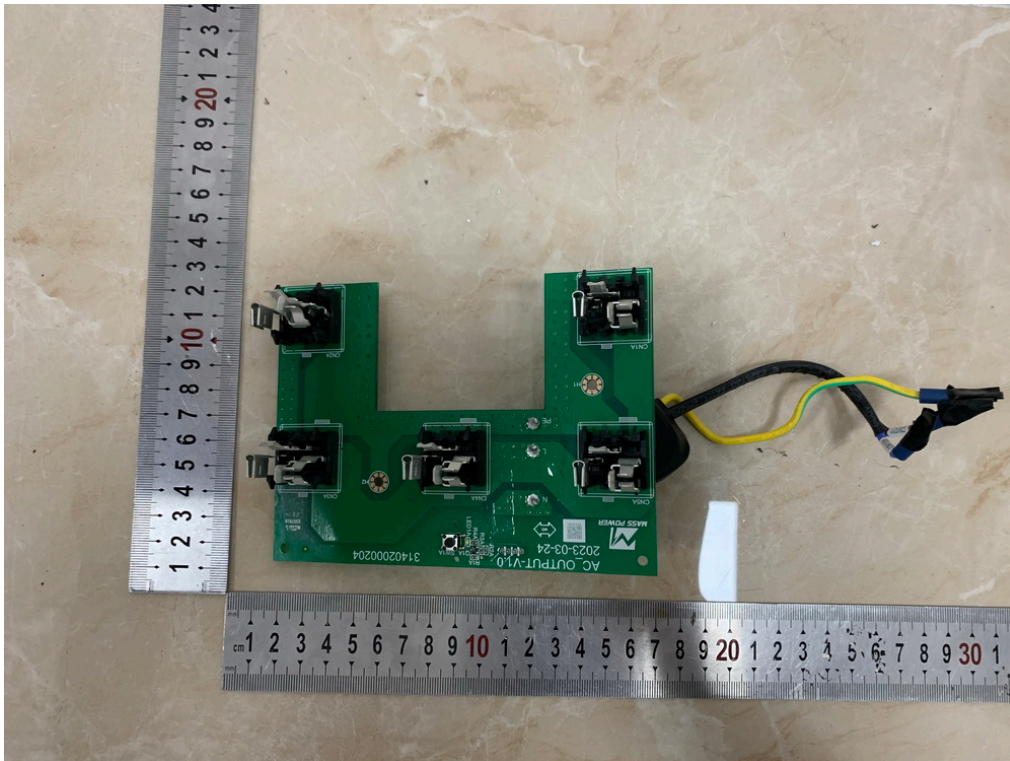
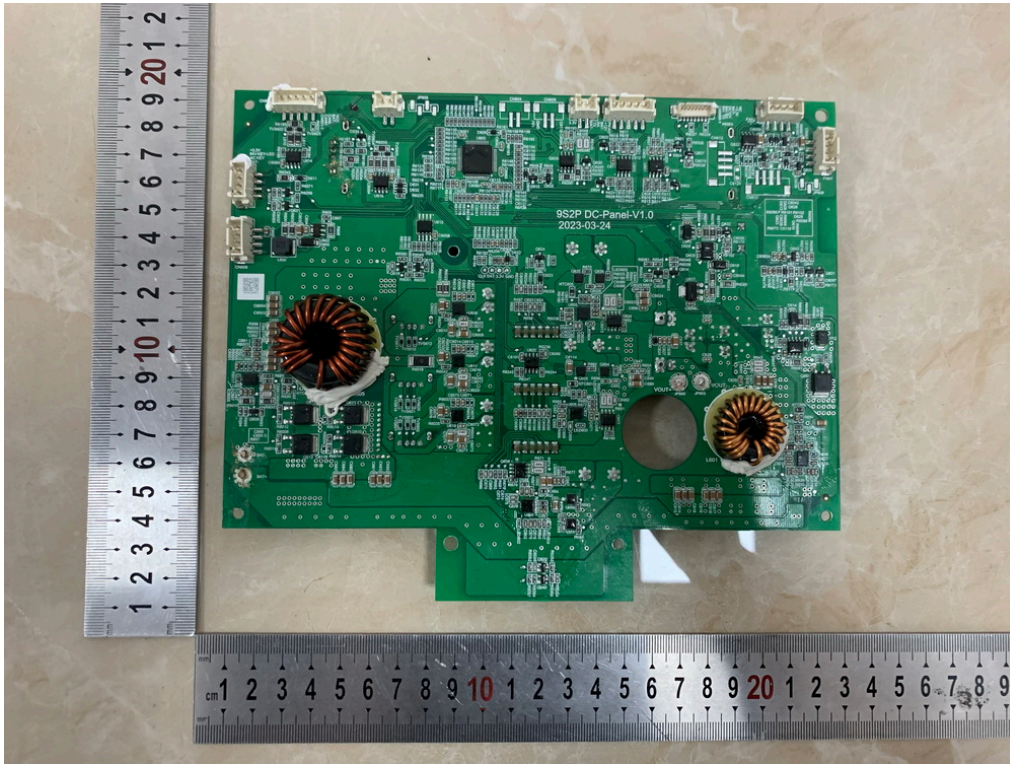

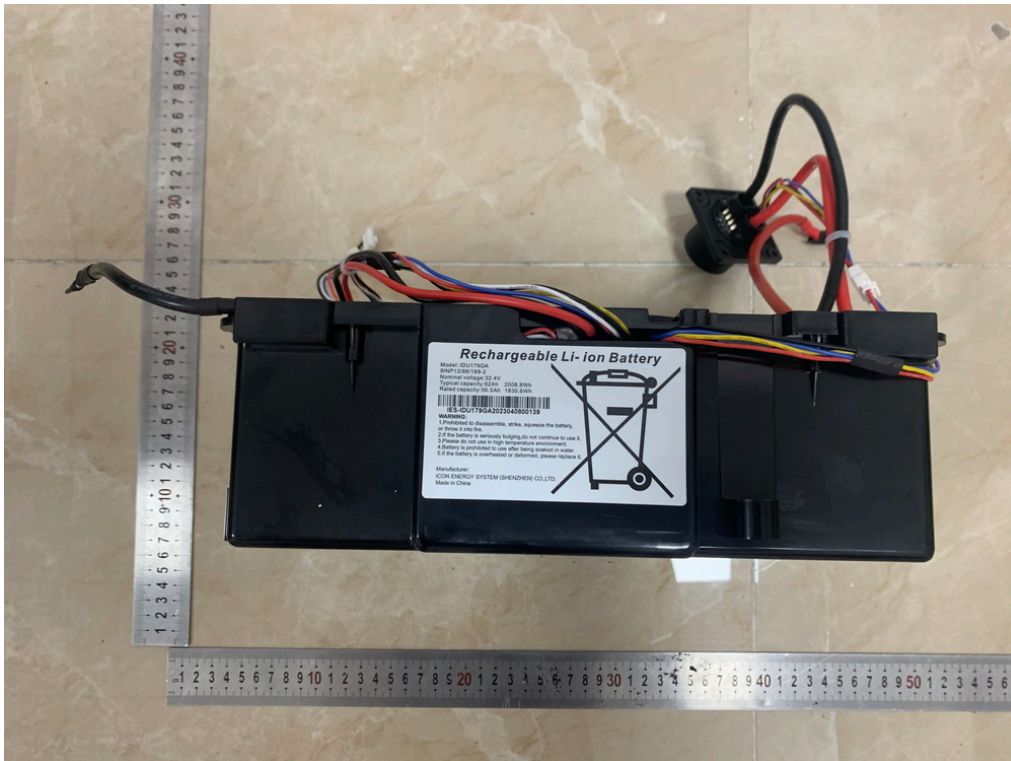
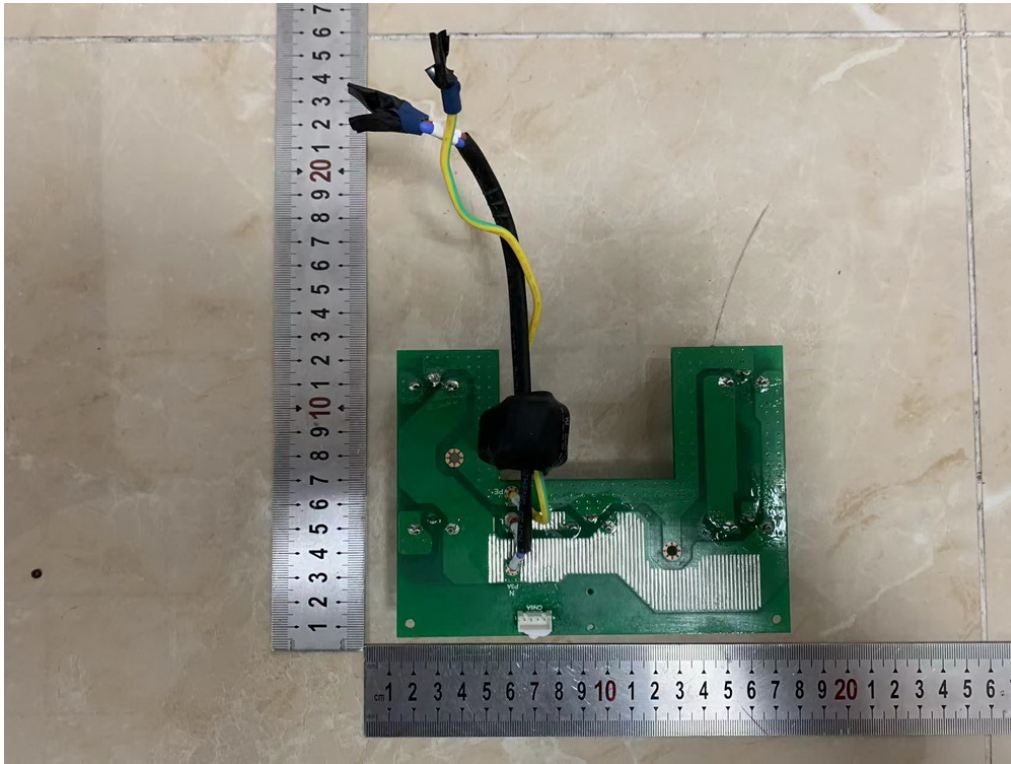

END OF REPORT