

## TEST REPORT

### FCC Rules Part 15.247

**Report Reference No.**..... : **MTEB23060072 -R**

**FCC ID**..... : **2BBGK-RAPTOR**

Compiled by

( position+printed name+signature): File administrators Alisa Luo



Supervised by

( position+printed name+signature): Test Engineer Sunny Deng



Approved by

( position+printed name+signature): Manager Yvette Zhou



Date of issue..... : Jun.07,2023

**Representative Laboratory Name**..... : **Shenzhen Most Technology Service Co., Ltd.**

Address ..... : No.5, 2nd Langshan Road, North District, Hi-tech Industrial Park, Nanshan, Shenzhen, Guangdong, China.

**Applicant's name**..... : **Shenzhen Xincheng Times Technology Co.,Ltd**

Address ..... : 104-105, Block C, Donghai Wang Building, No. 369 Bulong Road, Ma'antang Community, Bantian Street, Longgang District, Shenzhen

**Test specification/ Standard**..... : **FCC Rules Part 15.247**

TRF Originator..... : Shenzhen Most Technology Service Co., Ltd.

**Shenzhen Most Technology Service Co., Ltd. All rights reserved.**

This publication may be reproduced in whole or in part for non-commercial purposes as long as the Shenzhen Most Technology Service Co., Ltd. is acknowledged as copyright owner and source of the material. Shenzhen Most Technology Service Co., Ltd. takes no responsibility for and will not assume liability for damages resulting from the reader's interpretation of the reproduced material due to its placement and context.

**Test item description** ..... : **ELECTRIC SCOOTER**

Trade Mark ..... : N/A

Manufacturer ..... : Shenzhen Xincheng Times Technology Co.,Ltd

Model/Type reference..... : Raptor

Listed Models ..... : T8, Raptor pro,R3

Modulation Type ..... : GFSK

Operation Frequency..... : From 2402MHz to 2480MHz

Hardware Version..... M0-2BLE8-V1.95-20221231

Software Version ..... T80.5.9 (13F0)

Rating ..... : 1:DC 48V (by Battery)  
2:DC 54.6V (by Adapter)

Result..... : PASS

**TEST REPORT**

Equipment under Test : ELECTRIC SCOOTER

Model /Type : Raptor

Listed Models : T8, Raptor pro,R3

Remark : Difference in model names

Applicant : **Shenzhen Xincheng Times Technology Co.,Ltd**

Address : 104-105, Block C, Donghai Wang Building, No. 369 Bulong Road, Ma'antang Community, Bantian Street, Longgang District, Shenzhen

Manufacturer : **Shenzhen Xincheng Times Technology Co.,Ltd**

Address : 104-105, Block C, Donghai Wang Building, No. 369 Bulong Road, Ma'antang Community, Bantian Street, Longgang District, Shenzhen

<b>Test Result:</b>	<b>PASS</b>
---------------------	-------------

The test report merely corresponds to the test sample.  
It is not permitted to copy extracts of these test result without the written permission of the test laboratory.

## Contents

<b>1.</b>	<b><u>REVISION HISTORY .....</u></b>	<b>4</b>
<b>2.</b>	<b><u>TEST STANDARDS .....</u></b>	<b>5</b>
<b>3.</b>	<b><u>SUMMARY .....</u></b>	<b>6</b>
3.1.	General Remarks	6
3.2.	Product Description	6
3.3.	Equipment Under Test	6
3.4.	Short description of the Equipment under Test (EUT)	6
3.5.	EUT operation mode	7
3.6.	Block Diagram of Test Setup	7
3.7.	Test Item (Equipment Under Test) Description*	7
3.8.	Auxiliary Equipment (AE) Description	7
3.9.	Antenna Information*	8
3.10.	EUT configuration	8
3.11.	Modifications	8
<b>4.</b>	<b><u>TEST ENVIRONMENT .....</u></b>	<b>9</b>
4.1.	Address of the test laboratory	9
4.2.	Environmental conditions	9
4.3.	Test Description	10
4.4.	Statement of the measurement uncertainty	10
4.5.	Equipments Used during the Test	11
<b>5.</b>	<b><u>TEST CONDITIONS AND RESULTS.....</u></b>	<b>12</b>
5.1.	AC Power Conducted Emission	12
5.2.	Radiated Emission	15
5.3.	Maximum Peak Output Power	22
5.4.	Power Spectral Density	23
5.5.	6dB Bandwidth and 99% Bandwidth	24
5.6.	Band Edge Compliance of RF Emission	25
5.7.	Spurious RF Conducted Emission	27
5.8.	Antenna Requirement	28
<b>6.</b>	<b><u>TEST SETUP PHOTOS OF THE EUT .....</u></b>	<b>29</b>
<b>7.</b>	<b><u>EXTERNAL AND INTERNAL PHOTOS OF THE EUT .....</u></b>	<b>30</b>
	<b>APPENDIX I. Conducted Peak Output Power</b>	<b>错</b>
	误! 未定义书签。	
	<b>APPENDIX II. 99% Bandwidth</b>	<b>错</b>
	误! 未定义书签。	
	<b>APPENDIX III. 6dB Bandwidth</b>	<b>错</b>
	误! 未定义书签。	
	<b>APPENDIX IV. Conducted Out Of Band Emission</b>	<b>错</b>
	误! 未定义书签。	
	<b>APPENDIX V. Power Spectral Density</b>	<b>错</b>
	误! 未定义书签。	

## 1. Revision History

Revision	Issue Date	Revisions	Revised By
00	2023.06.07	Initial Issue	Alisa Luo

## **2. TEST STANDARDS**

The tests were performed according to following standards:

The tests were performed according to following standards:

[FCC Rules Part 15.247](#): Frequency Hopping, Direct Spread Spectrum and Hybrid Systems that are in operation within the bands of 902-928 MHz, 2400-2483.5 MHz, and 5725-5850 MHz.

[ANSI C63.10:2013](#) : American National Standard for Testing Unlicensed Wireless Devices

### 3. SUMMARY

#### 3.1. General Remarks

Date of receipt of test sample	:	2023.05.31
Testing commenced on	:	2023.06.01
Testing concluded on	:	2023.06.07

#### 3.2. Product Description

Product Name:	ELECTRIC SCOOTER
Model/Type reference:	Raptor
Power Supply:	1:DC 48V (by Battery) 2:DC 54.6V (by Adapter)
Testing sample ID:	MTYP01682
<b>Bluetooth :</b>	
Supported Type:	BLE
Modulation:	GFSK
Operation frequency:	2402MHz~2480MHz
Channel number:	40
Channel separation:	2MHz
Antenna type:	PCB Antenna
Antenna gain:	-1.59dBi

#### 3.3. Equipment Under Test

##### Power supply system utilised

Power supply voltage	:	<input type="radio"/> 230V / 50 Hz	<input type="radio"/> 120V / 60Hz
		<input type="radio"/> 12 V DC	<input type="radio"/> 24 V DC
		<input checked="" type="radio"/> Other (specified in blank below)	

**1: DC 48V (by Battery)**  
**2: DC 54.6V (by Adapter)**

#### 3.4. Short description of the Equipment under Test (EUT)

This is a ELECTRIC SCOOTER For more details, refer to the user's manual of the EUT.

### 3.5. EUT operation mode

The Applicant provides communication tools software to control the EUT for staying in continuous transmitting (Duty Cycle more than 98%) and receiving mode for testing .There are 40 channels provided to the EUT. Channel 00/19/39 was selected to test.

Channel	Frequency(MHz)	Channel	Frequency(MHz)
0	2402	20	2442
1	2404	21	2444
2	2406	22	2446
3	2408	23	2448
4	2410	24	2450
5	2412	25	2452
6	2414	26	2454
7	2416	27	2456
8	2418	28	2458
9	2420	29	2460
10	2422	30	2462
11	2424	31	2464
12	2426	32	2466
13	2428	33	2468
14	2430	34	2470
15	2432	35	2472
16	2434	36	2474
17	2436	37	2476
18	2438	38	2478
19	2440	39	2480

### 3.6. Block Diagram of Test Setup

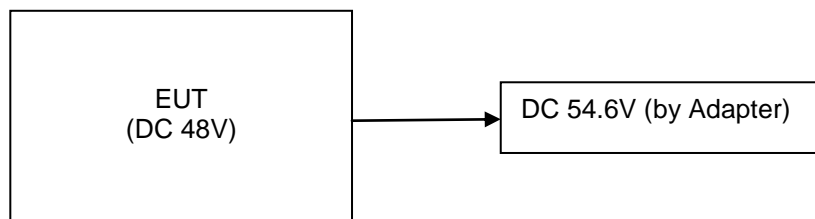

### 3.7. Test Item (Equipment Under Test) Description\*

Short designation	EUT Name	EUT Description	Serial number	Hardware status	Software status
EUT A	Adapter	GJS150-0541830	/	/	/
EUT B	/	/	/	/	/

\*: declared by the applicant. According to customers information EUTs A and B are the same devices.

### 3.8. Auxiliary Equipment (AE) Description

AE short designation	EUT Name (if available)	EUT Description	Serial number (if available)	Software (if used)

AE 1	/	/	/	/
AE 2	/	/	/	/

### 3.9. Antenna Information\*

Short designation	Antenna Name	Antenna Type	Frequency Range	Serial number	Antenna Peak Gain
Antenna 1	---	PCB Antenna	2.4 - 2.5 GHz	---	-1.59 dBi
Antenna 2	/	/	/	/	/

\*: declared by the applicant.

### 3.10. EUT configuration

The following peripheral devices and interface cables were connected during the measurement:

● - supplied by the manufacturer

○ - Supplied by the lab

● ADAPTER	M/N:	GJS150-0541830
	Manufacturer:	Shenzhen Gojusin Technology CO.,LTD

### 3.11. Modifications

No modifications were implemented to meet testing criteria.



## 4. TEST ENVIRONMENT

### 4.1. Address of the test laboratory

#### **Shenzhen Most Technology Service Co., Ltd.**

No.5, 2nd Langshan Road, North District, Hi-tech Industrial Park, Nanshan, Shenzhen, Guangdong, China.  
The 3m-Semi anechoic test site fulfils CISPR 16-1-4 according to ANSI C63.4:2014 and CISPR 16-1-4:2010 SVSWR requirement for radiated emission above 1GHz.

#### **Test Facility**

The test facility is recognized, certified, or accredited by the following organizations:

#### **FCC-Registration No.: 0031192610**

Shenzhen Most Technology Service Co., Ltd. EMC Laboratory has been registered and fully described in a report filed with the (FCC) Federal Communications Commission. The acceptance letter from the FCC is maintained in our files.

#### **A2LA-Lab Cert. No.: 6343.01**

Shenzhen Most Technology Service Co., Ltd. EMC Laboratory has been accredited by A2LA for technical competence in the field of electrical testing, and proved to be in compliance with ISO/IEC 17025: 2005 General Requirements for the Competence of Testing and Calibration Laboratories and any additional program requirements in the identified field of testing.

### 4.2. Environmental conditions

Radiated Emission:

Temperature:	21.6 ° C
Humidity:	48 %
Atmospheric pressure:	950-1050mbar

Conducted testing:

Temperature:	21.6 ° C
Humidity:	48 %
Atmospheric pressure:	950-1050mbar

### 4.3. Test Description

FCC and IC Requirements		
FCC Part 15.207	AC Power Conducted Emission	PASS
FCC Part 15.247 (a)(2)	6dB Bandwidth & 99% Bandwidth	PASS
FCC Part 15.247(d)	Spurious RF Conducted Emission	PASS
FCC Part 15.247(b)	Maximum Conducted Output Power	PASS
FCC Part 15.247 (e)	Power Spectral Density	PASS
FCC Part 15.205/15.209	Radiated Emissions	PASS
FCC Part 15.247(d)	Band Edge	PASS

Remark:

1. The measurement uncertainty is not included in the test result.
2. NA = Not Applicable; NP = Not Performed

### 4.4. Statement of the measurement uncertainty

The data and results referenced in this document are true and accurate. The reader is cautioned that there may be errors within the calibration limits of the equipment and facilities. The measurement uncertainty was calculated for all measurements listed in this test report acc. to CISPR 16 - 4 „Specification for radio disturbance and immunity measuring apparatus and methods – Part 4: Uncertainty in EMC Measurements“ and is documented in the Shenzhen Most Technology Service Co., Ltd. quality system acc. to DIN EN ISO/IEC 17025. Furthermore, component and process variability of devices similar to that tested may result in additional deviation. The manufacturer has the sole responsibility of continued compliance of the device.

Hereafter the best measurement capability for Shenzhen Most Technology Service Co., Ltd. is reported:

Test	Range	Measurement Uncertainty	Notes
Radiated Emission	30~1000MHz	4.10 dB	(1)
Radiated Emission	1~18GHz	4.32 dB	(1)
Radiated Emission	18-40GHz	5.54 dB	(1)
Conducted Disturbance	0.15~30MHz	3.12 dB	(1)

- (1) This uncertainty represents an expanded uncertainty expressed at approximately the 95% confidence level using a coverage factor of k=2.

#### 4.5. Equipments Used during the Test

Item	Equipment	Manufacturer	Model No.	Serial No.	Firmware versions	Last Cal.
1.	L.I.S.N.	R&S	ENV216	100093	/	2023/03/17
2	Three-phase artificial power network	Schwarzback Mess	NNLK8129	8129178	/	2023/03/17
3.	Receiver	R&S	ESCI	100492	V3.0-10-2	2023/03/17
4	Receiver	R&S	ESPI	101202	V3.0-10-2	2023/03/17
5	Spectrum analyzer	Agilent	9020A	MT-E306	A14.16	2023/03/17
6	Bilong Antenna	Sunol Sciences	JB3	A121206	/	2023/03/17
7	Horn antenna	HF Antenna	HF Antenna	MT-E158	/	2023/03/17
8	Loop antenna	Beijing Daze	ZN30900B	/	/	2023/03/17
9	Horn antenna	R&S	OBH100400	26999002	/	2023/03/17
10	Wireless Communication Test Set	R&S	CMW500	/	CMW-BASE-3.7.21	2023/03/17
11	Spectrum analyzer	R&S	FSP	100019	V4.40 SP2	2023/03/17
12	High gain antenna	Schwarzbeck	LB-180400KF	MT-E389	/	2023/03/17
13	Preamplifier	Schwarzbeck	BBV 9743	MT-E390	/	2023/03/17
14	Pre-amplifier	EMCI	EMC051845S E	MT-E391	/	2023/03/17
15	Pre-amplifier	Agilent	83051A	MT-E392	/	2023/03/17
16	High pass filter unit	Tonscend	JS0806-F	MT-E393	/	2023/03/17
17	RF Cable(below1GHz)	Times	9kHz-1GHz	MT-E394	/	2023/03/17
18	RF Cable(above 1GHz)	Times	1-40G	MT-E395	/	2023/03/17
19	RF Cable (9KHz-40GHz)	Tonscend	170660	N/A	/	2023/03/17

Note: 1. The Cal.Interval was one year.

## 5. TEST CONDITIONS AND RESULTS

### 5.1. AC Power Conducted Emission

#### TEST CONFIGURATION

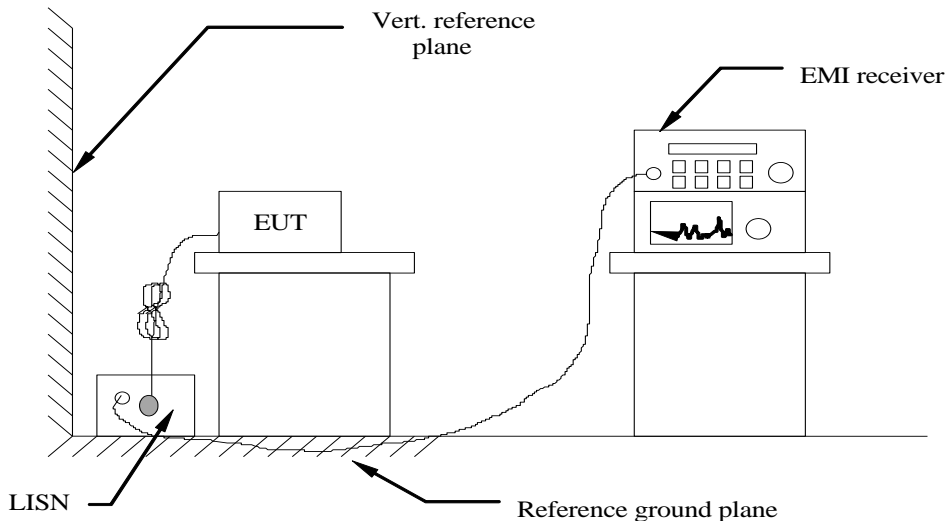

#### TEST PROCEDURE

- 1 The equipment was set up as per the test configuration to simulate typical actual usage per the user's manual. The EUT is a tabletop system, a wooden table with a height of 0.8 meters is used and is placed on the ground plane as per ANSI C63.10-2013.
- 2 Support equipment, if needed, was placed as per ANSI C63.10-2013
- 3 All I/O cables were positioned to simulate typical actual usage as per ANSI C63.10-2013
- 4 The EUT received DC5V power, the adapter received AC120V/60Hz power through a Line Impedance Stabilization Network (LISN) which supplied power source and was grounded to the ground plane.
- 5 All support equipments received AC power from a second LISN, if any.
- 6 The EUT test program was started. Emissions were measured on each current carrying line of the EUT using a spectrum Analyzer / Receiver connected to the LISN powering the EUT. The LISN has two monitoring points: Line 1 (Hot Side) and Line 2 (Neutral Side). Two scans were taken: one with Line 1 connected to Analyzer / Receiver and Line 2 connected to a 50 ohm load; the second scan had Line 1 connected to a 50 ohm load and Line 2 connected to the Analyzer / Receiver.
- 7 Analyzer / Receiver scanned from 150 KHz to 30MHz for emissions in each of the test modes.
- 8 During the above scans, the emissions were maximized by cable manipulation.

#### AC Power Conducted Emission Limit

For unintentional device, according to RSS Gen 8.8 and § 15.207(a) Line Conducted Emission Limits is as following:

Frequency range (MHz)	Limit (dBuV)	
	Quasi-peak	Average
0.15-0.5	66 to 56*	56 to 46*
0.5-5	56	46
5-30	60	50

\* Decreases with the logarithm of the frequency.

#### TEST RESULTS

Remark:

- GFSK modes were test at Low, Middle, and High channel; only the worst result of GFSK Middle Channel was reported as below:

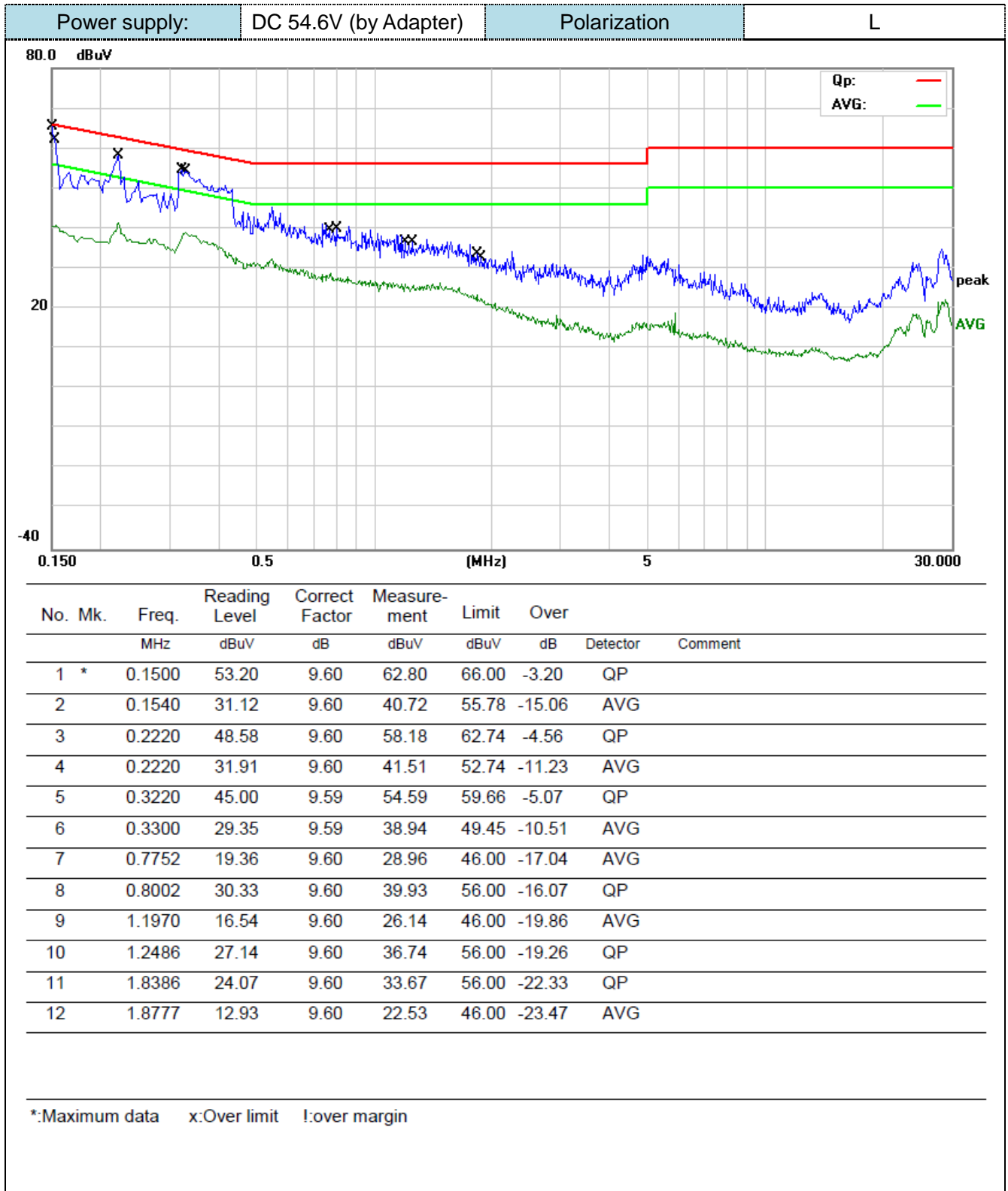

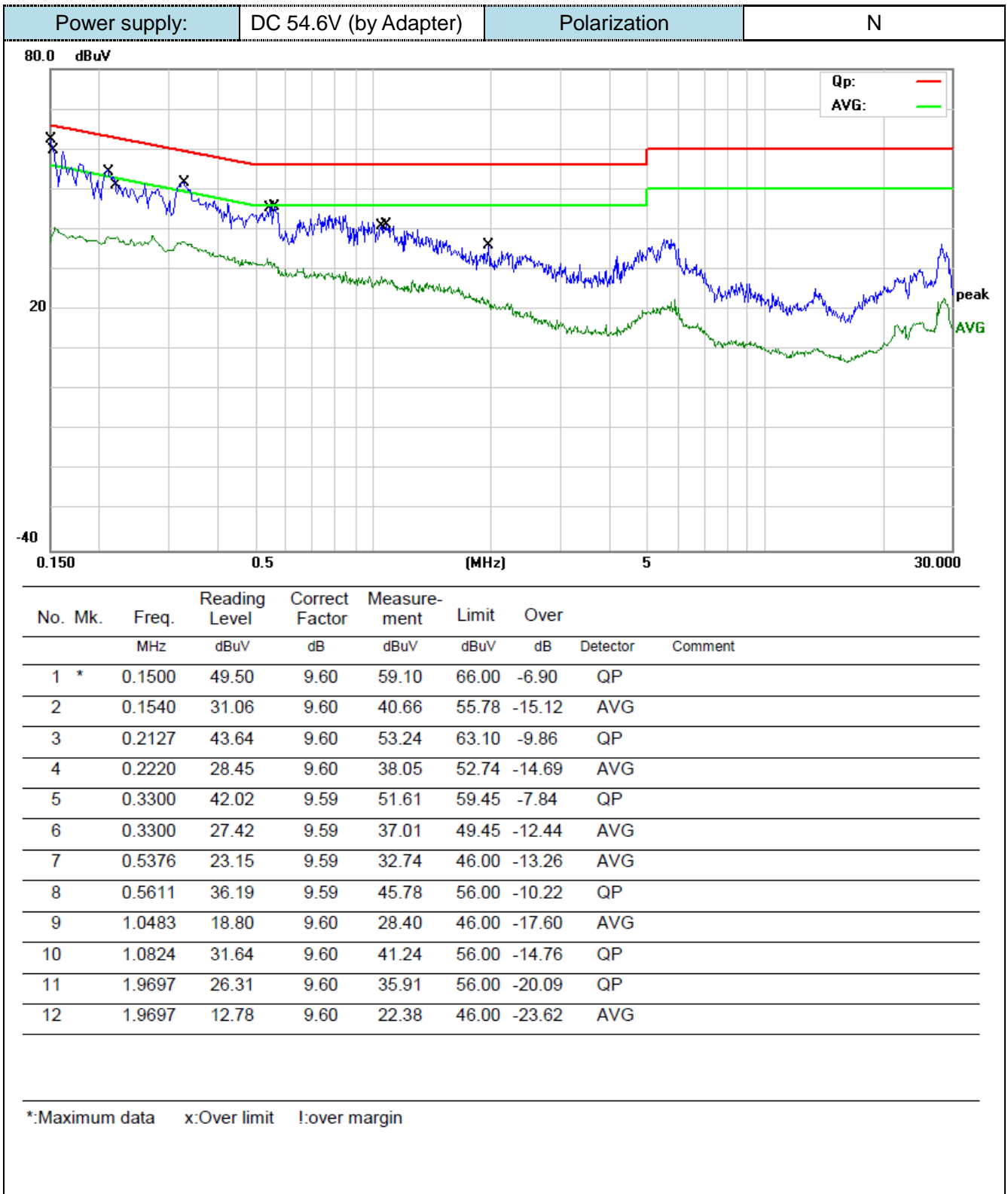

## 5.2. Radiated Emission

### TEST CONFIGURATION

Frequency range 9 KHz – 30MHz

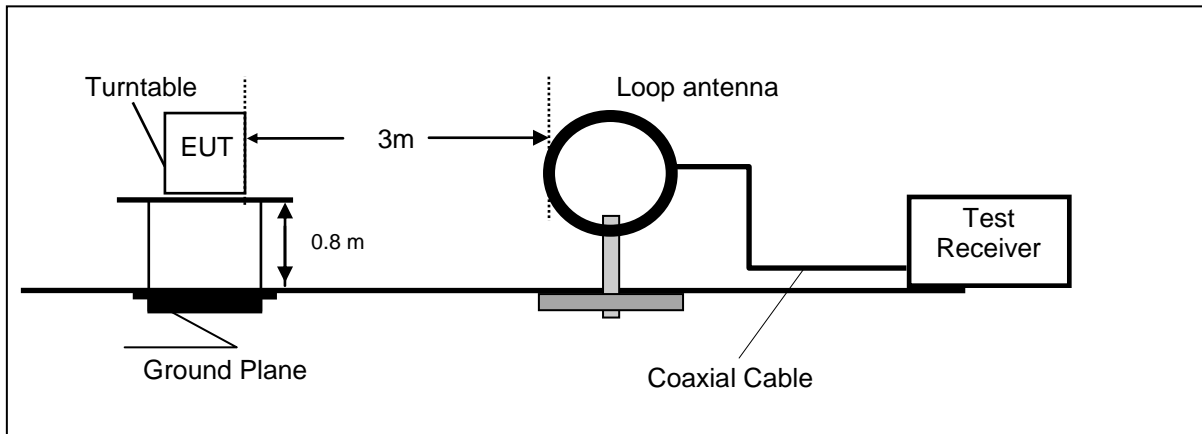

Frequency range 30MHz – 1000MHz

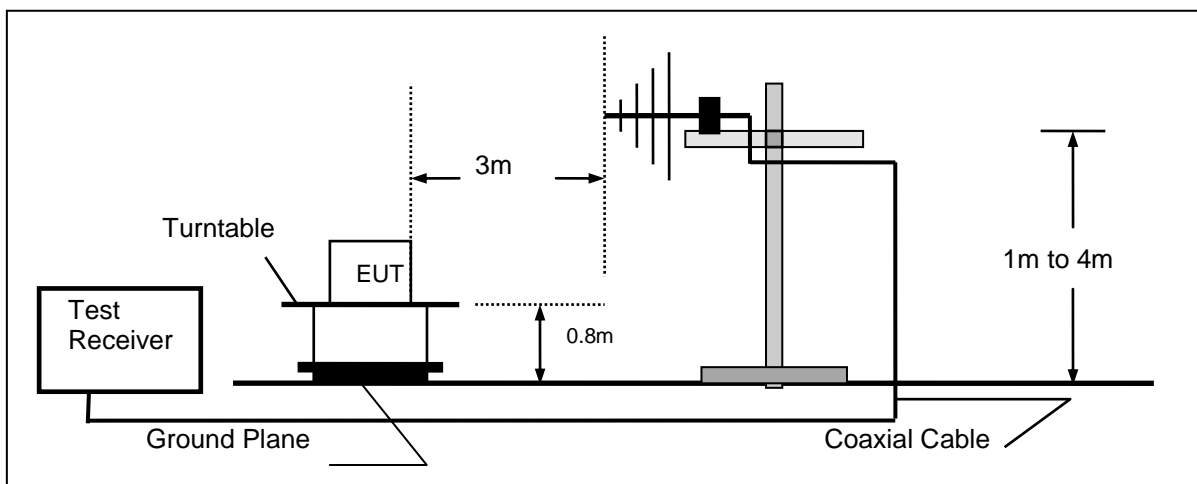

Frequency range above 1GHz-25GHz

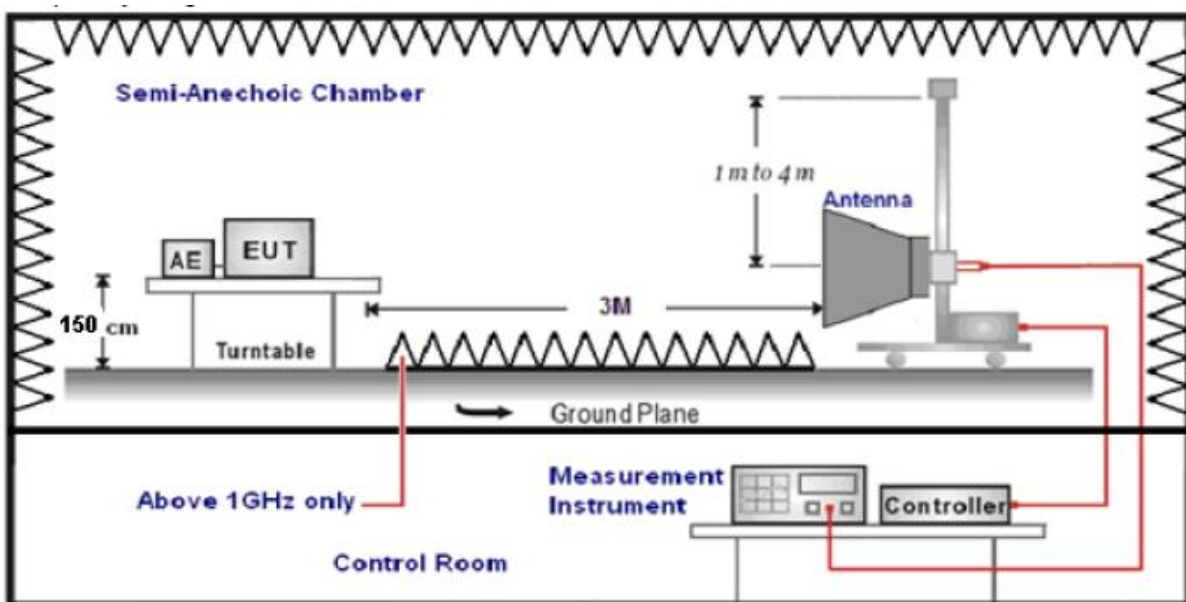

**TEST PROCEDURE**

1. The EUT was placed on a turn table which is 0.8m above ground plane when testing frequency range 9 KHz –1GHz;the EUT was placed on a turn table which is 1.5m above ground plane when testing frequency range 1GHz – 25GHz.
2. Maximum procedure was performed by raising the receiving antenna from 1m to 4m and rotating the turn table from 0° to 360° to acquire the highest emissions from EUT.
3. And also, each emission was to be maximized by changing the polarization of receiving antenna both horizontal and vertical.
4. Repeat above procedures until all frequency measurements have been completed.
5. The EUT minimum operation frequency was 32.768KHz and maximum operation frequency was 2480MHz.so radiated emission test frequency band from 9KHz to 25GHz.
6. The distance between test antenna and EUT as following table states:

Test Frequency range	Test Antenna Type	Test Distance
9KHz-30MHz	Active Loop Antenna	3
30MHz-1GHz	Ultra-Broadband Antenna	3
1GHz-18GHz	Double Ridged Horn Antenna	3
18GHz-25GHz	Horn Antenna	1

7. Setting test receiver/spectrum as following table states:

Test Frequency range	Test Receiver/Spectrum Setting	Detector
9KHz-150KHz	RBW=200Hz/VBW=3KHz, Sweep time=Auto	QP
150KHz-30MHz	RBW=9KHz/VBW=100KHz, Sweep time=Auto	QP
30MHz-1GHz	RBW=120KHz/VBW=1000KHz, Sweep time=Auto	QP
1GHz-40GHz	Peak Value: RBW=1MHz/VBW=3MHz, Sweep time=Auto Average Value: RBW=1MHz/VBW=10Hz, Sweep time=Auto	Peak

**Field Strength Calculation**

The field strength is calculated by adding the Antenna Factor and Cable Factor and subtracting the Amplifier Gain and Duty Cycle Correction Factor(if any) from the measured reading. The basic equation with a sample calculation is as follows:

**FS = RA + AF + CL - AG**

Where FS = Field Strength	CL = Cable Attenuation Factor (Cable Loss)
RA = Reading Amplitude	AG = Amplifier Gain
AF = Antenna Factor	

Transd=AF +CL-AG

**RADIATION LIMIT**

For intentional device, according to § 15.209(a), the general requirement of field strength of radiated emission out of authorized band shall not exceed the following table at a 3 meters measurement distance.

In addition, radiated emissions which fall in the restricted bands, as defined in §15.205(a), must also comply with the radiated emission limits specified in §15.209(a)

Except when the requirements applicable to a given device state otherwise, emissions from licence-exempt transmitters shall comply with the field strength limits shown in table below. Additionally, the level of any transmitter emission shall not exceed the level of the transmitter’s fundamental emission

Unwanted emissions that fall into restricted bands shall comply with the limits specified in RSS-Gen; and Unwanted emissions that do not fall within the restricted frequency bands shall comply either with the limits specified in the applicable RSS or with those specified in this RSS-Gen.



Frequency (MHz)	Distance (Meters)	Radiated (dB $\mu$ V/m)	Radiated ( $\mu$ V/m)
0.009-0.49	3	$20\log(2400/F(\text{KHz}))+40\log(300/3)$	$2400/F(\text{KHz})$
0.49-1.705	3	$20\log(24000/F(\text{KHz}))+40\log(30/3)$	$24000/F(\text{KHz})$
1.705-30	3	$20\log(30)+40\log(30/3)$	30
30-88	3	40.0	100
88-216	3	43.5	150
216-960	3	46.0	200
Above 960	3	54.0	500

### **TEST RESULTS**

Remark:

1. We measured Radiated Emission at GFSK mode from 9 KHz to 25GHz and recorded worst case at GFSK DH5 mode.
2. For below 1GHz testing recorded worst at GFSK DH5 middle channel.
3. Radiated emission test from 9 KHz to 10th harmonic of fundamental was verified, and no emission found except system noise floor in 9 KHz to 30MHz and not recorded in this report.

For 30MHz-1GHz

Horizontal

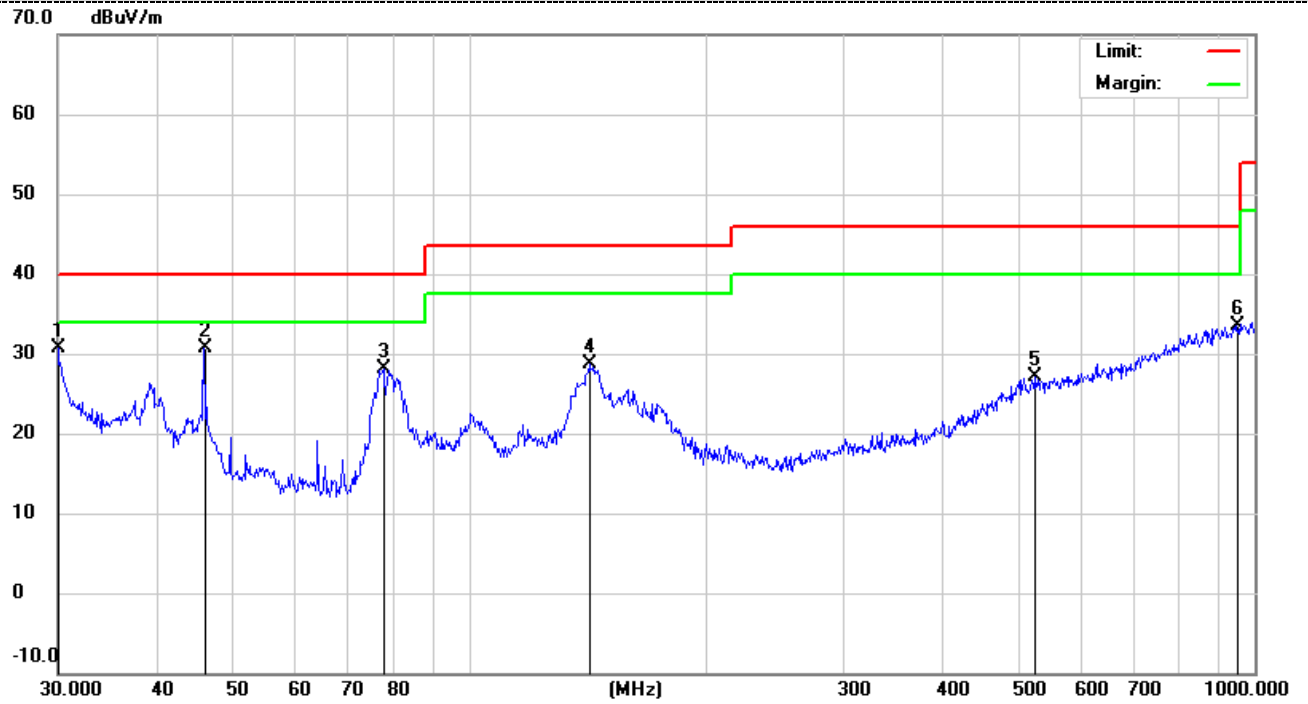

No.	Mk.	Freq. MHz	Reading Level dBuV	Correct Factor dB	Measure- ment dBuV/m	Limit dBuV/m	Over dB	Antenna Height cm	Table Degree	Comment
1		30.0000	9.77	20.90	30.67	40.00	-9.33	QP	200	125
2	*	46.0164	20.79	10.01	30.80	40.00	-9.20	QP	200	214
3		77.8654	18.23	9.93	28.16	40.00	-11.84	QP	200	225
4		142.3243	11.98	16.70	28.68	43.50	-14.82	QP	200	88
5		524.5541	4.05	22.97	27.02	46.00	-18.98	QP	200	169
6		948.7610	3.99	29.49	33.48	46.00	-12.52	QP	200	122

\*:Maximum data    x:Over limit    !:over margin

Vertical

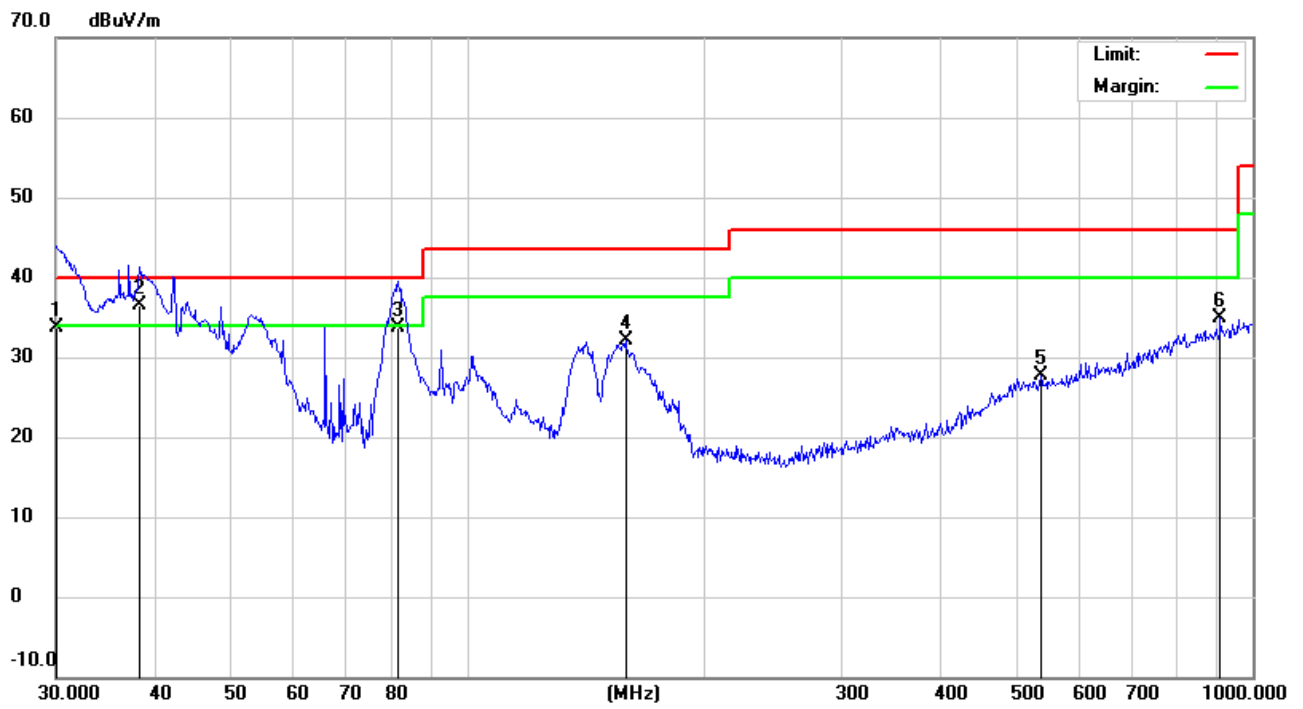

No.	Mk.	Freq. MHz	Reading Level dBuV	Correct Factor dB	Measure- ment dBuV/m	Limit dBuV/m	Over dB	Antenna Height cm	Table Degree	Comment
1		30.0000	12.80	20.90	33.70	40.00	-6.30	QP	100	251
2	*	38.3462	21.50	15.02	36.52	40.00	-3.48	QP	100	187
3		81.7832	23.70	10.06	33.76	40.00	-6.24	QP	100	298
4		159.2249	14.76	17.33	32.09	43.50	-11.41	QP	100	301
5		537.5891	4.65	23.11	27.76	46.00	-18.24	QP	100	254
6		909.6666	5.83	29.10	34.93	46.00	-11.07	QP	100	320

\*:Maximum data    x:Over limit    !:over margin

For 1GHz to 25GHz

**GFSK (above 1GHz)**

Frequency(MHz):			2402		Polarity:		HORIZONTAL		
Frequency (MHz)	Emission Level (dBuV/m)		Limit (dBuV/m)	Margin (dB)	Raw Value (dBuV)	Antenna Factor (dB/m)	Cable Factor (dB)	Pre-amplifier (dB)	Correction Factor (dB/m)
4804.00	55.05	PK	74	18.95	53.15	31.42	6.98	36.5	1.9
4804.00	44.62	AV	54	9.38	42.72	31.42	6.98	36.5	1.9
7206.00	51.09	PK	74	22.91	40.49	37.03	8.87	35.3	10.6
7206.00	42.42	AV	54	11.58	31.82	37.03	8.87	35.3	10.6

Frequency(MHz):			2402		Polarity:		VERTICAL		
Frequency (MHz)	Emission Level (dBuV/m)		Limit (dBuV/m)	Margin (dB)	Raw Value (dBuV)	Antenna Factor (dB/m)	Cable Factor (dB)	Pre-amplifier (dB)	Correction Factor (dB/m)
4804.00	55.02	PK	74	18.98	53.12	31.42	6.98	36.5	1.9
4804.00	43.39	AV	54	10.61	41.49	31.42	6.98	36.5	1.9
7206.00	52.9	PK	74	21.1	42.3	37.03	8.87	35.3	10.6
7206.00	41.64	AV	54	12.36	31.04	37.03	8.87	35.3	10.6

Frequency(MHz):			2440		Polarity:		HORIZONTAL		
Frequency (MHz)	Emission Level (dBuV/m)		Limit (dBuV/m)	Margin (dB)	Raw Value (dBuV)	Antenna Factor (dB/m)	Cable Factor (dB)	Pre-amplifier (dB)	Correction Factor (dB/m)
4880.00	52.63	PK	74	21.37	50.57	30.98	7.58	36.5	2.06
4880.00	46.38	AV	54	7.62	44.32	30.98	7.58	36.5	2.06
7320.00	53.2	PK	74	20.8	42.28	37.66	8.56	35.3	10.92
7320.00	43.02	AV	54	10.98	32.1	37.66	8.56	35.3	10.92

Frequency(MHz):			2440		Polarity:		VERTICAL		
Frequency (MHz)	Emission Level (dBuV/m)		Limit (dBuV/m)	Margin (dB)	Raw Value (dBuV)	Antenna Factor (dB/m)	Cable Factor (dB)	Pre-amplifier (dB)	Correction Factor (dB/m)
4880.00	57.64	PK	74	16.36	55.58	30.98	7.58	36.5	2.06
4880.00	43.13	AV	54	10.87	41.07	30.98	7.58	36.5	2.06
7320.00	54.72	PK	74	19.28	43.8	37.66	8.56	35.3	10.92
7320.00	41.86	AV	54	12.14	30.94	37.66	8.56	35.3	10.92

Frequency(MHz):			2480		Polarity:		HORIZONTAL		
Frequency (MHz)	Emission Level (dBuV/m)		Limit (dBuV/m)	Margin (dB)	Raw Value (dBuV)	Antenna Factor (dB/m)	Cable Factor (dB)	Pre-amplifier (dB)	Correction Factor (dB/m)
4960.00	56.14	PK	74	17.86	53.07	31.47	7.8	36.2	3.07
4960.00	46.29	AV	54	7.71	43.22	31.47	7.8	36.2	3.07
7440.00	53.46	PK	74	20.54	41.72	38.32	8.72	35.3	11.74
7440.00	44.18	PK	54	9.82	32.44	38.32	8.72	35.3	11.74

Frequency(MHz):			2480		Polarity:		VERTICAL		
Frequency (MHz)	Emission Level (dBuV/m)		Limit (dBuV/m)	Margin (dB)	Raw Value (dBuV)	Antenna Factor (dB/m)	Cable Factor (dB)	Pre-amplifier (dB)	Correction Factor (dB/m)
4960.00	54.22	PK	74	19.78	51.15	31.47	7.8	36.2	3.07
4960.00	47.77	AV	54	6.23	44.7	31.47	7.8	36.2	3.07
7440.00	54.24	PK	74	19.76	42.5	38.32	8.72	35.3	11.74
7440.00	43.51	PK	54	10.49	31.77	38.32	8.72	35.3	11.74

REMARKS:

1. Emission level (dBuV/m) =Raw Value (dBuV)+Correction Factor (dB/m)
2. Correction Factor (dB/m) = Antenna Factor (dB/m)+Cable Factor (dB)- Pre-amplifier
3. Margin value = Limit value- Emission level.
4. -- Mean the PK detector measured value is below average limit.
5. The other emission levels were very low against the limit.

### 5.3. Maximum Peak Output Power

#### TEST CONFIGURATION

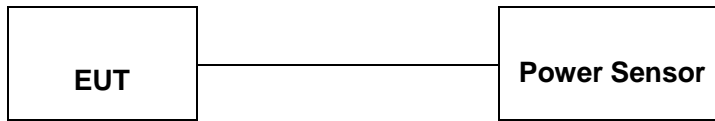

#### TEST PROCEDURE

According to KDB558074 D01 DTS Measurement Guidance Section 9.1 Maximum peak conducted output power,9.1.2.

The maximum peak conducted output power may be measured using a broadband peak RF power meter. The power meter shall have a video bandwidth that is greater than or equal to the DTS bandwidth and shall utilize a fast-responding diode detector.

#### LIMIT

The Maximum Peak Output Power Measurement is 30dBm.

#### TEST RESULTS

See Appendix I

## 5.4. Power Spectral Density

### TEST CONFIGURATION

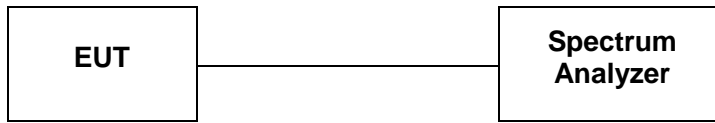

### TEST PROCEDURE

1. Use this procedure when the maximum peak conducted output power in the fundamental emission is used to demonstrate compliance.
2. Set the RBW = 3 kHz.
3. Set the VBW = 10 KHz.
4. Set the span to 1.5 times the DTS channel bandwidth.
5. Detector = peak.
6. Sweep time = auto couple.
7. Trace mode = max hold.
8. Allow trace to fully stabilize.
9. Use the peak marker function to determine the maximum power level.
10. If measured value exceeds limit, reduce RBW (no less than 3 kHz) and repeat.
11. The resulting peak PSD level must be 8 dBm.

### LIMIT

For digitally modulated systems, the power spectral density conducted from the intentional radiator to the antenna shall not be greater than 8 dBm in any 3 kHz band during any time interval of continuous transmission.

### TEST RESULTS

See APPENDIX V

## 5.5. 6dB Bandwidth and 99% Bandwidth

### TEST CONFIGURATION

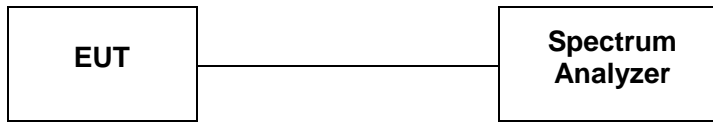

### TEST PROCEDURE

The transmitter output was connected to the spectrum analyzer through an attenuator. The bandwidth of the fundamental frequency was measured by spectrum analyzer with RBW=100 KHz and VBW=300KHz. The 6dB bandwidth is defined as the total spectrum the power of which is higher than peak power minus 6dB. According to KDB558074 D01 V03 for one of the following procedures may be used to determine the modulated DTS device signal bandwidth.

1. Set RBW = 100 kHz.
2. Set the video bandwidth (VBW)  $\geq 3$  RBW.
3. Detector = Peak.
4. Trace mode = max hold.
5. Sweep = auto couple.
6. Allow the trace to stabilize.
7. Measure the maximum width of the emission that is constrained by the frequencies associated with the two outermost amplitude points (upper and lower frequencies) that are attenuated by 6 dB relative to the maximum level measured in the fundamental emission.

The transmitter output was connected to the spectrum analyzer through an attenuator. The bandwidth of the fundamental frequency was measured by spectrum analyzer with 43 KHz RBW and 150 KHz VBW record the 99% bandwidth.

### LIMIT

For digital modulation systems, the minimum 6 dB bandwidth shall be at least 500 kHz

### TEST RESULTS

See Appendix II&Appendix III



### 5.6. Band Edge Compliance of RF Emission

#### TEST REQUIREMENT

In any 100 kHz bandwidth outside the frequency band in which the spread spectrum or digitally modulated intentional radiator is operating, the radio frequency power that is produced by the intentional radiator shall be at least 20 dB below that in the 100 kHz bandwidth within the band that contains the highest level of the desired power, based on either an RF conducted or a radiated measurement, provided the transmitter demonstrates compliance with the peak conducted power limits. If the transmitter complies with the conducted power limits based on the use of RMS averaging over a time interval, as permitted under paragraph (b)(3) of this section, the attenuation required under this paragraph shall be 30 dB instead of 20 dB. Attenuation below the general limits specified in §15.209(a) is not required. In addition, radiated emissions which fall in the restricted bands, as defined in §15.205(a), must also comply with the radiated emission limits specified in §15.209(a) (see §15.205(c)).

#### TEST CONFIGURATION

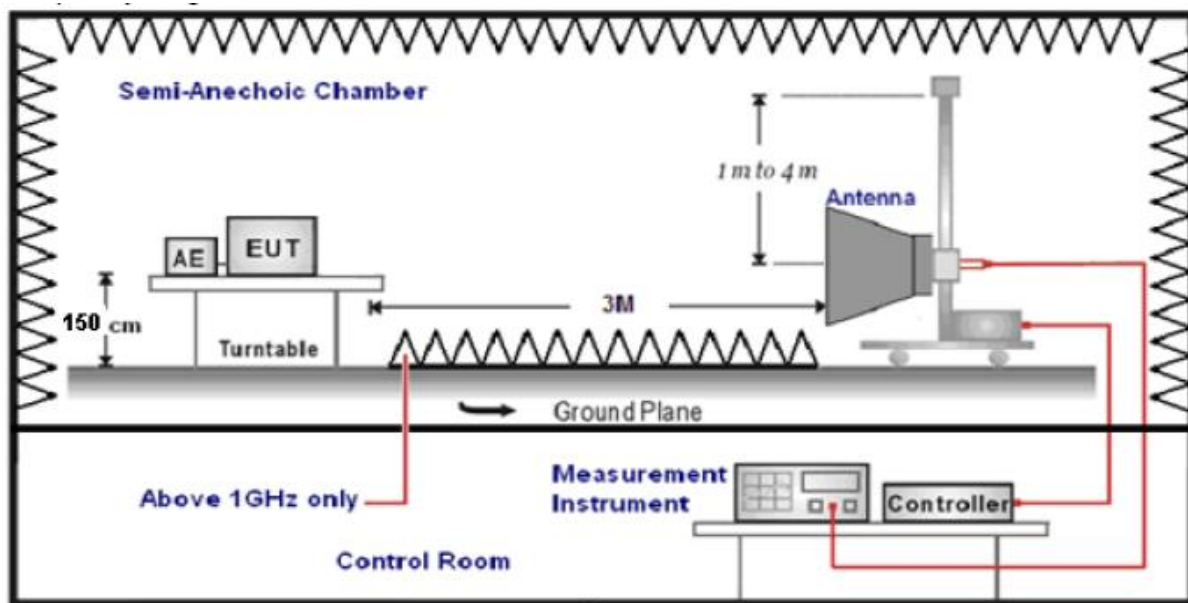

#### TEST PROCEDURE

1. The EUT was placed on a turn table which is 1.5m above ground plane.
2. Maximum procedure was performed by raising the receiving antenna from 1m to 4m and rotating the turn table from 0° to 360° to acquire the highest emissions from EUT.
3. And also, each emission was to be maximized by changing the polarization of receiving antenna both horizontal and vertical.
4. Repeat above procedures until all frequency measurements have been completed..
5. The distance between test antenna and EUT was 3 meter:
6. Setting test receiver/spectrum as following table states:

Test Frequency range	Test Receiver/Spectrum Setting	Detector
1GHz-40GHz	Peak Value: RBW=1MHz/VBW=3MHz, Sweep time=Auto Average Value: RBW=1MHz/VBW=10Hz, Sweep time=Auto	Peak

#### LIMIT

Below -20dB of the highest emission level in operating band.  
Radiated emissions which fall in the restricted bands, as defined in § 15.205(a), must also comply with the radiated emission limits specified in § 15.209(a)

**TEST RESULTS****Results of Band Edges Test (Radiated)****GFSK**

Frequency(MHz):			2402		Polarity:		HORIZONTAL		
Frequency (MHz)	Emission Level (dBuV/m)		Limit (dBuV/m)	Margin (dB)	Raw Value (dBuV)	Antenna Factor (dB/m)	Cable Factor (dB)	Pre-amplifier (dB)	Correction Factor (dB/m)
2390.00	56.07	PK	74	17.93	61.48	27.49	3.32	36.22	-5.41
2390.00	41.32	AV	54	12.68	46.73	27.49	3.32	36.22	-5.41
Frequency(MHz):			2402		Polarity:		VERTICAL		
Frequency (MHz)	Emission Level (dBuV/m)		Limit (dBuV/m)	Margin (dB)	Raw Value (dBuV)	Antenna Factor (dB/m)	Cable Factor (dB)	Pre-amplifier (dB)	Correction Factor (dB/m)
2390.00	58.08	PK	74	15.92	63.49	27.49	3.32	36.22	-5.41
2390.00	42.57	AV	54	11.43	47.98	27.49	3.32	36.22	-5.41
Frequency(MHz):			2480		Polarity:		HORIZONTAL		
Frequency (MHz)	Emission Level (dBuV/m)		Limit (dBuV/m)	Margin (dB)	Raw Value (dBuV)	Antenna Factor (dB/m)	Cable Factor (dB)	Pre-amplifier (dB)	Correction Factor (dB/m)
2483.50	55.56	PK	74	18.44	61.07	27.45	3.38	36.34	-5.51
2483.50	40.12	AV	54	13.88	45.63	27.45	3.38	36.34	-5.51
Frequency(MHz):			2480		Polarity:		VERTICAL		
Frequency (MHz)	Emission Level (dBuV/m)		Limit (dBuV/m)	Margin (dB)	Raw Value (dBuV)	Antenna Factor (dB/m)	Cable Factor (dB)	Pre-amplifier (dB)	Correction Factor (dB/m)
2483.50	58.83	PK	74	15.17	64.34	27.45	3.38	36.34	-5.51
2483.50	40.7	AV	54	13.3	46.21	27.45	3.38	36.34	-5.51

## REMARKS:

1. Emission level (dBuV/m) =Raw Value (dBuV)+Correction Factor (dB/m)
2. Correction Factor (dB/m) = Antenna Factor (dB/m)+Cable Factor (dB)- Pre-amplifier
3. Margin value = Limit value- Emission level.
4. -- Mean the PK detector measured value is below average limit.

## 5.7. Spurious RF Conducted Emission

### TEST CONFIGURATION

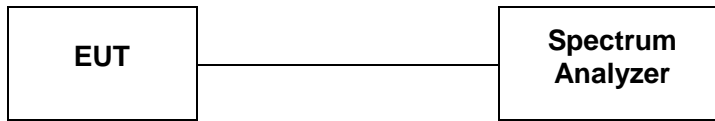

### TEST PROCEDURE

The Spurious RF conducted emissions compliance of RF radiated emission should be measured by following the guidance in ANSI C63.10-2013 with respect to maximizing the emission by rotating the EUT, measuring the emission while the EUT is situated in three orthogonal planes (if appropriate), adjusting the measurement antenna height and polarization etc. Set RBW=100kHz and VBW= 300KHz to measure the peak field strength, and measure frequency range from 9KHz to 25GHz.

### LIMIT

1. Below -20dB of the highest emission level in operating band.
2. Fall in the restricted bands listed in section 15.205. The maximum permitted average field strength is listed in section 15.209.

### TEST RESULTS

See Appendix IV

## 5.8. Antenna Requirement

### **Standard Applicable**

For intentional device, according to FCC 47 CFR Section 15.203, an intentional radiator shall be designed to ensure that no antenna other than that furnished by the responsible party shall be used with the device.

And according to FCC 47 CFR Section 15.247 (c), if transmitting antennas of directional gain greater than 6dBi are used, the power shall be reduced by the amount in dB that the directional gain of the antenna exceeds 6dBi.

### **Refer to statement below for compliance**

The manufacturer may design the unit so that the user can replace a broken antenna, but the use of a standard antenna jack or electrical connector is prohibited. Further, this requirement does not apply to intentional radiators that must be professionally installed.

### **Antenna Connected Construction**

The directional gains of antenna used for transmitting is -1.59dBi, and the antenna is an PCB Antenna to PCB board and no consideration of replacement. Please see EUT photo for details.

Results: Compliance.

## 6. Test Setup Photos of the EUT

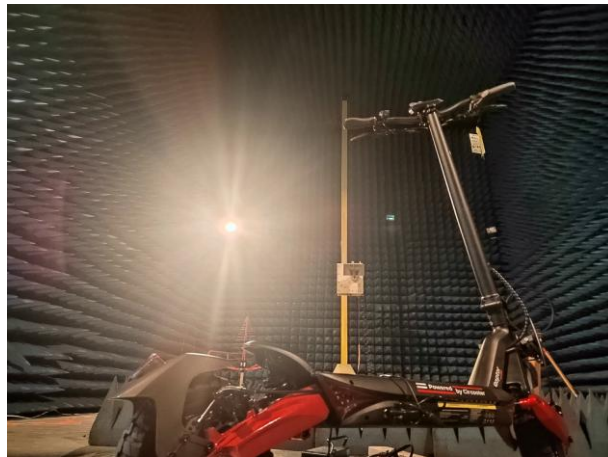

## **7. External and Internal Photos of the EUT**

See related photo report.

### APPENDIX I. Conducted Peak Output Power

#### Test Result

Mode	Channel	Peak Output Power (dBm)	Peak Output Power (mW)	Max. Avg. Power (dBm)	Limit (dBm)	Result
LE	0	-2.454	0.57	None	30	PASS
	19	-2.510	0.56	None	30	PASS
	39	-2.305	0.59	None	30	PASS

#### Test Graphs

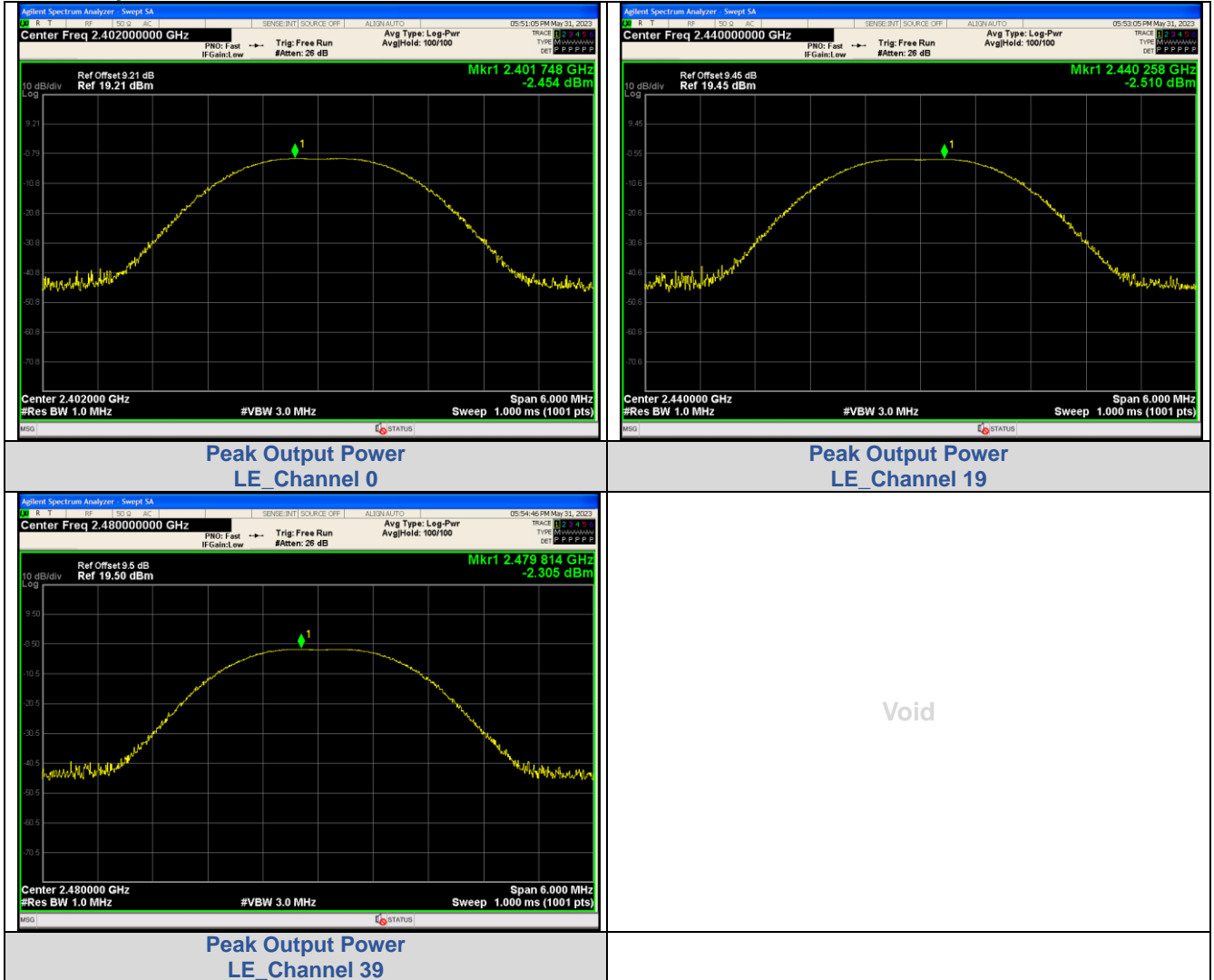

### APPENDIX II.99% Bandwidth

#### Test Result

Mode	Channel	99% BW (MHz)
LE	0	1.0055
LE	19	1.0204
LE	39	1.0189

#### Test Graphs

<p><b>LE_Channel 0</b></p>	<p><b>LE_Channel 19</b></p>
<p><b>LE_Channel 39</b></p>	<p style="text-align: center;">Void</p>



### APPENDIX III.6dB Bandwidth

#### Test Result

Mode	Channel	Center Frequency (MHz)	6 dB Bandwidth (MHz)	Limit (MHz)	Result
LE	0	2402	0.6784	0.5	PASS
	19	2440	0.6580		PASS
	39	2480	0.7017		PASS

#### Test Graphs

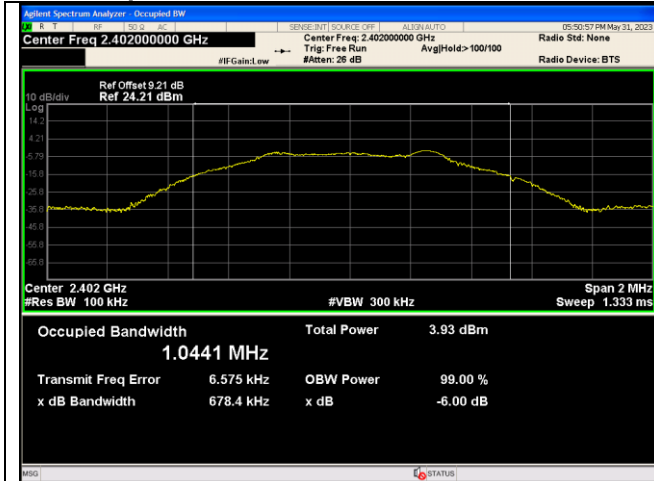

LE\_Channel 0

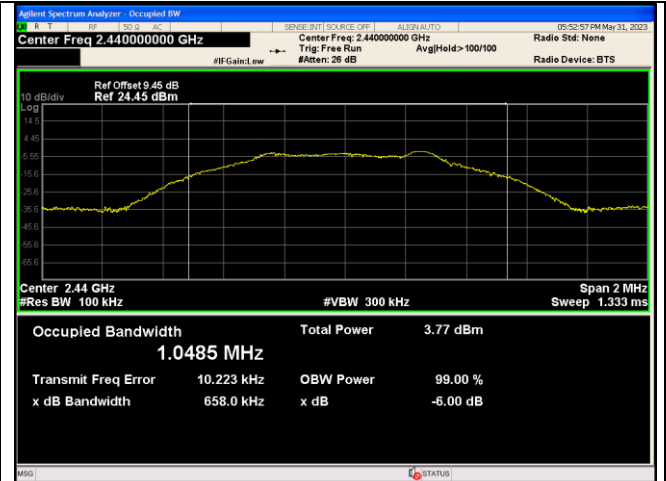

LE\_Channel 19

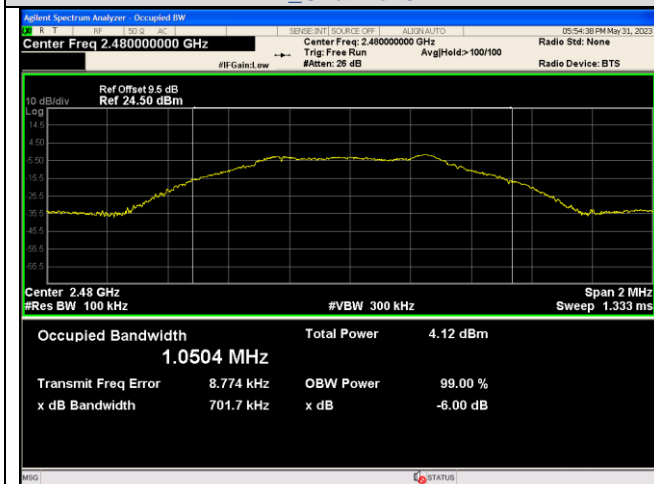

LE\_Channel 39

Void

APPENDIX IV. Conducted Out Of Band Emission

Test Result

Mode	Channel	OOB Emission Frequency (MHz)	OOB Emission Level (dBm)	Limit (dBm)	Over Limit (dB)	Result
LE	0	2400.00	-48.032	-22.52	-26	PASS
		900.23	-27.583	-22.52	-5.063	PASS
	19	7320.80	-45.127	-22.55	-22.577	PASS
	39	2483.50	-54.050	-22.4	-32	PASS
		24877.6	-47.253	-22.4	-24.853	PASS

Test Graphs

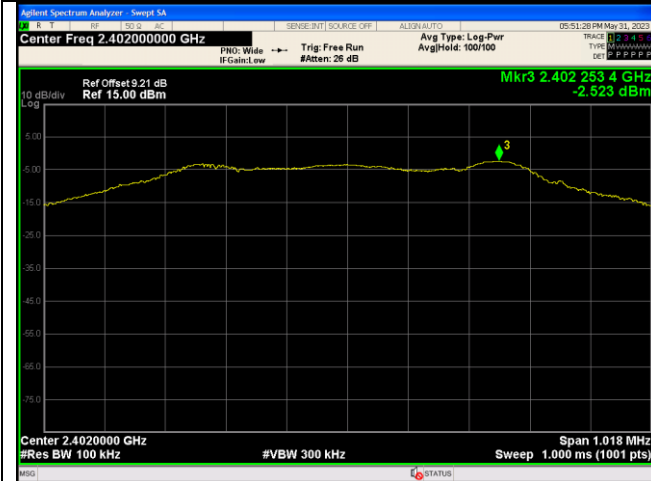

In-Band Reference Level  
LE\_Channel 0

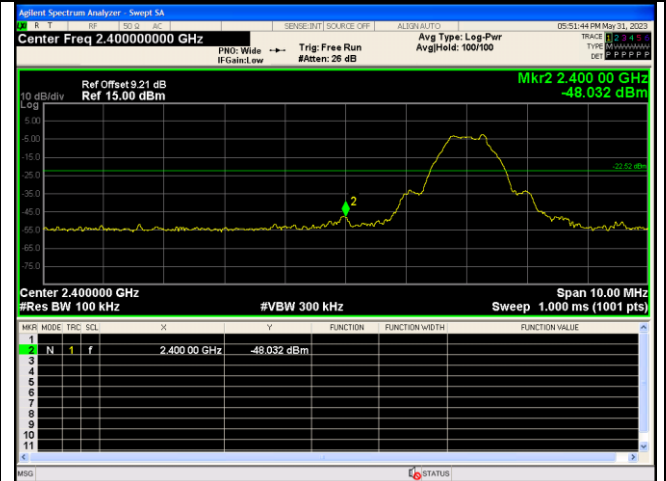

Out Of Band Emission  
LE\_Channel 0

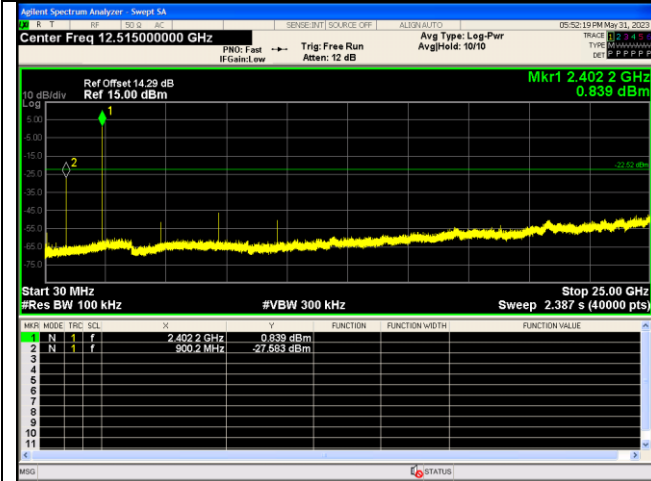

Spurious Emission  
LE\_Channel 0

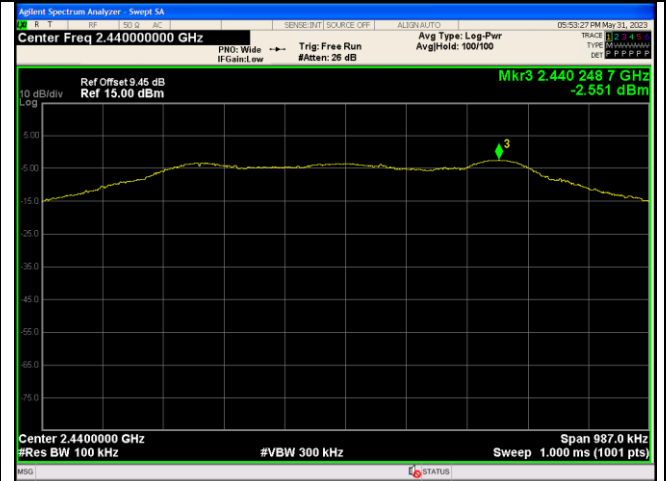

In-Band Reference Level  
LE\_Channel 19

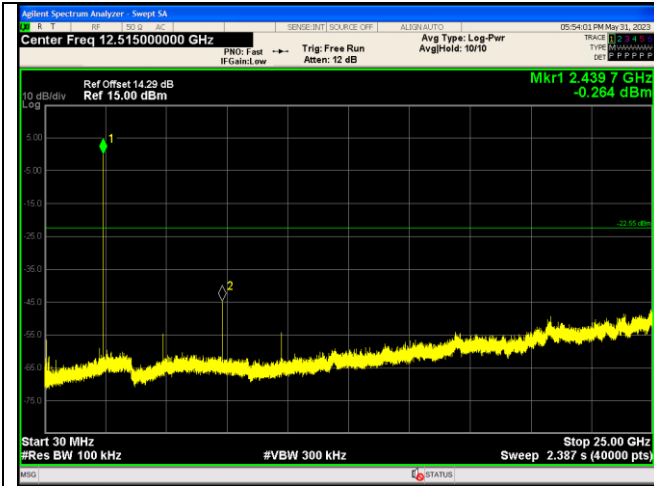

Spurious Emissions  
LE\_Channel 19

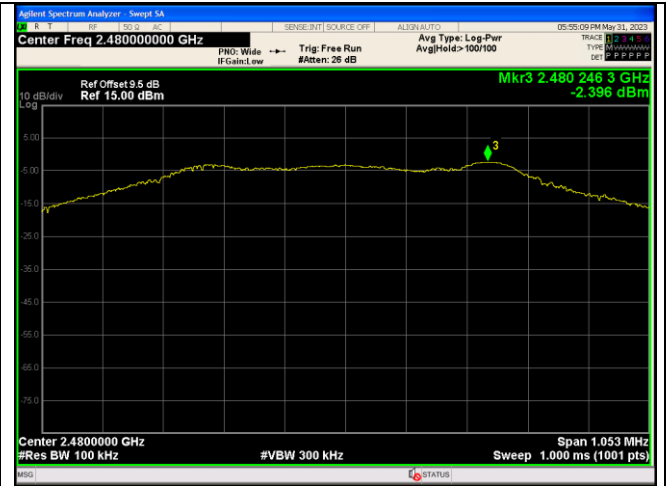

In-Band Reference Level  
LE\_Channel 39

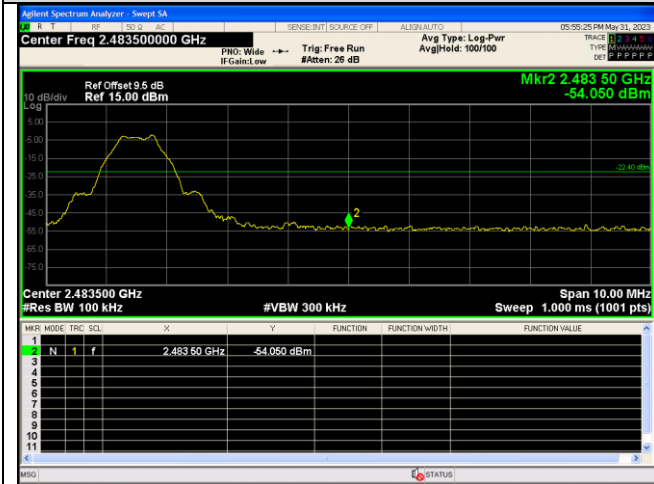

Out Of Band Emission  
LE\_Channel 39

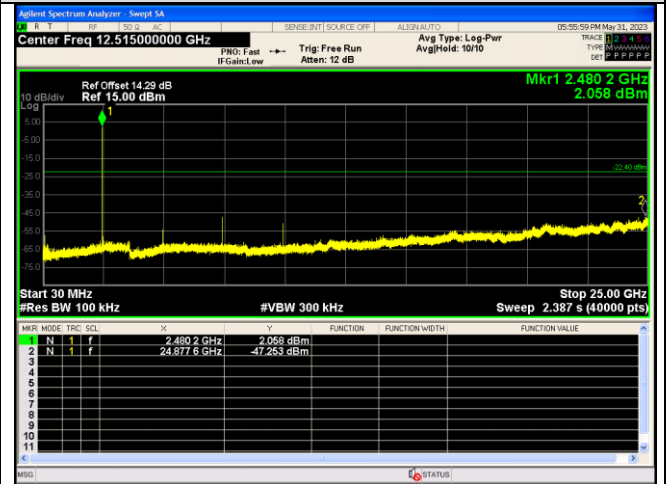

Spurious Emission  
LE\_Channel 39

### APPENDIX V. Power Spectral Density

#### Test Result

Mode	Channel	PSD (dBm/3kHz)	Limit (dBm/3kHz)	Result
LE	0	-17.954	8	PASS
LE	19	-18.094	8	PASS
LE	39	-17.771	8	PASS

#### Test Graphs

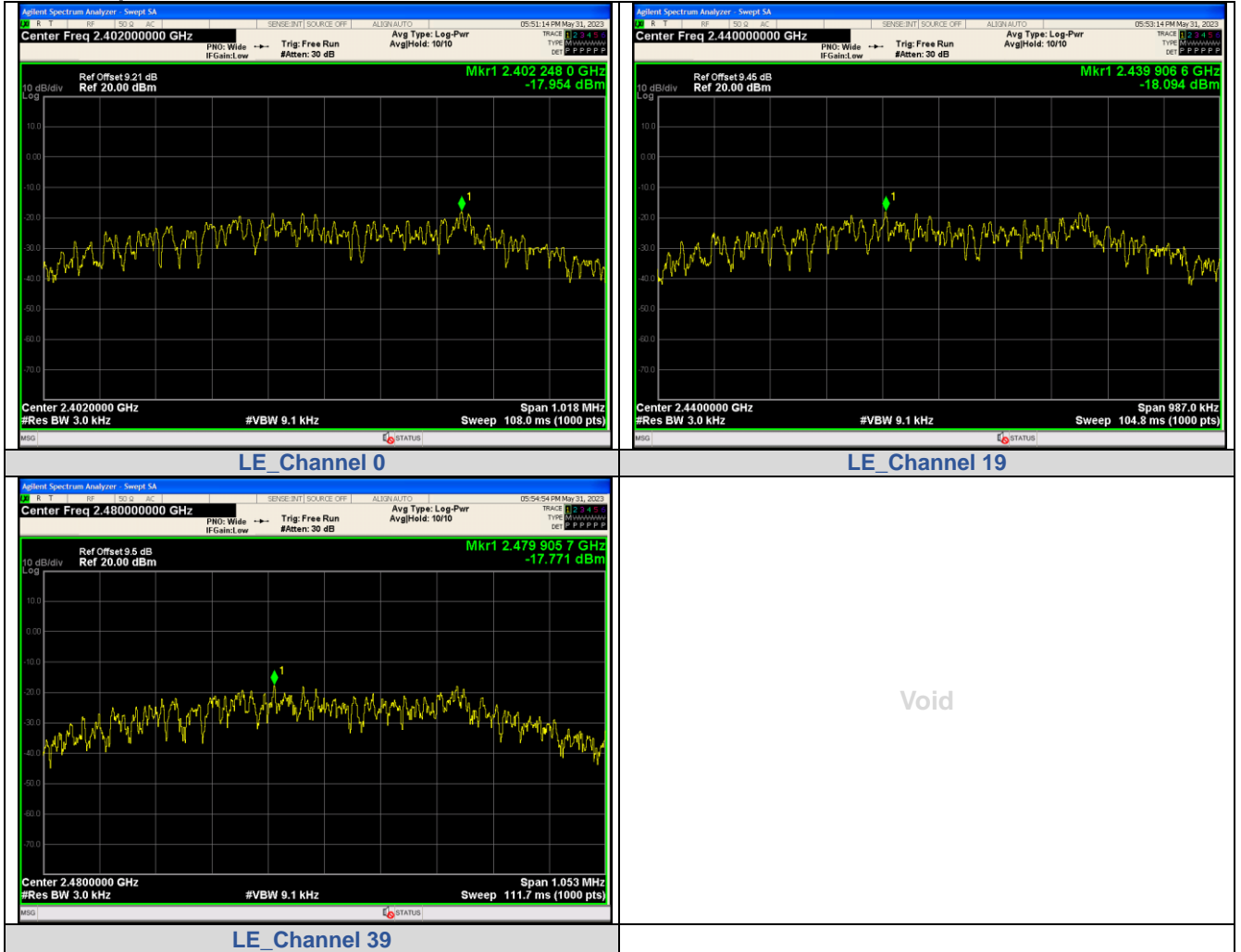

.....End of Report.....