

# FCC RADIO TEST REPORT

**FCC ID: 2BBGJ-MMSMS**

**Sample :** Mini Rechargeable Speaker

**Trade Name :** N/A

**Main Model :** MMSMS24

**Additional Model :** N/A

**Report No. :** UNIA23053103ER-61

## Prepared for

Yiwu VIFA Imp.&Exp. Co., LTD  
11th Floor, A8 Building, Headquarters Economic Park, Choujiang Street,  
Yiwu, China

## Prepared by

Shenzhen United Testing Technology Co., Ltd.  
D101, No. 107, Kaicheng High-Tech Park, Taoyuan Community,  
Dalang Sub-District, Longhua District, Shenzhen, Guangdong, China/518109

## TEST RESULT CERTIFICATION

**Applicant**..... Yiwu VIFA Imp.&Exp. Co., LTD  
Address..... 11th Floor, A8 Building, Headquarters Economic Park, Choujiang Street, Yiwu, China

**Manufacturer**..... Yiwu VIFA Imp.&Exp. Co., LTD  
Address..... 11th Floor, A8 Building, Headquarters Economic Park, Choujiang Street, Yiwu, China

### Product description

Product..... Mini Rechargeable Speaker  
Trade Name..... N/A  
Model Name..... MMSMS24

**Test Methods**..... FCC Rules and Regulations Part 15 Subpart C Section 15.249,  
ANSI C63.10: 2013

This device described above has been tested by Shenzhen ZKT Technology Co., Ltd., and the test results show that the equipment under test (EUT) is in compliance with the FCC requirements. And it is applicable only to the tested sample identified in the report. This report shall not be reproduced except in full, without the written approval of UNI, this document may be altered or revised by Shenzhen United Testing Technology Co., Ltd., personnel only, and shall be noted in the revision of the document.

### Date of Test .....

Date (s) of performance of tests ..... May 31, 2023 ~ Jun. 13, 2023  
Date of Issue..... Jun. 14, 2023  
Test Result ..... Pass

Prepared by:

*Jason Ye*  
\_\_\_\_\_  
Jason Ye/Supervisor

Reviewer:

*Kelly Cheng*  
\_\_\_\_\_  
Kelly Cheng/Supervisor

Approved & Authorized Signer:

*Liuze*  
\_\_\_\_\_  
Liuze/Manager

**Table of Contents**

**Pages**

<b>1 TEST SUMMARY</b>	<b>5</b>
1.1 TEST PROCEDURES AND RESULTS	5
1.2 TEST FACILITY	6
1.3 MEASUREMENT UNCERTAINTY	7
1.4 ENVIRONMENTAL CONDITIONS	7
<b>2 GENERAL INFORMATION</b>	<b>8</b>
2.1 GENERAL DESCRIPTION OF EUT	8
2.2 CARRIER FREQUENCY OF CHANNELS	9
2.3 DESCRIPTION OF TEST MODES	9
2.4 TEST SETUP	10
2.5 EQUIPMENT USED IN TESTED SYSTEM	10
2.6 MEASUREMENT INSTRUMENTS LIST	11
<b>3 CONDUCTED EMISSION</b>	<b>12</b>
3.1 TEST LIMIT	12
3.2 TEST SETUP	12
3.3 TEST PROCEDURE	13
3.4 TEST RESULT	13
<b>4 RADIATED EMISSION</b>	<b>16</b>
4.1 TEST LIMIT	16
4.2 TEST SETUP	17
4.3 TEST PROCEDURE	18
4.4 TEST RESULT	18
<b>5 BAND EDGE</b>	<b>30</b>
5.1 TEST LIMIT	30
5.2 TEST SETUP	30
5.3 MEASUREMENT EQUIPMENT USED	30
5.4 TEST PROCEDURE	30
5.5 TEST RESULT	30
<b>6 OCCUPIED BANDWIDTH</b>	<b>33</b>
6.1 TEST SETUP (BLOCK DIAGRAM OF CONFIGURATION)	33
6.2 MEASUREMENT EQUIPMENT USED	33
6.3 TEST PROCEDURE	33
6.4 TEST RESULT	33



**Table of Contents**

**Pages**

7 ANTENNA REQUIREMENT

40

8 PHOTO OF TEST

41

## 1 TEST SUMMARY

### 1.1 TEST PROCEDURES AND RESULTS

Item	FCC Rules	Description Of Test	Result
1	FCC Part 15.207	Conducted Emission	Pass
2	FCC Part 15.209/15.249	Radiated Emission	Pass
3	FCC Part 15.249/15.205	Band Edge	Pass
4	FCC Part 15.215	Occupied Bandwidth	Pass
5	FCC Part 15.203	Antenna Requirement	Pass

Note:

“N/A” denotes test is not applicable in this Test Report.

## 1.2 TEST FACILITY

Test Firm : Shenzhen ZKT Technology Co., Ltd.  
Address : 1/F, No. 101, Building B, No. 6, Tangwei Community Industrial Avenue,  
Fuhai Street, Bao'an District, Shenzhen, China

The testing quality ability of our laboratory meet with "Quality Law of People's Republic of China" Clause 19. The testing quality system of our laboratory meets with ISO/IEC-17025 requirements. This approval result is accepted by MRA of APLAC.

Our test facility is recognized, certified, or accredited by the following organizations:

Designation Number: CN1299

The EMC Laboratory has been accredited by A2LA, and in compliance with ISO/IEC 17025:2017 General Requirements for testing Laboratories.

FCC Registration Number: 692225

The EMC Laboratory has been registered and fully described in a report filed with the (FCC) Federal Communications commission.

IC Registration Number: 27033

The EMC Laboratory has been registered and fully described in a report filed with the (IC) Industry Canada.

### 1.3 MEASUREMENT UNCERTAINTY

The reported uncertainty of measurement  $y \pm U$ , where expanded uncertainty  $U$  is based on a standard uncertainty multiplied by a coverage factor of  $k=2$ , providing a level of confidence of approximately 95 %.

A. Conducted Measurement:

Test Site	Method	Measurement Frequency Range	U, (dB)	NOTE
UNI	ANSI	9kHz ~ 150kHz	2.96	
		150kHz ~ 30MHz	2.44	

B. Radiated Measurement:

Test Site	Method	Measurement Frequency Range	U, (dB)	NOTE
UNI	ANSI	9kHz ~ 30MHz	2.50	
		30MHz ~ 1000MHz	4.80	
		Above 1000MHz	4.13	

C. RF Conducted Method:

Item	Measurement Uncertainty
Uncertainty of total RF power, conducted	$U_c = \pm 0.8$ dB
Uncertainty of RF power density, conducted	$U_c = \pm 2.6$ dB
Uncertainty of spurious emissions, conducted	$U_c = \pm 2$ %
Uncertainty of Occupied Channel Bandwidth	$U_c = \pm 2$ %

### 1.4 ENVIRONMENTAL CONDITIONS

During the measurement the environmental conditions were within the listed ranges:

	NORMAL CONDITIONS	EXTREME CONDITIONS
Temperature range ( °C)	15 - 35	-20 - 50
Relative humidity range	20 % - 75 %	20 % - 75 %
Pressure range (kPa)	86 - 106	86 - 106

Note: The Extreme Temperature and Extreme Voltages declared by the manufacturer.

## 2 GENERAL INFORMATION

### 2.1 GENERAL DESCRIPTION OF EUT

Product:	Mini Rechargeable Speaker
Trade Name:	N/A
Main Model:	MMSMS24
Additional Model:	N/A
Model Difference:	N/A
FCC ID:	2BBGJ-MMSMS
Operation Frequency:	2402MHz~2480MHz
Number of Channels:	79CH
Field Strength of Fundamental:	93.77dBuV/m
Modulation Type:	GFSK, $\pi/4$ DQPSK, 8DPSK
Antenna Type:	PCB Antenna
Antenna Gain:	1.3dBi
Battery:	N/A
Adapter:	N/A
Power Source:	DC 5V from adapter or DC 3.7V from Li-ion battery

## 2.2 CARRIER FREQUENCY OF CHANNELS

Channel List							
Channel	Frequency (MHz)	Channel	Frequency (MHz)	Channel	Frequency (MHz)	Channel	Frequency (MHz)
00	2402	21	2423	42	2444	63	2465
01	2403	22	2424	43	2445	64	2466
02	2404	23	2425	44	2446	65	2467
03	2405	24	2426	45	2447	66	2468
04	2406	25	2427	46	2448	67	2469
05	2407	26	2428	47	2449	68	2470
06	2408	27	2429	48	2450	69	2471
07	2409	28	2430	49	2451	70	2472
08	2410	29	2431	50	2452	71	2473
09	2411	30	2432	51	2453	72	2474
10	2412	31	2433	52	2454	73	2475
11	2413	32	2434	53	2455	74	2476
12	2414	33	2435	54	2456	75	2477
13	2415	34	2436	55	2457	76	2478
14	2416	35	2437	56	2458	77	2479
15	2417	36	2438	57	2459	78	2480
16	2418	37	2439	58	2460		
17	2419	38	2440	59	2461		
18	2420	39	2441	60	2462		
19	2421	40	2442	61	2463		
20	2422	41	2443	62	2464		

## 2.3 DESCRIPTION OF TEST MODES

No.	Test Mode Description
1	Low channel TX
2	Middle channel TX
3	High channel TX
<p>Note: 1. For Radiated Emission, 3axis were chosen for testing for each applicable mode.            2.For Conducted Test method,at emporary antenna connector is provided by the manufacture.</p>	

## 2.4 TEST SETUP

Operation of EUT during Radiation testing:



Operation of EUT during RF Conducted testing:

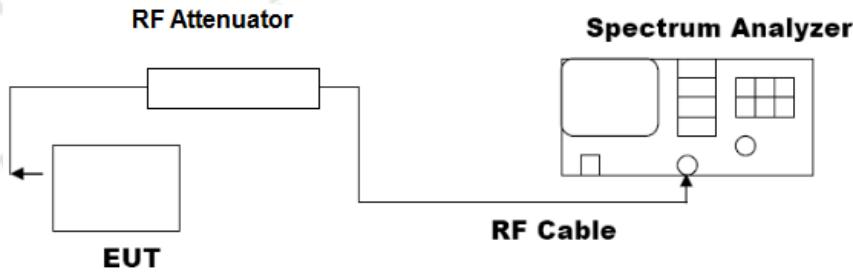

## 2.5 EQUIPMENT USED IN TESTED SYSTEM

Item	Equipment	Model/Type No.	Cable Length(m)	Note
1	Mini Rechargeable Speaker	MMSMS24	0.3	EUT

Note:

1. The support equipment was authorized by Declaration of Confirmation.
2. All the above equipment/cables were placed in worse case positions to maximize emission signals during emission test.

## 2.6 MEASUREMENT INSTRUMENTS LIST

Item	Equipment	Manufacturer	Model No.	Serial No.	Calibrated until
Conduction Emissions Measurement					
1	Conducted Emission Test Software	EZ-EMC	Ver.CCS-3A1-CE	N/A	N/A
2	AMN	Schwarzbeck	NNLK8121	8121370	2023.09.22
3	AAN	TESEQ	T8-Cat6	38888	2023.09.22
4	Pulse Limiter	CYBRTEK	EM5010	E115010056	2024.05.30
5	EMI Test Receiver	Rohde&Schwarz	ESCI	101210	2023.09.22
Radiated Emissions Measurement					
1	Radiated Emission Test Software	EZ-EMC	Ver.CCS-03A1	N/A	N/A
2	Horn Antenna	Sunol	DRH-118	A101415	2023.09.27
3	Broadband Hybrid Antenna	Sunol	JB1	A090215	2024.02.26
4	PREAMP	HP	8449B	3008A00160	2023.09.22
5	PREAMP	HP	8447D	2944A07999	2024.05.30
6	EMI TEST RECEIVER	Rohde&Schwarz	ESR3	101891	2023.09.22
7	VECTOR Signal Generator	Rohde&Schwarz	SMU200A	101521	2023.09.22
8	Signal Generator	Agilent	E4421B	MY4335105	2023.09.22
9	MXA Signal Analyzer	Agilent	N9020A	MY50510140	2023.09.22
10	MXA Signal Analyzer	Keysight	N9020A	MY51110104	2023.09.22
11	RF Power sensor	DARE	RPR3006W	15I00041SNO88	2024.05.30
12	RF Power sensor	DARE	RPR3006W	15I00041SNO89	2024.05.30
13	RF power divider	Anritsu	K241B	992289	2023.09.22
14	Wideband radio communication tester	Rohde&Schwarz	CMW500	154987	2023.09.22
15	Active Loop Antenna	Com-Power	AL-130R	10160009	2024.05.30
16	Broadband Hybrid Antennas	Schwarzbeck	VULB9163	VULB9163#958	2023.09.22
17	Horn Antenna	Schwarzbeck	BBHA9120D	9120D-1680	2024.05.30
18	Horn Antenna	A-INFOMW	LB-180400-KF	J211060660	2023.09.27
19	Microwave Broadband Preampfier	Schwarzbeck	BBV 9721	100472	2023.09.22
20	Signal Generator	Agilent	N5183A	MY47420153	2023.09.22
21	Spectrum Analyzer	Rohde&Schwarz	FSP 40	100501	2023.09.22
22	Power Meter	KEYSIGHT	N1911A	MY50520168	2023.09.22
23	Frequency Meter	VICTOR	VC2000	997406086	2023.09.22
24	DC Power Source	HYELEC	HY5020E	055161818	2023.09.22

### 3 CONDUCTED EMISSION

#### 3.1 TEST LIMIT

For unintentional device, according to § 15.207(a) Line Conducted Emission Limits is as following

Frequency (MHz)	Maximum RF Line Voltage (dB $\square$ V)			
	CLASS A		CLASS B	
	Q.P.	Ave.	Q.P.	Ave.
0.15~0.50	79	66	66~56*	56~46*
0.50~5.00	73	60	56	46
5.00~30.0	73	60	60	50

\* Decreasing linearly with the logarithm of the frequency.

For intentional device, according to §15.207(a) Line Conducted Emission Limit is same as above table.

#### 3.2 TEST SETUP

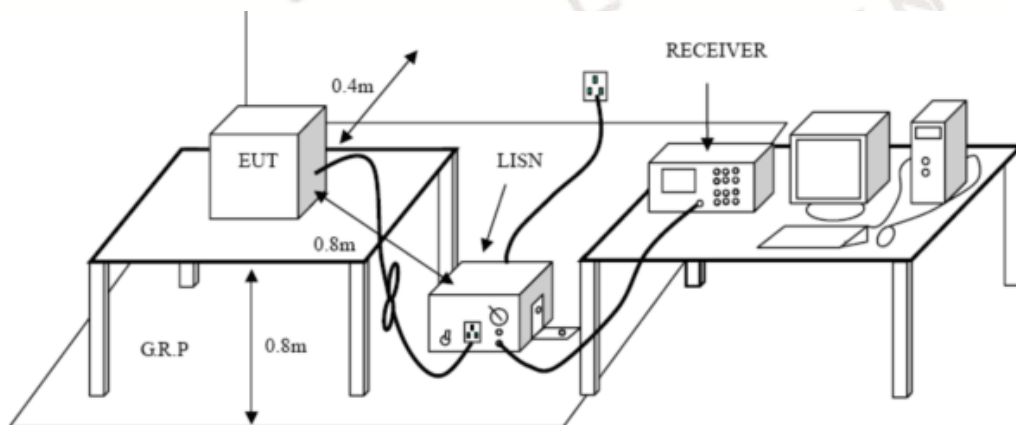

### 3.3 TEST PROCEDURE

1. The equipment was set up as per the test configuration to simulate typical actual usage per the user's manual. The EUT is placed on a wooden table with a height of 0.8 meters is used and is placed on the ground plane as per ANSI C63.10.
2. Support equipment, if needed, was placed as per ANSI C63.10.
3. All I/O cables were positioned to simulate typical actual usage as per ANSI C63.10.
4. If a EUT received DC power from the USB Port of Notebook PC, the PC's adapter received AC120V/60Hz power through a Line Impedance Stabilization Network (LISN) which supplied power source and was grounded to the ground plane.
5. All support equipments received AC power from a second LISN, if any.
6. The EUT test program was started. Emissions were measured on each current carrying line of the EUT using a spectrum Analyzer / Receiver connected to the LISN powering the EUT. The LISN has two monitoring points: Line 1 (Hot Side) and Line 2 (Neutral Side). Two scans were taken: one with Line 1 connected to Analyzer / Receiver and Line 2 connected to a 50 ohm load; the second scan had Line 1 connected to a 50 ohm load and Line 2 connected to the Analyzer / Receiver.
7. Analyzer / Receiver scanned from 150 kHz to 30MHz for emissions in each of the test modes.

### 3.4 TEST RESULT

PASS

Remark:

1. All modes were tested at AC 120V and 240V, only the worst result of AC 120V was reported.
2. All modes were test at Low, Middle, and High channel, only the worst result of GFSK Low Channel was reported.

Temperature:	24°C	Relative Humidity:	48%
Test Date:	Jun. 13, 2023	Pressure:	1010hPa
Test Voltage:	AC 120V, 60Hz	Phase:	Line
Test Mode:	Transmitting mode of GFSK 2402MHz		

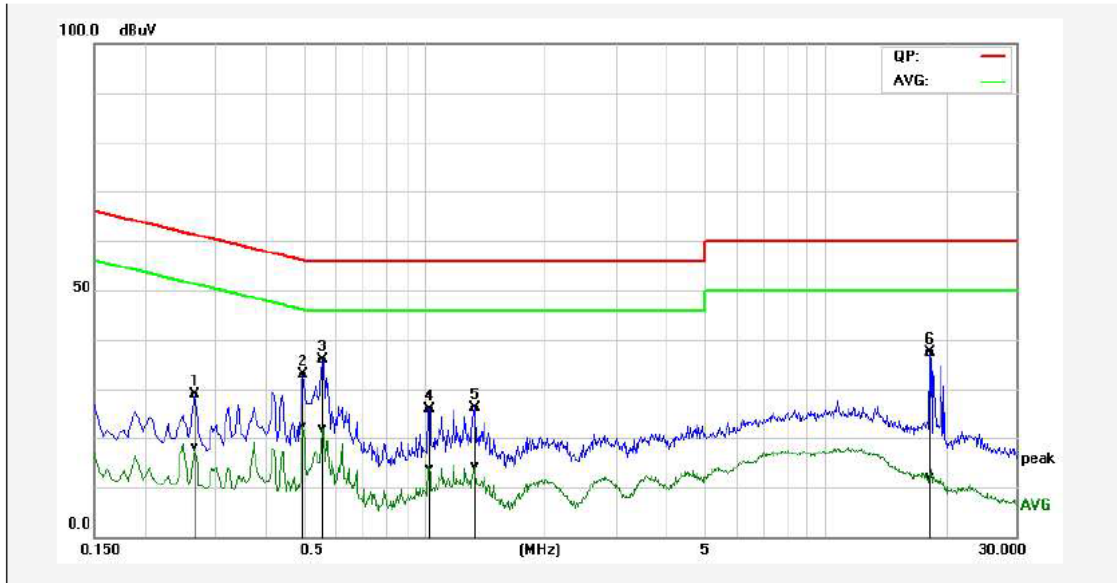

No.	Frequency (MHz)	QuasiPeak reading (dBuV)	Average reading (dBuV)	Correction factor (dB)	QuasiPeak result (dBuV)	Average result (dBuV)	QuasiPeak limit (dBuV)	Average limit (dBuV)	QuasiPeak margin (dB)	Average margin (dB)	Remark
1P	0.2660	18.86	7.97	10.11	28.97	18.08	61.24	51.24	-32.27	-33.16	Pass
2P	0.4980	22.72	12.35	10.12	32.84	22.47	56.03	46.03	-23.19	-23.56	Pass
3*	0.5580	25.80	11.78	10.11	35.91	21.89	56.00	46.00	-20.09	-24.11	Pass
4P	1.0300	15.72	3.85	10.12	25.84	13.97	56.00	46.00	-30.16	-32.03	Pass
5P	1.3340	15.96	4.24	10.12	26.08	14.36	56.00	46.00	-29.92	-31.64	Pass
6P	18.3260	26.98	1.75	10.44	37.42	12.19	60.00	50.00	-22.58	-37.81	Pass

Remark: Factor = Insertion Loss + Cable Loss, Result = Reading + Factor, Margin = Result – Limit.

Temperature:	24°C	Relative Humidity:	48%
Test Date:	Jun. 13, 2023	Pressure:	1010hPa
Test Voltage:	AC 120V, 60Hz	Phase:	Neutral
Test Mode:	Transmitting mode of GFSK 2402MHz		

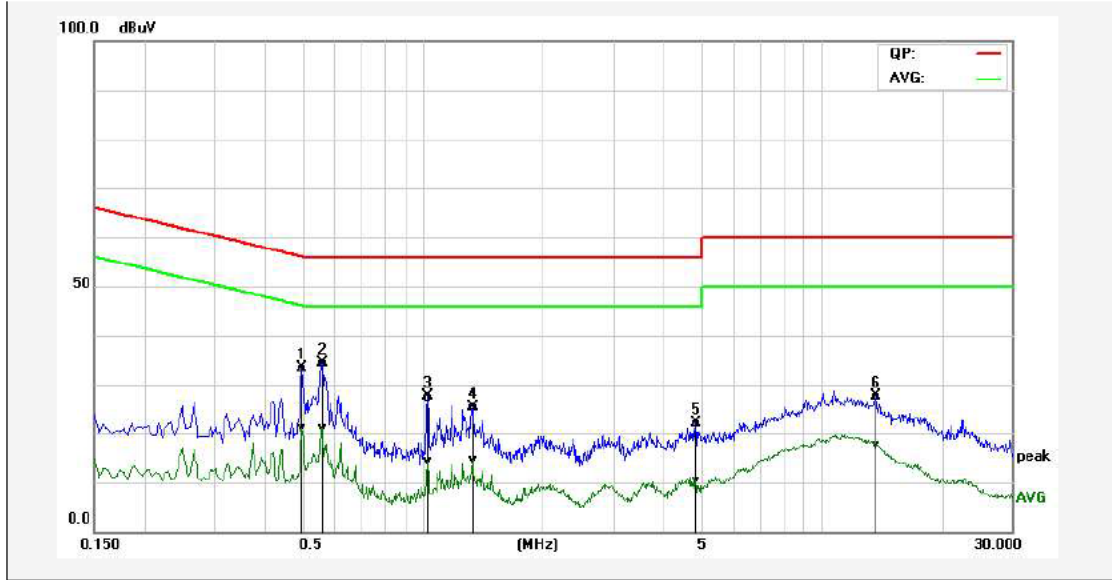

No.	Frequency (MHz)	QuasiPeak reading (dBuV)	Average reading (dBuV)	Correction factor (dB)	QuasiPeak result (dBuV)	Average result (dBuV)	QuasiPeak limit (dBuV)	Average limit (dBuV)	QuasiPeak margin (dB)	Average margin (dB)	Remark
1P	0.4980	23.37	11.15	10.01	33.38	21.16	56.03	46.03	-22.65	-24.87	Pass
2*	0.5580	24.42	11.12	10.00	34.42	21.12	56.00	46.00	-21.58	-24.88	Pass
3P	1.0300	17.48	4.25	10.02	27.50	14.27	56.00	46.00	-28.50	-31.73	Pass
4P	1.3340	15.44	4.56	10.03	25.47	14.59	56.00	46.00	-30.53	-31.41	Pass
5P	4.8420	11.92	0.18	10.09	22.01	10.27	56.00	46.00	-33.99	-35.73	Pass
6P	13.6420	17.50	7.30	10.22	27.72	17.52	60.00	50.00	-32.28	-32.48	Pass

Remark: Factor = Insertion Loss + Cable Loss, Result = Reading + Factor, Margin = Result – Limit.

## 4 RADIATED EMISSION

### 4.1 TEST LIMIT

For unintentional device, according to § 15.209(a), except for Class B digital devices, the field strength of radiated emissions from unintentional radiators at a distance of 3 meters shall not exceed the following values:

Frequency	Field strength (microvolt/meter)	Limit (dBuV/m )	Remark	Measurement distance (m)
0.009MHz-0.490MHz	2400/F (kHz)	-	Quasi-peak	300
0.490MHz-1.705MHz	24000/F (kHz)	-	Quasi-peak	30
1.705MHz-30MHz	30	-	Quasi-peak	30
30MHz-88MHz	100	40.0	Quasi-peak	3
88MHz-216MHz	150	43.5	Quasi-peak	3
216MHz-960MHz	200	46.0	Quasi-peak	3
960MHz-1GHz	500	54.0	Quasi-peak	3
Above 1GHz	500	54.0	Average	3
		74.0	Peak	3

For intentional device, according to § 15.209(a), the general requirement of field strength of radiated emissions from intentional radiators at a distance of 3 meters shall not exceed the above table.

Limit: (Field strength of the fundamental signal)

Frequency	Limit (dBuV/m @3m)	Remark
2400MHz-2483.5MHz	94.0	Average Value
	114.0	Peak Value

## 4.2 TEST SETUP

### 1. Radiated Emission Test-Up Frequency Below 30MHz

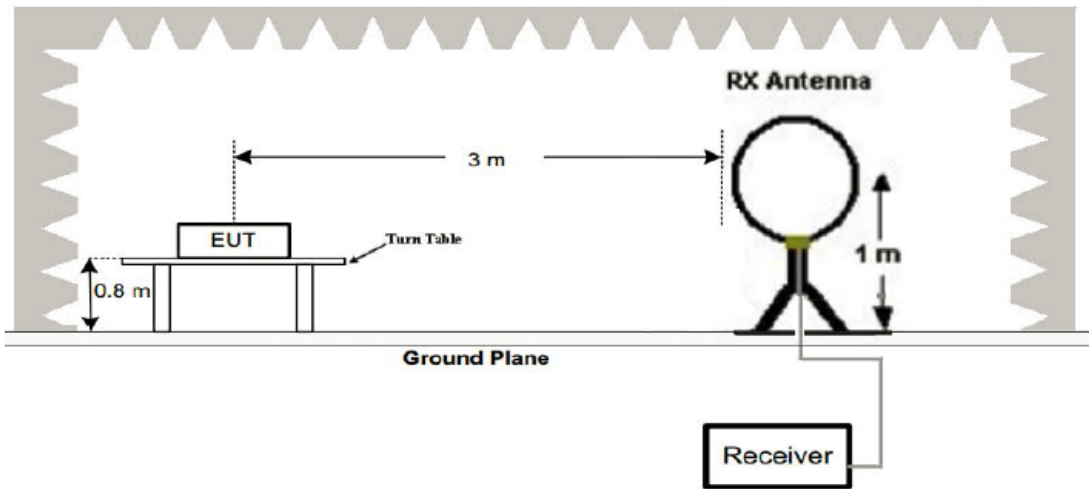

### 2. Radiated Emission Test-Up Frequency 30MHz~1GHz

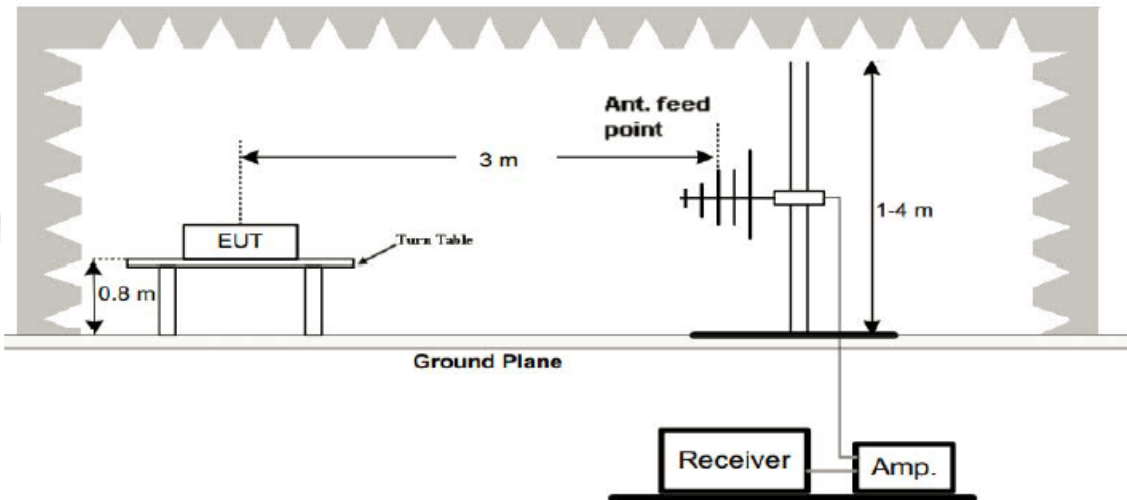

### 3. Radiated Emission Test-Up Frequency Above 1GHz

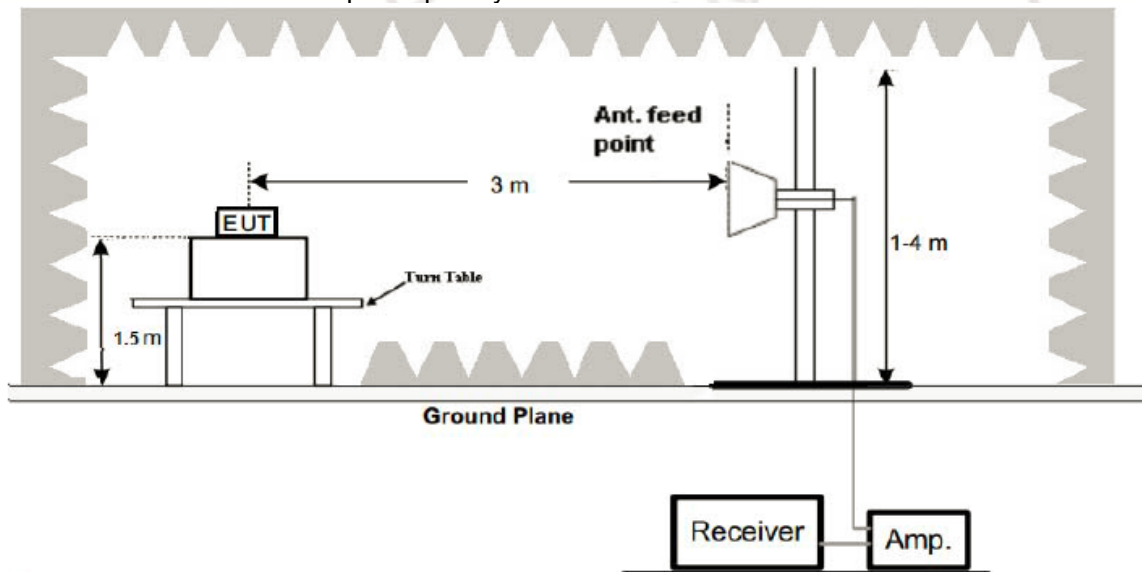

### 4.3 TEST PROCEDURE

1. Below 1GHz measurement the EUT is placed on turntable which is 0.8m above ground plane.  
And above 1GHz measurement EUT was placed on low permittivity and low tangent turn table which is 1.5m above ground plane.
2. The turntable shall be rotated for 360 degrees to determine the position of maximum emission level.
3. EUT is set 3m away from the receiving antenna, which is varied from 1m to 4m to find out the highest emissions.
4. Maximum procedure was performed on the six highest emissions to ensure EUT compliance.
5. And also, each emission was to be maximized by changing the polarization of receiving antenna both horizontal and vertical.
6. Repeat above procedures until the measurements for all frequencies are complete.
7. The test frequency range from 9kHz to 25GHz per FCC PART 15.33(a).

Note:

For battery operated equipment, the equipment tests shall be performed using a new battery.

### 4.4 TEST RESULT

PASS

Remark:

1. All modes were test at Low, Middle, and High channel, only the worst result of GFSK Low Channel was reported for below 1GHz test.
2. By preliminary testing and verifying three axis (X, Y and Z) position of EUT transmitted status, it was found that "X axis" position was the worst, and test data recorded in this report.
3. Radiated emission test from 9kHz to 10th harmonic of fundamental was verified, and no emission found except system noise floor in 9kHz to 30MHz and not recorded in this report.

Below 1GHz Test Results:

Temperature:	24°C	Relative Humidity:	48%
Test Date:	Jun. 13, 2023	Pressure:	1010hPa
Test Voltage:	AC 120V, 60Hz	Phase:	Horizontal
Test Mode:	Transmitting mode of GFSK 2402MHz		

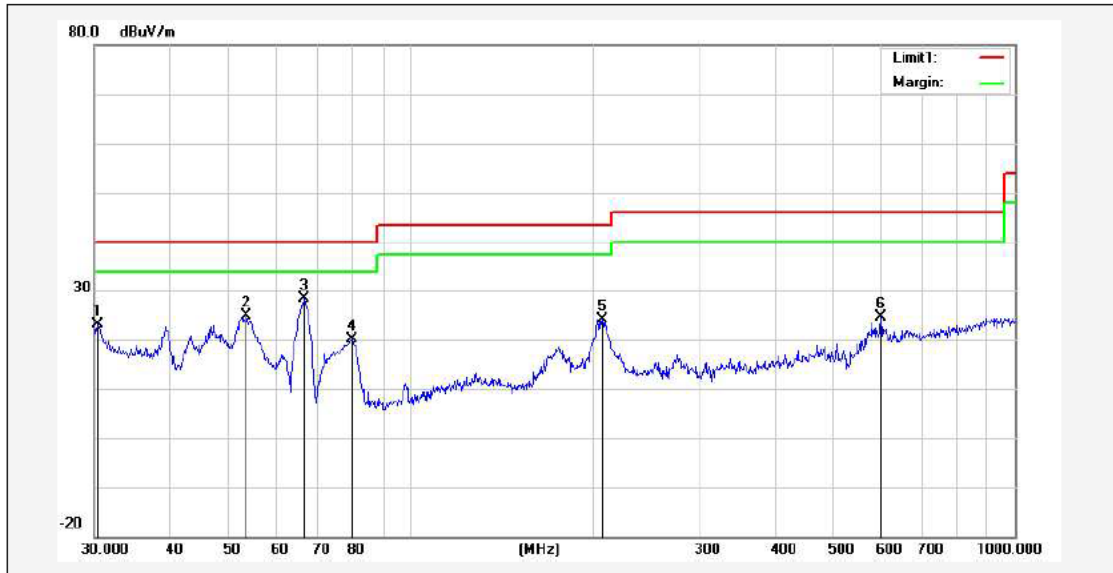

No.	Frequency (MHz)	Reading (dBuV)	Correction factor(dB/m)	Result (dBuV/m)	Limit (dBuV/m)	Margin (dB)	Degree (deg.)	Height (cm)	Remark
1	30.3173	29.94	-6.86	23.08	40.00	-16.92	314	100	peak
2	53.5052	45.02	-20.17	24.85	40.00	-15.15	296	100	peak
3*	66.4989	48.80	-20.32	28.48	40.00	-11.52	202	100	peak
4	79.8003	40.01	-19.93	20.08	40.00	-19.92	124	100	peak
5	207.1226	39.55	-15.30	24.25	43.50	-19.25	98	100	peak
6	599.3213	30.91	-6.33	24.58	46.00	-21.42	53	100	peak

Remark: Result = Reading Level + Factor, Margin = Result– Limit  
 Factor = Ant. Factor + Cable Loss – Pre-amplifier

Temperature:	24°C	Relative Humidity:	48%
Test Date:	Jun. 13, 2023	Pressure:	1010hPa
Test Voltage:	AC 120V, 60Hz	Phase:	Vertical
Test Mode:	Transmitting mode of GFSK 2402MHz		

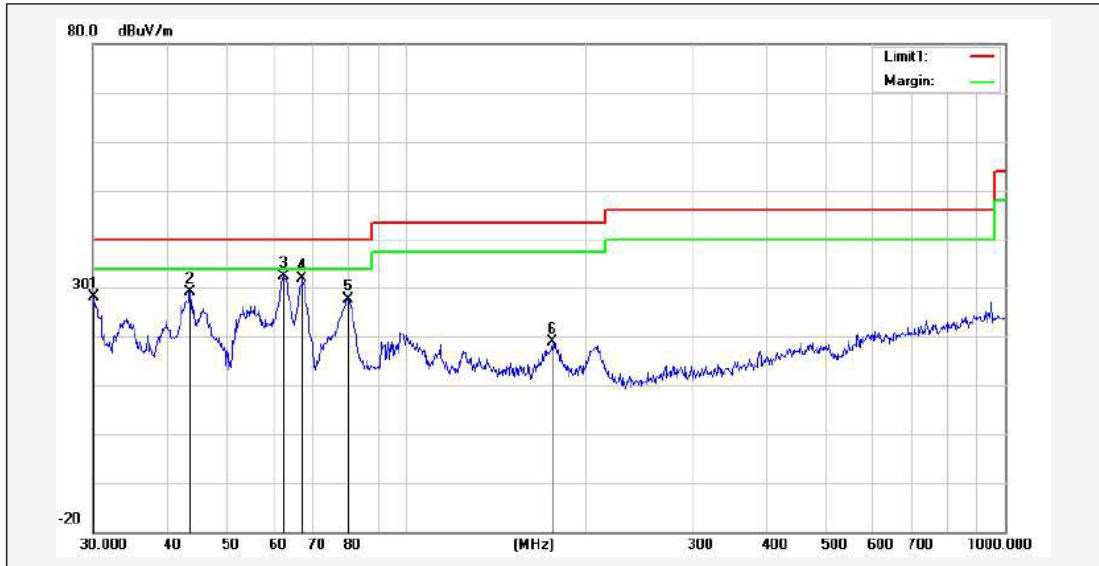

No.	Frequency (MHz)	Reading (dBuV)	Correction factor(dB/m)	Result (dBuV/m)	Limit (dBuV/m)	Margin (dB)	Degree (deg.)	Height (cm)	Remark
1	30.0000	34.66	-6.62	28.04	40.00	-11.96	353	100	peak
2	43.5057	45.68	-16.61	29.07	40.00	-10.93	301	100	peak
3*	62.2128	53.24	-20.88	32.36	40.00	-7.64	298	100	peak
4	66.9669	52.19	-20.25	31.94	40.00	-8.06	247	100	peak
5	79.8003	47.66	-19.93	27.73	40.00	-12.27	179	100	peak
6	175.0368	34.83	-15.95	18.88	43.50	-24.62	101	100	peak

Remark: Result = Reading Level + Factor, Margin = Result – Limit  
 Factor = Ant. Factor + Cable Loss – Pre-amplifier

Remark:

1. Measuring frequencies from 9 kHz to the 1 GHz, Radiated emission test from 9kHz to 30MHz was verified, and no any emission was found except system noise floor.
2. \* denotes emission frequency which appearing within the Restricted Bands specified in provision of 15.205, then the general radiated emission limits in 15.209 apply.
3. The IF bandwidth of EMI Test Receiver between 30MHz to 1GHz was 120kHz, 1 MHz for measuring above 1 GHz, below 30MHz was 10kHz.

Above 1 GHz Test Results:

GFSK Modulation:  
CH00 (2402MHz)

Horizontal:

Frequency (MHz)	Reading Result (dBμV)	Factor (dB)	Emission Level (dBμV/m)	Limits (dBμV/m)	Margin (dB)	Detector Type
2402	99.61	-5.84	93.77	114	-20.23	PK
2402	82.04	-5.84	76.2	94	-17.8	AV
4804	59.96	-3.64	56.32	74	-17.68	PK
4804	48.21	-3.64	44.57	54	-9.43	AV
7206	55.32	-0.95	54.37	74	-19.63	PK
7206	43.53	-0.95	42.58	54	-11.42	AV

Remark: Factor = Antenna Factor + Cable Loss – Pre-amplifier. Margin = Emission Level – Limit

Vertical:

Frequency (MHz)	Reading Result (dBμV)	Factor (dB)	Emission Level (dBμV/m)	Limits (dBμV/m)	Margin (dB)	Detector Type
2402	98.2	-5.84	92.36	114	-21.64	PK
2402	79.87	-5.84	74.03	94	-19.97	AV
4804	59	-3.64	55.36	74	-18.64	PK
4804	46.04	-3.64	42.4	54	-11.6	AV
7206	54.93	-0.95	53.98	74	-20.02	PK
7206	44.21	-0.95	43.26	54	-10.74	AV

Remark: Factor = Antenna Factor + Cable Loss – Pre-amplifier. Margin = Emission Level – Limit

CH39 (2441MHz)

Horizontal:

Frequency (MHz)	Reading Result (dBμV)	Factor (dB)	Emission Level (dBμV/m)	Limits (dBμV/m)	Margin (dB)	Detector Type
2441	98.7	-5.71	92.99	114	-21.01	PK
2441	80.8	-5.71	75.09	94	-18.91	AV
4882	58.02	-3.51	54.51	74	-19.49	PK
4882	46.83	-3.51	43.32	54	-10.68	AV
7323	55.26	-0.82	54.44	74	-19.56	PK
7323	43.41	-0.82	42.59	54	-11.41	AV

Remark: Factor = Antenna Factor + Cable Loss – Pre-amplifier. Margin = Emission Level – Limit

Vertical:

Frequency (MHz)	Reading Result (dBμV)	Factor (dB)	Emission Level (dBμV/m)	Limits (dBμV/m)	Margin (dB)	Detector Type
2441	97.29	-5.71	91.58	114	-22.42	PK
2441	81.03	-5.71	75.32	94	-18.68	AV
4882	57.96	-3.51	54.45	74	-19.55	PK
4882	47.11	-3.51	43.6	54	-10.4	AV
7323	55.02	-0.82	54.2	74	-19.8	PK
7323	44.9	-0.82	44.08	54	-9.92	AV

Remark: Factor = Antenna Factor + Cable Loss – Pre-amplifier. Margin = Emission Level – Limit

CH78 (2480MHz)

Horizontal:

Frequency (MHz)	Reading Result (dBμV)	Factor (dB)	Emission Level (dBμV/m)	Limits (dBμV/m)	Margin (dB)	Detector Type
2480	96.53	-5.65	90.88	114	-23.12	PK
2480	80.93	-5.65	75.28	94	-18.72	AV
4960	58.71	-3.43	55.28	74	-18.72	PK
4960	46.96	-3.43	43.53	54	-10.47	AV
7440	54.84	-0.75	54.09	74	-19.91	PK
7440	43.92	-0.75	43.17	54	-10.83	AV

Remark: Factor = Antenna Factor + Cable Loss – Pre-amplifier. Margin = Emission Level – Limit

Vertical:

Frequency (MHz)	Reading Result (dBμV)	Factor (dB)	Emission Level (dBμV/m)	Limits (dBμV/m)	Margin (dB)	Detector Type
2480	95.12	-5.65	89.47	114	-24.53	PK
2480	80.93	-5.65	75.28	94	-18.72	AV
4960	58.81	-3.43	55.38	74	-18.62	PK
4960	46.12	-3.43	42.69	54	-11.31	AV
7440	56.24	-0.75	55.49	74	-18.51	PK
7440	43.32	-0.75	42.57	54	-11.43	AV

Remark: Factor = Antenna Factor + Cable Loss – Pre-amplifier. Margin = Emission Level – Limit

$\pi/4$  DQPSK Modulation:  
CH00 (2402MHz)

Horizontal:

Frequency (MHz)	Reading Result (dB $\mu$ V)	Factor (dB)	Emission Level (dB $\mu$ V/m)	Limits (dB $\mu$ V/m)	Margin (dB)	Detector Type
2402	99.48	-5.84	93.64	114	-20.36	PK
2402	80.93	-5.84	75.09	94	-18.91	AV
4804	58.7	-3.64	55.06	74	-18.94	PK
4804	46.97	-3.64	43.33	54	-10.67	AV
7206	55.33	-0.95	54.38	74	-19.62	PK
7206	43.63	-0.95	42.68	54	-11.32	AV

Remark: Factor = Antenna Factor + Cable Loss – Pre-amplifier. Margin = Emission Level – Limit

Vertical:

Frequency (MHz)	Reading Result (dB $\mu$ V)	Factor (dB)	Emission Level (dB $\mu$ V/m)	Limits (dB $\mu$ V/m)	Margin (dB)	Detector Type
2402	98.07	-5.84	92.23	114	-21.77	PK
2402	80.93	-5.84	75.09	94	-18.91	AV
4804	58.04	-3.64	54.4	74	-19.6	PK
4804	46.86	-3.64	43.22	54	-10.78	AV
7206	54.9	-0.95	53.95	74	-20.05	PK
7206	43.91	-0.95	42.96	54	-11.04	AV

Remark: Factor = Antenna Factor + Cable Loss – Pre-amplifier. Margin = Emission Level – Limit

CH39 (2441MHz)

Horizontal:

Frequency (MHz)	Reading Result (dBμV)	Factor (dB)	Emission Level (dBμV/m)	Limits (dBμV/m)	Margin (dB)	Detector Type
2441	97.98	-5.71	92.27	114	-21.73	PK
2441	80.98	-5.71	75.27	94	-18.73	AV
4882	59.42	-3.51	55.91	74	-18.09	PK
4882	47.05	-3.51	43.54	54	-10.46	AV
7323	56.34	-0.82	55.52	74	-18.48	PK
7323	43.93	-0.82	43.11	54	-10.89	AV

Remark: Factor = Antenna Factor + Cable Loss – Pre-amplifier. Margin = Emission Level – Limit

Vertical:

Frequency (MHz)	Reading Result (dBμV)	Factor (dB)	Emission Level (dBμV/m)	Limits (dBμV/m)	Margin (dB)	Detector Type
2441	96.57	-5.71	90.86	114	-23.14	PK
2441	81.11	-5.71	75.4	94	-18.6	AV
4882	59.44	-3.51	55.93	74	-18.07	PK
4882	46.03	-3.51	42.52	54	-11.48	AV
7323	56.26	-0.82	55.44	74	-18.56	PK
7323	44.87	-0.82	44.05	54	-9.95	AV

Remark: Factor = Antenna Factor + Cable Loss – Pre-amplifier. Margin = Emission Level – Limit

CH78 (2480MHz)

Horizontal:

Frequency (MHz)	Reading Result (dBμV)	Factor (dB)	Emission Level (dBμV/m)	Limits (dBμV/m)	Margin (dB)	Detector Type
2480	96.84	-5.65	91.19	114	-22.81	PK
2480	81.23	-5.65	75.58	94	-18.42	AV
4960	59.34	-3.43	55.91	74	-18.09	PK
4960	47.05	-3.43	43.62	54	-10.38	AV
7440	55.96	-0.75	55.21	74	-18.79	PK
7440	44.71	-0.75	43.96	54	-10.04	AV

Remark: Factor = Antenna Factor + Cable Loss – Pre-amplifier. Margin = Emission Level – Limit

Vertical:

Frequency (MHz)	Reading Result (dBμV)	Factor (dB)	Emission Level (dBμV/m)	Limits (dBμV/m)	Margin (dB)	Detector Type
2480	95.43	-5.65	89.78	114	-24.22	PK
2480	81.05	-5.65	75.4	94	-18.6	AV
4960	59.54	-3.43	56.11	74	-17.89	PK
4960	46.16	-3.43	42.73	54	-11.27	AV
7440	55.3	-0.75	54.55	74	-19.45	PK
7440	43.93	-0.75	43.18	54	-10.82	AV

Remark: Factor = Antenna Factor + Cable Loss – Pre-amplifier. Margin = Emission Level – Limit

8DPSK Modulation:  
CH00 (2402MHz)

Horizontal:

Frequency (MHz)	Reading Result (dBμV)	Factor (dB)	Emission Level (dBμV/m)	Limits (dBμV/m)	Margin (dB)	Detector Type
2402	99.41	-5.84	93.57	114	-20.43	PK
2402	80.85	-5.84	75.01	94	-18.99	AV
4804	58.54	-3.64	54.9	74	-19.1	PK
4804	46.73	-3.64	43.09	54	-10.91	AV
7206	55.37	-0.95	54.42	74	-19.58	PK
7206	45.14	-0.95	44.19	54	-9.81	AV

Remark: Factor = Antenna Factor + Cable Loss – Pre-amplifier. Margin = Emission Level – Limit

Vertical:

Frequency (MHz)	Reading Result (dBμV)	Factor (dB)	Emission Level (dBμV/m)	Limits (dBμV/m)	Margin (dB)	Detector Type
2402	98	-5.84	92.16	114	-21.84	PK
2402	80.95	-5.84	75.11	94	-18.89	AV
4804	56.74	-3.64	53.1	74	-20.9	PK
4804	47.55	-3.64	43.91	54	-10.09	AV
7206	55.46	-0.95	54.51	74	-19.49	PK
7206	45.02	-0.95	44.07	54	-9.93	AV

Remark: Factor = Antenna Factor + Cable Loss – Pre-amplifier. Margin = Emission Level – Limit

CH39 (2441MHz)

Horizontal:

Frequency (MHz)	Reading Result (dBμV)	Factor (dB)	Emission Level (dBμV/m)	Limits (dBμV/m)	Margin (dB)	Detector Type
2441	98.46	-5.71	92.75	114	-21.25	PK
2441	81.16	-5.71	75.45	94	-18.55	AV
4882	59.03	-3.51	55.52	74	-18.48	PK
4882	46.75	-3.51	43.24	54	-10.76	AV
7323	55.32	-0.82	54.5	74	-19.5	PK
7323	43.36	-0.82	42.54	54	-11.46	AV

Remark: Factor = Antenna Factor + Cable Loss – Pre-amplifier. Margin = Emission Level – Limit

Vertical:

Frequency (MHz)	Reading Result (dBμV)	Factor (dB)	Emission Level (dBμV/m)	Limits (dBμV/m)	Margin (dB)	Detector Type
2441	97.05	-5.71	91.34	114	-22.66	PK
2441	81.22	-5.71	75.51	94	-18.49	AV
4882	57.16	-3.51	53.65	74	-20.35	PK
4882	46.83	-3.51	43.32	54	-10.68	AV
7323	55.34	-0.82	54.52	74	-19.48	PK
7323	43.42	-0.82	42.6	54	-11.4	AV

Remark: Factor = Antenna Factor + Cable Loss – Pre-amplifier. Margin = Emission Level – Limit

CH78 (2480MHz)

Horizontal:

Frequency (MHz)	Reading Result (dBμV)	Factor (dB)	Emission Level (dBμV/m)	Limits (dBμV/m)	Margin (dB)	Detector Type
2480	96.89	-5.65	91.24	114	-22.76	PK
2480	80.93	-5.65	75.28	94	-18.72	AV
4960	57.92	-3.43	54.49	74	-19.51	PK
4960	46.74	-3.43	43.31	54	-10.69	AV
7440	53.46	-0.75	52.71	74	-21.29	PK
7440	43.36	-0.75	42.61	54	-11.39	AV

Remark: Factor = Antenna Factor + Cable Loss – Pre-amplifier. Margin = Emission Level – Limit

Vertical:

Frequency (MHz)	Reading Result (dBμV)	Factor (dB)	Emission Level (dBμV/m)	Limits (dBμV/m)	Margin (dB)	Detector Type
2480	95.48	-5.65	89.83	114	-24.17	PK
2480	79.15	-5.65	73.5	94	-20.5	AV
4960	56.92	-3.43	53.49	74	-20.51	PK
4960	47.51	-3.43	44.08	54	-9.92	AV
7440	53.55	-0.75	52.8	74	-21.2	PK
7440	43.33	-0.75	42.58	54	-11.42	AV

Remark: Factor = Antenna Factor + Cable Loss – Pre-amplifier. Margin = Emission Level – Limit

Remark:

1. Measuring frequencies from 1 GHz to the 25 GHz.
2. "F" denotes fundamental frequency; "H" denotes spurious frequency. "E" denotes band edge frequency.
3. \* denotes emission frequency which appearing within the Restricted Bands specified in provision of 15.205, then the general radiated emission limits in 15.209 apply.
4. Data of measurement within this frequency range shown "---" in the table above means the reading of emissions are attenuated more than 20dB below the permissible limits or the field strength is too small to be measured.
5. The IF bandwidth of EMI Test Receiver between 30MHz to 1GHz was 120kHz, 1 MHz for measuring above 1 GHz, below 30MHz was 10kHz. The resolution bandwidth of test receiver/spectrum analyzer is 1MHz and video bandwidth is 3MHz for peak measurement with peak detector at frequency above 1GHz. The resolution bandwidth of test receiver/spectrum analyzer is 1MHz and video bandwidth is 10Hz for Average measurement with peak detection at frequency above 1GHz.
6. When the test results of Peak Detected below the limits of Average Detected, the Average Detected is not need completed. For example: Top Channel at Fundamental 73.16dBuV/m(PK Value) <93.98(AV Limit), at harmonic 53.20 dBuV/m(PK Value) <54 dBuV/m(AV Limit), the Average Detected not need to completed.
7. For fundamental frequency, RBW>20dB Bandwidth, VBW>=3\*RBW, Peak detector for PK value, RMS detector for AV value.

## 5 BAND EDGE

### 5.1 TEST LIMIT

FCC PART 15.249(d) Emissions radiated outside of the specified frequency bands, except for harmonics, shall be attenuated by at least 50 dB below the level of the fundamental or to the general radiated emission limits in §15.209, whichever is the lesser attenuation.

### 5.2 TEST SETUP

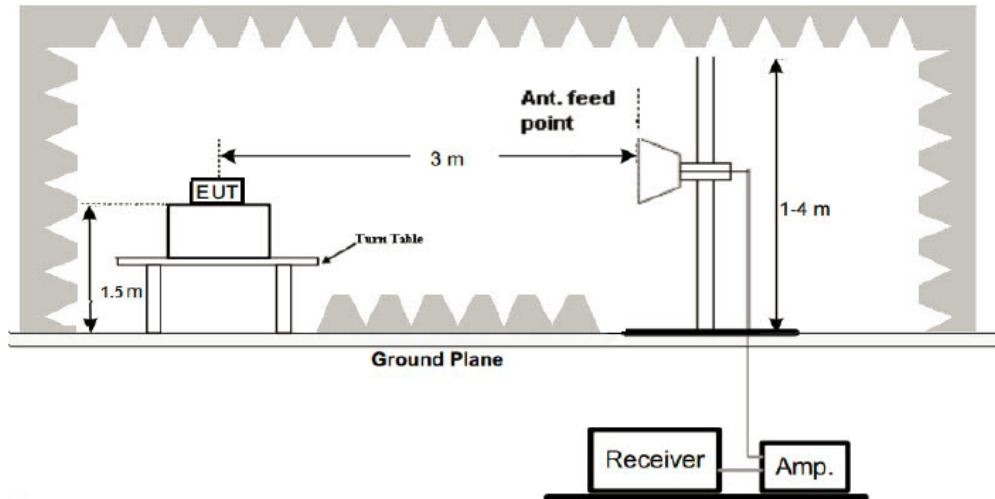

### 5.3 MEASUREMENT EQUIPMENT USED

Refer to Section 3.3.

### 5.4 TEST PROCEDURE

1. The EUT operates at transmitting mode. The operate channel is tested to verify the largest transmission and spurious emissions power at the continuous transmission mode. The band edge compliance of RF radiated emission should be measured by following the guidance in ANSI C63.10 with respect to maximizing the emission by rotating the EUT, measuring the emission while the EUT is situated in three orthogonal planes (if appropriate), adjusting the measurement antenna height and polarization etc.
2. Set the spectrum analyzer in the following setting in order to capture the lower and upper band-edges of the emission: (a) PEAK: RBW=1MHz, VBW=3MHz / Sweep=AUTO  
(b) AVERAGE: RBW=1MHz ; VBW=3MHz / Sweep=AUTO

### 5.5 TEST RESULT

PASS

Remark: All modes of were tested, only the worst result of GFSK was reported.

Operation Mode: TX CH00 (2402MHz)

Horizontal:

Frequency (MHz)	Reading Result (dBμV)	Factor (dB)	Emission Level (dBμV/m)	Limits (dBμV/m)	Margin (dB)	Detector Type
2310	52.95	-5.81	47.14	74	-26.86	PK
2310	/	-5.81	/	54	/	AV
2390	52.61	-5.84	46.77	74	-27.23	PK
2390	/	-5.84	/	54	/	AV
2400	53.75	-5.84	47.91	74	-26.09	PK
2400	/	-5.84	/	54	/	AV

Remark: Factor = Antenna Factor + Cable Loss – Pre-amplifier.

Vertical:

Frequency (MHz)	Reading Result (dBμV)	Factor (dB)	Emission Level (dBμV/m)	Limits (dBμV/m)	Margin (dB)	Detector Type
2310	53.84	-5.81	48.03	74	-25.97	PK
2310	/	-5.81	/	54	/	AV
2390	53.67	-5.84	47.83	74	-26.17	PK
2390	/	-5.84	/	54	/	AV
2400	54.91	-5.84	49.07	74	-24.93	PK
2400	/	-5.84	/	54	/	AV

Remark: Factor = Antenna Factor + Cable Loss – Pre-amplifier.

Operation Mode: TX CH78 (2480MHz)

Horizontal:

Frequency (MHz)	Reading Result (dBμV)	Factor (dB)	Emission Level (dBμV/m)	Limits (dBμV/m)	Margin (dB)	Detector Type
2483.5	54.41	-5.65	48.76	74	-25.24	PK
2483.5	/	-5.65	/	54	/	AV
2500	53.75	-5.72	48.03	74	-25.97	PK
2500	/	-5.72	/	54	/	AV

Remark: Factor = Antenna Factor + Cable Loss – Pre-amplifier.

Vertical:

Frequency (MHz)	Reading Result (dBμV)	Factor (dB)	Emission Level (dBμV/m)	Limits (dBμV/m)	Margin (dB)	Detector Type
2483.5	55.16	-5.65	49.51	74	-24.49	PK
2483.5	/	-5.65	/	54	/	AV
2500	54.85	-5.72	49.13	74	-24.87	PK
2500	/	-5.72	/	54	/	AV

Remark: Factor = Antenna Factor + Cable Loss – Pre-amplifier.

## 6 OCCUPIED BANDWIDTH

### 6.1 TEST SETUP (BLOCK DIAGRAM OF CONFIGURATION)

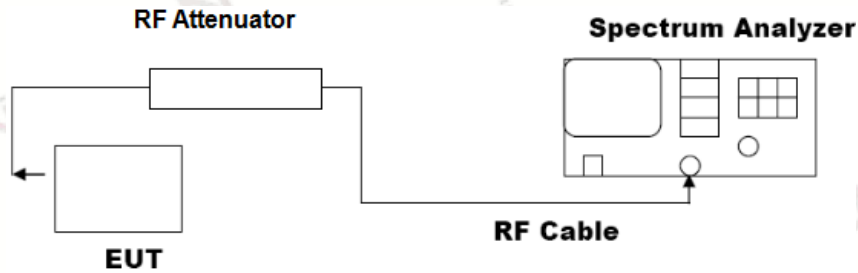

### 6.2 MEASUREMENT EQUIPMENT USED

Refer to Section 3.3.

### 6.3 TEST PROCEDURE

1. The RF output of EUT was connected to the spectrum analyzer by RF cable and attenuator. The path loss was compensated to the results for each measurement.
2. Set to the maximum power setting and enable the EUT transmit continuously.
3. Make the measurement with the spectrum analyzer's resolution bandwidth (RBW) = 30 kHz. Set the Video bandwidth (VBW) = 100 kHz. In order to make an accurate measurement.
4. For 99% Bandwidth Measurement, the spectrum analyzer's resolution bandwidth (RBW) is set 1-5% of the emission bandwidth and set the Video bandwidth (VBW)  $\geq 3 * RBW$ .
5. Measure and record the results in the test report.

### 6.4 TEST RESULT

PASS

GFSK Modulation:

Channel	Frequency (MHz)	20dB Bandwidth (MHz)	Result
CH00	2402	0.770	PASS
CH39	2441	0.777	PASS
CH78	2480	0.778	PASS

CH00: 2402MHz

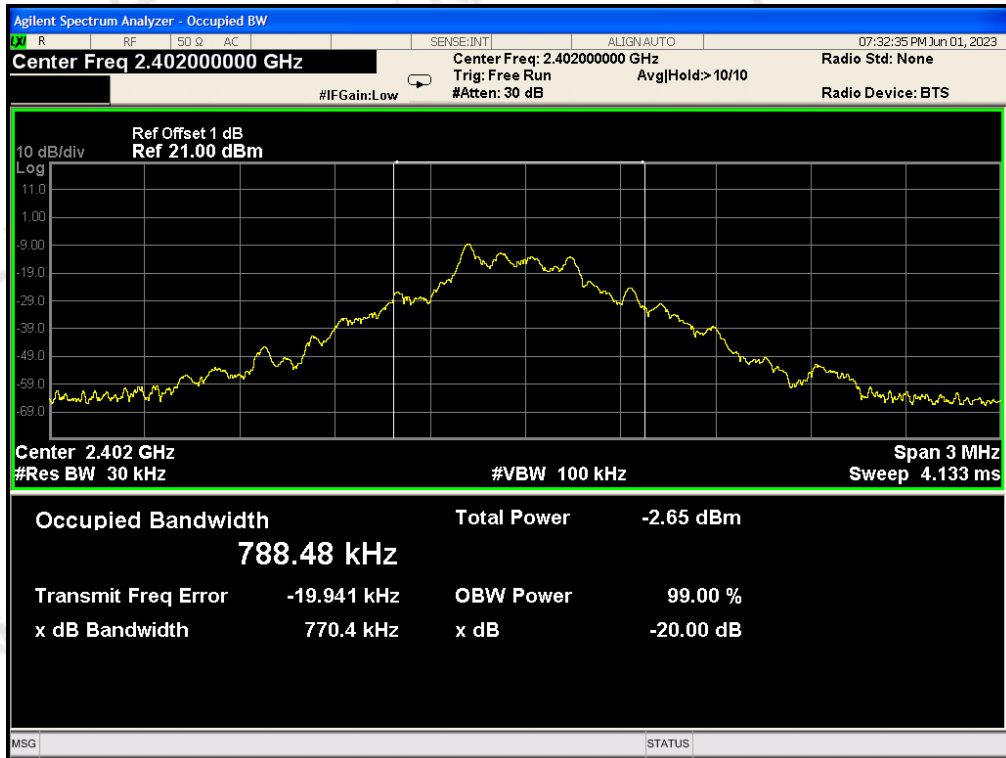

CH39: 2441MHz

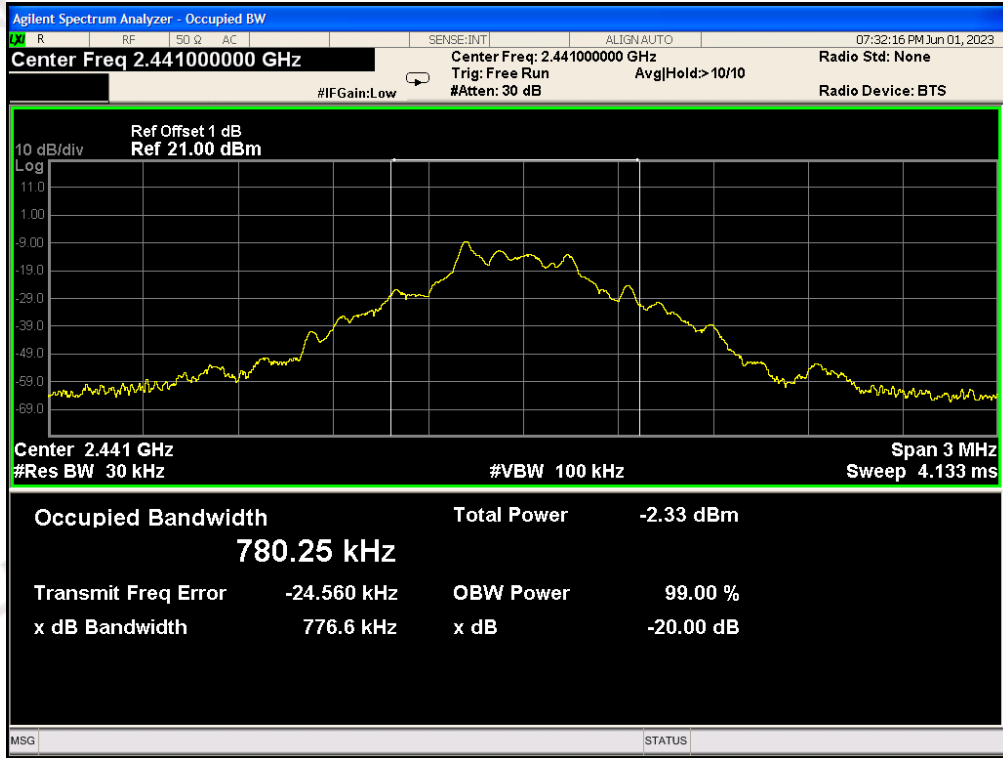

CH78: 2480MHz

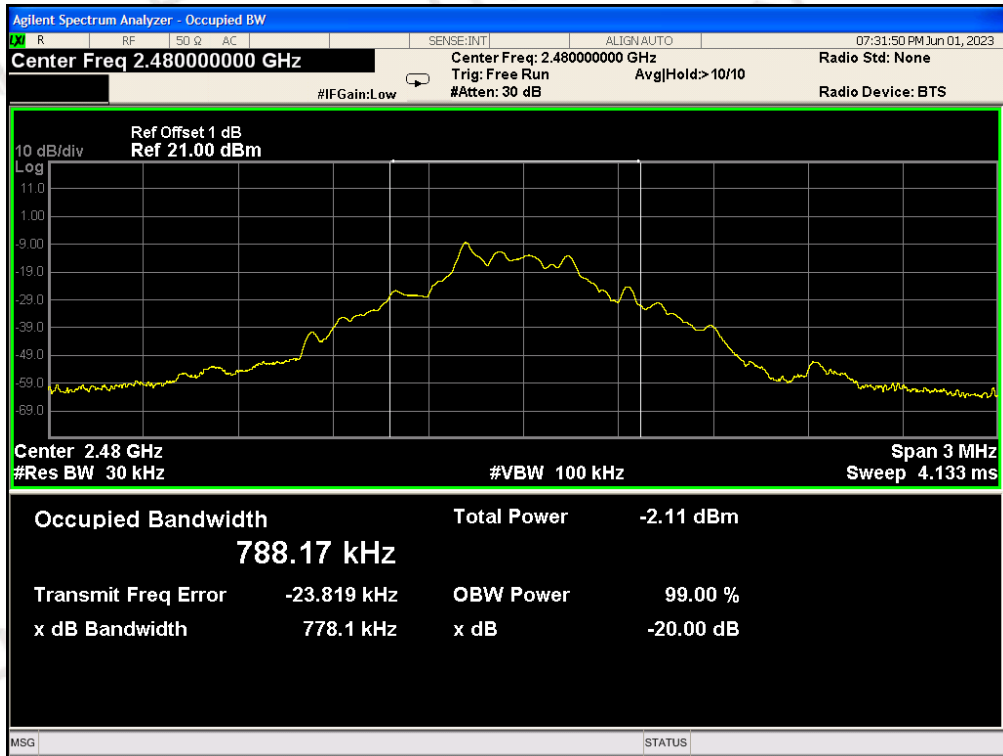

$\pi/4$  DQPSK Modulation:

Channel	Frequency (MHz)	20dB Bandwidth (MHz)	Result
CH00	2402	1.110	PASS
CH39	2441	1.108	PASS
CH78	2480	1.108	PASS

CH00: 2402MHz

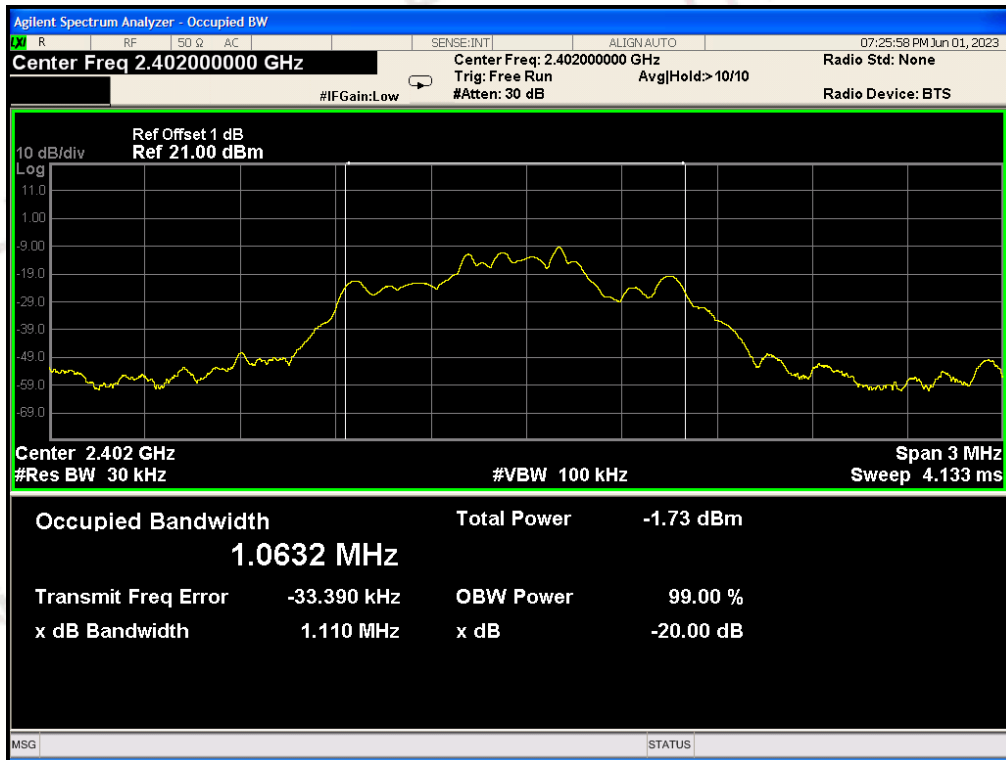

CH39: 2441MHz

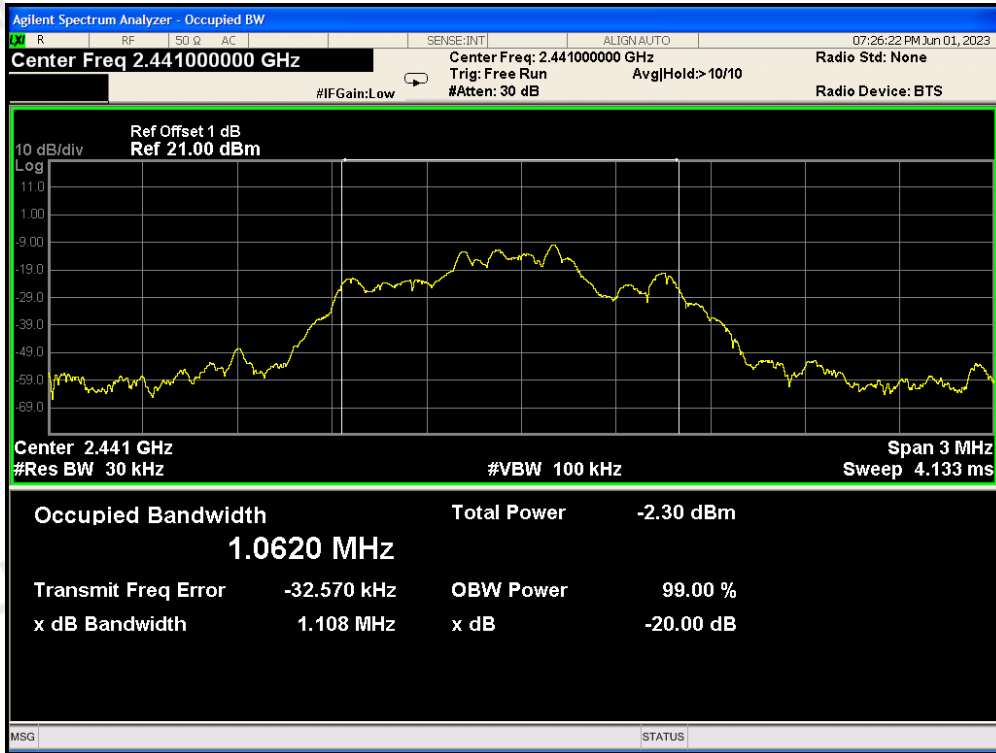

CH78: 2480MHz



8DPSK Modulation:

Channel	Frequency (MHz)	20dB Bandwidth (MHz)	Result
CH00	2402	1.250	PASS
CH39	2441	1.257	PASS
CH78	2480	1.266	PASS

CH00: 2402MHz

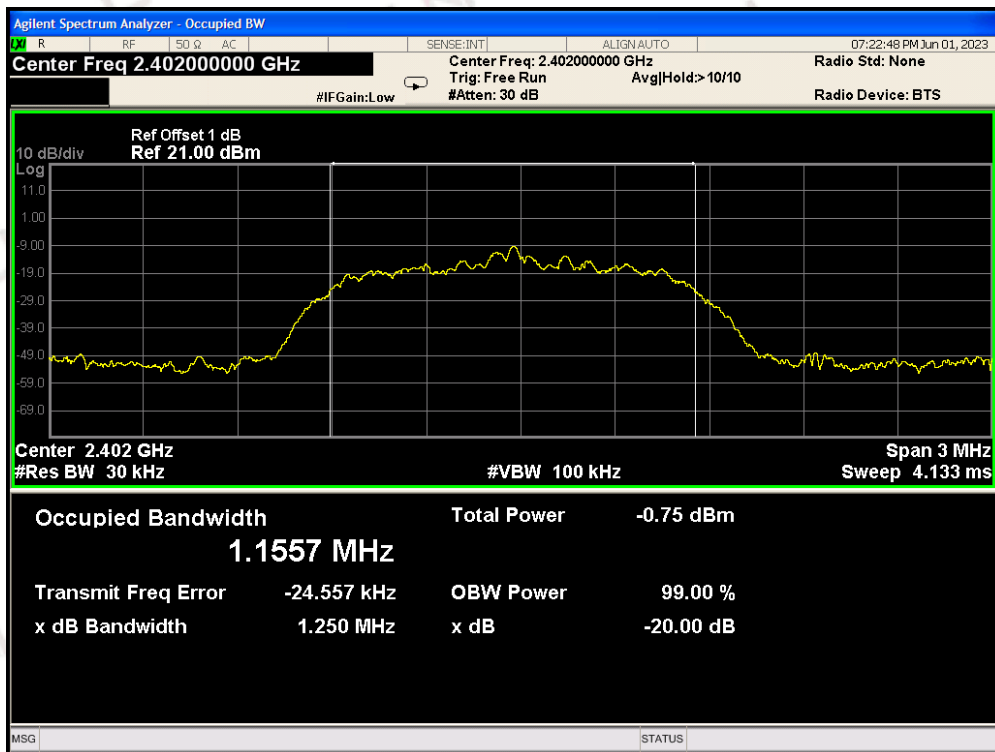

CH39: 2441MHz

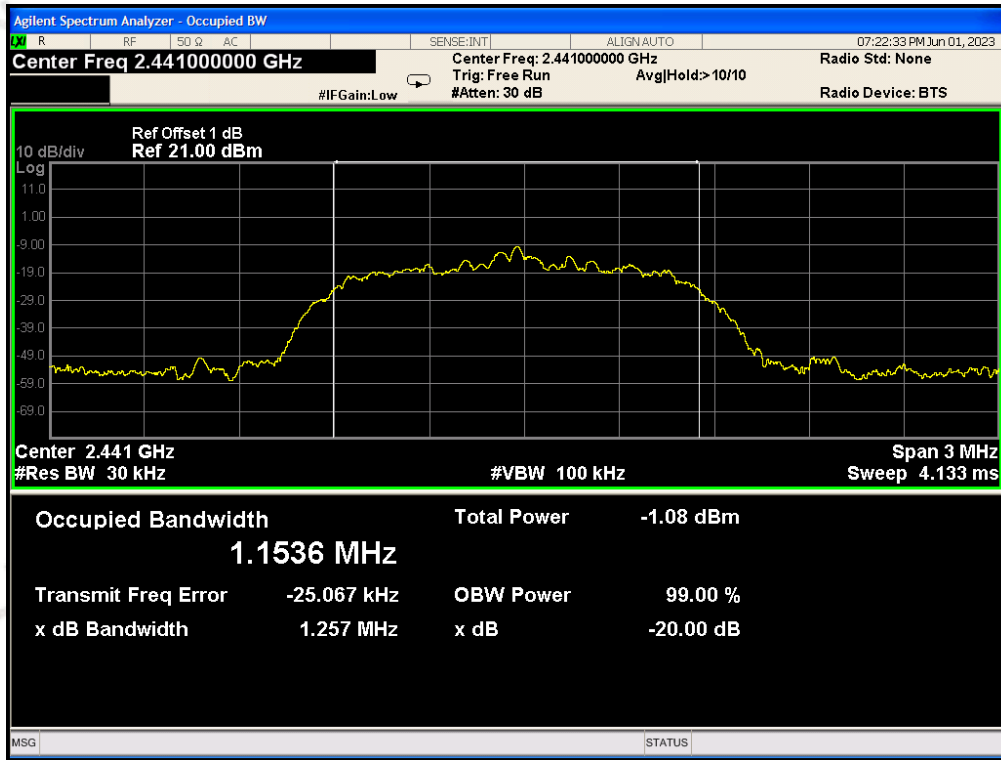

CH78: 2480MHz

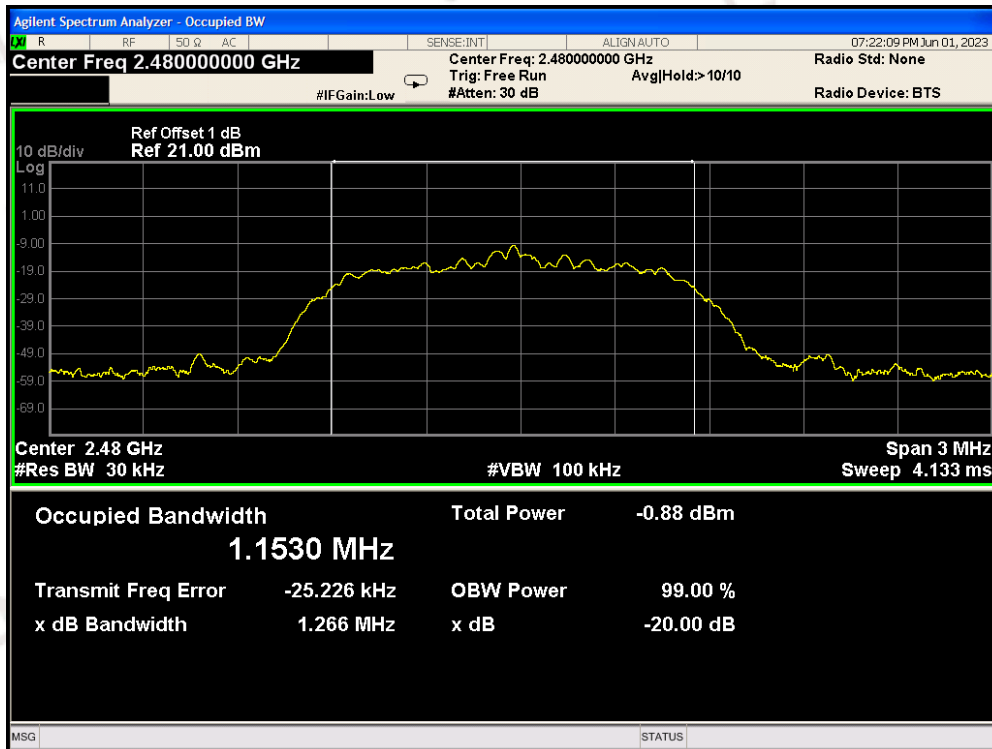

## 7 ANTENNA REQUIREMENT

Standard Applicable:

For intentional device, according to FCC 47 CFR Section 15.203, an intentional radiator shall be designed to ensure that no antenna other than that furnished by the responsible party shall be used with the device.

Antenna Connected Construction

The antenna used in this product is a PCB Antenna.

ANTENNA:

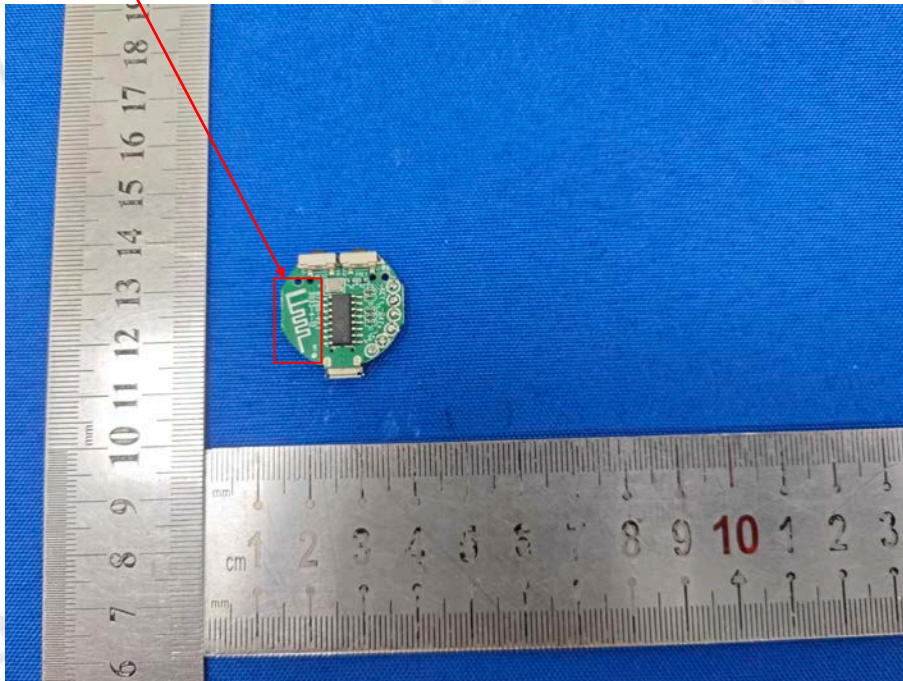

### 8 PHOTO OF TEST

### RADIATED EMISSION



30MHz-1000MHz



Above 1GHz

### CONDUCTED EMISSION



### RF CONDUCTED

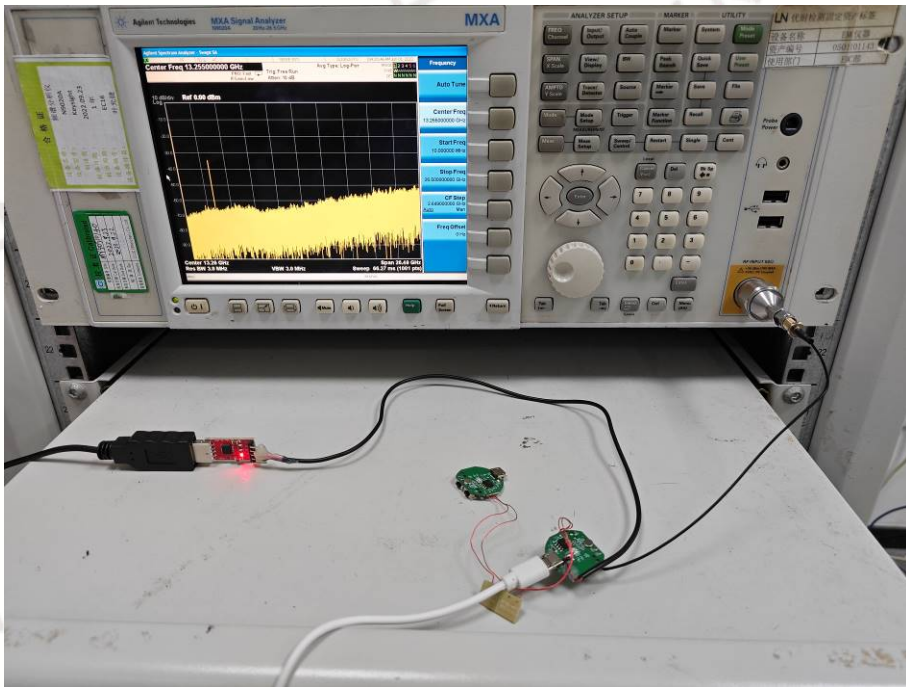

\*\*\*End of Report\*\*\*