



FCC TEST REPORT

FCC ID:2BBFLG9S

Report Number..... : ZHT-240903007E

Date of Test..... : Sept. 03, 2024 to Sept. 09, 2024

Date of issue : Sept. 09, 2024

Test Result : PASS

Testing Laboratory..... : Guangdong Zhonghan Testing Technology Co., Ltd.

Address : Room 104, Building 1, Yibaolai Industrial Park, Qiaotou Community, Fuhai Street, Bao'an District, Shenzhen, Guangdong, China

Applicant's name : Shenzhen SaiFeng Electronic Technology Co., Ltd

Address : Community, Ban Tin Street, LonggangDistrict, Shenzhen City, China

Manufacturer's name : Shenzhen SaiFeng Electronic Technology Co., Ltd

Address : Community, Ban Tin Street, LonggangDistrict, Shenzhen City, China

Test specification:

Standard..... : FCC CFR Title 47 Part 15 Subpart C Section 15.247

Test procedure..... : ANSI C63.10:2013

Non-standard test method : N/A

This device described above has been tested by ZHT, and the test results show that the equipment under test (EUT) is in compliance with the FCC requirements. And it is applicable only to the tested sample identified in the report.

This report shall not be reproduced except in full, without the written approval of ZHT, this document may be altered or revised by ZHT, personal only, and shall be noted in the revision of the document.

Product name..... : Bluetooth headset

Trademark : /

Model/Type reference : G9S

Model difference : /

Ratings..... : Input: DC 5V or DC 3.7V powered by battery



Testing procedure and testing location:

Testing Laboratory: Guangdong Zhonghan Testing Technology Co., Ltd.

Address.....: Room 104, Building 1, Yibaolai Industrial Park, Qiaotou Community, Fuhai Street, Bao'an District, Shenzhen, Guangdong, China

Tested by (name + signature): Leon Li

Leon Li

Reviewer (name + signature).....: Baret Wu

Baret Wu

Approved (name + signature): Levi Lee

Levi Lee



Table of Contents

	Page
1. VERSION	5
2. TEST SUMMARY	6
2.1 TEST FACILITY	7
2.2 MEASUREMENT UNCERTAINTY.....	7
3. GENERAL INFORMATION	8
3.1 GENERAL DESCRIPTION OF EUT.....	8
3.2 Test Setup Configuration.....	9
3.3 Support Equipment.....	10
3.4 Test Mode.....	10
3.5 EQUIPMENTS LIST FOR ALL TEST ITEMS.....	11
4. EMC EMISSION TEST	13
4.1 Conducted emissions	13
4.1.1 POWER LINE CONDUCTED EMISSION Limits	13
4.1.2 TEST PROCEDURE.....	13
4.1.3 DEVIATION FROM TEST STANDARD.....	13
4.1.4 TEST SETUP.....	14
4.1.5 EUT OPERATING CONDITIONS.....	14
4.1.6 Test Result.....	14
N/A.....	14
4.2 Radiated emissions.....	15
4.2.1 Radiated Emission Limits	15
4.2.2 TEST PROCEDURE.....	15
4.2.3 DEVIATION FROM TEST STANDARD.....	16
4.2.4 TEST SETUP.....	16
4.2.5 EUT OPERATING CONDITIONS.....	17
4.2.6 TEST RESULTS	18
5. RADIATED BAND EMISSION MEASUREMENT	26
5.1 Test Requirement:	26
5.2 TEST PROCEDURE.....	26
5.3 DEVIATION FROM TEST STANDARD.....	27
5.4 TEST SETUP.....	27
5.5 EUT OPERATING CONDITIONS.....	27
5.6 TEST RESULT.....	28
6. CONDUCTED BAND EDGE AND SPURIOUS EMISSION	30
6.1 Limit	30
6.2 Test Setup.....	30
6.3 Test procedure.....	30
6.4 DEVIATION FROM STANDARD	30
6.5 Test Result.....	31
BAND EDGE	31
BAND EDGE(HOPPING)	38
CONDUCTED RF SPURIOUS EMISSION	45
7. 20DB&99% BANDWIDTH	55
7.1 Test Setup.....	55
7.2 Limit	55
7.3 Test procedure.....	55
7.4 DEVIATION FROM STANDARD	55
7.5 Test Result.....	55
8. MAXIMUM PEAK OUTPUT POWER	66
8.1 Block Diagram Of Test Setup	66
8.2 Limit	66
8.3 Test procedure.....	66
8.4 DEVIATION FROM STANDARD	66
8.5 Test Result.....	66
9. HOPPING CHANNEL SEPARATION	72
9.1 Test Setup.....	72



9.2 Test procedure.....	72
9.3 DEVIATION FROM STANDARD	72
9.4 Test Result.....	72
10.NUMBER OF HOPPING FREQUENCY	78
10.1 Test Setup.....	78
10.2 Test procedure.....	78
10.3 DEVIATION FROM STANDARD	78
10.4 Test Result.....	79
11. DWELL TIME.....	84
11.1 Test Setup.....	84
11.2 Test procedure.....	84
11.3 DEVIATION FROM STANDARD	84
11.4 Test Result.....	85
12. ANTENNA REQUIREMENT.....	95
13. TEST SETUP PHOTO	96
14. EUT CONSTRUCTIONAL DETAILS	96



1. VERSION

Report No.	Version	Description	Approved
ZHT-240903007E	Rev.01	Initial issue of report	Sept. 09, 2024



2. TEST SUMMARY

Test procedures according to the technical standards:

FCC Part15 (15.247) , Subpart C			
Standard Section	Test Item	Result	Remark
FCC part 15.203/15.247 (b)(4)	Antenna Requirement	PASS	
15.207	AC Power Line Conducted Emission	N/A	
15.247 (b)(1)	Conducted Peak Output Power	PASS	
15.247 (a)(1)	20dB Occupied Bandwidth 99% OCB	PASS	
15.247 (a)(1)	Carrier Frequencies Separation	PASS	
15.247 (a)(1)(iii)	Hopping Channel Number	PASS	
15.247 (a)(1)(iii)	Dwell Time	PASS	
15.205/15.209	Radiated Emission and Restricted Band	PASS	
15.247(d)	Conducted Unwanted emissions and Band Edge	PASS	

NOTE:

(1) " N/A" denotes test is not applicable in this Test Report

(2)The EUT was programmed to be in continuously transmitting mode and the transmit duty cycle is not less than 98%.



2.1 TEST FACILITY

Guangdong Zhonghan Testing Technology Co., Ltd.
Add. : Room 104, Building 1, Yibaolai Industrial Park, Qiaotou Community, Fuhai Street, Bao'an District, Shenzhen, Guangdong, China

FCC Registration Number:255941
Designation Number: CN0325
IC Registered No.: 29832
CAB identifier: CN0143

2.2 MEASUREMENT UNCERTAINTY

The reported uncertainty of measurement $y \pm U$, where expanded uncertainty U is based on a standard uncertainty multiplied by a coverage factor of $k=2$, providing a level of confidence of approximately 95 %.

No.	Item	Uncertainty
1	Conducted Emission Test	$\pm 1.38\text{dB}$
2	RF conducted power	$\pm 0.16\text{dB}$
3	Conducted spurious emissions	$\pm 0.21\text{dB}$
4	All radiated emissions (9k-30MHz)	$\pm 4.68\text{dB}$
5	All radiated emissions (<1G)	$\pm 4.68\text{dB}$
6	All radiated emissions (>1G)	$\pm 4.89\text{dB}$
7	Temperature	$\pm 0.5^\circ\text{C}$
8	Humidity	$\pm 2\%$
9	Occupied Bandwidth	$\pm 4.96\text{dB}$



3. GENERAL INFORMATION

3.1 GENERAL DESCRIPTION OF EUT

Product Name:	Bluetooth headset
Test Model No.:	G9S
Hardware Version:	V1.0
Software Version:	V1.0
Sample(s) Status:	Engineer sample
Channel numbers:	79
Channel separation:	2402MHz-2480MHz
Modulation technology:	GFSK, $\pi/4$ DQPSK, 8DPSK
Antenna Type:	PCB antenna
Antenna gain:	1.52dBi



Operation Frequency each of channel							
Channel	Frequency	Channel	Frequency	Channel	Frequency	Channel	Frequency
1	2402MHz	21	2422MHz	41	2442MHz	61	2462MHz
2	2403MHz	22	2423MHz	42	2443MHz	62	2463MHz
3	2404MHz	23	2424MHz	43	2444MHz	63	2464MHz
4	2405MHz	24	2425MHz	44	2445MHz	64	2465MHz
5	2406MHz	25	2426MHz	45	2446MHz	65	2466MHz
6	2407MHz	26	2427MHz	46	2447MHz	66	2467MHz
7	2408MHz	27	2428MHz	47	2448MHz	67	2468MHz
8	2409MHz	28	2429MHz	48	2449MHz	68	2469MHz
9	2410MHz	29	2430MHz	49	2450MHz	69	2470MHz
10	2411MHz	30	2431MHz	50	2451MHz	70	2471MHz
11	2412MHz	31	2432MHz	51	2452MHz	71	2472MHz
12	2413MHz	32	2433MHz	52	2453MHz	72	2473MHz
13	2414MHz	33	2434MHz	53	2454MHz	73	2474MHz
14	2415MHz	34	2435MHz	54	2455MHz	74	2475MHz
15	2416MHz	35	2436MHz	55	2456MHz	75	2476MHz
16	2417MHz	36	2437MHz	56	2457MHz	76	2477MHz
17	2418MHz	37	2438MHz	57	2458MHz	77	2478MHz
18	2419MHz	38	2439MHz	58	2459MHz	78	2479MHz
19	2420MHz	39	2440MHz	59	2460MHz	79	2480MHz
20	2421MHz	40	2441MHz	60	2461MHz		

Note:

In section 15.31(m), regards to the operating frequency range over 10 MHz, the Lowest frequency, the middle frequency, and the highest frequency of channel were selected to perform the test, and the selected channel see below:

Test channel	Frequency
The lowest channel	2402MHz
The middle channel	2441MHz
The Highest channel	2480MHz

3.2 Test Setup Configuration

Radiated Emission

EUT



3.3 Support Equipment

The EUT has been tested as an independent unit together with other necessary accessories or support units. The following support units or accessories were used to form a representative test configuration during the tests.

Item	Equipment	Mfr/Brand	Model/Type No.	Series No.	Note

Item	Shielded Type	Ferrite Core	Length	Note

Note:

- (1) The support equipment was authorized by Declaration of Confirmation.
- (2) For detachable type I/O cable should be specified the length in cm in 『Length』 column.
- (3) The test software is the Bluetooth RF Test Tool which can set the EUT into the individual test modes.TX Power:7

3.4 Test Mode

Transmitting mode	Keep the EUT in continuously transmitting mode.
Remark: During the test, the test voltage was tuned from 85% to 115% of the nominal rated supply voltage, and found that the worst case was under the nominal rated supply condition. So the report just shows that condition's data.	



3.5 EQUIPMENTS LIST FOR ALL TEST ITEMS

Radiation Test equipment

Item	Equipment	Manufacturer	Model	Serial No.	Last Cal.	Next Cal.
1	Receiver	R&S	ESCI	100874	May 10, 2024	May 09, 2025
2	Loop antenna	EMCI	LAP600	272	May 10, 2024	May 09, 2025
3	Amplifier	Schwarzbeck	BBV 9743 B	00378	May 10, 2024	May 09, 2025
4	Amplifier	Schwarzbeck	BBV 9718 B	00040	May 10, 2024	May 09, 2025
5	Bilog Antenna	Schwarzbeck	VULB9162	00498	May 28, 2024	May 27, 2025
6	Horn Antenna	Schwarzbeck	BBHA9120D	02623	May 16, 2024	May 15, 2025
7	Horn Antenna	A.H.SYSTEMS	SAS574	588	May 10, 2024	May 09, 2025
8	Amplifier	AEROFLEX	100KHz-40GHz	097	May 10, 2024	May 09, 2025
9	Spectrum Analyzer	R&S	FSV40	101413	May 16, 2024	May 15, 2025
10	966 Anechoic Chamber	EMToni	9m6m6m	/	Nov. 25, 2021	Nov. 24, 2024
11	Spectrum Analyzer	KEYSIGHT	N9020A	MY53420208	May 10, 2024	May 09, 2025
12	WIDBAND RADIO COMMUNICATION TESTER	R&S	CMW500	109863	May 10, 2024	May 09, 2025
13	Single Generator	Agilent	N5182A	MY48180575	May 10, 2024	May 09, 2025
14	Power Sensor	MWRFtest	MW100-RFCB	/	May 10, 2024	May 09, 2025
15	Power Amplifier Shielding Room	EMToni	2m3m3m	/	Nov. 25, 2021	Nov. 24, 2024



Conduction Test equipment

Equipment	Manufacturer	Model	Serial No.	Last Cal.	Next Cal.
Receiver	R&S	ESCI	100874	May 10, 2024	May 09, 2025
LISN	R&S	ENV216	102794	May 10, 2024	May 09, 2025
ISN CAT 6	Schwarzbeck	NTFM 8158	00318	May 10, 2024	May 09, 2025
ISN CAT 5	Schwarzbeck	CAT5 8158	00343	May 10, 2024	May 09, 2025
Capacitive Voltage Probe	Schwarzbeck	CVP 9222 C	00101	May 10, 2024	May 09, 2025
Current Transformer Clamp	Schwarzbeck	SW 9605	SW9605 #209	May 10, 2024	May 09, 2025
CE Shielding Room	EMToni	9m4m3m	/	Nov. 25, 2021	Nov. 24, 2024



4. EMC EMISSION TEST

4.1 Conducted emissions

Test Requirement:	FCC Part15 C Section 15.207, RSS-Gen 8.8
Test Method:	ANSI C63.10:2013
Test Frequency Range:	150KHz to 30MHz
Receiver setup:	RBW=9KHz, VBW=30KHz, Sweep time=auto

4.1.1 POWER LINE CONDUCTED EMISSION Limits

FREQUENCY (MHz)	Limit (dBuV)		Standard
	Quasi-peak	Average	
0.15 -0.5	66 - 56 *	56 - 46 *	FCC
0.50 -5.0	56.00	46.00	FCC
5.0 -30.0	60.00	50.00	FCC

Note:

(1) *Decreases with the logarithm of the frequency.

4.1.2 TEST PROCEDURE

- a. The EUT was placed 0.8 meters from the horizontal ground plane with EUT being connected to the power mains through a line impedance stabilization network (LISN). All other support equipments powered from additional LISN(s). The LISN provide 50 Ohm/ 50uH of coupling impedance for the measuring instrument.
- b. Interconnecting cables that hang closer than 40 cm to the ground plane shall be folded back and forth in the center forming a bundle 30 to 40 cm long.
- c. I/O cables that are not connected to a peripheral shall be bundled in the center. The end of the cable may be terminated, if required, using the correct terminating impedance. The overall length shall not exceed 1 m.
- d. LISN at least 80 cm from nearest part of EUT chassis.
- e. For the actual test configuration, please refer to the related Item –EUT Test Photos.

4.1.3 DEVIATION FROM TEST STANDARD

No deviation

4.1.4 TEST SETUP

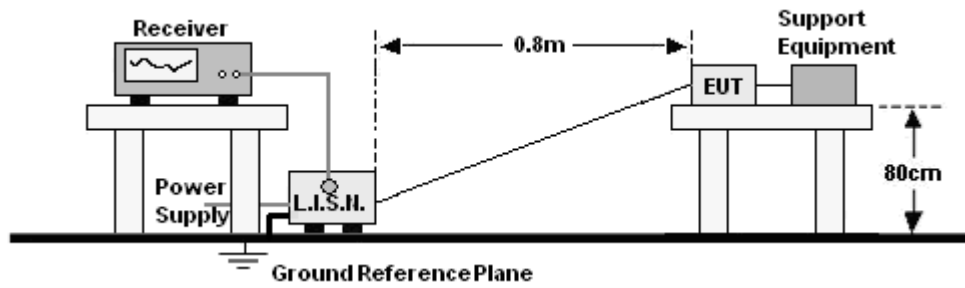

4.1.5 EUT OPERATING CONDITIONS

The EUT was configured for testing in a typical fashion (as a customer would normally use it). The EUT has been programmed to continuously transmit during test. This operating condition was tested and used to collect the included data.

4.1.6 Test Result

N/A

This product charging and BT cannot be used at the same time, the test item is not applicable.



4.2 Radiated emissions

Test Requirement:	FCC Part15 C Section 15.209, RSS-Gen 8.9, RSS-Gen 8.10				
Test Method:	ANSI C63.10:2013				
Test Frequency Range:	9kHz to 25GHz				
Test site:	Measurement Distance: 3m				
Receiver setup:	Frequency	Detector	RBW	VBW	Value
	9KHz-150KHz	Quasi-peak	200Hz	600Hz	Quasi-peak
	150KHz-30MHz	Quasi-peak	9KHz	30KHz	Quasi-peak
	30MHz-1GHz	Quasi-peak	100KHz	300KHz	Quasi-peak
	Above 1GHz	Peak	1MHz	3MHz	Peak
		Average	1MHz	10Hz	Average

4.2.1 Radiated Emission Limits

Frequencies (MHz)	Field Strength (micorvolts/meter)	Measurement Distance (meters)
0.009~0.490	2400/F(KHz)	300
0.490~1.705	24000/F(KHz)	30
1.705~30.0	30	30
30~88	100	3
88~216	150	3
216~960	200	3
Above 960	500	3

LIMITS OF RADIATED EMISSION MEASUREMENT

FREQUENCY (MHz)	Limit (dBuV/m) (at 3M)	
	PEAK	AVERAGE
Above 1000	74	54

Notes:

- (1) The limit for radiated test was performed according to FCC PART 15C.
- (2) The tighter limit applies at the band edges.
- (3) Emission level (dBuV/m)=20log Emission level (uV/m).

4.2.2 TEST PROCEDURE

Below 1GHz test procedure as below:

- a. The EUT was placed on the top of a rotating table 0.8 meters above the ground at a 3 meter semi-anechoic chamber. The table was rotated 360 degrees to determine the position of the highest radiation.
- b. The EUT was set 3 meters away from the interference-receiving antenna, which was mounted on the top of a variable-height antenna tower.
- c. The antenna height is varied from one meter to four meters above the ground to determine the maximum value of the field strength. Both horizontal and vertical polarizations of the antenna are set to make the measurement.

- d. For each suspected emission, the EUT was arranged to its worst case and then the antenna was tuned to heights from 1 meter to 4 meters (for the test frequency of below 30MHz, the antenna was tuned to heights 1 meter) and the rotatable table was turned from 0 degrees to 360 degrees to find the maximum reading.
- e. The test-receiver system was set to Peak Detect Function and Specified Bandwidth with Maximum Hold Mode.
- f. If the emission level of the EUT in peak mode was 10dB lower than the limit specified, then testing could be stopped and the peak values of the EUT would be reported. Otherwise the emissions that did not have 10dB margin would be re-tested one by one using peak, quasi-peak or average method as specified and then reported in a data sheet.

Above 1GHz test procedure as below:

- g. Different between above is the test site, change from Semi- Anechoic Chamber to fully Anechoic Chamber and change form table 0.8 metre to 1.5 metre(Above 18GHz the distance is 1 meter and table is 1.5 metre).
- h. Test the EUT in the lowest channel ,the middle channel ,the Highest channel

Note:

Both horizontal and vertical antenna polarities were tested and performed pretest to three orthogonal axis. The worst case emissions were reported

4.2.3 DEVIATION FROM TEST STANDARD

No deviation

4.2.4 TEST SETUP

(A) Radiated Emission Test-Up Frequency Below 30MHz

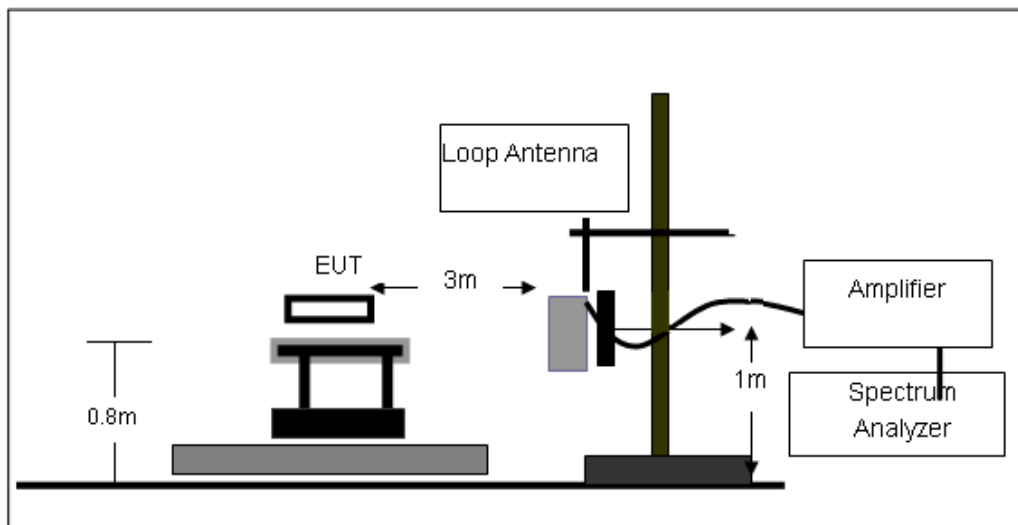

(B) Radiated Emission Test-Up Frequency 30MHz~1GHz

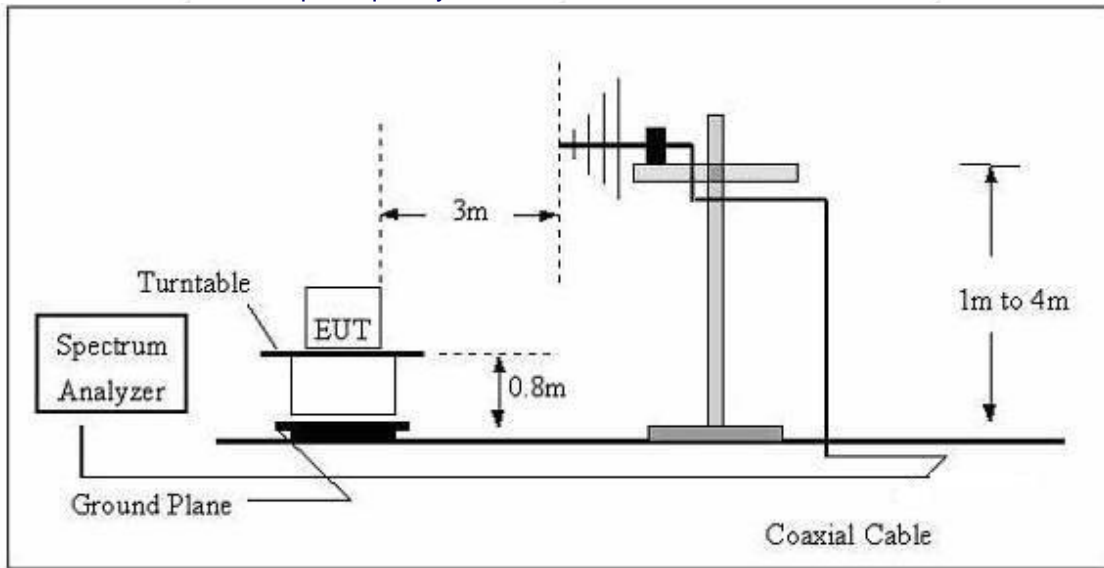

(C) Radiated Emission Test-Up Frequency Above 1GHz

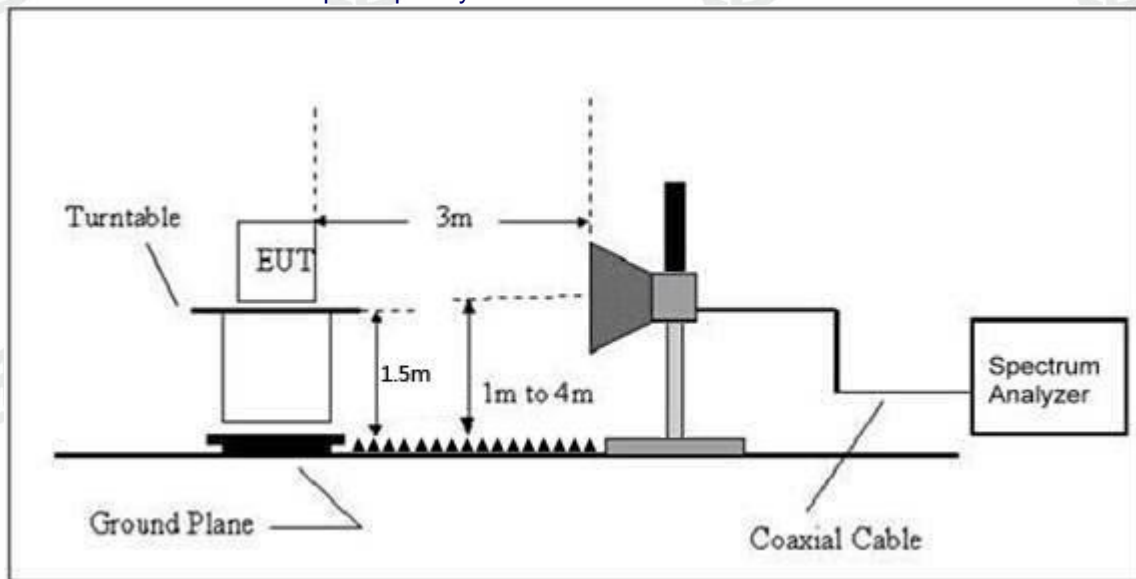

4.2.5 EUT OPERATING CONDITIONS

The EUT tested system was configured as the statements of 2.4 Unless otherwise a special operating condition is specified in the follows during the testing.



4.2.6 TEST RESULTS

Between 9KHz – 30MHz

The emission from 9 kHz to 30MHz was pre-tested and found the result was 20dB lower than the limit, and according to 15.31(o), the test result no need to reported.

Between 30MHz – 1GHz

Temperature:	25.2°C	Relative Humidity:	50%
Pressure:	1010kPa	Polarization:	Horizontal
Test Voltage:	DC 3.7V		

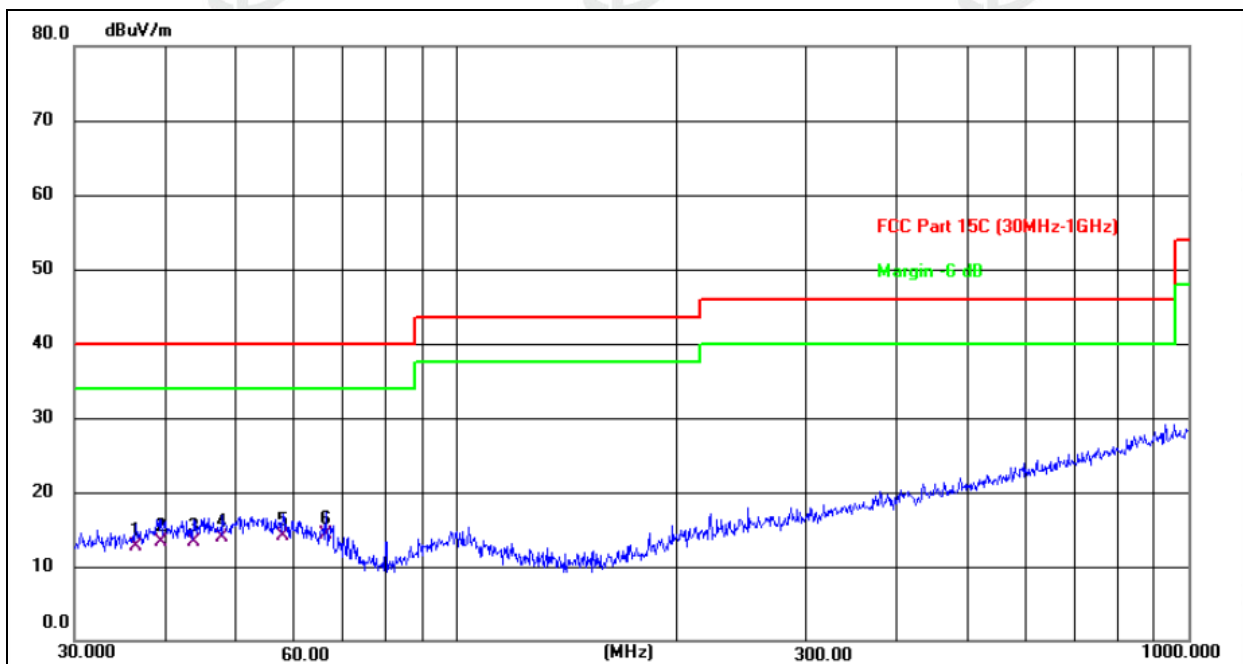

No.	Frequency (MHz)	Reading (dBuV)	Factor (dB/m)	Level (dBuV/m)	Limit (dBuV/m)	Margin (dB)	Detector
1	36.3814	23.07	-10.33	12.74	40.00	-27.26	QP
2	39.4371	23.19	-9.79	13.40	40.00	-26.60	QP
3	43.6584	22.68	-9.34	13.34	40.00	-26.66	QP
4	47.8260	22.85	-8.95	13.90	40.00	-26.10	QP
5	57.7962	23.65	-9.60	14.05	40.00	-25.95	QP
6 *	66.2661	26.10	-11.84	14.26	40.00	-25.74	QP



Temperature:	25.2°C	Relative Humidity:	50%
Pressure:	1010kPa	Polarization:	Vertical
Test Voltage:	DC 3.7V		

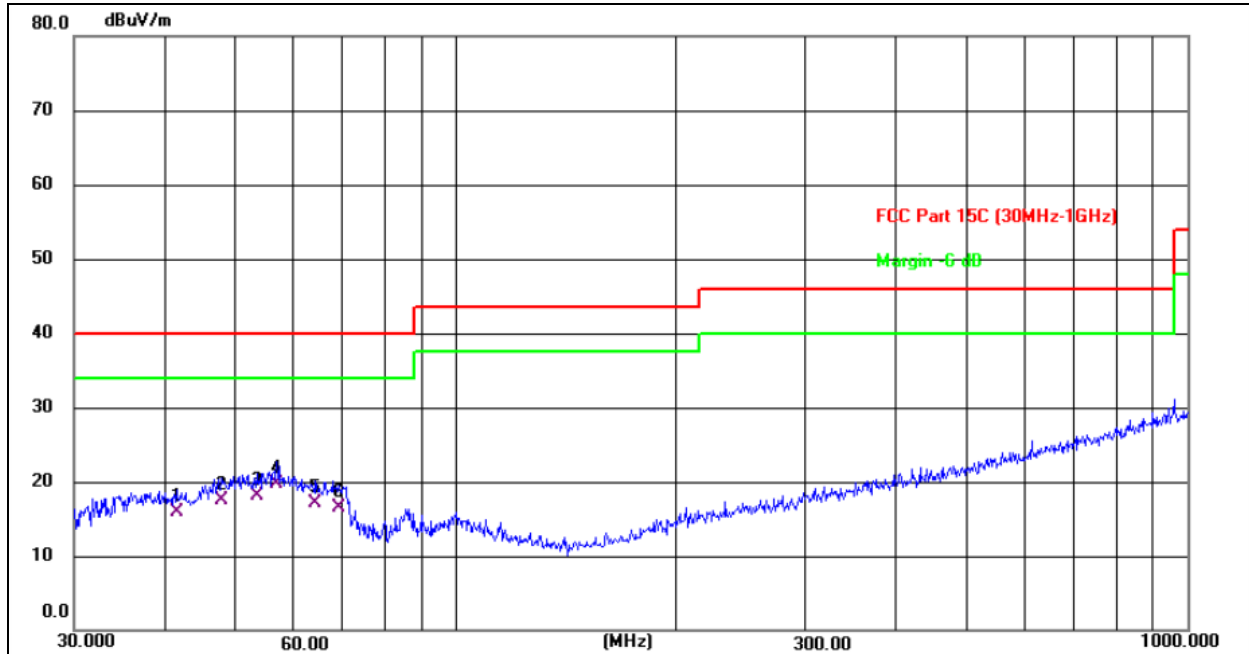

No.	Frequency (MHz)	Reading (dBuV)	Factor (dB/m)	Level (dBuV/m)	Limit (dBuV/m)	Margin (dB)	Detector
1	41.4215	25.37	-9.56	15.81	40.00	-24.19	QP
2	47.8260	26.47	-8.95	17.52	40.00	-22.48	QP
3	53.3180	27.15	-9.10	18.05	40.00	-21.95	QP
4 *	56.7917	29.15	-9.48	19.67	40.00	-20.33	QP
5	64.2074	28.29	-11.19	17.10	40.00	-22.90	QP
6	69.1140	29.35	-12.76	16.59	40.00	-23.41	QP

Remarks:

- 1.Final Level =Receiver Read level + Antenna Factor + Cable Loss
- 2.The emission levels of other frequencies are very lower than the limit and not show in test report.
- 3.The test data shows only the worst case GFSK mode(Low Channel:2402MHz).



1GHz~25GHz

GFSK

Polar (H/V)	Frequency	Meter Reading	Pre-amplifier	Cable Loss	Antenna Factor	Emission Level	Limits	Margin	Detector Type
	(MHz)	(dBuV)	(dB)	(dB)	(dB)	(dBuV/m)	(dBuV/m)	(dB)	
Low Channel:2402MHz									
V	4804.00	56.37	30.55	5.77	24.66	56.25	74	-17.75	Pk
V	4804.00	44.61	30.55	5.77	24.66	44.49	54	-9.51	AV
V	7206.00	56.48	30.33	6.32	24.55	57.02	74	-16.98	Pk
V	7206.00	44.77	30.33	6.32	24.55	45.31	54	-8.69	AV
V	9608.00	57.01	30.55	5.77	24.66	56.89	74	-17.11	Pk
V	9608.00	42.94	30.55	5.77	24.66	42.82	54	-11.18	AV
V	12010.00	56.5	30.33	6.32	24.55	57.04	74	-16.96	Pk
V	12010.00	41.39	30.33	6.32	24.55	41.93	54	-12.07	AV
H	4804.00	59.41	30.55	5.77	24.66	59.29	74	-14.71	Pk
H	4804.00	41.1	30.55	5.77	24.66	40.98	54	-13.02	AV
H	7206.00	59.03	30.33	6.32	24.55	59.57	74	-14.43	Pk
H	7206.00	41.33	30.33	6.32	24.55	41.87	54	-12.13	AV
H	9608.00	55.27	30.55	5.77	24.66	55.15	74	-18.85	Pk
H	9608.00	41	30.55	5.77	24.66	40.88	54	-13.12	AV
H	12010.00	59.05	30.33	6.32	24.55	59.59	74	-14.41	Pk
H	12010.00	41.56	30.33	6.32	24.55	42.1	54	-11.9	AV

Polar (H/V)	Frequency	Meter Reading	Pre-amplifier	Cable Loss	Antenna Factor	Emission Level	Limits	Margin	Detector Type
	(MHz)	(dBuV)	(dB)	(dB)	(dB)	(dBuV/m)	(dBuV/m)	(dB)	
Middle Channel:2441MHz									
V	4882.00	56.23	30.55	5.77	24.66	56.11	74	-17.89	Pk
V	4882.00	41.12	30.55	5.77	24.66	41	54	-13	AV
V	7323.00	55.23	30.33	6.32	24.55	55.77	74	-18.23	Pk
V	7323.00	41.91	30.33	6.32	24.55	42.45	54	-11.55	AV
V	9764.00	56.31	30.55	5.77	24.66	56.19	74	-17.81	Pk
V	9764.00	41.52	30.55	5.77	24.66	41.4	54	-12.6	AV
V	12205.00	57.51	30.33	6.32	24.55	58.05	74	-15.95	Pk
V	12205.00	44.73	30.33	6.32	24.55	45.27	54	-8.73	AV
H	4882.00	57.3	30.55	5.77	24.66	57.18	74	-16.82	Pk
H	4882.00	44.53	30.55	5.77	24.66	44.41	54	-9.59	AV
H	7323.00	56.9	30.33	6.32	24.55	57.44	74	-16.56	Pk
H	7323.00	44.76	30.33	6.32	24.55	45.3	54	-8.7	AV
H	9764.00	59.04	30.55	5.77	24.66	58.92	74	-15.08	Pk
H	9764.00	44.23	30.55	5.77	24.66	44.11	54	-9.89	AV
H	12205.00	57.02	30.33	6.32	24.55	57.56	74	-16.44	Pk
H	12205.00	44.05	30.33	6.32	24.55	44.59	54	-9.41	AV



Polar (H/V)	Frequency	Meter Reading	Pre-amplifier	Cable Loss	Antenna Factor	Emission Level	Limits	Margin	Detector Type
	(MHz)	(dBuV)	(dB)	(dB)	(dB)	(dBuV/m)	(dBuV/m)	(dB)	
High Channel:2480MHz									
V	4960.00	57.9	30.55	5.77	24.66	57.78	74	-16.22	Pk
V	4960.00	41.29	30.55	5.77	24.66	41.17	54	-12.83	AV
V	7440.00	59.49	30.33	6.32	24.55	60.03	74	-13.97	Pk
V	7440.00	42.42	30.33	6.32	24.55	42.96	54	-11.04	AV
V	9920.00	55.67	30.55	5.77	24.66	55.55	74	-18.45	Pk
V	9920.00	41.51	30.55	5.77	24.66	41.39	54	-12.61	AV
V	12400.00	58.71	30.33	6.32	24.55	59.25	74	-14.75	Pk
V	12400.00	41.41	30.33	6.32	24.55	41.95	54	-12.05	AV
H	4960.00	59.59	30.55	5.77	24.66	59.47	74	-14.53	Pk
H	4960.00	41.22	30.55	5.77	24.66	41.1	54	-12.9	AV
H	7440.00	57.22	30.33	6.32	24.55	57.76	74	-16.24	Pk
H	7440.00	43.33	30.33	6.32	24.55	43.87	54	-10.13	AV
H	9920.00	56.43	30.55	5.77	24.66	56.31	74	-17.69	Pk
H	9920.00	42.93	30.55	5.77	24.66	42.81	54	-11.19	AV
H	12400.00	55.41	30.33	6.32	24.55	55.95	74	-18.05	Pk
H	12400.00	41.94	30.33	6.32	24.55	42.48	54	-11.52	AV

Remark:

1. Emission Level = Meter Reading + Antenna Factor + Cable Loss – Pre-amplifier, Margin= Emission Level - Limit
2. If peak below the average limit, the average emission was no test.
3. The amplitude of spurious emissions which are attenuated by more than 20dB below the permissible value has no need to be reported.



π/4DQPSK

Polar (H/V)	Frequency	Meter Reading	Pre-amplifier	Cable Loss	Antenna Factor	Emission Level	Limits	Margin	Detector Type
	(MHz)	(dBuV)	(dB)	(dB)	(dB)	(dBuV/m)	(dBuV/m)	(dB)	
Low Channel:2402MHz									
V	4804.00	58.42	30.55	5.77	24.66	58.3	74	-15.7	Pk
V	4804.00	42.82	30.55	5.77	24.66	42.7	54	-11.3	AV
V	7206.00	59.69	30.33	6.32	24.55	60.23	74	-13.77	Pk
V	7206.00	42.44	30.33	6.32	24.55	42.98	54	-11.02	AV
V	9608.00	57.67	30.55	5.77	24.66	57.55	74	-16.45	Pk
V	9608.00	43.52	30.55	5.77	24.66	43.4	54	-10.6	AV
V	12010.00	58.98	30.33	6.32	24.55	59.52	74	-14.48	Pk
V	12010.00	42.86	30.33	6.32	24.55	43.4	54	-10.6	AV
H	4804.00	57.94	30.55	5.77	24.66	57.82	74	-16.18	Pk
H	4804.00	41.49	30.55	5.77	24.66	41.37	54	-12.63	AV
H	7206.00	58.58	30.33	6.32	24.55	59.12	74	-14.88	Pk
H	7206.00	42.56	30.33	6.32	24.55	43.1	54	-10.9	AV
H	9608.00	57.08	30.55	5.77	24.66	56.96	74	-17.04	Pk
H	9608.00	41.3	30.55	5.77	24.66	41.18	54	-12.82	AV
H	12010.00	55.74	30.33	6.32	24.55	56.28	74	-17.72	Pk
H	12010.00	41.62	30.33	6.32	24.55	42.16	54	-11.84	AV

Polar (H/V)	Frequency	Meter Reading	Pre-amplifier	Cable Loss	Antenna Factor	Emission Level	Limits	Margin	Detector Type
	(MHz)	(dBuV)	(dB)	(dB)	(dB)	(dBuV/m)	(dBuV/m)	(dB)	
Middle Channel:2441MHz									
V	4882.00	59.59	30.55	5.77	24.66	59.47	74	-14.53	Pk
V	4882.00	41.28	30.55	5.77	24.66	41.16	54	-12.84	AV
V	7323.00	55.43	30.33	6.32	24.55	55.97	74	-18.03	Pk
V	7323.00	43.56	30.33	6.32	24.55	44.1	54	-9.9	AV
V	9764.00	56.67	30.55	5.77	24.66	56.55	74	-17.45	Pk
V	9764.00	43.78	30.55	5.77	24.66	43.66	54	-10.34	AV
V	12205.00	56.36	30.33	6.32	24.55	56.9	74	-17.1	Pk
V	12205.00	44.38	30.33	6.32	24.55	44.92	54	-9.08	AV
H	4882.00	57.83	30.55	5.77	24.66	57.71	74	-16.29	Pk
H	4882.00	41.43	30.55	5.77	24.66	41.31	54	-12.69	AV
H	7323.00	59.39	30.33	6.32	24.55	59.93	74	-14.07	Pk
H	7323.00	42.19	30.33	6.32	24.55	42.73	54	-11.27	AV
H	9764.00	55.39	30.55	5.77	24.66	55.27	74	-18.73	Pk
H	9764.00	41.71	30.55	5.77	24.66	41.59	54	-12.41	AV
H	12205.00	58.56	30.33	6.32	24.55	59.1	74	-14.9	Pk
H	12205.00	43.02	30.33	6.32	24.55	43.56	54	-10.44	AV



Polar (H/V)	Frequency	Meter Reading	Pre-amplifier	Cable Loss	Antenna Factor	Emission Level	Limits	Margin	Detector Type
	(MHz)	(dBuV)	(dB)	(dB)	(dB)	(dBuV/m)	(dBuV/m)	(dB)	
High Channel:2480MHz									
V	4960.00	59.55	30.55	5.77	24.66	59.43	74	-14.57	Pk
V	4960.00	41.72	30.55	5.77	24.66	41.6	54	-12.4	AV
V	7440.00	55.9	30.33	6.32	24.55	56.44	74	-17.56	Pk
V	7440.00	41.43	30.33	6.32	24.55	41.97	54	-12.03	AV
V	9920.00	56.9	30.55	5.77	24.66	56.78	74	-17.22	Pk
V	9920.00	41.06	30.55	5.77	24.66	40.94	54	-13.06	AV
V	12400.00	59.44	30.33	6.32	24.55	59.98	74	-14.02	Pk
V	12400.00	41.87	30.33	6.32	24.55	42.41	54	-11.59	AV
H	4960.00	59.4	30.55	5.77	24.66	59.28	74	-14.72	Pk
H	4960.00	41.52	30.55	5.77	24.66	41.4	54	-12.6	AV
H	7440.00	58.11	30.33	6.32	24.55	58.65	74	-15.35	Pk
H	7440.00	44.3	30.33	6.32	24.55	44.84	54	-9.16	AV
H	9920.00	56.39	30.55	5.77	24.66	56.27	74	-17.73	Pk
H	9920.00	41.24	30.55	5.77	24.66	41.12	54	-12.88	AV
H	12400.00	58.82	30.33	6.32	24.55	59.36	74	-14.64	Pk
H	12400.00	44.24	30.33	6.32	24.55	44.78	54	-9.22	AV

Remark:

1. Emission Level = Meter Reading + Antenna Factor + Cable Loss – Pre-amplifier,
Margin= Emission Level - Limit
2. If peak below the average limit, the average emission was no test.
3. The amplitude of spurious emissions which are attenuated by more than 20dB below the permissible value has no need to be reported.



8DPSK

Polar (H/V)	Frequency	Meter Reading	Pre-amplifier	Cable Loss	Antenna Factor	Emission Level	Limits	Margin	Detector Type
	(MHz)	(dBuV)	(dB)	(dB)	(dB)	(dBuV/m)	(dBuV/m)	(dB)	
Low Channel:2402MHz									
V	4804.00	57.93	30.55	5.77	24.66	57.81	74	-16.19	Pk
V	4804.00	41.74	30.55	5.77	24.66	41.62	54	-12.38	AV
V	7206.00	55.29	30.33	6.32	24.55	55.83	74	-18.17	Pk
V	7206.00	41.55	30.33	6.32	24.55	42.09	54	-11.91	AV
V	9608.00	56.32	30.55	5.77	24.66	56.2	74	-17.8	Pk
V	9608.00	42.16	30.55	5.77	24.66	42.04	54	-11.96	AV
V	12010.00	56.22	30.33	6.32	24.55	56.76	74	-17.24	Pk
V	12010.00	43.57	30.33	6.32	24.55	44.11	54	-9.89	AV
H	4804.00	55.19	30.55	5.77	24.66	55.07	74	-18.93	Pk
H	4804.00	41.82	30.55	5.77	24.66	41.7	54	-12.3	AV
H	7206.00	59.04	30.33	6.32	24.55	59.58	74	-14.42	Pk
H	7206.00	43.77	30.33	6.32	24.55	44.31	54	-9.69	AV
H	9608.00	56.28	30.55	5.77	24.66	56.16	74	-17.84	Pk
H	9608.00	41.06	30.55	5.77	24.66	40.94	54	-13.06	AV
H	12010.00	56.16	30.33	6.32	24.55	56.7	74	-17.3	Pk
H	12010.00	41.34	30.33	6.32	24.55	41.88	54	-12.12	AV

Polar (H/V)	Frequency	Meter Reading	Pre-amplifier	Cable Loss	Antenna Factor	Emission Level	Limits	Margin	Detector Type
	(MHz)	(dBuV)	(dB)	(dB)	(dB)	(dBuV/m)	(dBuV/m)	(dB)	
Middle Channel:2441MHz									
V	4882.00	59.7	30.55	5.77	24.66	59.58	74	-14.42	Pk
V	4882.00	41.03	30.55	5.77	24.66	40.91	54	-13.09	AV
V	7323.00	56.31	30.33	6.32	24.55	56.85	74	-17.15	Pk
V	7323.00	41.96	30.33	6.32	24.55	42.5	54	-11.5	AV
V	9764.00	59.41	30.55	5.77	24.66	59.29	74	-14.71	Pk
V	9764.00	43.7	30.55	5.77	24.66	43.58	54	-10.42	AV
V	12205.00	57.58	30.33	6.32	24.55	58.12	74	-15.88	Pk
V	12205.00	43.35	30.33	6.32	24.55	43.89	54	-10.11	AV
H	4882.00	59.78	30.55	5.77	24.66	59.66	74	-14.34	Pk
H	4882.00	43.13	30.55	5.77	24.66	43.01	54	-10.99	AV
H	7323.00	59.3	30.33	6.32	24.55	59.84	74	-14.16	Pk
H	7323.00	43.78	30.33	6.32	24.55	44.32	54	-9.68	AV
H	9764.00	58.52	30.55	5.77	24.66	58.4	74	-15.6	Pk
H	9764.00	44.73	30.55	5.77	24.66	44.61	54	-9.39	AV
H	12205.00	55.41	30.33	6.32	24.55	55.95	74	-18.05	Pk
H	12205.00	42.79	30.33	6.32	24.55	43.33	54	-10.67	AV



Polar (H/V)	Frequency	Meter Reading	Pre-amplifier	Cable Loss	Antenna Factor	Emission Level	Limits	Margin	Detector Type
	(MHz)	(dBuV)	(dB)	(dB)	(dB)	(dBuV/m)	(dBuV/m)	(dB)	
High Channel:2480MHz									
V	4960.00	59.72	30.55	5.77	24.66	59.6	74	-14.4	Pk
V	4960.00	41.96	30.55	5.77	24.66	41.84	54	-12.16	AV
V	7440.00	55.13	30.33	6.32	24.55	55.67	74	-18.33	Pk
V	7440.00	41.98	30.33	6.32	24.55	42.52	54	-11.48	AV
V	9920.00	59.03	30.55	5.77	24.66	58.91	74	-15.09	Pk
V	9920.00	41.05	30.55	5.77	24.66	40.93	54	-13.07	AV
V	12400.00	59.75	30.33	6.32	24.55	60.29	74	-13.71	Pk
V	12400.00	41.44	30.33	6.32	24.55	41.98	54	-12.02	AV
H	4960.00	57.14	30.55	5.77	24.66	57.02	74	-16.98	Pk
H	4960.00	44.26	30.55	5.77	24.66	44.14	54	-9.86	AV
H	7440.00	59.85	30.33	6.32	24.55	60.39	74	-13.61	Pk
H	7440.00	43.42	30.33	6.32	24.55	43.96	54	-10.04	AV
H	9920.00	59.4	30.55	5.77	24.66	59.28	74	-14.72	Pk
H	9920.00	43.07	30.55	5.77	24.66	42.95	54	-11.05	AV
H	12400.00	55.05	30.33	6.32	24.55	55.59	74	-18.41	Pk
H	12400.00	42	30.33	6.32	24.55	42.54	54	-11.46	AV

Remark:

1. Emission Level = Meter Reading + Antenna Factor + Cable Loss – Pre-amplifier,
Margin= Emission Level - Limit
2. If peak below the average limit, the average emission was no test.
3. The amplitude of spurious emissions which are attenuated by more than 20dB below the permissible value has no need to be reported.

5. RADIATED BAND EMISSION MEASUREMENT

5.1 Test Requirement:

Test Requirement:	FCC Part15 C Section 15.209 and 15.205, RSS-Gen 8.9, RSS-Gen 8.10				
Test Method:	ANSI C63.10: 2013				
Test Frequency Range:	All of the restrict bands were tested, only the worst band's (2310MHz to 2500MHz) data was showed.				
Test site:	Measurement Distance: 3m				
Receiver setup:	Frequency	Detector	RBW	VBW	Value
	Above 1GHz	Peak	1MHz	3MHz	Peak
		Average	1MHz	3MHz	Average

LIMITS OF RADIATED EMISSION MEASUREMENT (Above 1000MHz)

FREQUENCY (MHz)	Limit (dBuV/m) (at 3M)	
	PEAK	AVERAGE
Above 1000	74	54

Notes:

- (1) The limit for radiated test was performed according to FCC PART 15C.
- (2) The tighter limit applies at the band edges.
- (3) Emission level (dBuV/m)=20log Emission level (uV/m).

Spectrum Parameter	Setting
Attenuation	Auto
Start Frequency	2300MHz
Stop Frequency	2520
RB / VB (emission in restricted band)	1 MHz / 1 MHz for Peak, 1 MHz / 10Hz for Average

5.2 TEST PROCEDURE

Above 1GHz test procedure as below:

- a. 1. The EUT was placed on the top of a rotating table 1.5 meters above the ground at a 3 meter camber. The table was rotated 360 degrees to determine the position of the highest radiation.
- b. The EUT was set 3 meters away from the interference-receiving antenna, which was mounted on the top of a variable-height antenna tower.
- c. The antenna height is varied from one meter to four meters above the ground to determine the maximum value of the field strength. Both horizontal and vertical polarizations of the antenna are set to make the measurement.
- d. For each suspected emission, the EUT was arranged to its worst case and then the antenna was tuned to heights from 1 meter to 4 meters and the rota table was turned from 0 degrees to 360 degrees to find the maximum reading.
- e. The test-receiver system was set to Peak Detect Function and Specified Bandwidth with Maximum Hold Mode.
- f. If the emission level of the EUT in peak mode was 10dB lower than the limit specified, then testing could be stopped and the peak values of the EUT would be reported. Otherwise the emissions that did not have 10dB margin would be re-tested one by one using peak, quasi-peak or average method as specified and then reported in a data sheet.
- g. Test the EUT in the lowest channel,the Highest channel

Note:

Both horizontal and vertical antenna polarities were tested and performed pretest to three orthogonal axis. The worst case emissions were reported

5.3 DEVIATION FROM TEST STANDARD

No deviation

5.4 TEST SETUP

Radiated Emission Test-Up Frequency Above 1GHz

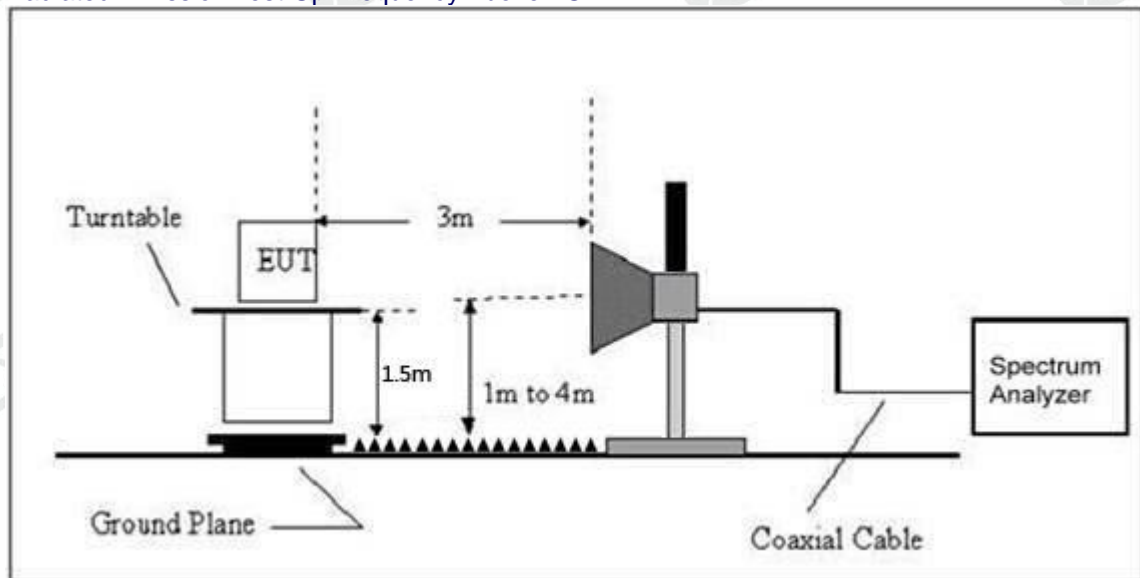

5.5 EUT OPERATING CONDITIONS

The EUT tested system was configured as the statements of 2.3 Unless otherwise a special operating condition is specified in the follows during the testing.



5.6 TEST RESULT

	Polar (H/V)	Frequency (MHz)	Meter Reading (dBuV)	Pre-amplifier (dB)	Cable Loss (dB)	Antenna Factor (dB/m)	Emission level (dBuV/m)	Limit (dBuV/m)	Margin (dB)	Detector Type	Result
GFSK	Low Channel: 2402MHz										
	H	2390.00	59.98	30.22	4.85	23.98	58.59	74.00	-15.41	PK	PASS
	H	2390.00	47.22	30.22	4.85	23.98	45.83	54.00	-8.17	AV	PASS
	H	2400.00	62.33	30.22	4.85	23.98	60.94	74.00	-13.06	PK	PASS
	H	2400.00	48.15	30.22	4.85	23.98	46.76	54.00	-7.24	AV	PASS
	V	2390.00	60.73	30.22	4.85	23.98	59.34	74.00	-14.66	PK	PASS
	V	2390.00	47.54	30.22	4.85	23.98	46.15	54.00	-7.85	AV	PASS
	V	2400.00	60.94	30.22	4.85	23.98	59.55	74.00	-14.45	PK	PASS
	V	2400.00	46.54	30.22	4.85	23.98	45.15	54.00	-8.85	AV	PASS
	High Channel: 2480MHz										
	H	2483.50	59.31	30.22	4.85	23.98	57.92	74.00	-16.08	PK	PASS
	H	2483.50	46.38	30.22	4.85	23.98	44.99	54.00	-9.01	AV	PASS
	H	2500.00	61.13	30.22	4.85	23.98	59.74	74.00	-14.26	PK	PASS
	H	2500.00	46.71	30.22	4.85	23.98	45.32	54.00	-8.68	AV	PASS
	V	2483.50	59.43	30.22	4.85	23.98	58.04	74.00	-15.96	PK	PASS
	V	2483.50	48.47	30.22	4.85	23.98	47.08	54.00	-6.92	AV	PASS
V	2500.00	62.31	30.22	4.85	23.98	60.92	74.00	-13.08	PK	PASS	
V	2500.00	47.47	30.22	4.85	23.98	46.08	54.00	-7.92	AV	PASS	
π/4DQPSK	Low Channel: 2402MHz										
	H	2390.00	60.98	30.22	4.85	23.98	59.59	74.00	-14.41	PK	PASS
	H	2390.00	47.86	30.22	4.85	23.98	46.47	54.00	-7.53	AV	PASS
	H	2400.00	62.02	30.22	4.85	23.98	60.63	74.00	-13.37	PK	PASS
	H	2400.00	46.18	30.22	4.85	23.98	44.79	54.00	-9.21	AV	PASS
	V	2390.00	61.70	30.22	4.85	23.98	60.31	74.00	-13.69	PK	PASS
	V	2390.00	46.58	30.22	4.85	23.98	45.19	54.00	-8.81	AV	PASS
	V	2400.00	60.93	30.22	4.85	23.98	59.54	74.00	-14.46	PK	PASS
	V	2400.00	47.52	30.22	4.85	23.98	46.13	54.00	-7.87	AV	PASS
	High Channel: 2480MHz										
	H	2483.50	62.37	30.22	4.85	23.98	60.98	74.00	-13.02	PK	PASS
	H	2483.50	46.14	30.22	4.85	23.98	44.75	54.00	-9.25	AV	PASS
	H	2500.00	61.63	30.22	4.85	23.98	60.24	74.00	-13.76	PK	PASS
	H	2500.00	46.80	30.22	4.85	23.98	45.41	54.00	-8.59	AV	PASS
	V	2483.50	61.68	30.22	4.85	23.98	60.29	74.00	-13.71	PK	PASS
	V	2483.50	46.22	30.22	4.85	23.98	44.83	54.00	-9.17	AV	PASS
V	2500.00	59.22	30.22	4.85	23.98	57.83	74.00	-16.17	PK	PASS	
V	2500.00	46.07	30.22	4.85	23.98	44.68	54.00	-9.32	AV	PASS	



Low Channel: 2402MHz												
8DPSK	H	2390.00	62.03	30.22	4.85	23.98	60.64	74.00	-13.36	PK	PASS	
	H	2390.00	48.00	30.22	4.85	23.98	46.61	54.00	-7.39	AV	PASS	
	H	2400.00	61.80	30.22	4.85	23.98	60.41	74.00	-13.59	PK	PASS	
	H	2400.00	47.81	30.22	4.85	23.98	46.42	54.00	-7.58	AV	PASS	
	V	2390.00	61.04	30.22	4.85	23.98	59.65	74.00	-14.35	PK	PASS	
	V	2390.00	46.85	30.22	4.85	23.98	45.46	54.00	-8.54	AV	PASS	
	V	2400.00	60.37	30.22	4.85	23.98	58.98	74.00	-15.02	PK	PASS	
	V	2400.00	46.20	30.22	4.85	23.98	44.81	54.00	-9.19	AV	PASS	
	High Channel: 2480MHz											
	H	2483.50	60.79	30.22	4.85	23.98	59.40	74.00	-14.60	PK	PASS	
	H	2483.50	46.57	30.22	4.85	23.98	45.18	54.00	-8.82	AV	PASS	
	H	2500.00	62.08	30.22	4.85	23.98	60.69	74.00	-13.31	PK	PASS	
	H	2500.00	46.37	30.22	4.85	23.98	44.98	54.00	-9.02	AV	PASS	
	V	2483.50	60.34	30.22	4.85	23.98	58.95	74.00	-15.05	PK	PASS	
	V	2483.50	48.37	30.22	4.85	23.98	46.98	54.00	-7.02	AV	PASS	
	V	2500.00	61.89	30.22	4.85	23.98	60.50	74.00	-13.50	PK	PASS	
V	2500.00	47.16	30.22	4.85	23.98	45.77	54.00	-8.23	AV	PASS		

Remark:
1. Emission Level = Meter Reading + Antenna Factor + Cable Loss – Pre-amplifier, Margin= Emission Level - Limit

6. CONDUCTED BAND EDGE AND SPURIOUS EMISSION

Test Requirement:	FCC Part15 C Section 15.247 (d), RSS-247 5.5
Test Method:	ANSI C63.10

6.1 Limit

In any 100 kHz bandwidth outside the frequency band in which the spread spectrum or digitally modulated intentional radiator is operating, the radio frequency power that is produced by the intentional radiator shall be at least 20 dB below that in the 100 kHz bandwidth within the band that contains the highest level of the desired power, based on either an RF con-ducted or a radiated measurement, pro-vided the transmitter demonstrates compliance with the peak conducted power limits. If the transmitter com-plies with the conducted power limits based on the use of RMS averaging over a time interval, as permitted under paragraph (b)(3) of this section, the attenuation required under this paragraph shall be 30 dB instead of 20 dB. Attenuation below the general limits specified in §15.209(a) is not required.

According to RSS-247§5.5 and RSS-Gen§8.9, In any 100 kHz bandwidth outside the frequency band in which the spread spectrum or digitally modulated intentional radiator is operating, the radio frequency power that is produced by the intentional radiator shall be at least 20 dB below that in the 100 kHz bandwidth within the band that contains the highest level of the desired power, based on either an RF conducted or a radiated measurement. Attenuation below the general limits specified in Section 15.209(a) or RSS-Gen is not required.

6.2 Test Setup



6.3 Test procedure

Using the following spectrum analyzer setting:

- A) Set the RBW = 100KHz.
- B) Set the VBW = 300KHz.
- C) Sweep time = auto couple.
- D) Detector function = peak.
- E) Trace mode = max hold.
- F) Allow trace to fully stabilize.

6.4 DEVIATION FROM STANDARD

No deviation.



6.5 Test Result

Band Edge

Mode	Frequency (MHz)	Hopping Mode	Max Value (dBc)	Limit (dBc)	Verdict
1-DH5	2402	No-Hopping	-44.88	-20	Pass
1-DH5	2480	No-Hopping	-53.21	-20	Pass
2-DH5	2402	No-Hopping	-45.94	-20	Pass
2-DH5	2480	No-Hopping	-51.19	-20	Pass
3-DH5	2402	No-Hopping	-50.28	-20	Pass
3-DH5	2480	No-Hopping	-52.4	-20	Pass

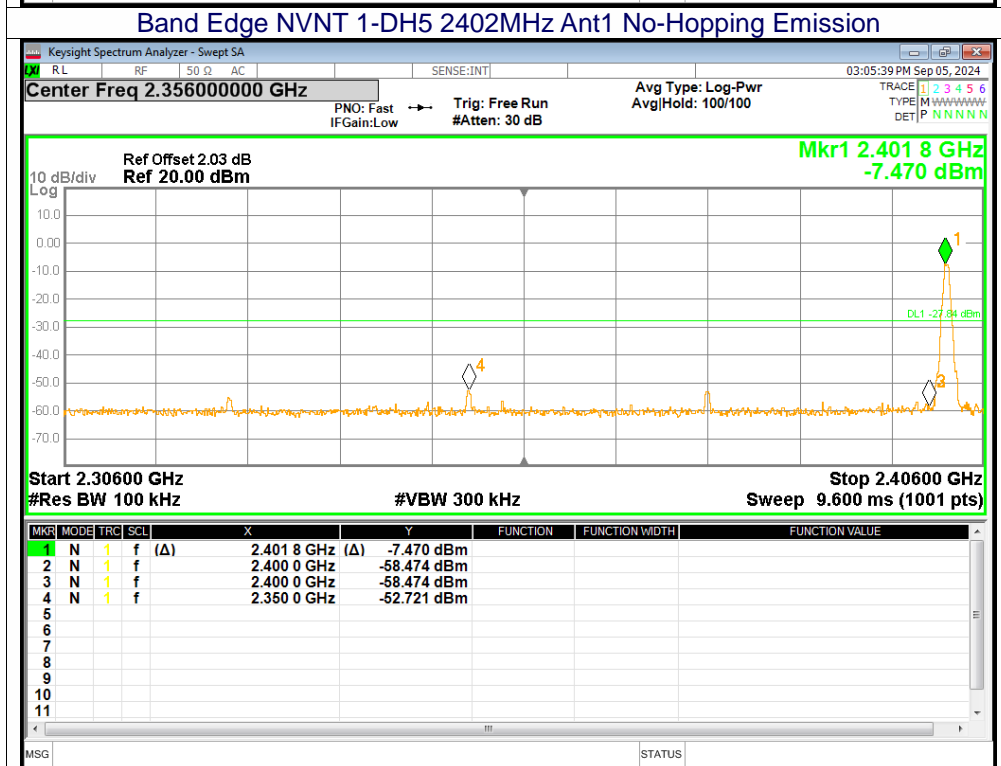
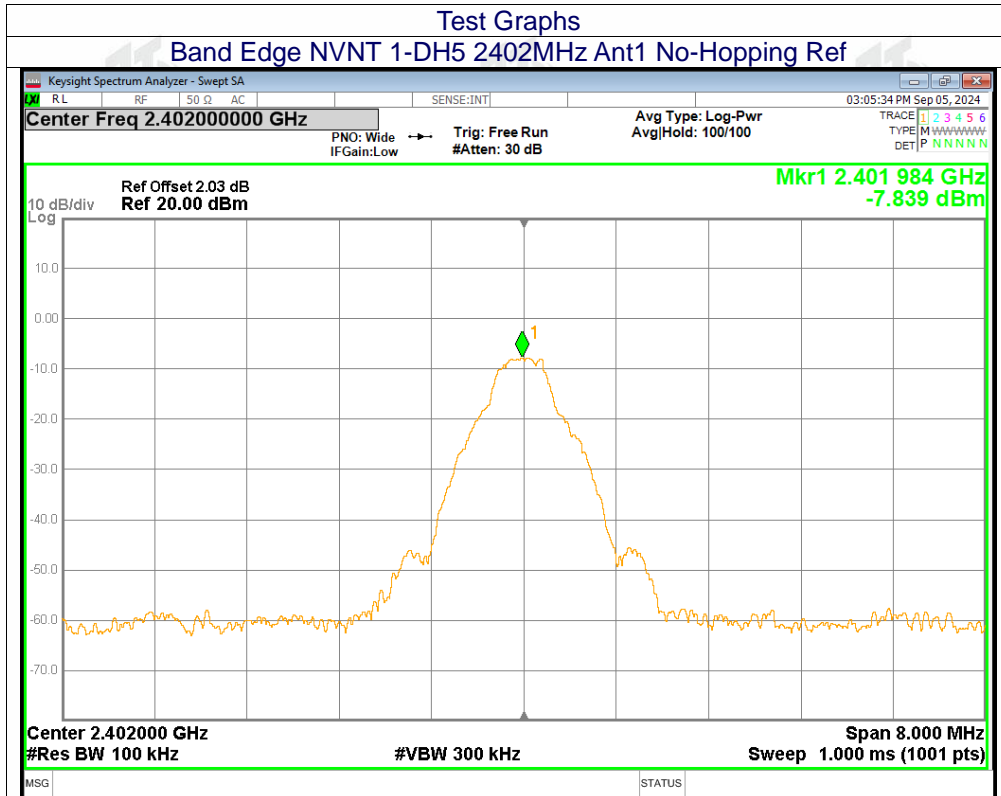

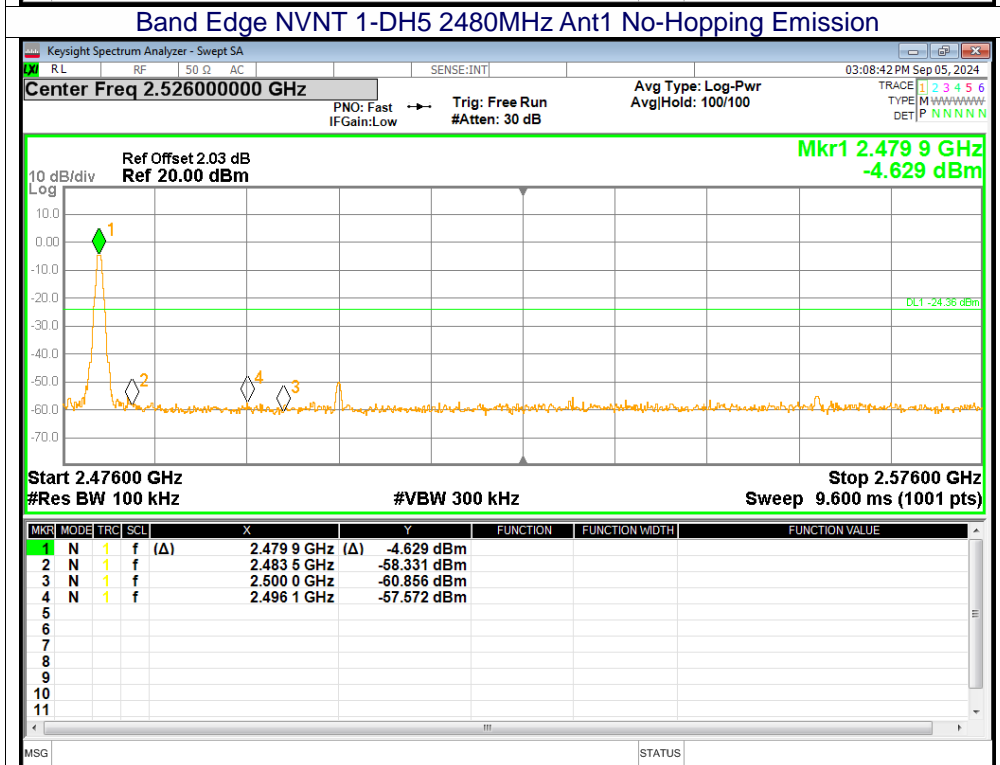
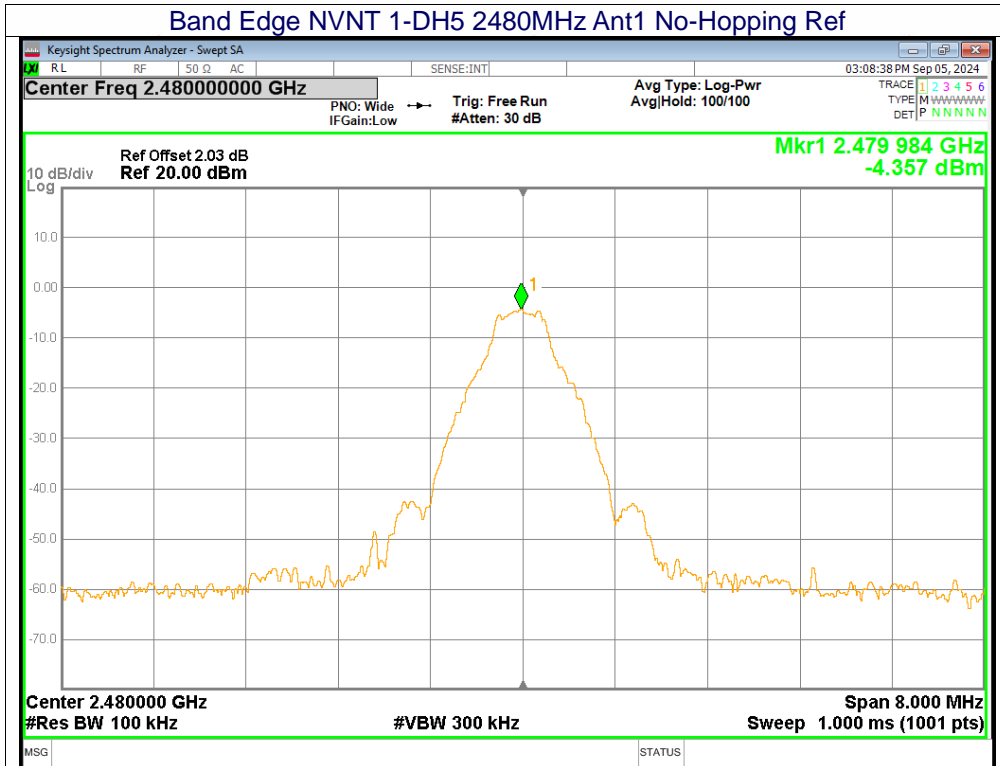

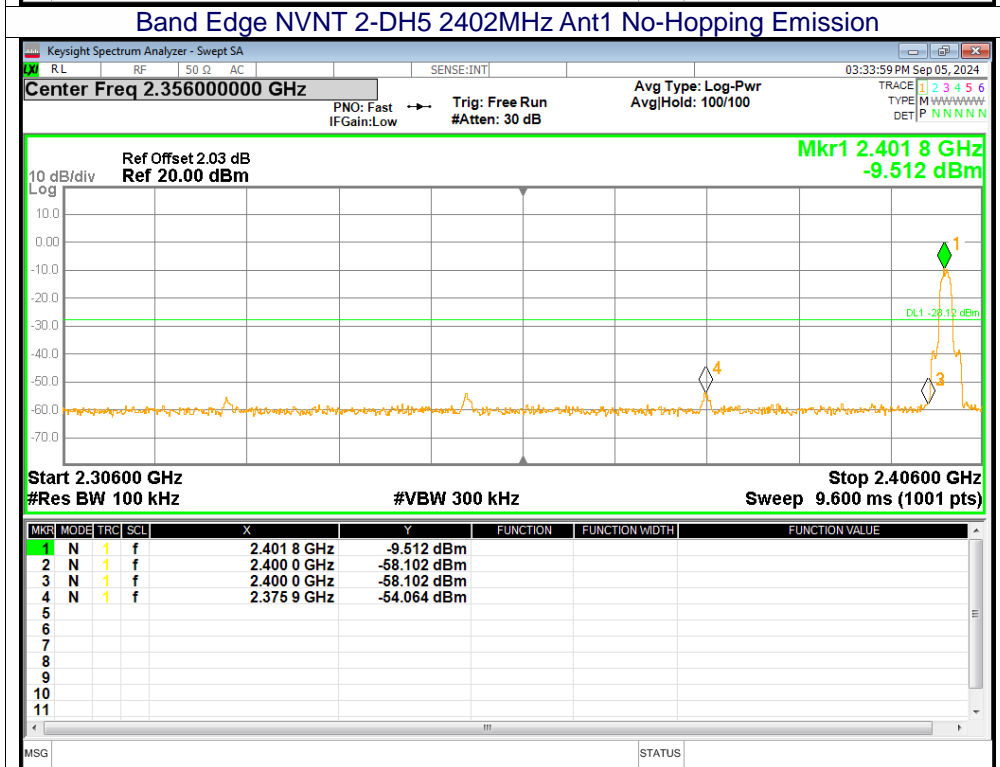
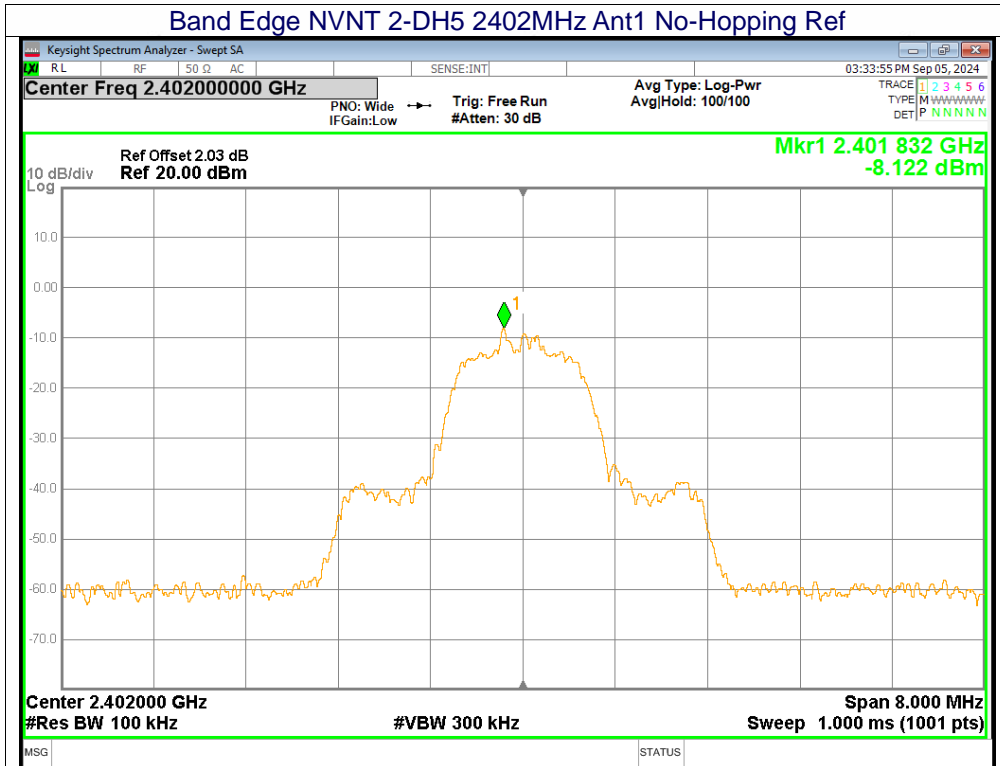

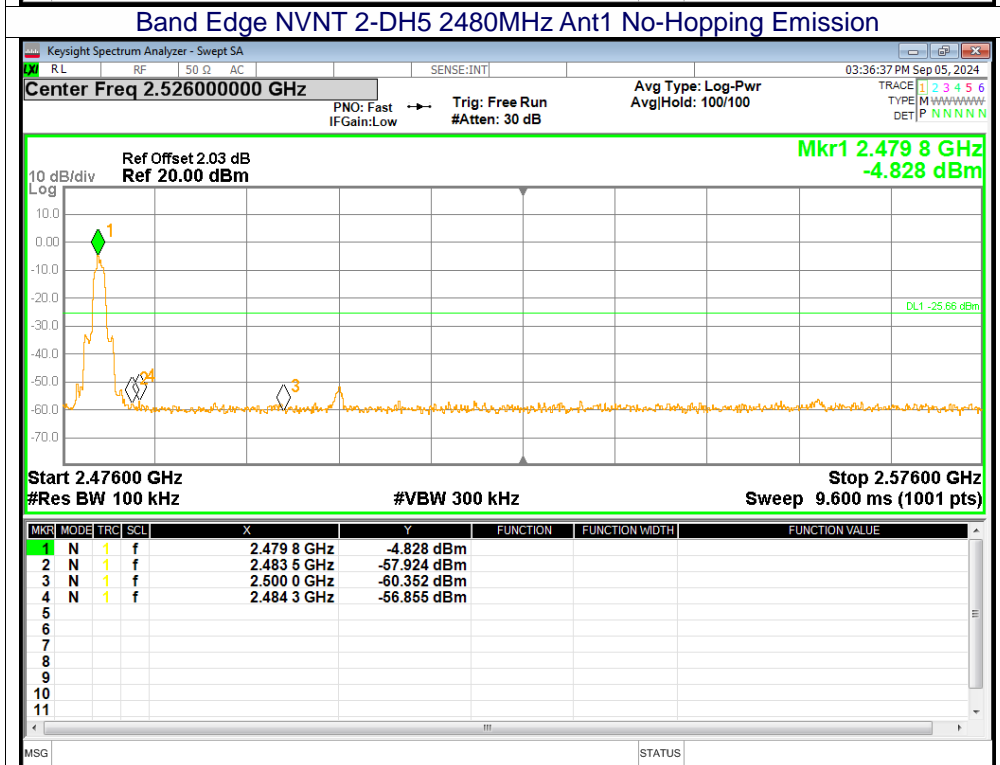
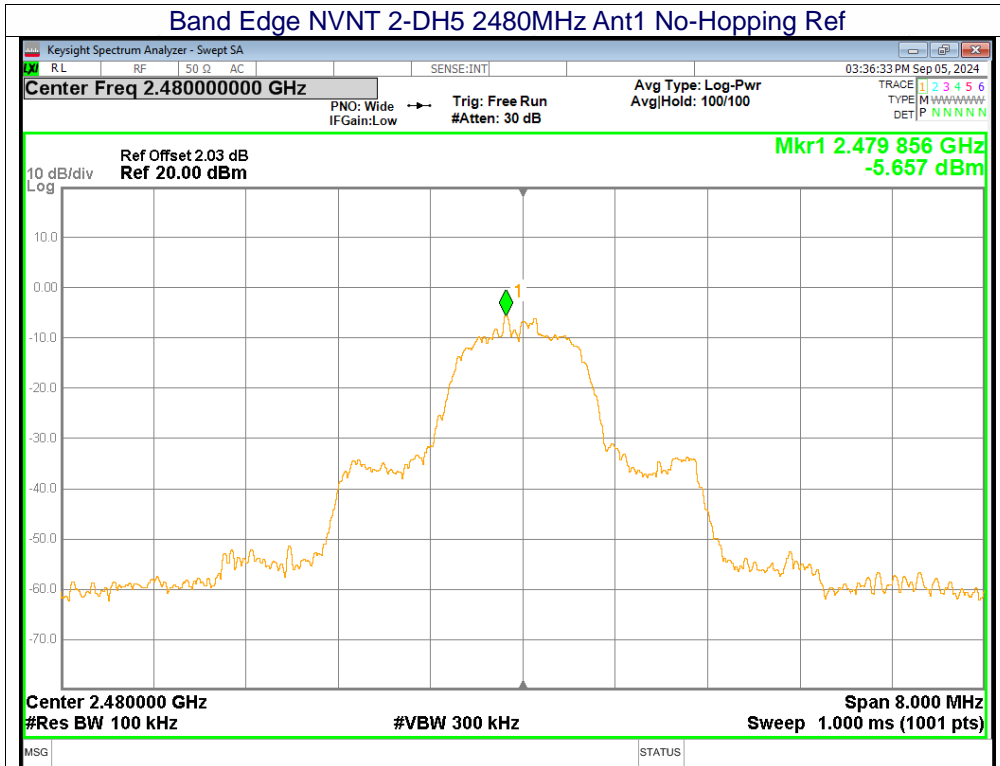

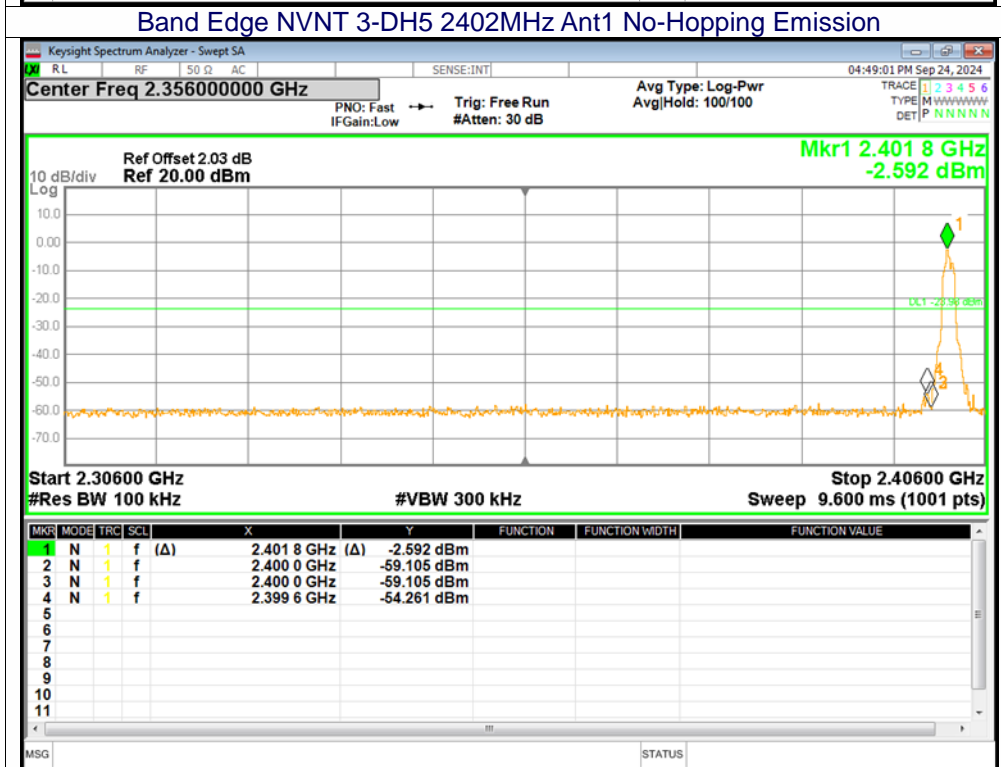
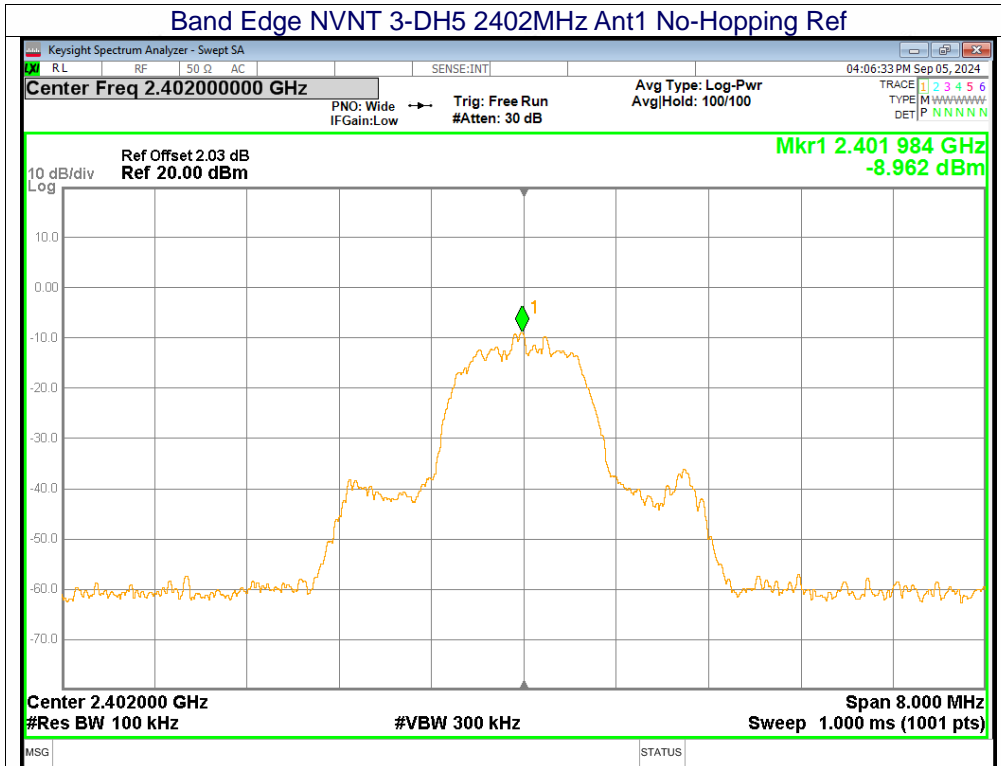

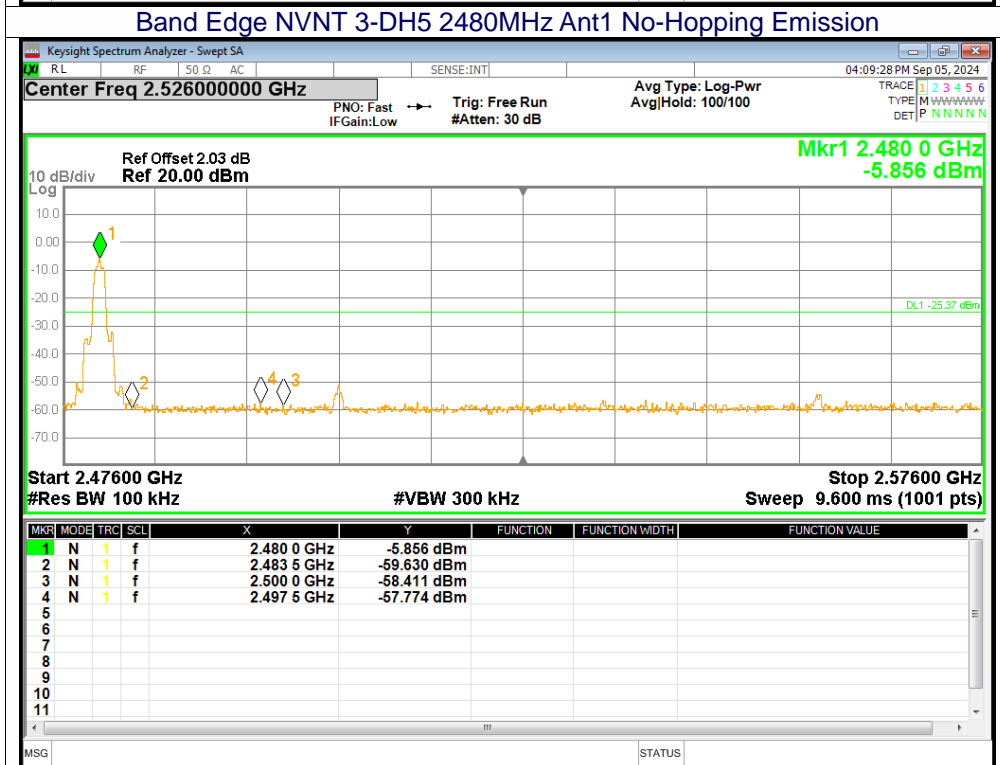
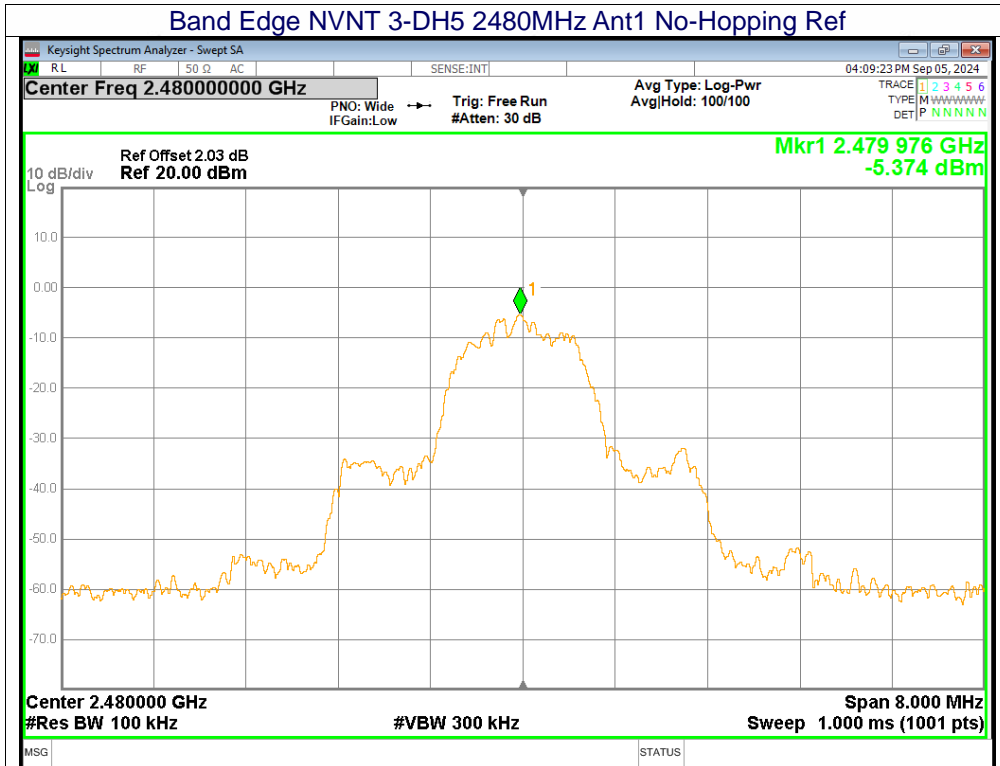



Band Edge(Hopping)

Mode	Frequency (MHz)	Hopping Mode	Max Value (dBc)	Limit (dBc)	Verdict
1-DH5	2402	Hopping	-43.14	-20	Pass
1-DH5	2480	Hopping	-45.29	-20	Pass
2-DH5	2402	Hopping	-44.77	-20	Pass
2-DH5	2480	Hopping	-45.57	-20	Pass
3-DH5	2402	Hopping	-44.38	-20	Pass
3-DH5	2480	Hopping	-44.37	-20	Pass

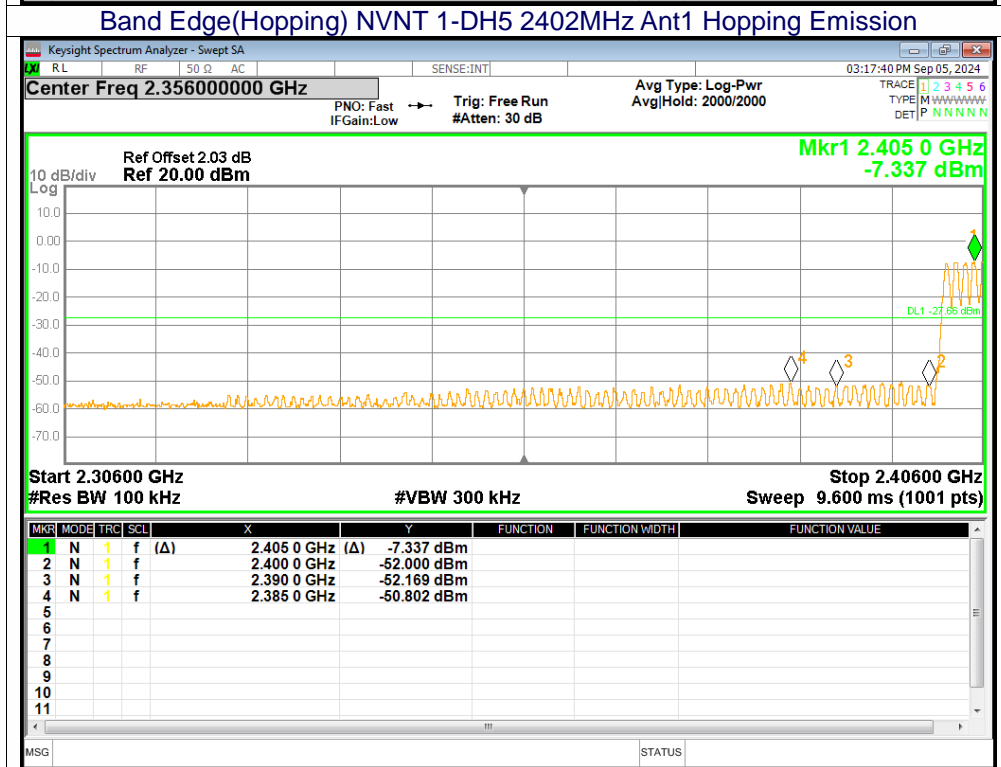
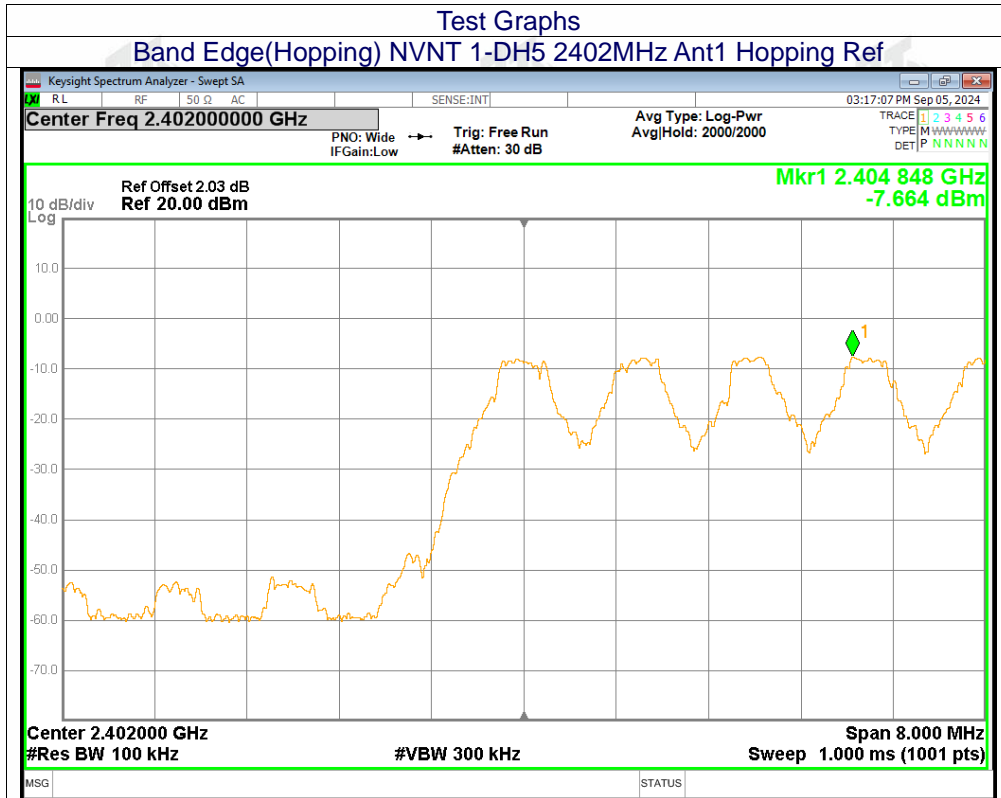

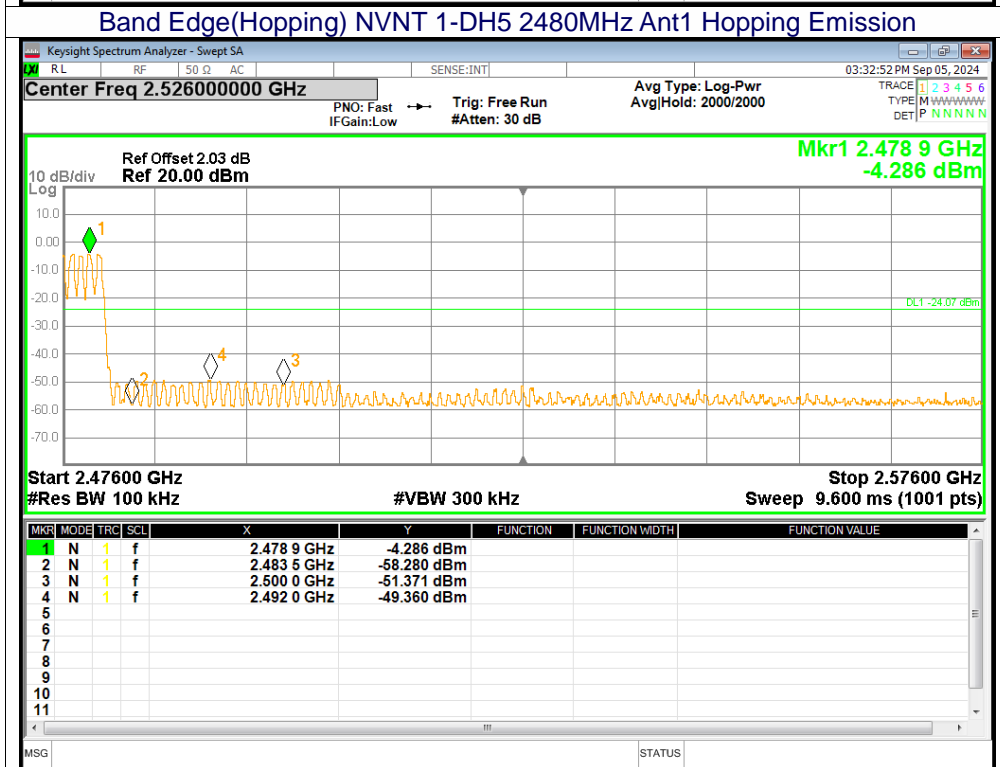
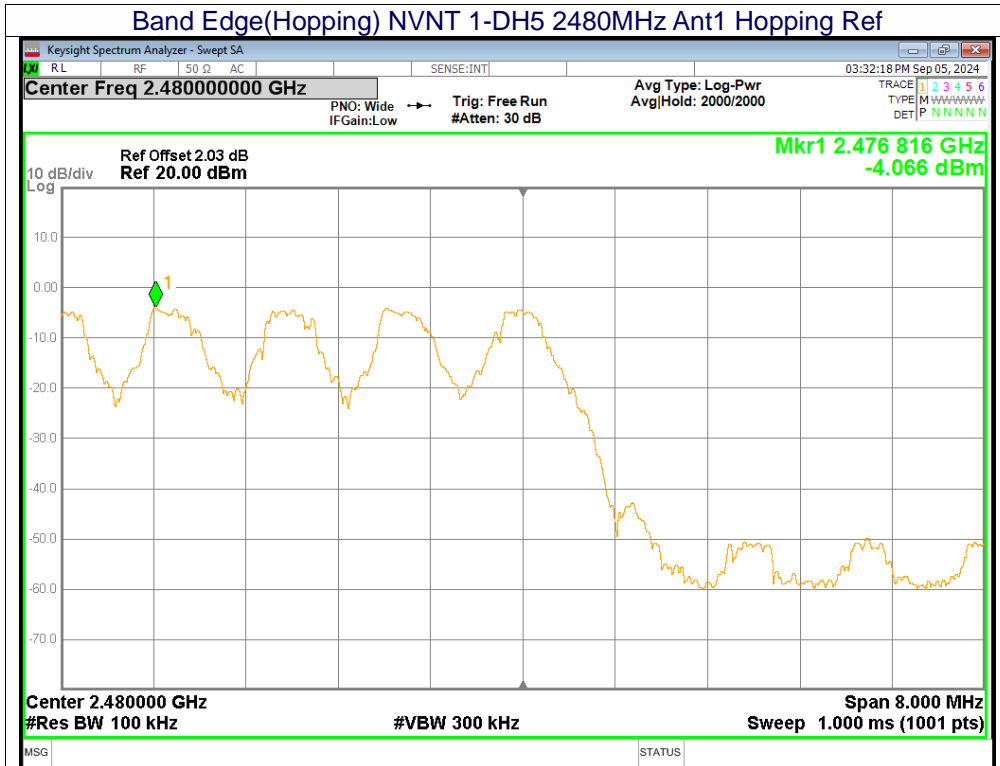

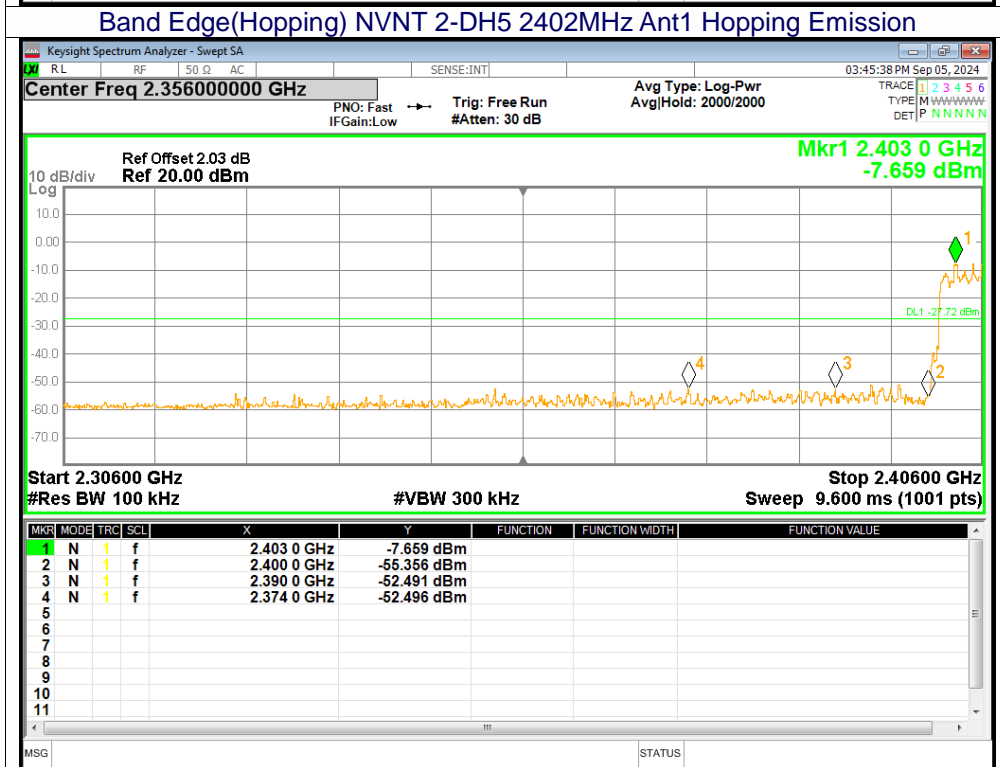
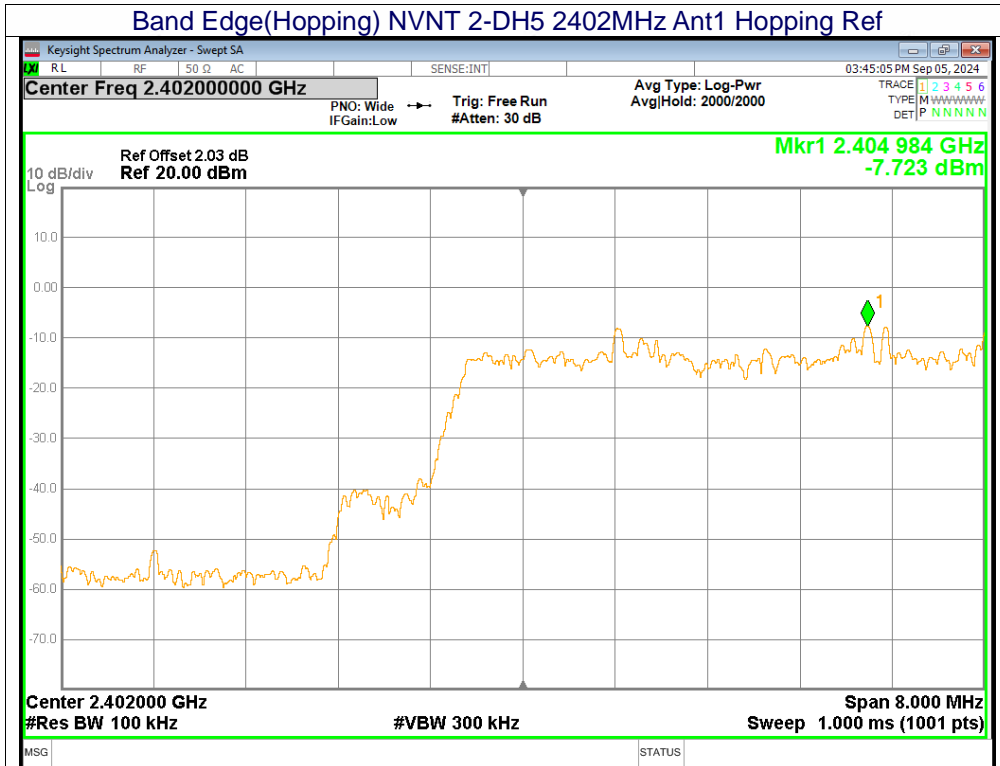

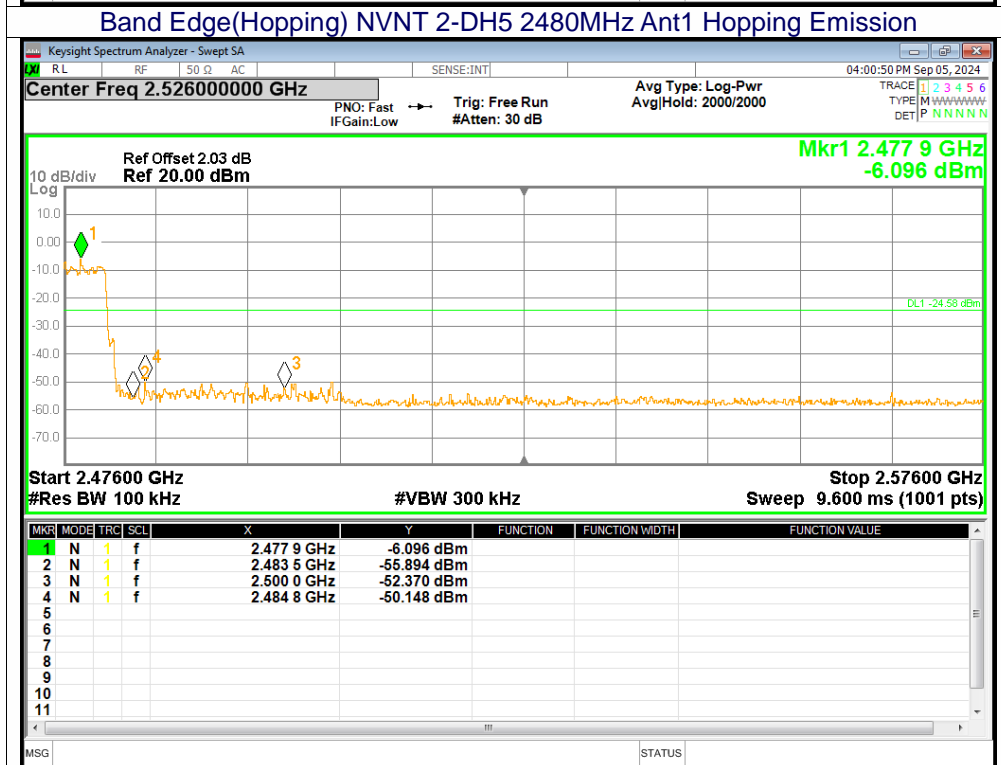
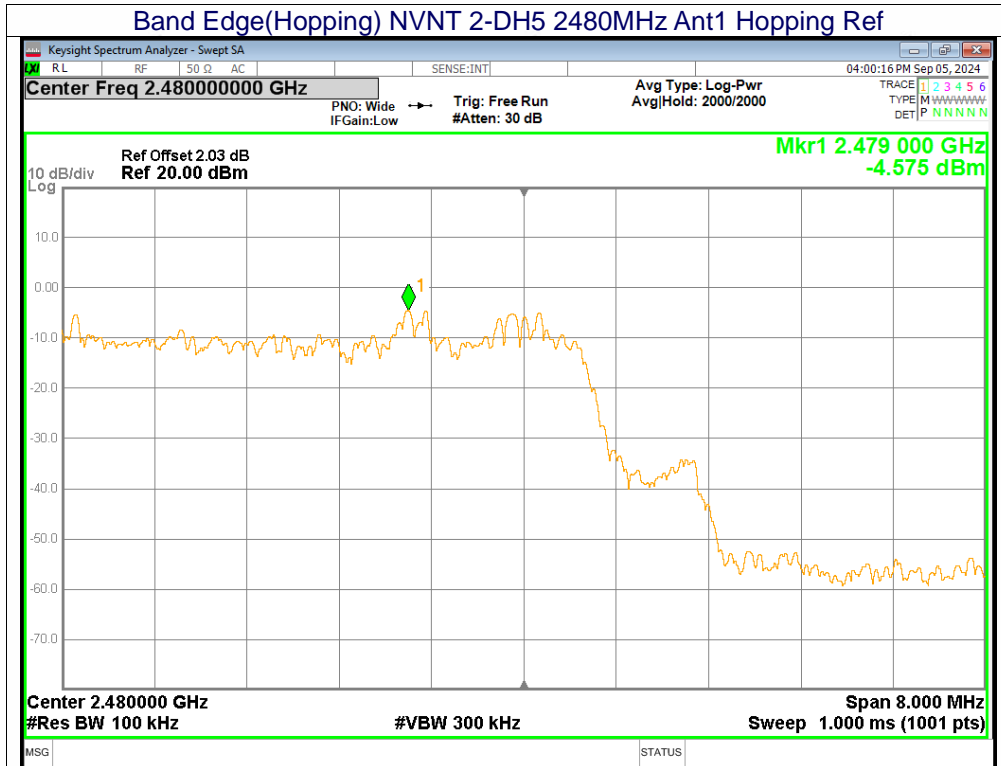

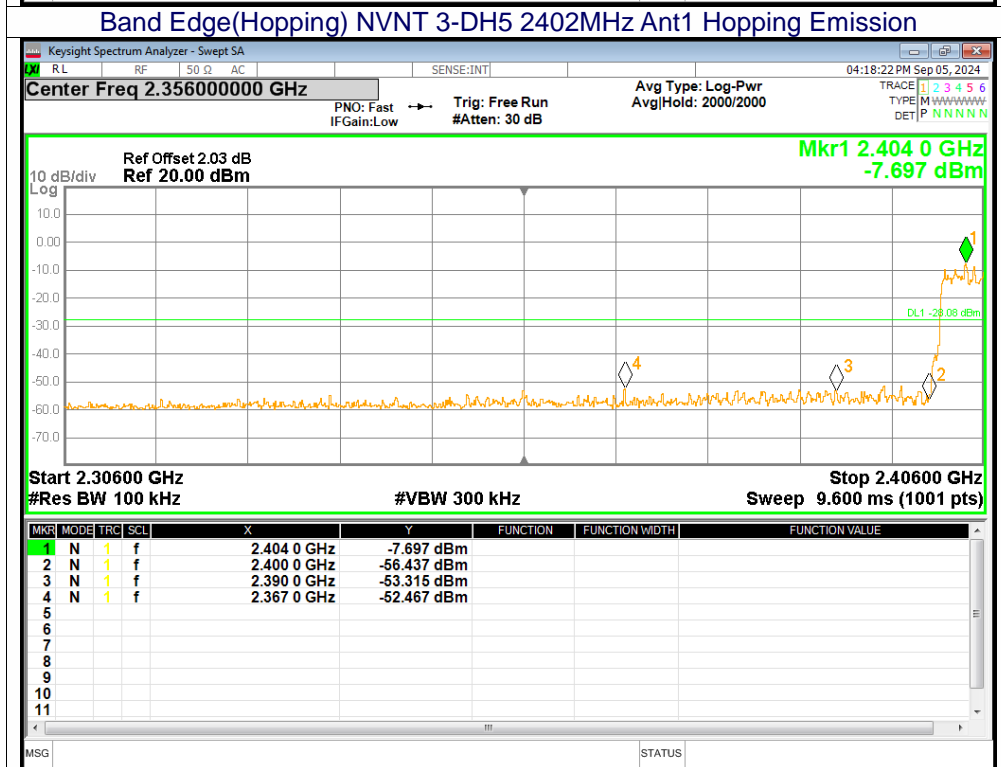
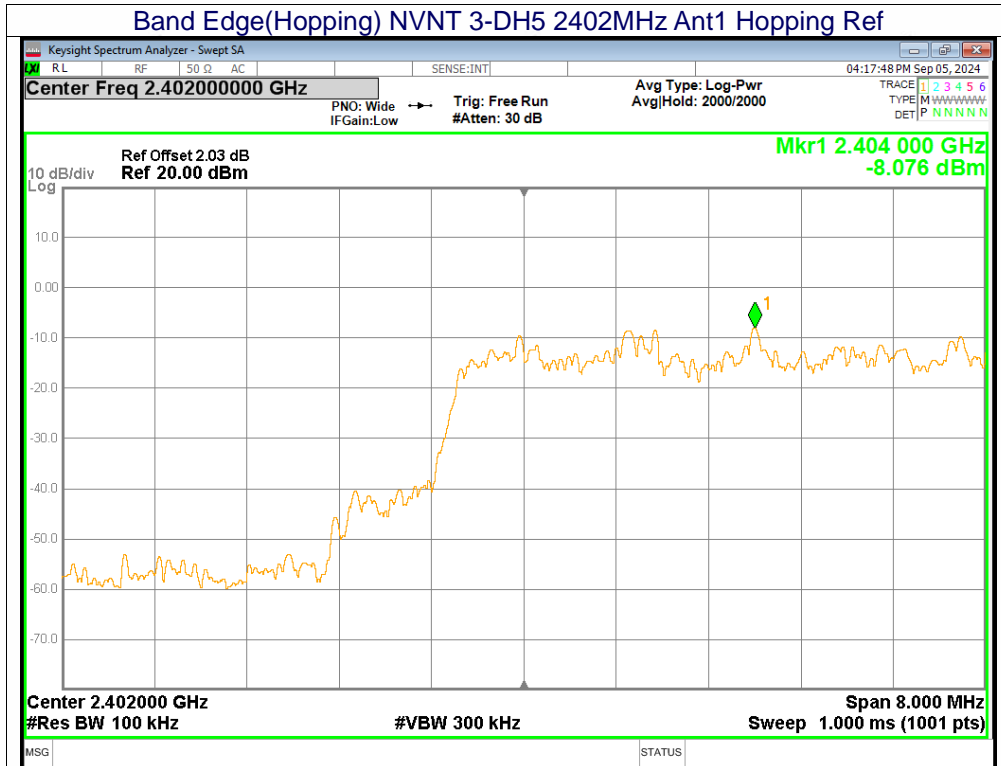

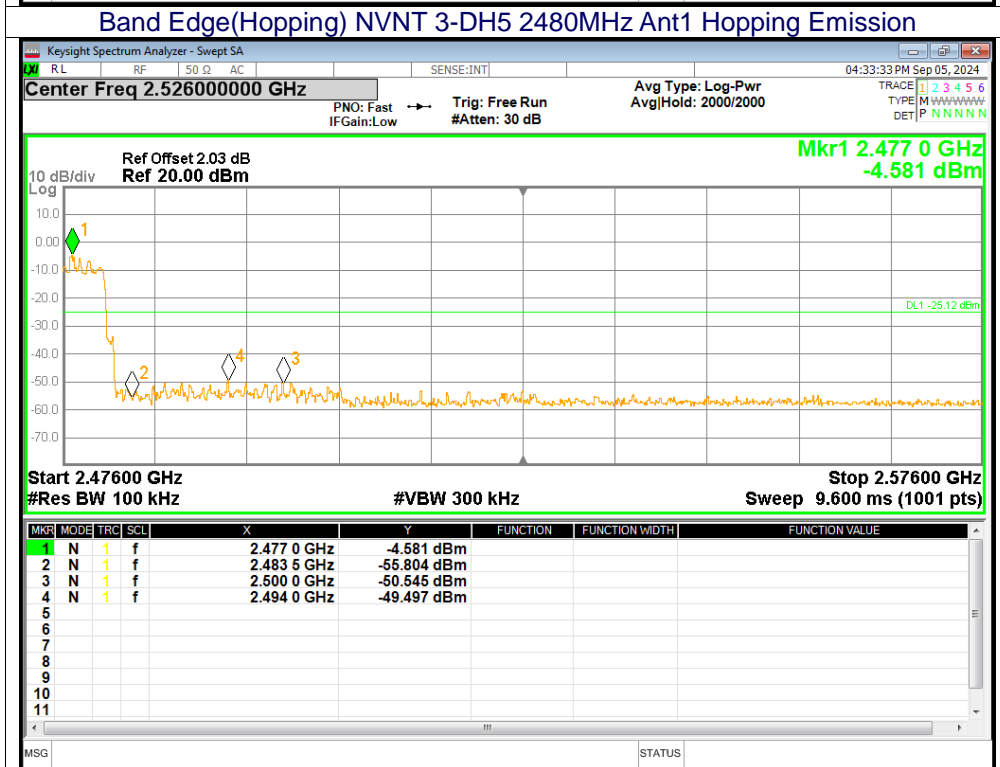
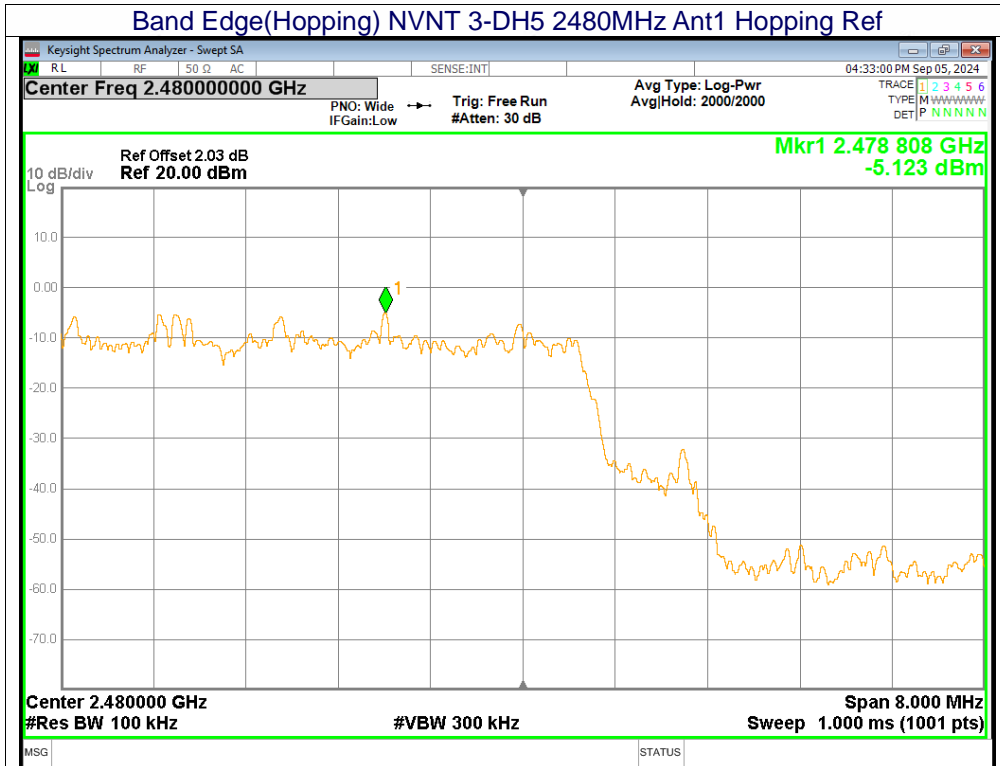



Conducted RF Spurious Emission

Mode	Frequency (MHz)	Max Value (dBc)	Limit (dBc)	Verdict
1-DH5	2402	-32.56	-20	Pass
1-DH5	2441	-33.1	-20	Pass
1-DH5	2480	-35.02	-20	Pass
2-DH5	2402	-38.17	-20	Pass
2-DH5	2441	-37.97	-20	Pass
2-DH5	2480	-37.23	-20	Pass
3-DH5	2402	-34.17	-20	Pass
3-DH5	2441	-37.05	-20	Pass
3-DH5	2480	-34.81	-20	Pass

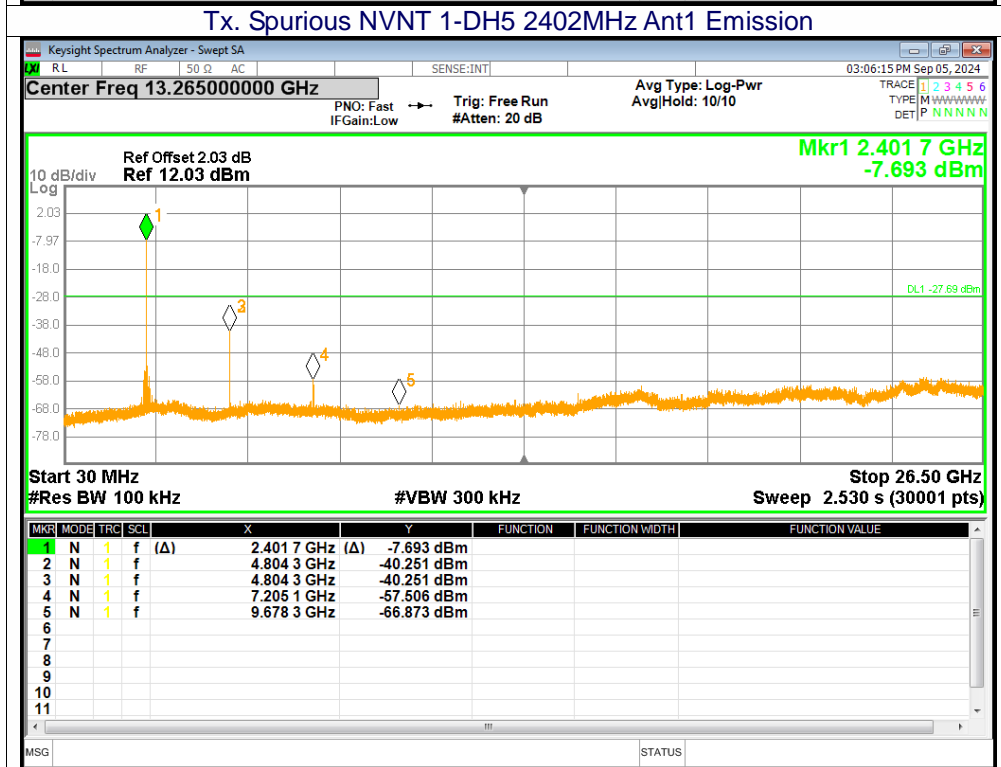
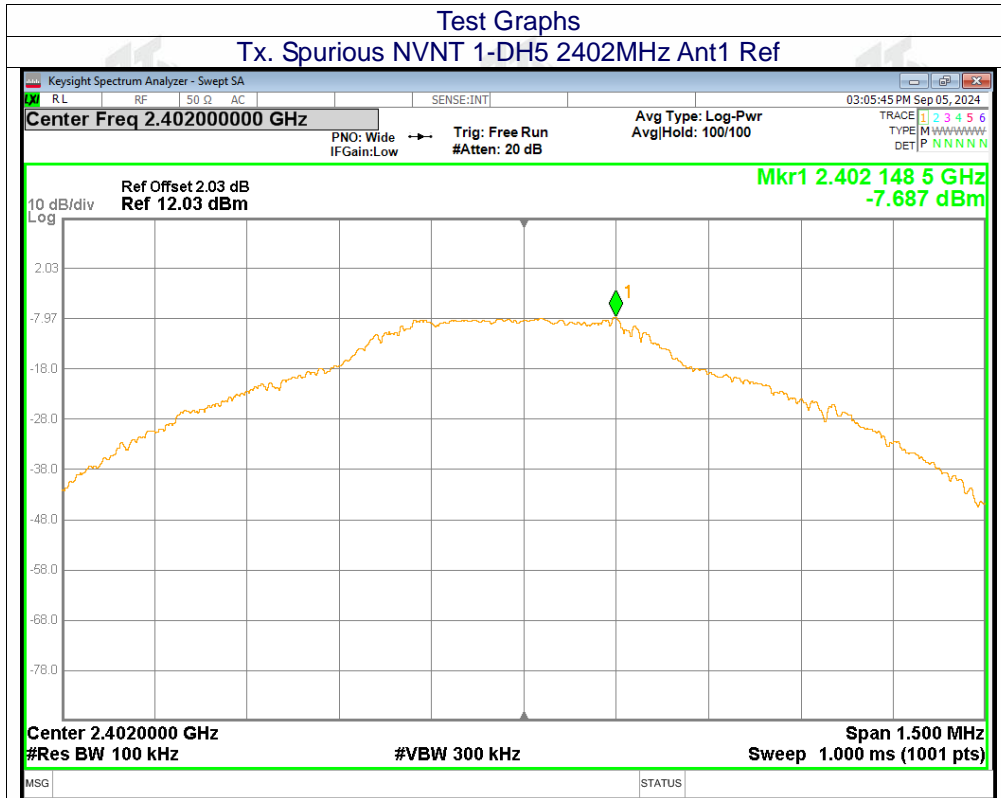

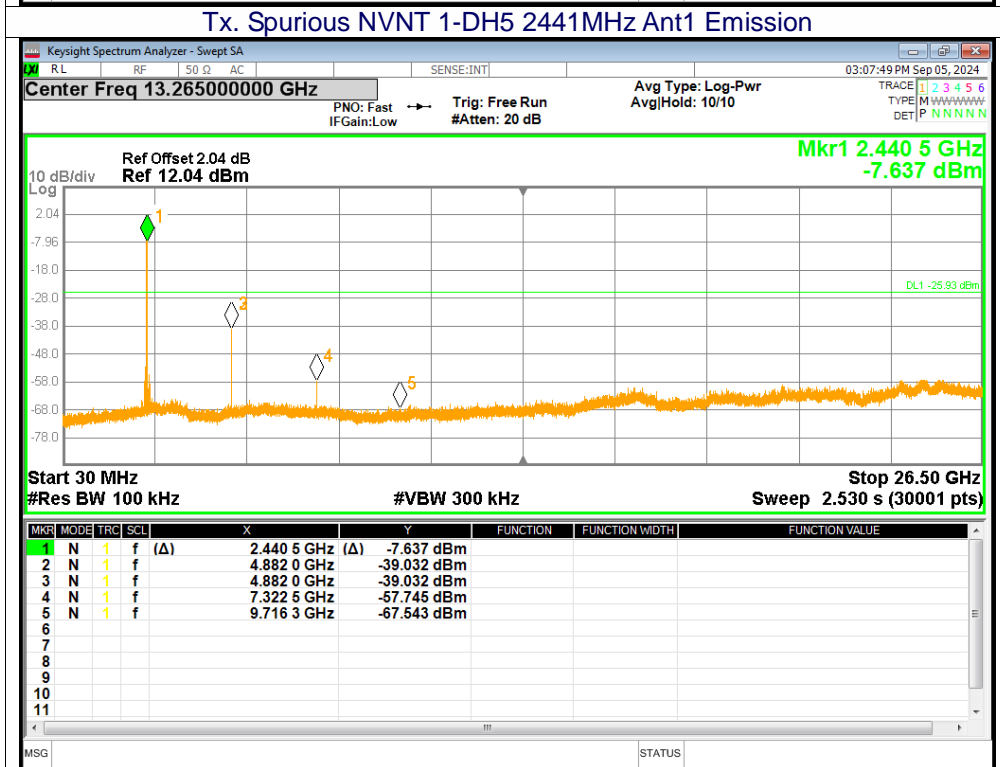
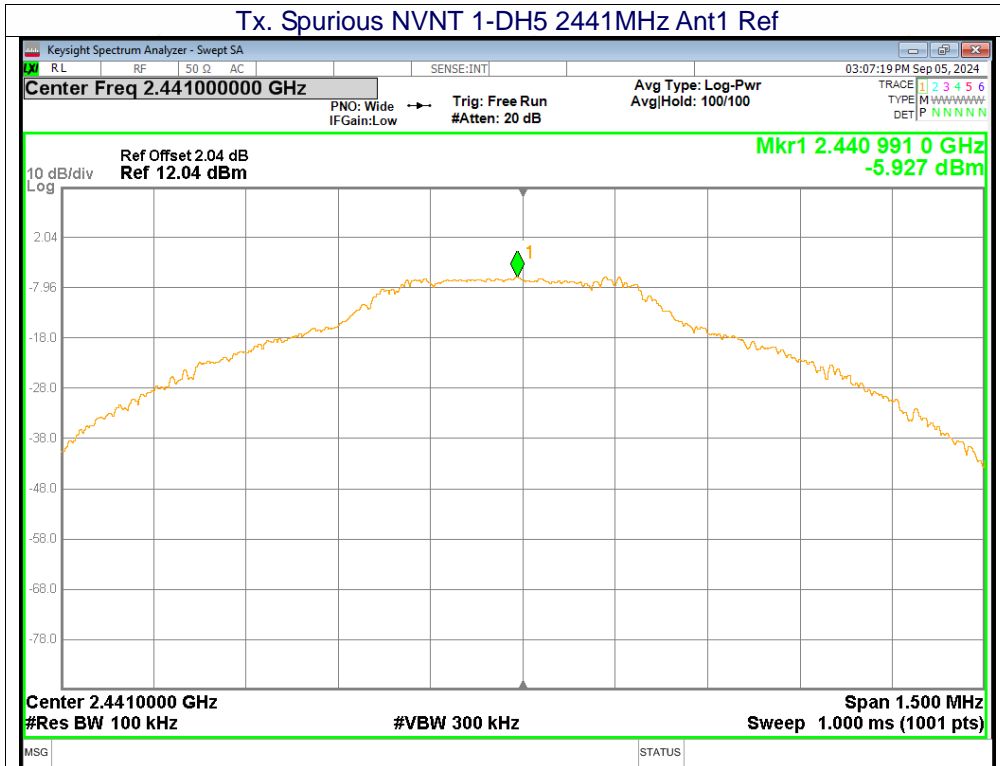

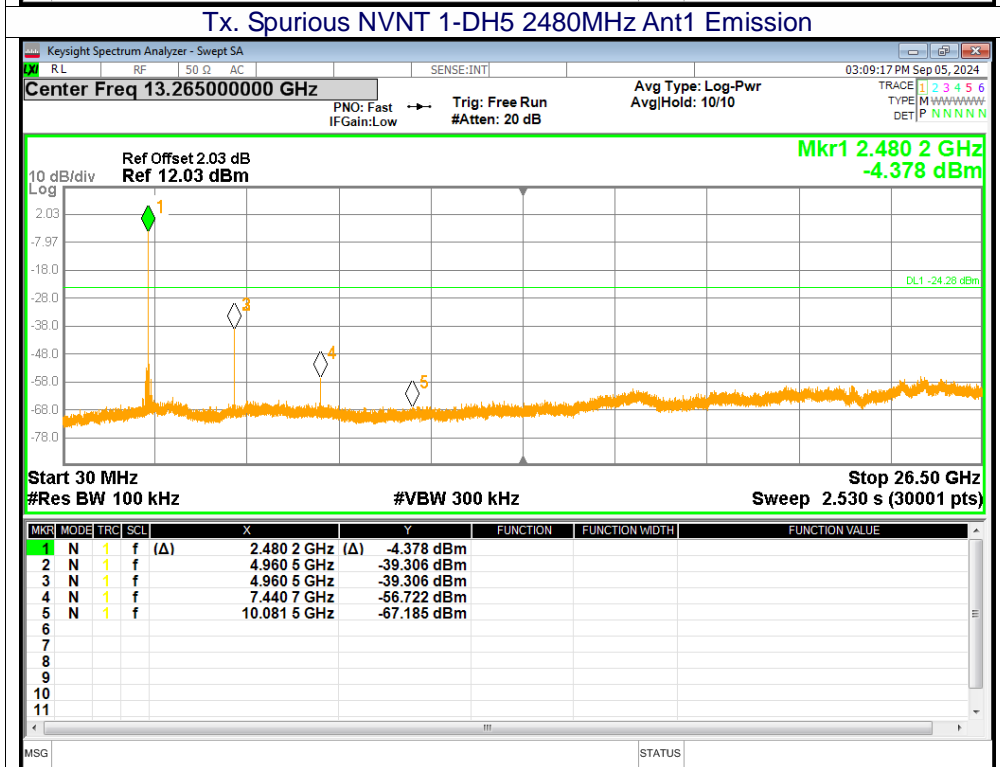
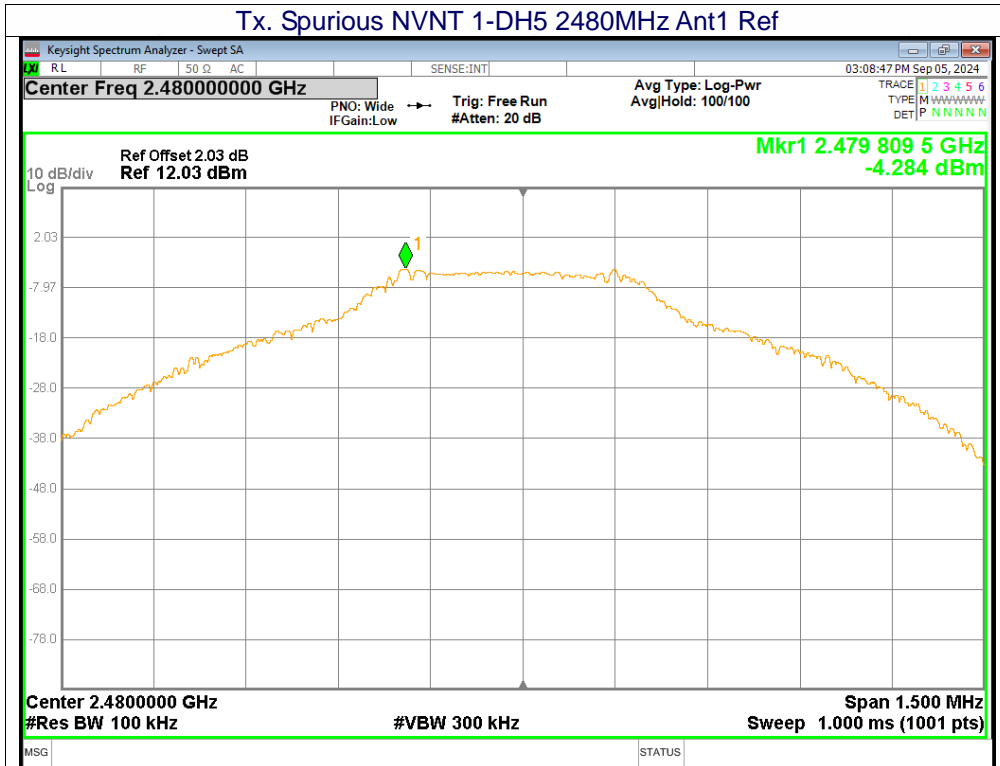

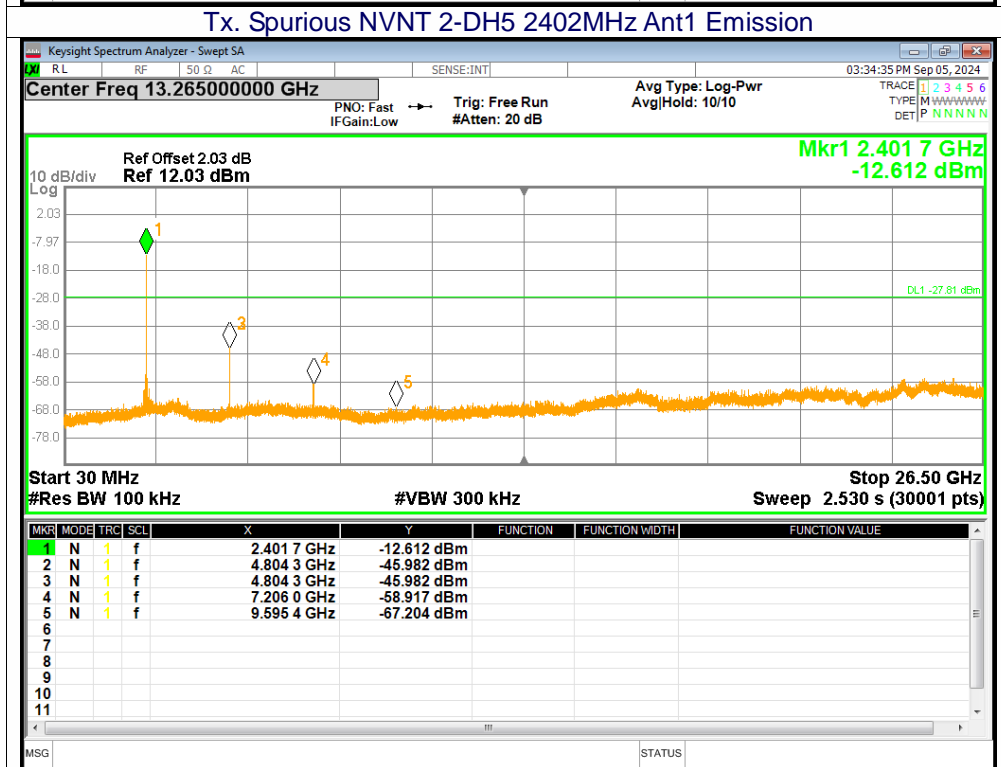
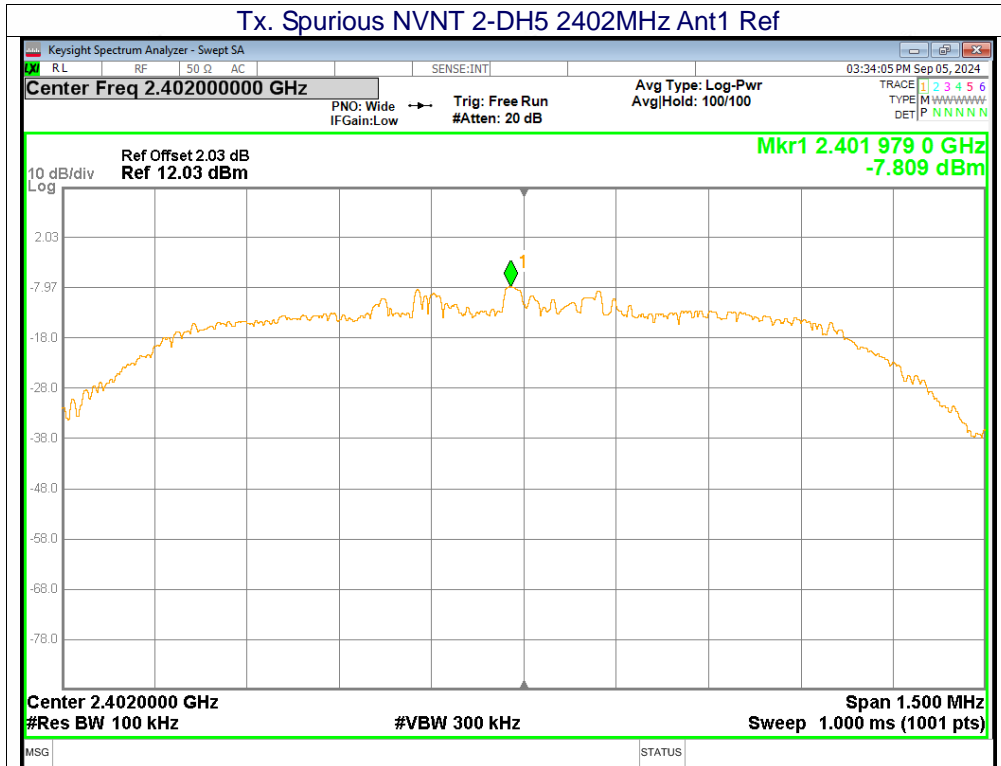

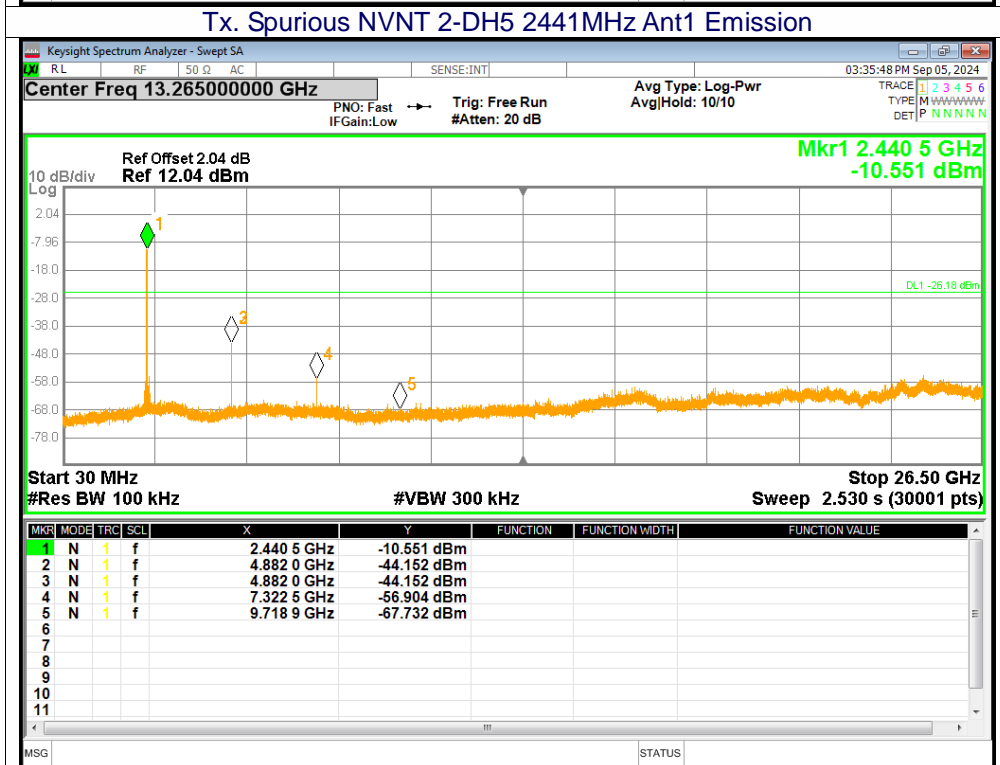
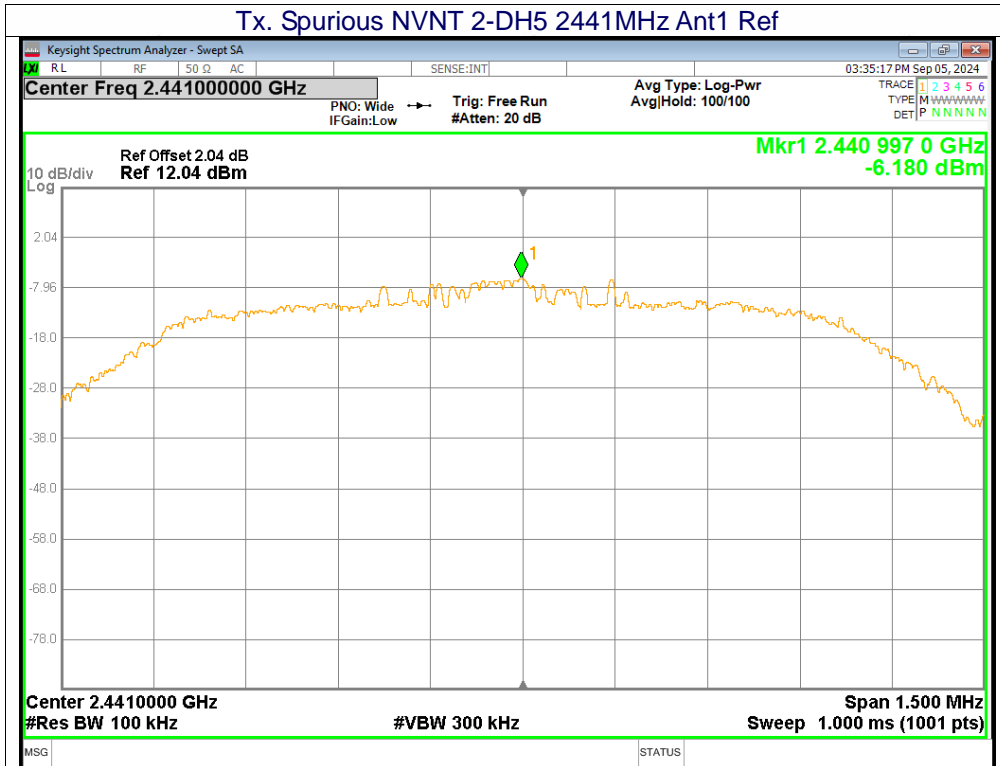

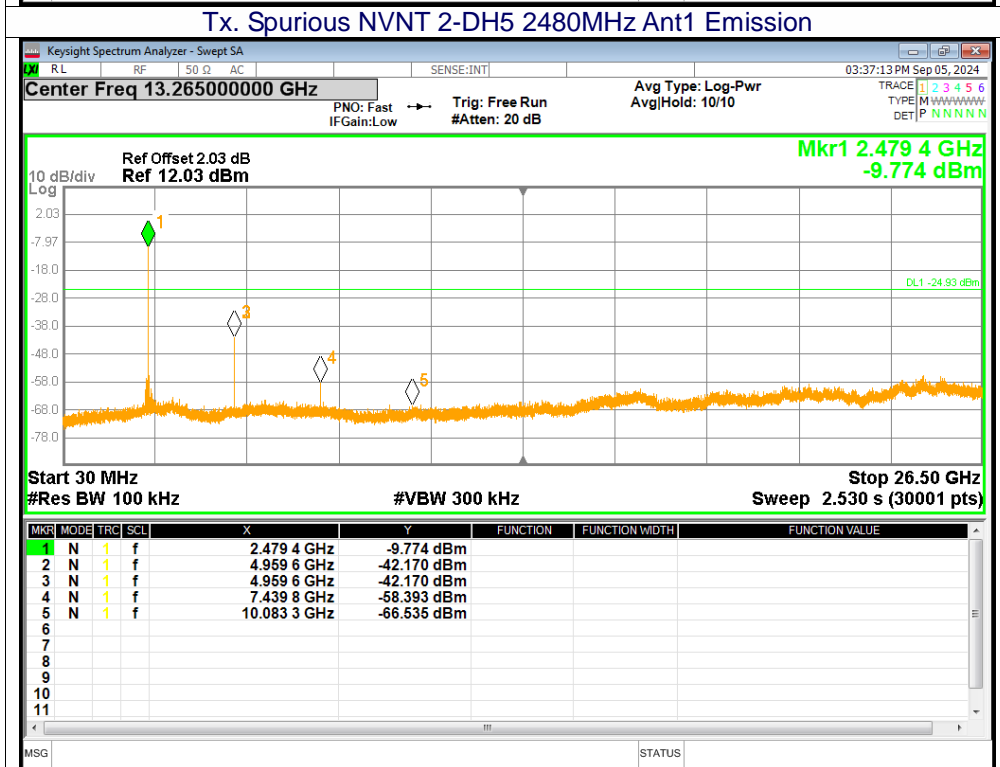
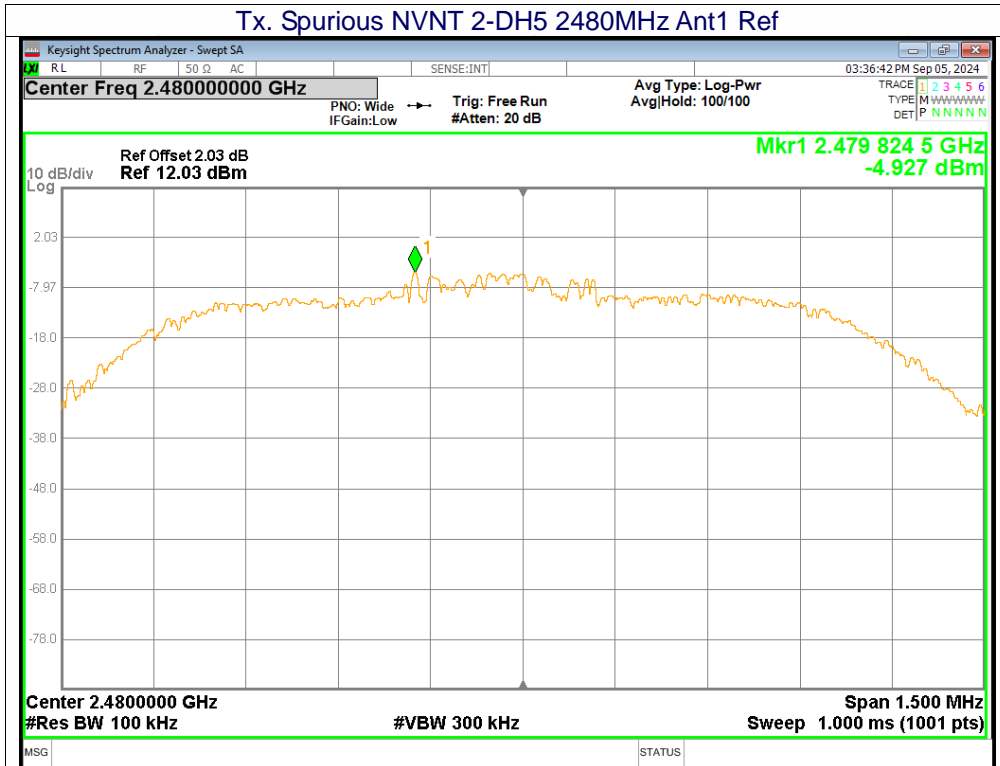

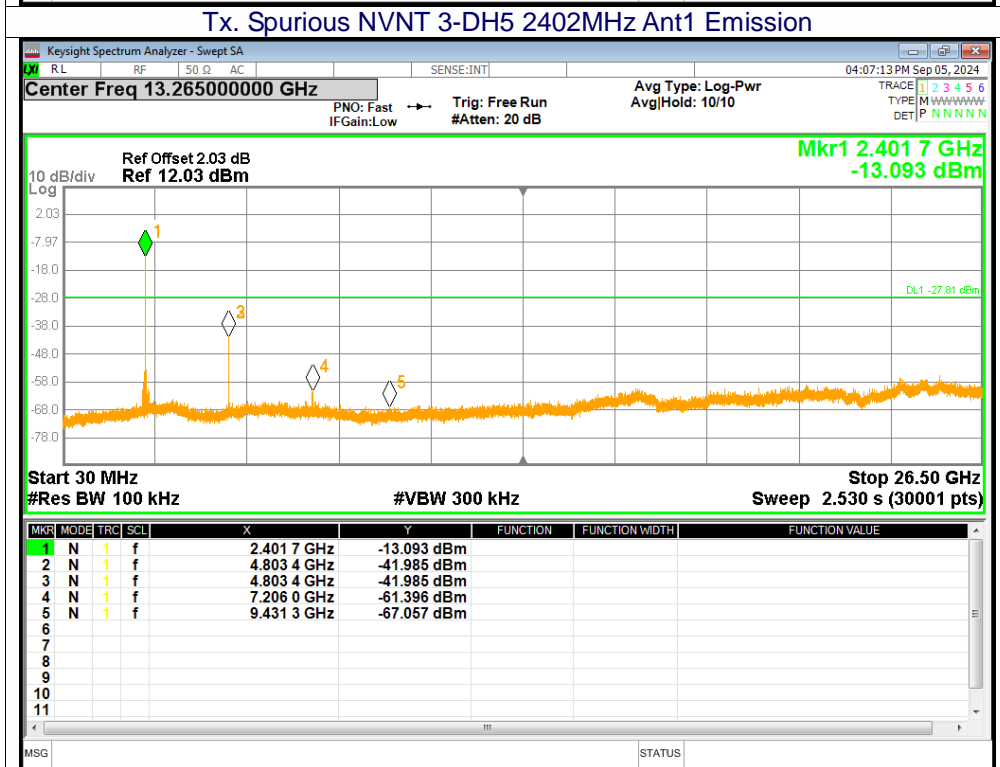
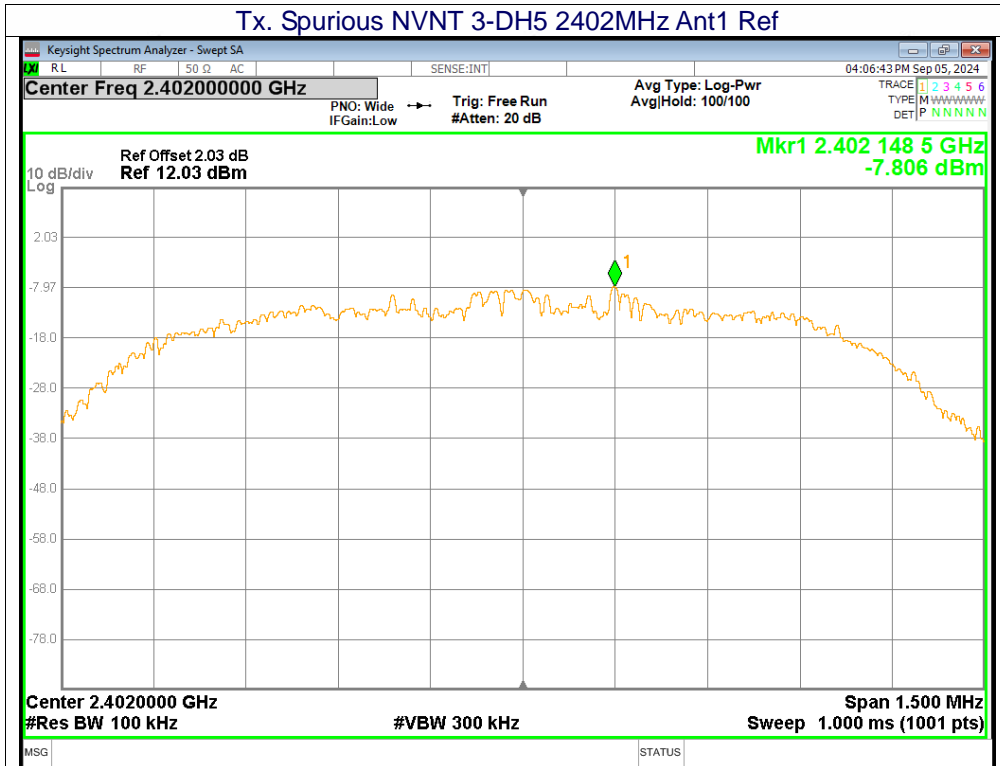

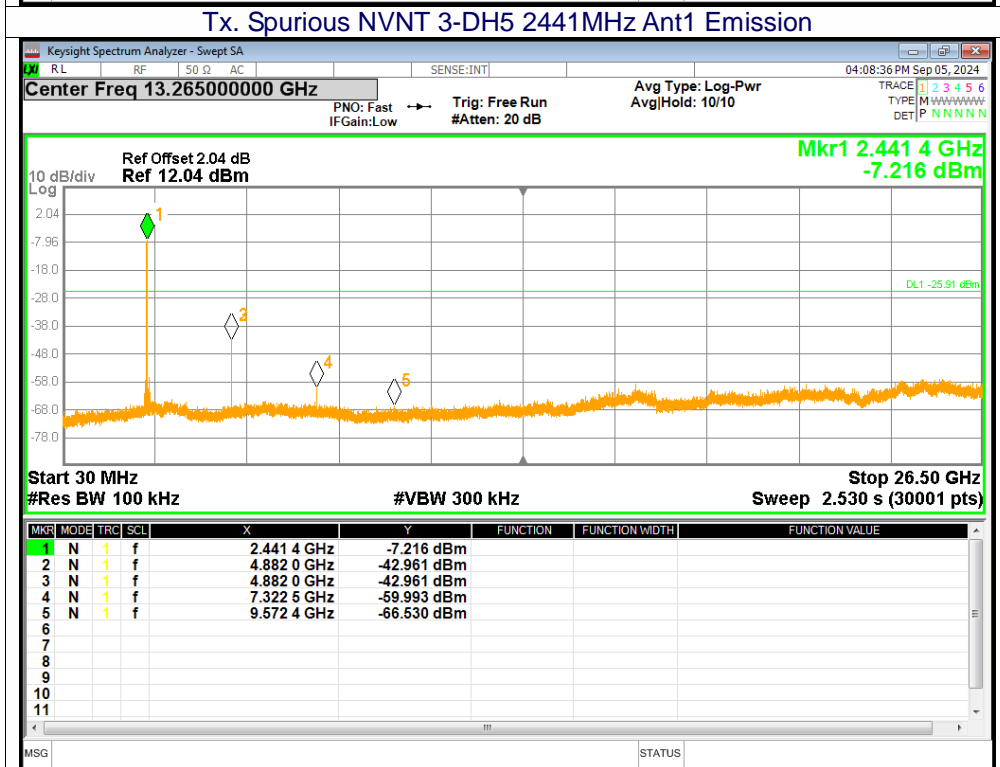
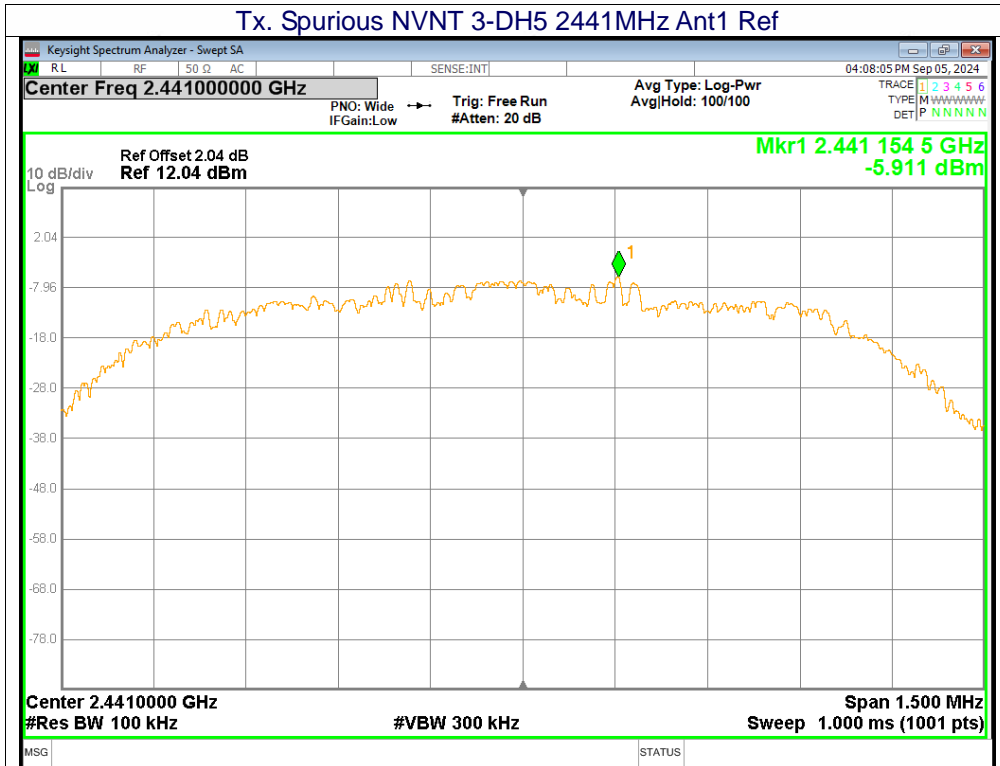

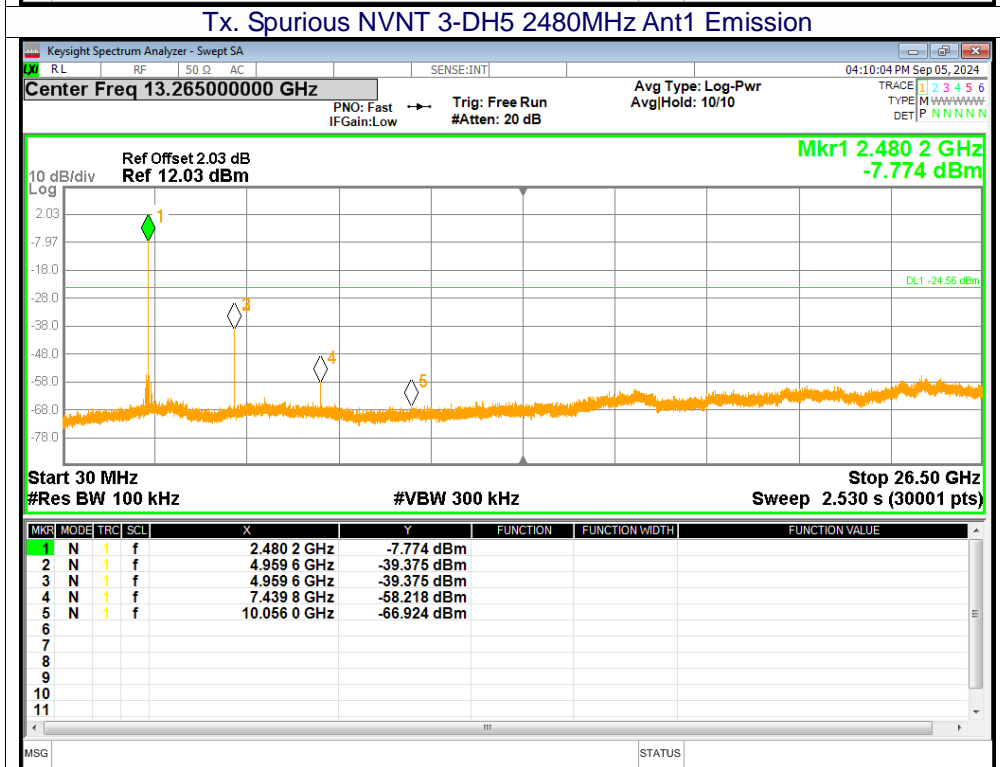
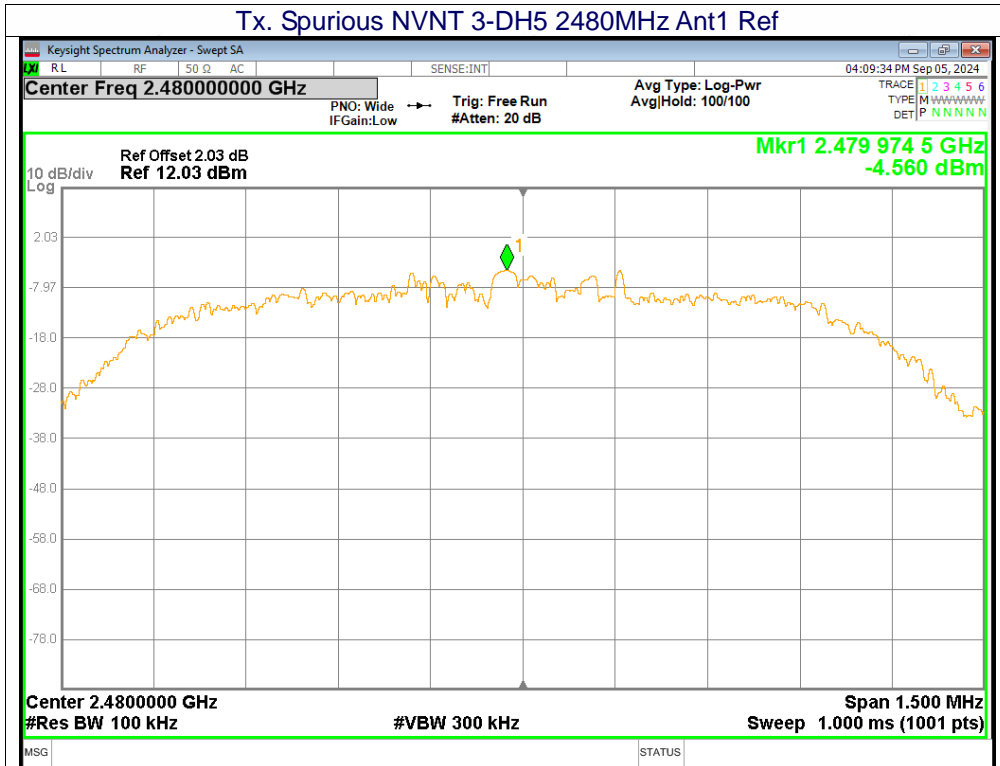



7. 20DB&99% BANDWIDTH

Test Requirement:	FCC Part15 C Section 15.247 (a)(1), RSS 247 5.1, RSS-Gen 6.7
Test Method:	ANSI C63.10:2013

7.1 Test Setup

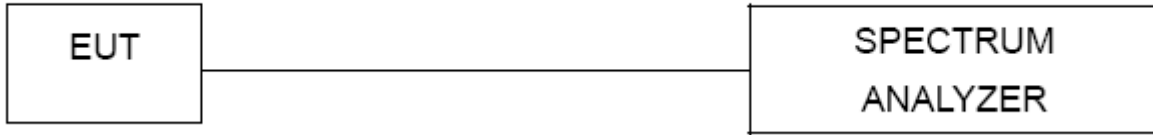

7.2 Limit

According to RSS-247§5.1(a)& §5.1(b), Frequency hopping systems shall have hopping channel carrier frequencies separated by a minimum of 25 kHz or the 20 dB bandwidth of the hopping channel, whichever is greater. Alternatively, frequency hopping systems operating in the 2400-2483.5 MHz band may have hopping channel carrier frequencies that are separated by 25 kHz or two-thirds of the 20 dB bandwidth of the hopping channel, whichever is greater, provided the systems operate with an output power no greater than 125 mW. The system shall hop to channel frequencies that are selected at the system hopping rate from a pseudo randomly ordered list of hopping frequencies. Each frequency must be used equally on the average by each transmitter. The system receivers shall have input bandwidths that match the hopping channel bandwidths of their corresponding transmitters and shall shift frequencies in synchronization with the transmitted signals.

7.3 Test procedure

1. Set RBW = 30 kHz.
2. Set the video bandwidth (VBW) ≥ 3 x RBW.
3. Detector = Peak.
4. Trace mode = max hold.
5. Sweep = auto couple.
6. Allow the trace to stabilize.
7. Measure the maximum width of the emission that is constrained by the frequencies associated with the two outermost amplitude points (upper and lower frequencies) that are attenuated by 6 dB relative to the maximum level measured in the fundamental emission.
8. The transmitter output was connected to the spectrum analyzer through an attenuator. The bandwidth of the fundamental frequency was measured by spectrum analyzer with 30KHz RBW and 100 KHz VBW record the 99% bandwidth.

7.4 DEVIATION FROM STANDARD

No deviation.

7.5 Test Result

Mode	Test channel	20dB Emission Bandwidth (MHz)	99%Bandwidth (MHz)	Result
GFSK	Lowest	0.95	0.868	Pass
	Middle	0.953	0.859	
	Highest	0.955	0.872	
π/4DQPSK	Lowest	1.261	1.206	Pass
	Middle	1.275	1.214	
	Highest	1.265	1.208	
8DPSK	Lowest	1.301	1.175	Pass
	Middle	1.288	1.184	
	Highest	1.279	1.212	

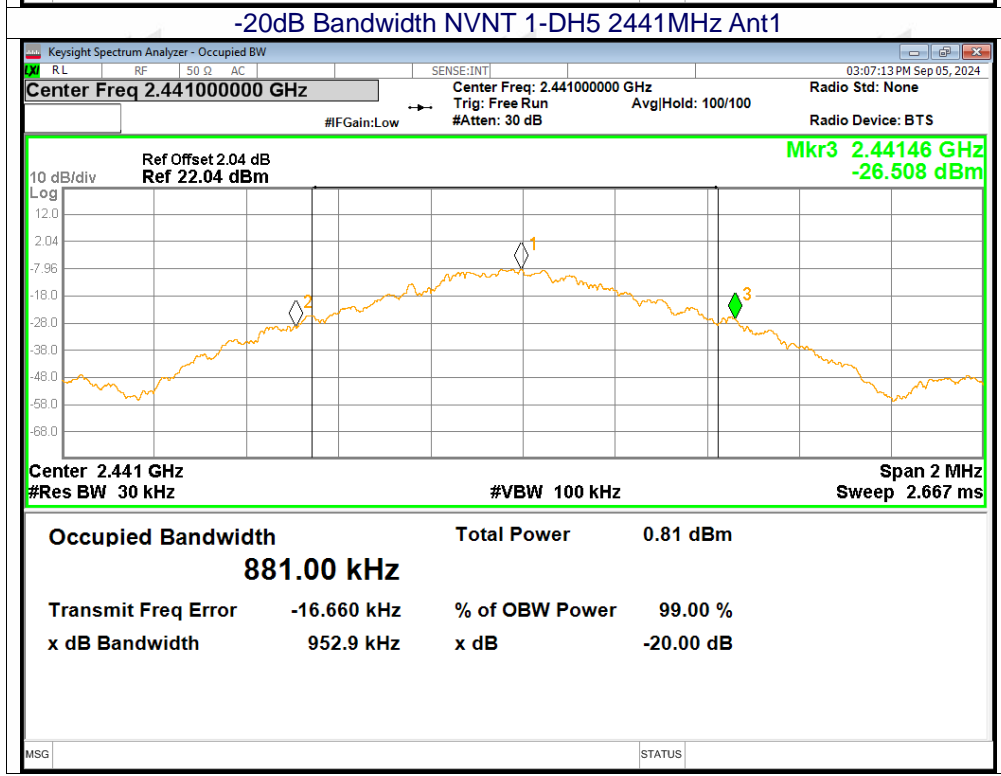
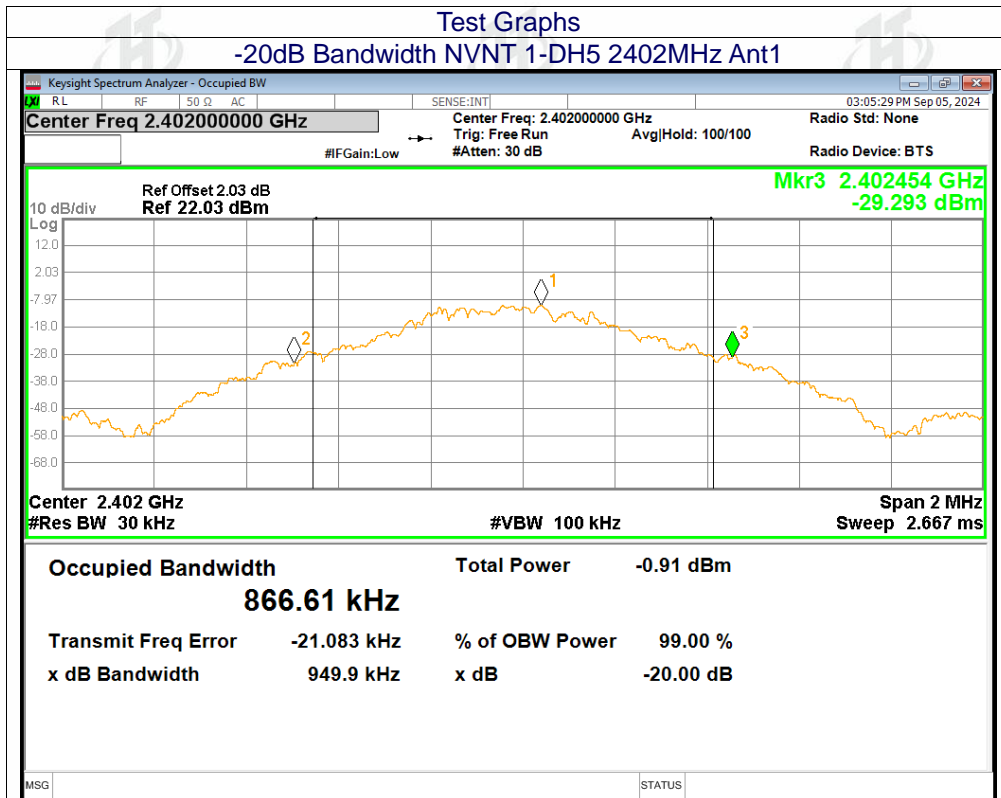

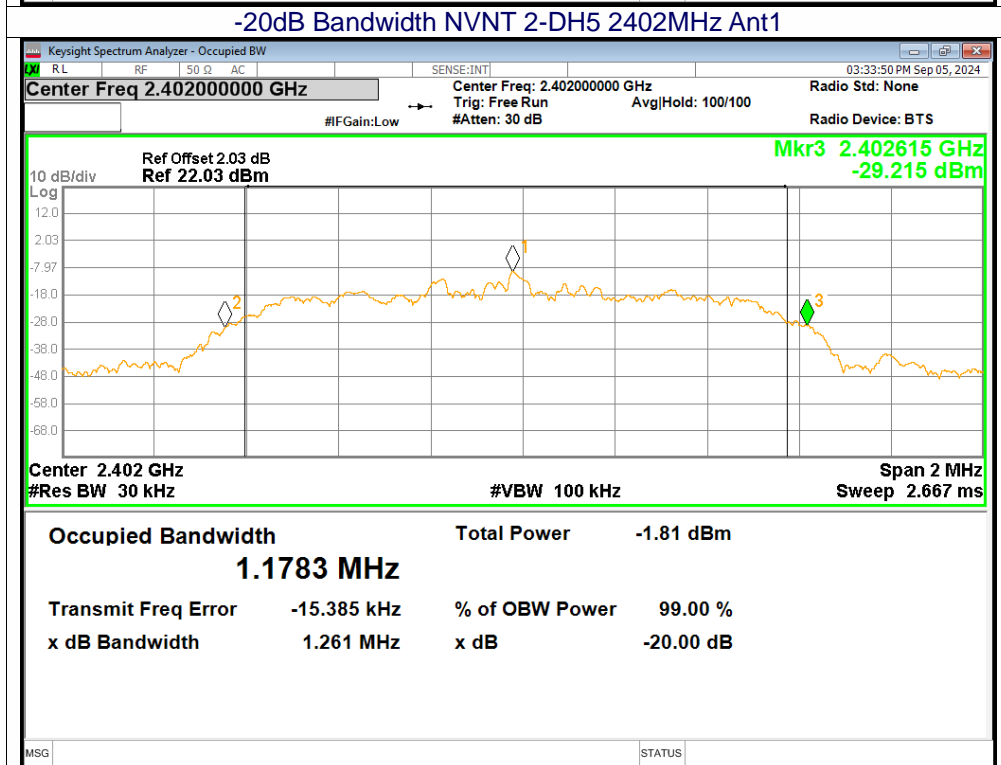
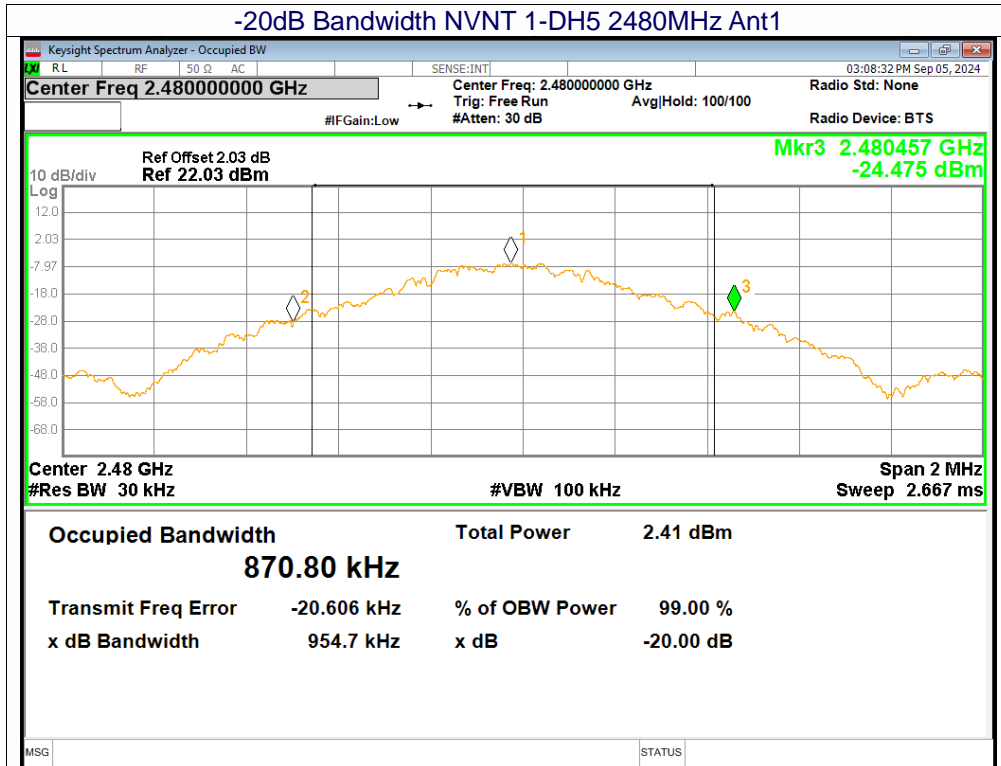

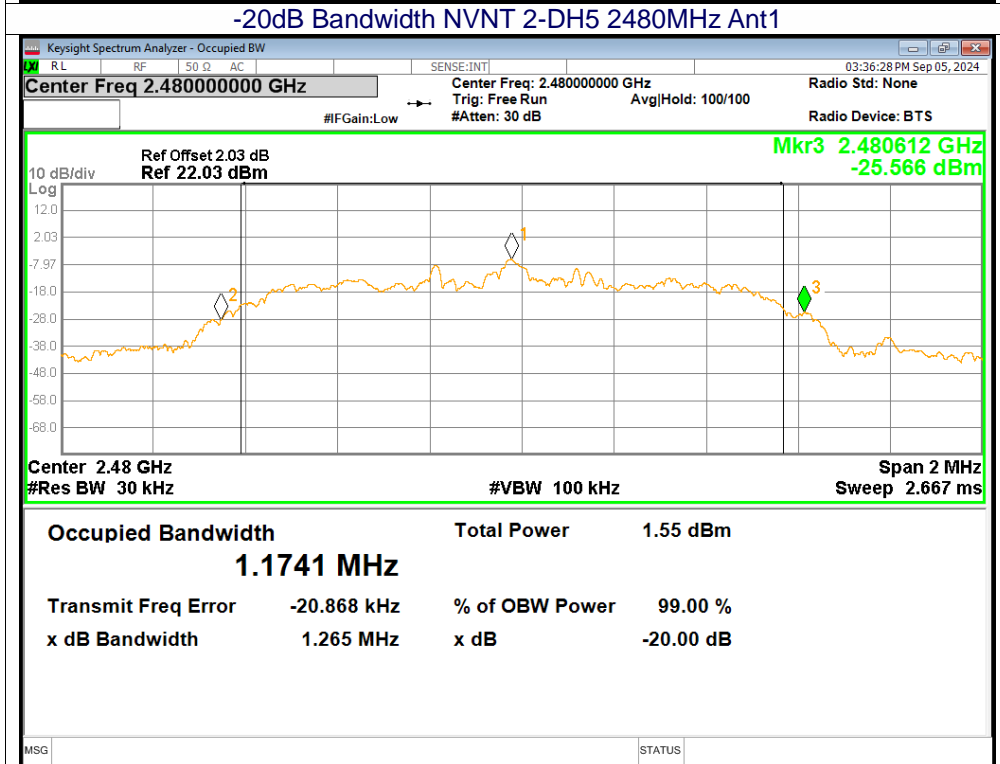
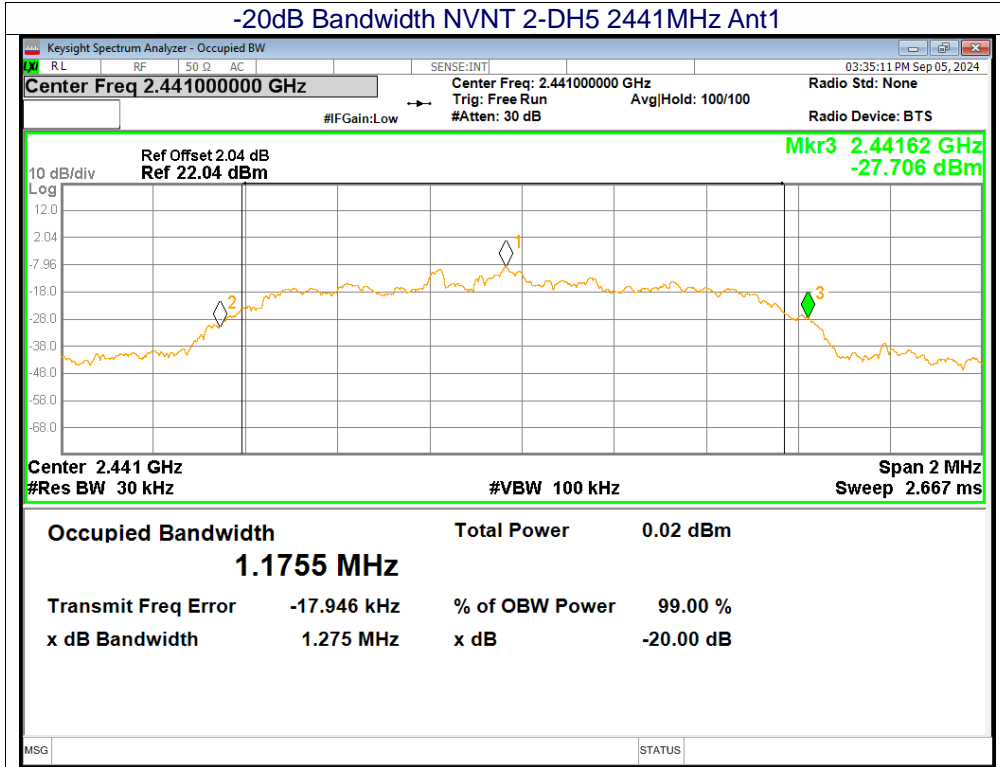

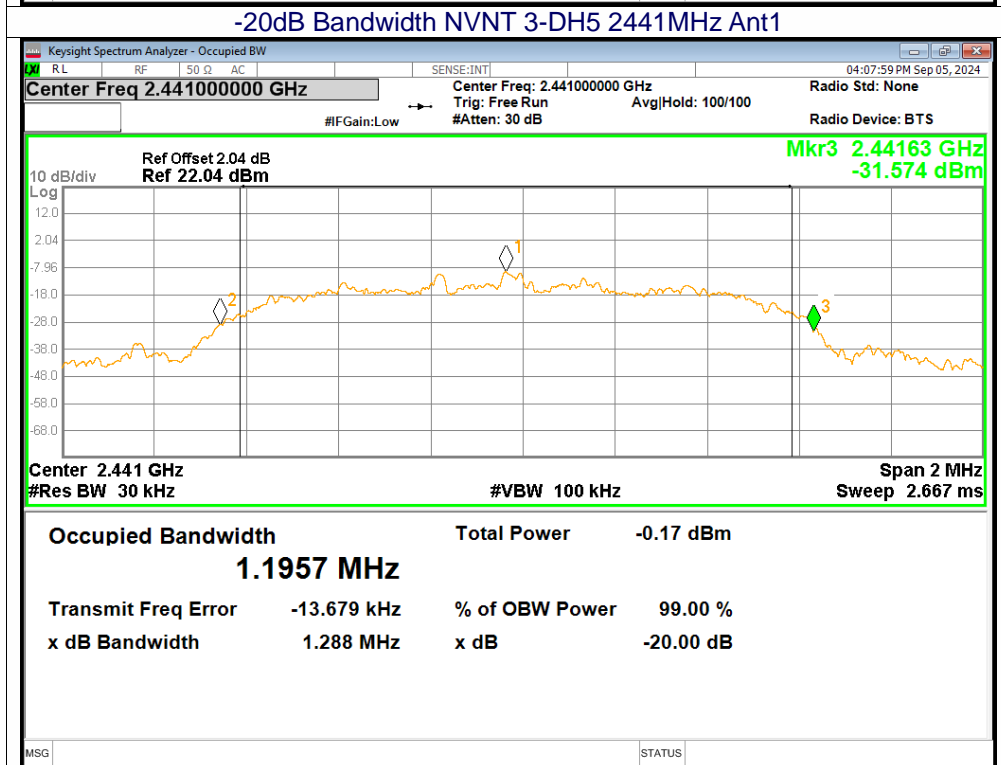
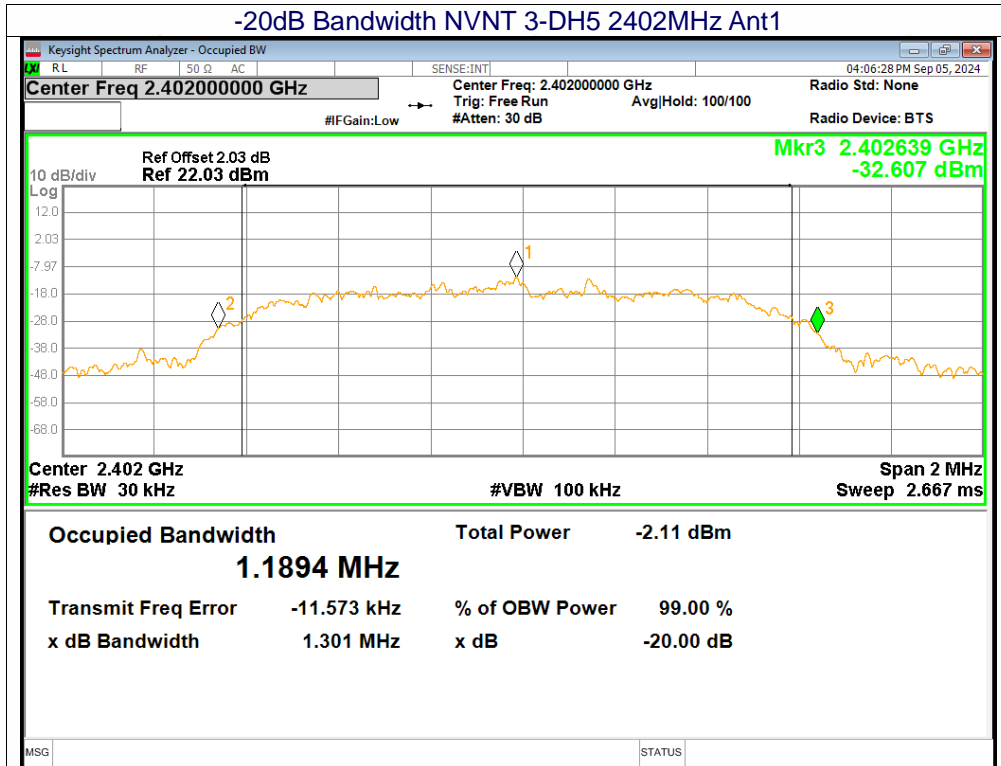

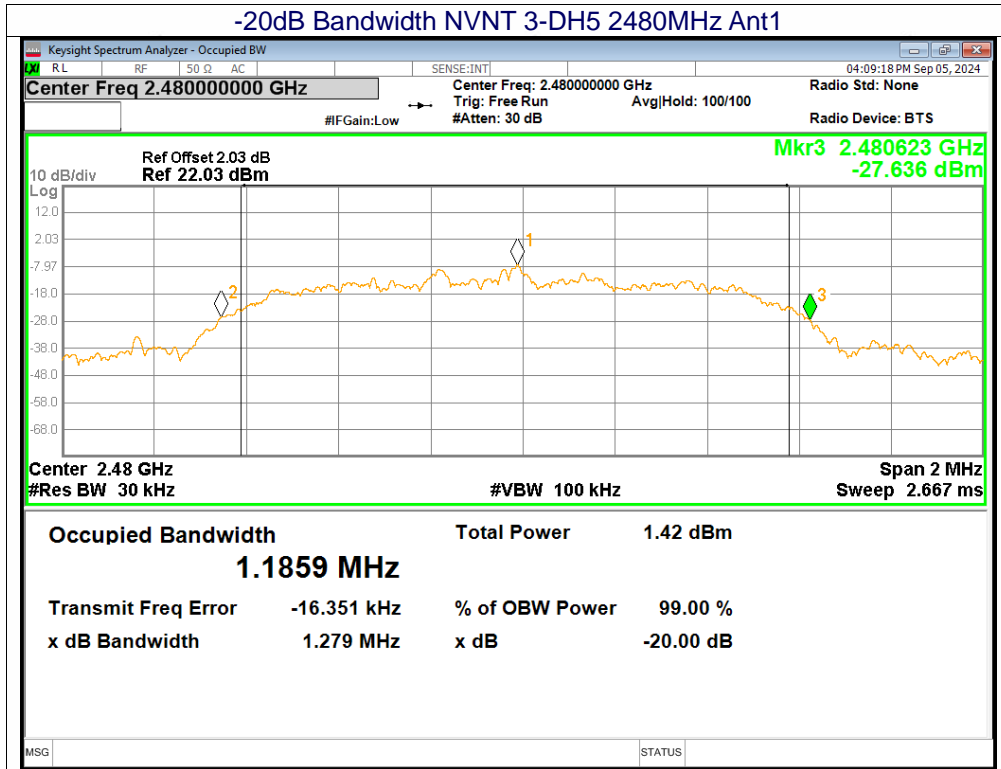

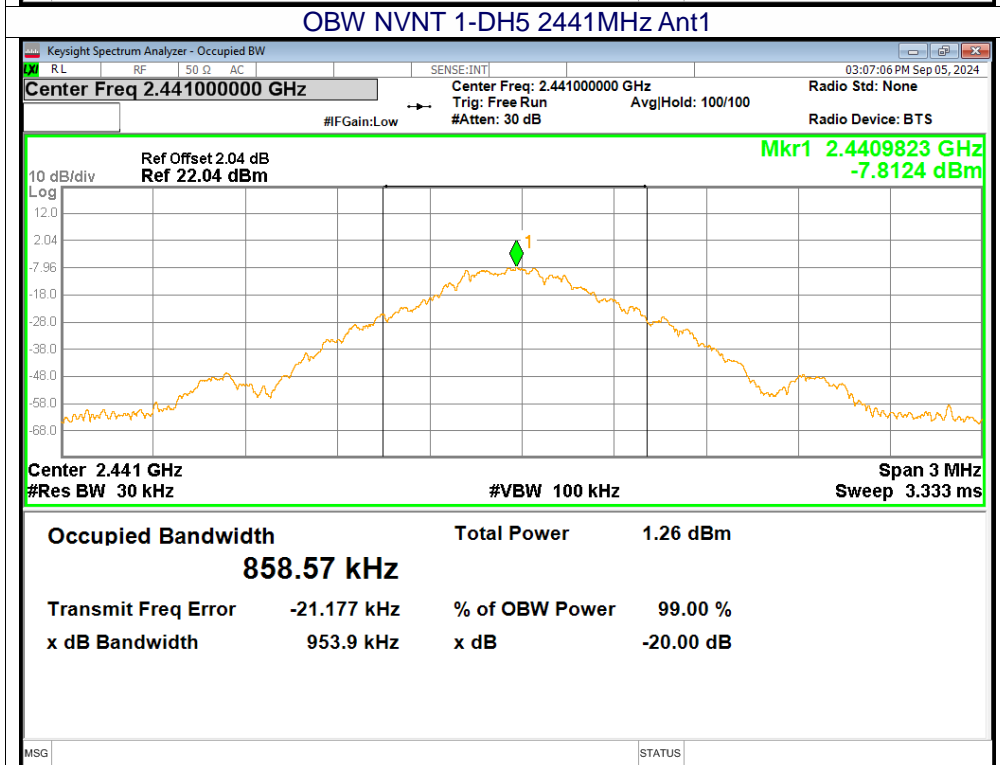
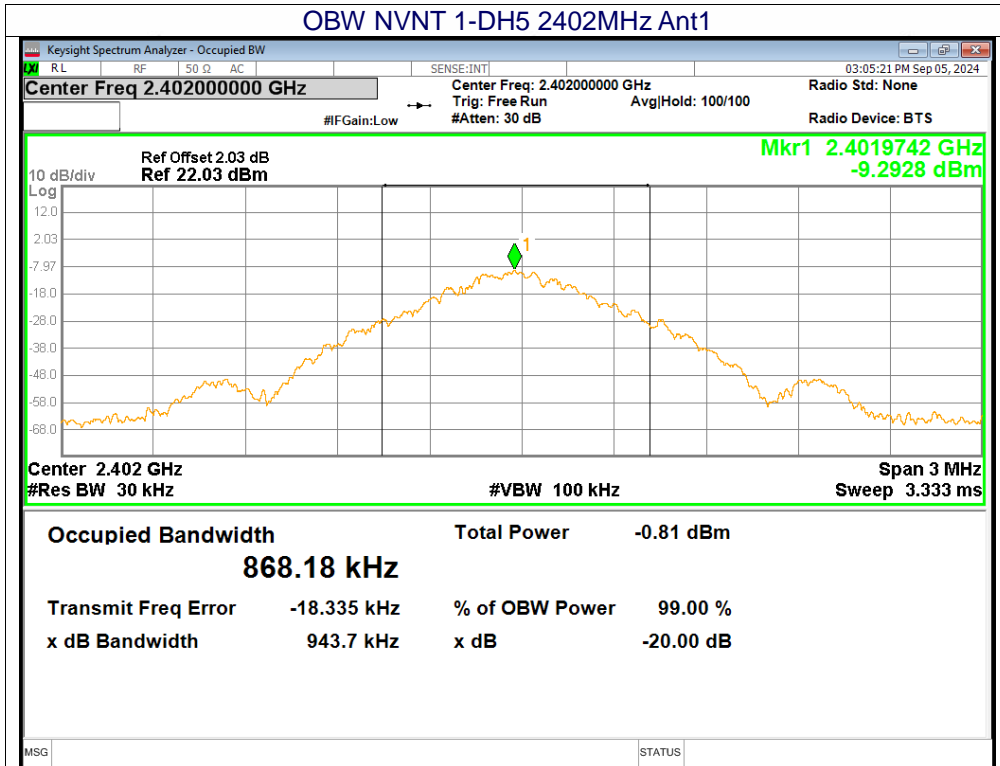

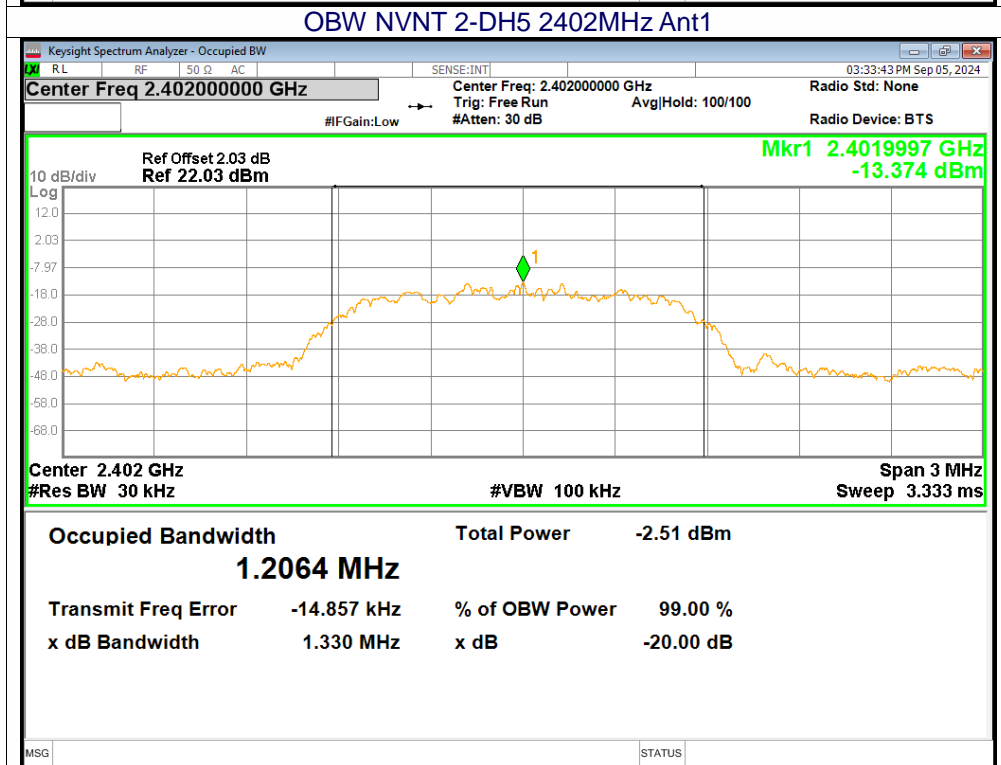
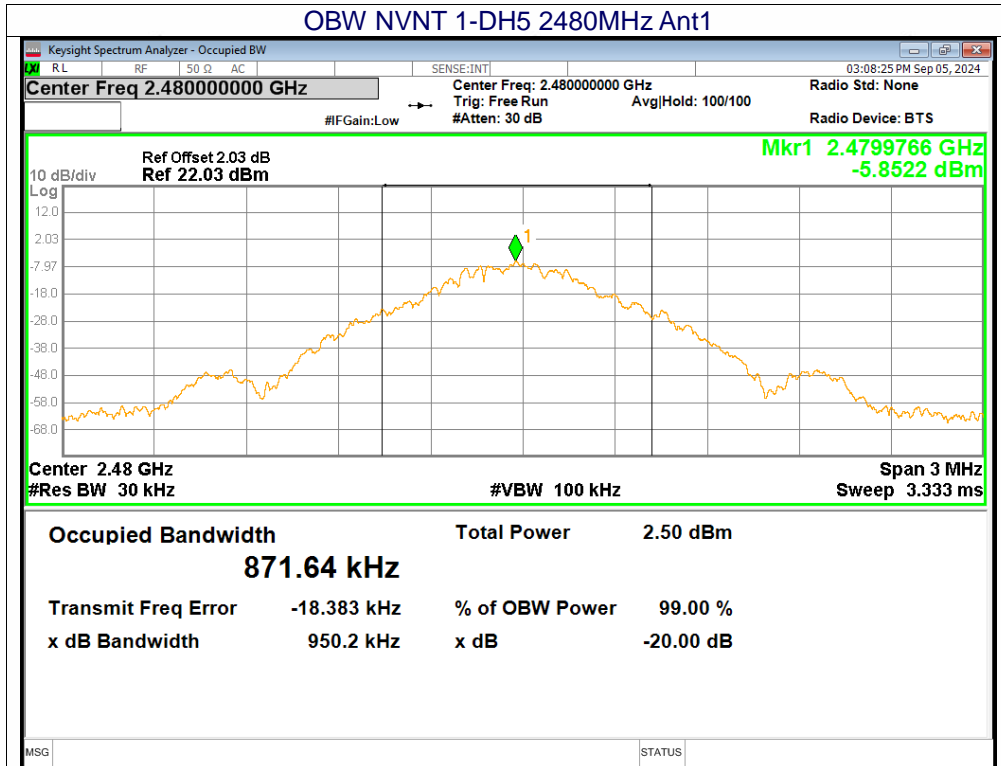

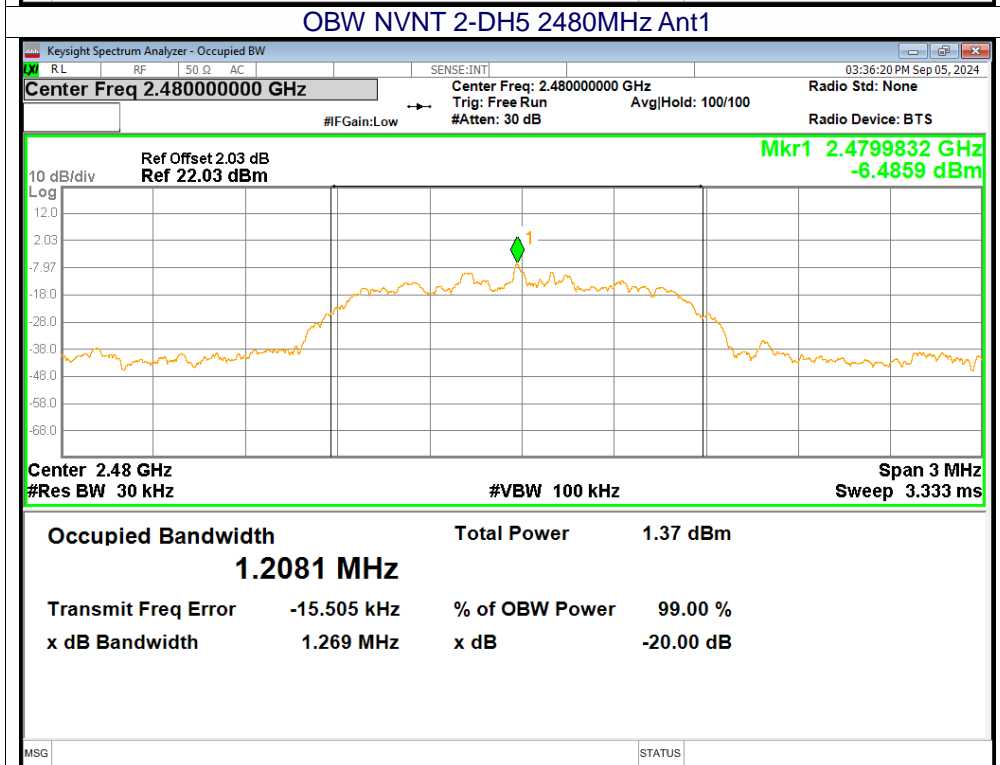
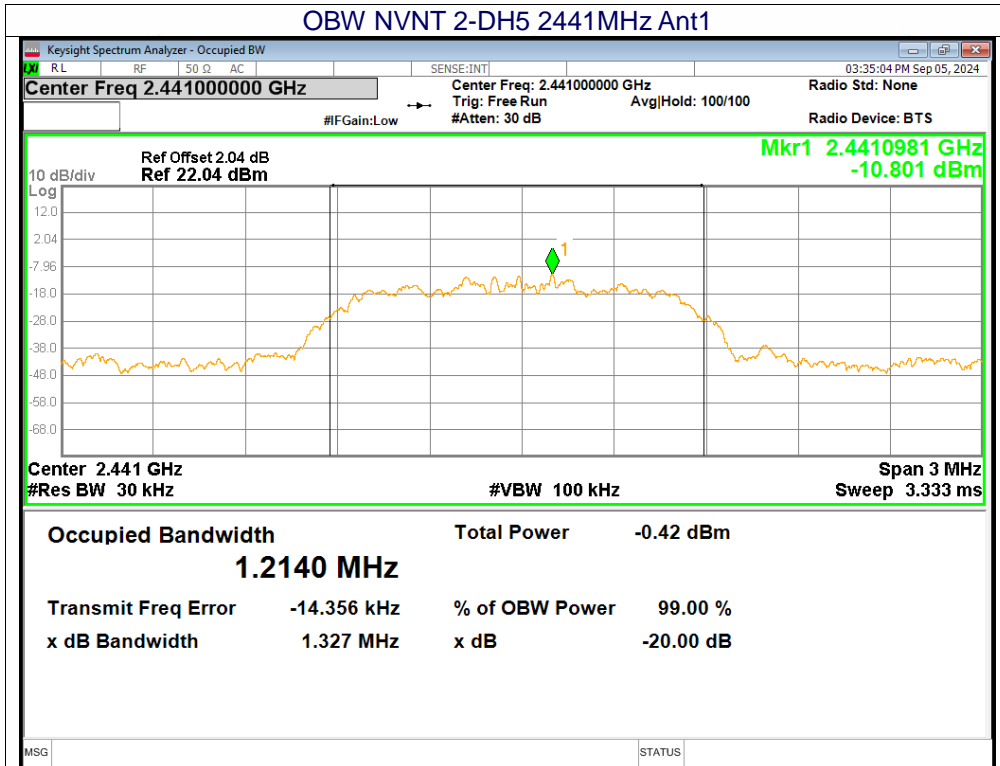

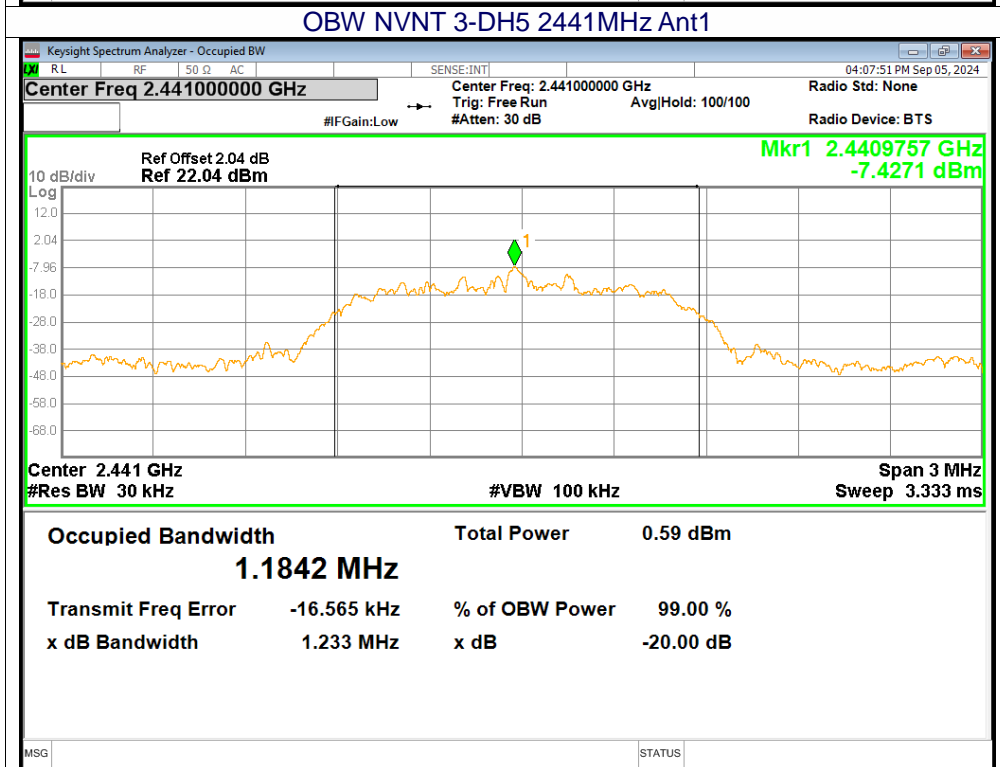
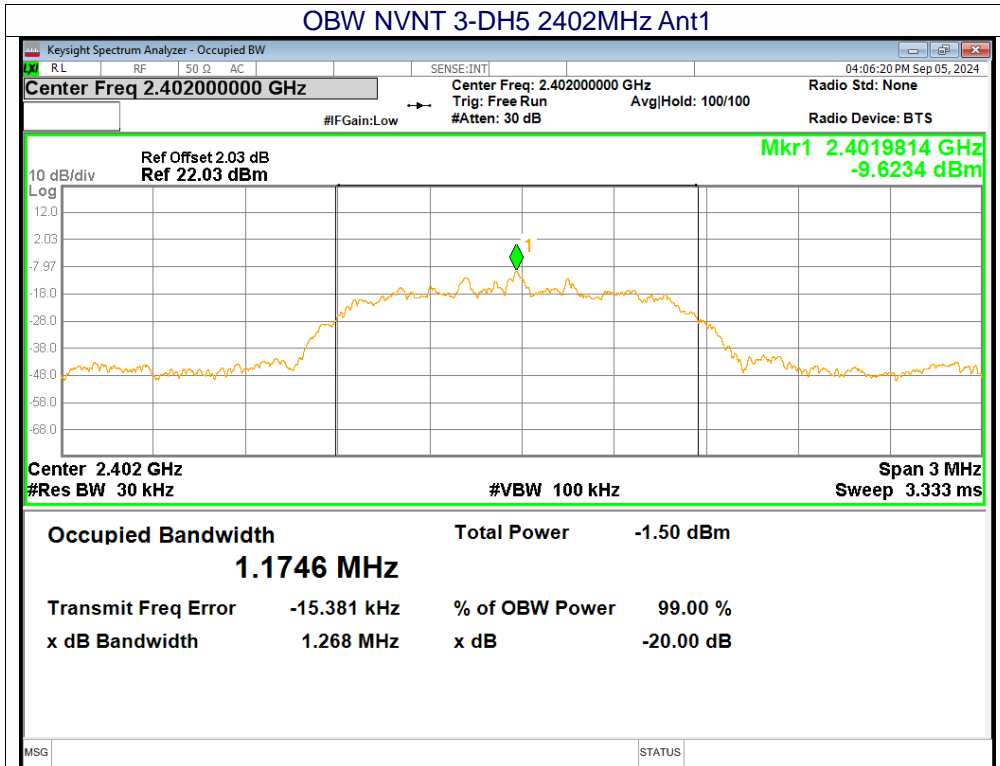

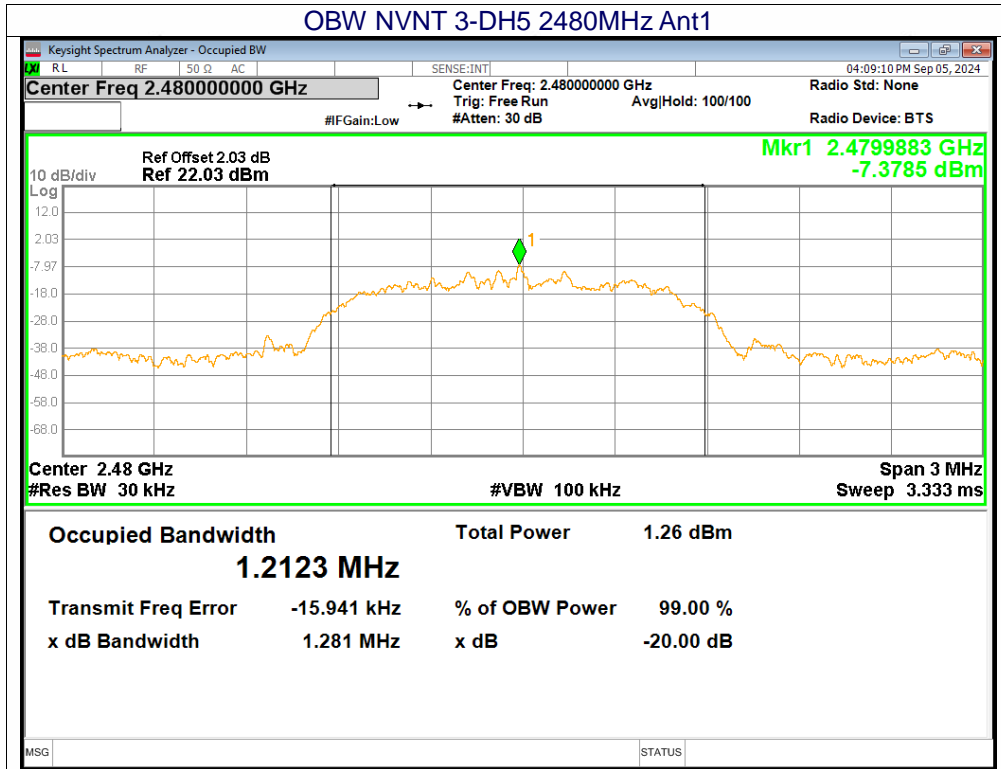

8. Maximum Peak Output Power

Test Requirement:	FCC Part15 C Section 15.247 (b)(1), RSS 247 5.4 (b)
Test Method:	ANSI C63.10:2013

8.1 Block Diagram Of Test Setup



8.2 Limit

For frequency hopping systems operating in the 2400-2483.5 MHz band employing at least 75 non-overlapping hopping channels, and all frequency hopping systems in the 5725-5850 MHz band: 1 watt. For all other frequency hopping systems in the 2400-2483.5 MHz band: 0.125 watts.

For FHSs operating in the band 2400-2483.5 MHz, the maximum peak conducted output power shall not exceed 1.0 W if the hopset uses 75 or more hopping channels; the maximum peak conducted output power shall not exceed 0.125 W if the hopset uses less than 75 hopping channels. The e.i.r.p. shall not exceed 4 W.

8.3 Test procedure

1. Remove the antenna from the EUT and then connect a low RF cable from the antenna port to the spectrum.
2. Set the spectrum analyzer: RBW = 2MHz. VBW =6MHz. Sweep = auto; Detector Function = Peak.
3. Keep the EUT in transmitting at lowest, medium and highest channel individually. Record the max value.

8.4 DEVIATION FROM STANDARD

No deviation.

8.5 Test Result

Mode	Test channel	Peak Output Power (dBm)	Peak Output Power Limit (dBm)	Result
GFSK	Lowest	-7.07	30.00	Pass
	Middle	-5.24		
	Highest	-3.82		
π/4DQPSK	Lowest	-5.95	21.00	Pass
	Middle	-4.1		
	Highest	-2.63		
8DPSK	Lowest	-5.33	21.00	Pass
	Middle	-3.32		
	Highest	-2.01		

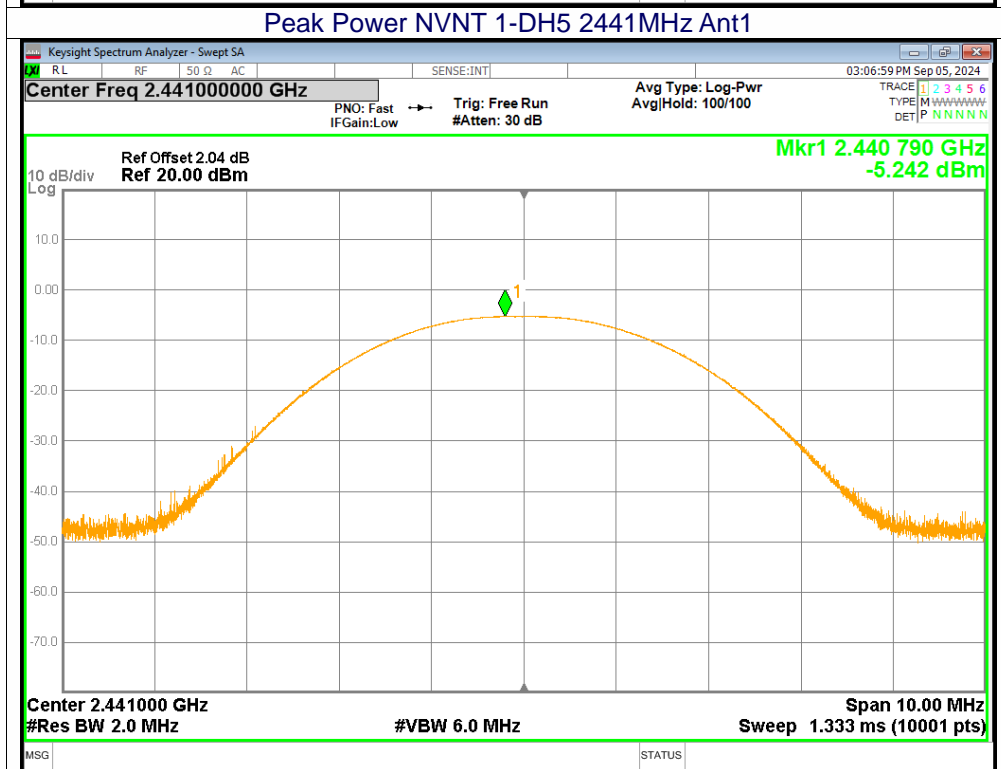
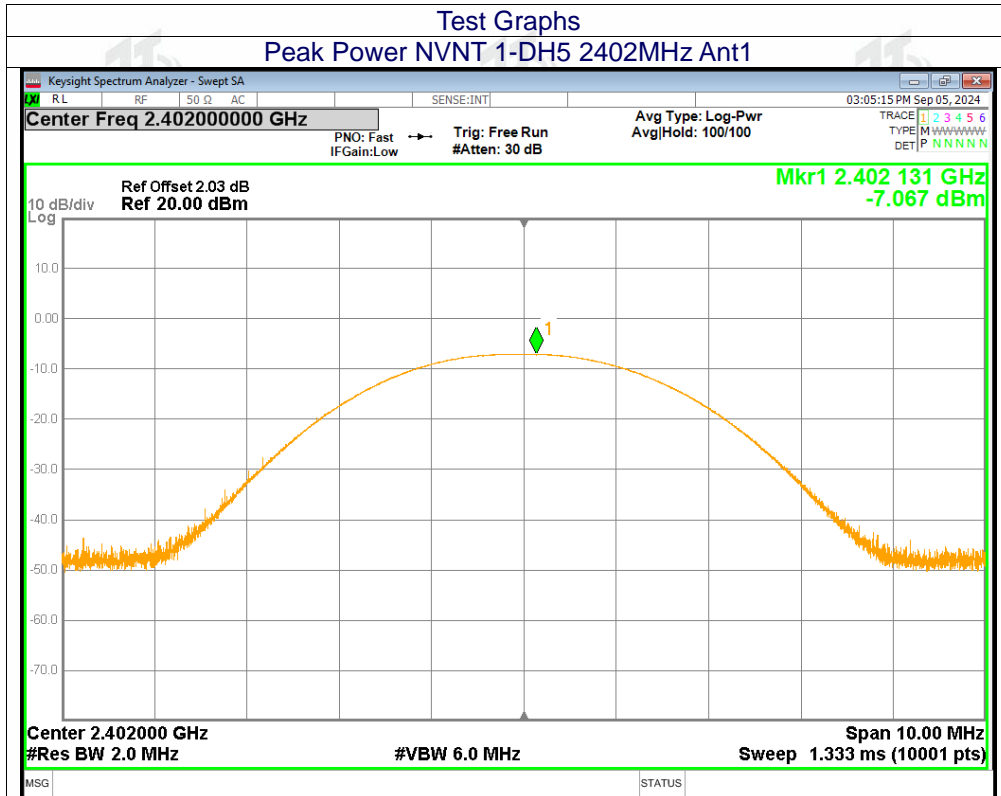

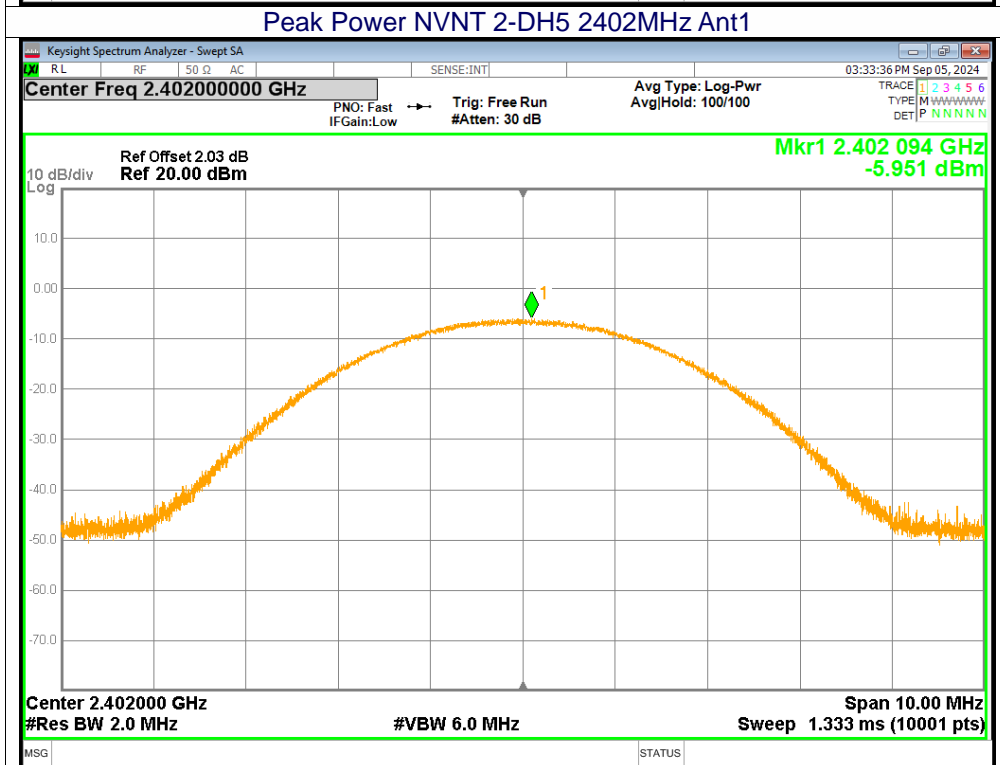
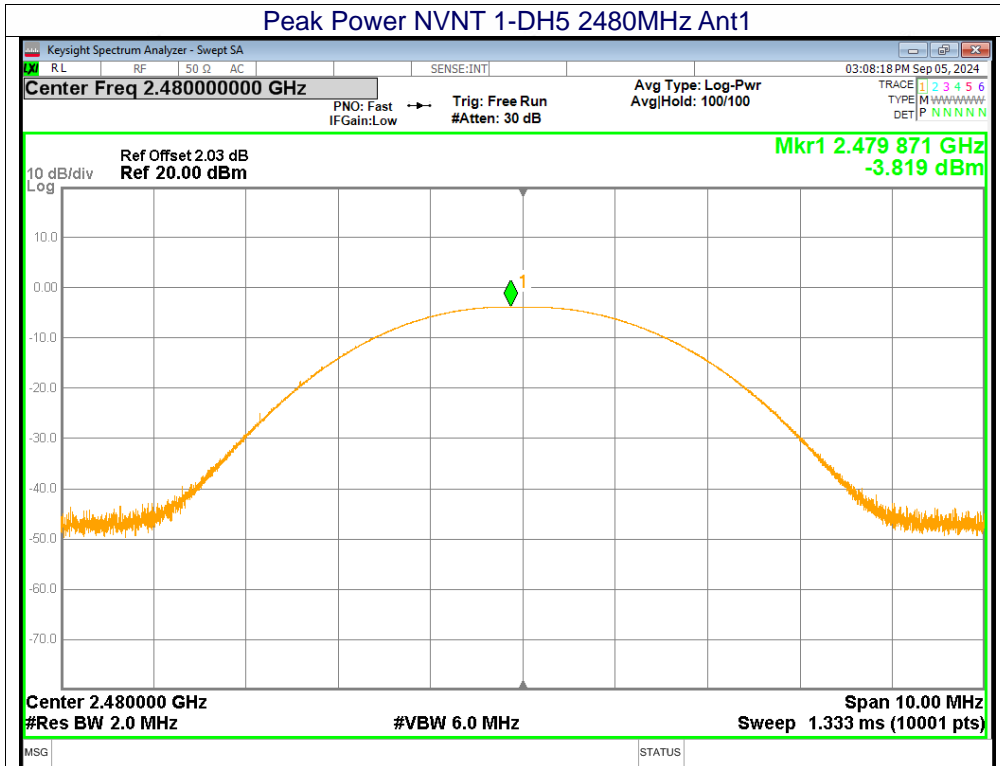

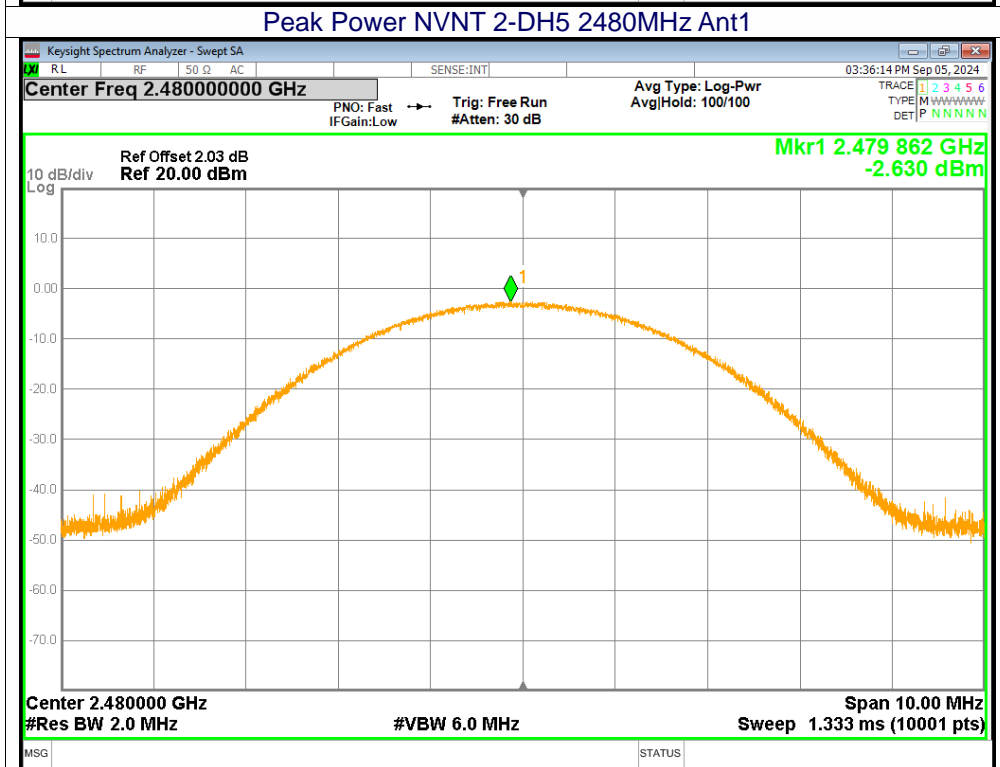
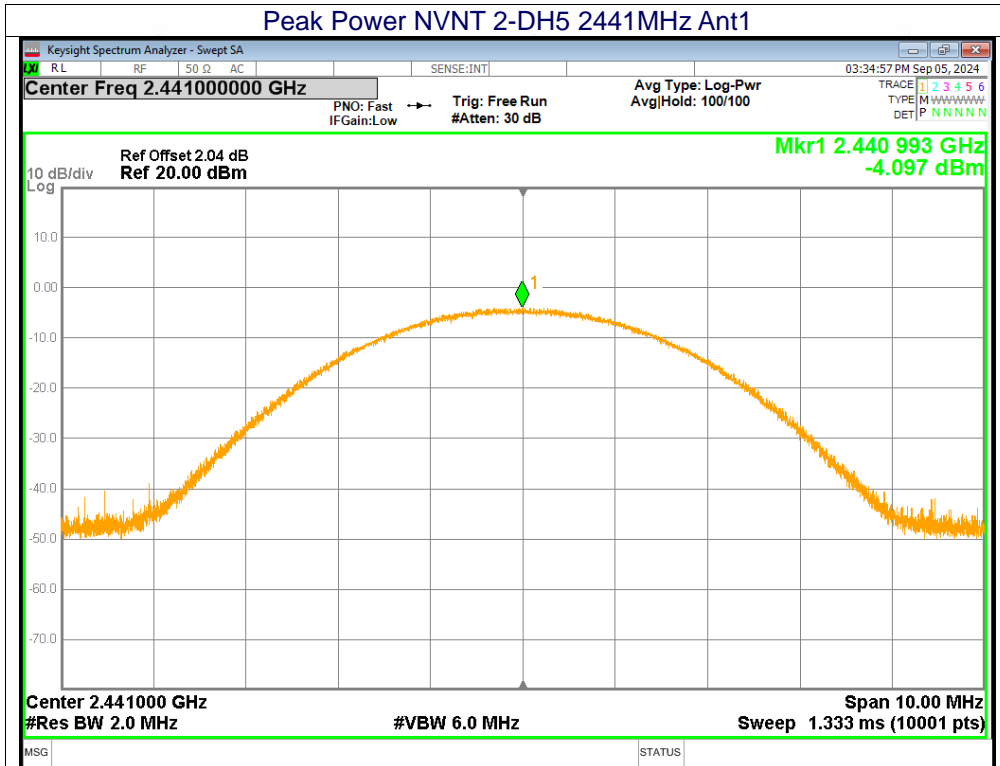

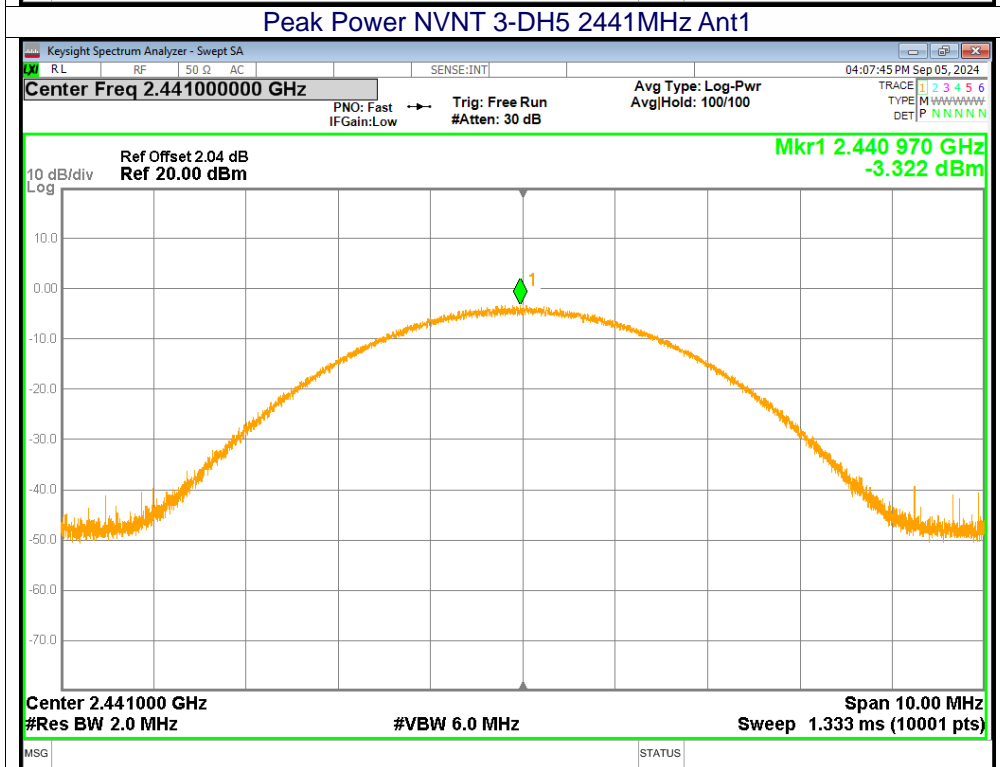
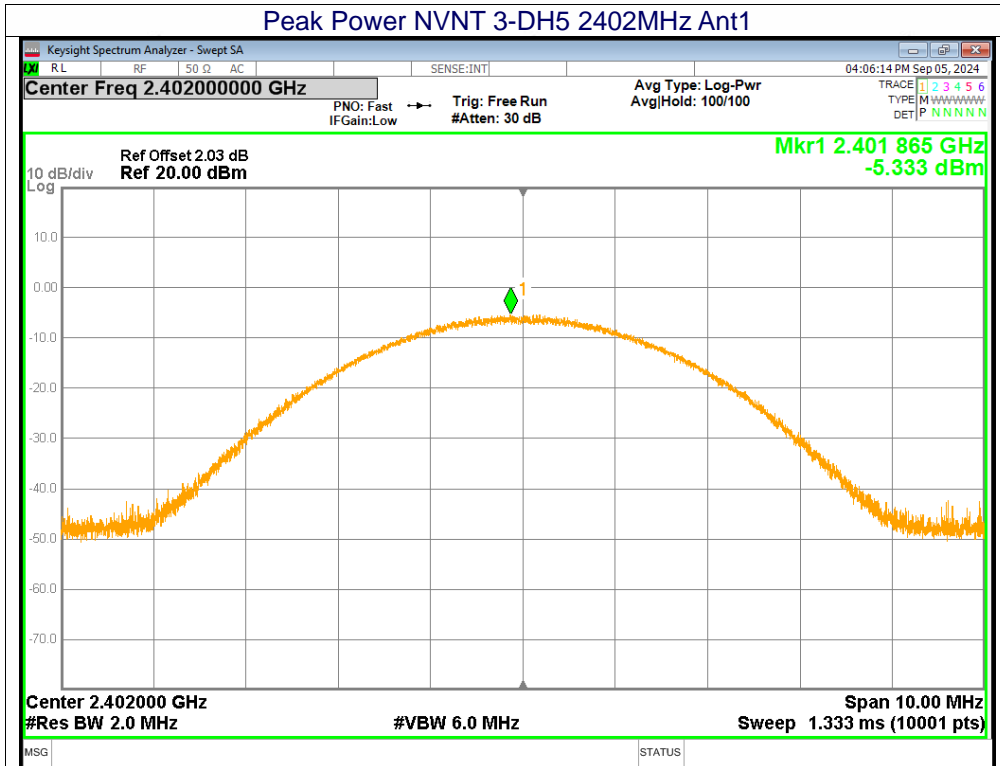

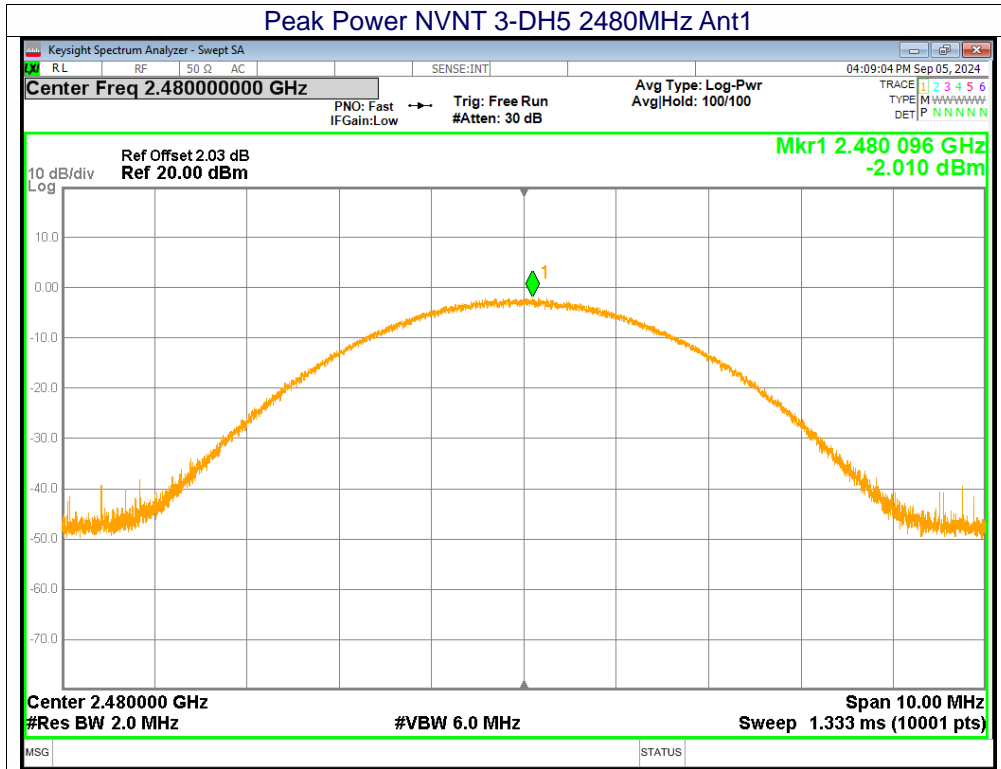



9. HOPPING CHANNEL SEPARATION

Test Requirement:	FCC Part15 C Section 15.247 (a)(1), RSS 247 5.1
Test Method:	ANSI C63.10:2013
Receiver setup:	RBW=30KHz, VBW=100KHz, detector=Peak
Limit:	GFSK: 20dB bandwidth $\pi/4$ -DQPSK & 8DSK: 0.025MHz or 2/3 of the 20dB bandwidth (whichever is greater)

9.1 Test Setup

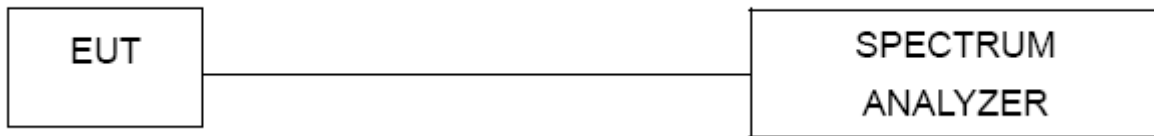

9.2 Test procedure

1. Remove the antenna from the EUT and then connect a low RF cable from the antenna port to the spectrum.
2. Set the spectrum analyzer: RBW = 30kHz. VBW = 100kHz , Span = 2.0MHz. Sweep = auto; Detector Function = Peak. Trace = Max hold.
3. Allow the trace to stabilize. Use the marker-delta function to determine the separation between the peaks of the adjacent channels. The limit is specified in one of the subparagraphs of this Section Submit this plot.

9.3 DEVIATION FROM STANDARD

No deviation.

9.4 Test Result

Mode	Hopping Freq1 (MHz)	Hopping Freq2 (MHz)	HFS (MHz)	Limit (MHz)	Verdict
1-DH5	2401.978	2402.974	0.996	0.95	Pass
1-DH5	2440.976	2441.956	0.98	0.953	Pass
1-DH5	2478.97	2479.97	1	0.955	Pass
2-DH5	2401.974	2402.976	1.002	0.841	Pass
2-DH5	2440.972	2441.97	0.998	0.85	Pass
2-DH5	2478.98	2479.974	0.994	0.843	Pass
3-DH5	2401.972	2402.974	1.002	0.867	Pass
3-DH5	2440.974	2441.972	0.998	0.859	Pass
3-DH5	2478.978	2479.972	0.994	0.853	Pass

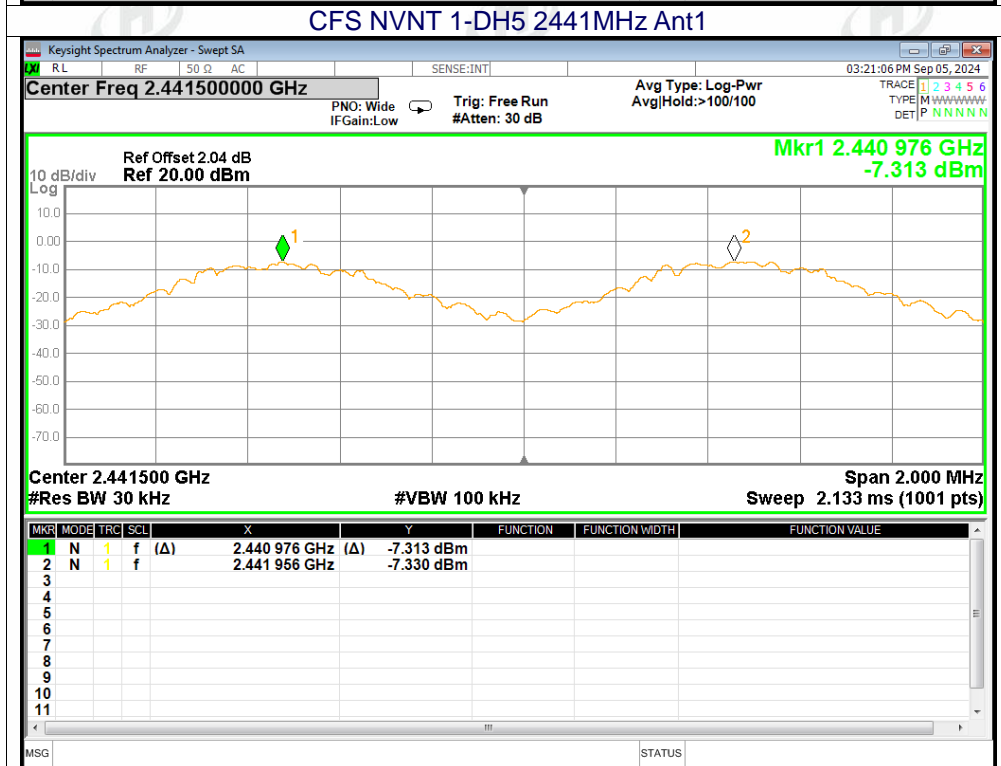
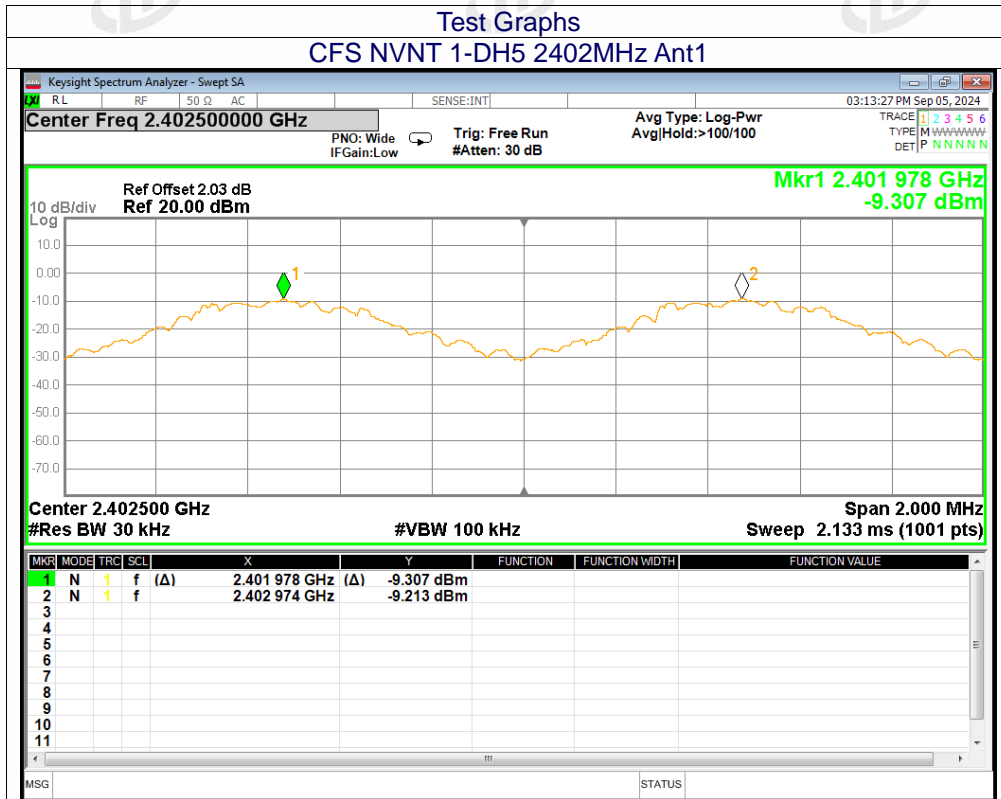

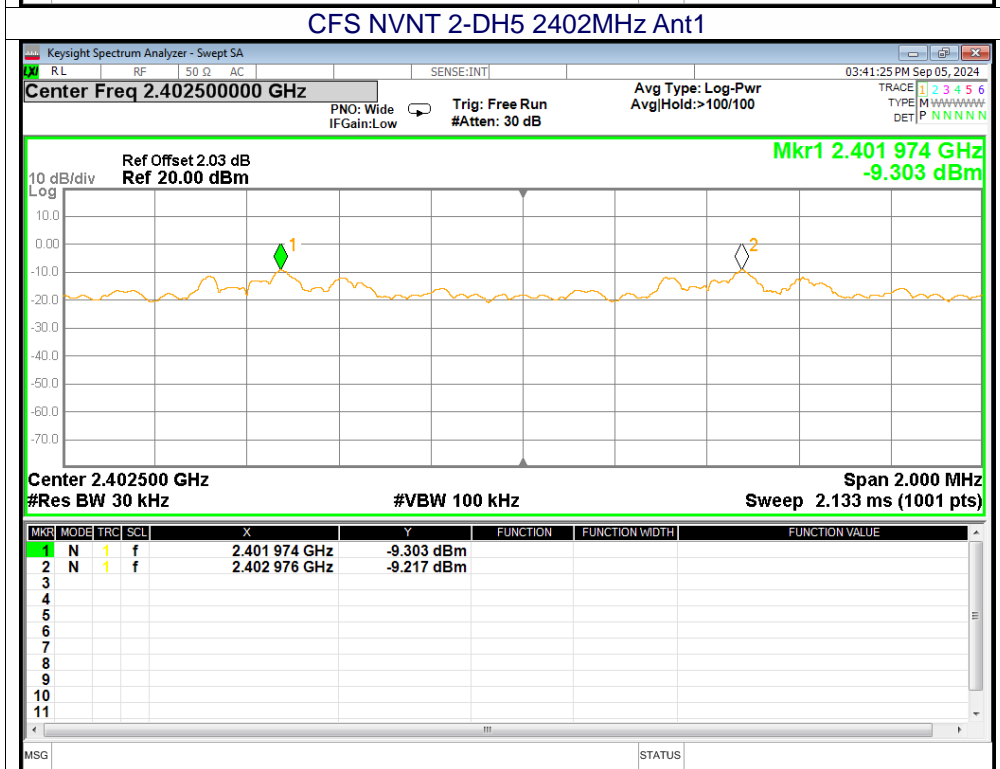
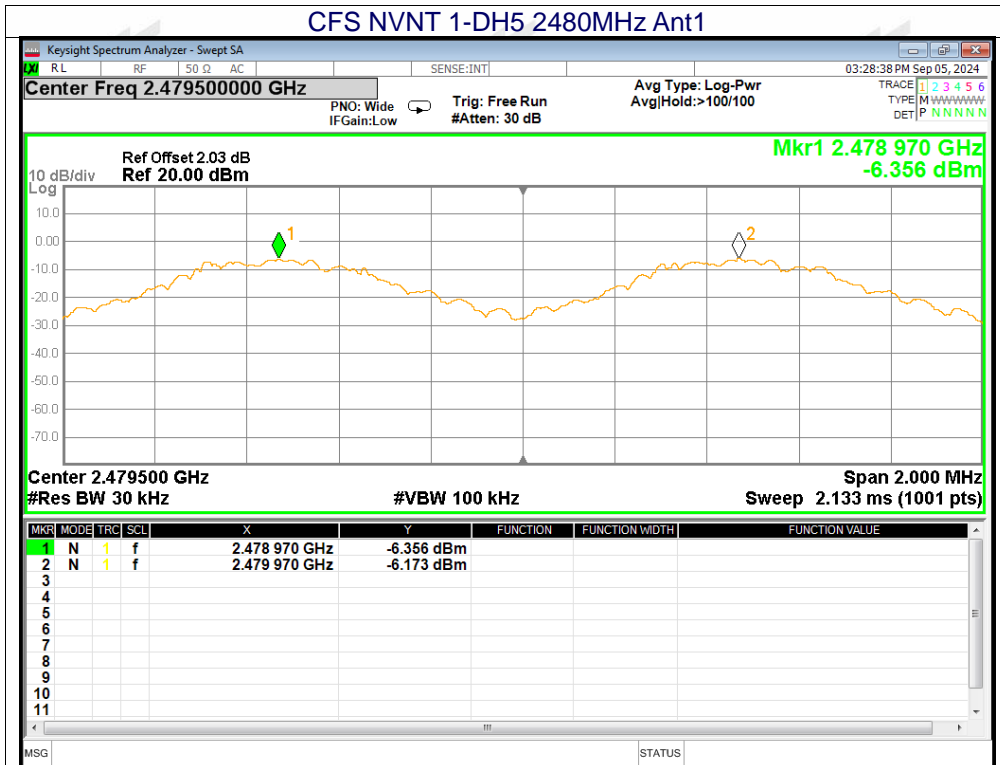

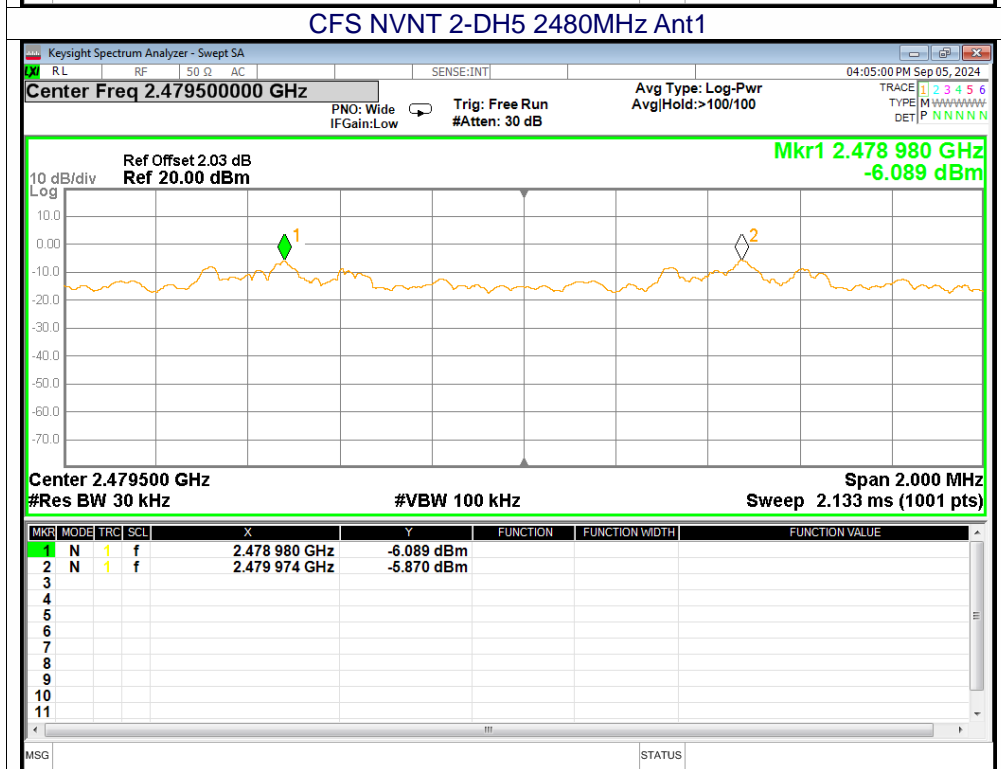
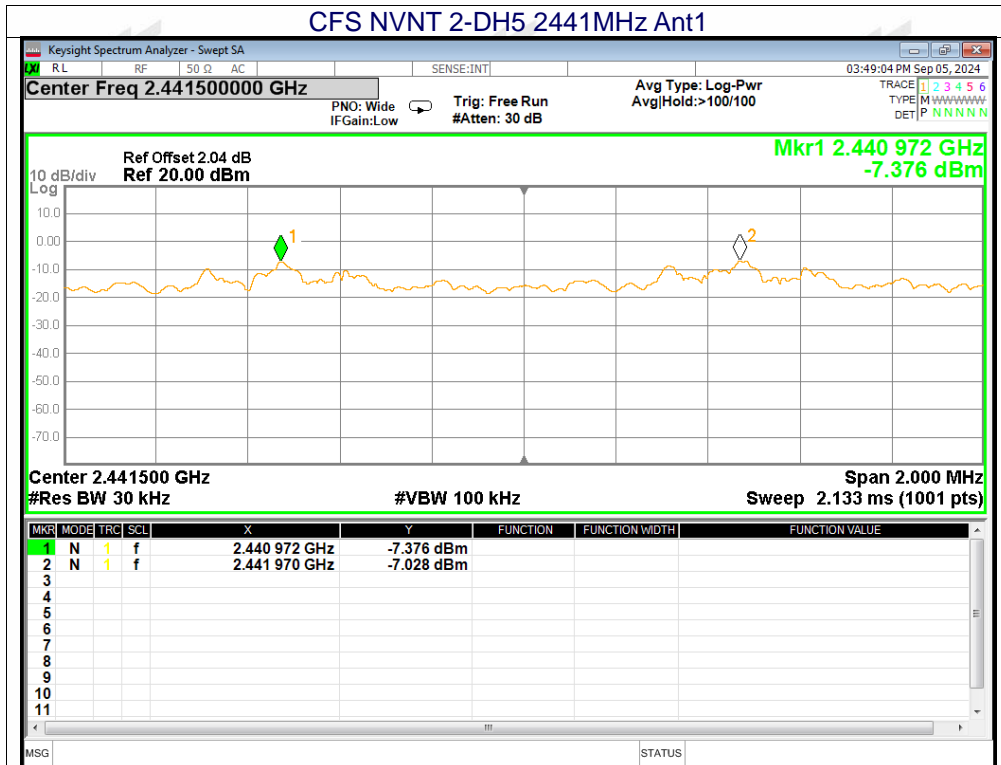

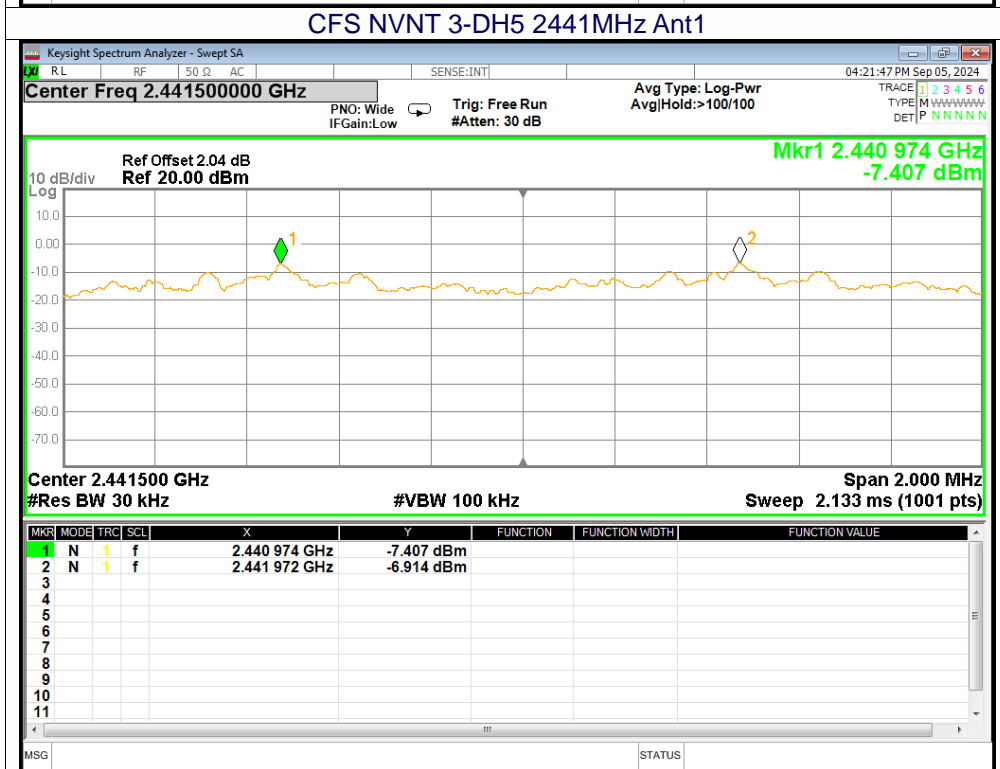
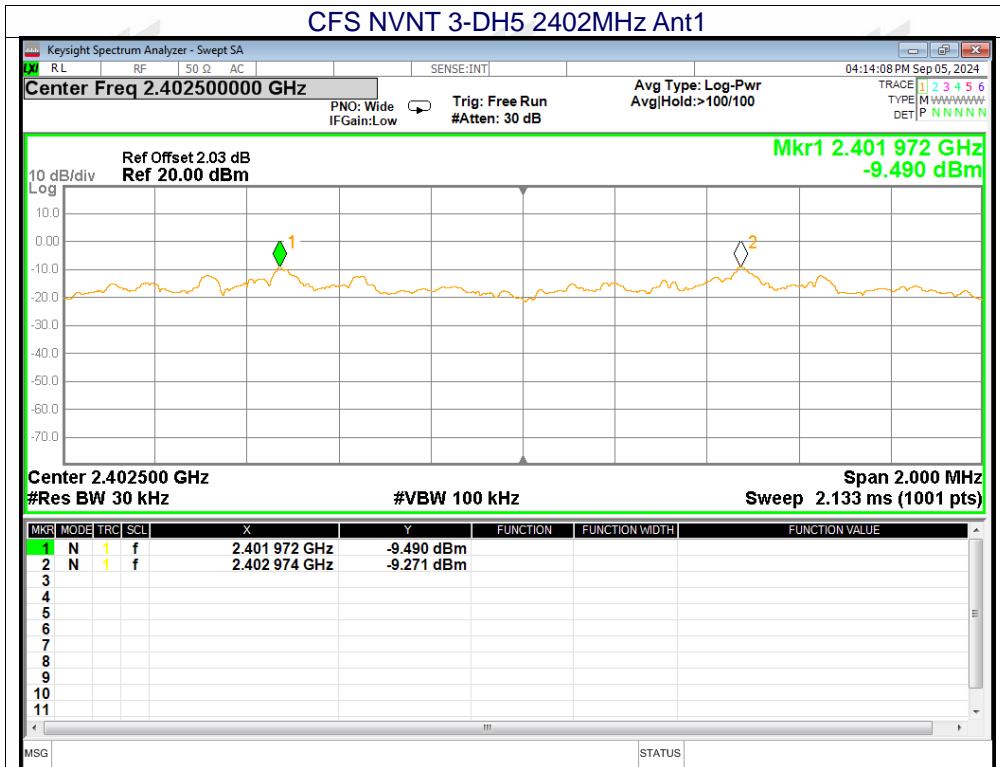

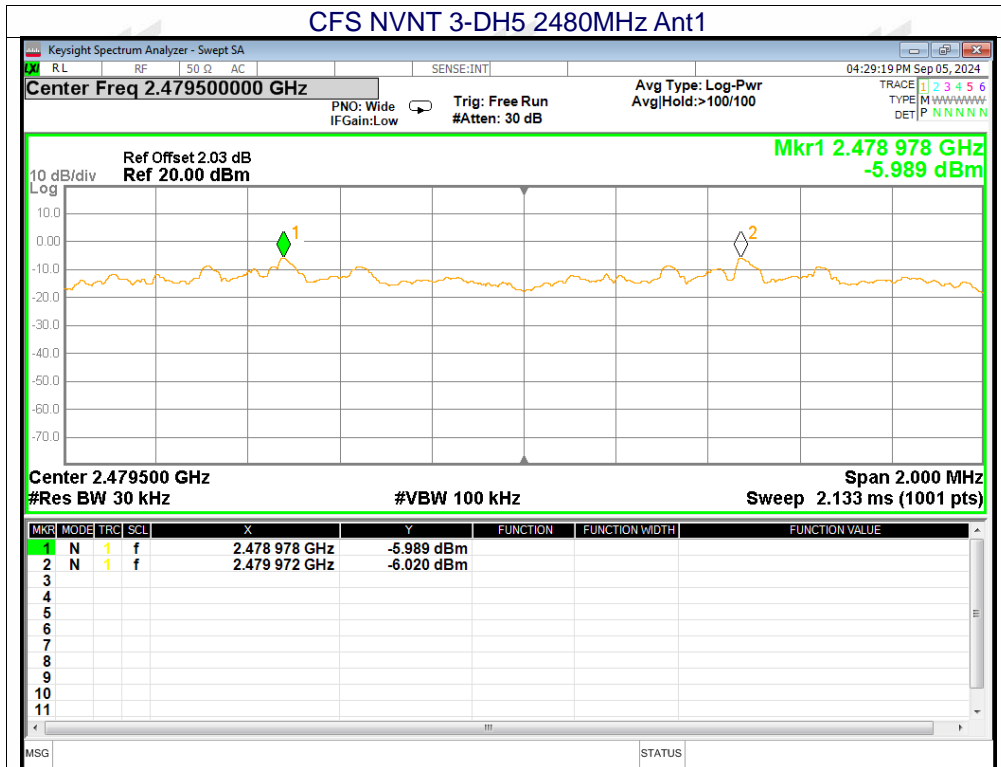



10.NUMBER OF HOPPING FREQUENCY

Test Requirement:	FCC Part15 C Section 15.247 (a)(1)(iii), RSS-247 5.1
Test Method:	ANSI C63.10:2013
Receiver setup:	RBW=100kHz, VBW=300kHz, Frequency range=2400MHz-2483.5MHz, Detector=Peak
Limit:	15 channels

10.1 Test Setup

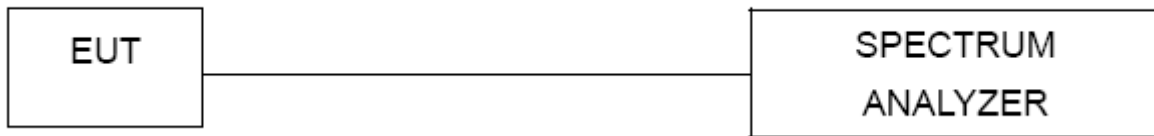

10.2 Test procedure

1. Remove the antenna from the EUT and then connect a low RF cable from the antenna port to the spectrum.
2. Set the spectrum analyzer: RBW = 100kHz. VBW = 300kHz. Sweep = auto; Detector Function = Peak. Trace = Max hold.
3. Allow the trace to stabilize. It may prove necessary to break the span up to sections. in order to clearly show all of the hopping frequencies. The limit is specified in one of the subparagraphs of this Section.
4. Set the spectrum analyzer: Start Frequency = 2.4GHz, Stop Frequency = 2.4835GHz. Sweep=auto;

10.3 DEVIATION FROM STANDARD

No deviation.



10.4 Test Result

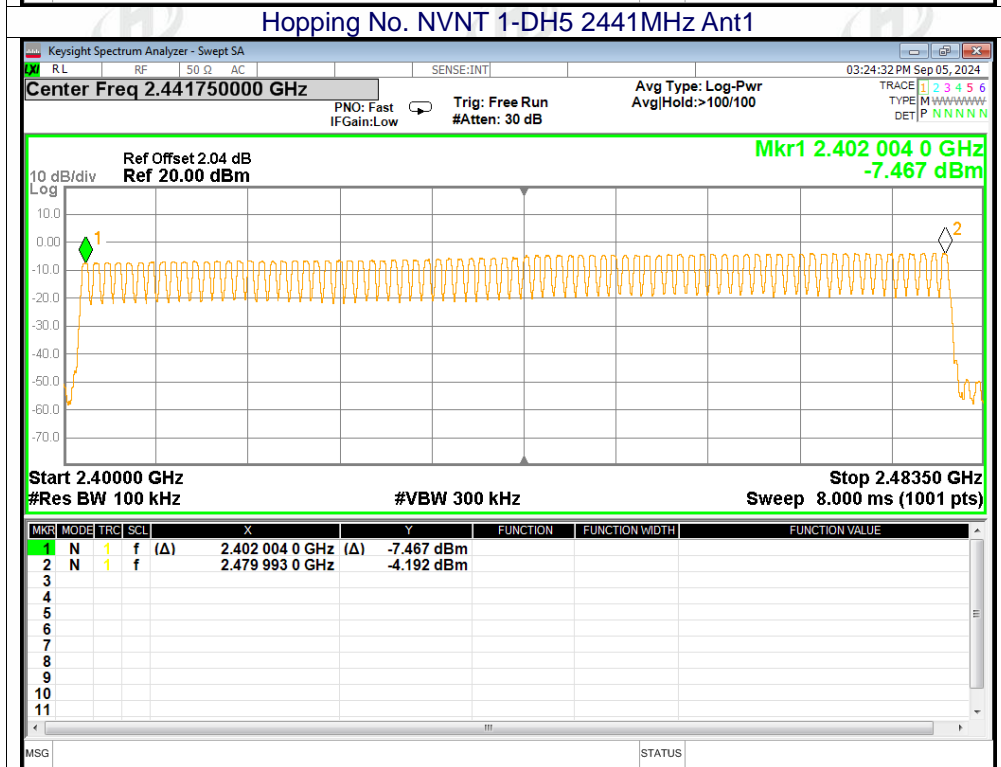
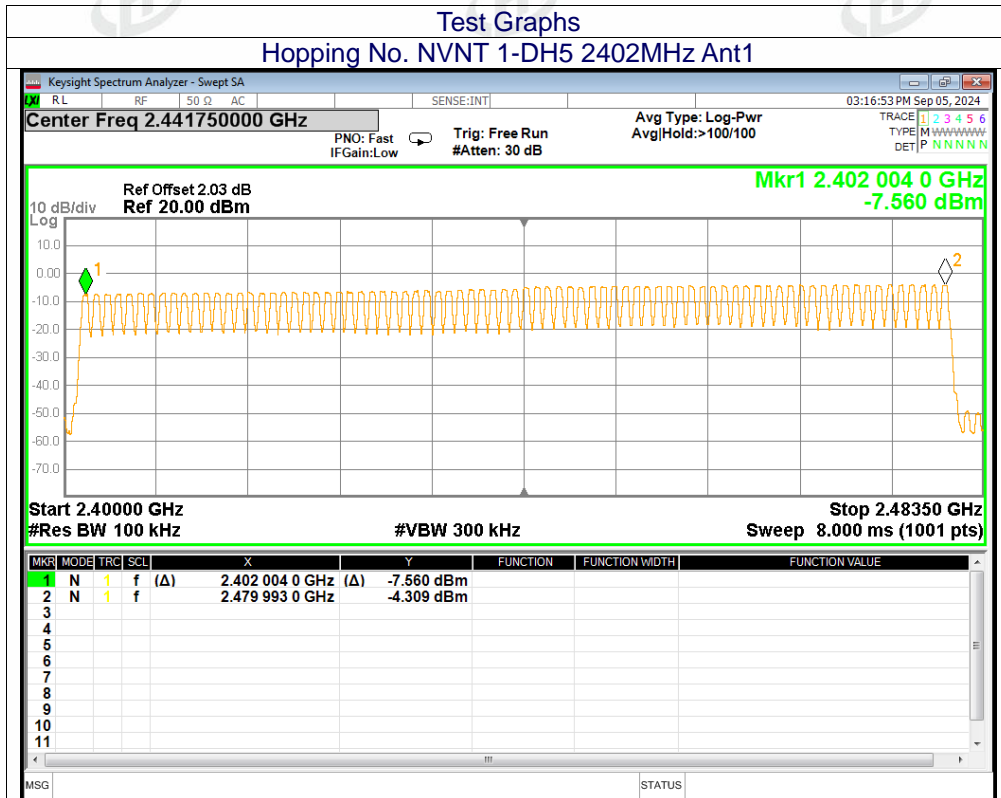

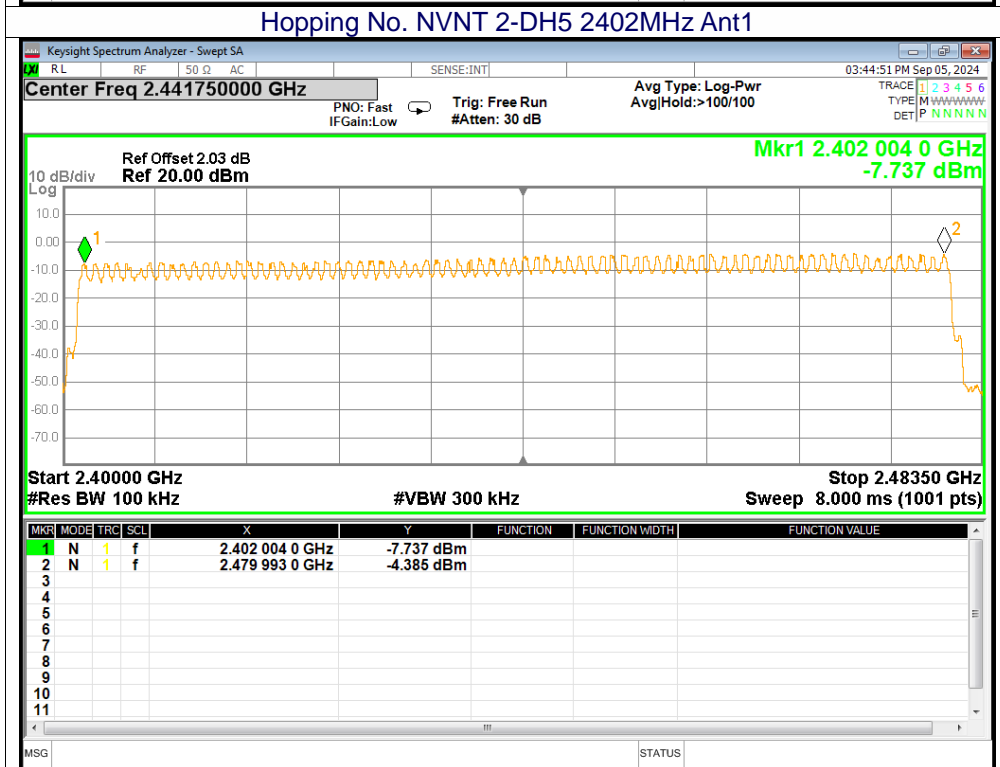
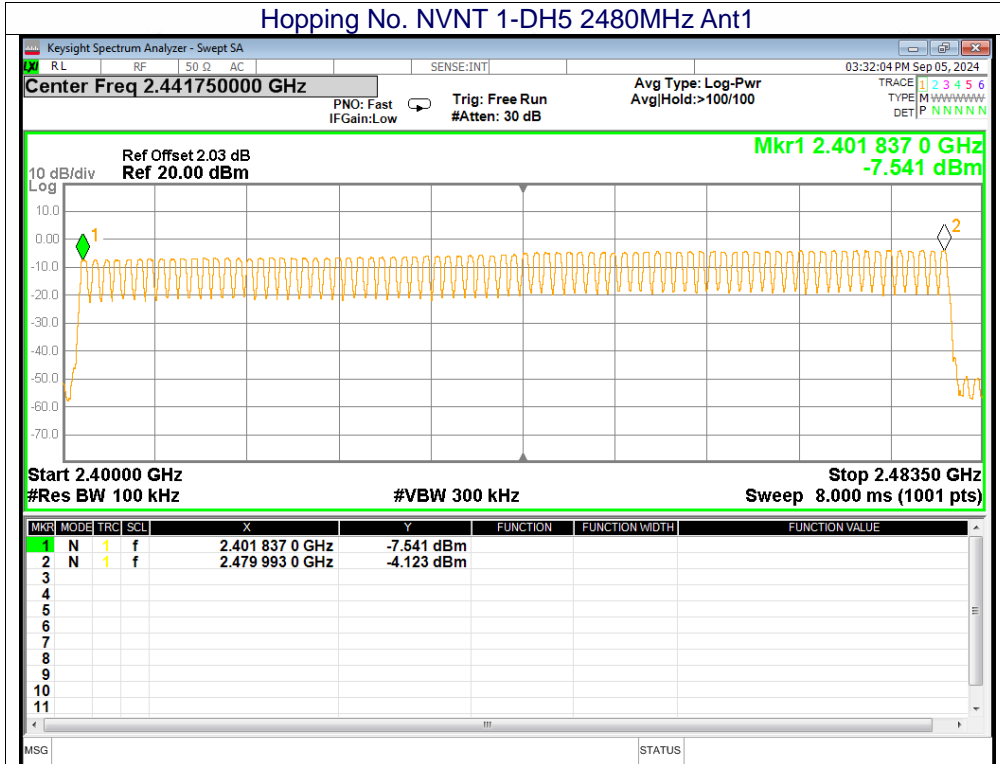

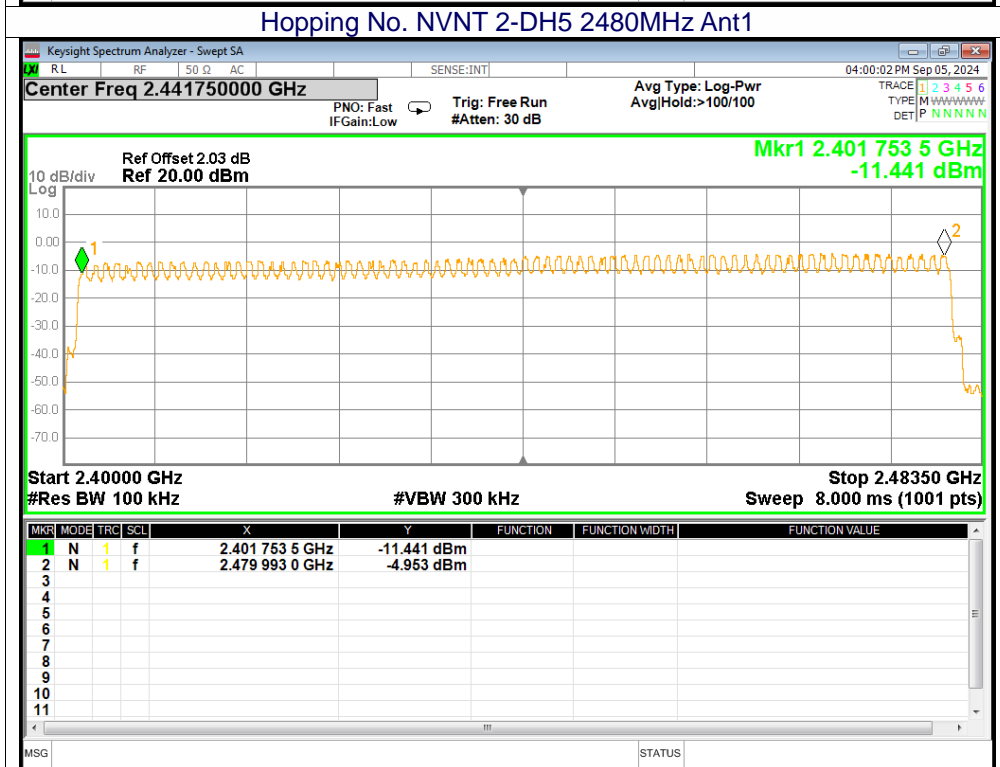
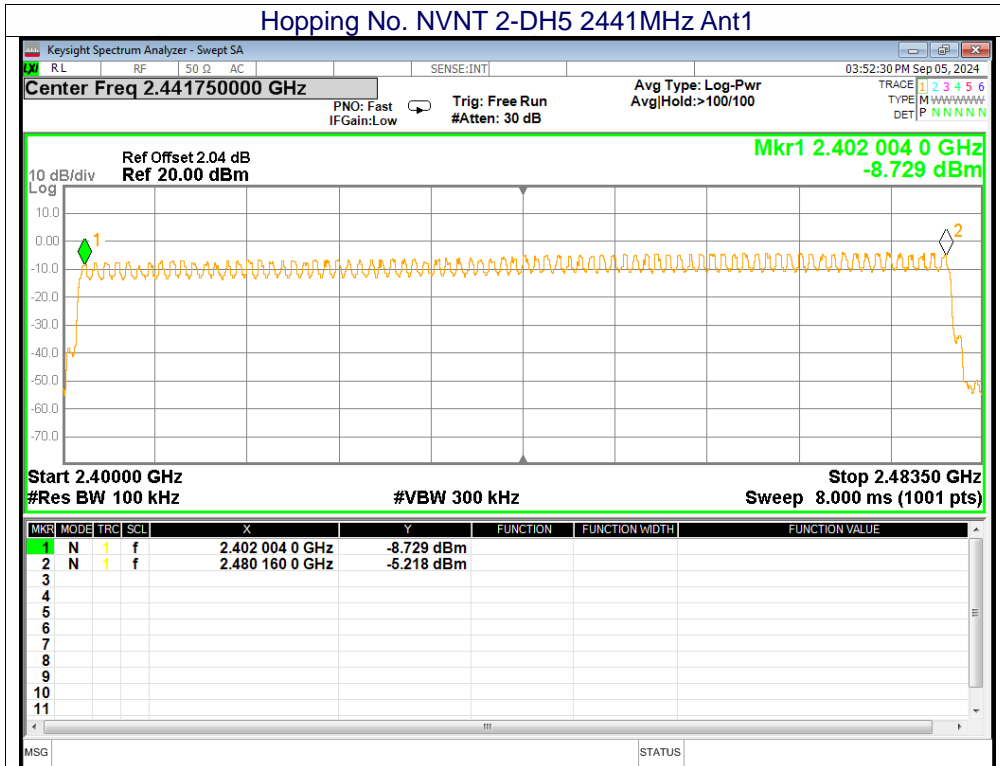

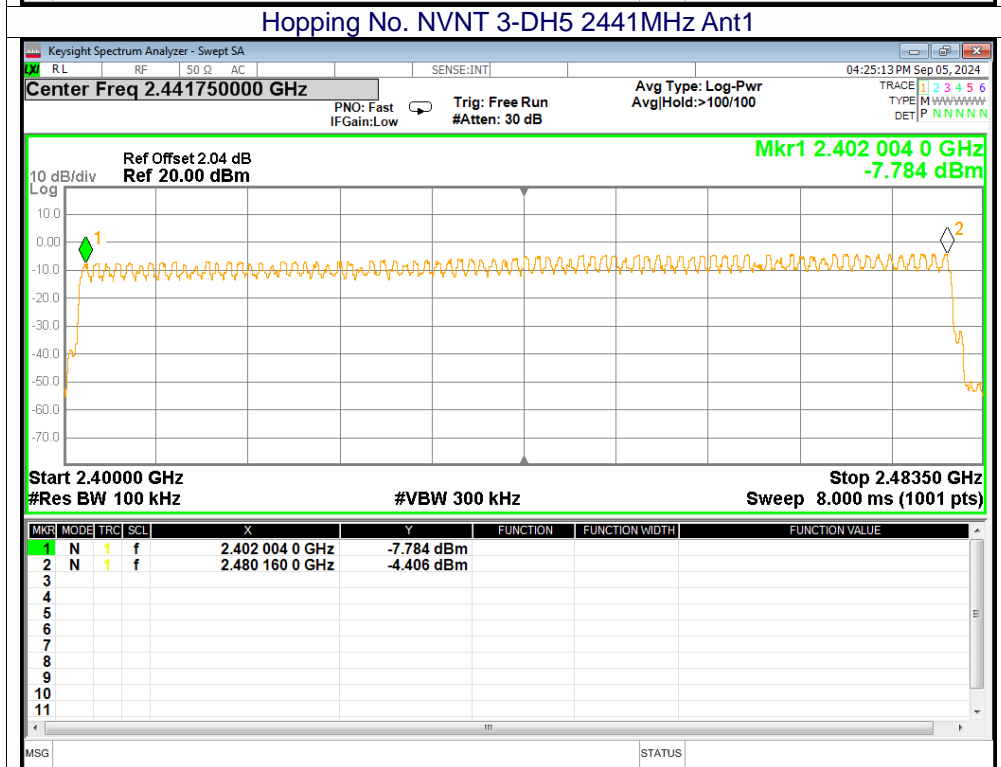
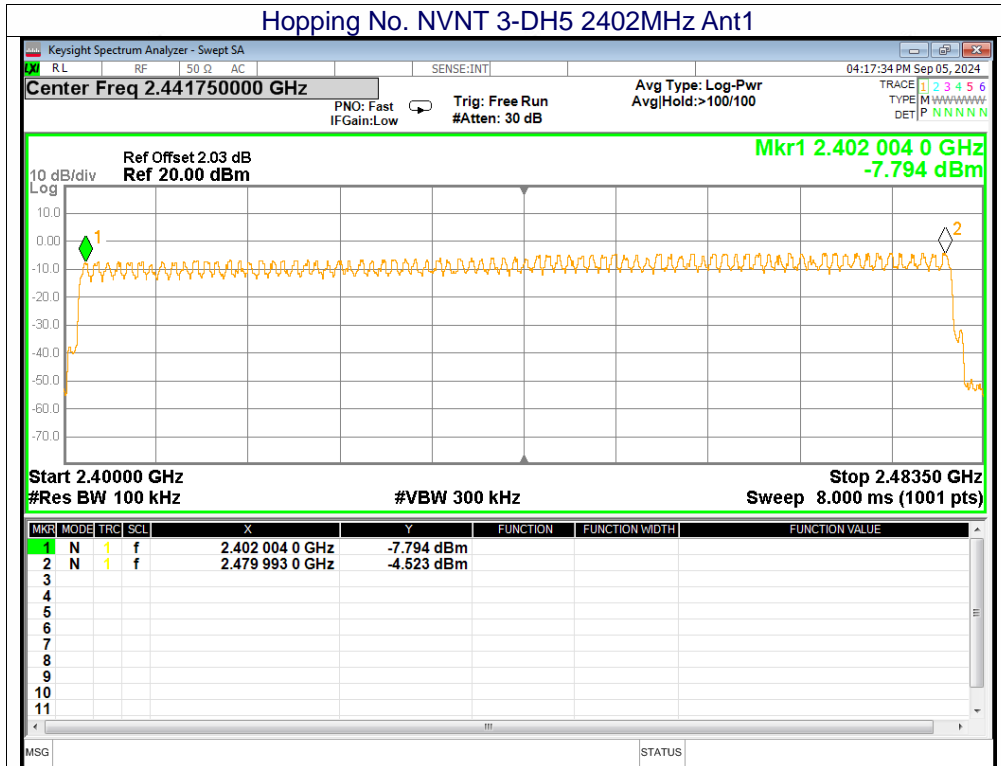

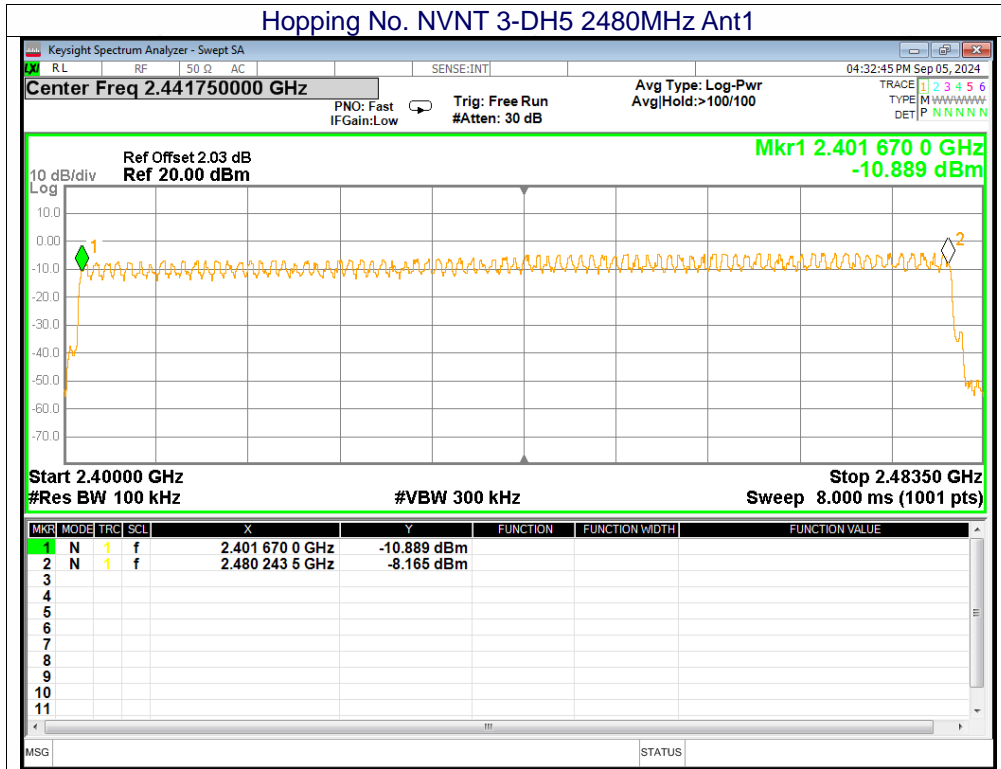



11. DWELL TIME

Test Requirement:	FCC Part15 C Section 15.247 (a)(1)(iii), RSS-247 5.1
Test Method:	ANSI C63.10:2013
Receiver setup:	RBW=1MHz, VBW=3MHz, Span=0Hz, Detector=Peak
Limit:	0.4 Second

11.1 Test Setup



11.2 Test procedure

1. Remove the antenna from the EUT and then connect a low RF cable from the antenna port to the spectrum.
2. Set spectrum analyzer span = 0Hz;
3. Set RBW = 1MHz and VBW = 3MHz. Sweep = as necessary to capture the entire dwell time per hopping channel. Set the EUT for DH5, DH3 and DH1 packet transmitting.
4. Use the marker-delta function to determine the dwell time. If this value varies with different modes of operation (e.g.. data rate. modulation format. etc.). repeat this test for each variation. The limit is specified in one of the subparagraphs of this Section. Submit this plot(s).

11.3 DEVIATION FROM STANDARD

No deviation.



11.4 Test Result

Mode	Frequency (MHz)	Pulse Time (ms)	Total Dwell Time (ms)	Burst Count	Period Time (ms)	Limit (ms)	Verdict
1-DH1	2441	0.401	127.117	317	31600	400	Pass
1-DH3	2441	1.657	260.149	157	31600	400	Pass
1-DH5	2441	2.903	296.106	102	31600	400	Pass
2-DH1	2441	0.409	129.653	317	31600	400	Pass
2-DH3	2441	1.662	274.23	165	31600	400	Pass
2-DH5	2441	2.909	253.083	87	31600	400	Pass
3-DH1	2441	0.412	130.604	317	31600	400	Pass
3-DH3	2441	1.662	249.3	150	31600	400	Pass
3-DH5	2441	2.912	297.024	102	31600	400	Pass

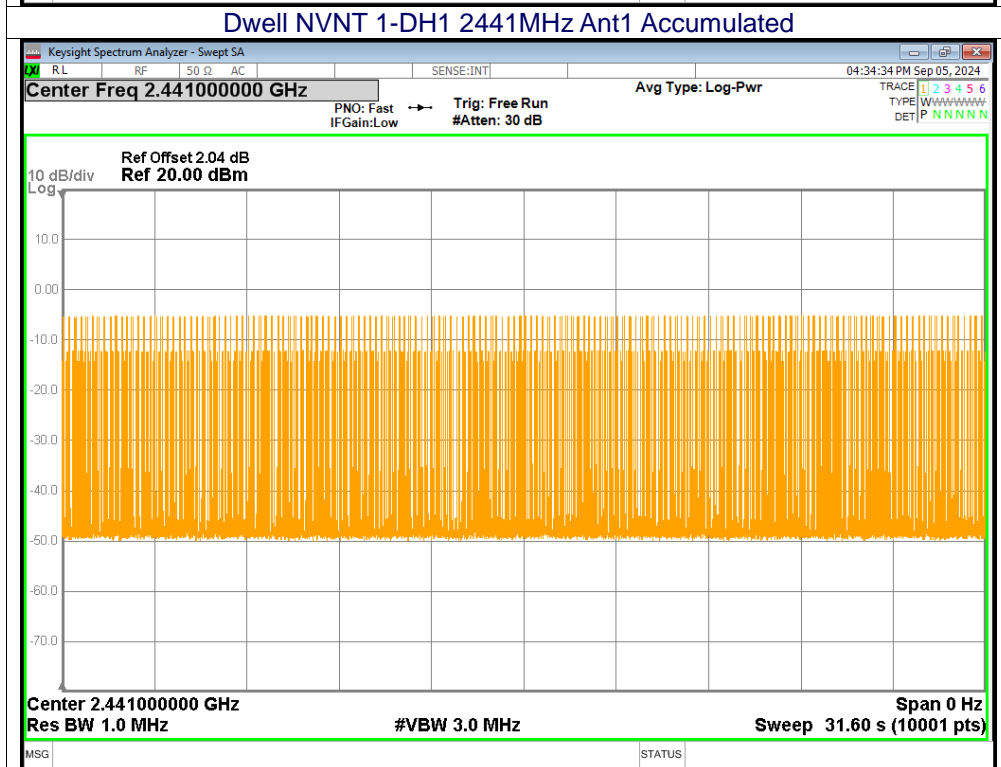
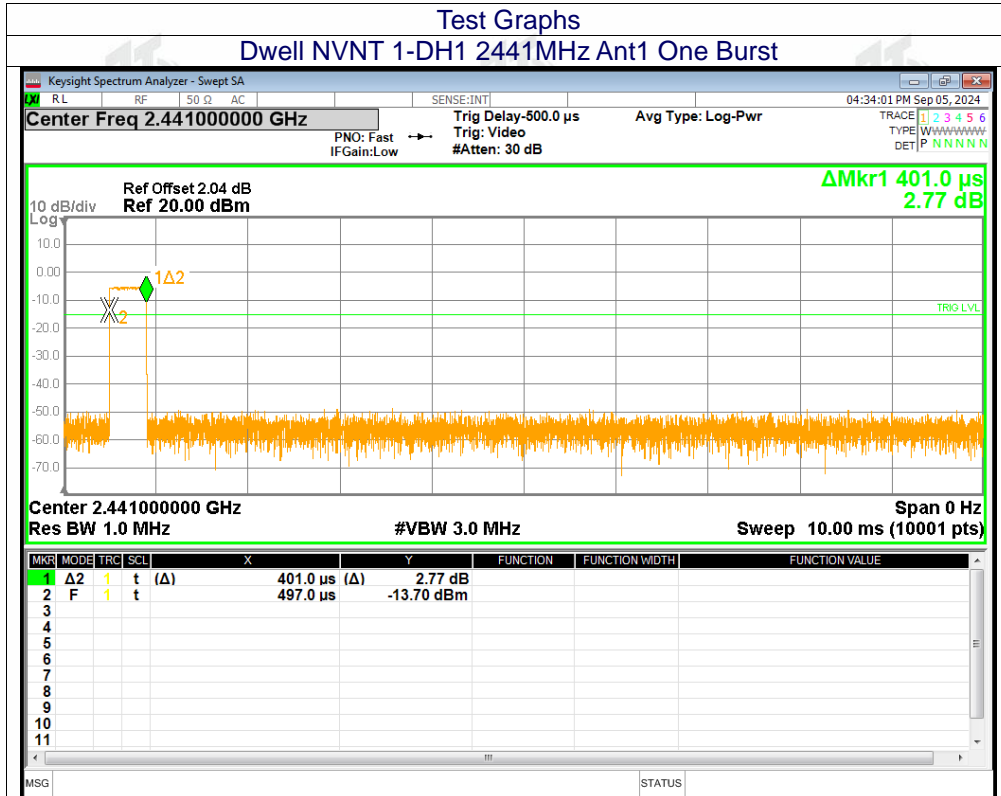

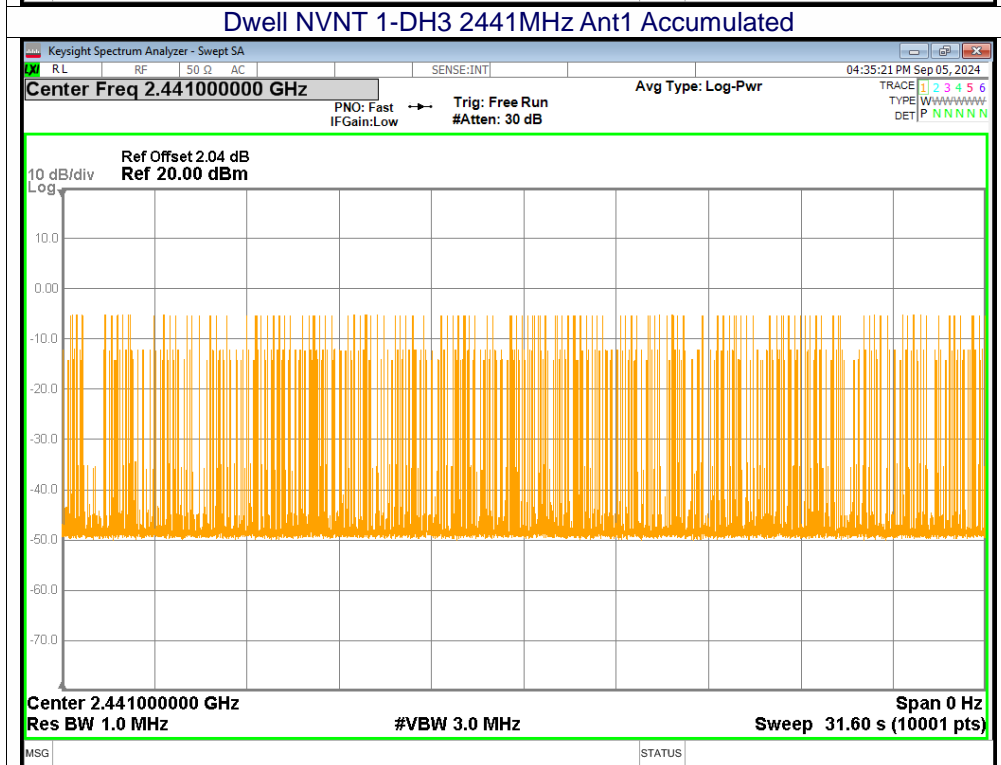
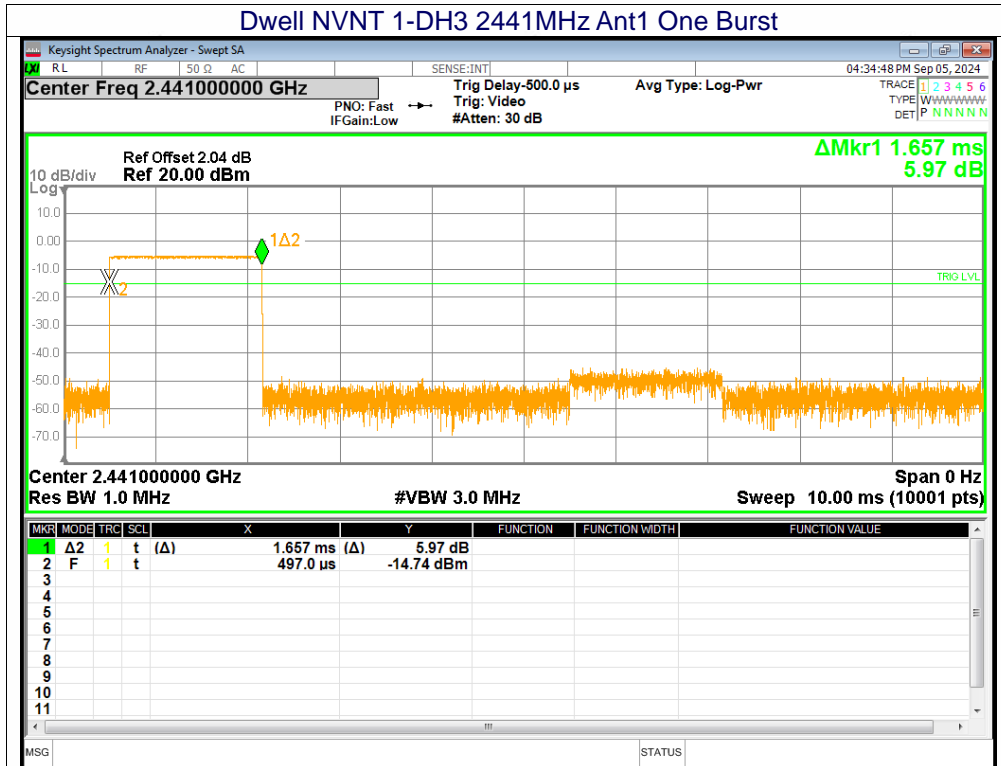

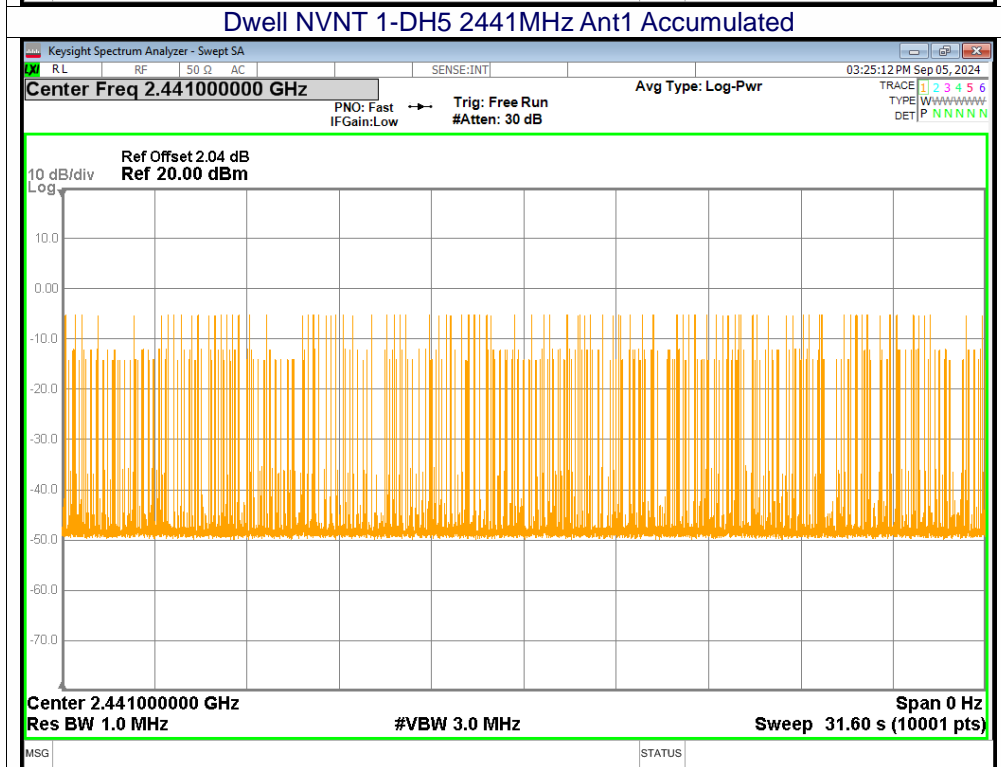
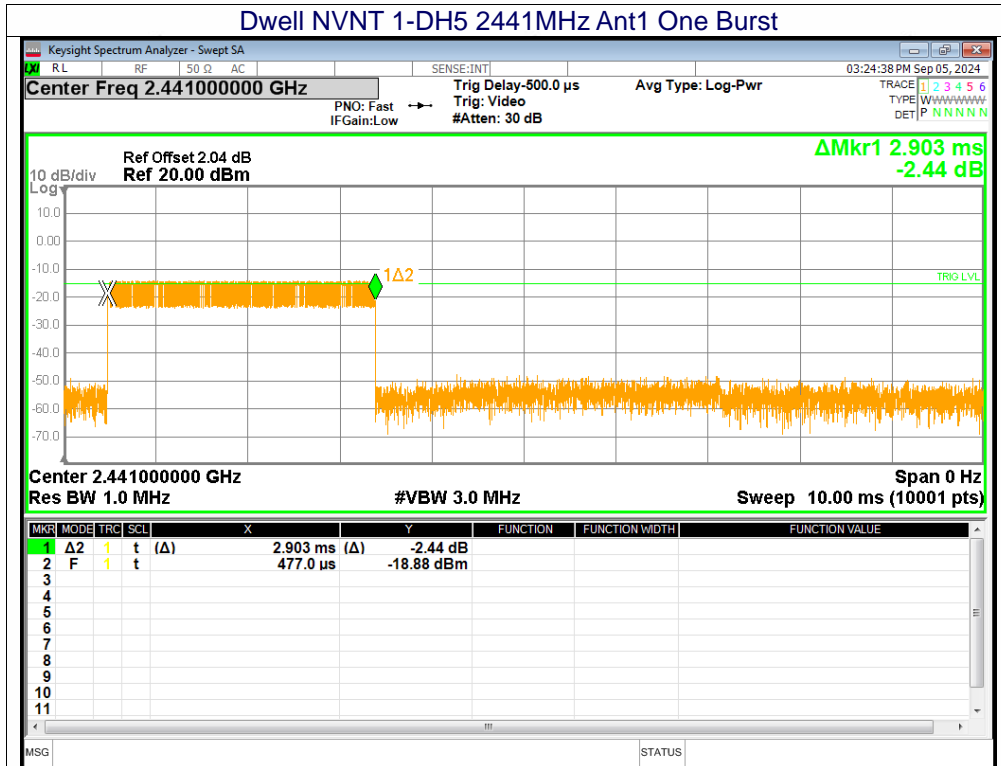

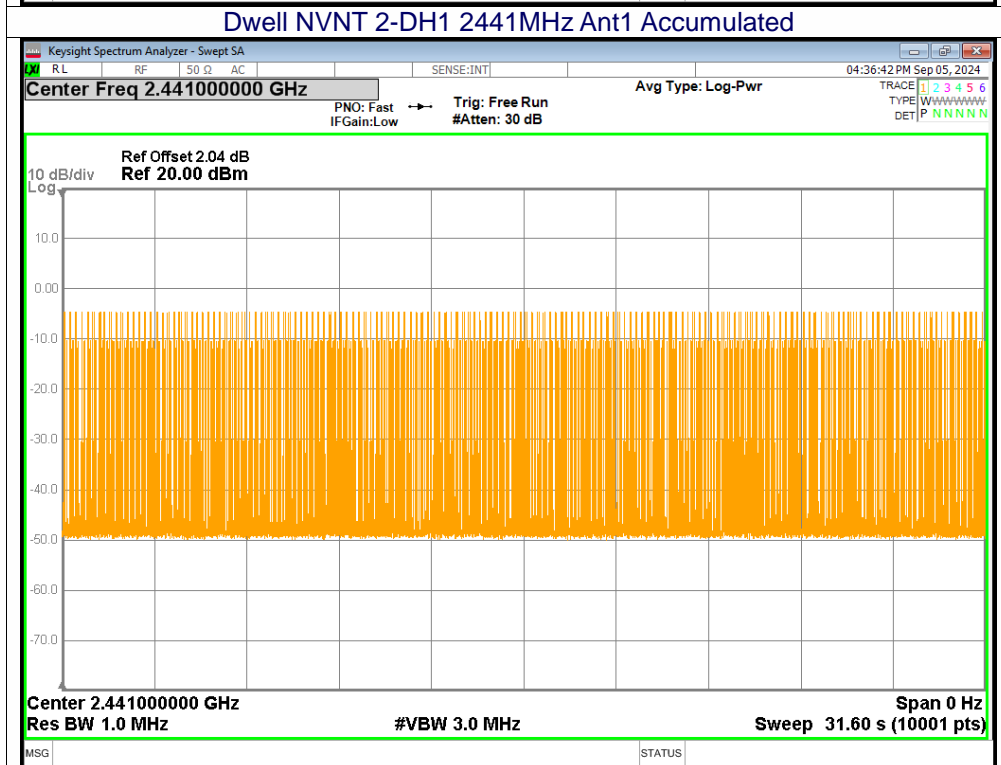
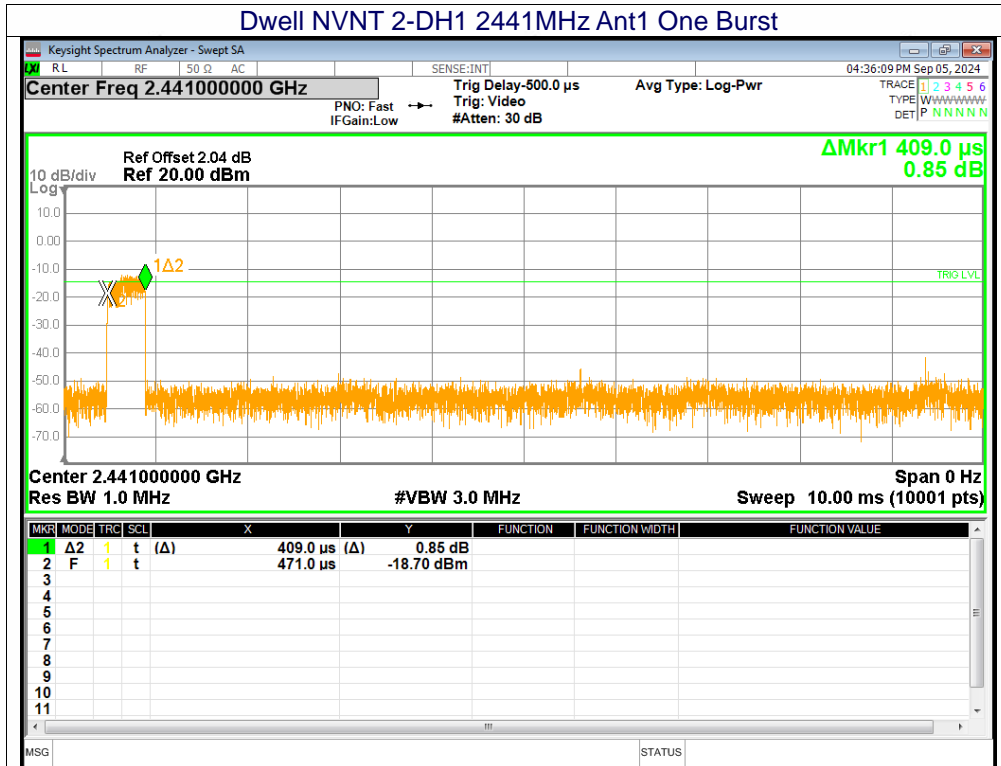

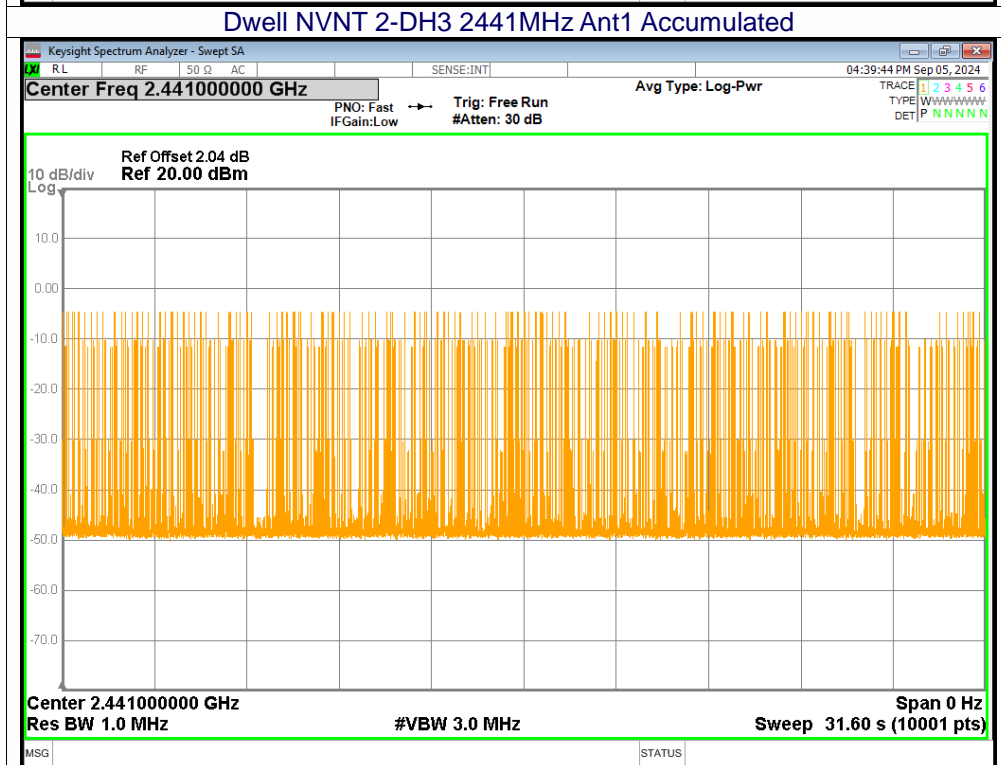
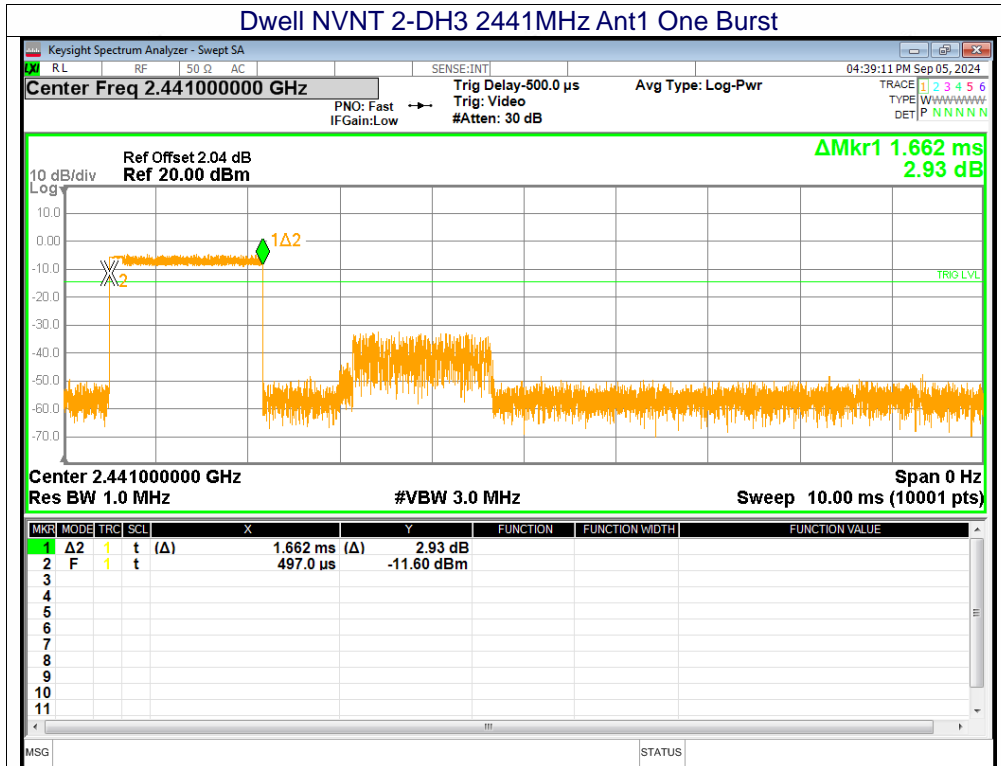

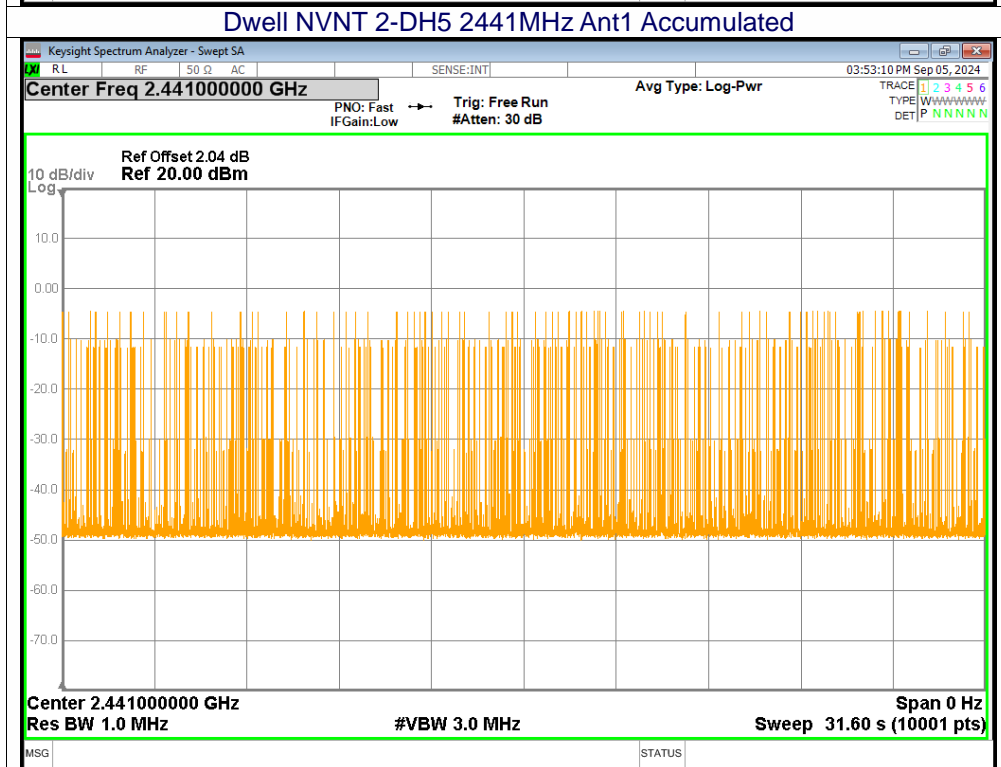
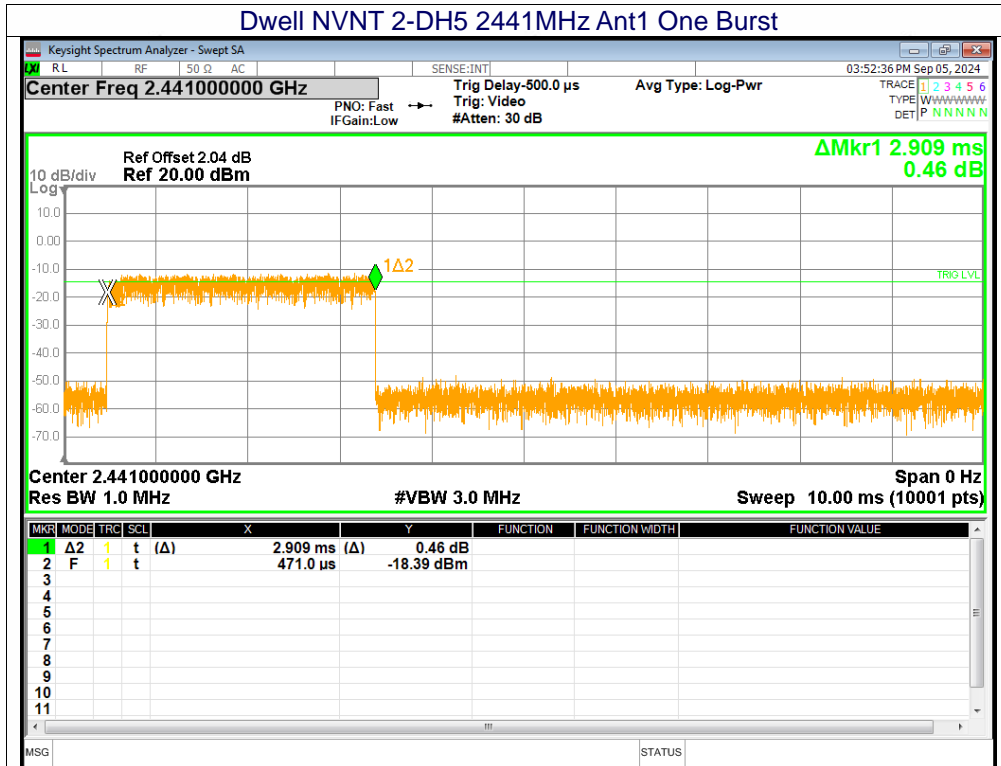

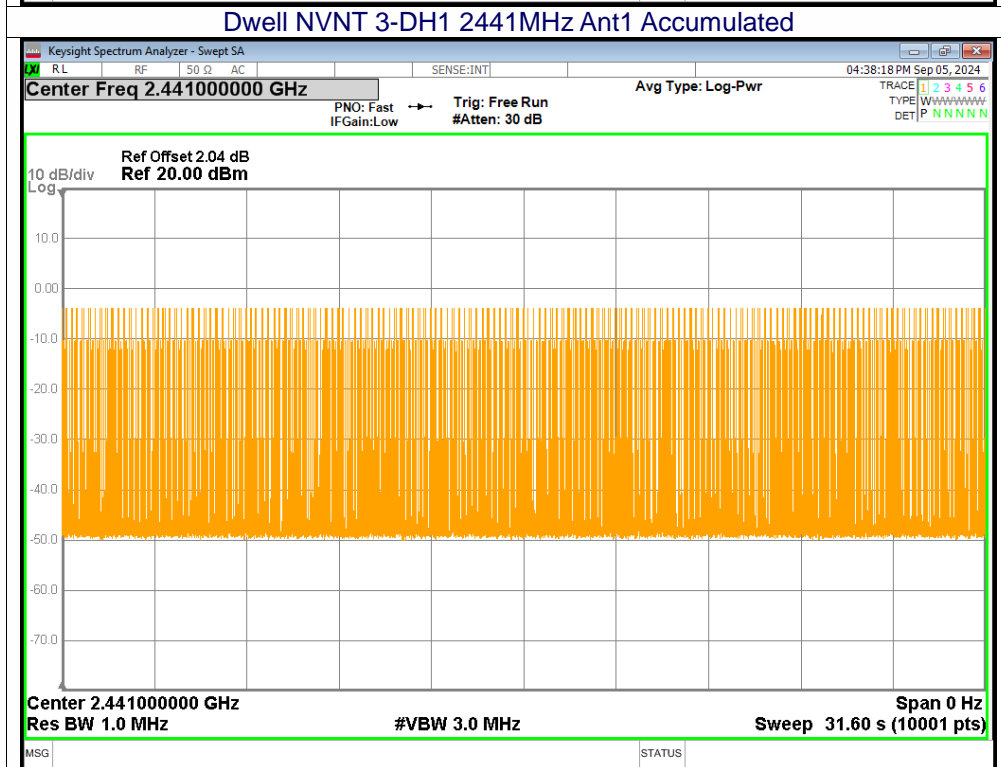
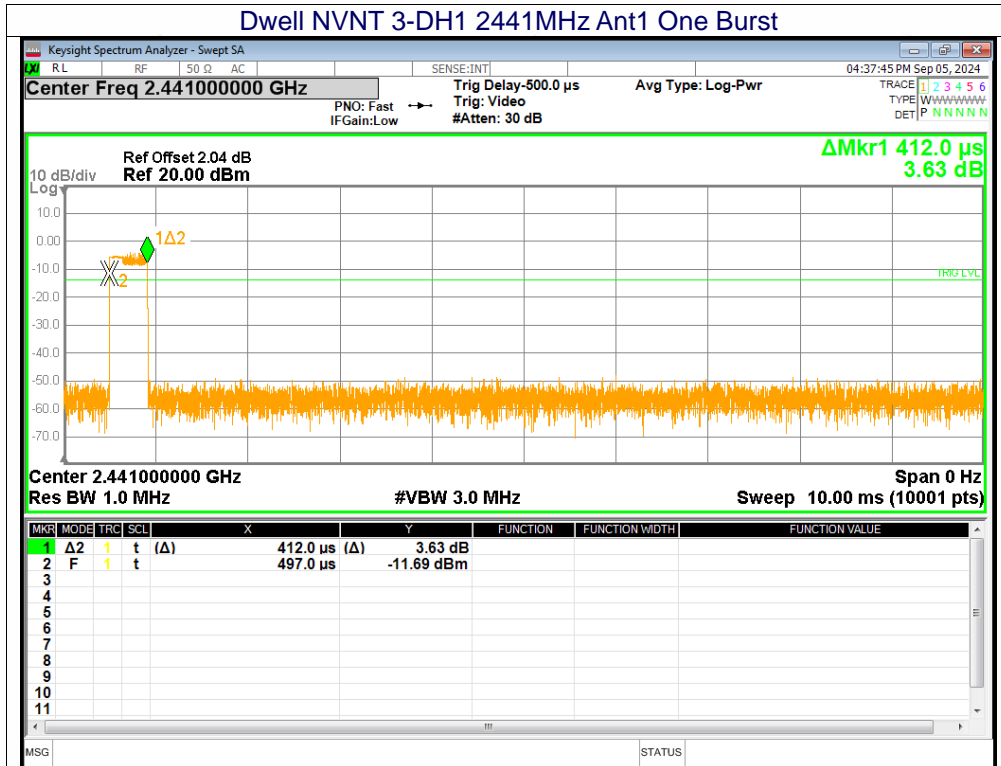

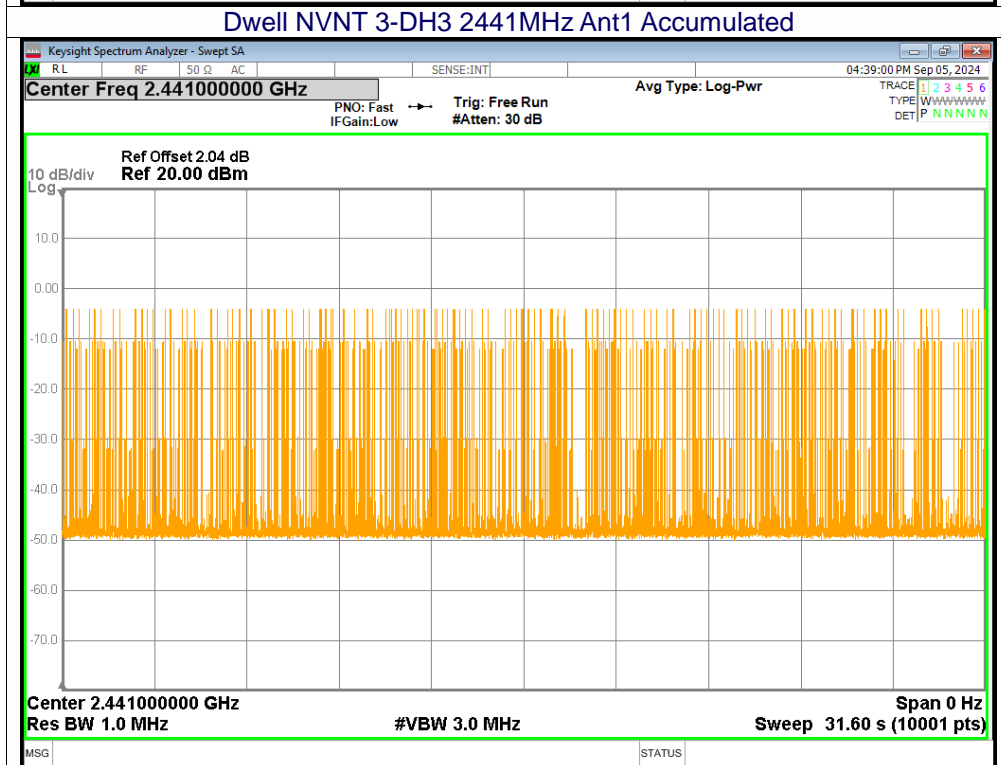
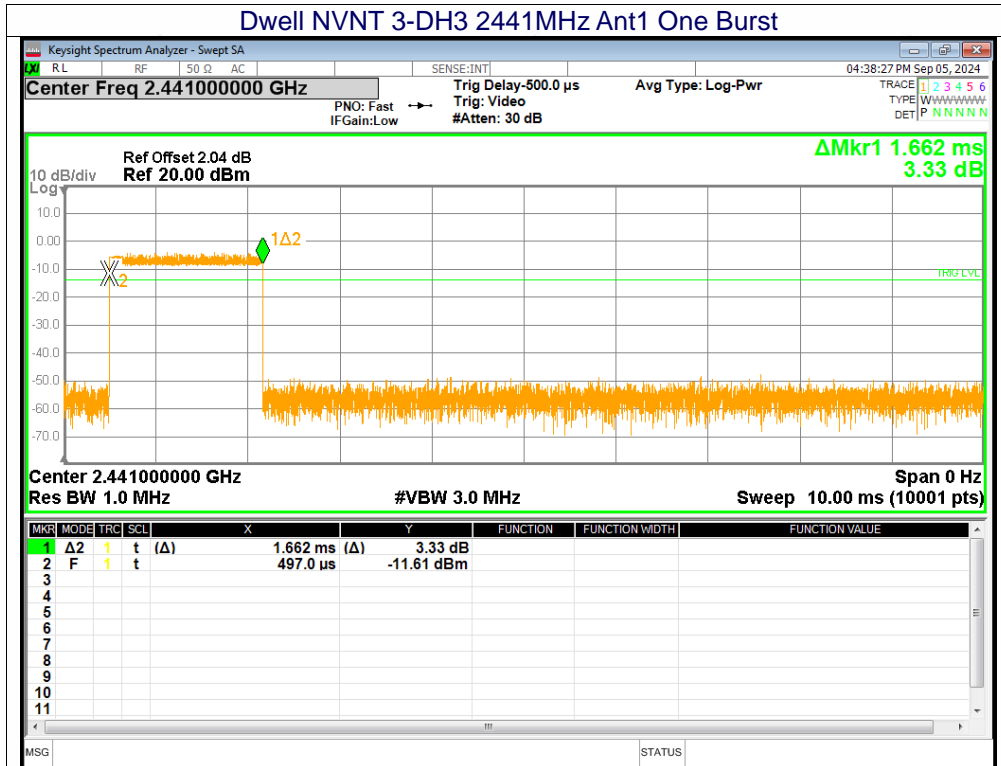

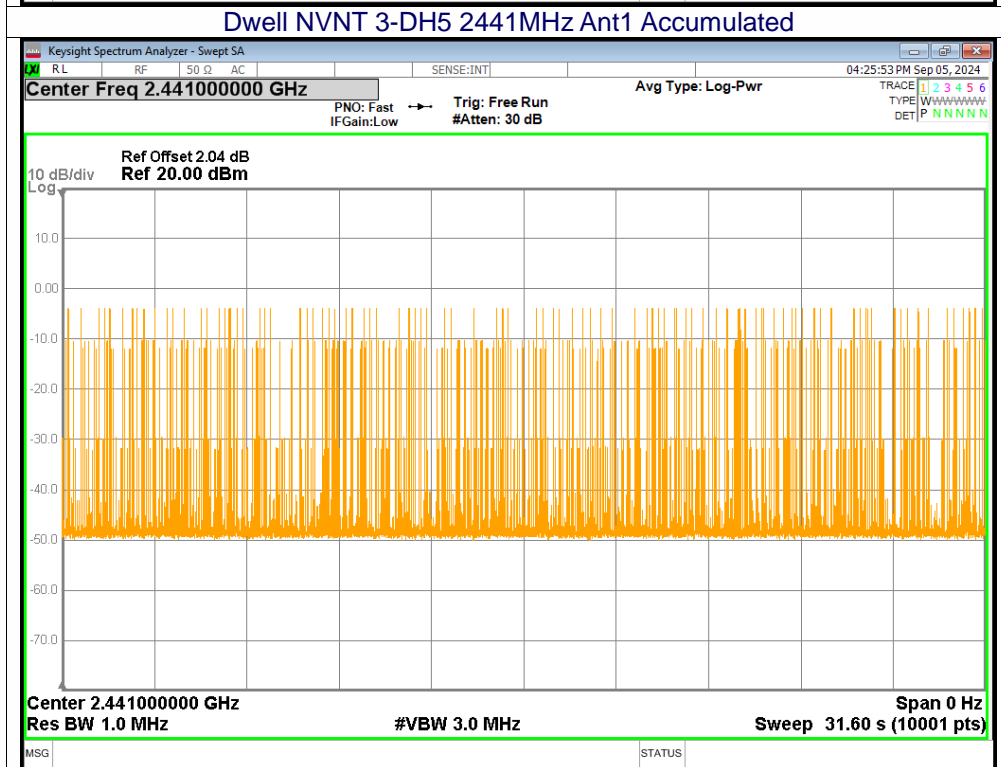
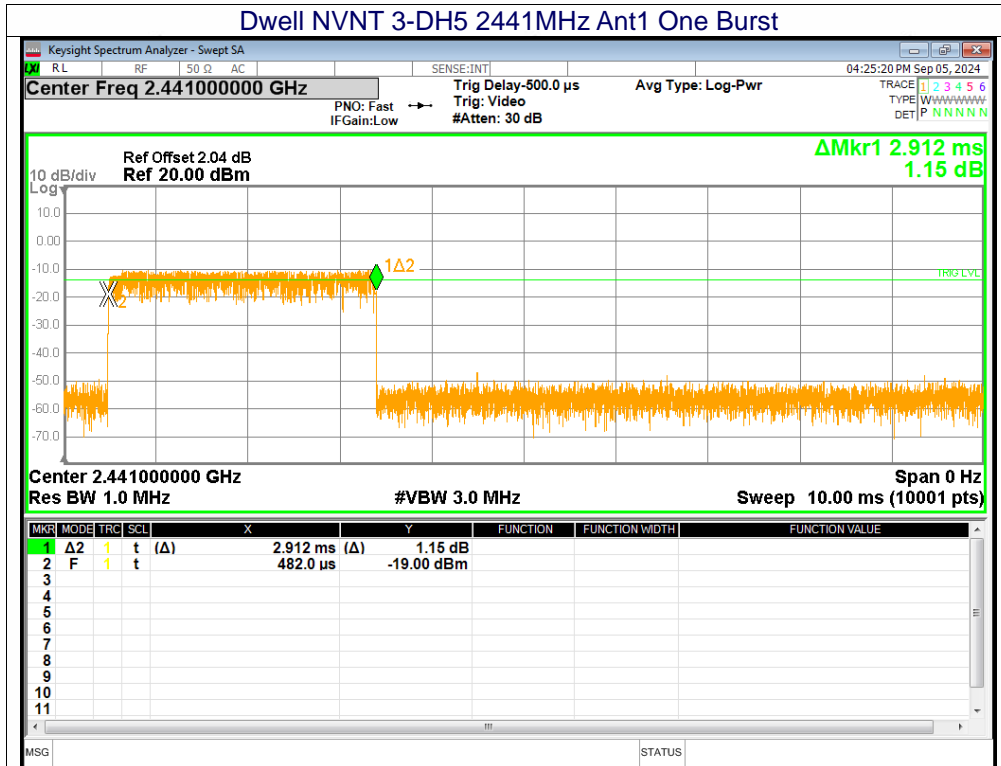



12. Antenna Requirement

Standard requirement:	FCC Part15 C Section 15.203 /247(b)(4), RSS-Gen 6.8
<p>15.203 requirement: An intentional radiator shall be designed to ensure that no antenna other than that furnished by the responsible party shall be used with the device. The use of a permanently attached antenna or of an antenna that uses a unique coupling to the intentional radiator, the manufacturer may design the unit so that a broken antenna can be replaced by the user, but the use of a standard antenna jack or electrical connector is prohibited.</p> <p>15.247(b) (4) requirement: The conducted output power limit specified in paragraph (b) of this section is based on the use of antennas with directional gains that do not exceed 6 dBi. Except as shown in paragraph (c) of this section, if transmitting antennas of directional gain greater than 6 dBi are used, the conducted output power from the intentional radiator shall be reduced below the stated values in paragraphs (b)(1), (b)(2), and (b)(3) of this section, as appropriate, by the amount in dB that the directional gain of the antenna exceeds 6 dBi.</p> <p>The applicant for equipment certification, as per RSP-100, must provide a list of all antenna types that may be used with the licence-exempt transmitter, indicating the maximum permissible antenna gain (in dBi) and the required impedance for each antenna. Licence-exempt transmitters that have received equipment certification may operate with different types of antennas. However, it is not permissible to exceed the maximum equivalent isotropically radiated power (EIRP) limits specified in the applicable standard (RSS) for the licence-exempt apparatus. Testing shall be performed using the highest gain antenna of each combination of licence-exempt transmitter and antenna type, with the transmitter output power set at the maximum level.9 When a measurement at the antenna connector is used to determine RF output power, the effective gain of the device's antenna shall be stated, based on a measurement or on data from the antenna manufacturer.</p>	
EUT Antenna:	
The antenna is PCB antenna, the best case gain of the antennas is 1.52dBi, reference to the appendix II for details	



13. Test Setup Photo

Reference to the appendix I for details.

14. EUT Constructional Details

Reference to the appendix II for details.

***** END OF REPORT *****