

Antenna Specifications

1. Model number: RC- G25-7.7~8.0UH-3300GS-7MM

2. Manufacture:

Dongguan Ceris Technology Co., LTD

152 Wanchang Road Section, Taigongling Village, Dalingshan Town, Dongguan City

3. Floor plan: unit: MM

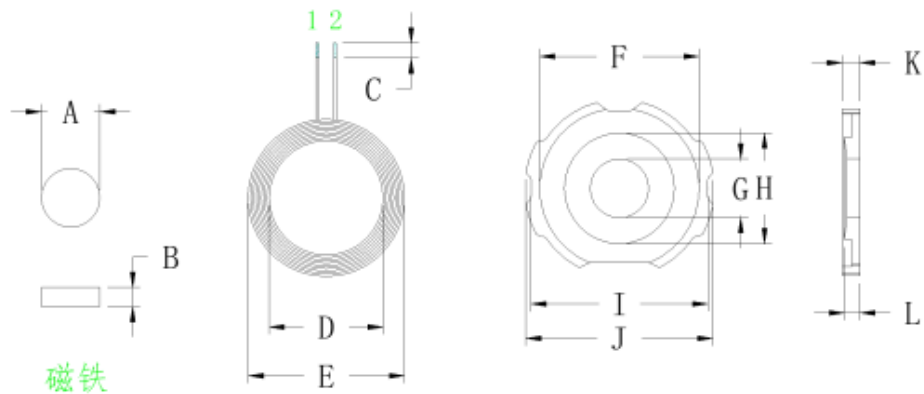

A	7.7 ± 0.05
B	2.5 ± 0.1
C	2 ± 1
D	14 ± 0.2
E	20.5 ± 0.5
F	2.1 ± 0.2
G	7.7 ± 0.1
H	13.5 ± 0.2
I	23.5 ± 0.3
J	25 ± 0.3
K	2.55 ± 0.1
L	2.3 ± 1 中柱高度
M	7 ± 1

4. Product parameters

Antenna Gain: 0dBi

Line diameter: 0.08*24P

Number of turns: 7

