

600W Power Station

portable

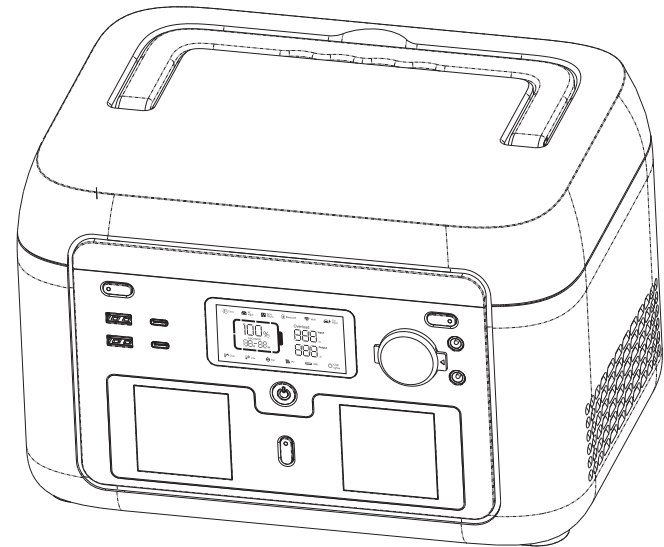

User Manual

Content

1. Parameters	1
2. Safety guidelines	
2.1 Warning	2
2.2 Discard	3
3. Guideline for users	
3.1 Product overview	3
3.2 LCD screen	4
3.3 Use	5
3.4 AC charging	7
3.5 PV charging	7
3.6 Car charging	8
3.7 Constant power	8
3.8 APP	8
3.9 EPS function	9
4. FAQs (Frequently Asked Questions)	9
5. Error messages & solutions	10
6. What's in the box	12
7. Maintenance	12
8. Disclaimer	13

1. Parameters

General

Net weight	≈7kg (≈15lbs)
Dimension	301x227x193mm (11.8x8.9x7.6in)
Battery capacity	512Wh, 25.6V \approx , 20Ah
Wi-Fi	supported

Output

(UK/EU/FR/AU/ZA)

AC socket x2 (Inverter mode)	pure sine-wave, total 600W (peak 1000W), 220-240V~, 50Hz/60Hz, 3A
AC socket (Bypass mode)	220-240V~, 50Hz/60Hz, 600W Max., 3A

(US)

AC socket x2 (Inverter mode)	pure sine-wave, total 600W (peak 1000W), 100-120V~, 60Hz, 6A
AC socket (Bypass mode)	100-120V~, 60Hz, 600W Max., 6A

USB-A1/A2	5V \approx 2.4A, 12W Max.
USB-C1/C2	5/9/12/15 \approx 3A, 20V \approx 5A, 100W Max.
Car charger	12.6V \approx 10A, 126W Max.
DC5521 output x2	12.6V \approx 3A

* Car charge and DC5521 share power, 126W Max.

* Inverter mode: the output AC power comes from the battery, not the grid.

* Bypass mode: the output AC power comes from the grid, not the battery.

Input

(UK/EU/FR/AU/ZA)

AC input power	1200W Max., 6A
AC input voltage	220-240V~, 50Hz/60Hz

(US)

AC input power	1200W Max., 10A
AC input voltage	100-120V~, 60Hz

PV charge	200W Max., 12-20V \approx 10A
Car charging input	12V battery supported, 8A by default

Input charging

AC charging power	600W Max.
PV / Car charging power	200W Max.
AC+PV charging power	600W Max.

Battery

Cell Type	lithium iron phosphate battery (LiFePO ₄)
Life cycle	3000 cycles
Protection type	over temperature protection, low temperature protection, over discharge protection, over charge protection, over load protection, short circuit protection, over current protection

*Test conditions: 95% DOD, 0.5C charge & 1.0C discharge at +25±3°C.

Operating temperature

Optimal operating temperature	20°C~30°C (68°F~86°F)
Discharge temperature range	-20°C~45°C (-4°F~113°F)
Charge temperature range	0°C~45°C (32°F~113°F)
Storage ambient temperature	-20°C~45°C (20°C~30°C preferred) [-4°F~113°F(68°F~86°F preferred)]

*Whether the product can be charged or discharged is subject to the actual battery pack temperature.

2. Safety guidelines

2.1 Warning

- Do not let a working power station be close to the heat source, such as fire or heater.
- Do not make power station contact with any liquid.
- Do not use power station in a strong electrostatic or strong magnetic field environment.
- Do not disassemble power station in any way or pierce it with a sharp object.
- Do not short power station by wire or other metal objects.
- It is forbidden to step on, sit or climb on this product.
- Do not use ingenuine parts or accessories. For part or accessory replacement, please visit official sales channel for purchase information.
- When using power station, please follow the operating temperature defined in this user manual strictly. If the temperature is too high, battery may catch fire or even explode. If the temperature is too low, power station performance will be seriously impaired, even normal use will be impacted.
- Do not stack heavy objects on power station.
- Do not stop the fan by force or expose power station in an unventilated or dusty environment when it is working.
- Please avoid collision, drop, and violent vibration. If severe impact happens, shut down the power supply immediately. Please fix power station firmly during transportation to avoid vibration and impact.
- If power station falls into water accidentally, place it in a safe and wide area, and keep yourself away from it until it's dry. Dried product shall not be used again. Dispose it properly according to chapter 2.2 in this user manual. If power station is on fire, please use fire extinguishing equipment in the recommended order: water or water mist, sand, fire blanket, dry powder, dioxide carbon fire extinguisher.
- If there is dirt, use a dry cloth to wipe it.
- Place power station carefully to prevent damage. If power station is tipped over and seriously damaged, turn off power station immediately and place the battery in a spacious place and keep it away from flammable materials and people, and scrap it in accordance with the requirements of local laws and regulations.
- Keep power station out of the reach of children and pets.
- Keep power station in a dry and ventilated place.
- In humid environment (seaside, water, etc.), it is recommended to equip power station with moisture-proof bag. If water is found inside product, do not use/start it again. Please take countermeasures to prevent electric shock before touching power station. Put it in a safe and waterproof open area, and contact customer service immediately.
- It is not recommended to use power station to supply power for safety-related emergency medical equipment, including but not limited to medical grade breathing machine (hospital version CPAP: Continuous Positive Airway Pressure), artificial lung (ECMO, Extracorporeal Membrane Oxygenation). It can be used to supply power for home version CPAP at home and does not require continuous professional monitoring. Please follow your doctor's advice and consult the manufacturer for any restrictions on the use of the device. For general medical equipment, please pay attention to the power condition to ensure that power does not run out.
- Power supplies will inevitably generate electromagnetic fields when it is in use, which might affect the implantable medical device or normal operation of personal medical device, such as pacemaker devices, cochlear implants, hearing AIDS, defibrillators, etc. If any of these medical devices are used, please consult the manufacturer about the restrictions on the use to ensure that power station is operated at a safe distance from implanted medical devices such as pacemakers, cochlear implants, hearing AIDS, defibrillators, etc.

19. Power supplies will inevitably generate electromagnetic fields when it is in use, which might affect the implantable medical device or normal operation of personal medical device, such as pacemaker devices, cochlear implants, hearing AIDS, defibrillators, etc. If any of these medical devices are used, please consult the manufacturer about the restrictions on the use to ensure that power station is operated at a safe distance from implanted medical devices such as pacemakers, cochlear implants, hearing AIDS, defibrillators, etc.

20. When the power station is connected to a refrigerator, it may automatically shut down because of the power fluctuation property of the refrigerator. When connecting the power supply to a refrigerator that stores medicine, vaccines or other valuable items, it is recommended to set the AC output to "Never off" in the APP, so as to ensure continuous power. Users should pay attention to power consumption.

21. During the push-pull movement of this product, it is forbidden to put other items on this product.

2.2 Discard

1. Conditions permitting, be sure to discharge the battery completely, and then put power station in the specified battery recycling bin. Power station contains batteries, which are dangerous. It is strictly prohibited to discard them in ordinary dust bins. For details, follow local laws and regulations on battery recycling and disposal.

2. If the battery cannot be discharged completely due to product failure, do not discard the battery directly in the battery recycling bin. Contact a professional battery recycling company for further disposal.

3. The battery will not start after over discharge. Please dispose it as discarded.

3. Guideline for users

3.1 Product overview

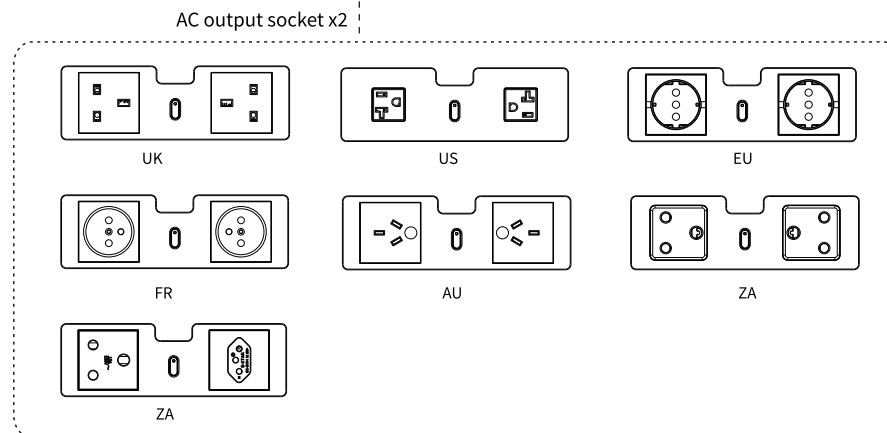
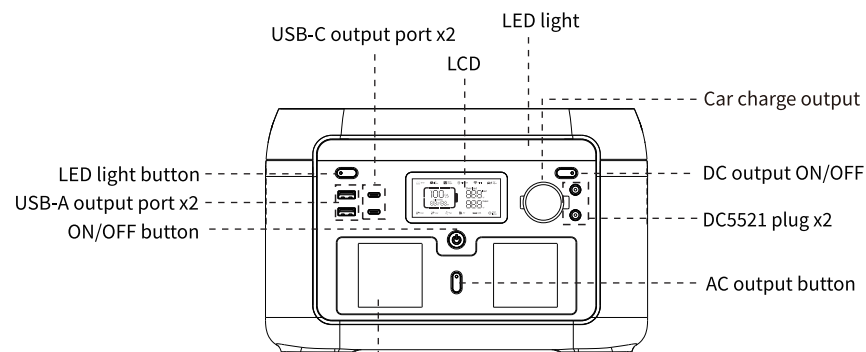

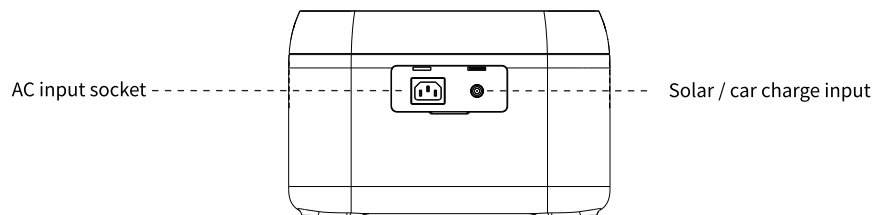
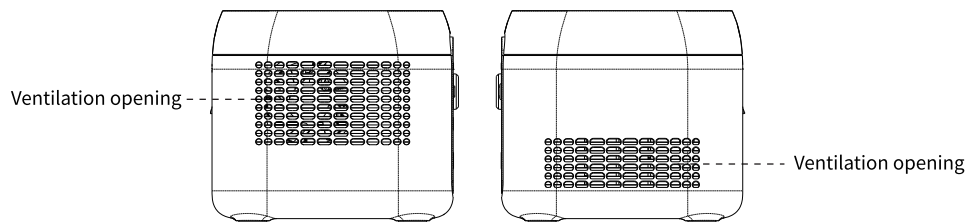

3.2 LCD screen

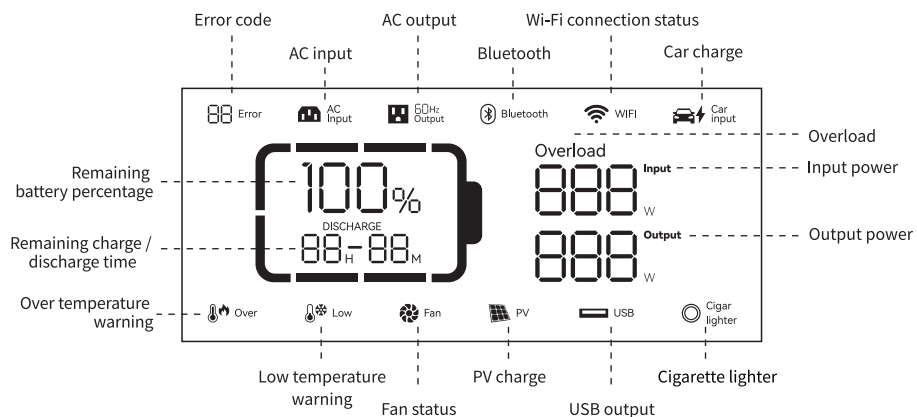

Battery capacity: When power station is being charged, SOC icon will flicker.



Wi-Fi connection status: The flickering icon indicates that power station is ready for pairing. The icon will keep flickering if a mobile phone and power station are connected by hotspot. After network connection succeeds, the icon will always be on. If connection fails, the icon will be off.

* Please refer to clause 5 for more details regarding error message.

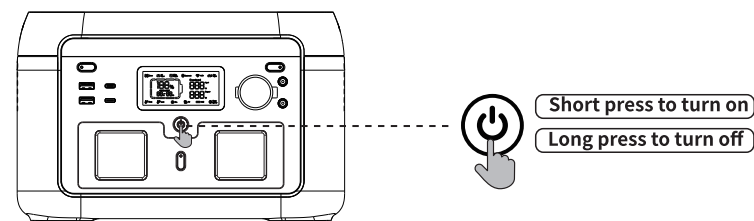

3.3 Use

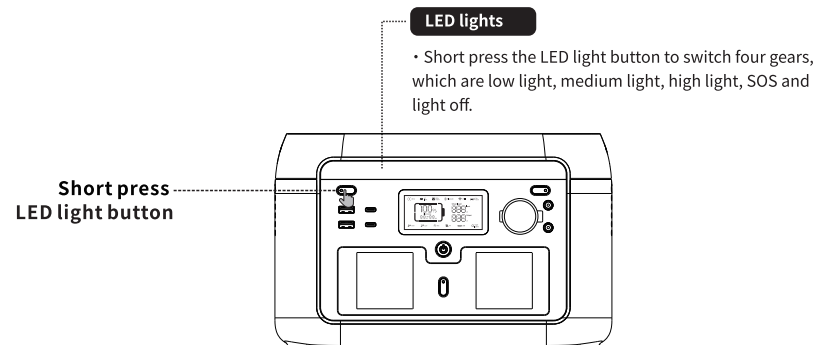

On and off

- Press the main power switch to turn on the device, then the screen will be lit and the main power indicator will enter the breathing light mode.
- If no operation is performed to power station for 5 minutes, power station will enter hibernation state and the LCD will automatically turn off. When there is load change or operation to power station, the LCD screen will be automatically lit. Press the main power switch to turn on or turn off the LCD.
- Press and hold the main power switch will turn off power station.
- In the normal mode (the power is above 5%), the default standby time of this product is 2 hours; when the AC output switch is not turned on, and there is no charge or discharge for 2 hours, the product will automatically shut down, and the standby time can be Set it on the APP; when the power is 5% or below, the product will be forced to enter the low power mode. In the case of no charge or discharge, the product will adjust the standby time according to the power and automatically shut down.
- In normal mode, long press the LED light button to exit the automatic shutdown setting, and the battery icon  on the screen will flash. Long press again to enter the automatic shutdown setting, and the battery icon  does not flash. (The automatic shutdown setting is to protect the battery from low power, exiting this setting may damage the battery life, please use it with caution.)



Note: When no AC input, long press the above AC output button, you can switch the AC off-grid output frequency ( / ), long press 2s to switch, the AC output icon will flash 3 times after successful switching.

- After the main power switch is turned on, press the 12V DC output power switch to enable the DC output port.
- Press the 12V DC output power switch again to turn it off.
- When the 12V DC output power switch is turned on, power station does not shut down automatically.

USB output

USB output is enabled by default after the main power switch is turned on.

12V DC output

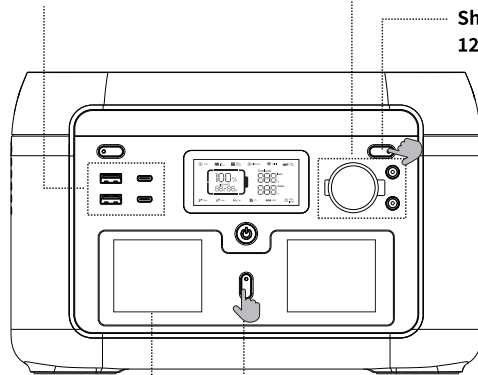

Short press
12V DC output power switch

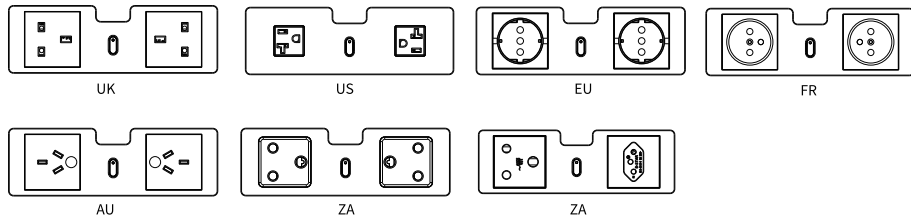

Short press AC output power switch



AC output

- After ensuring that the main power is turned on, short press the AC output power switch to turn on the AC output. Short press the AC output power switch again to turn it off.
- The default standby time of the AC output port is 1 hour. After 1 hour without any load on the AC output port of this product, the AC output power will be automatically turned off. In normal mode, long press the LED light button, the AC output power switch can exit the automatic shutdown setting, and the battery icon  on the screen will flash. Long press again, the AC output power switch enters the automatic shutdown setting, and the battery icon  does not flash.
- Long press the LED light button to exit the AC automatic shutdown setting: it is applicable to AC equipment below 10W and pulse working equipment.
- When the AC output is not in use, turn it off to save power consumption.

3.4 AC charging

When the product is turned on, the default fast charging mode is working. If your product has a wifi function, you can control the recharge rate through the APP.

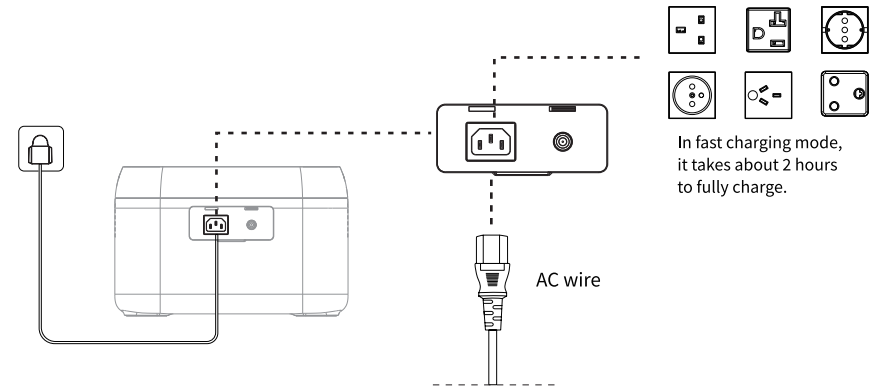

Please use the standard AC cable for charging. AC charging cable should directly plug into 10A (or above) wall-mounted socket. We take no responsibilities for any damage caused by using unofficial AC charging cable, and other failures to follow instructions.

3.5 PV charging

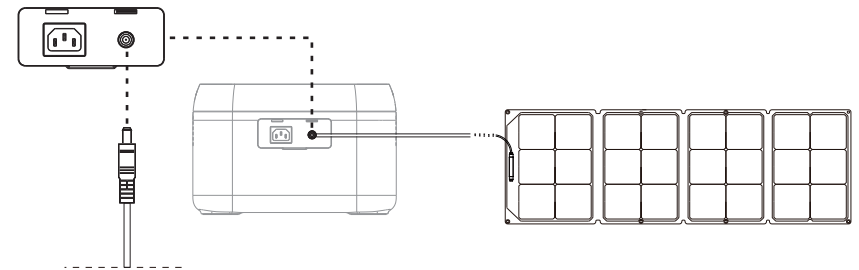

Charge the power station by solar panel.

*Solar charging cable (DC7909)

- Please follow the user manual to connect the solar panels.
- Before connecting the solar panel, check whether its output voltage is within power station specifications to avoid damage to power station.
- *The interface of this product is DC7909. If you need an adapter cable from MC4 to DC7909, please purchase it yourself.

3.6 Car charging

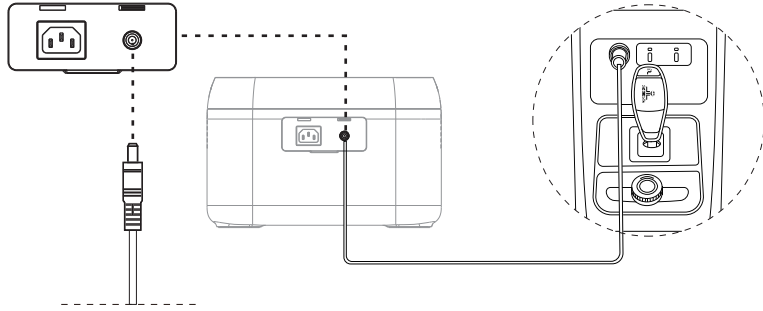

*Car charger cable (DC7909)

Power station can be charged by a car charging port. It should be charged after the car starts, so as to avoid the car battery loss and failure to start. At the same time, ensure good connection between the car charging port and cigarette lighter. We take no responsibilities for any loss caused by improper operation.

3.7 Constant power

1. The constant power output function is not enabled by default, which can be turned on or off by App.
2. In the following cases, constant power output function is not enabled:
 - (1) AC output turned on in charging status (bypass mode).
 - (2) Constant power output turned off.
3. Constant power output function is more suitable for heater and motor instead of all electrical equipment. It is not suitable for some electrical appliances with voltage protection (such as precision instruments). Constant power output function application is subject to actual testing.

3.8 APP

You can control and view information and data about this product by App.

Software download, search for [Smart Life] in the Google App Store or Apple App Store, download the software, register and open it or scan the QR code below to download. For detailed usage of the APP, please refer to the APP Operation Guide.



3.9 EPS function

This product supports the EPS (emergency backup power) function. You connect the power grid and the AC input port of this product through the AC charging cable; Bypass mode (AC power comes from the grid, not the battery); when the grid suddenly loses power, the product can automatically switch to battery power supply mode within 10mS, at this time it is an inverter mode (AC power comes from the battery, not the grid). This function does not support 0mS switching. Please do not connect it to devices that require high uninterrupted power supply, such as data servers and workstations, or use it after multiple tests to confirm whether it is compatible, and It is recommended to use only one device during use, and do not use multiple devices at the same time to avoid overload protection of the product. If the device does not operate normally or data is lost due to failure to follow the instructions, our company will not bear the corresponding responsibility.

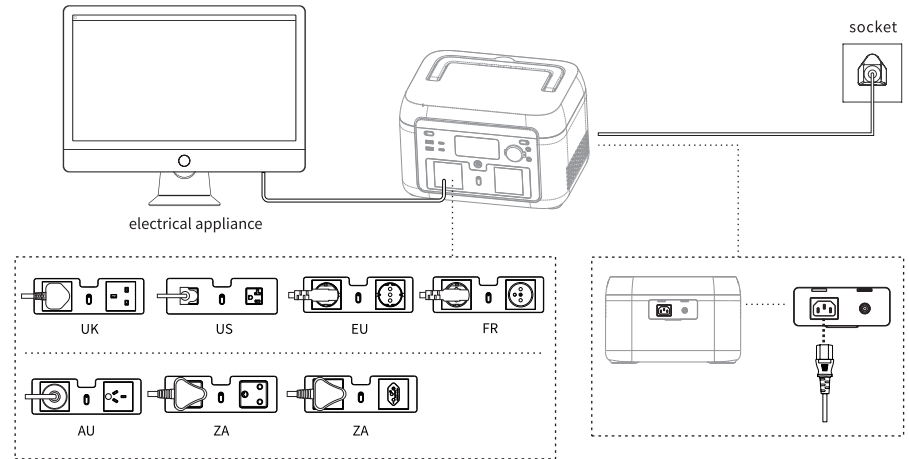

4. FAQs (Frequently Asked Questions)

1. What kind of battery is used?

Lithium iron phosphate battery (LiFePO₄).

2. What equipment can be connected to the AC output ports?

The AC output port of the product has high rated power and the highest power, which can supply power for small power household equipment. We suggest confirming the power of the equipment before use to ensure that the sum of the power of all load equipment is lower than the rated power.

3. How to know the supply time?

Time shows in the LCD, which can be referred to for estimation for equipment with stable power consumption.

4. How to know it is charging?

When in charge, the LCD shows remaining charging time. The SOC flickers, and input power is shown.

5. How to clean the unit?

Clean the unit with a dry, soft and clean cloth or tissue.



6. How to store the unit?

Turn it off, and keep it in a dry and ventilated place. Do not expose it close to water. For long-term storage, suggest discharge to 0% and charge to 100% every 3 months to extend the service life.

7. Can it be taken on board?



No.

5. Error messages & solutions

Icon	Fault Description	Solution
02 Error Error code always on	Pressure difference is too large	Automatic recovery after fault clearing; 3 consecutive locks within a certain period of time, longer recovery time.
 Over 04 Error High temperature icon flickers Error code always on	Battery OTP (over temperature protection) fault	Shut down, after temperature recovery, rechargeable activation.
 Low 05 Error Low temperature icon flickers Error code always on	Battery UTP (under temperature protection) fault	
06 Error Error code always on	OCP (over current protection) fault	Remove the over-power device, and it will automatically recover after the fault is cleared; if it is triggered continuously for 3 times within 1 minute, it will be locked, and the recovery time will be prolonged, and it can be recovered by powering on and off again.
08 Error Error code always on	Abnormal precharge	Power on and off again to clear the fault.
09 Error Error code always on	Battery under voltage fault	charging process, Repeated charging failures or failure to charge, please contact customer service.
11 Error Error code always on	Abnormal INV battery voltage	Automatic recovery after the fault is cleared; if it is triggered 3 times within 1 minute, it will be locked, and the recovery time will be extended, and it can be recovered by powering on and off again.
12 Error Error code always on	Grid voltage or frequency fault	The fault is cleared when the grid returns to normal.
13 Error Error code always on	Abnormal INV BUS voltage	Automatic recovery after the fault is cleared; if it is triggered 3 times within 1 minute, it will be locked, and the recovery time will be extended, and it can be recovered by powering on and off again.
14 Error Error code always on	Abnormal INV output	
Overload 15 Error Overload icon always on Error code always on	INV discharge overload	Remove the over-power device, and it will automatically recover after the fault is cleared; if it is triggered continuously for 3 times within 1 minute, it will be locked, and the recovery time will be prolonged, and it can be recovered by powering on and off again.
Overload 16 Error Overload icon always on Error code always on	Charge overload	Automatic recovery after the fault is cleared; if it is triggered 3 times within 1 minute, it will be locked, and the recovery time will be extended, and it can be recovered by powering on and off again.

If there is a warning occurs during the use of this product, and the warning icon still does not disappear after restarting the device, please stop using it immediately (do not try to charge or discharge).

5. Error messages & solutions

Icon	Fault Description	Solution
17 Error Error code always on	INV Tz	Auto recover after fault is cleared.
19 Error Error code always on	INV output short	Fault will be cleared after reboot.
 Over 20 Error High temperature icon flickers Error code always on	MOSFET OTP fault	After removing the device and restarting, the fault is cleared.
21 Error Error code always on	Fan stop	Exclude the fan abnormality, turn on and off, contact after sales if still not fixed.
22 Error Error code always on	Discharge soft start fault	Auto recover after fault is cleared.
23 Error Error code always on	Charge soft start fault	Automatic recovery after the fault is cleared; if it is triggered 3 times within 1 minute, it will be locked, and the recovery time will be extended, and it can be recovered by powering on and off again.
24 Error Error code always on	MOSFET UTP fault	Automatic recovery after the product heats up.
27 Error Error code always on	PV hardware OCP fault	Remove PV charge, auto recover after connecting PV and turn on.
28 Error Error code always on	PV1 software OCP fault	Stop PV1 charging, auto recover after connecting PV and turn on.
30 Error Error code always on	Car charge output OCP fault	Turn off output, manual recover after fault is cleared.
31 Error Error code always on	PV input OVP (over voltage protection) fault	PV charging does not work, return to normal working range, fault cleared.
 Over 35 Error High temperature icon flickers Error code always on	PV1 OTP fault	Stop PV1. Auto recover after fault is cleared.
38 Error Error code always on	Abnormal communication	Turn on and off, or change operation environment. Contact after sales if still not fixed.

If none of the above information can solve problem you encounter, please contact the customer service for consultation.

6. What's in the box

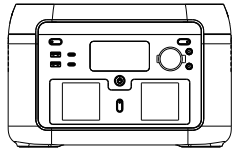

Power station

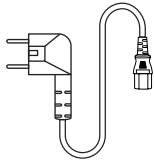

AC cable

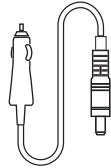

Car charge cable

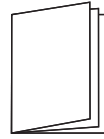

User manual

7. Maintenance

- It is recommended to use or store power station under 20~30°C ambient temperature. Keep it away from water, heater and metal parts.
- For long-term storage, charge and discharge every 3 months, i.e. discharge to 0% then charge to 100%.
- For safety, do not store power station with temperature above 45°C or below -10°C.
- If the capacity is lower than 1%, please charge to 60%. Long-term storage with serious power shortage will cause irreversible damage to the cell and shorten the service life of the product.
- If the capacity is seriously insufficient and idle time is too long, the product will enter deep sleep mode, and the product can only be used after being charged.

8. Disclaimer

- The product has a built-in battery management system, which has protections such as overcharge, overdischarge, overcurrent, short circuit, high and low temperature, and abnormal communication. During the use of this product, protection may occur and cause output interruption. Power supply to special equipment, such as medical equipment, server, the indirect loss caused by accidental power failure has nothing to do with the company; all accidents caused by illegal use, self-dismantling, and man-made damage have nothing to do with the company.
- Before using the power station, please read this user manual to ensure understanding and proper use. After reading the user manual, please keep it well for future reference. Improper operation may cause serious injury to yourself or others, or result in product damage and property loss. Once using power station, you are deemed to have understood and accepted all terms and contents herein. Users promise to be responsible for their actions and all consequences arising therefrom. We shall not be liable for any loss arising from user's not following this user manual.
- In compliance with laws and regulations, the company reserves the right of final interpretation of this document and all related documents of this product. Subject to update, revision or termination without prior notice, please visit the official website for the latest product information.

FCC Statement

This device complies with Part 15 of the FCC Rules. Operation is subject to the following two conditions:

(1) This device may not cause harmful interference.

(2) This device must accept any interference received, including interference that may cause undesired operation.

2. Changes or modifications not expressly approved by the party responsible for compliance could void the user's authority to operate the equipment.

Note: This equipment has been tested and found to comply with the limits for a class B digital device, pursuant to Part 15 of the FCC Rules. These limits are designed to provide reasonable protection against harmful interference in a residential installation.

This equipment generates uses and can radiate radio frequency energy and, if not installed and used in accordance with the instructions, may cause harmful interference to radio communications. However, there is no guarantee that interference will not occur in a particular installation. If this equipment does cause harmful interference to radio or television reception, which can be determined by turning the equipment off and on, the user is encouraged to try to correct the interference by one or more of the following measures:

- Reorient or relocate the receiving antenna.
- Increase the separation between the equipment and receiver.
- Connect the equipment into an outlet on a circuit different from that to which the receiver is connected.
- Consult the dealer or an experienced radio/TV technician for help.

The device has been evaluated to meet general RF exposure requirement, This equipment should be installed and operated with a minimum distance of 20 cm between the radiator and your body.

ISED Statement

This device contains licence-exempt transmitter(s)/receiver(s) that comply with Innovation, Science and Economic Development Canada's licence-exempt RSS(s). Operation is subject to the following two conditions:

This device may not cause interference.

This device must accept any interference, including interference that may cause undesired operation of the device.

This equipment should be installed and operated with a minimum distance of 20 cm between the radiator and your body.

Le présent appareil est conforme aux CNR d'Industrie Canada applicables aux appareils radio exempts de licence. L'exploitation est autorisée aux deux conditions suivantes :

(1) l'appareil ne doit pas produire de brouillage, et (2) l'utilisateur de l'appareil doit accepter tout brouillage radioélectrique subi, même si le brouillage est susceptible d'en compromettre le fonctionnement. Cet équipement doit être installé et utilisé avec une distance minimale de 20 cm entre le radiateur et votre corps.