

TEST REPORT

Report No..... : KS2409S3823E
FCC ID..... : 2BBDJ-ADPT002
Applicant..... : ELevated Perceptions LLC
Address..... : 317 E. Washington Avenue Sunnyvale, CA 94086
Manufacturer..... : SHENZHEN ALONG ELECTRONICS CO., LTD.
Address..... : NO.35 XIANYUAN INDUSTRIAL PARK,GUSHU
COMMUNITY,XIXIANG,BAOAN,SHENZHEN,GUANGDONG,CHINA
SHENZHEN
Product Name..... : Audio stream adapter
Trademark..... : GameScent, MovieScent
Model/Type reference..... : ADPT002, ADPT002W
Standard..... : 47 CFR Part 15.247
Date of Receipt..... : September 02, 2024
Date of Test Date..... : September 02, 2024 to September 23, 2024
Date of issue..... : September 23, 2024
Test result..... : Pass

Conclusion..... : The submitted sample was found to COMPLY with the standards above.

Prepared by:
(Printed name + Signature) Chad Lin



Approved by:
(Printed name + Signature) Sky Dong

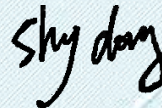

Testing Laboratory Name...: K5IGN(Guangdong) Testing Co., Ltd.

Address..... : West Side of 1/F., Building C, Zone A, Fuyuan New Factory, Jiujiu Industrial Park, Minzhu, Shatou, Shajing, Bao'an District, Shenzhen, Guangdong, China

TABLE OF CONTENTS**Page**

1. TEST SUMMARY	3
1.1. Test Standards	3
1.2. Report Version	3
1.3. Test Description	4
1.4. Test Facility	5
1.5. Measurement Uncertainty	5
2. GENERAL INFORMATION	6
2.1. General Description Of EUT	6
2.2. Accessory Equipment Information	6
2.3. Description of Test Modes	6
2.4. Operation channel list	7
2.5. Measurement Instruments List	8
3. Evaluation Results (Evaluation)	10
3.1. Antenna requirement	10
4. Radio Spectrum Matter Test Results (RF)	10
4.1. Conducted Emission at AC power line	10
4.2. Occupied Bandwidth	14
4.3. Maximum Conducted Output Power	16
4.4. Power Spectral Density	17
4.5. Emissions in non-restricted frequency bands	18
4.6. Band edge emissions (Radiated)	19
4.7. Emissions in frequency bands (below 1GHz)	24
4.8. Emissions in frequency bands (above 1GHz)	27
5. EUT TEST PHOTOS	34
6. PHOTOGRAPHS OF EUT CONSTRUCTIONAL	36
Appendix	37
6.1. Appendix A: DTS Bandwidth	38
6.2. Appendix B: Occupied Channel Bandwidth	44
6.3. Appendix C: Maximum conducted output power	50
6.4. Appendix D: Maximum power spectral density	57
6.5. Appendix E: Reference level measurement	63
6.6. Appendix F: Band edge measurements	69
6.7. Appendix G: Conducted Spurious Emission	73
6.8. Appendix H: Duty Cycle	83

1. TEST SUMMARY

1.1. Test Standards

The tests were performed according to following standards:

47 CFR Part 15.247: Operation within the bands 902-928 MHz, 2400-2483.5 MHz, and 5725-5850 MHz

ANSI C63.10-2013: American National Standard of Procedures for Compliance Testing of Unlicensed Wireless Devices.

KDB 558074 D01 15.247 Meas Guidance v05r02: Guidance for compliance measurements on digital transmission system, frequency hopping spread spectrum system, and hybrid system devices operating under section 15.247 of the FCC rules.

1.2. Report Version

Revised No.	Date of issue	Description
01	September 23, 2024	Original

1.3. Test Description

Test Item	Standard	Requirement	Result
Antenna requirement	47 CFR Part 15.247	47 CFR 15.203	Pass
Conducted Emission at AC power line	47 CFR Part 15.247	47 CFR 15.207(a)	Pass
Occupied Bandwidth	47 CFR Part 15.247	47 CFR 15.247(a)(2)	Pass
Maximum Conducted Output Power	47 CFR Part 15.247	47 CFR 15.247(b)(3)	Pass
Power Spectral Density	47 CFR Part 15.247	47 CFR 15.247(e)	Pass
Emissions in non-restricted frequency bands	47 CFR Part 15.247	47 CFR 15.247(d), 15.209, 15.205	Pass
Band edge emissions (Radiated)	47 CFR Part 15.247	47 CFR 15.247(d), 15.209, 15.205	Pass
Emissions in frequency bands (below 1GHz)	47 CFR Part 15.247	47 CFR 15.247(d), 15.209, 15.205	Pass
Emissions in frequency bands (above 1GHz)	47 CFR Part 15.247	47 CFR 15.247(d), 15.209, 15.205	Pass

TRF No. RF_R1

Add: West Side of 1/F., Building C, Zone A, Fuyuan New Factory, Jiujiu Industrial Park, Minzhu, Shatou, Shajing, Bao'an District, Shenzhen, Guangdong, China

Tel: +(86) 0755-2985 2678 Fax: +(86) 0755-2985 2397 E-mail: info@gdkesign.cn Web: www.gdkesign.com

1.4. Test Facility

KSIGN(Guangdong) Testing Co., Ltd .

West Side of 1/F., Building C, Zone A, Fuyuan New Factory, Jiujiu Industrial Park, Minzhu, Shatou, Shajing, Bao'an District, Shenzhen, Guangdong, China

The test facility is recognized, certified, or accredited by the following organizations:

CNAS-Lab Code: L 13261

KSIGN(Guangdong) Testing Co., Ltd. has been assessed and proved to be in Compliance with CNAS-CL01 Accreditation Criteria for Testing and Calibration Laboratories (identical to ISO/IEC17025: 2017 General Requirements) for the Competence of Testing and Calibration Laboratories.

A2LA-Lab Cert. No.: 5457.01

KSIGN(Guangdong) Testing Co., Ltd. EMC Laboratory has been accredited by A2LA for technical competence in the field of electrical testing, and proved to be in compliance with ISO/IEC 17025:2017 General Requirements for the Competence of Testing and Calibration Laboratories and any additional program requirements in the identified field of testing.

ISED# : 25693 CAB identifier.: CN0096

KSIGN(Guangdong) Testing Co., Ltd. has been listed by Innovation, Science and Economic Development Canada to perform electromagnetic emission measurement.

FCC-Registration No.: 294912 Designation Number: CN1328

KSIGN(Guangdong) Testing Co., Ltd. EMC Laboratory has been listed on the US Federal Communications Commission list of test facilities recognized to perform electromagnetic emissions measurements.

1.5. Measurement Uncertainty

Test Items	Measurement Uncertainty
Conducted Emission (150k-30MHz)	± 3.34dB
Output Power, Conducted	± 1.4dB
PSD, Conducted	± 1.0dB
Spurious Emissions, Conducted	± 3.3dB
RSE (1-18GHz)	± 4.68dB
RSE (30-1000MHz)	± 5.7dB
RSE (18-40GHz)	± 5.18dB

The reported uncertainty of measurement $y \pm U$, where expanded uncertainty U is based on a standard uncertainty multiplied by a coverage factor of $k=2$, providing a level of confidence of approximately 95 %. Otherwise required by the applicant or Product Regulations. Decision Rule in this report did not consider the uncertainty.

2. GENERAL INFORMATION

2.1. General Description Of EUT

Test Sample Number:	KS2409S3823E-01, KS2409S3823E-02
Product Name:	Audio stream adapter
Trademark:	GameScent, MovieScent
Model / Type reference:	ADPT002, ADPT002W
Model Difference:	The only difference product models is color of appearance. Different model names are available to meet market demands. Other power supply methods, appearance, internal structures, circuits and key components are the same, and do not affect safety and electromagnetic compatibility performance. According to the above information, all tests were performed on ADPT002.
Power Supply:	DC 5V from adapter
Operation Frequency:	802.11b/g/n(HT20): 2412MHz to 2462MHz; 802.11n(HT40): 2422MHz to 2452MHz
Number of Channels:	802.11b/g/n(HT20): 11 Channels; 802.11n(HT40): 7 Channels
Modulation Type:	802.11b: DSSS(CCK, DQPSK, DBPSK); 802.11g: OFDM(BPSK, QPSK, 16QAM, 64QAM); 802.11n(HT20 and HT40): OFDM (BPSK, QPSK, 16QAM, 64QAM)
Antenna Type:	PCB
Antenna Gain:	2.36dBi
Max TX Power:	17.05dBm
Hardware Version:	Gamescent-V3.0
Software Version:	2V2

Note:Antenna gain provided by the applicant Can affect the validity of results

2.2. Accessory Equipment Information

Title	Manufacturer	Model No.	Technical Parameters	Provided by
Computer	HP	15-cd028AX	/	Laboratory
Power Adapter	Xiaomi	HW-200440C00	/	Laboratory

2.3. Description of Test Modes

No.	Title	Description of Mode
Test Mode1	802.11b mode	Keep the EUT in 802.11b transmitting mode at lowest, middle and highest channel.
Test Mode2	802.11g mode	Keep the EUT in 802.11g transmitting mode at lowest, middle and highest channel.
Test Mode3	802.11n(HT20) mode	Keep the EUT in 802.11n(HT20) transmitting mode at lowest, middle and highest channel.
Test Mode4	802.11n(HT40) mode	Keep the EUT in 802.11n(HT40) transmitting mode at lowest, middle and highest channel.

2.4. Operation channel list

Channel	Frequency (MHz)	Channel	Frequency (MHz)	Channel	Frequency (MHz)
1	2412	5	2432	9	2452
2	2417	6	2437	10	2457
3	2422	7	2442	11	2462
4	2427	8	2447	/	/

2.5. Measurement Instruments List

Conducted Emission at AC power line				
Test Equipment	Manufacturer	Model No.	Serial No.	Cal. Until
LISN	R&S	ENV432	1326.6105.02	2025-01-19
EMI Test Receiver	R&S	ESR	102524	2025-01-19
Manual RF Switch	JS TOYO	/	MSW-01/002	2025-01-19
ISN CAT6	Schwarzbeck	CAT5 8158	227	2025-01-19
Color Signal Generator	Philips	PM5418	672926	2025-01-19
Power Absorbing Clamp	R&S	MDS-21	100925	2025-01-21
TV Tuner	SUNLIGHT	ST5075	/	2024-12-12
LISN	EVERFINE	LS-5	G657431CD14311 12	2025-01-19
Current Sensor Probe	Beijin ZHINAN	ZN23101	23013	2024-12-12
PV Artificial power network	Beijing KeHuan	KH8301	830120007	2025-07-23

Occupied Bandwidth Maximum Conducted Output Power Power Spectral Density Emissions in non-restricted frequency bands				
Test Equipment	Manufacturer	Model No.	Serial No.	Cal. Until
Wideband Radio Communication Tester	R&S	CMU200	115297	2025-01-19
Audio Analyzer	R&S	UPL16	100001	2025-01-19
Shielding box	Gxiong	GX-5915A	2201113	2025-01-19
High Pass Filter	COM-MW Technology Co., Ltd	ZHPF-M1.2-9G-1 87	09203403	2025-01-19
Band Stop Filter	COM-MW Technology Co., Ltd	ZBSF6-C820-920 -188	09203401	2025-01-19
Splitter	COM-MW Technology Co., Ltd	ZPD-M1-8-2103	09203407	2025-01-19
Coaxial Cable	BEBES	A40-2.92M2.92F- 4.5M	1907021	2025-01-19
Hygrothermograph	Anymetre	JB913	/	2025-01-19
Climate Chamber	Angul	AGNH80L	1903042120	2025-01-19
Spectrum Analyzer	HP	8593E	3831U02087	2025-01-19
Dual Output DC Power Supply	Agilent	E3646A	MY40009992	2025-01-19
RF Control Unit	Tonscend	JS0806-2	/	2025-01-19
Analog Signal Generator	HP	83752A	3344A00337	2025-01-19
Vector Signal Generator	Agilent	N5182A	MY50142520	2025-01-19
Wideband Radio Communication Tester	R&S	CMW500	157282	2025-01-19
Spectrum Analyzer	R&S	FSV40-N	101798	2025-01-19

TRF No. RF_R1

Add: West Side of 1/F., Building C, Zone A, Fuyuan New Factory, Jiujiu Industrial Park, Minzhu, Shatou, Shajing, Bao'an District, Shenzhen, Guangdong, China

Tel: +(86) 0755-2985 2678 Fax: +(86) 0755-2985 2397 E-mail: info@gdkesign.cn Web: www.gdkesign.com

Emissions in frequency bands (below 1GHz) Emissions in frequency bands (above 1GHz) Band edge emissions (Radiated)				
Test Equipment	Manufacturer	Model No.	Serial No.	Cal. Until
Color Signal Generator	Philips	PM5418	672926	2025-01-19
Log Periodic Antenna	Schwarzbeck	VULB 9163	1230	2025-01-29
Pre-Amplifier	Schwarzbeck	BBV 9745	9745#129	2025-01-19
Broadcast Television Signal Generator	R&S	SFE100	141038	2025-01-19
Analog Signal Generator	Agilent	8648A	3847M00445	2025-01-19
EMI Test Receiver	R&S	ESR	102525	2025-01-19
Loop Antenna	Beijin ZHINAN	ZN30900C	18050	2025-01-29
Horn Antenna	Schwarzbeck	BBHA 9120 D	2023	2025-01-21
Pre-Amplifier	EMCI	EMC051835SE	980662	2025-01-19
Spectrum Analyzer	Keysight	N9020A	MY46471971	2025-01-19

TRF No. RF_R1

Add: West Side of 1/F., Building C, Zone A, Fuyuan New Factory, Jiujiu Industrial Park, Minzhu, Shatou, Shajing, Bao'an District, Shenzhen, Guangdong, China

Tel: +(86) 0755-2985 2678 Fax: +(86) 0755-2985 2397 E-mail: info@gdkesign.cn Web: www.gdkesign.com

3. Evaluation Results (Evaluation)

3.1. Antenna requirement

Test Requirement:	Refer to 47 CFR Part 15.203, an intentional radiator shall be designed to ensure that no antenna other than that furnished by the responsible party shall be used with the device. The use of a permanently attached antenna or of an antenna that uses a unique coupling to the intentional radiator shall be considered sufficient to comply with the provisions of this section.
Conclusion:	The directional gain of the antenna less than 6dBi, please refer to the EUT internal photographs antenna photo.

4. Radio Spectrum Matter Test Results (RF)

4.1. Conducted Emission at AC power line

Test Requirement:	Refer to 47 CFR 15.207(a), Except as shown in paragraphs (b)and (c)of this section, for an intentional radiator that is designed to be connected to the public utility (AC) power line, the radio frequency voltage that is conducted back onto the AC power line on any frequency or frequencies, within the band 150 kHz to 30 MHz, shall not exceed the limits in the following table, as measured using a 50 μH/50 ohms line impedance stabilization network (LISN).		
Test Limit:	Frequency of emission (MHz)	Conducted limit (dBμV)	
		Quasi-peak	Average
	0.15-0.5	66 to 56*	56 to 46*
	0.5-5	56	46
	5-30	60	50
	*Decreases with the logarithm of the frequency.		
Test Method:	ANSI C63.10-2013 section 6.2		
Procedure:	Refer to ANSI C63.10-2013 section 6.2, standard test method for ac power-line conducted emissions from unlicensed wireless devices		

4.1.1. E.U.T. Operation:

Operating Environment:	
Temperature:	23.5 °C
Humidity:	50.8 %
Atmospheric Pressure:	102 kPa
Final test mode:	Test Mode 1

4.1.2. Test Setup Diagram:

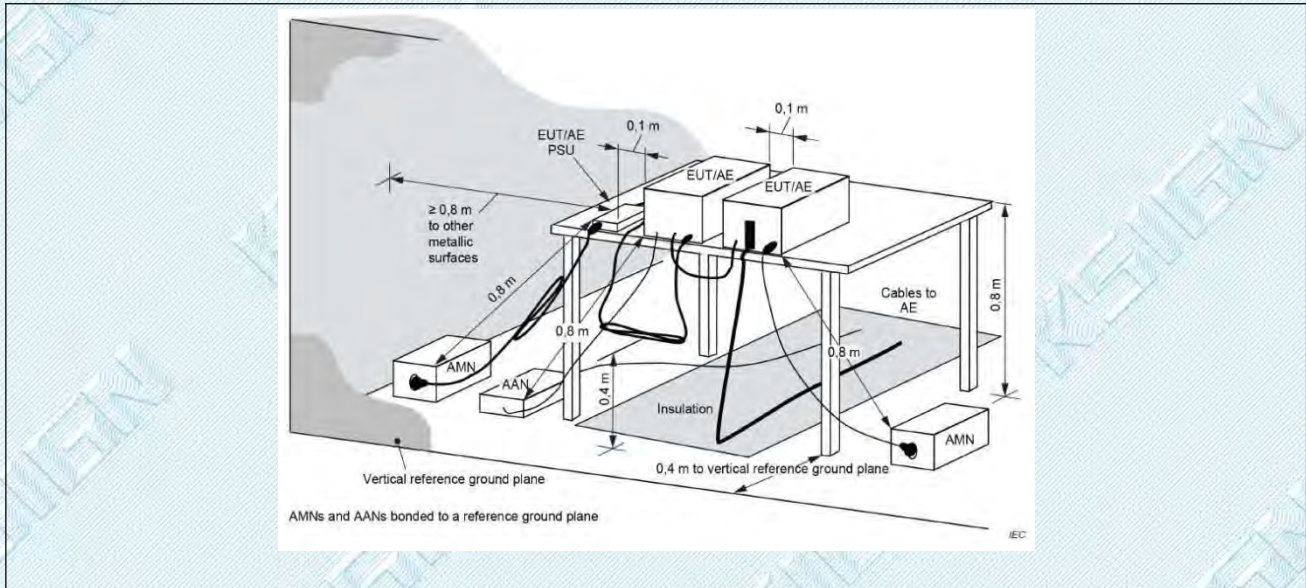

4.1.3. Test Data:

Test Mode1 / Line: Line / Band: 2400-2483.5 MHz / BW: 20 / CH: L

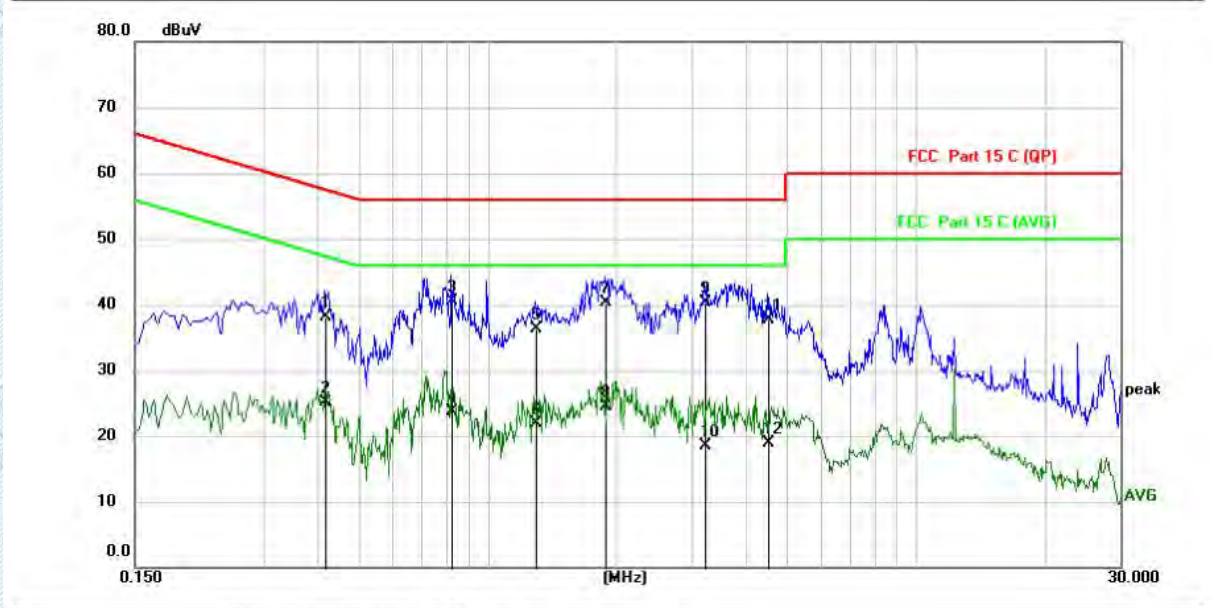

No. Mk.	Freq. MHz	Reading Level dBuV	Correct Factor dB	Measurement dBuV	Limit dBuV	Over dB	Detector	Comment
1	0.4178	17.36	20.71	38.07	57.49	-19.42	QP	
2	0.4178	4.36	20.71	25.07	47.49	-22.42	AVG	
3 *	0.8256	19.66	20.76	40.42	56.00	-15.58	QP	
4	0.8256	3.04	20.76	23.80	46.00	-22.20	AVG	
5	1.2940	15.63	20.77	36.40	56.00	-19.60	QP	
6	1.2940	1.23	20.77	22.00	46.00	-24.00	AVG	
7	1.8814	19.44	20.79	40.23	56.00	-15.77	QP	
8	1.8814	3.66	20.79	24.45	46.00	-21.55	AVG	
9	3.2179	19.44	20.82	40.26	56.00	-15.74	QP	
10	3.2179	-2.32	20.82	18.50	46.00	-27.50	AVG	
11	4.5100	16.80	20.84	37.64	56.00	-18.36	QP	
12	4.5100	-1.91	20.84	18.93	46.00	-27.07	AVG	

TRF No. RF_R1

Add: West Side of 1/F., Building C, Zone A, Fuyuan New Factory, Jiujiu Industrial Park, Minzhu, Shatou, Shajing, Bao'an District, Shenzhen, Guangdong, China

Tel: +(86) 0755-2985 2678 Fax: +(86) 0755-2985 2397 E-mail: info@gdkesign.cn Web: www.gdkesign.com

Test Mode1 / Line: Neutral / Band: 2400-2483.5 MHz / BW: 20 / CH: L

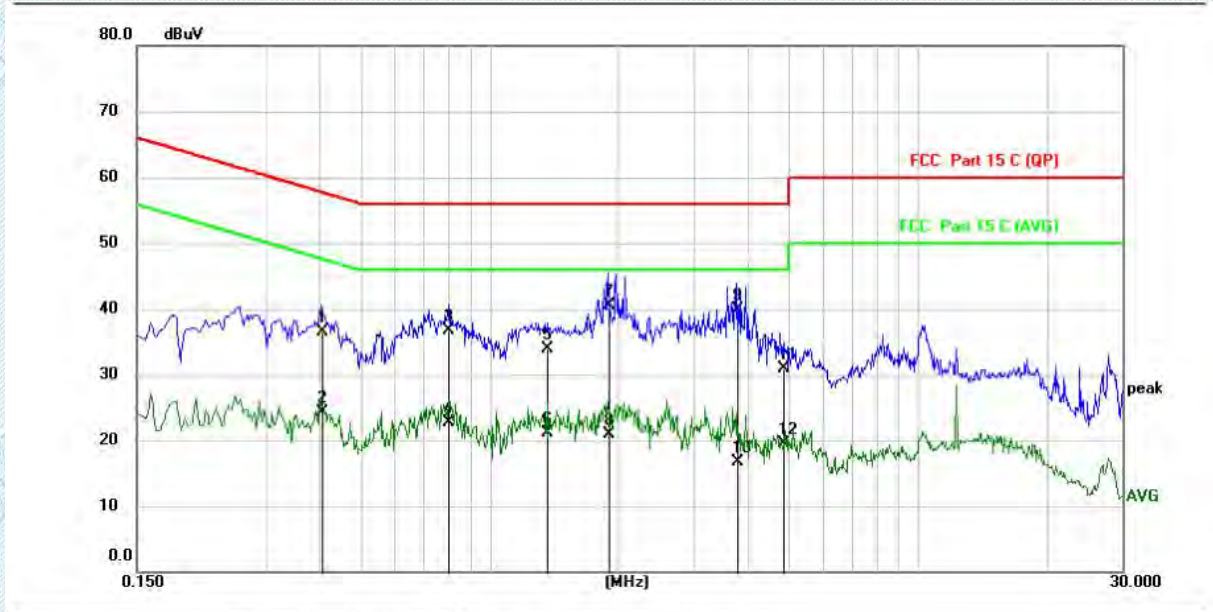

No. Mk.	Freq.	Reading Level	Correct Factor	Measurement	Limit	Over	Detector	Comment
	MHz	dBuV	dB	dBuV	dBuV	dB		
1	0.4060	15.72	20.72	36.44	57.73	-21.29	QP	
2	0.4060	3.67	20.72	24.39	47.73	-23.34	AVG	
3	0.8020	16.03	20.75	36.78	56.00	-19.22	QP	
4	0.8020	1.91	20.75	22.66	46.00	-23.34	AVG	
5	1.3619	13.15	20.77	33.92	56.00	-22.08	QP	
6	1.3619	0.33	20.77	21.10	46.00	-24.90	AVG	
7 *	1.8900	19.70	20.80	40.50	56.00	-15.50	QP	
8	1.8900	0.07	20.80	20.87	46.00	-25.13	AVG	
9	3.7940	19.16	20.84	40.00	56.00	-16.00	QP	
10	3.7940	-4.14	20.84	16.70	46.00	-29.30	AVG	
11	4.8658	10.12	20.87	30.99	56.00	-25.01	QP	
12	4.8658	-1.46	20.87	19.41	46.00	-26.59	AVG	

Note:

1.Measurement = Reading level + Correct Factor

2.Correct Factor=Antenna Factor + Cable Loss -Preamplifier Factor

4.2. Occupied Bandwidth

Test Requirement:	47 CFR 15.247(a)(2)
Test Limit:	Refer to 47 CFR 15.247(a)(2), Systems using digital modulation techniques may operate in the 902-928 MHz, and 2400-2483.5 MHz bands. The minimum 6 dB bandwidth shall be at least 500 kHz.
Test Method:	ANSI C63.10-2013, section 11.8 KDB 558074 D01 15.247 Meas Guidance v05r02
Procedure:	<p>DTS Occupied Bandwidth:</p> <ul style="list-style-type: none"> a) Set RBW = 100 kHz. b) Set the VBW \geq [3 × RBW]. c) Detector = peak. d) Trace mode = max hold. e) Sweep = auto couple. f) Allow the trace to stabilize. g) Measure the maximum width of the emission that is constrained by the frequencies associated with the two outermost amplitude points (upper and lower frequencies) that are attenuated by 6 dB relative to the maximum level measured in the fundamental emission. <p>99% Occupied Bandwidth:</p> <ul style="list-style-type: none"> a) Set RBW = 1% to 5% of the OBW. b) Set the VBW \geq [3 × RBW]. c) Detector = peak. d) Trace mode = max hold. e) Sweep = auto couple. f) Allow the trace to stabilize. g) Use the 99% power bandwidth function of the instrument (if available) and report the measured bandwidth

4.2.1. E.U.T. Operation:

Operating Environment:	
Temperature:	23.5 °C
Humidity:	50.8 %
Atmospheric Pressure:	102 kPa
Final test mode:	Test Mode1, Test Mode2, Test Mode3, Test Mode4

4.2.2. Test Setup Diagram:

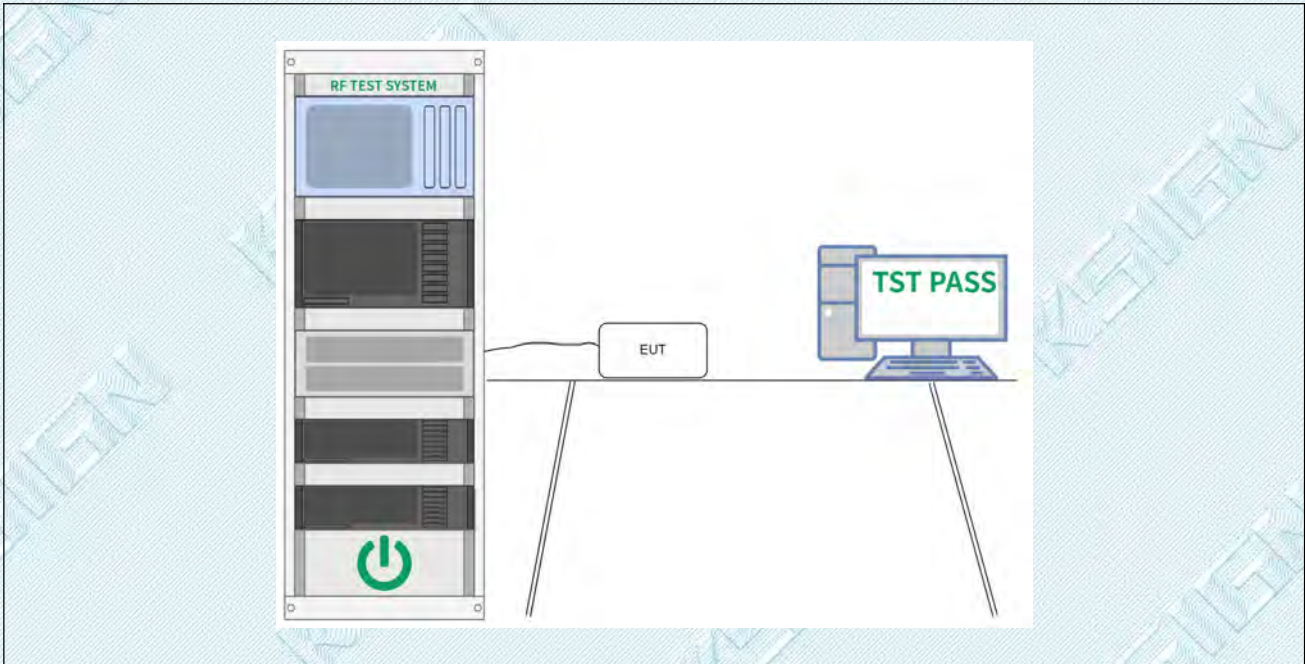

4.2.3. Test Data:

Please Refer to Appendix for Details.

4.3. Maximum Conducted Output Power

Test Requirement:	47 CFR 15.247(b)(3)
Test Limit:	Refer to 47 CFR 15.247(b)(3), For systems using digital modulation in the 902-928 MHz, 2400-2483.5 MHz, and 5725-5850 MHz bands: 1 Watt. As an alternative to a peak power measurement, compliance with the one Watt limit can be based on a measurement of the maximum conducted output power. Maximum Conducted Output Power is defined as the total transmit power delivered to all antennas and antenna elements averaged across all symbols in the signaling alphabet when the transmitter is operating at its maximum power control level. Power must be summed across all antennas and antenna elements. The average must not include any time intervals during which the transmitter is off or is transmitting at a reduced power level. If multiple modes of operation are possible (e.g., alternative modulation methods), the maximum conducted output power is the highest total transmit power occurring in any mode.
Test Method:	ANSI C63.10-2013, section 11.9.2 KDB 558074 D01 15.247 Meas Guidance v05r02
Procedure:	ANSI C63.10-2013, section 11.9.2 Maximum conducted (average) output power

4.3.1. E.U.T. Operation:

Operating Environment:	
Temperature:	23.5 °C
Humidity:	50.8 %
Atmospheric Pressure:	102 kPa
Final test mode:	Test Mode1, Test Mode2, Test Mode3, Test Mode4

4.3.2. Test Setup Diagram:

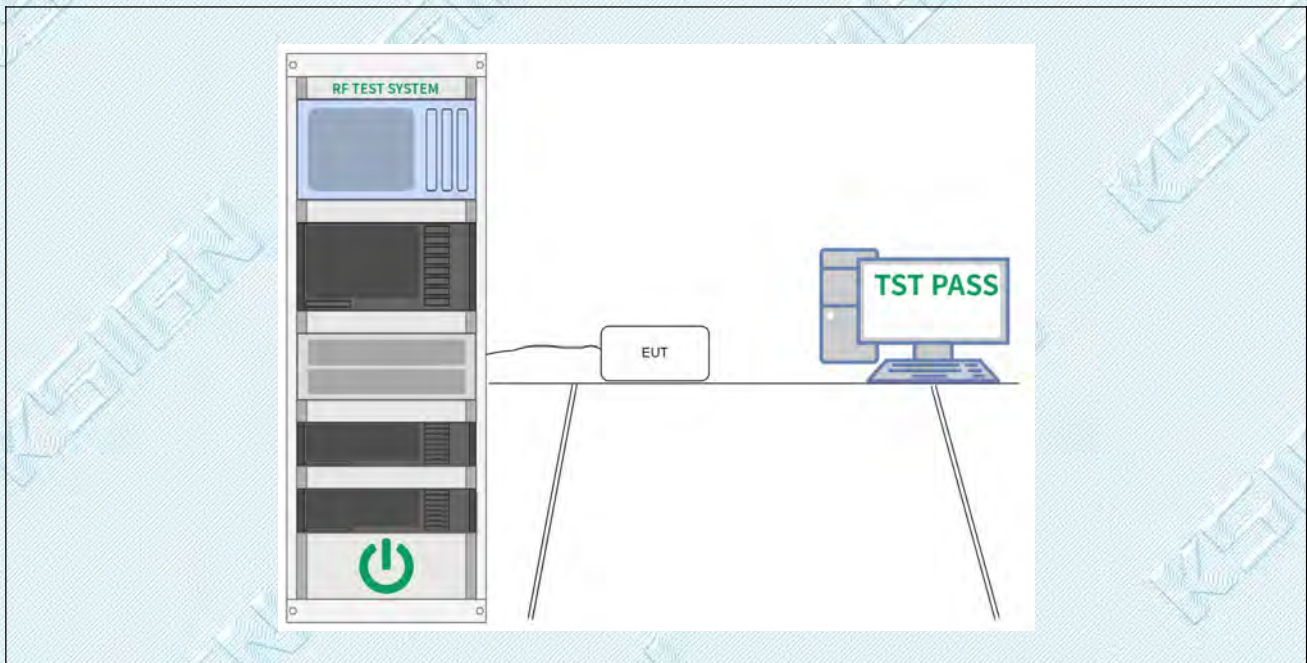

4.3.3. Test Data:

Please Refer to Appendix for Details.

4.4. Power Spectral Density

Test Requirement:	47 CFR 15.247(e)
Test Limit:	Refer to 47 CFR 15.247(e), For digitally modulated systems, the power spectral density conducted from the intentional radiator to the antenna shall not be greater than 8 dBm in any 3 kHz band during any time interval of continuous transmission. This power spectral density shall be determined in accordance with the provisions of paragraph (b) of this section. The same method of determining the conducted output power shall be used to determine the power spectral density.
Test Method:	ANSI C63.10-2013, section 11.10 KDB 558074 D01 15.247 Meas Guidance v05r02
Procedure:	ANSI C63.10-2013, section 11.10, Maximum power spectral density level in the fundamental emission

4.4.1. E.U.T. Operation:

Operating Environment:	
Temperature:	23.5 °C
Humidity:	50.8 %
Atmospheric Pressure:	102 kPa
Final test mode:	Test Mode1, Test Mode2, Test Mode3, Test Mode4

4.4.2. Test Setup Diagram:

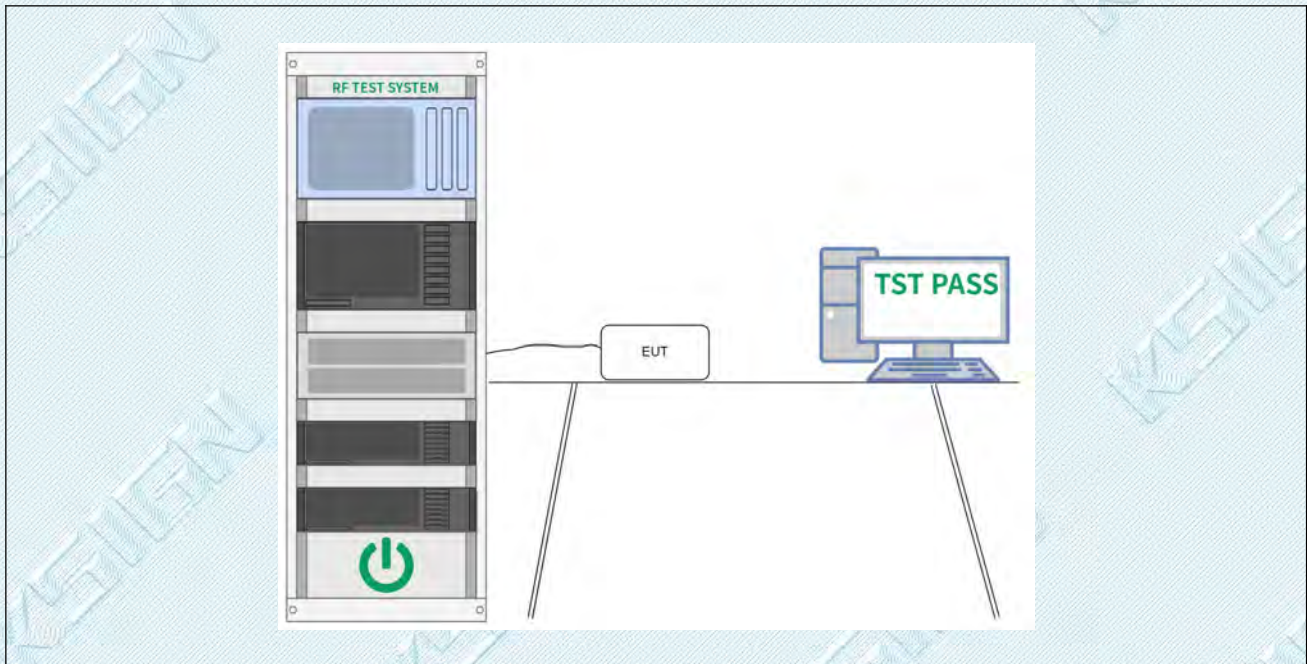

4.4.3. Test Data:

Please Refer to Appendix for Details.

4.5. Emissions in non-restricted frequency bands

Test Requirement:	47 CFR 15.247(d), 15.209, 15.205
Test Limit:	Refer to 47 CFR 15.247(d), In any 100 kHz bandwidth outside the frequency band in which the spread spectrum or digitally modulated intentional radiator is operating, the radio frequency power that is produced by the intentional radiator shall be at least 20 dB below that in the 100 kHz bandwidth within the band that contains the highest level of the desired power, based on either an RF conducted or a radiated measurement, provided the transmitter demonstrates compliance with the peak conducted power limits. If the transmitter complies with the conducted power limits based on the use of RMS averaging over a time interval, as permitted under paragraph (b)(3) of this section, the attenuation required under this paragraph shall be 30 dB instead of 20 dB. Attenuation below the general limits specified in § 15.209(a) is not required.
Test Method:	ANSI C63.10-2013 section 11.11 KDB 558074 D01 15.247 Meas Guidance v05r02
Procedure:	ANSI C63.10-2013 Section 11.11.1, Section 11.11.2, Section 11.11.3

4.5.1. E.U.T. Operation:

Operating Environment:	
Temperature:	23.5 °C
Humidity:	50.8 %
Atmospheric Pressure:	102 kPa
Final test mode:	Test Mode1, Test Mode2, Test Mode3, Test Mode4

4.5.2. Test Setup Diagram:

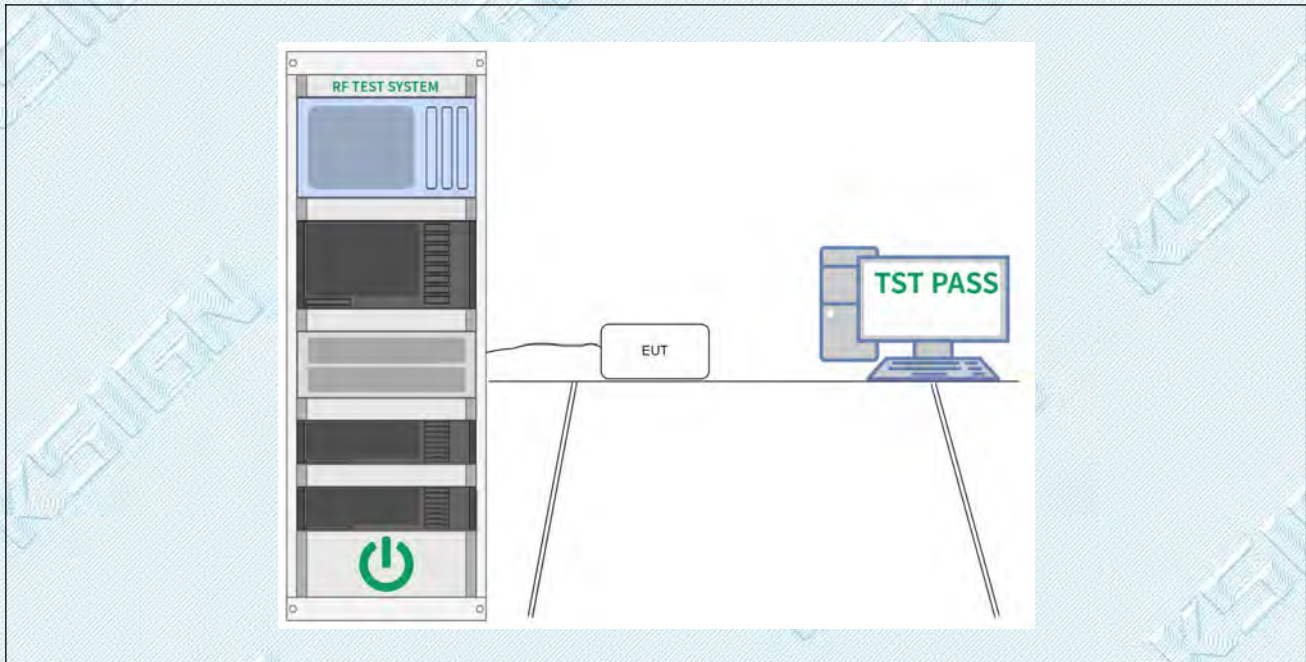

4.5.3. Test Data:

Please Refer to Appendix for Details.

4.6. Band edge emissions (Radiated)

Test Requirement:	Refer to 47 CFR 15.247(d), In addition, radiated emissions which fall in the restricted bands, as defined in § 15.205(a), must also comply with the radiated emission limits specified in § 15.209(a)(see § 15.205(c)).		
Test Limit:	Frequency (MHz)	Field strength (microvolts/meter)	Measurement distance (meters)
	0.009-0.490	2400/F(kHz)	300
	0.490-1.705	24000/F(kHz)	30
	1.705-30.0	30	30
	30-88	100 **	3
	88-216	150 **	3
	216-960	200 **	3
	Above 960	500	3
	<p>** Except as provided in paragraph (g), fundamental emissions from intentional radiators operating under this section shall not be located in the frequency bands 54-72 MHz, 76-88 MHz, 174-216 MHz or 470-806 MHz. However, operation within these frequency bands is permitted under other sections of this part, e.g., §§ 15.231 and 15.241.</p> <p>In the emission table above, the tighter limit applies at the band edges.</p> <p>The emission limits shown in the above table are based on measurements employing a CISPR quasi-peak detector except for the frequency bands 9-90 kHz, 110-490 kHz and above 1000 MHz. Radiated emission limits in these three bands are based on measurements employing an average detector.</p>		
Test Method:	ANSI C63.10-2013 section 6.10 KDB 558074 D01 15.247 Meas Guidance v05r02		
Procedure:	ANSI C63.10-2013 section 6.10.5.2		

4.6.1. E.U.T. Operation:

Operating Environment:	
Temperature:	23.5 °C
Humidity:	50.8 %
Atmospheric Pressure:	102 kPa
Final test mode:	Test Mode1, Test Mode2, Test Mode3, Test Mode4

4.6.2. Test Setup Diagram:

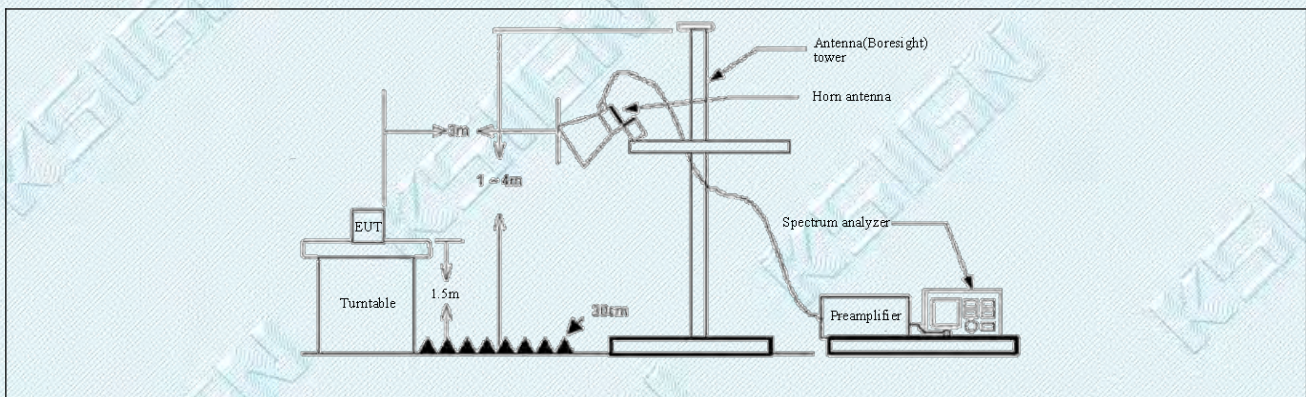

4.6.3. Test Data:

Test Mode1 / Polarization: Horizontal / Band: 2400-2483.5 MHz / BW: 20 / CH: L

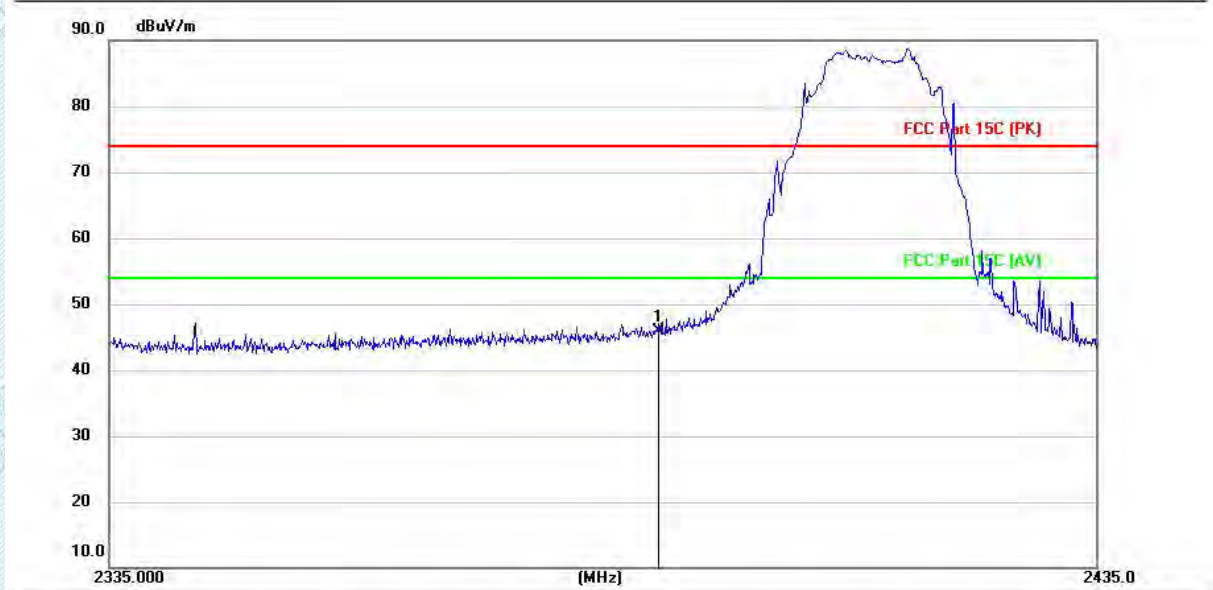

No.	Mk.	Freq. MHz	Reading Level (dBuV)	Correct Factor (dB/m)	Measurement (dBuV/m)	Limit (dBuV/m)	Over (dB)	Detector
1	*	2390.000	45.10	0.90	46.00	74.00	-28.00	peak

Test Mode1 / Polarization: Vertical / Band: 2400-2483.5 MHz / BW: 20 / CH: L

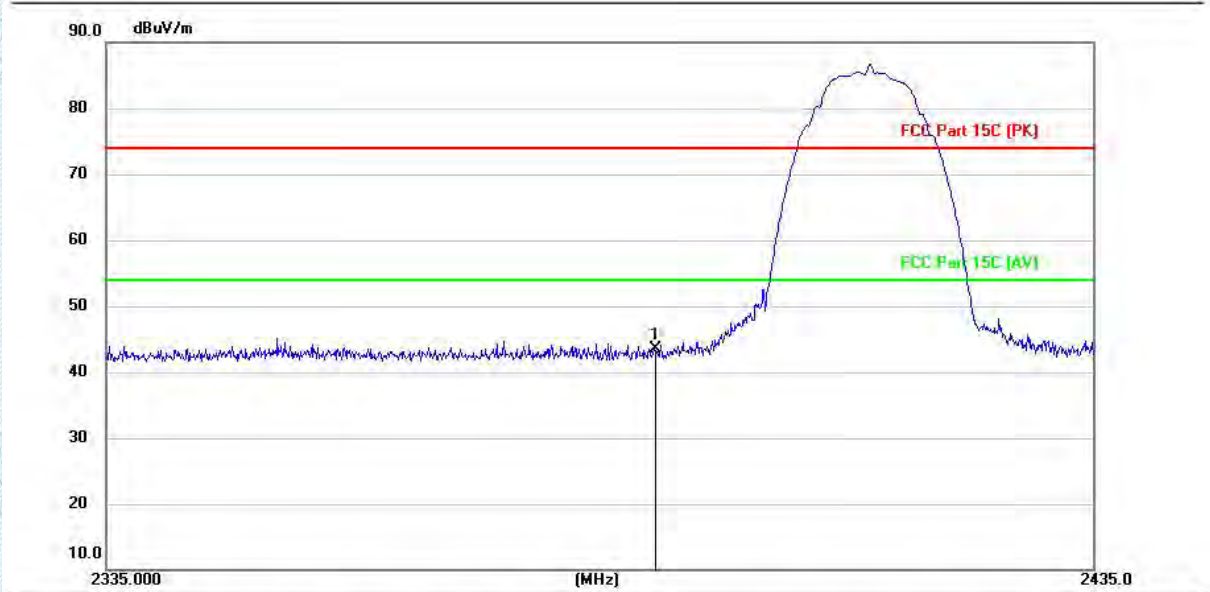

No.	Mk.	Freq. MHz	Reading Level (dBuV)	Correct Factor (dB/m)	Measurement (dBuV/m)	Limit (dBuV/m)	Over (dB)	Detector
1	*	2390.000	42.65	0.90	43.55	74.00	-30.45	peak

TRF No. RF_R1

Add: West Side of 1/F., Building C, Zone A, Fuyuan New Factory, Jiujiu Industrial Park, Minzhu, Shatou, Shajing, Bao'an District, Shenzhen, Guangdong, China

Tel: +(86) 0755-2985 2678 Fax: +(86) 0755-2985 2397 E-mail: info@gdkesign.cn Web: www.gdkesign.com

Test Mode1 / Polarization: Horizontal / Band: 2400-2483.5 MHz / BW: 20 / CH: H

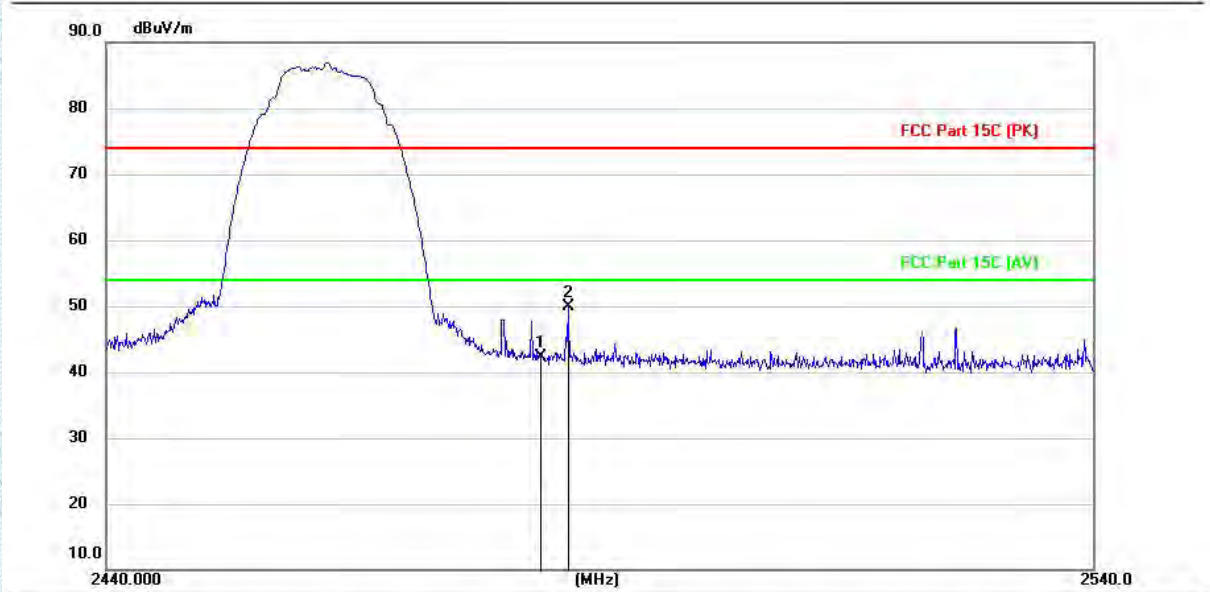

No.	Mk.	Freq. MHz	Reading Level (dBuV)	Correct Factor (dB/m)	Measurement (dBuV/m)	Limit (dBuV/m)	Over (dB)	Detector
1		2483.500	41.64	0.69	42.33	74.00	-31.67	peak
2	*	2486.320	49.19	0.66	49.85	74.00	-24.15	peak

TRF No. RF_R1

Add: West Side of 1/F., Building C, Zone A, Fuyuan New Factory, Jiujiu Industrial Park, Minzhu, Shatou, Shajing, Bao'an District, Shenzhen, Guangdong, China

Tel: +(86) 0755-2985 2678 Fax: +(86) 0755-2985 2397 E-mail: info@gdkesign.cn Web: www.gdkesign.com

Test Mode1 / Polarization: Vertical / Band: 2400-2483.5 MHz / BW: 20 / CH: H

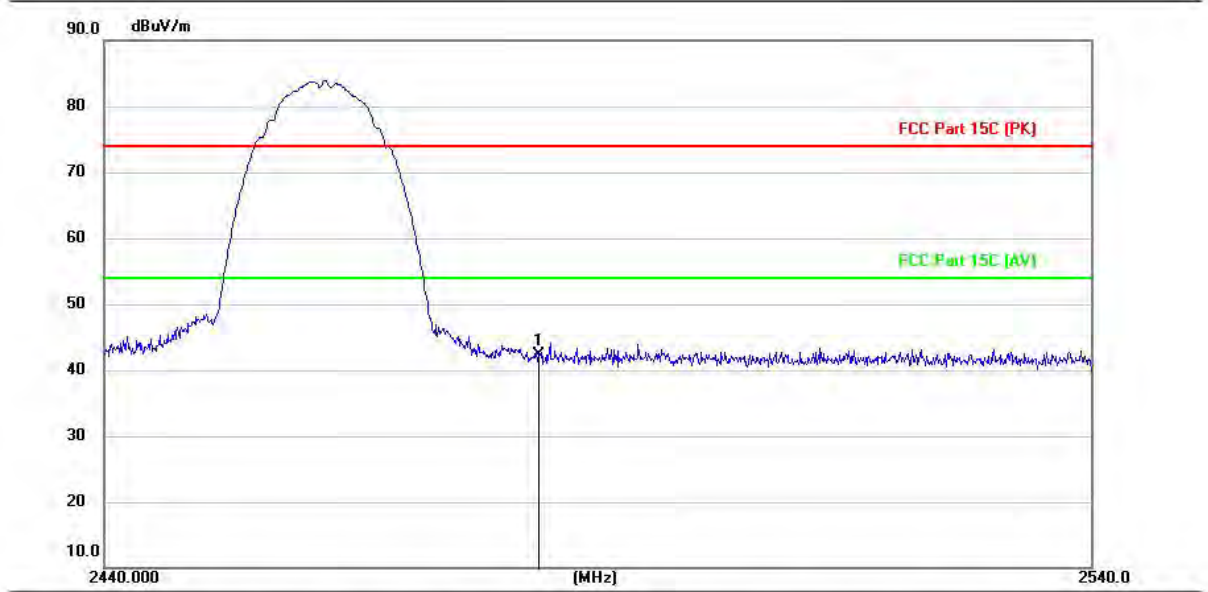

No.	Mk.	Freq. MHz	Reading Level (dBuV)	Correct Factor (dB/m)	Measurement (dBuV/m)	Limit (dBuV/m)	Over (dB)	Detector
1	*	2483.500	41.52	0.69	42.21	74.00	-31.79	peak

Note:

1.Measurement = Reading level + Correct Factor

Correct Factor=Antenna Factor + Cable Loss - Preamplifier Factor

Over = Measurement -Limit

2.Pre-scan 802.11b, 802.11g, 802.11n(HT20) mode and 802.11n(HT40) mode, and found the 802.11b mode which it is worse case, so only show the test data for worse case.

3. Since the peak value is less than the limit of the AVG value, there is no AVG data.

4.7. Emissions in frequency bands (below 1GHz)

Test Requirement:	Refer to 47 CFR 15.247(d), In addition, radiated emissions which fall in the restricted bands, as defined in § 15.205(a), must also comply with the radiated emission limits specified in § 15.209(a)(see § 15.205(c)).		
Test Limit:	Frequency (MHz)	Field strength (microvolts/meter)	Measurement distance (meters)
	0.009-0.490	2400/F(kHz)	300
	0.490-1.705	24000/F(kHz)	30
	1.705-30.0	30	30
	30-88	100 **	3
	88-216	150 **	3
	216-960	200 **	3
	Above 960	500	3
	<p>** Except as provided in paragraph (g), fundamental emissions from intentional radiators operating under this section shall not be located in the frequency bands 54-72 MHz, 76-88 MHz, 174-216 MHz or 470-806 MHz. However, operation within these frequency bands is permitted under other sections of this part, e.g., §§ 15.231 and 15.241.</p> <p>In the emission table above, the tighter limit applies at the band edges.</p> <p>The emission limits shown in the above table are based on measurements employing a CISPR quasi-peak detector except for the frequency bands 9-90 kHz, 110-490 kHz and above 1000 MHz. Radiated emission limits in these three bands are based on measurements employing an average detector.</p>		
Test Method:	ANSI C63.10-2013 section 6.6.4 KDB 558074 D01 15.247 Meas Guidance v05r02		
Procedure:	ANSI C63.10-2013 section 6.6.4		

4.7.1. E.U.T. Operation:

Operating Environment:	
Temperature:	23.5 °C
Humidity:	50.8 %
Atmospheric Pressure:	102 kPa
Final test mode:	Test Mode1, Test Mode2, Test Mode3, Test Mode4

4.7.2. Test Setup Diagram:

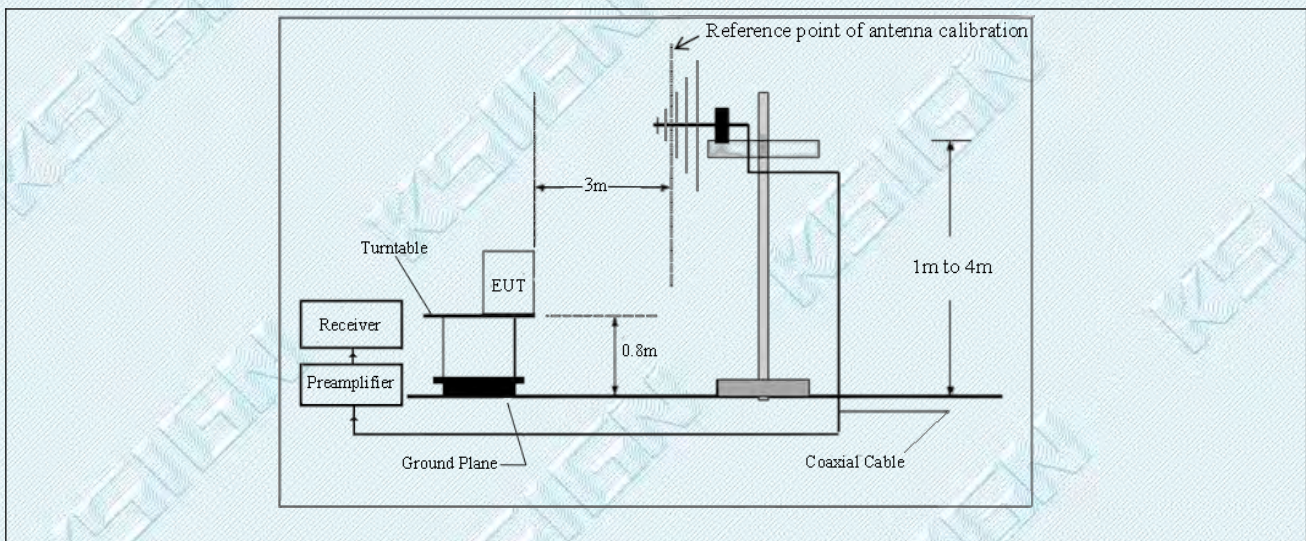

4.7.3. Test Data:

Test Mode1 / Polarization: Horizontal / Band: 2400-2483.5 MHz / BW: 20 / CH: L



No.	Mk.	Freq. MHz	Reading Level (dBuV)	Correct Factor (dB/m)	Measurement (dBuV/m)	Limit (dBuV/m)	Over (dB)	Detector
1		41.4503	29.44	-10.89	18.55	40.00	-21.45	QP
2		67.1786	29.86	-11.37	18.49	40.00	-21.51	QP
3		109.5267	29.69	-11.03	18.66	43.50	-24.84	QP
4		331.8197	30.93	-6.61	24.32	46.00	-21.68	QP
5		602.0593	27.43	0.88	28.31	46.00	-17.69	QP
6	*	845.0877	27.57	3.52	31.09	46.00	-14.91	QP

Test Mode1 / Polarization: Vertical / Band: 2400-2483.5 MHz / BW: 20 / CH: L



No.	Mk.	Freq. MHz	Reading Level (dBuV)	Correct Factor (dB/m)	Measurement (dBuV/m)	Limit (dBuV/m)	Over (dB)	Detector
1		36.8693	32.05	-11.33	20.72	40.00	-19.28	QP
2		67.5327	31.64	-11.51	20.13	40.00	-19.87	QP
3		135.1739	34.76	-14.14	20.62	43.50	-22.88	QP
4		343.6616	27.48	-5.99	21.49	46.00	-24.51	QP
5		587.2553	27.73	0.42	28.15	46.00	-17.85	QP
6	*	854.9234	26.72	3.67	30.39	46.00	-15.61	QP

9 KHz - 30 MHz:

The amplitude of spurious emissions which are attenuated by more than 20dB below the permissible value has no need to be reported.

Note:

- 1.Measurement = Reading level + Correct Factor
- 2.Correct Factor=Antenna Factor + Cable Loss - Preamplifier Factor
- 3.Over = Measurement -Limit
- 4.Pre-scan all mode, and found the low channel of Mode 1 which it is worse case, so only show the test data for worse case.

TRF No. RF_R1

Add: West Side of 1/F., Building C, Zone A, Fuyuan New Factory, Jiujiu Industrial Park, Minzhu, Shatou, Shajing, Bao'an District, Shenzhen, Guangdong, China

Tel: +(86) 0755-2985 2678 Fax: +(86) 0755-2985 2397 E-mail: info@gdkesign.cn Web: www.gdkesign.com

4.8. Emissions in frequency bands (above 1GHz)

Test Requirement:	In addition, radiated emissions which fall in the restricted bands, as defined in § 15.205(a), must also comply with the radiated emission limits specified in § 15.209(a)(see § 15.205(c)).		
Test Limit:	Frequency (MHz)	Field strength (microvolts/meter)	Measurement distance (meters)
	0.009-0.490	2400/F(kHz)	300
	0.490-1.705	24000/F(kHz)	30
	1.705-30.0	30	30
	30-88	100 **	3
	88-216	150 **	3
	216-960	200 **	3
	Above 960	500	3
	<p>** Except as provided in paragraph (g), fundamental emissions from intentional radiators operating under this section shall not be located in the frequency bands 54-72 MHz, 76-88 MHz, 174-216 MHz or 470-806 MHz. However, operation within these frequency bands is permitted under other sections of this part, e.g., §§ 15.231 and 15.241.</p> <p>In the emission table above, the tighter limit applies at the band edges.</p> <p>The emission limits shown in the above table are based on measurements employing a CISPR quasi-peak detector except for the frequency bands 9-90 kHz, 110-490 kHz and above 1000 MHz. Radiated emission limits in these three bands are based on measurements employing an average detector.</p>		
Test Method:	ANSI C63.10-2013 section 6.6.4 KDB 558074 D01 15.247 Meas Guidance v05r02		
Procedure:	ANSI C63.10-2013 section 6.6.4		

4.8.1. E.U.T. Operation:

Operating Environment:	
Temperature:	23.5 °C
Humidity:	50.8 %
Atmospheric Pressure:	102 kPa
Final test mode:	Test Mode1, Test Mode2, Test Mode3, Test Mode4

4.8.2. Test Setup Diagram:

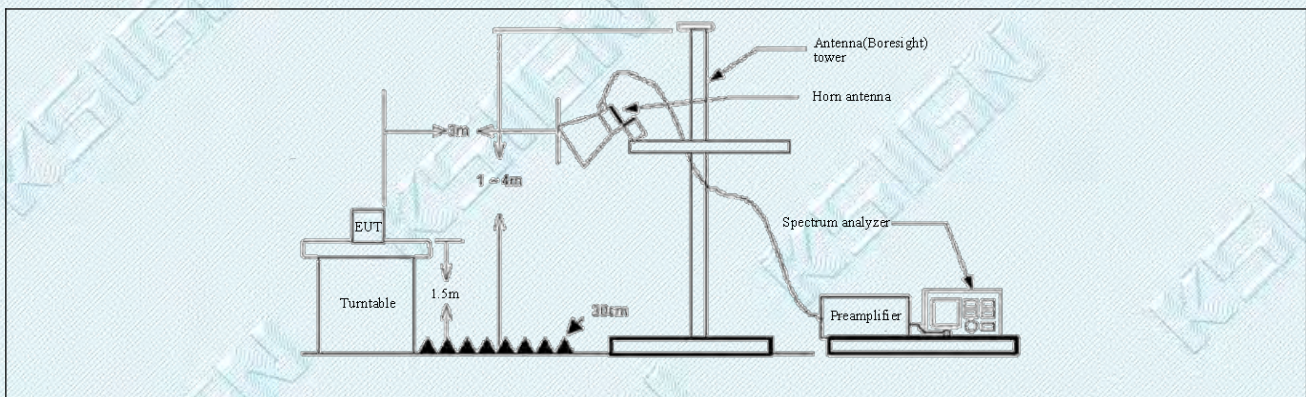

4.8.3. Test Data:

Test Mode1 / Polarization: Horizontal / Band: 2400-2483.5 MHz / BW: 20 / CH: L

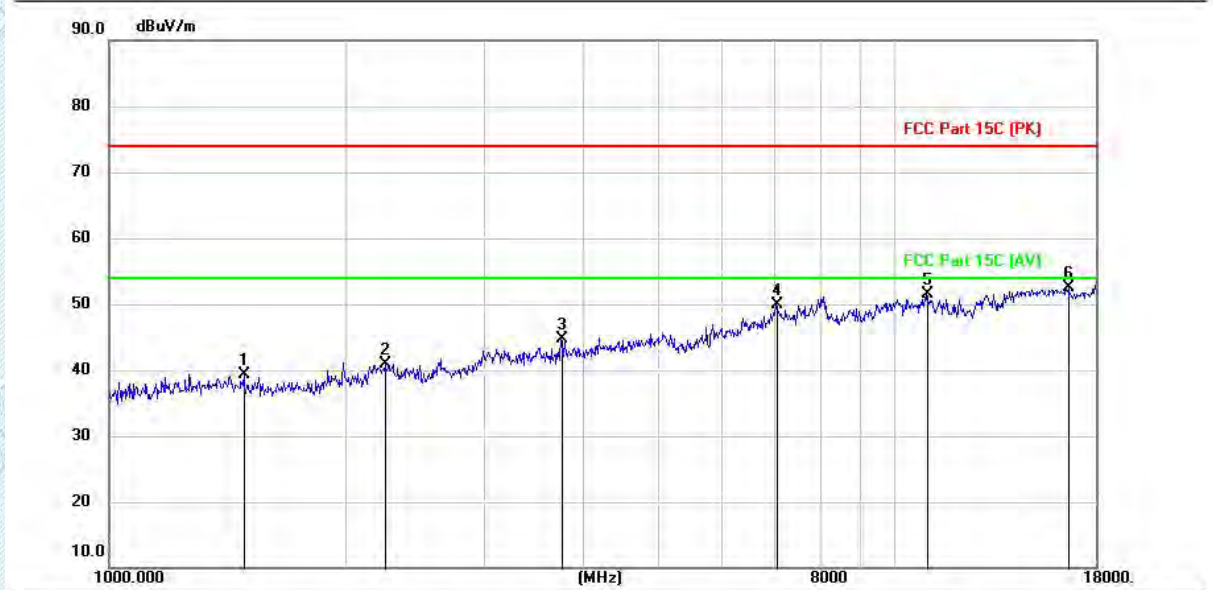

No.	Mk.	Freq. MHz	Reading Level (dBuV)	Correct Factor (dB/m)	Measurement (dBuV/m)	Limit (dBuV/m)	Over (dB)	Detector
1		1484.500	40.72	-1.35	39.37	74.00	-34.63	peak
2		2251.200	39.54	1.34	40.88	74.00	-33.12	peak
3		3762.500	42.85	1.89	44.74	74.00	-29.26	peak
4		7055.400	40.30	9.67	49.97	74.00	-24.03	peak
5		11006.200	37.67	13.91	51.58	74.00	-22.42	peak
6	*	16631.500	36.00	16.43	52.43	74.00	-21.57	peak

Test Mode1 / Polarization: Vertical / Band: 2400-2483.5 MHz / BW: 20 / CH: L

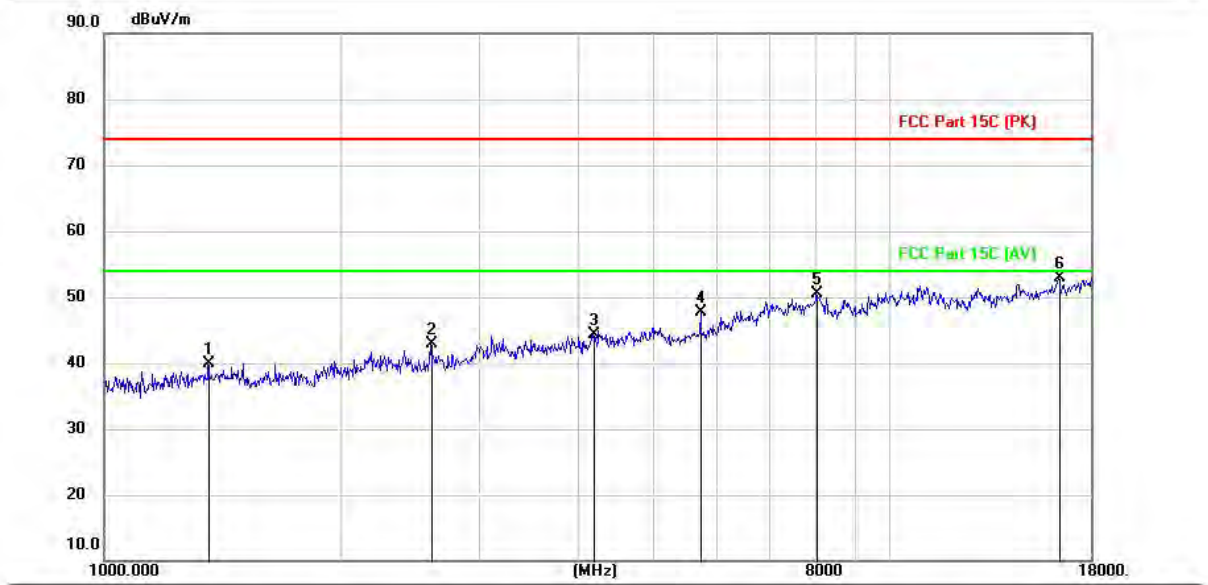

No.	Mk.	Freq. MHz	Reading Level (dBuV)	Correct Factor (dB/m)	Measurement (dBuV/m)	Limit (dBuV/m)	Over (dB)	Detector
1		1357.000	41.03	-1.04	39.99	74.00	-34.01	peak
2		2604.800	41.93	0.92	42.85	74.00	-31.15	peak
3		4189.200	41.45	2.81	44.26	74.00	-29.74	peak
4		5744.700	42.73	4.94	47.67	74.00	-26.33	peak
5		8043.100	39.43	11.13	50.56	74.00	-23.44	peak
6	*	16383.300	37.51	15.39	52.90	74.00	-21.10	peak

TRF No. RF_R1

Add: West Side of 1/F., Building C, Zone A, Fuyuan New Factory, Jiujiu Industrial Park, Minzhu, Shatou, Shajing, Bao'an District, Shenzhen, Guangdong, China

Tel: +(86) 0755-2985 2678 Fax: +(86) 0755-2985 2397 E-mail: info@gdkesign.cn Web: www.gdkesign.com

Test Mode1 / Polarization: Horizontal / Band: 2400-2483.5 MHz / BW: 20 / CH: M

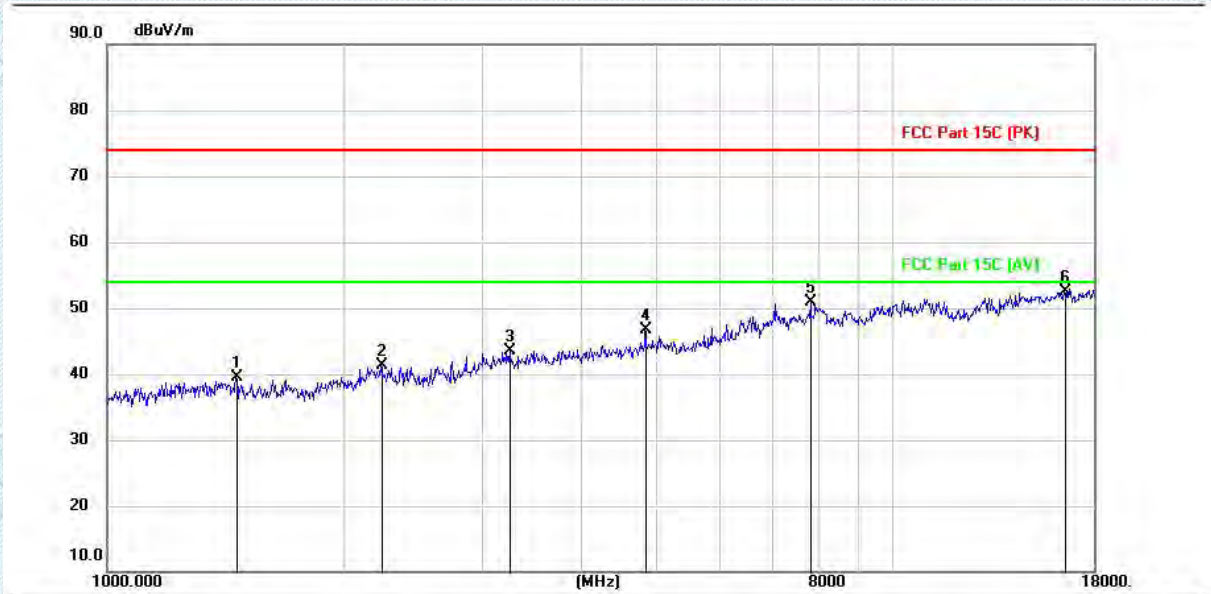

No.	Mk.	Freq. MHz	Reading Level (dBuV)	Correct Factor (dB/m)	Measurement (dBuV/m)	Limit (dBuV/m)	Over (dB)	Detector
1		1459.000	40.87	-1.32	39.55	74.00	-34.45	peak
2		2234.200	39.97	1.38	41.35	74.00	-32.65	peak
3		3261.000	42.27	1.26	43.53	74.00	-30.47	peak
4		4845.400	42.60	4.14	46.74	74.00	-27.26	peak
5		7842.500	40.17	10.64	50.81	74.00	-23.19	peak
6	*	16544.800	36.46	15.95	52.41	74.00	-21.59	peak

TRF No. RF_R1

Add: West Side of 1/F., Building C, Zone A, Fuyuan New Factory, Jiujiu Industrial Park, Minzhu, Shatou, Shajing, Bao'an District, Shenzhen, Guangdong, China

Tel: +(86) 0755-2985 2678 Fax: +(86) 0755-2985 2397 E-mail: info@gdkesign.cn Web: www.gdkesign.com

Test Mode1 / Polarization: Vertical / Band: 2400-2483.5 MHz / BW: 20 / CH: M

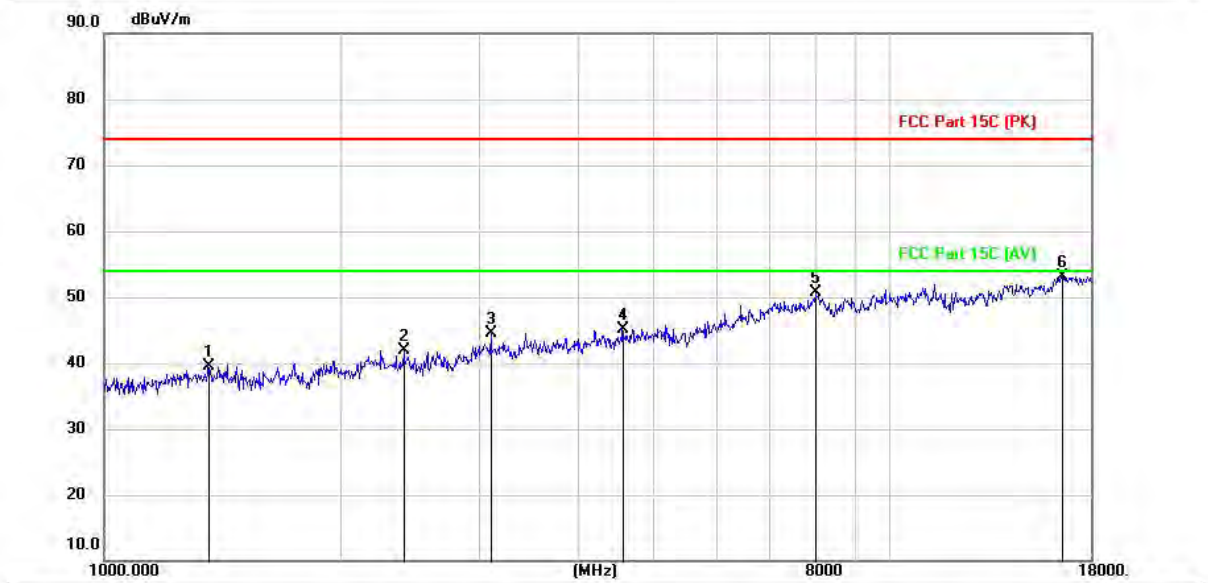

No.	Mk.	Freq. MHz	Reading Level (dBuV)	Correct Factor (dB/m)	Measurement (dBuV/m)	Limit (dBuV/m)	Over (dB)	Detector
1		1355.300	40.44	-1.02	39.42	74.00	-34.58	peak
2		2412.700	41.09	0.88	41.97	74.00	-32.03	peak
3		3111.400	43.08	1.41	44.49	74.00	-29.51	peak
4		4570.000	41.82	3.38	45.20	74.00	-28.80	peak
5		8034.600	39.49	11.12	50.61	74.00	-23.39	peak
6	*	16531.200	37.31	15.86	53.17	74.00	-20.83	peak

TRF No. RF_R1

Add: West Side of 1/F., Building C, Zone A, Fuyuan New Factory, Jiujiu Industrial Park, Minzhu, Shatou, Shajing, Bao'an District, Shenzhen, Guangdong, China

Tel: +(86) 0755-2985 2678 Fax: +(86) 0755-2985 2397 E-mail: info@gdkesign.cn Web: www.gdkesign.com

Test Mode1 / Polarization: Horizontal / Band: 2400-2483.5 MHz / BW: 20 / CH: H

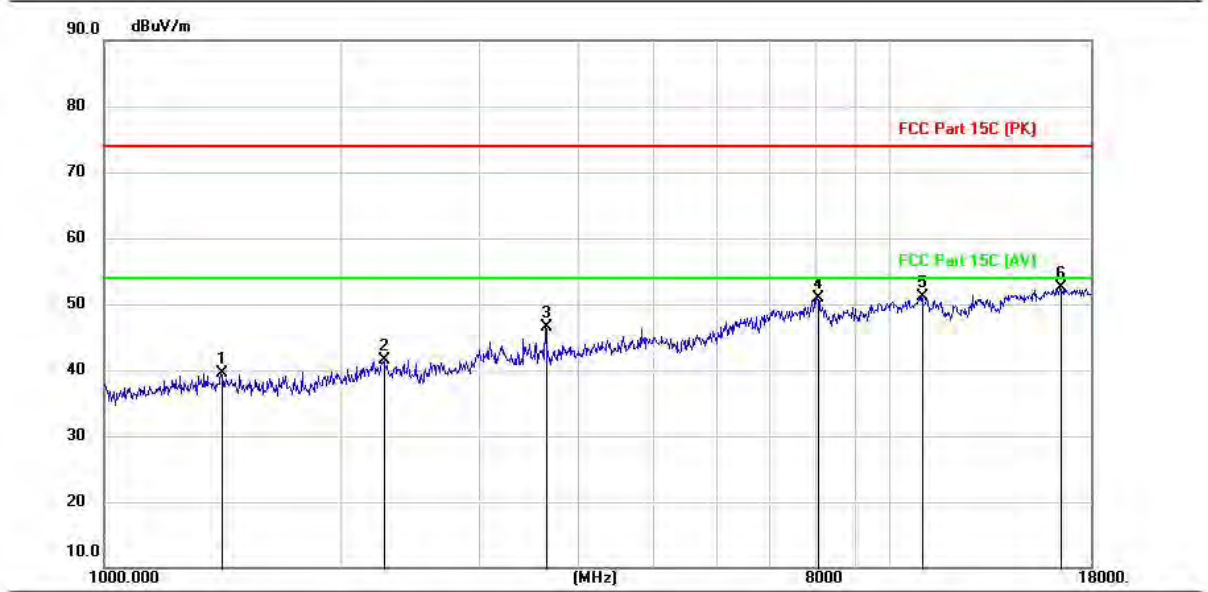

No.	Mk.	Freq. MHz	Reading Level (dBuV)	Correct Factor (dB/m)	Measurement (dBuV/m)	Limit (dBuV/m)	Over (dB)	Detector
1		1408.000	40.90	-1.39	39.51	74.00	-34.49	peak
2		2278.400	40.29	1.23	41.52	74.00	-32.48	peak
3		3645.200	44.87	1.68	46.55	74.00	-27.45	peak
4		8075.400	39.96	11.01	50.97	74.00	-23.03	peak
5		10992.600	37.28	13.92	51.20	74.00	-22.80	peak
6	*	16458.100	36.84	15.57	52.41	74.00	-21.59	peak

TRF No. RF_R1

Add: West Side of 1/F., Building C, Zone A, Fuyuan New Factory, Jiujiu Industrial Park, Minzhu, Shatou, Shajing, Bao'an District, Shenzhen, Guangdong, China

Tel: +(86) 0755-2985 2678 Fax: +(86) 0755-2985 2397 E-mail: info@gdkesign.cn Web: www.gdkesign.com

Test Mode1 / Polarization: Vertical / Band: 2400-2483.5 MHz / BW: 20 / CH: H

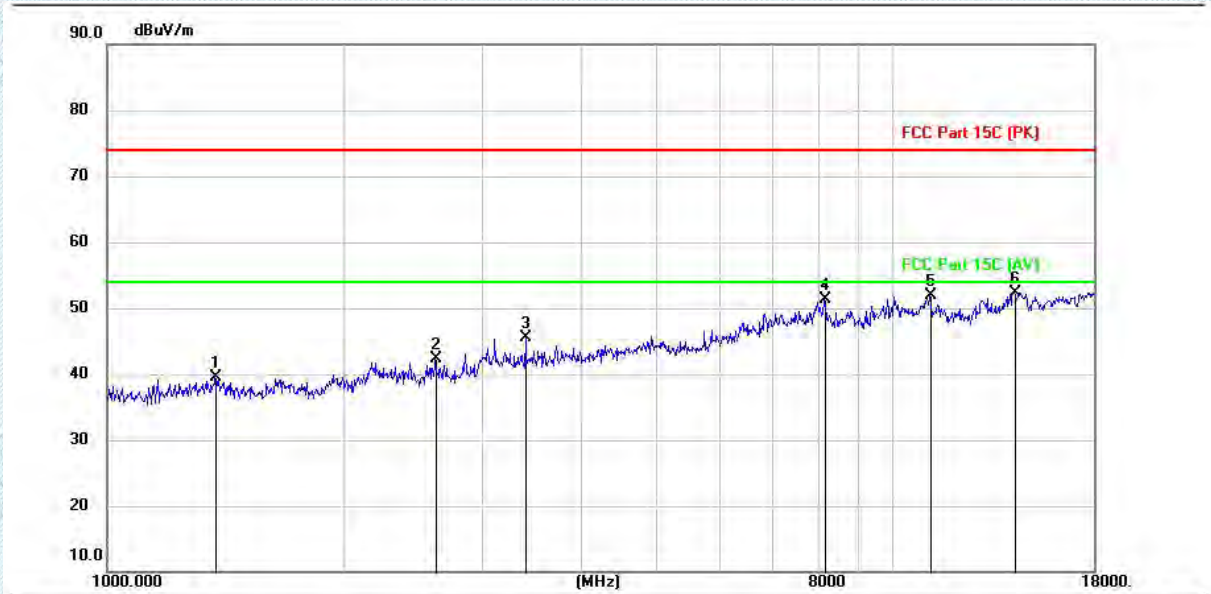

No.	Mk.	Freq. MHz	Reading Level (dBuV)	Correct Factor (dB/m)	Measurement (dBuV/m)	Limit (dBuV/m)	Over (dB)	Detector
1		1372.300	40.73	-1.17	39.56	74.00	-34.44	peak
2		2618.400	41.46	0.93	42.39	74.00	-31.61	peak
3		3412.300	44.23	1.20	45.43	74.00	-28.57	peak
4		8160.400	40.47	10.84	51.31	74.00	-22.69	peak
5		11140.500	38.23	13.58	51.81	74.00	-22.19	peak
6	*	14265.100	35.11	17.25	52.36	74.00	-21.64	peak

Note:

- 1.Measurement = Reading level + Correct Factor
Correct Factor=Antenna Factor + Cable Loss - Preamplifier Factor
Over = Measurement -Limit
- 2.Pre-scan all mode, and found the B mode which it is worse case, so only show the test data for worse case.
3. Since the peak value is less than the limit of the AVG value, there is no AVG data.
- 4.From 18GHz to 26.5GHz,the amplitude of spurious emissions which are attenuated by more than 20dB below the permissible value has no need to be reported.

TRF No. RF_R1

Add: West Side of 1/F., Building C, Zone A, Fuyuan New Factory, Jiujiu Industrial Park, Minzhu, Shatou, Shajing, Bao'an District, Shenzhen, Guangdong, China

Tel: +(86) 0755-2985 2678 Fax: +(86) 0755-2985 2397 E-mail: info@gdkesign.cn Web: www.gdkesign.com

5. EUT TEST PHOTOS

Conducted Emission at AC power line



Emissions in frequency bands (below 1GHz)



Emissions in frequency bands (above 1GHz)



RF



6. PHOTOGRAPHS OF EUT CONSTRUCTIONAL

Refer to Appendix - EUT Photos for KS2409S3823E

Appendix

6.1. Appendix A: DTS Bandwidth

6.1.1. Test Result

TestMode	Antenna	Frequency [MHz]	DTS BW [MHz]	FL[MHz]	FH[MHz]	Limit[MHz]	Verdict
11B	Ant1	2412	10.00	2407.08	2417.08	0.5	PASS
		2437	10.04	2432.04	2442.08	0.5	PASS
		2462	9.56	2457.52	2467.08	0.5	PASS
11G	Ant1	2412	16.40	2403.88	2420.28	0.5	PASS
		2437	16.48	2428.80	2445.28	0.5	PASS
		2462	16.48	2453.80	2470.28	0.5	PASS
11N20SISO	Ant1	2412	17.60	2403.28	2420.88	0.5	PASS
		2437	17.60	2428.28	2445.88	0.5	PASS
		2462	17.60	2453.28	2470.88	0.5	PASS
11N40SISO	Ant1	2422	36.32	2403.92	2440.24	0.5	PASS
		2437	36.32	2418.92	2455.24	0.5	PASS
		2452	36.32	2433.92	2470.24	0.5	PASS

6.1.2. Test Graphs

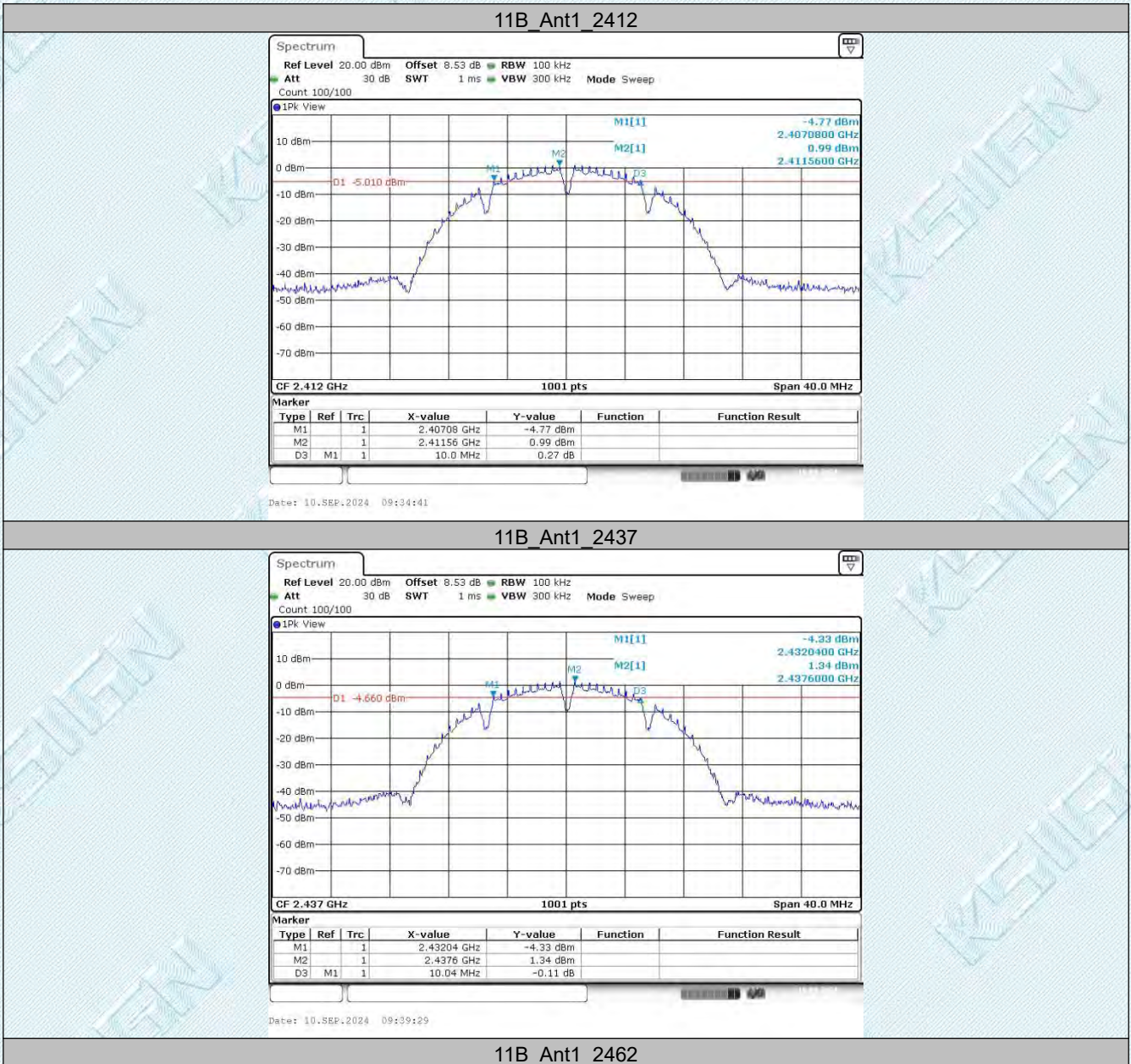

TRF No. RF_R1

Add: West Side of 1/F., Building C, Zone A, Fuyuan New Factory, Jiujiu Industrial Park, Minzhu, Shatou, Shajing, Bao'an District, Shenzhen, Guangdong, China

Tel: +(86) 0755-2985 2678 Fax: +(86) 0755-2985 2397 E-mail: info@gdksign.cn Web: www.gdksign.com

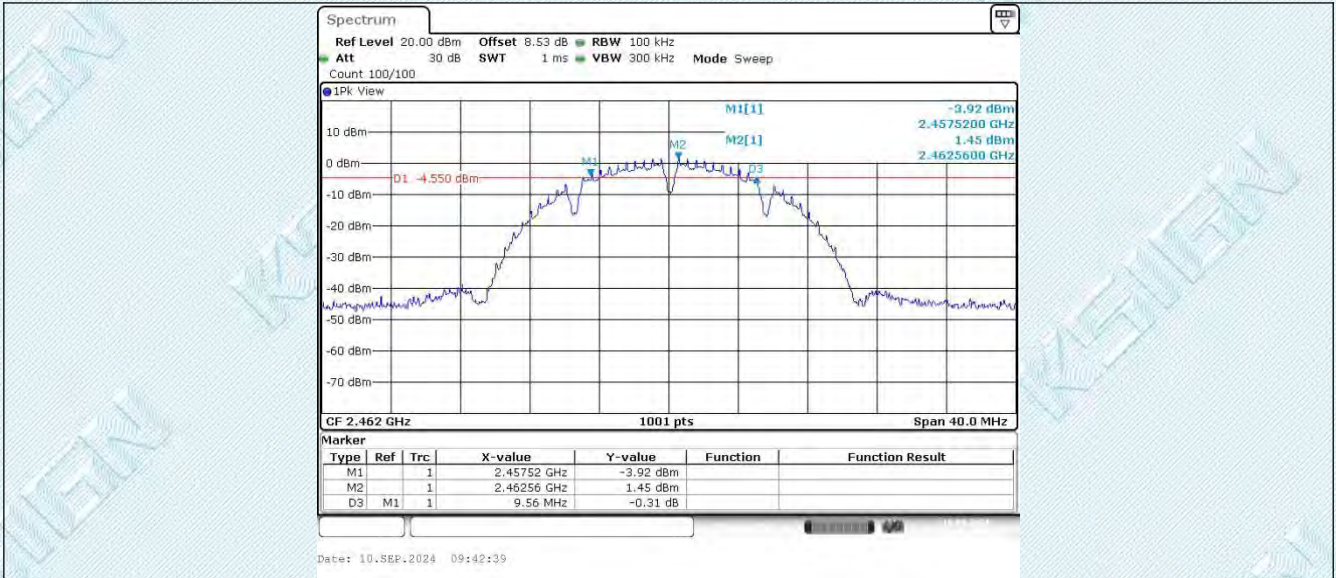

11G_Ant1_2412

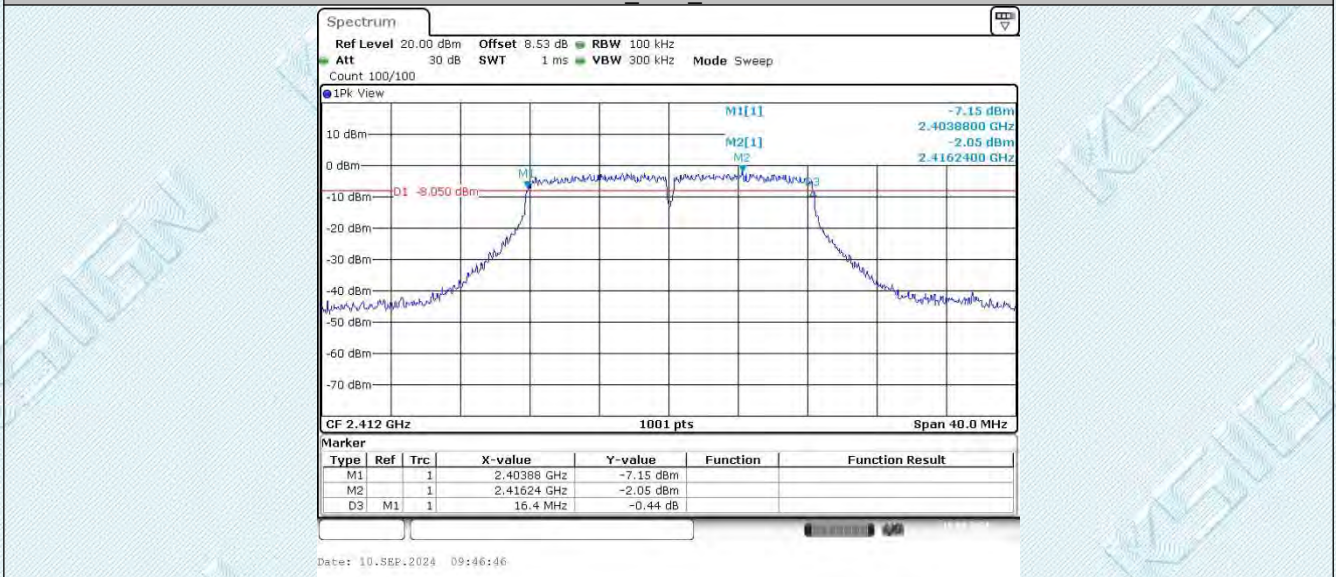

11G_Ant1_2437

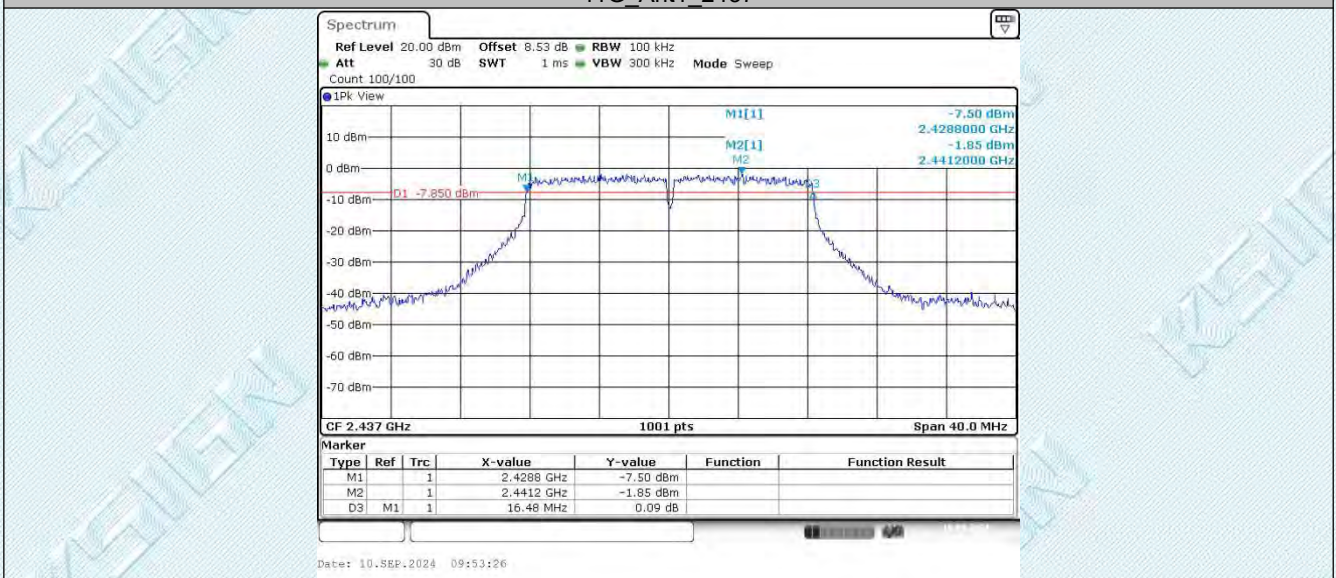

11G_Ant1_2462

TRF No. RF_R1

Add: West Side of 1/F., Building C, Zone A, Fuyuan New Factory, Jiujiu Industrial Park, Minzhu, Shatou, Shajing, Bao'an District, Shenzhen, Guangdong, China

Tel: +(86) 0755-2985 2678 Fax: +(86) 0755-2985 2397 E-mail: info@gdkesign.cn Web: www.gdkesign.com

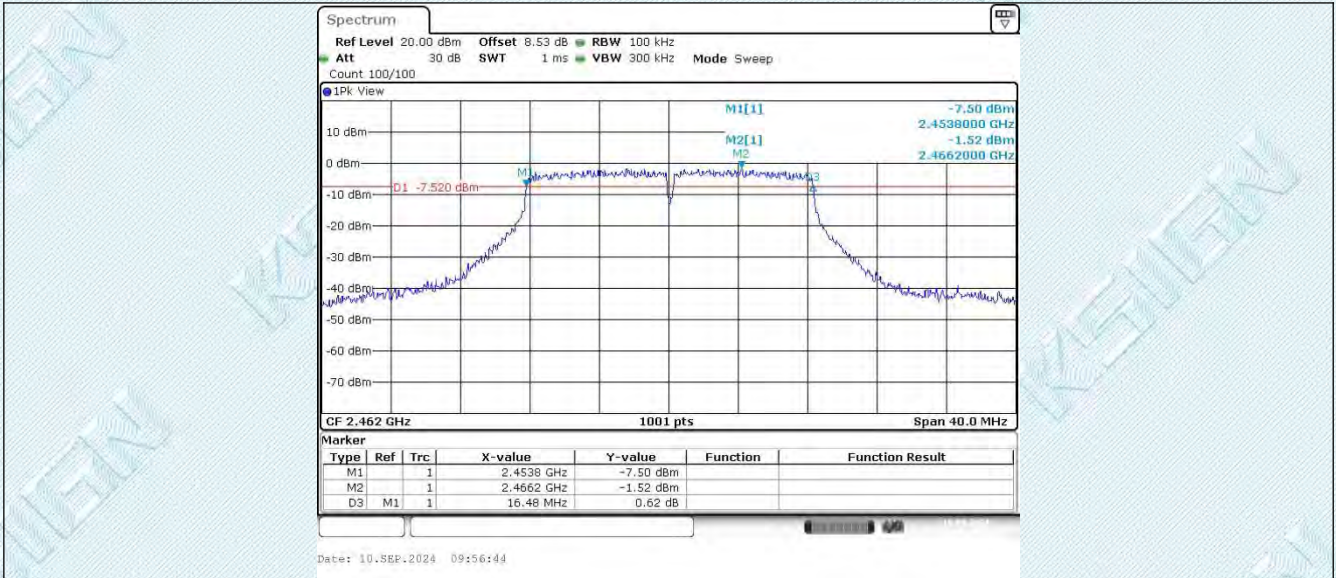

11N20SISO_Ant1_2412

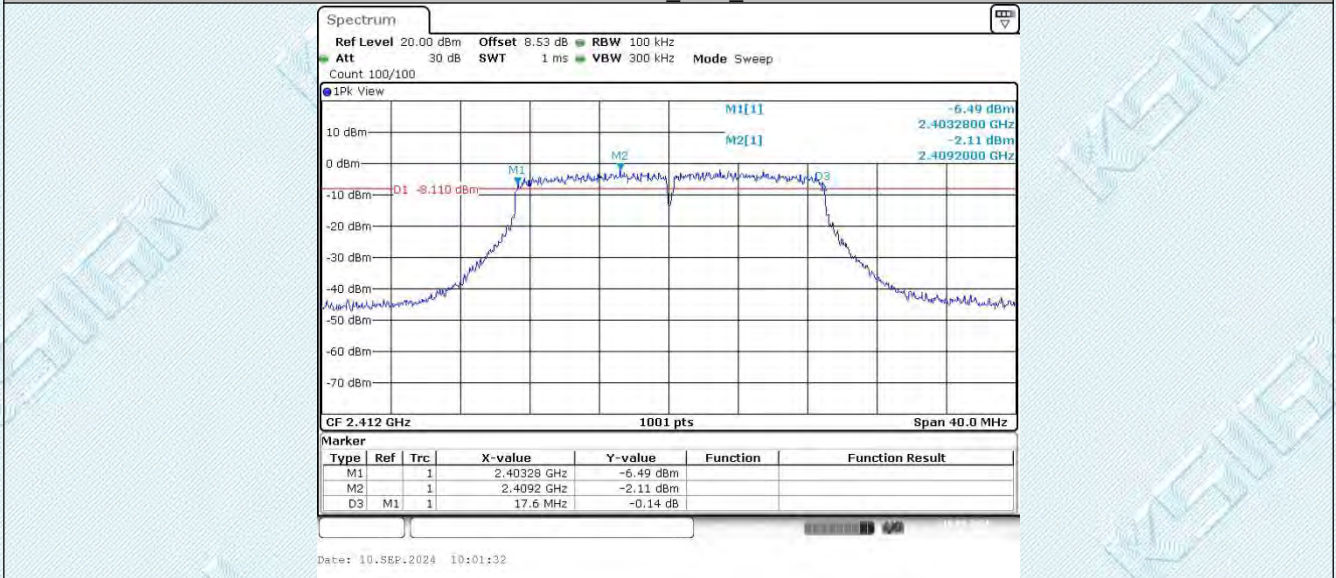

11N20SISO_Ant1_2437

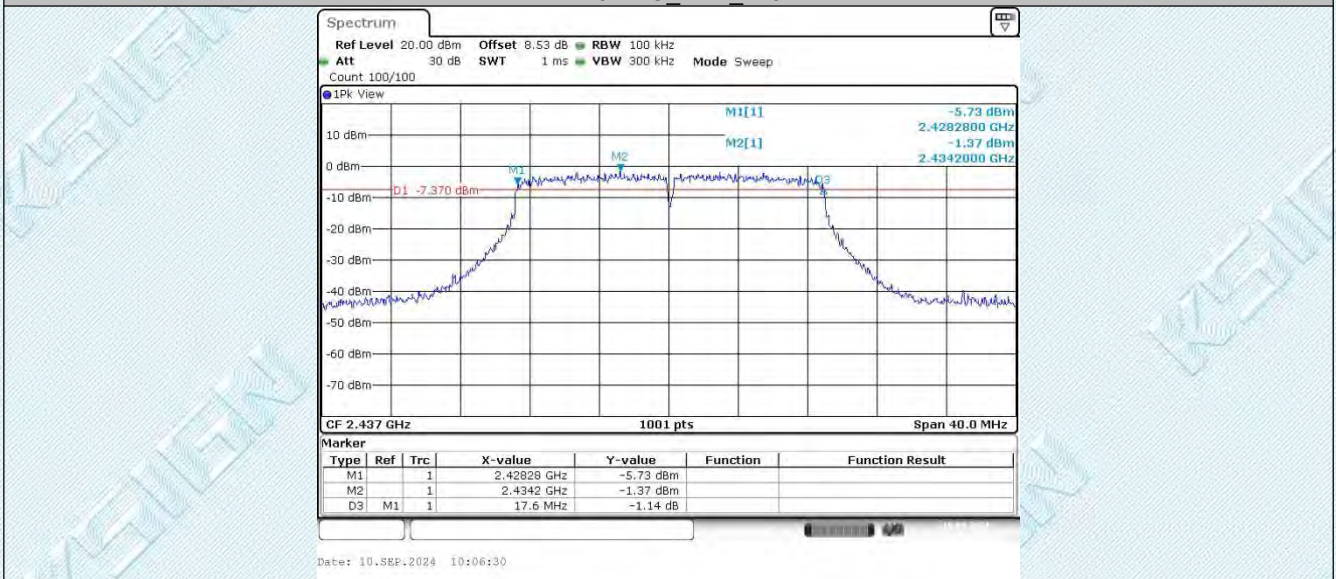

11N20SISO_Ant1_2462

TRF No. RF_R1

Add: West Side of 1/F., Building C, Zone A, Fuyuan New Factory, Jiujiu Industrial Park, Minzhu, Shatou, Shajing, Bao'an District, Shenzhen, Guangdong, China

Tel: +(86) 0755-2985 2678 Fax: +(86) 0755-2985 2397 E-mail: info@gdkesign.cn Web: www.gdkesign.com

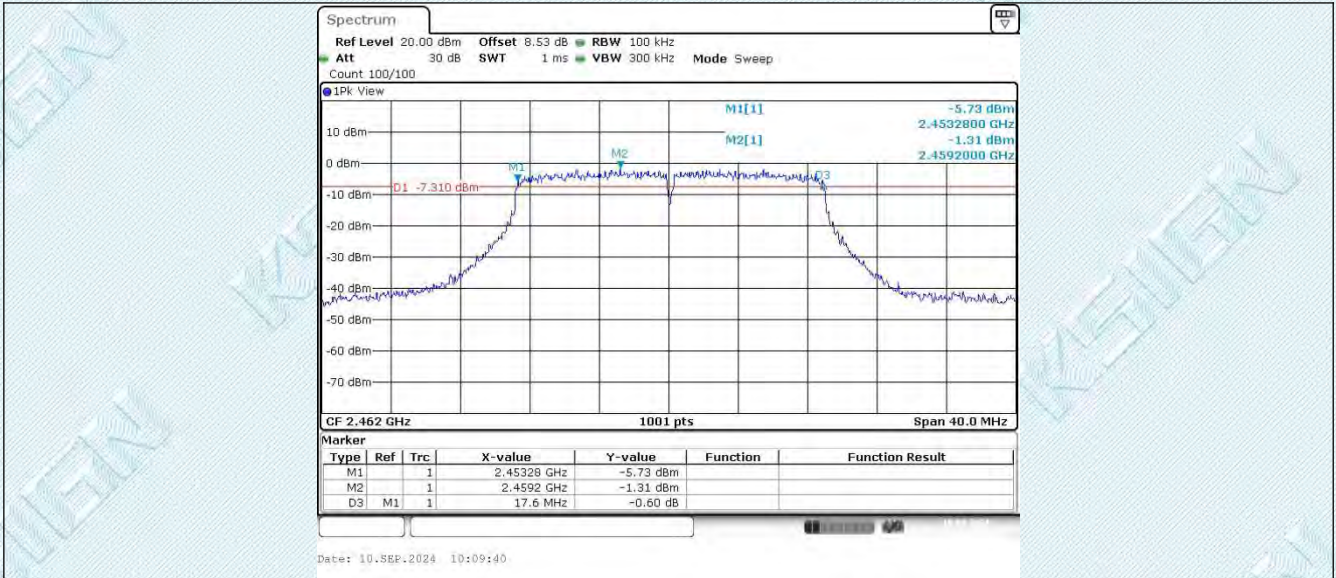

11N40SISO_Ant1_2422

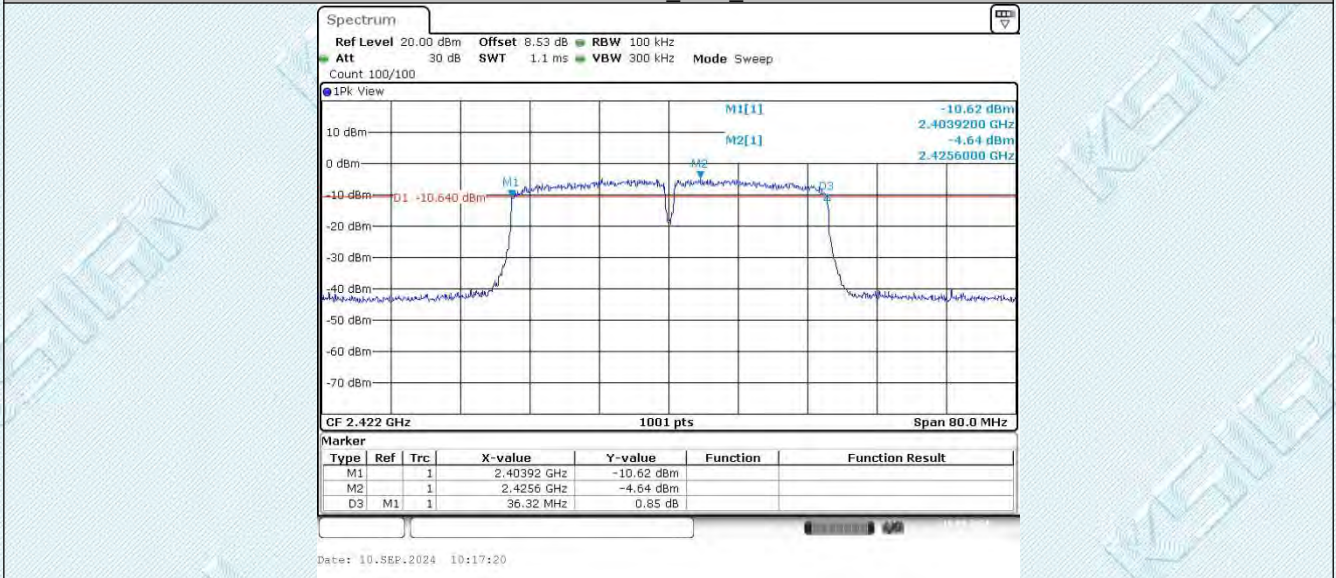

11N40SISO_Ant1_2437

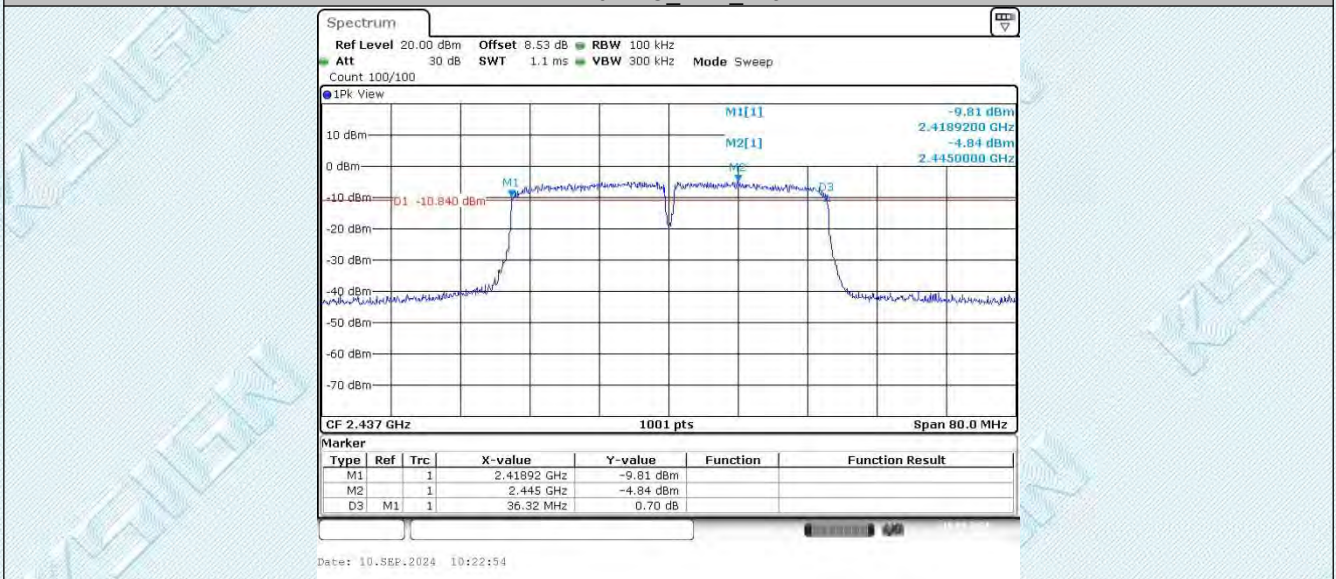

11N40SISO_Ant1_2452

TRF No. RF_R1

Add: West Side of 1/F., Building C, Zone A, Fuyuan New Factory, Jiujiu Industrial Park, Minzhu, Shatou, Shajing, Bao'an District, Shenzhen, Guangdong, China

Tel: +(86) 0755-2985 2678 Fax: +(86) 0755-2985 2397 E-mail: info@gdkesign.cn Web: www.gdkesign.com

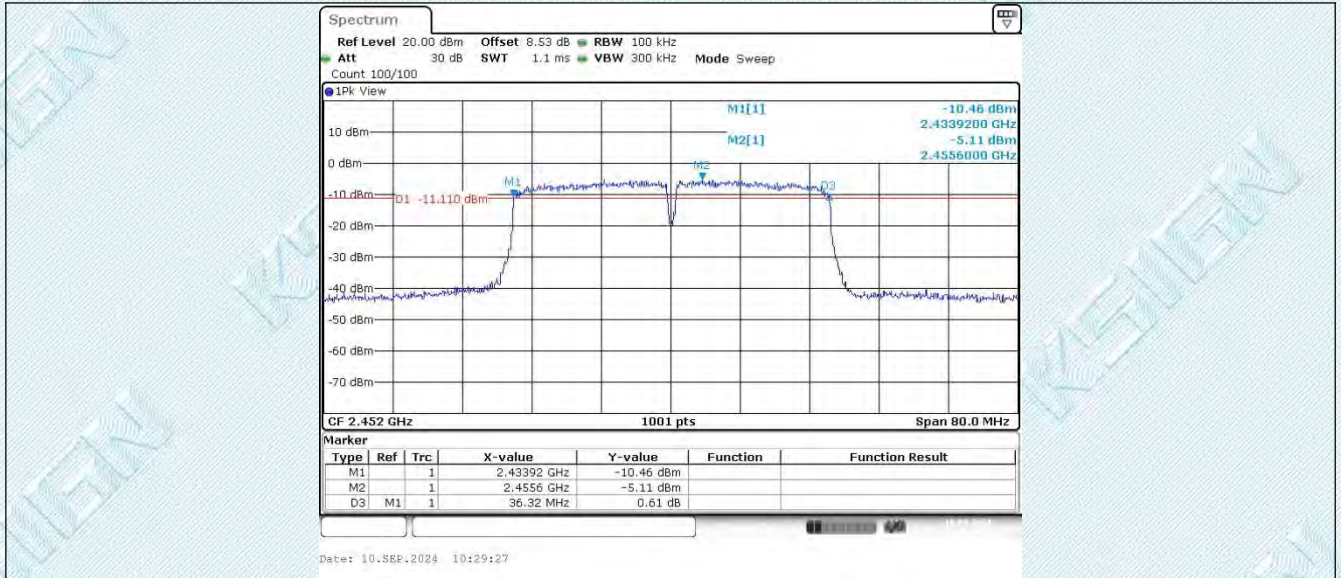

TRF No. RF_R1

Add: West Side of 1/F., Building C, Zone A, Fuyuan New Factory, Jiujiu Industrial Park, Minzhu, Shatou, Shajing, Bao'an District, Shenzhen, Guangdong, China

Tel: +(86) 0755-2985 2678 Fax: +(86) 0755-2985 2397 E-mail: info@gdkesign.cn Web: www.gdkesign.com

6.2. Appendix B: Occupied Channel Bandwidth

6.2.1. Test Result

TestMode	Antenna	Channel Frequency[MHz]	OCB [MHz]	FL[MHz]	FH[MHz]	Limit[MHz]	Verdict
11B	Ant1	2412	14.745	2404.727	2419.473	---	---
		2437	14.785	2429.607	2444.393	---	---
		2462	14.745	2454.647	2469.393	---	---
11G	Ant1	2412	17.223	2403.329	2420.551	---	---
		2437	17.263	2428.249	2445.511	---	---
		2462	17.223	2453.289	2470.511	---	---
11N20SISO	Ant1	2412	18.102	2403.009	2421.111	---	---
		2437	18.142	2427.969	2446.111	---	---
		2462	18.102	2452.969	2471.071	---	---
11N40SISO	Ant1	2422	35.804	2404.178	2439.982	---	---
		2437	35.884	2419.178	2455.062	---	---
		2452	35.884	2434.178	2470.062	---	---

6.2.2. Test Graphs



TRF No. RF_R1

Add: West Side of 1/F., Building C, Zone A, Fuyuan New Factory, Jiujiu Industrial Park, Minzhu, Shatou, Shajing, Bao'an District, Shenzhen, Guangdong, China

Tel: +(86) 0755-2985 2678 Fax: +(86) 0755-2985 2397 E-mail: info@gdksign.cn Web: www.gdksign.com



11G_Ant1_2412

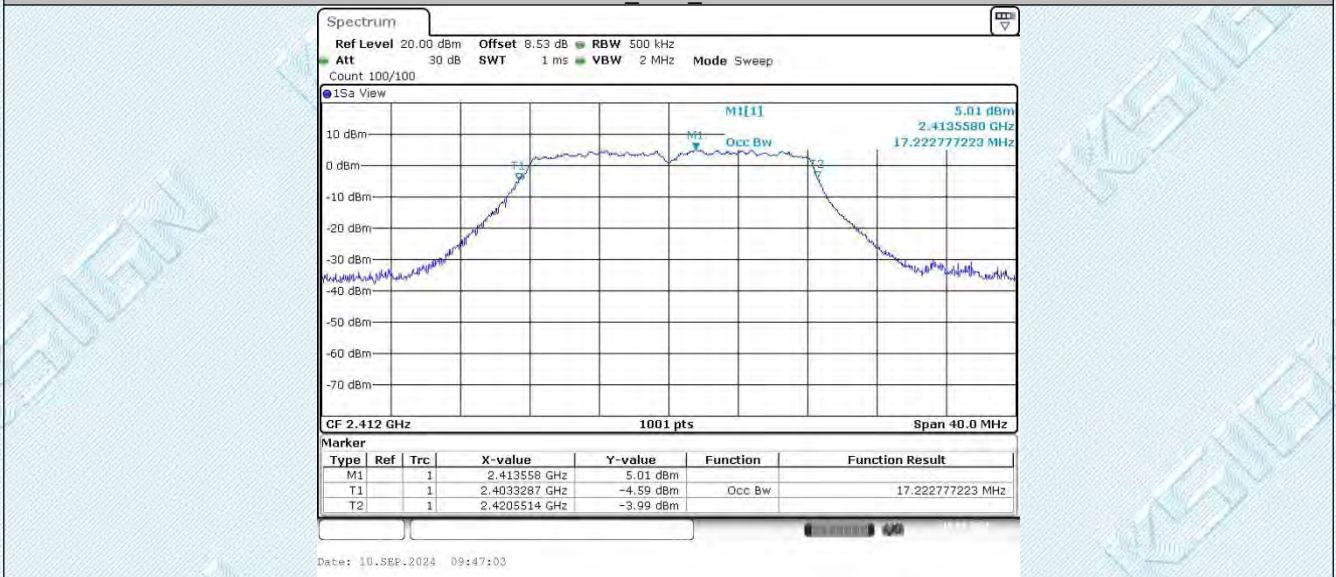

11G_Ant1_2437

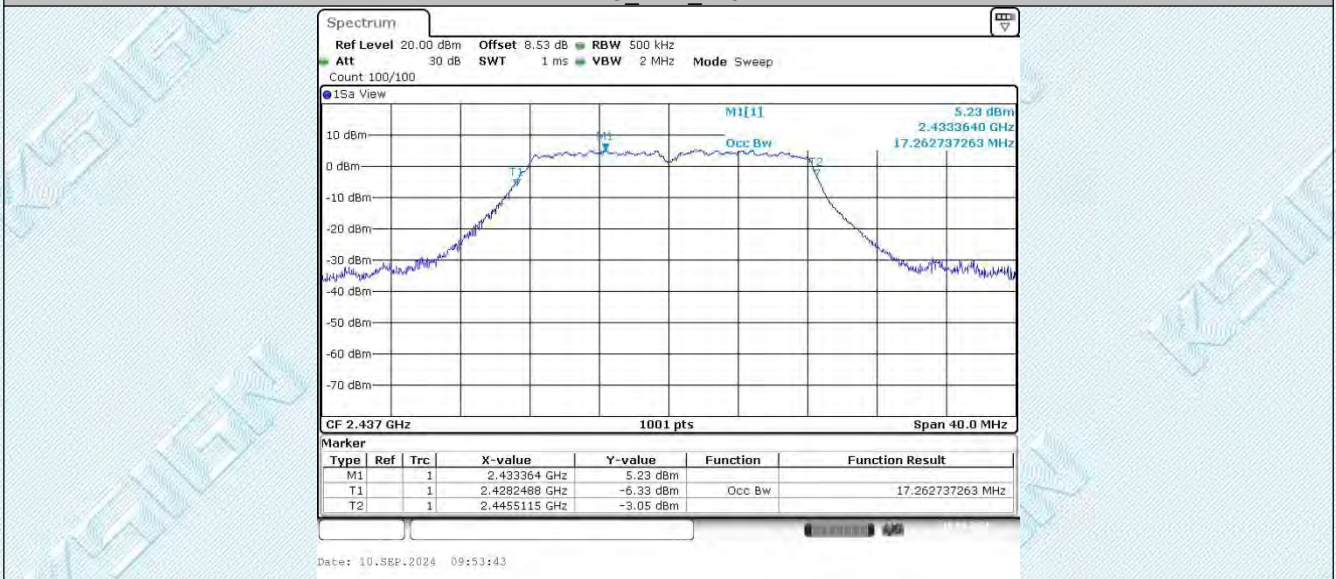

11G_Ant1_2462

TRF No. RF_R1

Add: West Side of 1/F., Building C, Zone A, Fuyuan New Factory, Jiujiu Industrial Park, Minzhu, Shatou, Shajing, Bao'an District, Shenzhen, Guangdong, China

Tel: +(86) 0755-2985 2678 Fax: +(86) 0755-2985 2397 E-mail: info@gdkesign.cn Web: www.gdkesign.com

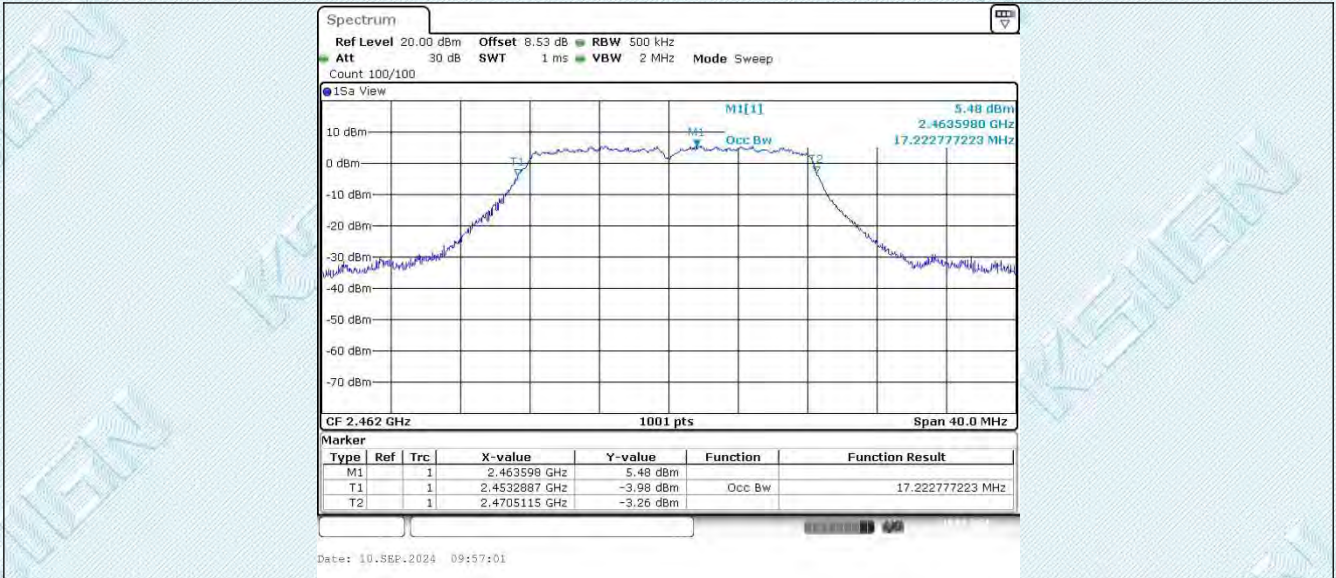

11N20SISO_Ant1_2412

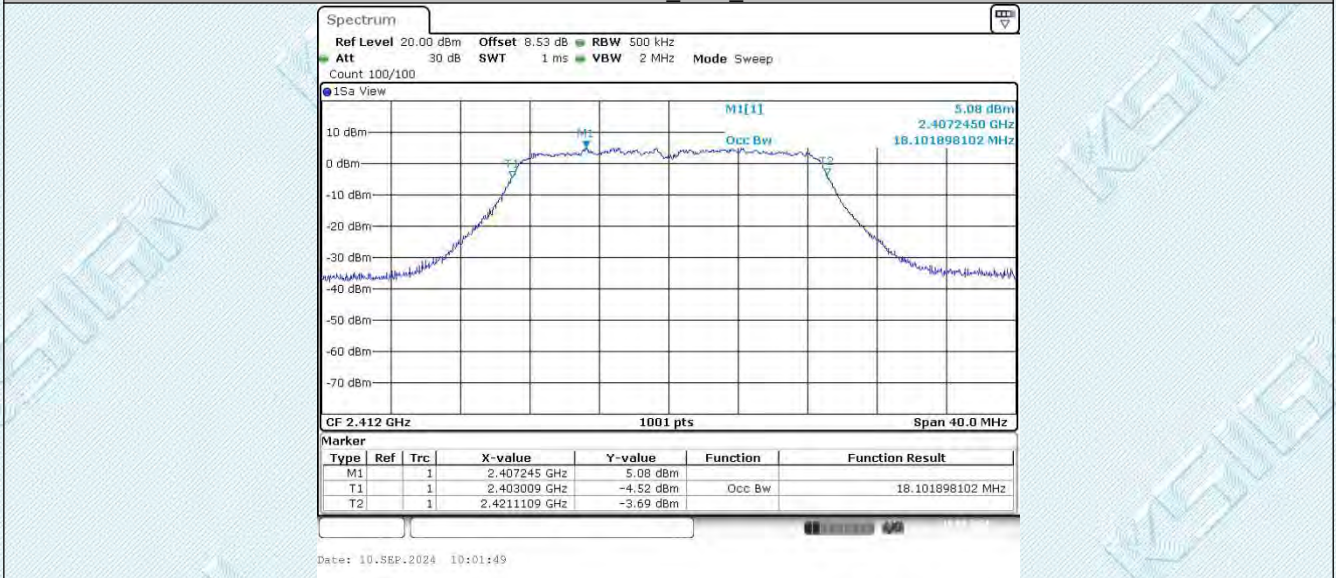

11N20SISO_Ant1_2437

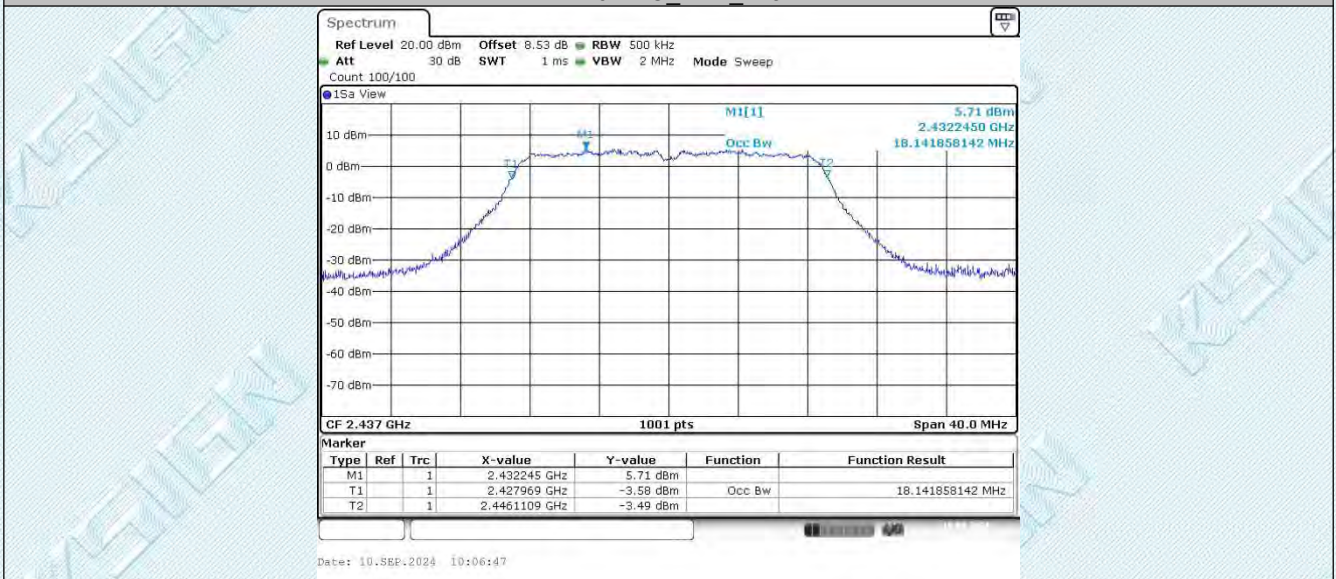

11N20SISO_Ant1_2462

TRF No. RF_R1

Add: West Side of 1/F., Building C, Zone A, Fuyuan New Factory, Jiujiu Industrial Park, Minzhu, Shatou, Shajing, Bao'an District, Shenzhen, Guangdong, China

Tel: +(86) 0755-2985 2678 Fax: +(86) 0755-2985 2397 E-mail: info@gdksign.cn Web: www.gdksign.com

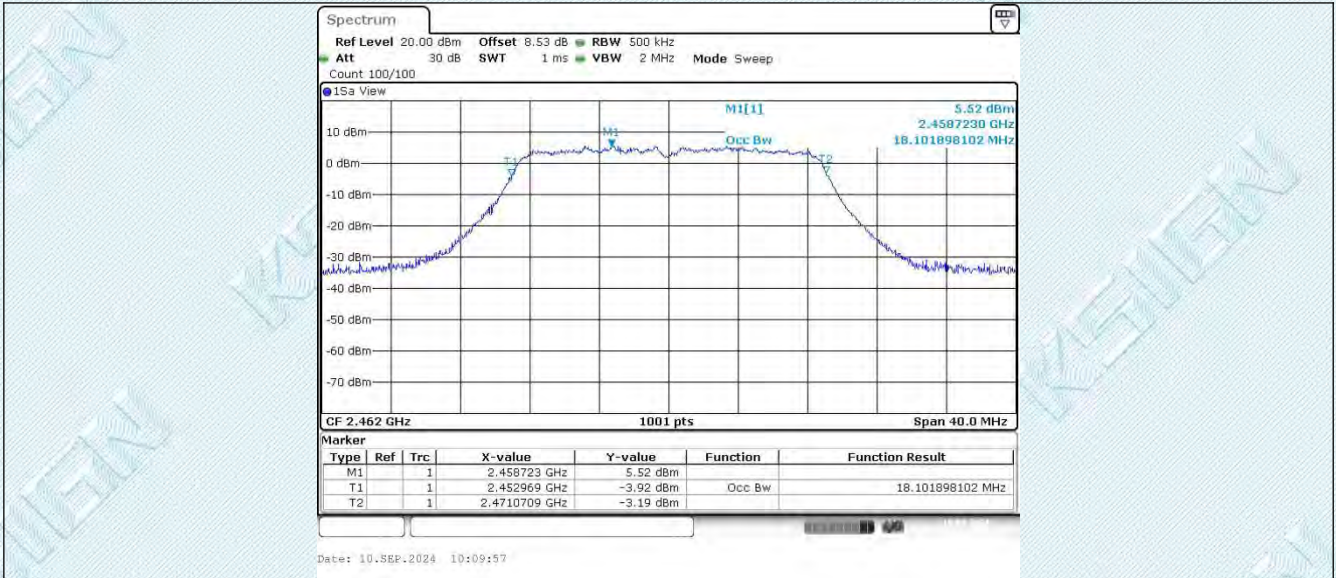

11N40SISO_Ant1_2422

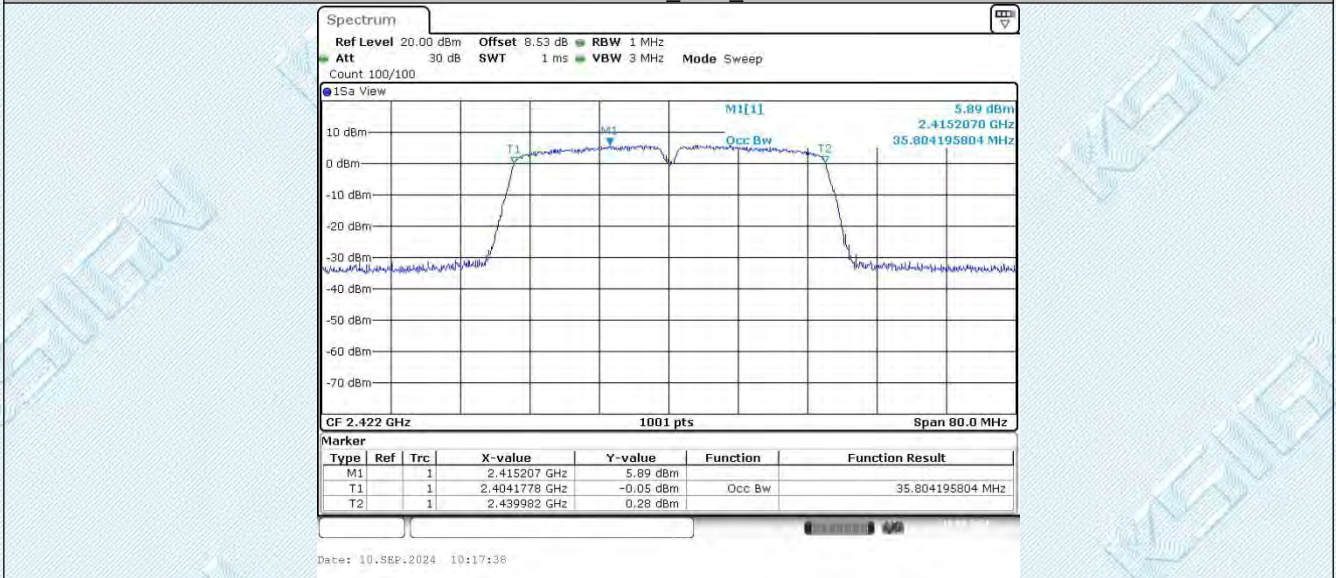

11N40SISO_Ant1_2437

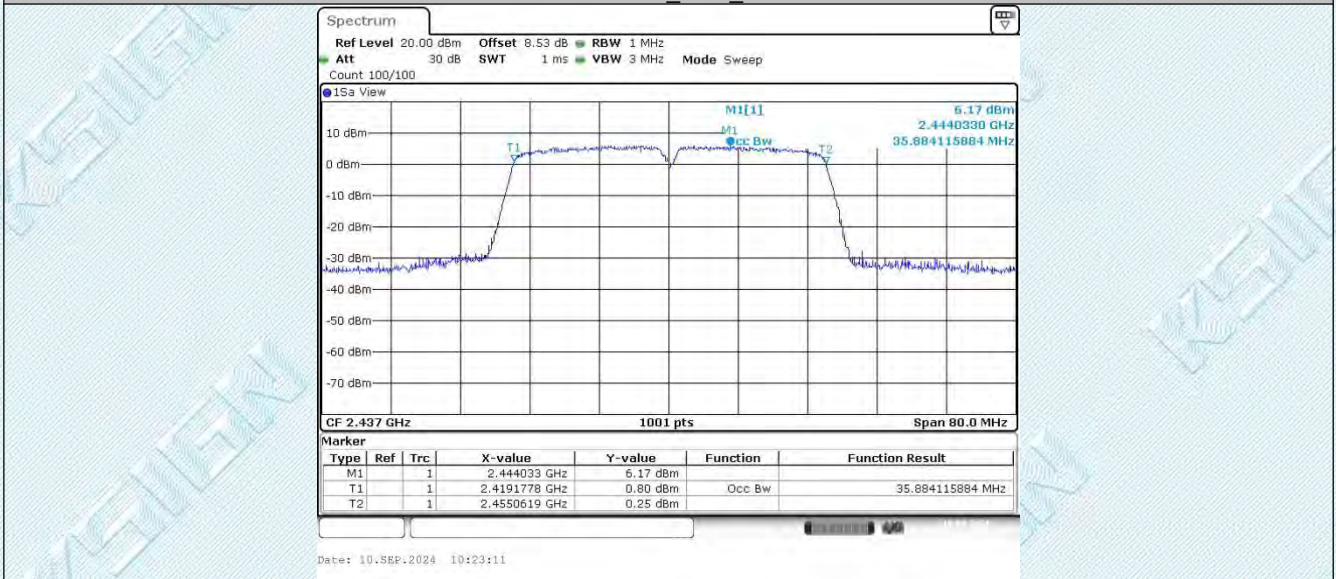

11N40SISO_Ant1_2452

TRF No. RF_R1

Add: West Side of 1/F., Building C, Zone A, Fuyuan New Factory, Jiujiu Industrial Park, Minzhu, Shatou, Shajing, Bao'an District, Shenzhen, Guangdong, China

Tel: +(86) 0755-2985 2678 Fax: +(86) 0755-2985 2397 E-mail: info@gdkesign.cn Web: www.gdkesign.com

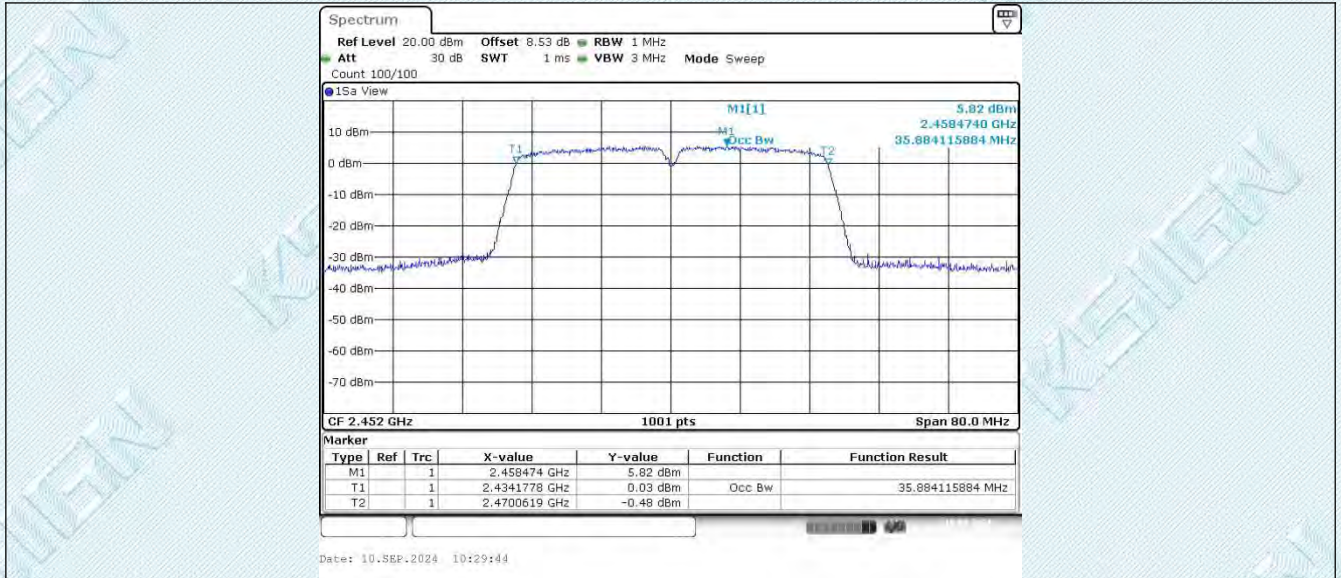

TRF No. RF_R1

Add: West Side of 1/F., Building C, Zone A, Fuyuan New Factory, Jiujiu Industrial Park, Minzhu, Shatou, Shajing, Bao'an District, Shenzhen, Guangdong, China

Tel: +(86) 0755-2985 2678 Fax: +(86) 0755-2985 2397 E-mail: info@gdkesign.cn Web: www.gdkesign.com

6.3. Appendix C: Maximum conducted output power

6.3.1. Test Result

TestMode	Antenna	Frequency[MHz]	Power[dBm]	Conducted Limit[dBm]	Verdict
11B	Ant1	2412	13.15	≤30.00	PASS
		2437	12.34	≤30.00	PASS
		2462	12.45	≤30.00	PASS
11G	Ant1	2412	16.05	≤30.00	PASS
		2437	17.02	≤30.00	PASS
		2462	17.05	≤30.00	PASS
11N20SISO	Ant1	2412	16.30	≤30.00	PASS
		2437	16.11	≤30.00	PASS
		2462	16.12	≤30.00	PASS
11N40SISO	Ant1	2422	16.30	≤30.00	PASS
		2437	15.95	≤30.00	PASS
		2452	15.91	≤30.00	PASS

6.3.2. Test Graphs



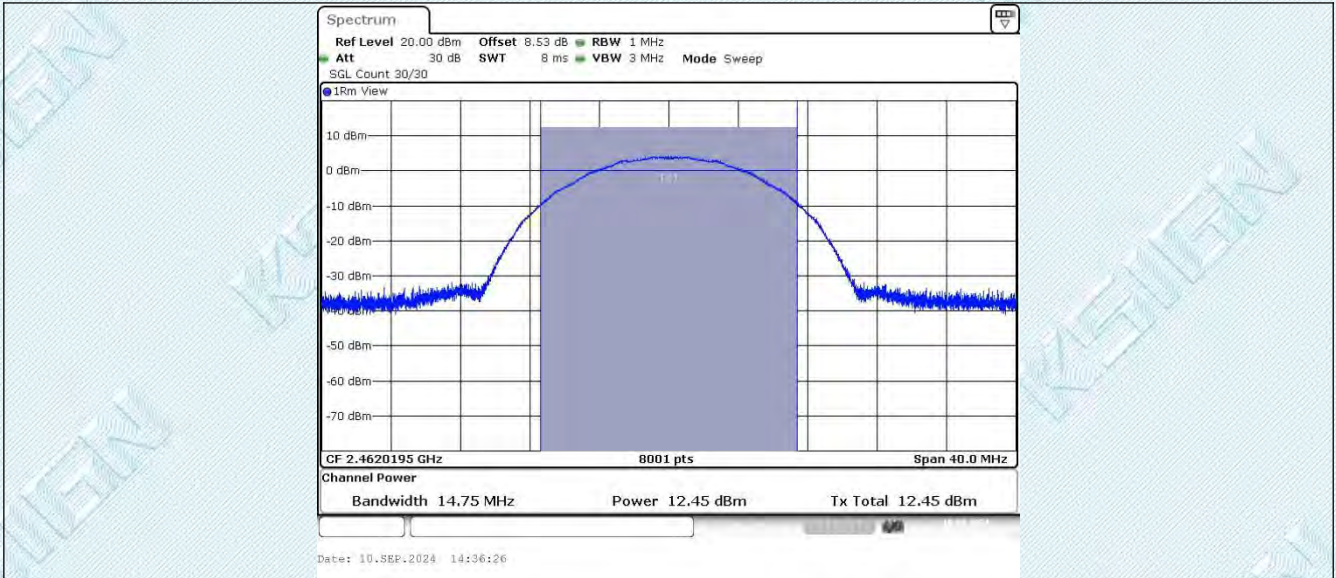

11G_Ant1_2412

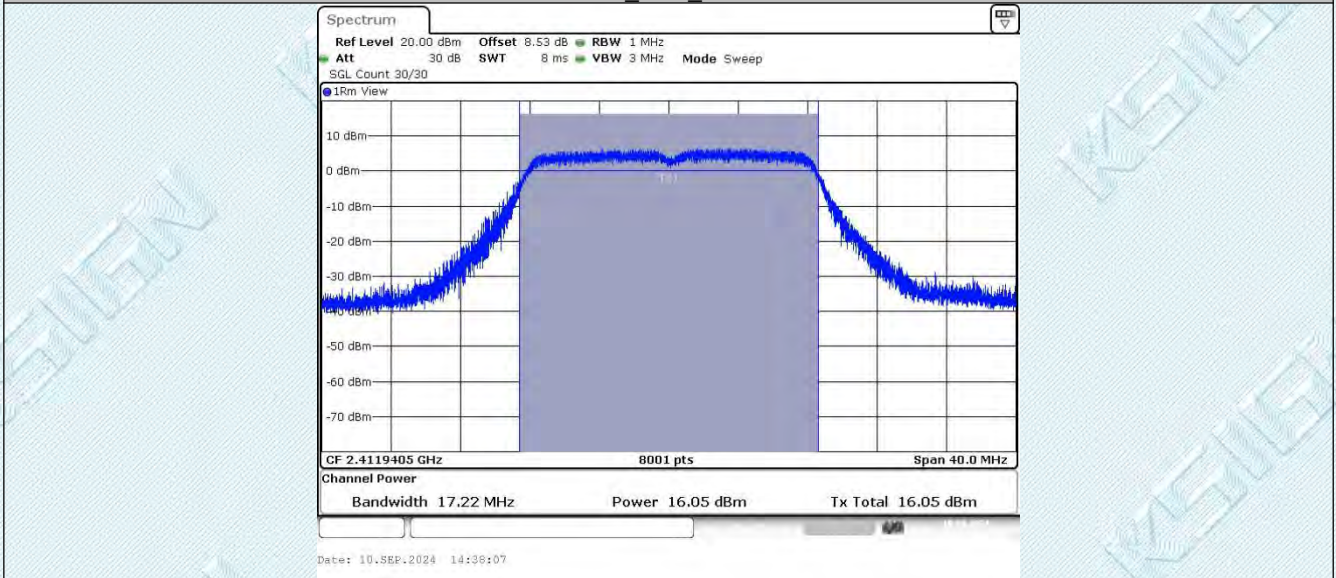

11G_Ant1_2437

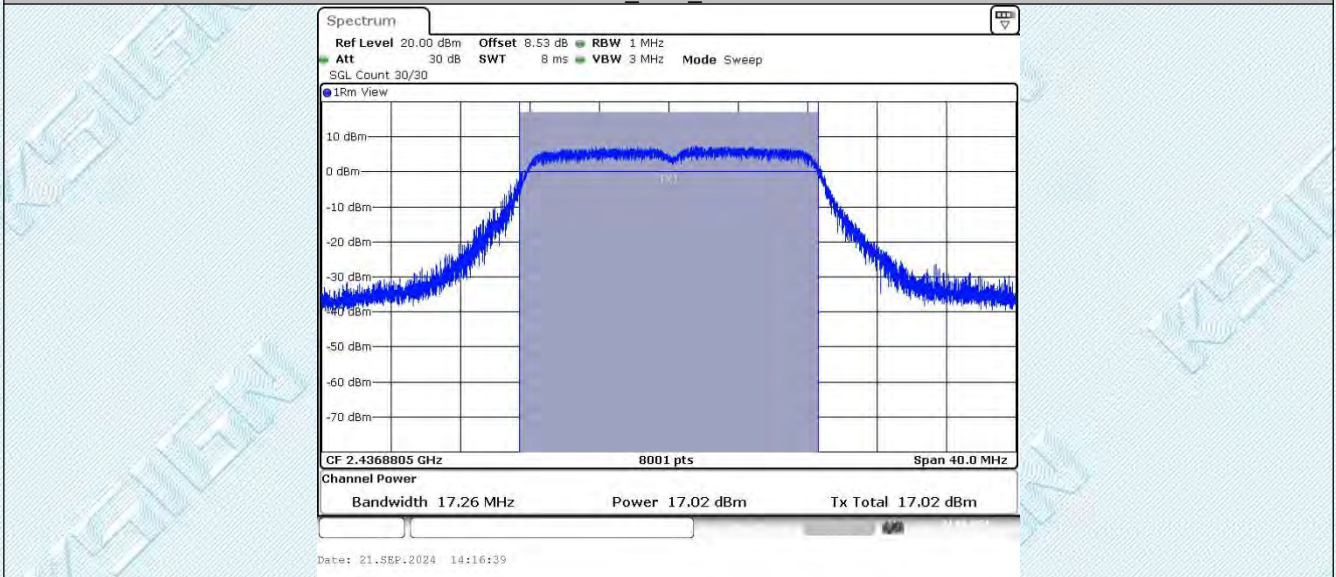

11G_Ant1_2462

TRF No. RF_R1

Add: West Side of 1/F., Building C, Zone A, Fuyuan New Factory, Jiujiu Industrial Park, Minzhu, Shatou, Shajing, Bao'an District, Shenzhen, Guangdong, China

Tel: +(86) 0755-2985 2678 Fax: +(86) 0755-2985 2397 E-mail: info@gdkesign.cn Web: www.gdkesign.com

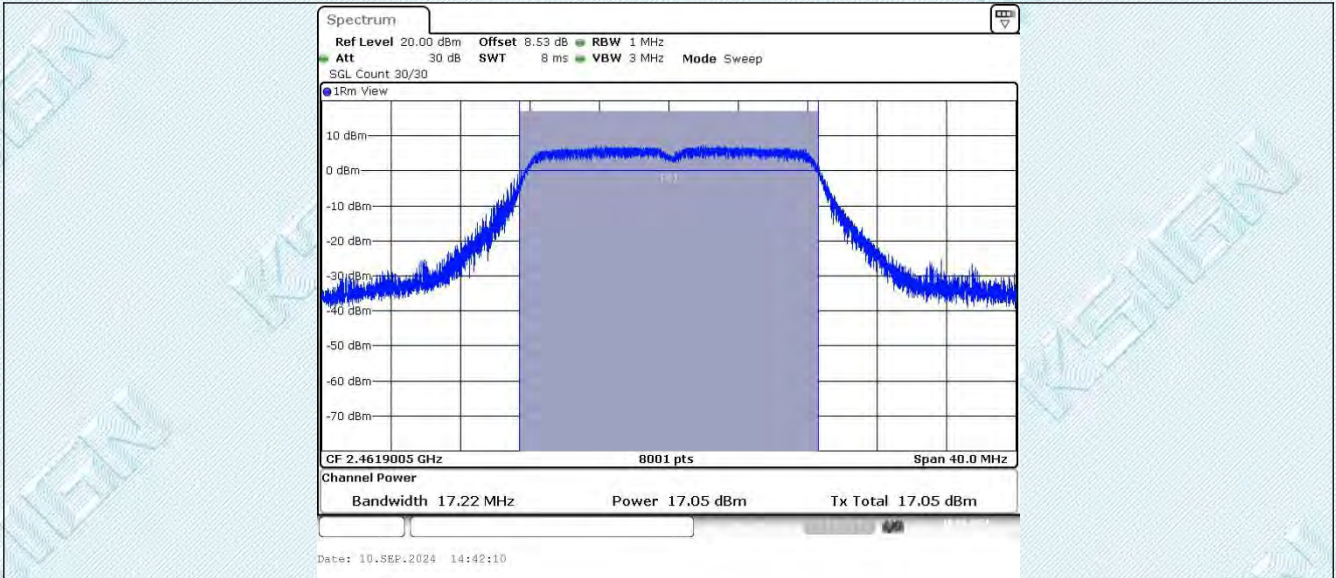

11N20SISO_Ant1_2412

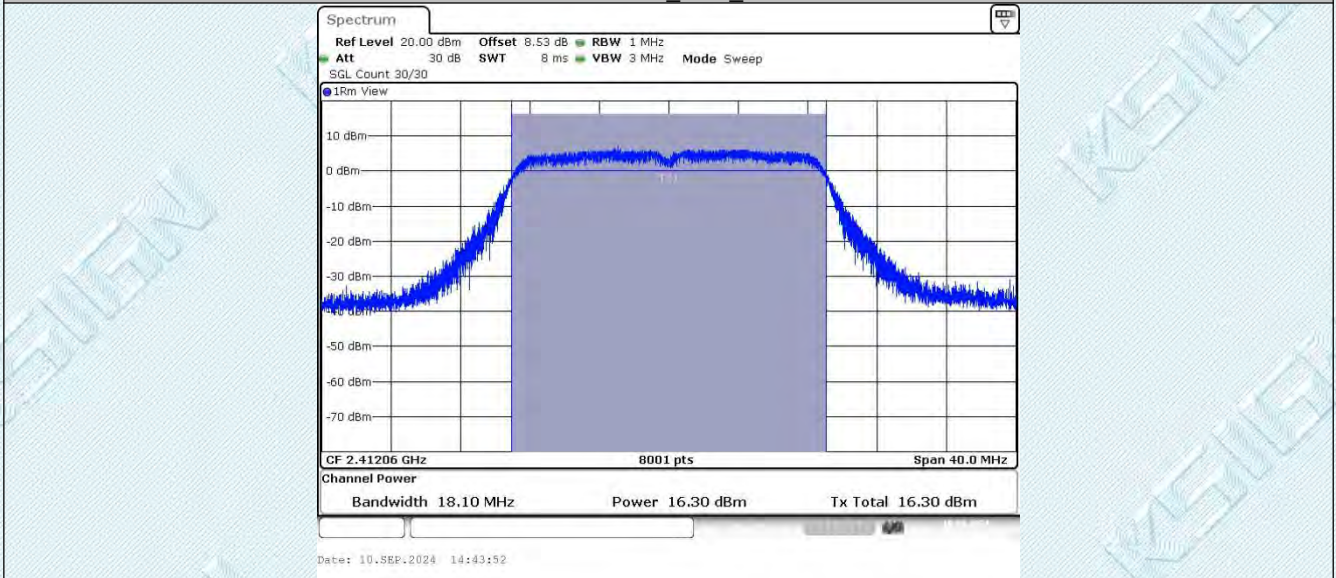

11N20SISO_Ant1_2437

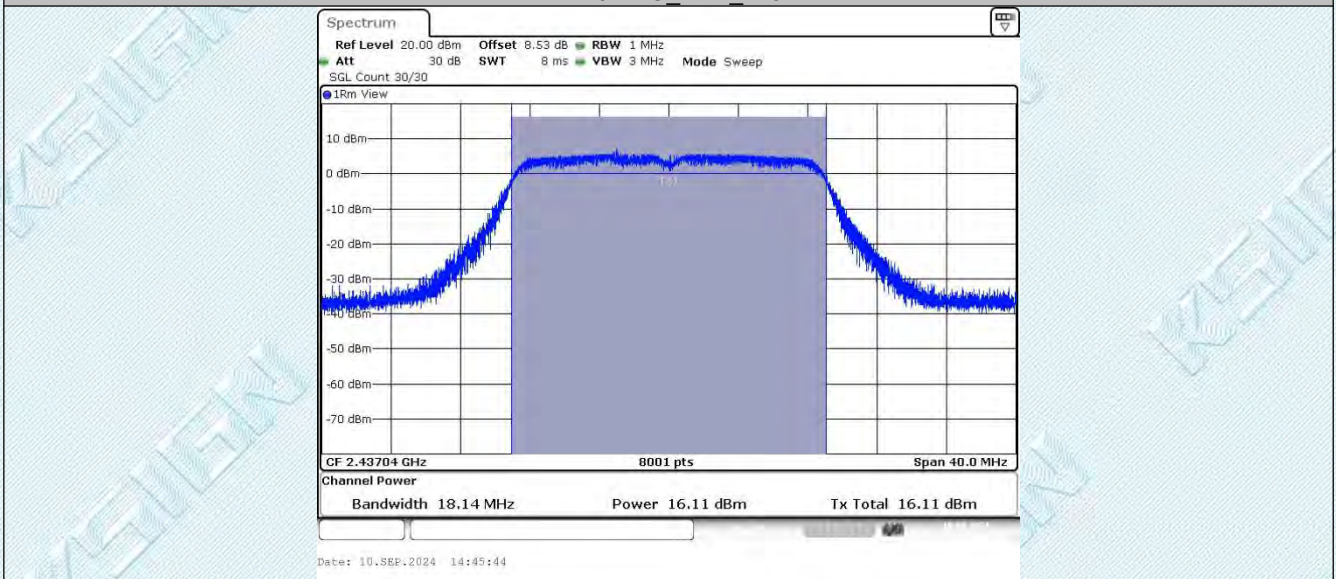

11N20SISO_Ant1_2462

TRF No. RF_R1

Add: West Side of 1/F., Building C, Zone A, Fuyuan New Factory, Jiujiu Industrial Park, Minzhu, Shatou, Shajing, Bao'an District, Shenzhen, Guangdong, China

Tel: +(86) 0755-2985 2678 Fax: +(86) 0755-2985 2397 E-mail: info@gdkesign.cn Web: www.gdkesign.com

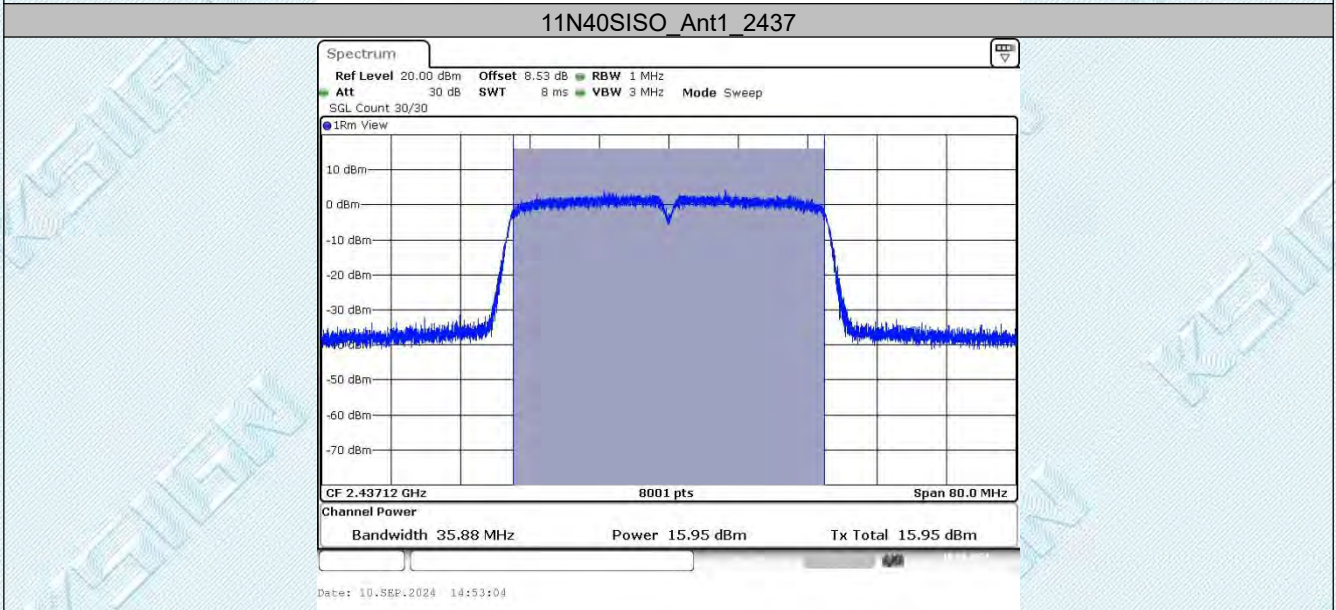
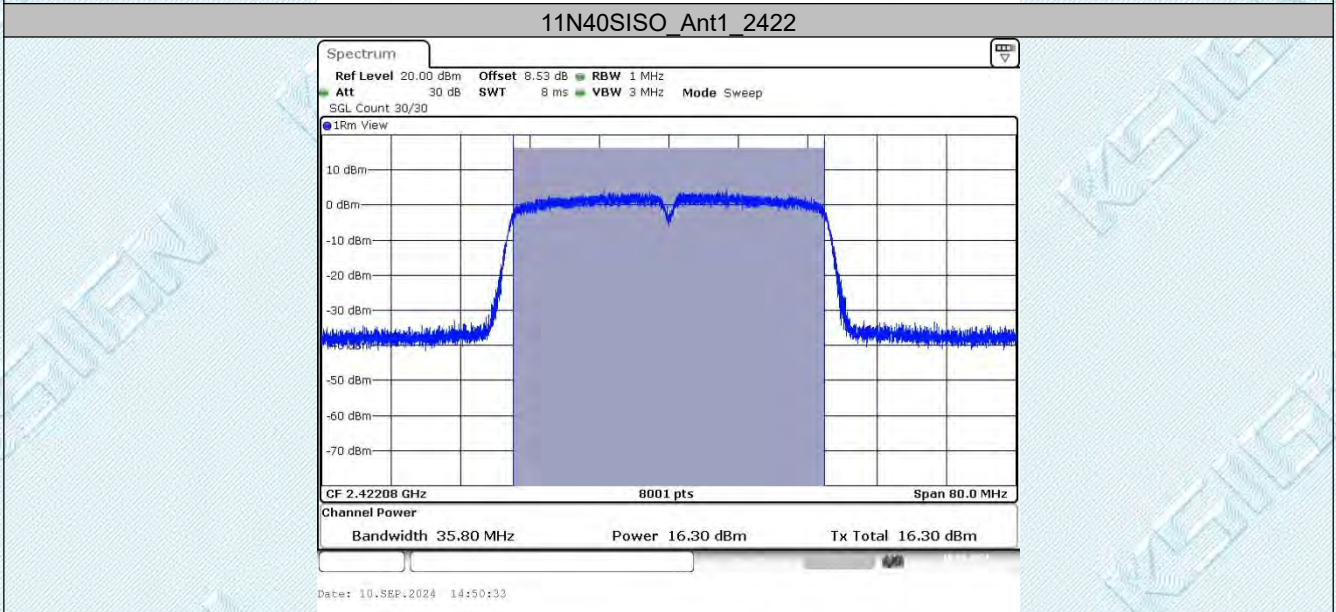
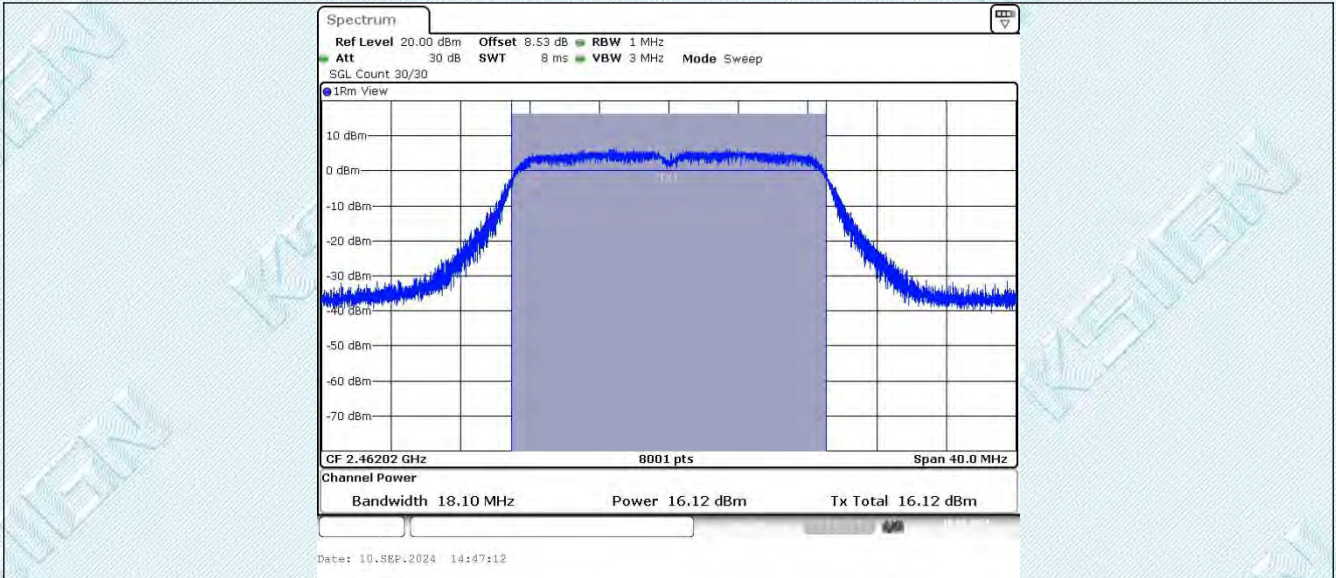

TRF No. RF_R1

Add: West Side of 1/F., Building C, Zone A, Fuyuan New Factory, Jiujiu Industrial Park, Minzhu, Shatou, Shajing, Bao'an District, Shenzhen, Guangdong, China

Tel: +(86) 0755-2985 2678 Fax: +(86) 0755-2985 2397 E-mail: info@gdkesign.cn Web: www.gdkesign.com

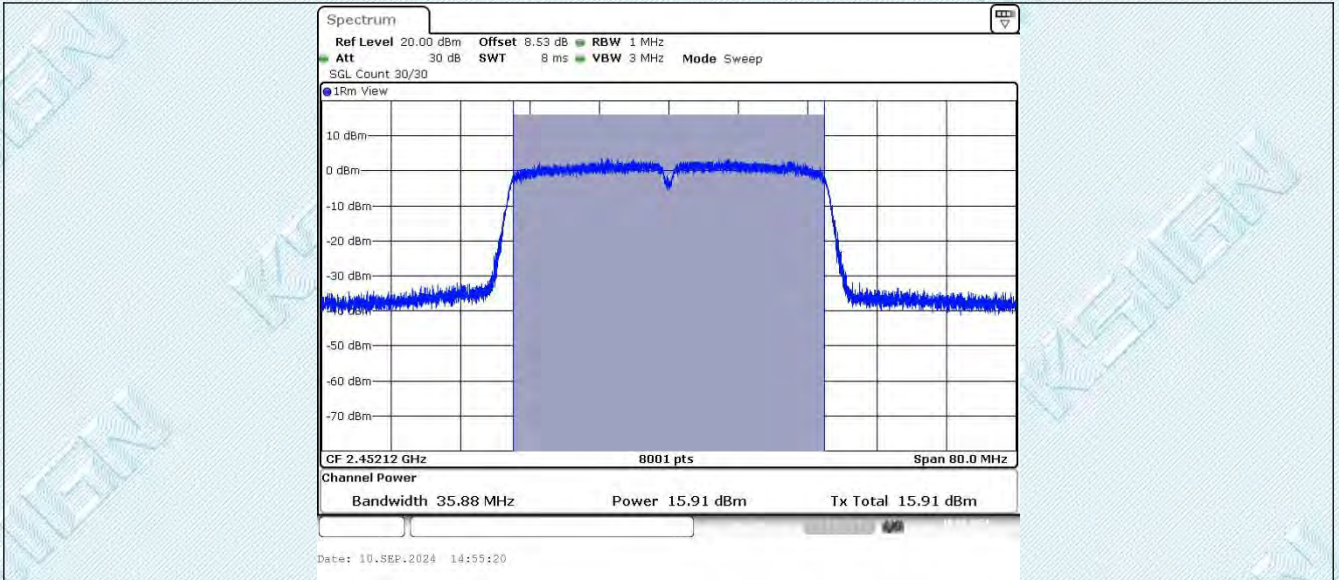

TRF No. RF_R1

Add: West Side of 1/F., Building C, Zone A, Fuyuan New Factory, Jiujiu Industrial Park, Minzhu, Shatou, Shajing, Bao'an District, Shenzhen, Guangdong, China

Tel: +(86) 0755-2985 2678 Fax: +(86) 0755-2985 2397 E-mail: info@gdkesign.cn Web: www.gdkesign.com

Maximum conducted output power

TRF No. RF_R1

Add: West Side of 1/F., Building C, Zone A, Fuyuan New Factory, Jiujiu Industrial Park, Minzhu, Shatou, Shajing, Bao'an District, Shenzhen, Guangdong, China

Tel: +(86) 0755-2985 2678 Fax: +(86) 0755-2985 2397 E-mail: info@gdkesign.cn Web: www.gdkesign.com

6.4. Appendix D: Maximum power spectral density

6.4.1. Test Result

TestMode	Antenna	Frequency[MHz]	Result[dBm/3kHz]	Limit[dBm/3kHz]	Verdict
11B	Ant1	2412	-19.66	≤8.00	PASS
		2437	-20.19	≤8.00	PASS
		2462	-20.04	≤8.00	PASS
11G	Ant1	2412	-20.04	≤8.00	PASS
		2437	-19.33	≤8.00	PASS
		2462	-19.58	≤8.00	PASS
11N20SISO	Ant1	2412	-20.12	≤8.00	PASS
		2437	-20.63	≤8.00	PASS
		2462	-20.30	≤8.00	PASS
11N40SISO	Ant1	2422	-24.22	≤8.00	PASS
		2437	-24.06	≤8.00	PASS
		2452	-24.15	≤8.00	PASS

6.4.2. Test Graphs

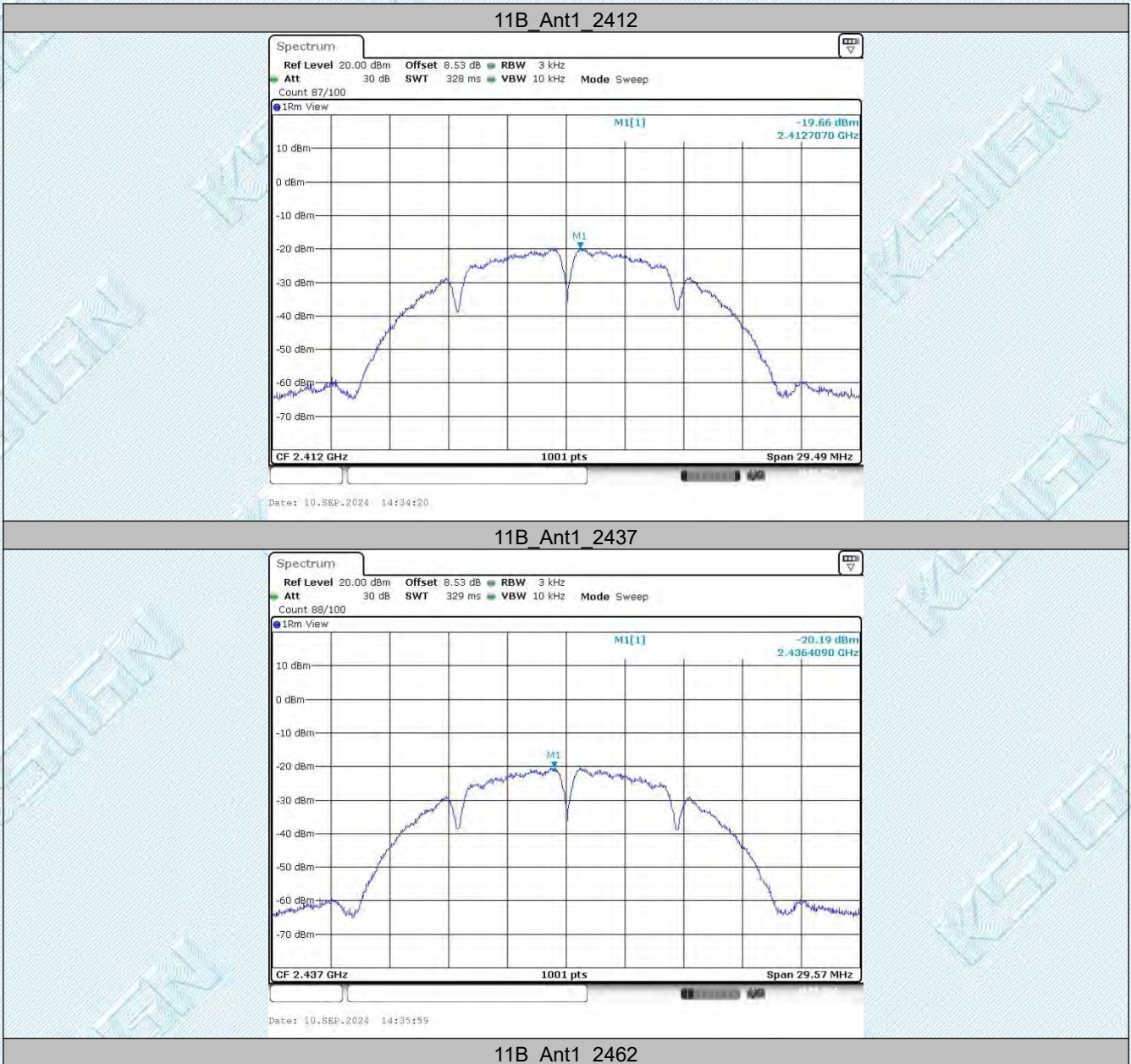

TRF No. RF_R1

Add: West Side of 1/F., Building C, Zone A, Fuyuan New Factory, Jiujiu Industrial Park, Minzhu, Shatou, Shajing, Bao'an District, Shenzhen, Guangdong, China

Tel: +(86) 0755-2985 2678 Fax: +(86) 0755-2985 2397 E-mail: info@gdkesign.cn Web: www.gdkesign.com

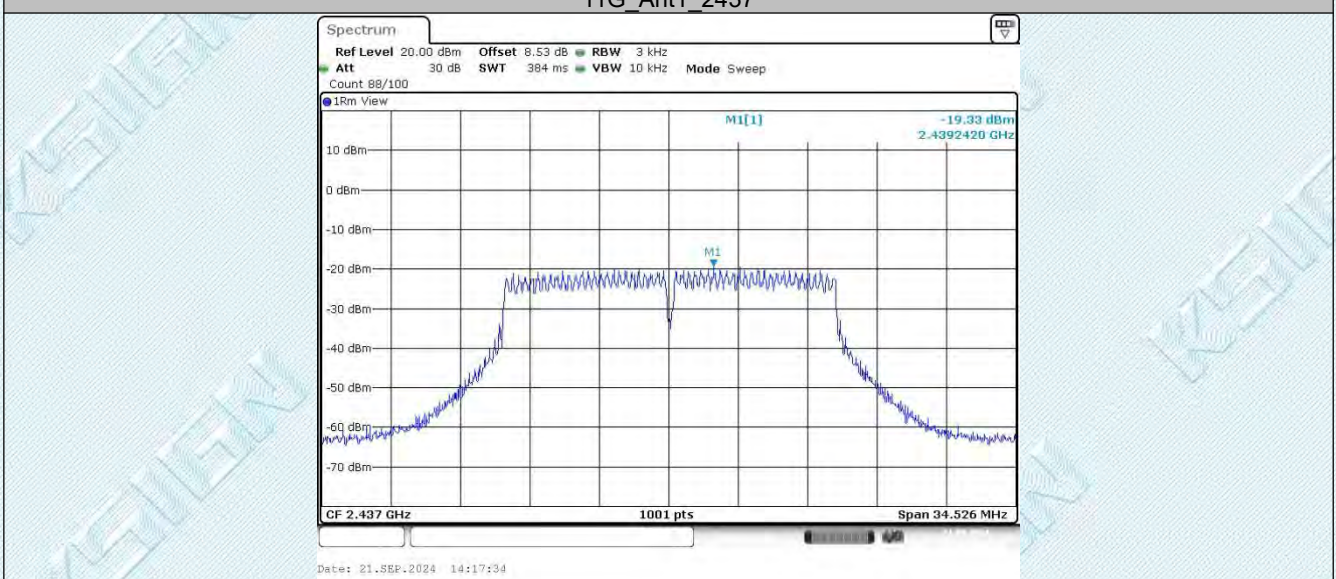
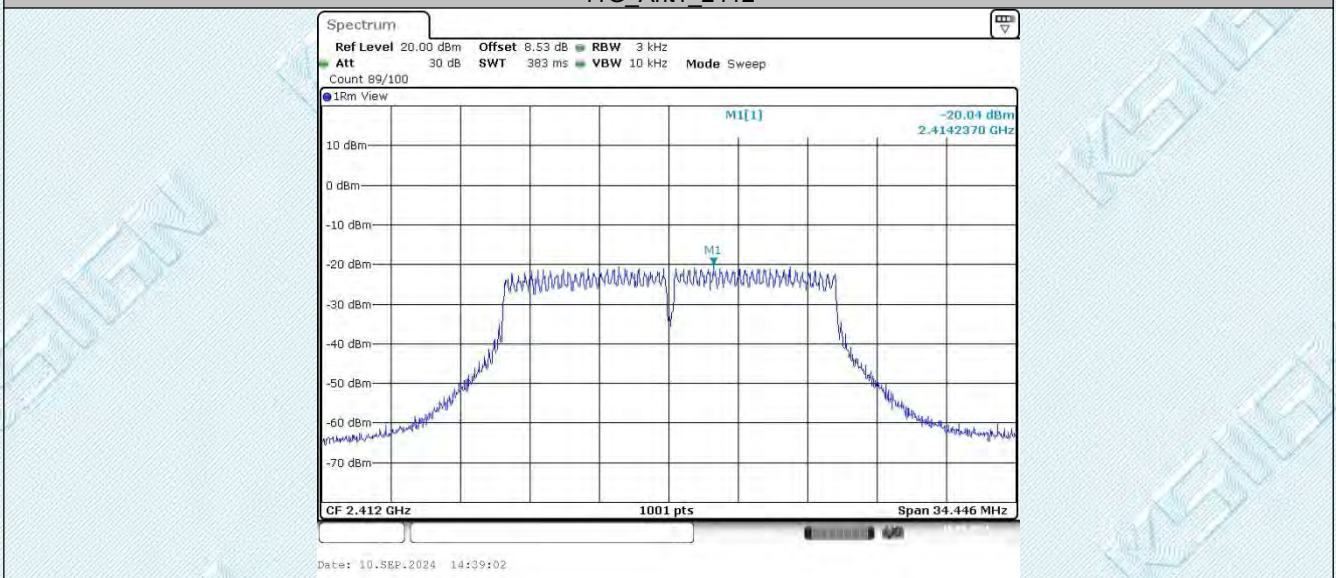

TRF No. RF_R1

Add: West Side of 1/F., Building C, Zone A, Fuyuan New Factory, Jiujiu Industrial Park, Minzhu, Shatou, Shajing, Bao'an District, Shenzhen, Guangdong, China

Tel: +(86) 0755-2985 2678 Fax: +(86) 0755-2985 2397 E-mail: info@gdkesign.cn Web: www.gdkesign.com

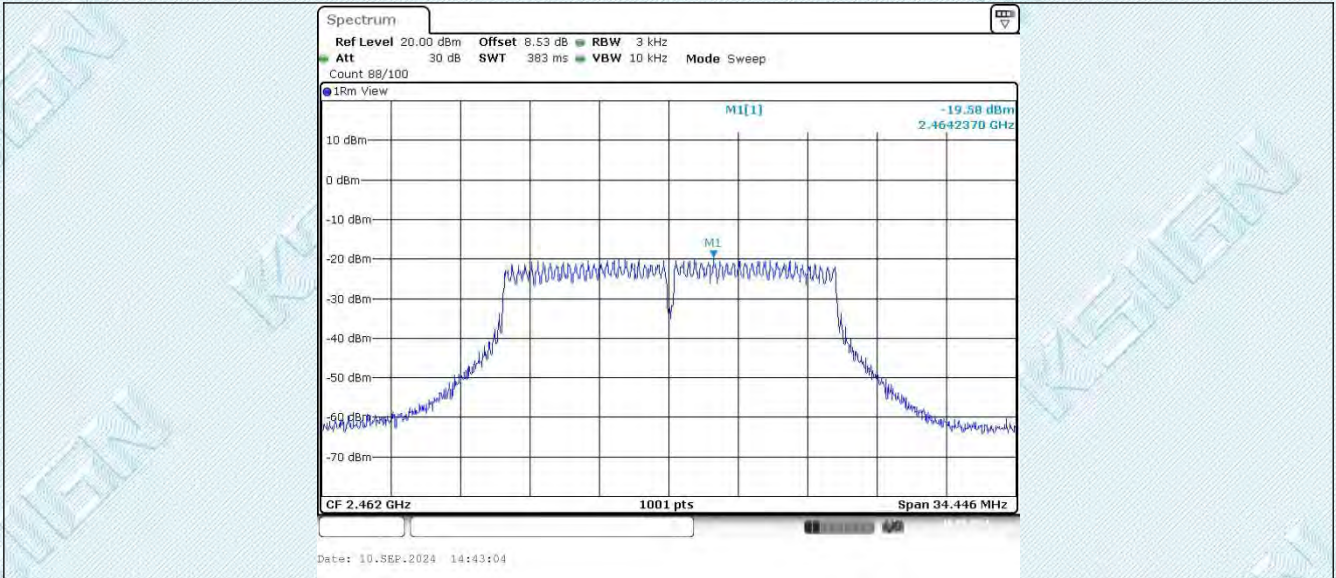

11N20SISO_Ant1_2412

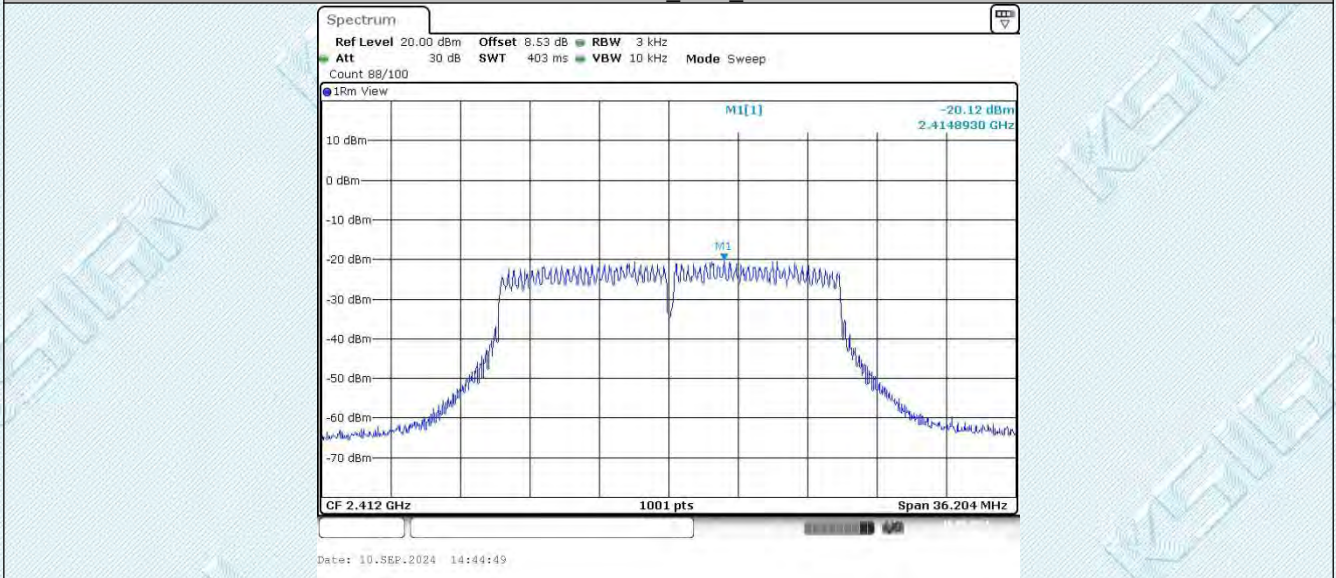

11N20SISO_Ant1_2437

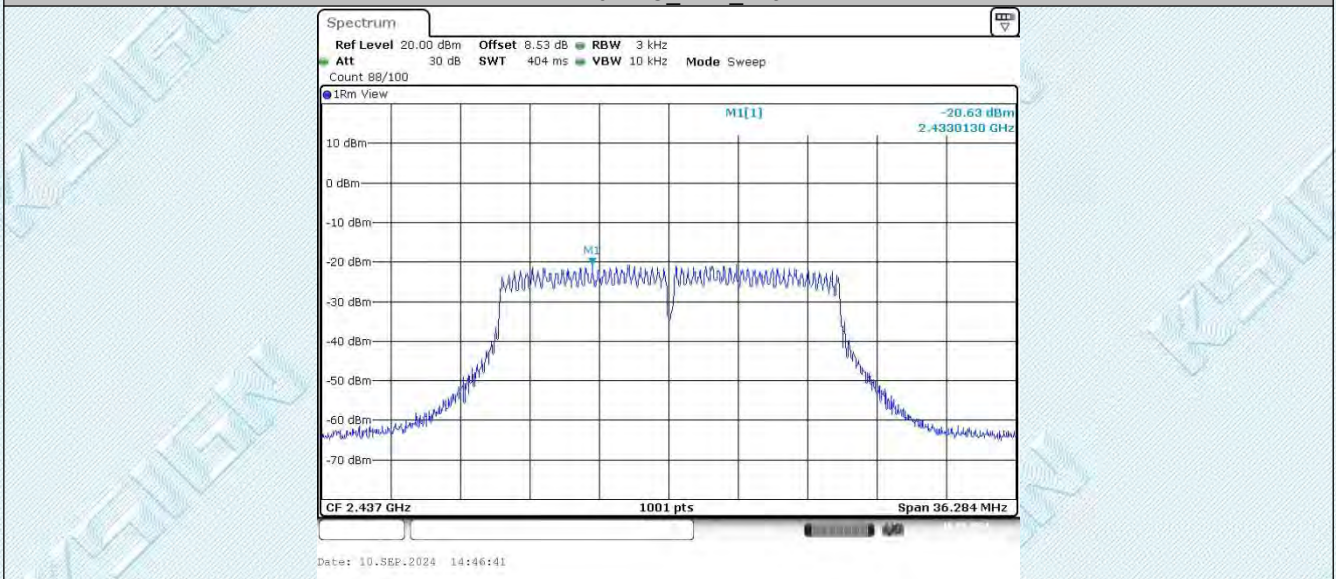

11N20SISO_Ant1_2462

TRF No. RF_R1

Add: West Side of 1/F., Building C, Zone A, Fuyuan New Factory, Jiujiu Industrial Park, Minzhu, Shatou, Shajing, Bao'an District, Shenzhen, Guangdong, China

Tel: +(86) 0755-2985 2678 Fax: +(86) 0755-2985 2397 E-mail: info@gdkesign.cn Web: www.gdkesign.com

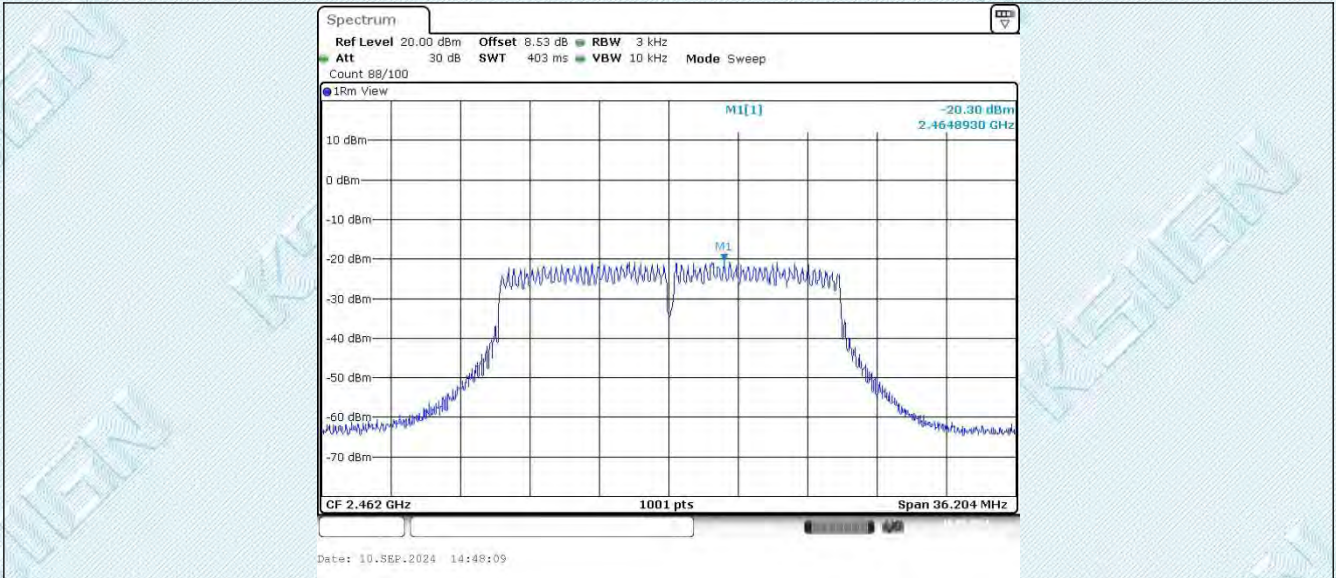

11N40SISO_Ant1_2422

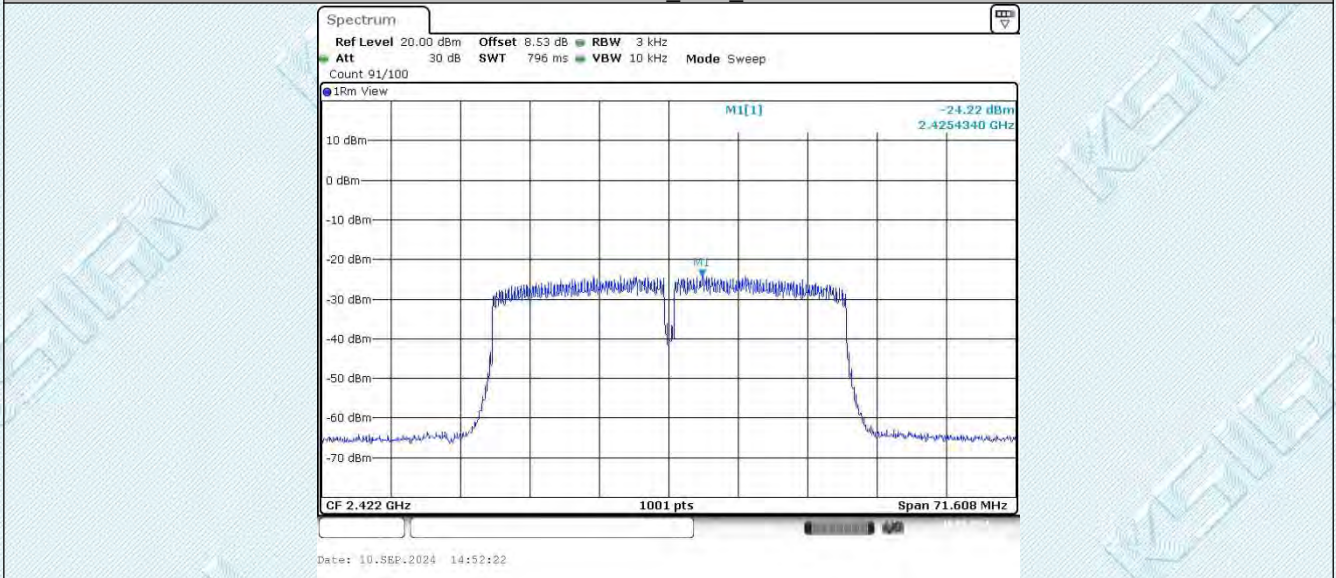

11N40SISO_Ant1_2437

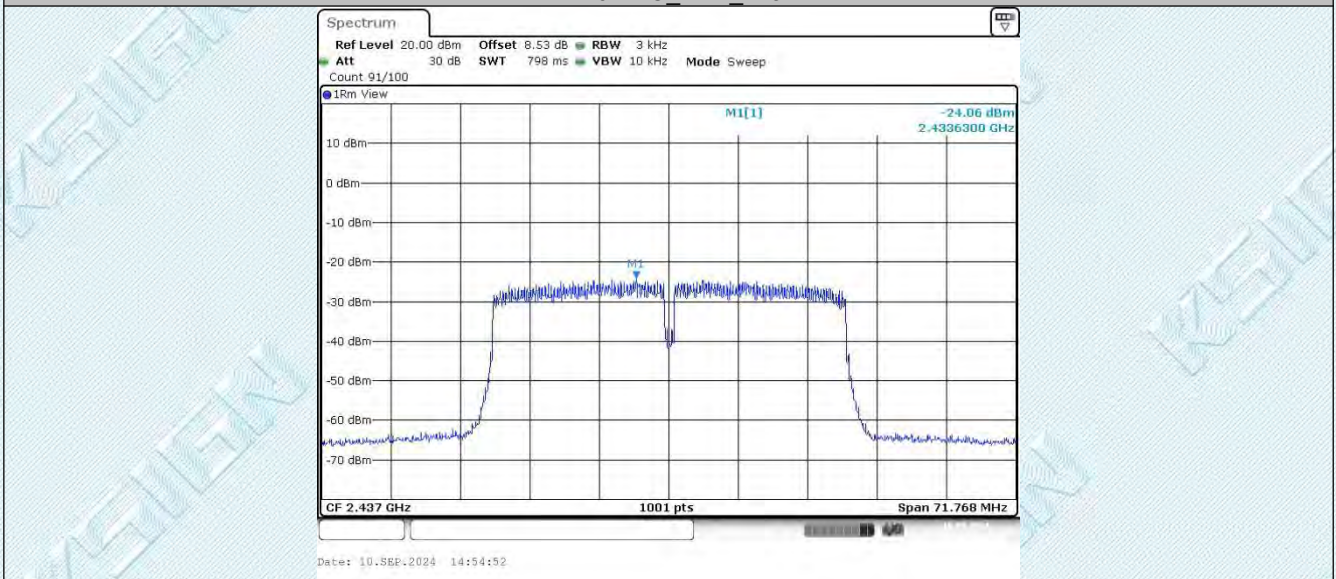

11N40SISO_Ant1_2452

TRF No. RF_R1

Add: West Side of 1/F., Building C, Zone A, Fuyuan New Factory, Jiujiu Industrial Park, Minzhu, Shatou, Shajing, Bao'an District, Shenzhen, Guangdong, China

Tel: +(86) 0755-2985 2678 Fax: +(86) 0755-2985 2397 E-mail: info@gdksign.cn Web: www.gdksign.com

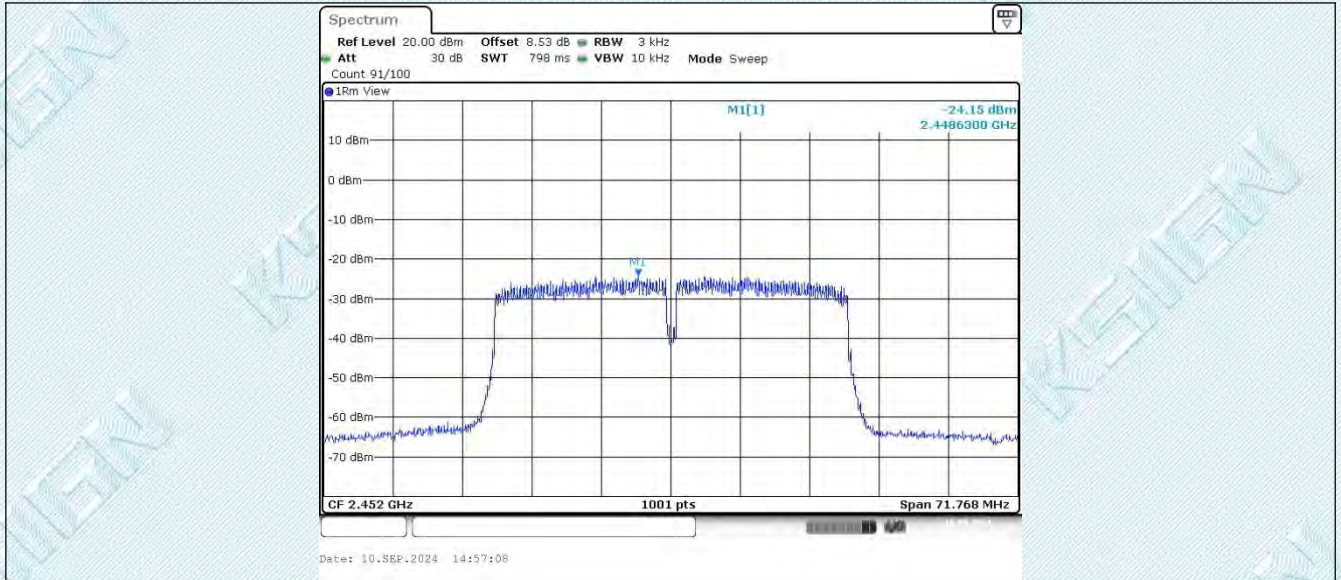

TRF No. RF_R1

Add: West Side of 1/F., Building C, Zone A, Fuyuan New Factory, Jiujiu Industrial Park, Minzhu, Shatou, Shajing, Bao'an District, Shenzhen, Guangdong, China

Tel: +(86) 0755-2985 2678 Fax: +(86) 0755-2985 2397 E-mail: info@gdkesign.cn Web: www.gdkesign.com

6.5. Appendix E: Reference level measurement

6.5.1. Test Result

TestMode	Antenna	Freq(MHz)	Max.Point[MHz]	Result[dBm]
11B	Ant1	2412	2412.56	0.95
		2437	2437.57	1.06
		2462	2461.56	1.31
11G	Ant1	2412	2416.20	-2.09
		2437	2434.57	-2.06
		2462	2466.22	-1.72
11N20SISO	Ant1	2412	2409.21	-2.00
		2437	2431.69	-2.17
		2462	2459.21	-1.58
11N40SISO	Ant1	2422	2425.63	-4.70
		2437	2440.63	-4.91
		2452	2459.96	-5.30

6.5.2. Test Graphs



TRF No. RF_R1

Add: West Side of 1/F., Building C, Zone A, Fuyuan New Factory, Jiujiu Industrial Park, Minzhu, Shatou, Shajing, Bao'an District, Shenzhen, Guangdong, China

Tel: +(86) 0755-2985 2678 Fax: +(86) 0755-2985 2397 E-mail: info@gdkesign.cn Web: www.gdkesign.com

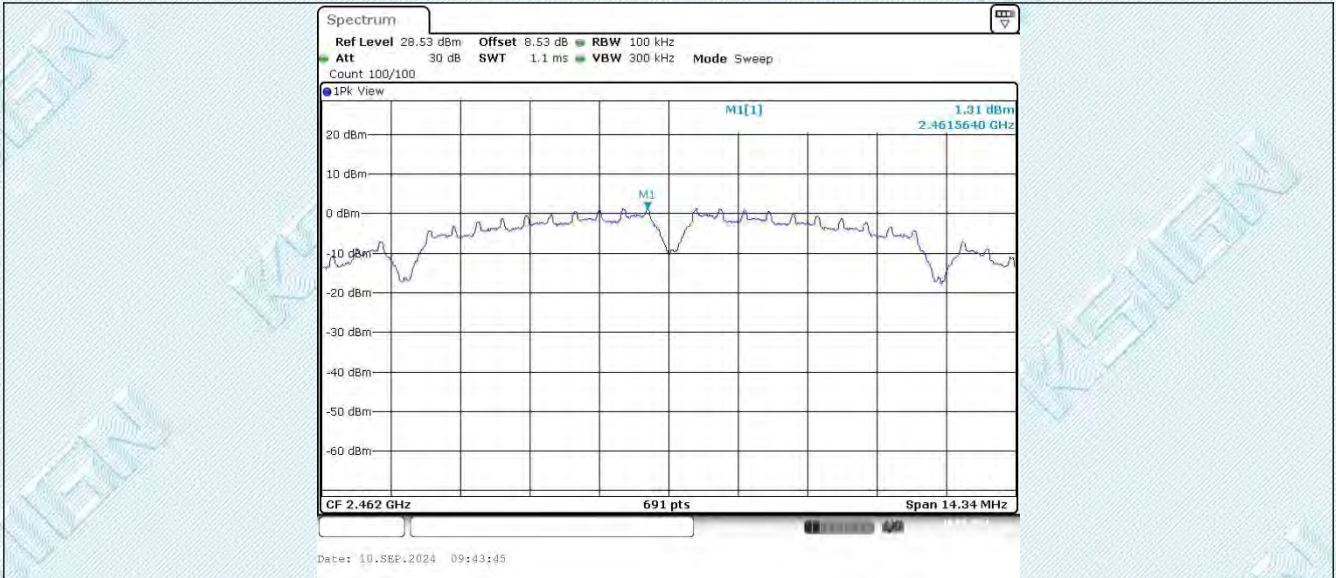

11G_Ant1_2412

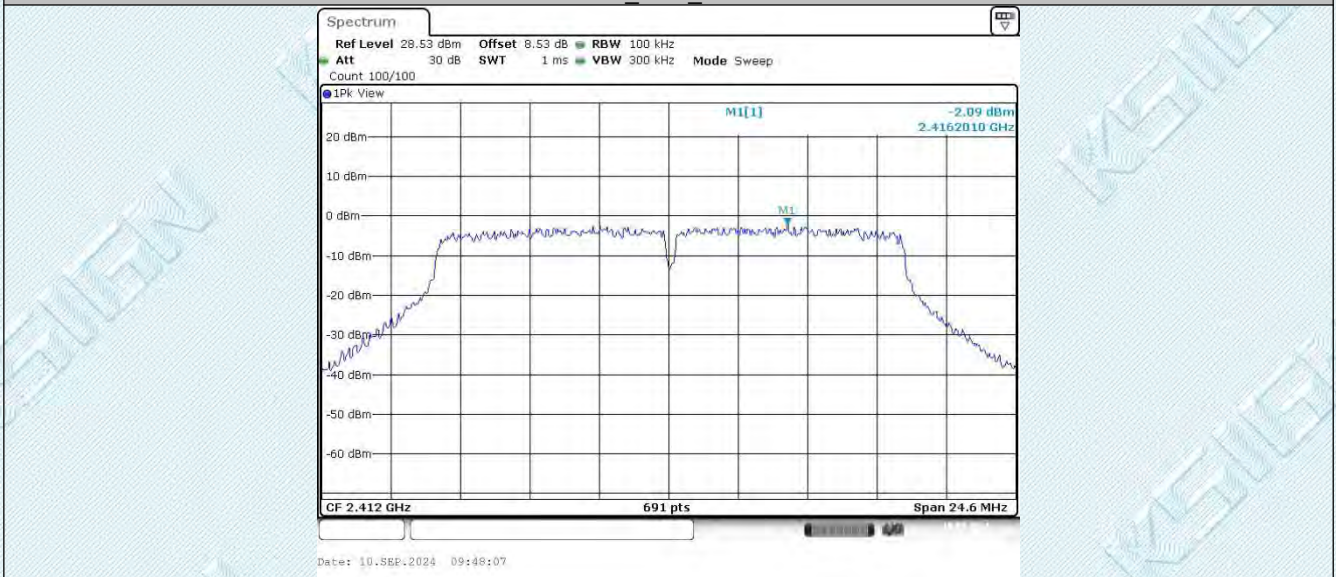

11G_Ant1_2437

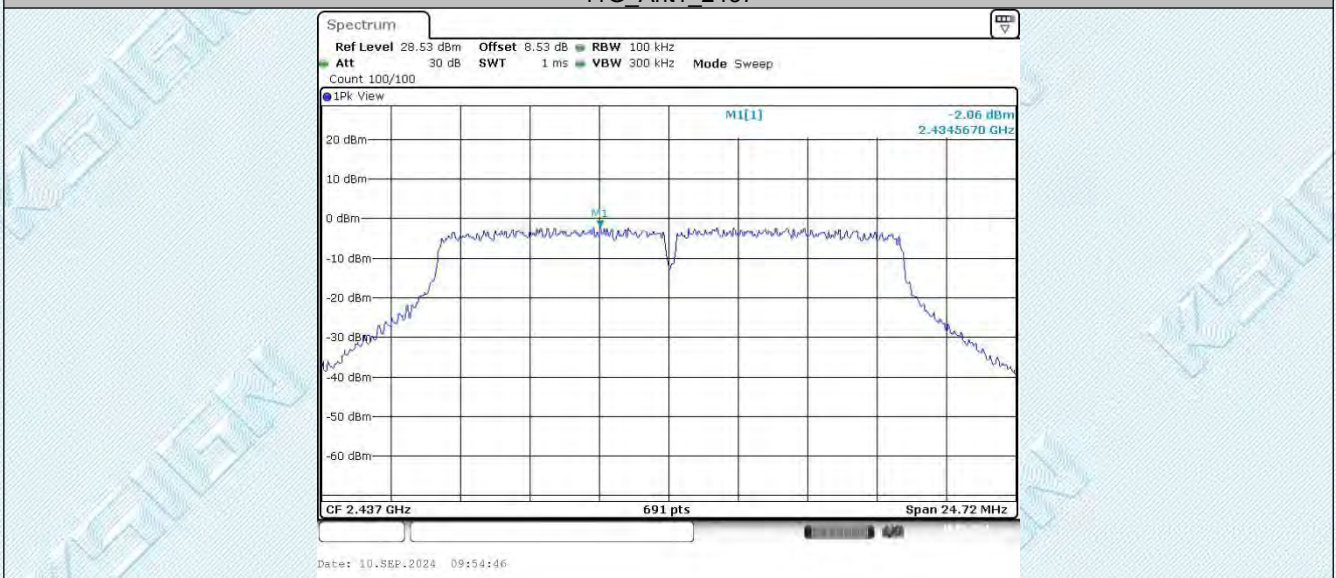

11G_Ant1_2462

TRF No. RF_R1

Add: West Side of 1/F., Building C, Zone A, Fuyuan New Factory, Jiujiu Industrial Park, Minzhu, Shatou, Shajing, Bao'an District, Shenzhen, Guangdong, China

Tel: +(86) 0755-2985 2678 Fax: +(86) 0755-2985 2397 E-mail: info@gdkesign.cn Web: www.gdkesign.com

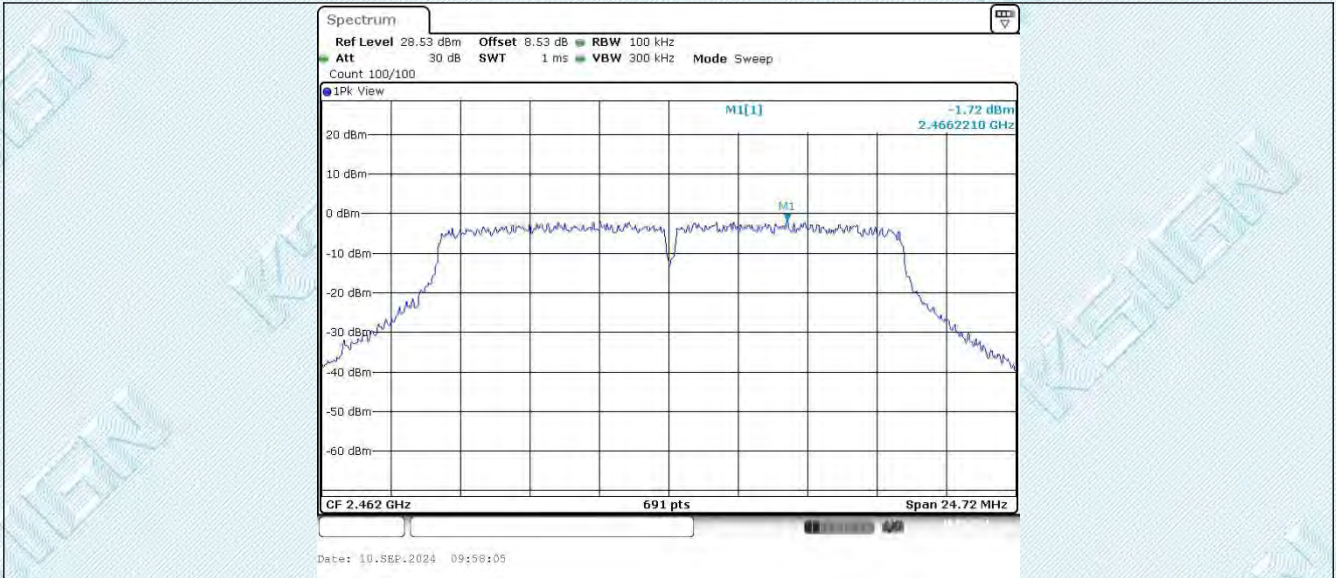

11N20SISO_Ant1_2412

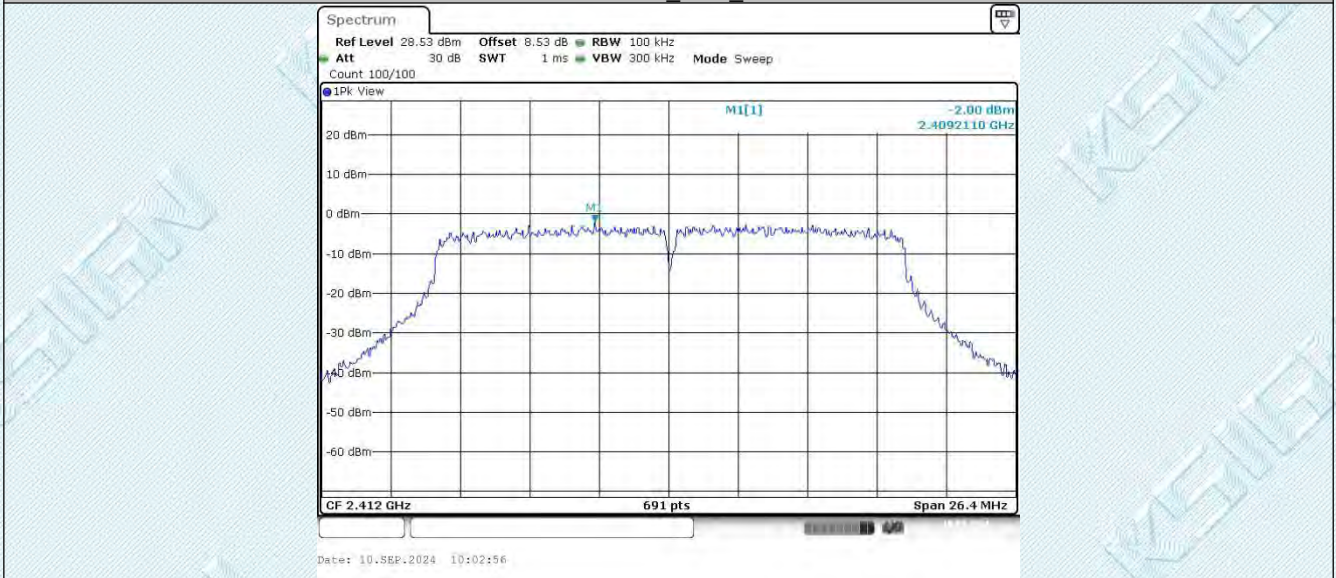

11N20SISO_Ant1_2437



11N20SISO_Ant1_2462

TRF No. RF_R1

Add: West Side of 1/F., Building C, Zone A, Fuyuan New Factory, Jiujiu Industrial Park, Minzhu, Shatou, Shajing, Bao'an District, Shenzhen, Guangdong, China

Tel: +(86) 0755-2985 2678 Fax: +(86) 0755-2985 2397 E-mail: info@gdkesign.cn Web: www.gdkesign.com

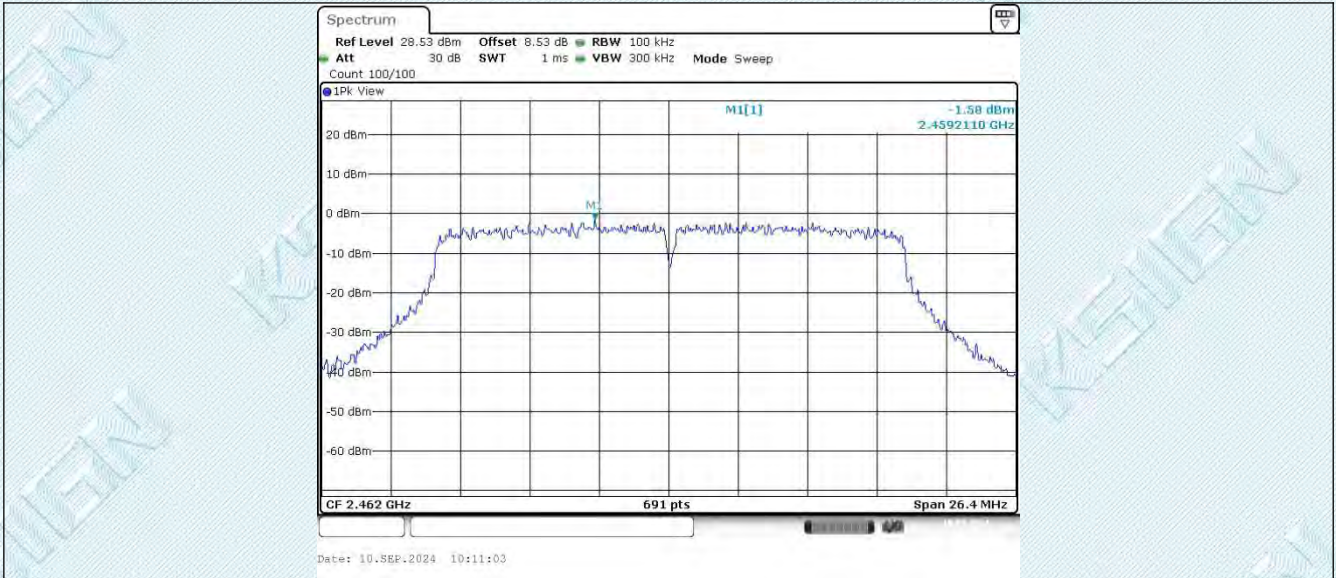

11N40SISO_Ant1_2422



11N40SISO_Ant1_2437

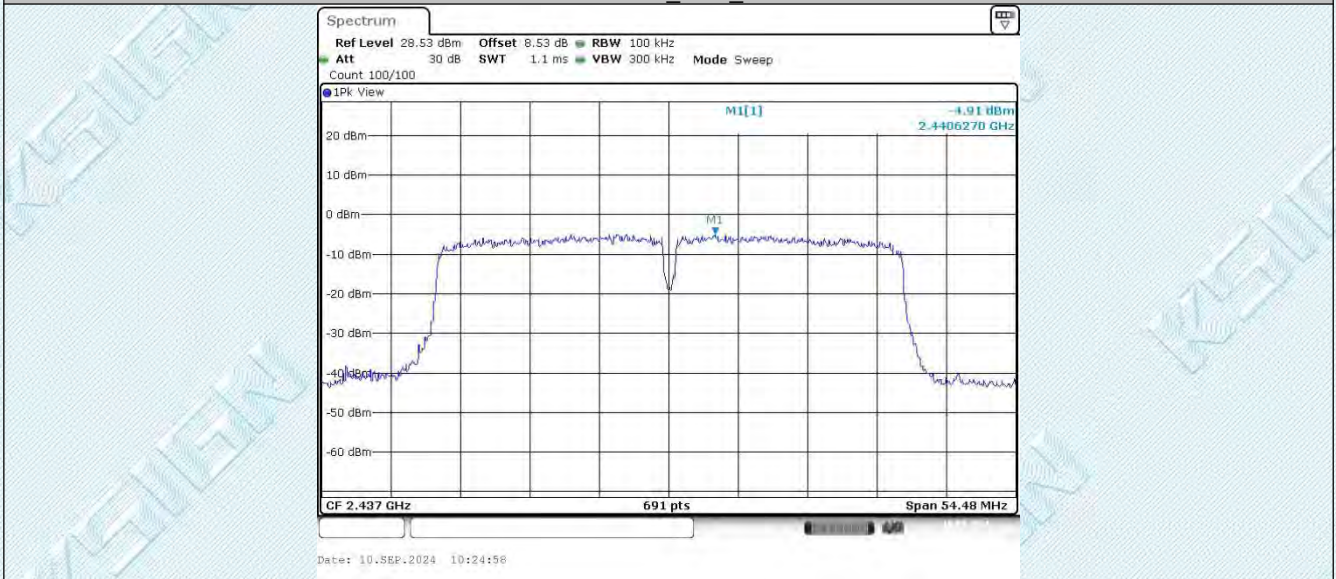

11N40SISO_Ant1_2452

TRF No. RF_R1

Add: West Side of 1/F., Building C, Zone A, Fuyuan New Factory, Jiujiu Industrial Park, Minzhu, Shatou, Shajing, Bao'an District, Shenzhen, Guangdong, China

Tel: +(86) 0755-2985 2678 Fax: +(86) 0755-2985 2397 E-mail: info@gdkesign.cn Web: www.gdkesign.com



TRF No. RF_R1

Add: West Side of 1/F., Building C, Zone A, Fuyuan New Factory, Jiujiu Industrial Park, Minzhu, Shatou, Shajing, Bao'an District, Shenzhen, Guangdong, China

Tel: +(86) 0755-2985 2678 Fax: +(86) 0755-2985 2397 E-mail: info@gdkesign.cn Web: www.gdkesign.com

6.6. Appendix F: Band edge measurements

6.6.1. Test Result

TestMode	Antenna	ChName	Frequency [MHz]	RefLevel[dBm]	Result[dBm]	Limit[dBm]	Verdict
11B	Ant1	Low	2412	0.95	-40.05	≤-29.05	PASS
		High	2462	1.31	-41.6	≤-28.69	PASS
11G	Ant1	Low	2412	-2.09	-36.85	≤-32.09	PASS
		High	2462	-1.72	-41.04	≤-31.72	PASS
11N20SISO	Ant1	Low	2412	-2.00	-35.51	≤-32	PASS
		High	2462	-1.58	-41.39	≤-31.58	PASS
11N40SISO	Ant1	Low	2422	-4.70	-41.75	≤-34.7	PASS
		High	2452	-5.30	-41.56	≤-35.3	PASS

6.6.2. Test Graphs

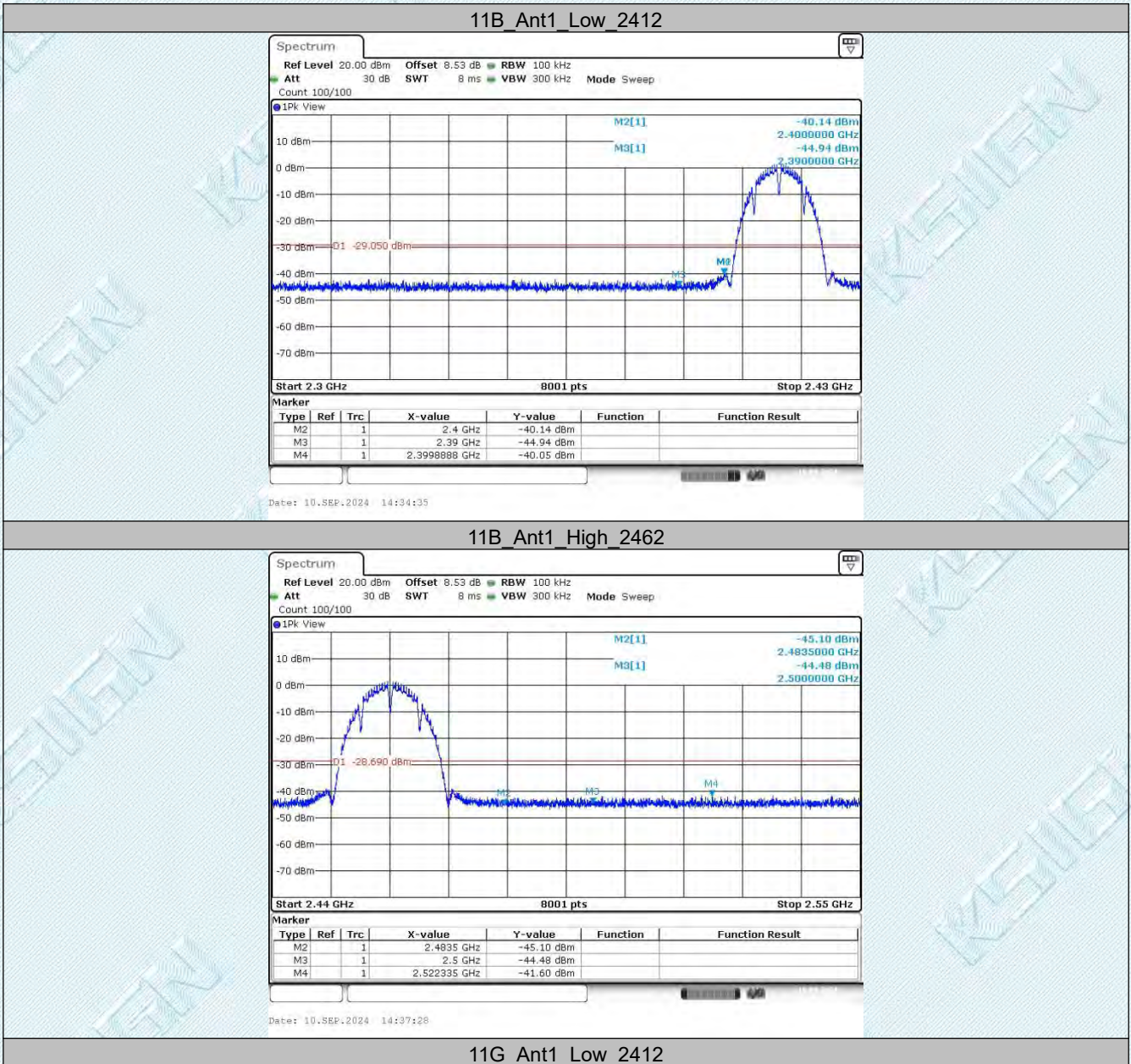

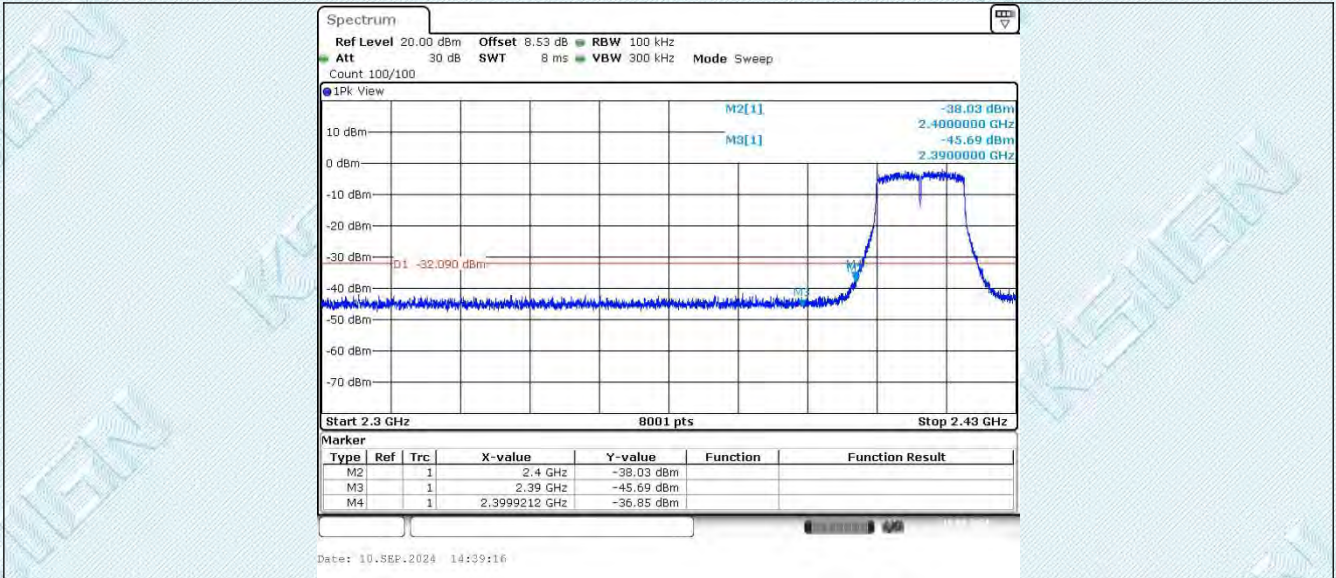

11G_Ant1_High_2462

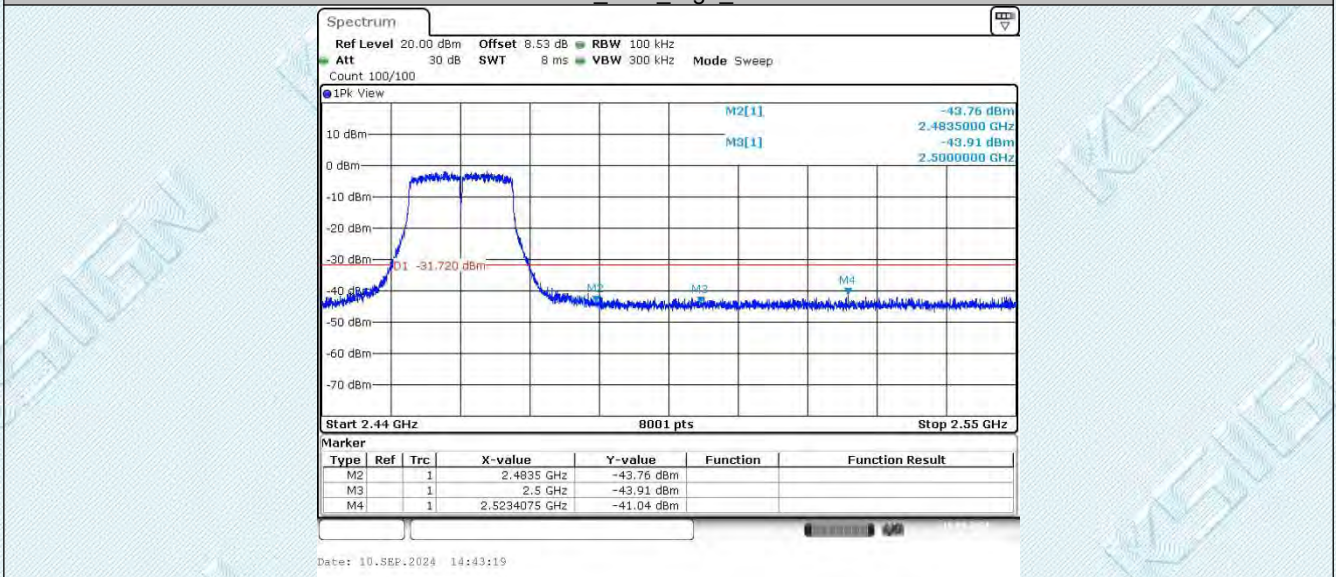

11N20SISO_Ant1_Low_2412

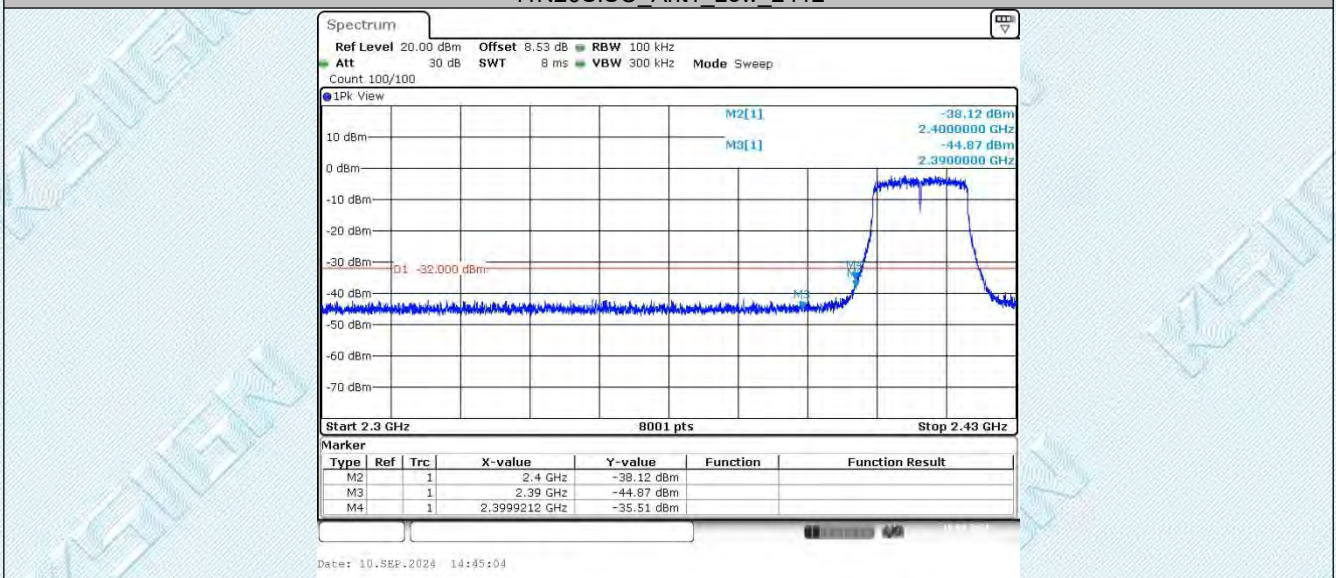

11N20SISO_Ant1_High_2462

TRF No. RF_R1

Add: West Side of 1/F., Building C, Zone A, Fuyuan New Factory, Jiujiu Industrial Park, Minzhu, Shatou, Shajing, Bao'an District, Shenzhen, Guangdong, China

Tel: +(86) 0755-2985 2678 Fax: +(86) 0755-2985 2397 E-mail: info@gdkesign.cn Web: www.gdkesign.com

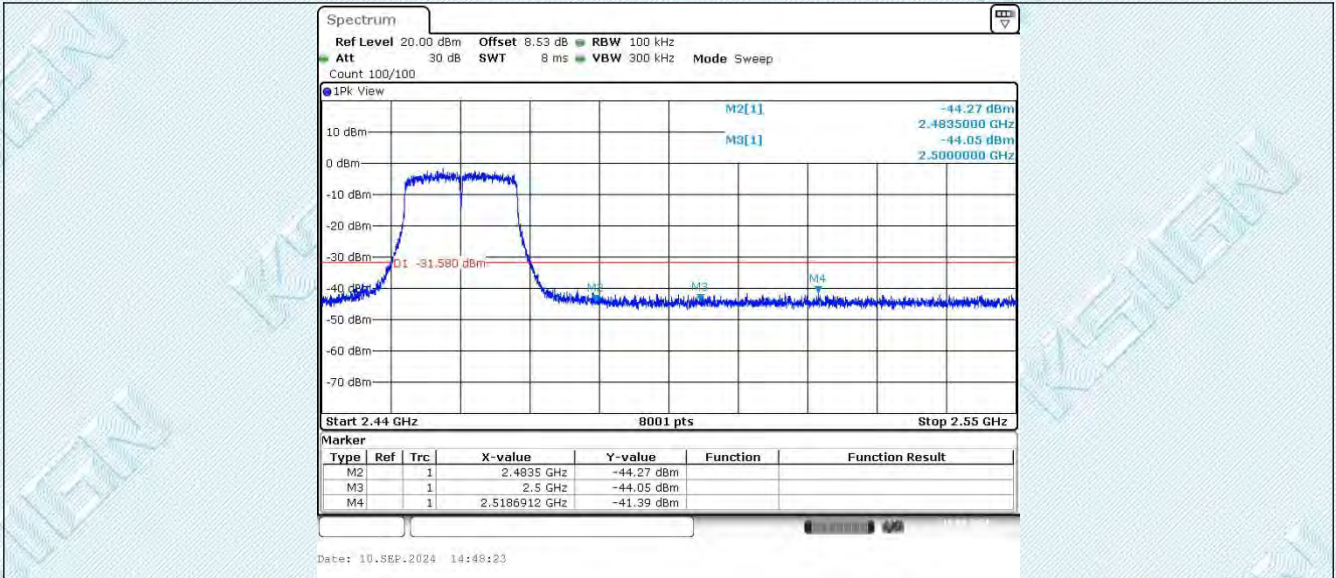

11N40SISO_Ant1_Low_2422

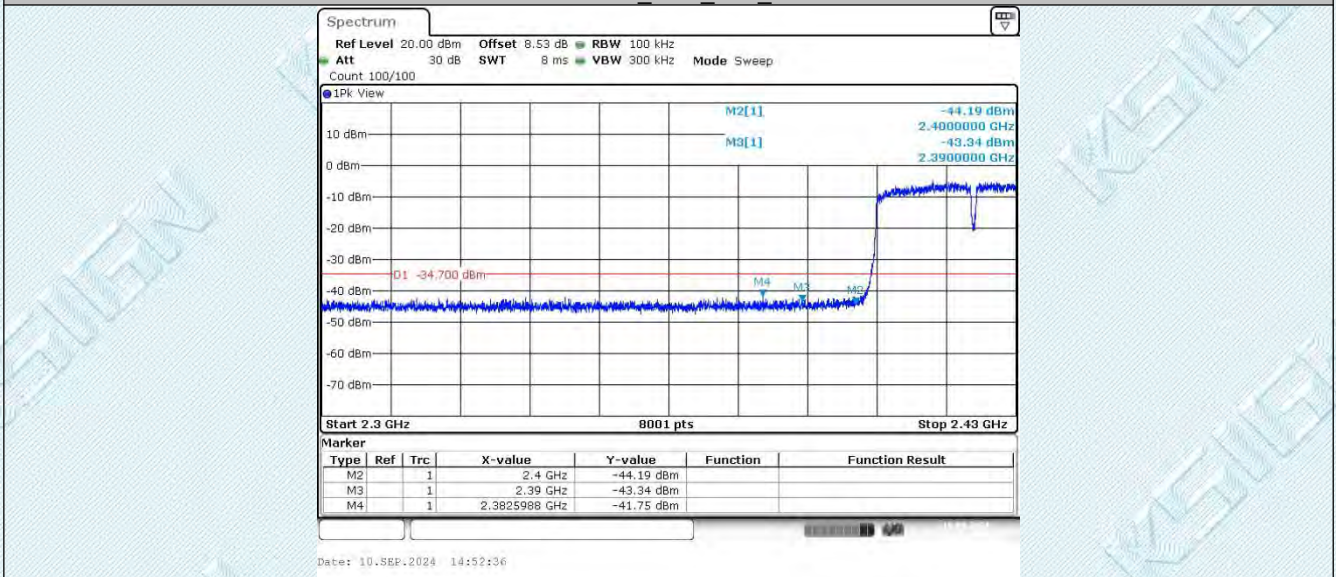

11N40SISO_Ant1_High_2452

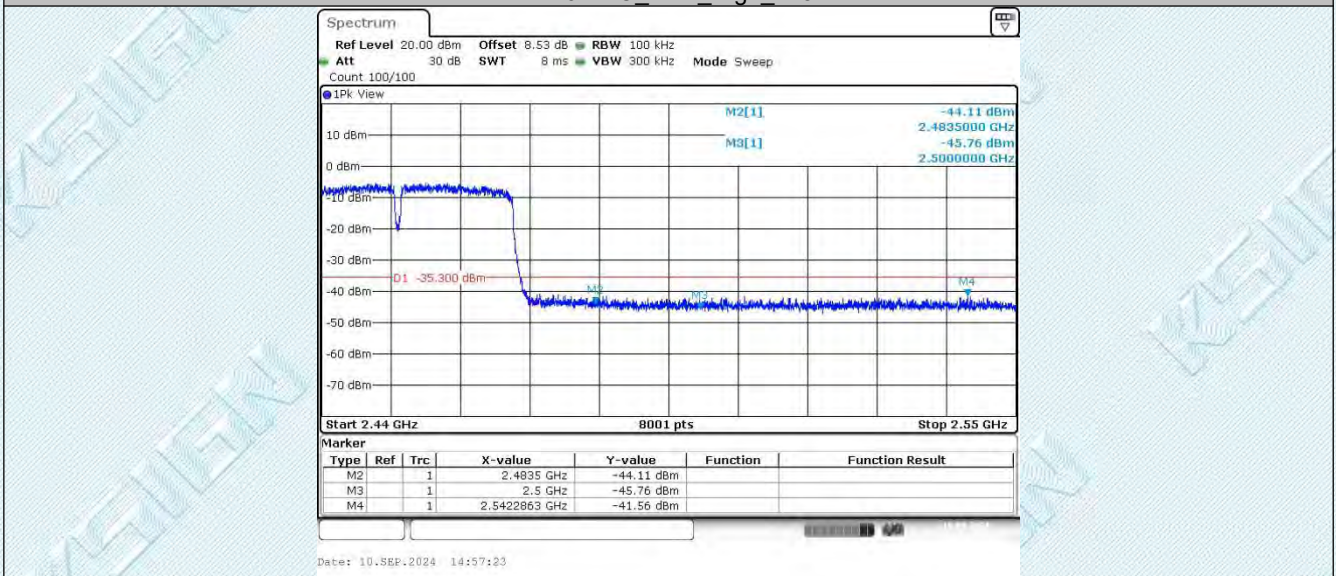

TRF No. RF_R1

Add: West Side of 1/F., Building C, Zone A, Fuyuan New Factory, Jiujiu Industrial Park, Minzhu, Shatou, Shajing, Bao'an District, Shenzhen, Guangdong, China

Tel: +(86) 0755-2985 2678 Fax: +(86) 0755-2985 2397 E-mail: info@gdkesign.cn Web: www.gdkesign.com

6.7. Appendix G: Conducted Spurious Emission

6.7.1. Test Result

TestMode	Antenna	Frequency [MHz]	FreqRange [Mhz]	RefLevel [dBm]	Result [dBm]	Limit [dBm]	Verdict
11B	Ant1	2412	30~1000	0.95	-51.84	≤-29.05	PASS
			1000~26500	0.95	-46.67	≤-29.05	PASS
		2437	30~1000	1.06	-51.57	≤-28.94	PASS
			1000~26500	1.06	-46.84	≤-28.94	PASS
		2462	30~1000	1.31	-52.69	≤-28.69	PASS
			1000~26500	1.31	-46.64	≤-28.69	PASS
11G	Ant1	2412	30~1000	-2.09	-52.9	≤-32.09	PASS
			1000~26500	-2.09	-47.14	≤-32.09	PASS
		2437	30~1000	-2.06	-52.28	≤-32.06	PASS
			1000~26500	-2.06	-47.26	≤-32.06	PASS
		2462	30~1000	-1.72	-52.5	≤-31.72	PASS
			1000~26500	-1.72	-47.52	≤-31.72	PASS
11N20SISO	Ant1	2412	30~1000	-2.00	-52.82	≤-32	PASS
			1000~26500	-2.00	-45.95	≤-32	PASS
		2437	30~1000	-2.17	-52.7	≤-32.17	PASS
			1000~26500	-2.17	-47.3	≤-32.17	PASS
		2462	30~1000	-1.58	-52.35	≤-31.58	PASS
			1000~26500	-1.58	-47.42	≤-31.58	PASS
11N40SISO	Ant1	2422	30~1000	-4.70	-52.48	≤-34.7	PASS
			1000~26500	-4.70	-45.7	≤-34.7	PASS
		2437	30~1000	-4.91	-52.45	≤-34.91	PASS
			1000~26500	-4.91	-46.92	≤-34.91	PASS
		2452	30~1000	-5.30	-52.44	≤-35.3	PASS
			1000~26500	-5.30	-46.98	≤-35.3	PASS

6.7.2. Test Graphs

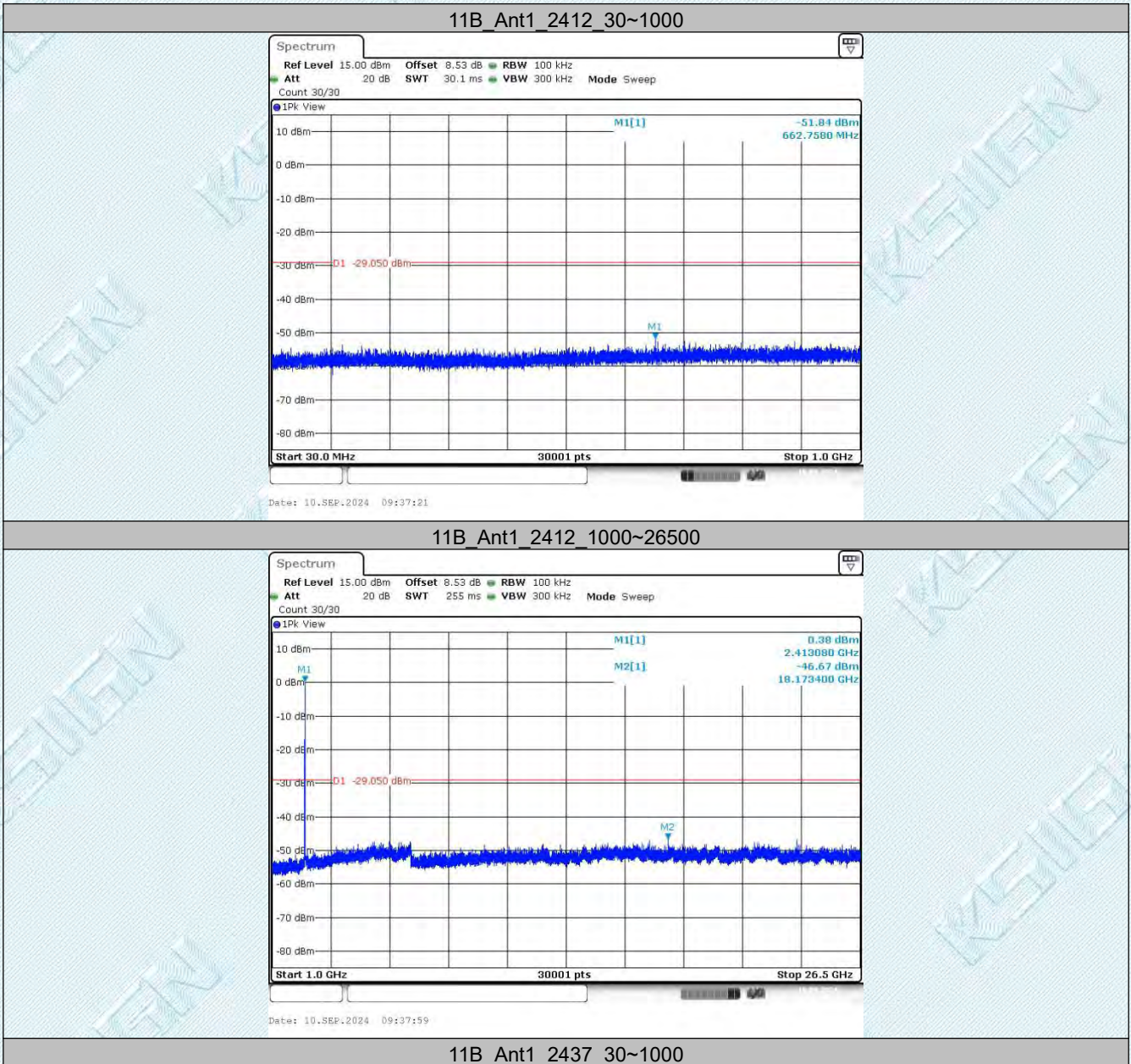

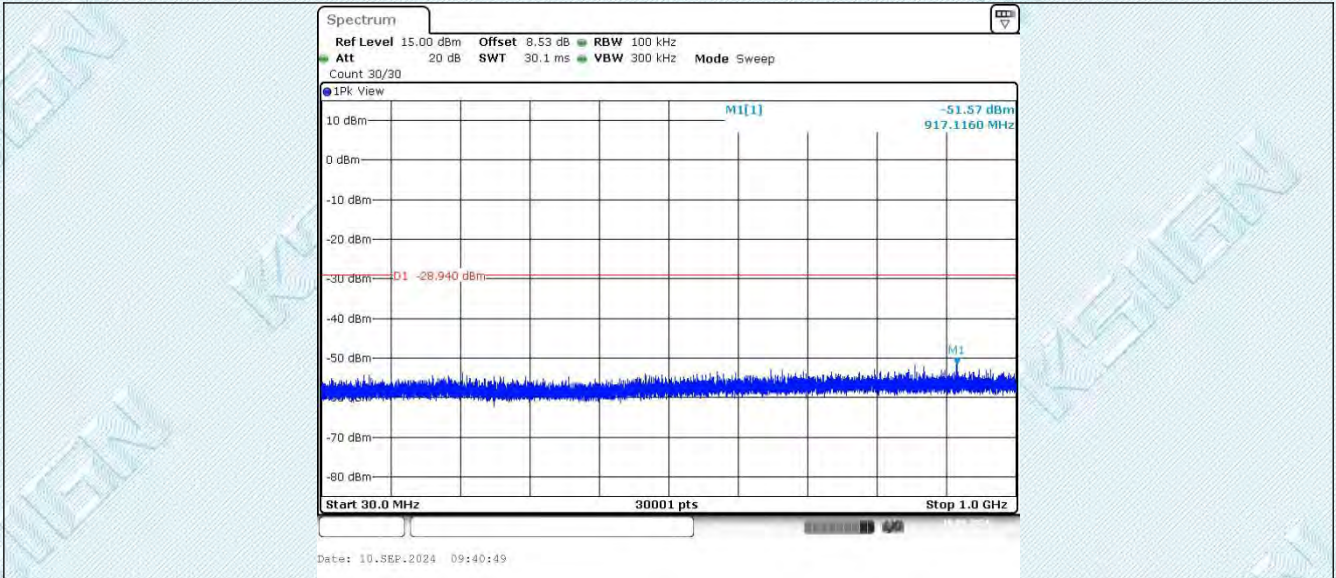

11B_Ant1_2437_1000~26500

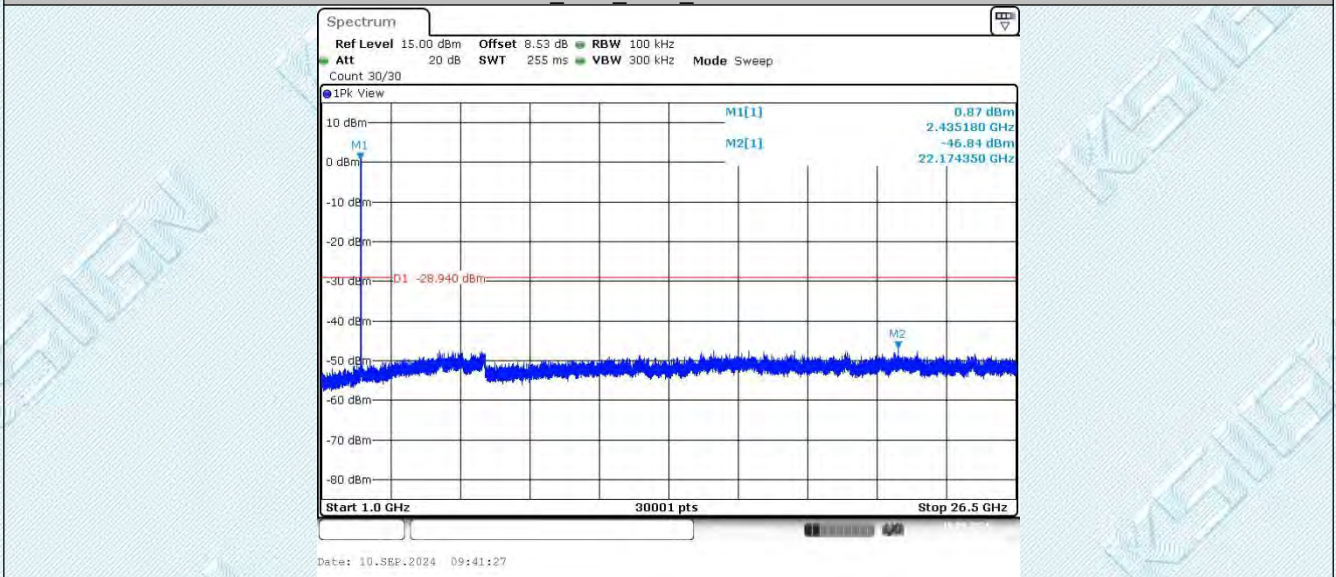

11B_Ant1_2462_30~1000

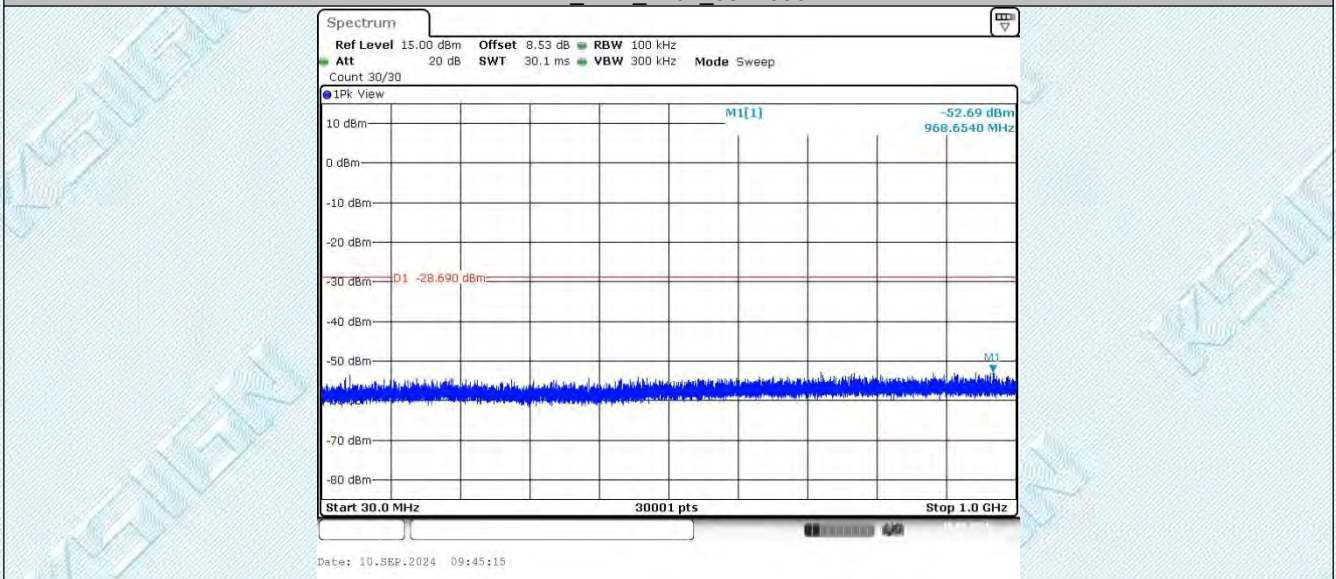

11B_Ant1_2462_1000~26500

TRF No. RF_R1

Add: West Side of 1/F., Building C, Zone A, Fuyuan New Factory, Jiujiu Industrial Park, Minzhu, Shatou, Shajing, Bao'an District, Shenzhen, Guangdong, China

Tel: +(86) 0755-2985 2678 Fax: +(86) 0755-2985 2397 E-mail: info@gdkesign.cn Web: www.gdkesign.com

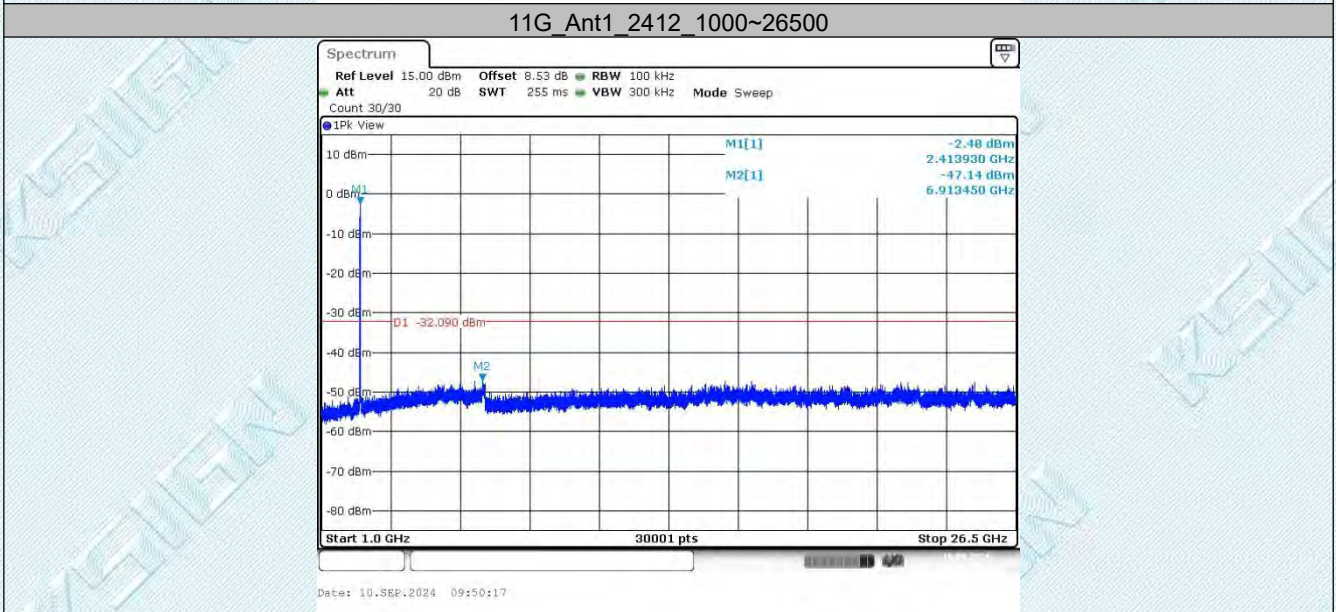
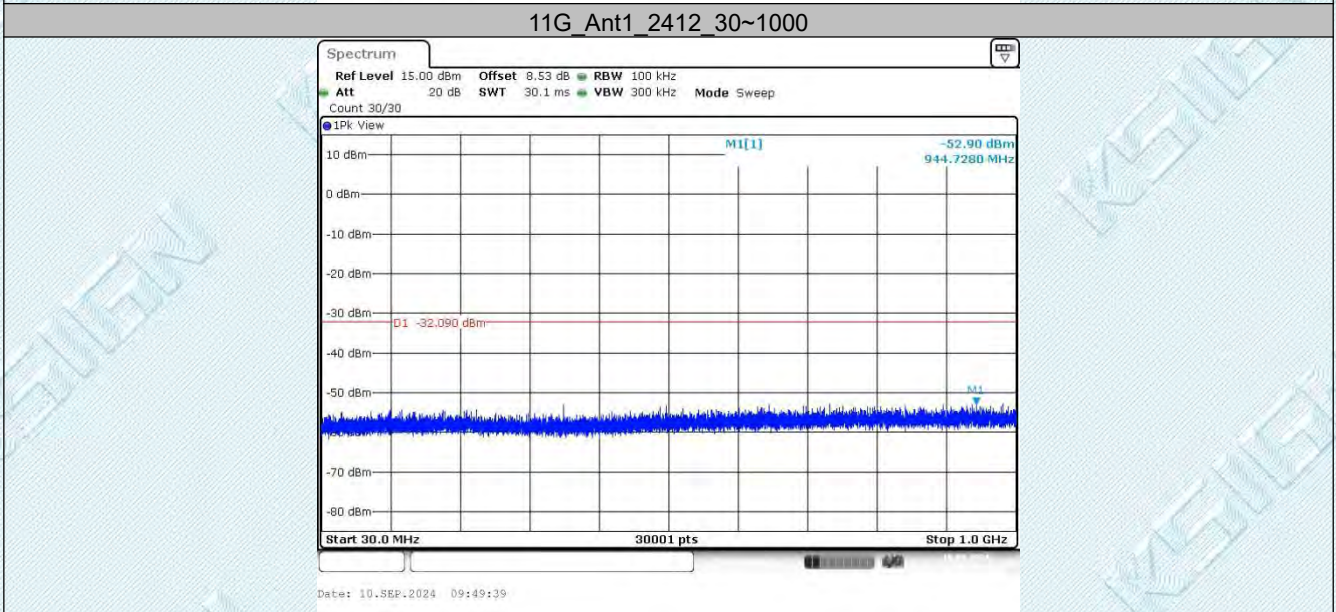
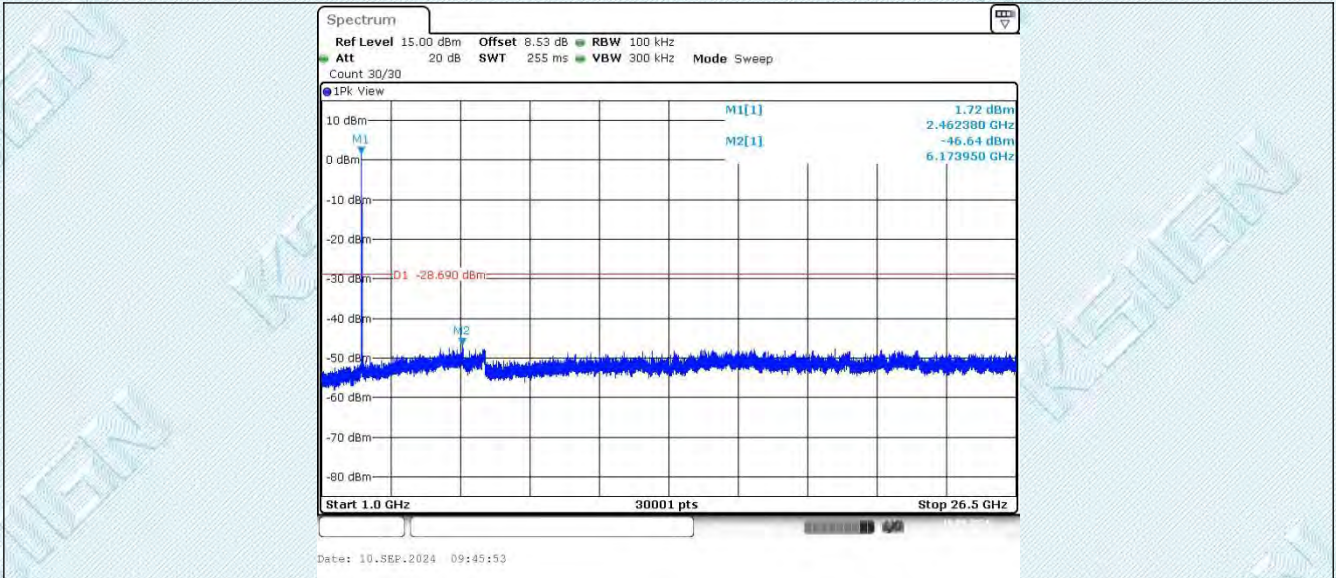

TRF No. RF_R1

Add: West Side of 1/F., Building C, Zone A, Fuyuan New Factory, Jiujiu Industrial Park, Minzhu, Shatou, Shajing, Bao'an District, Shenzhen, Guangdong, China

Tel: +(86) 0755-2985 2678 Fax: +(86) 0755-2985 2397 E-mail: info@gdkesign.cn Web: www.gdkesign.com

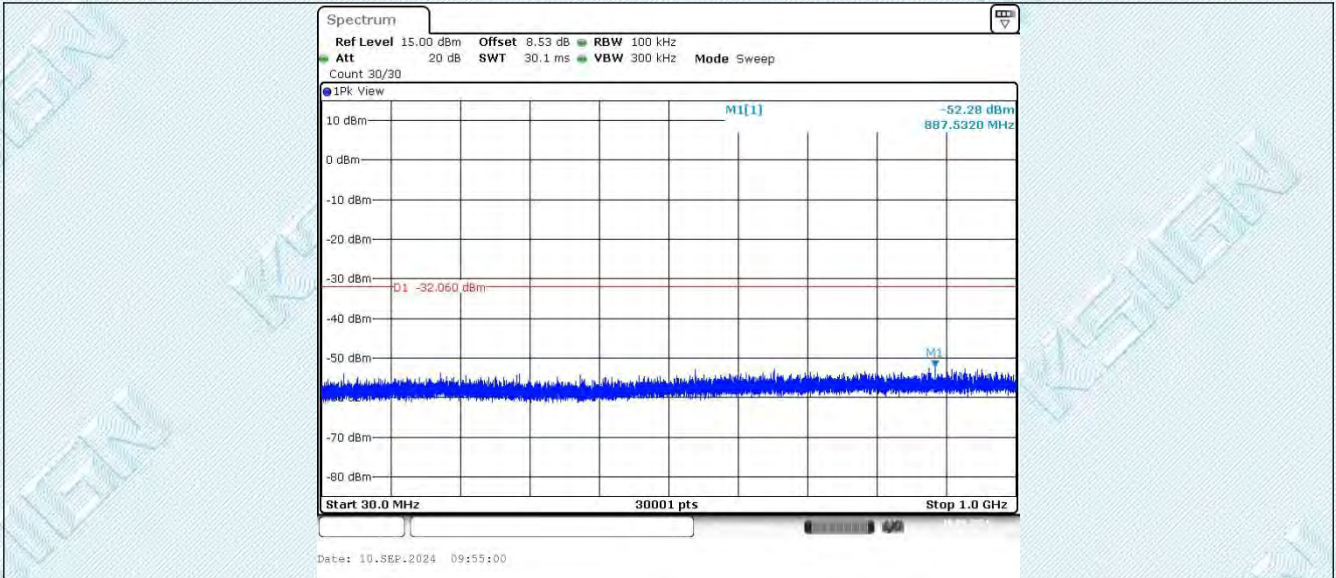

11G_Ant1_2437_1000~26500

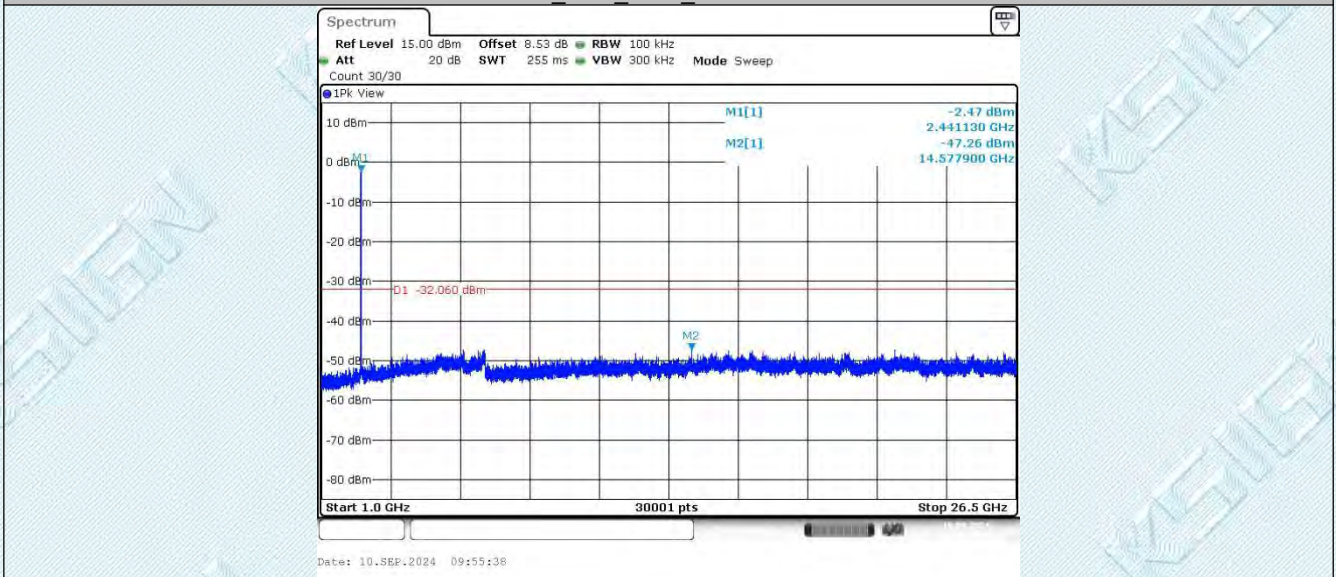

11G_Ant1_2462_30~1000

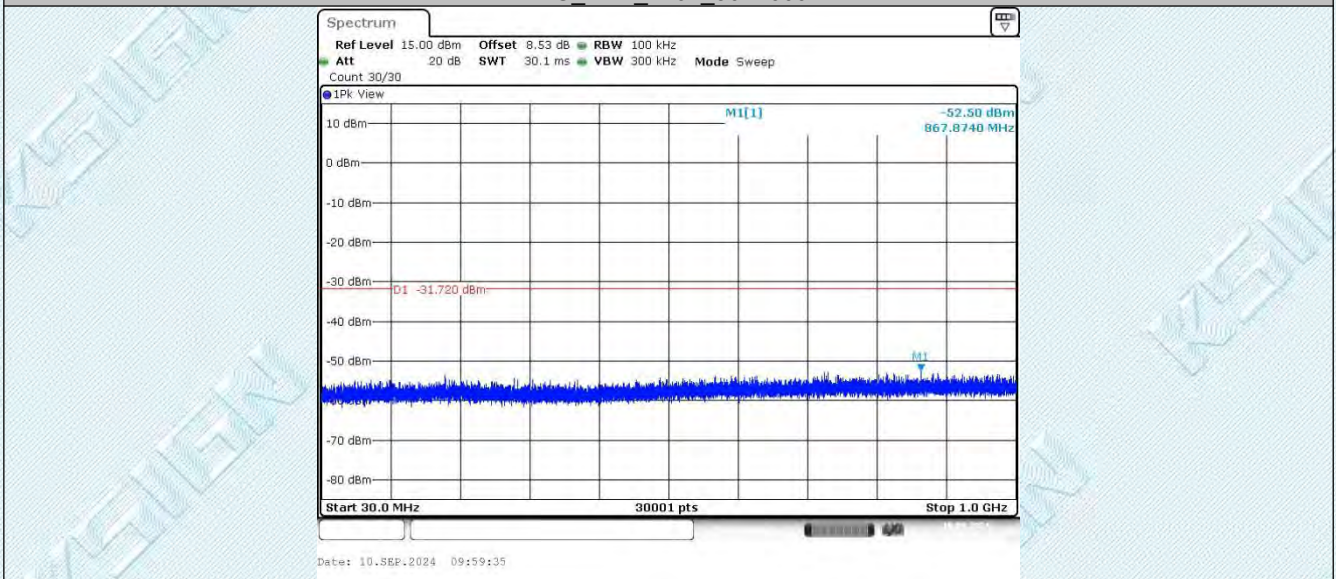

11G_Ant1_2462_1000~26500

TRF No. RF_R1

Add: West Side of 1/F., Building C, Zone A, Fuyuan New Factory, Jiujiu Industrial Park, Minzhu, Shatou, Shajing, Bao'an District, Shenzhen, Guangdong, China

Tel: +(86) 0755-2985 2678 Fax: +(86) 0755-2985 2397 E-mail: info@gdkesign.cn Web: www.gdkesign.com

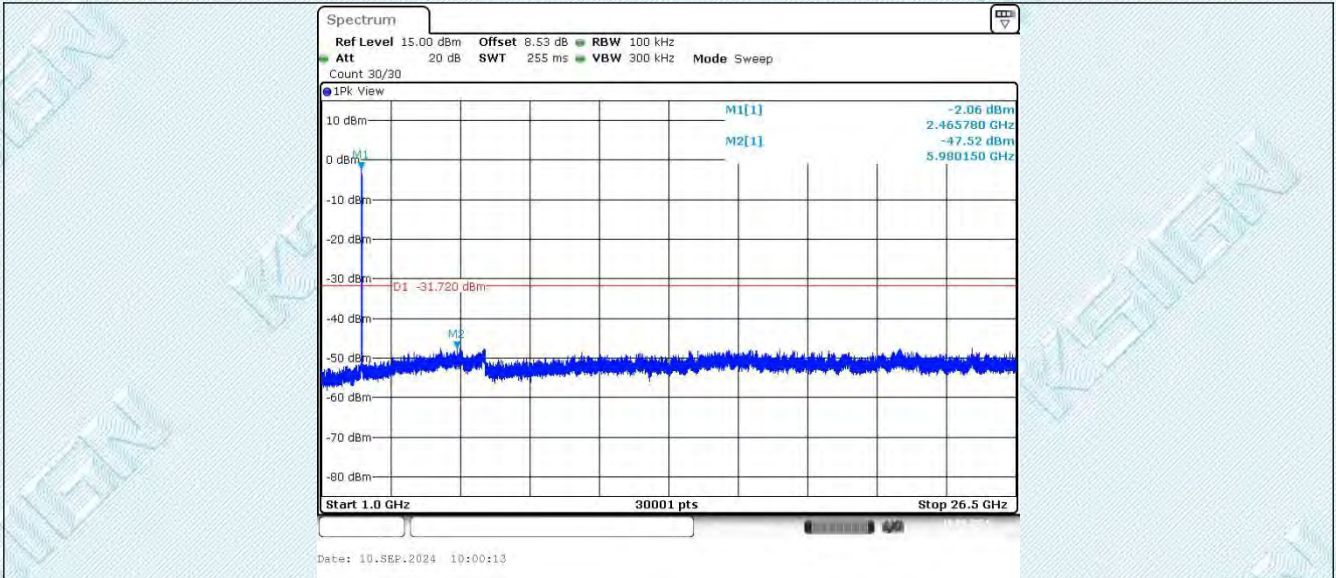

11N20SISO_Ant1_2412_30~1000

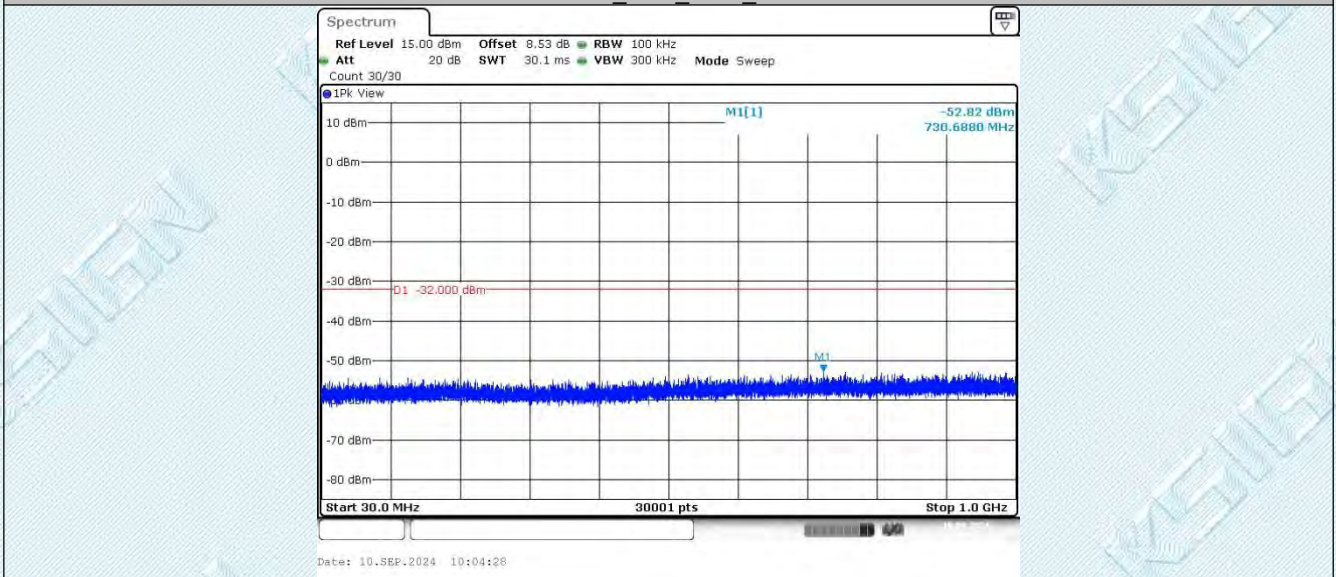

11N20SISO_Ant1_2412_1000~26500

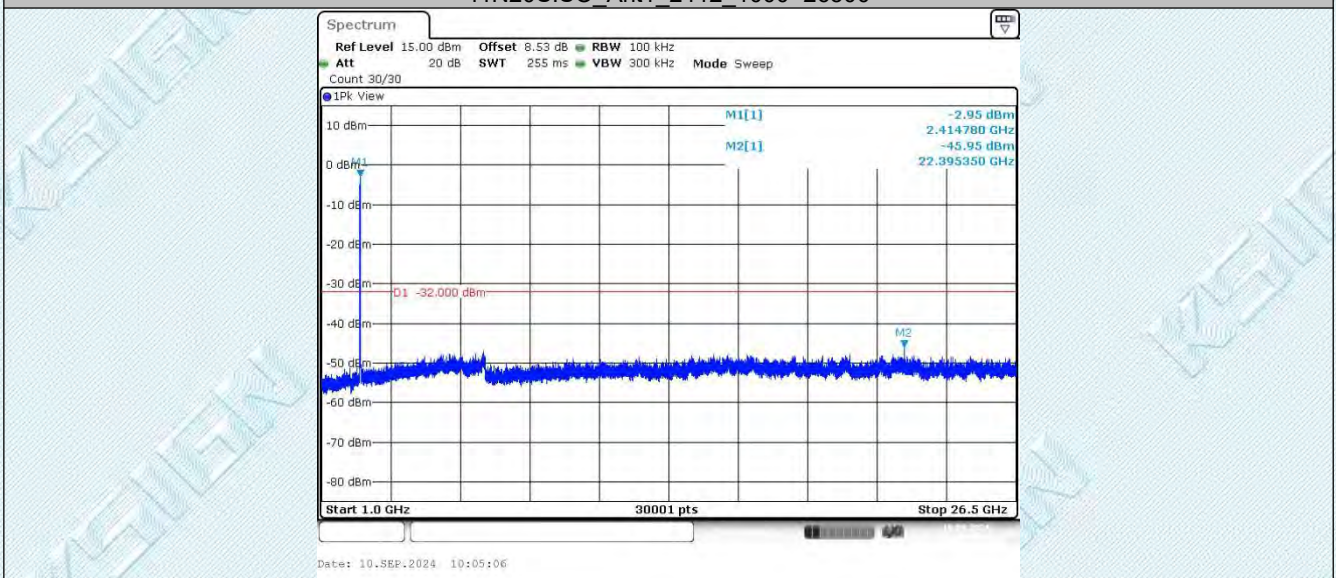

11N20SISO_Ant1_2437_30~1000

TRF No. RF_R1

Add: West Side of 1/F., Building C, Zone A, Fuyuan New Factory, Jiujiu Industrial Park, Minzhu, Shatou, Shajing, Bao'an District, Shenzhen, Guangdong, China

Tel: +(86) 0755-2985 2678 Fax: +(86) 0755-2985 2397 E-mail: info@gdkesign.cn Web: www.gdkesign.com

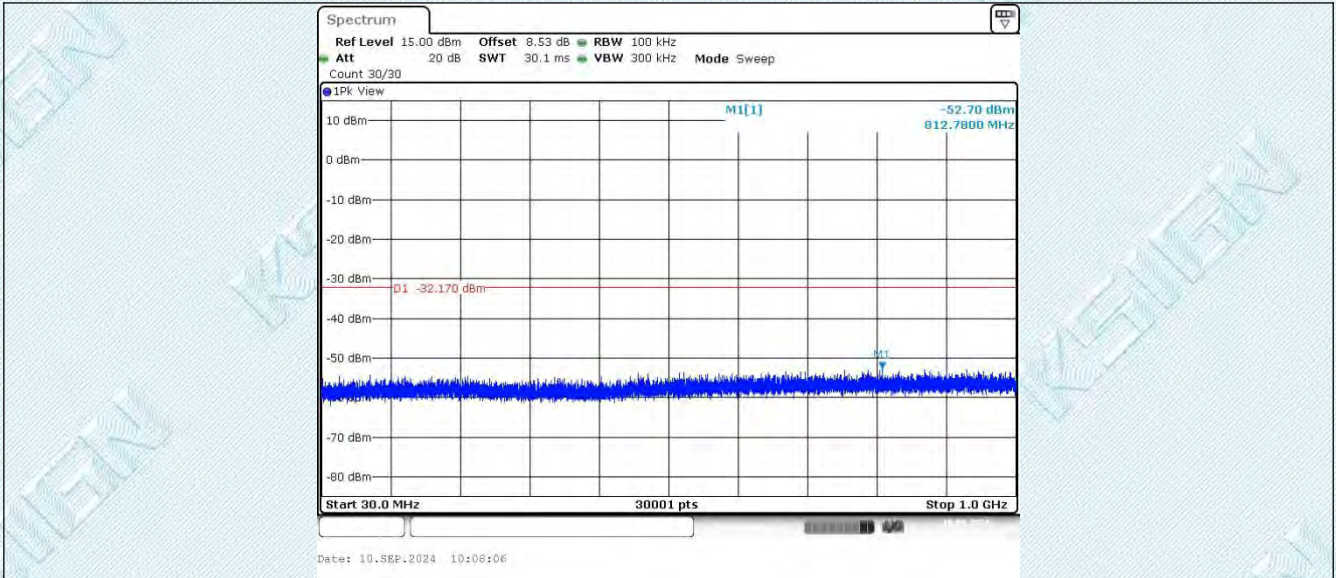

11N20SISO_Ant1_2437_1000~26500

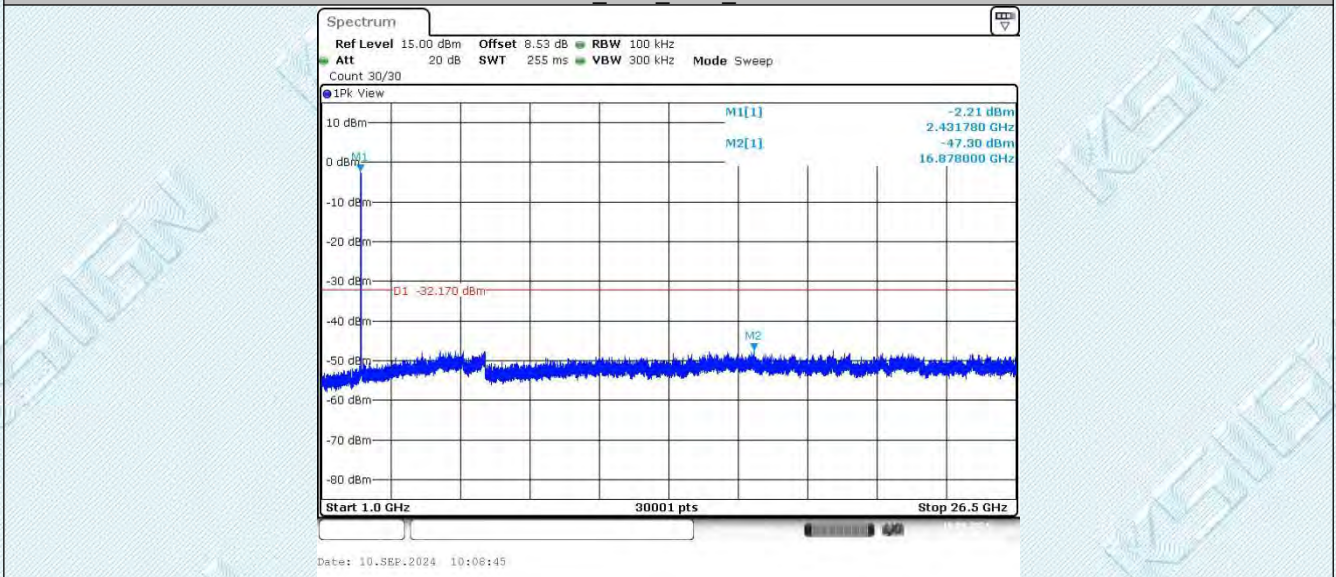

11N20SISO_Ant1_2462_30~1000

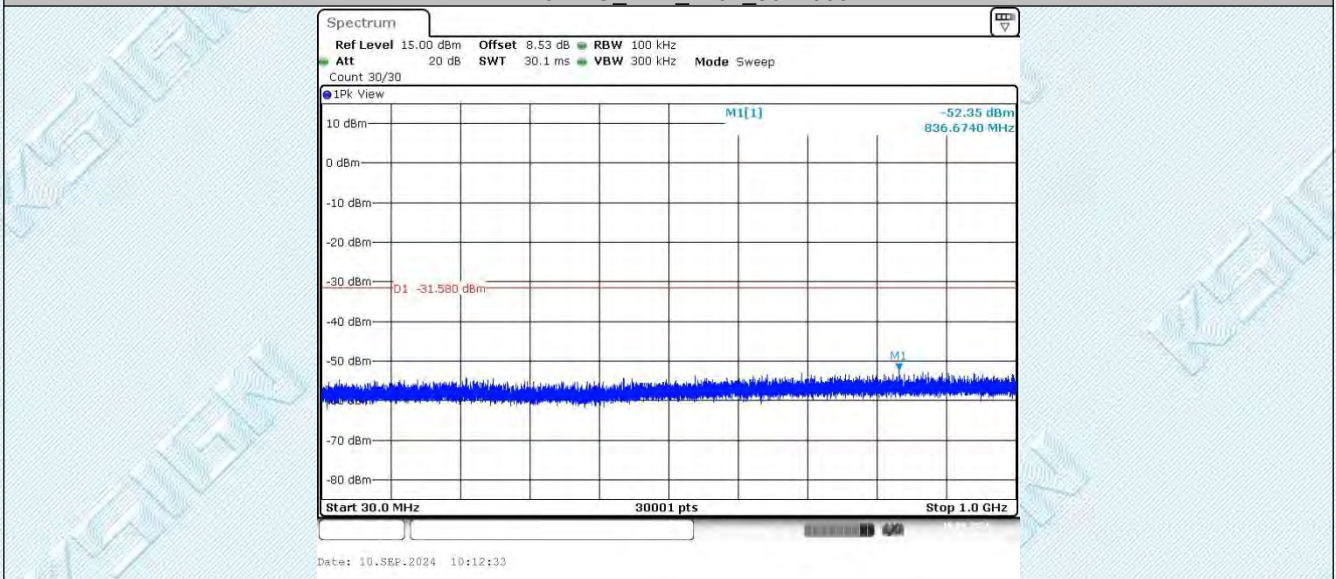

11N20SISO_Ant1_2462_1000~26500

TRF No. RF_R1

Add: West Side of 1/F., Building C, Zone A, Fuyuan New Factory, Jiujiu Industrial Park, Minzhu, Shatou, Shajing, Bao'an District, Shenzhen, Guangdong, China

Tel: +(86) 0755-2985 2678 Fax: +(86) 0755-2985 2397 E-mail: info@gdkesign.cn Web: www.gdkesign.com

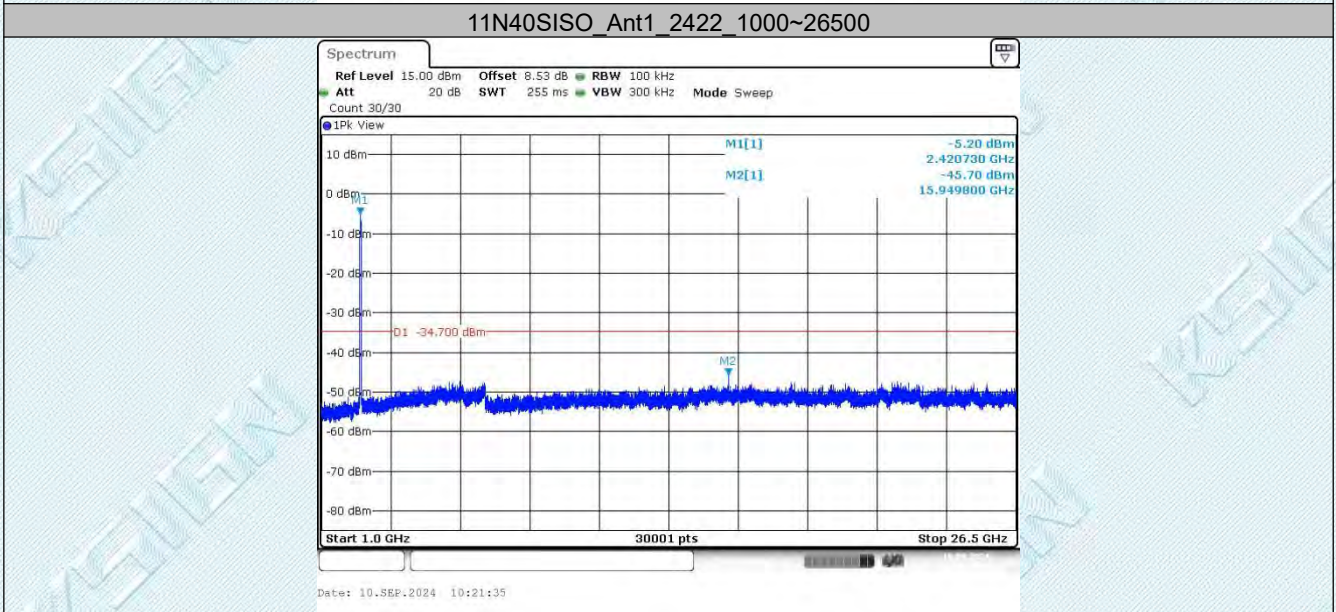
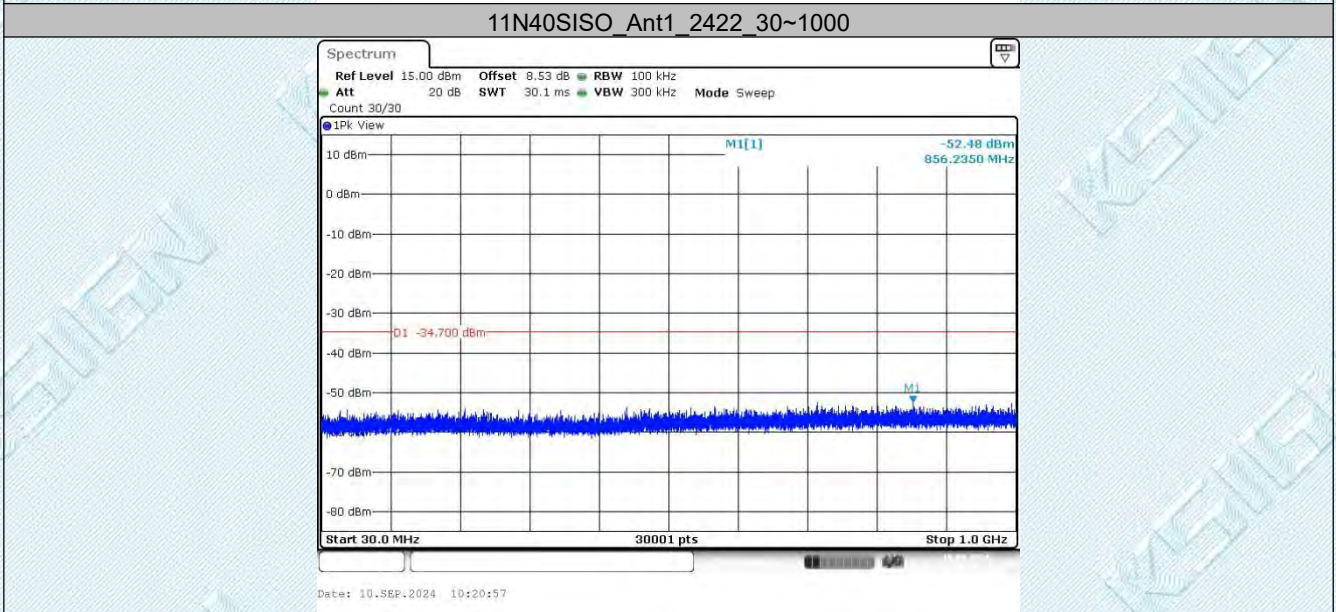
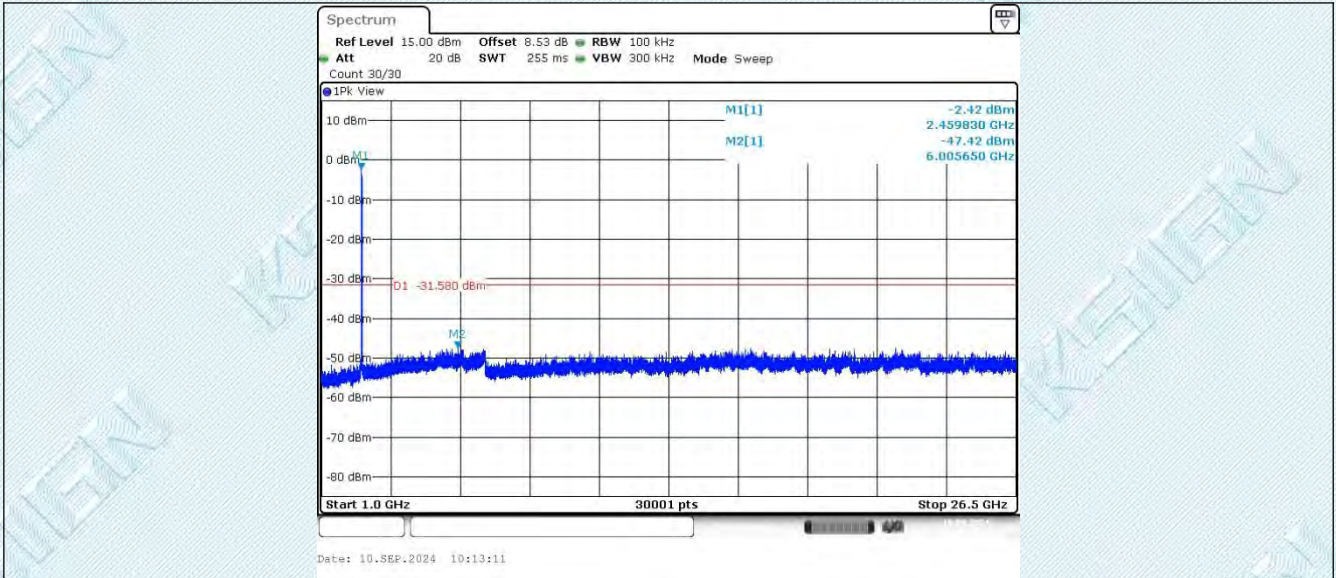

TRF No. RF_R1

Add: West Side of 1/F., Building C, Zone A, Fuyuan New Factory, Jiujiu Industrial Park, Minzhu, Shatou, Shajing, Bao'an District, Shenzhen, Guangdong, China

Tel: +(86) 0755-2985 2678 Fax: +(86) 0755-2985 2397 E-mail: info@gdkesign.cn Web: www.gdkesign.com

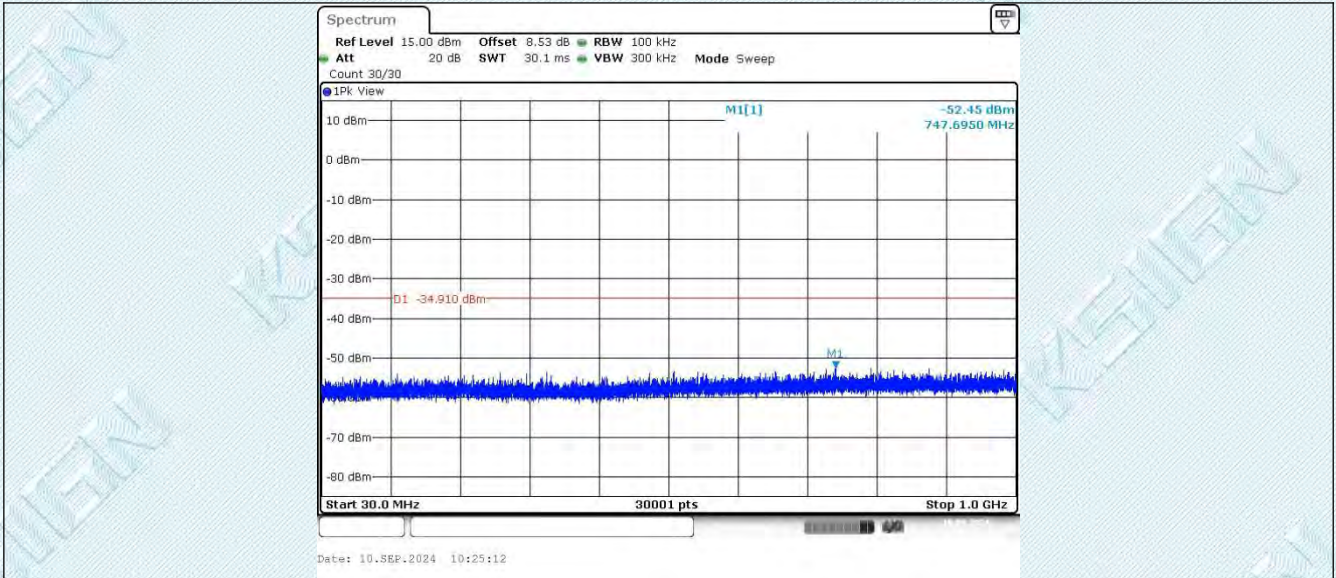

11N40SISO_Ant1_2437_1000~26500

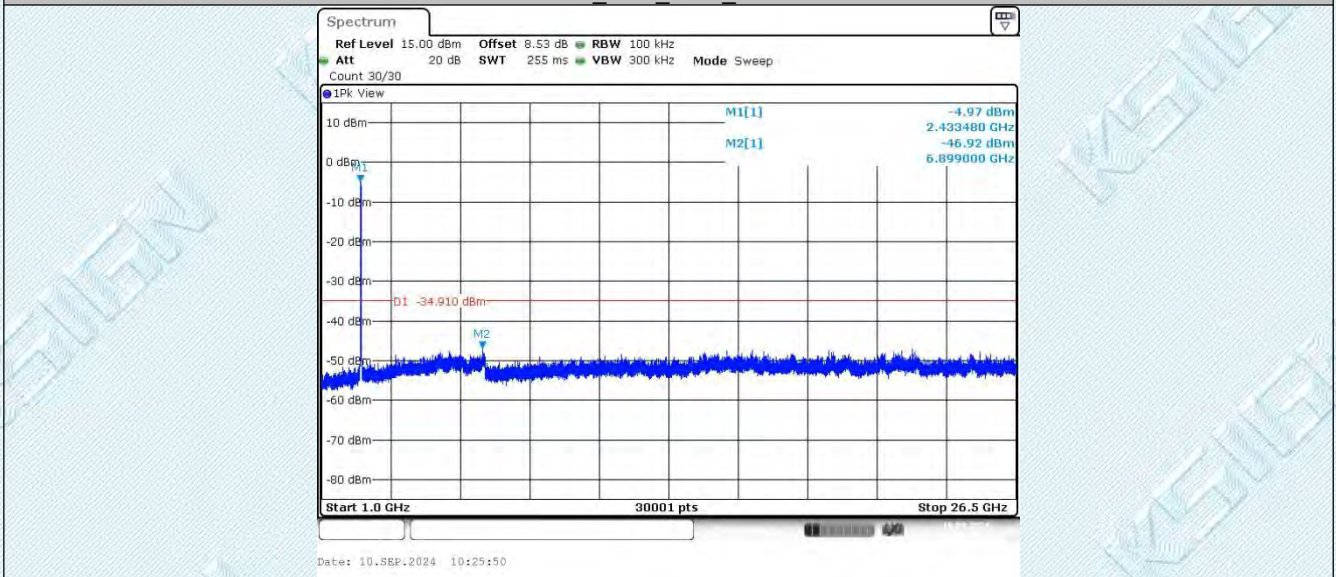

11N40SISO_Ant1_2452_30~1000

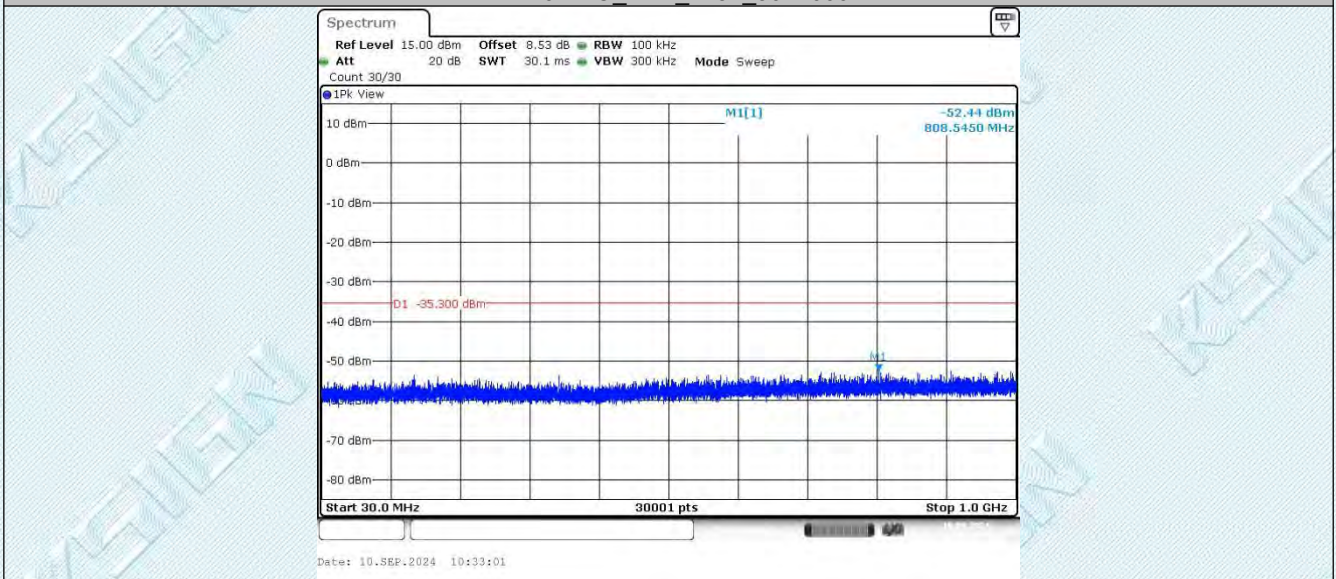

11N40SISO_Ant1_2452_1000~26500

TRF No. RF_R1

Add: West Side of 1/F., Building C, Zone A, Fuyuan New Factory, Jiujiu Industrial Park, Minzhu, Shatou, Shajing, Bao'an District, Shenzhen, Guangdong, China

Tel: +(86) 0755-2985 2678 Fax: +(86) 0755-2985 2397 E-mail: info@gdkesign.cn Web: www.gdkesign.com

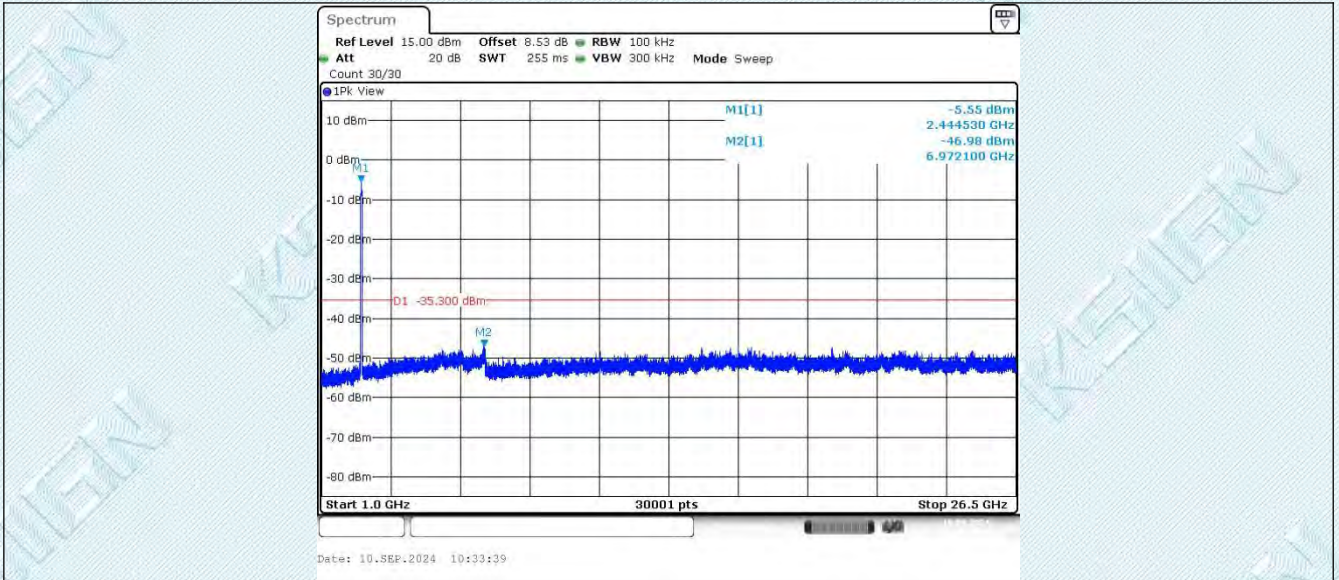

TRF No. RF_R1

Add: West Side of 1/F., Building C, Zone A, Fuyuan New Factory, Jiujiu Industrial Park, Minzhu, Shatou, Shajing, Bao'an District, Shenzhen, Guangdong, China

Tel: +(86) 0755-2985 2678 Fax: +(86) 0755-2985 2397 E-mail: info@gdksign.cn Web: www.gdksign.com

6.8. Appendix H: Duty Cycle

6.8.1. Test Result

TestMode	Antenna	Frequency[MHz]	Transmission Duration [ms]	Transmission Period [ms]	Duty Cycle [%]
11B	Ant1	2412	20.00	20.00	100.00
		2437	20.00	20.00	100.00
		2462	20.00	20.00	100.00
11G	Ant1	2412	20.00	20.00	100.00
		2437	20.00	20.00	100.00
		2462	20.00	20.00	100.00
11N20SISO	Ant1	2412	20.00	20.00	100.00
		2437	20.00	20.00	100.00
		2462	20.00	20.00	100.00
11N40SISO	Ant1	2422	20.00	20.00	100.00
		2437	20.00	20.00	100.00
		2452	20.00	20.00	100.00

Duty Cycle=Transmission Duration/Transmission Period*100%

6.8.2. Test Graphs

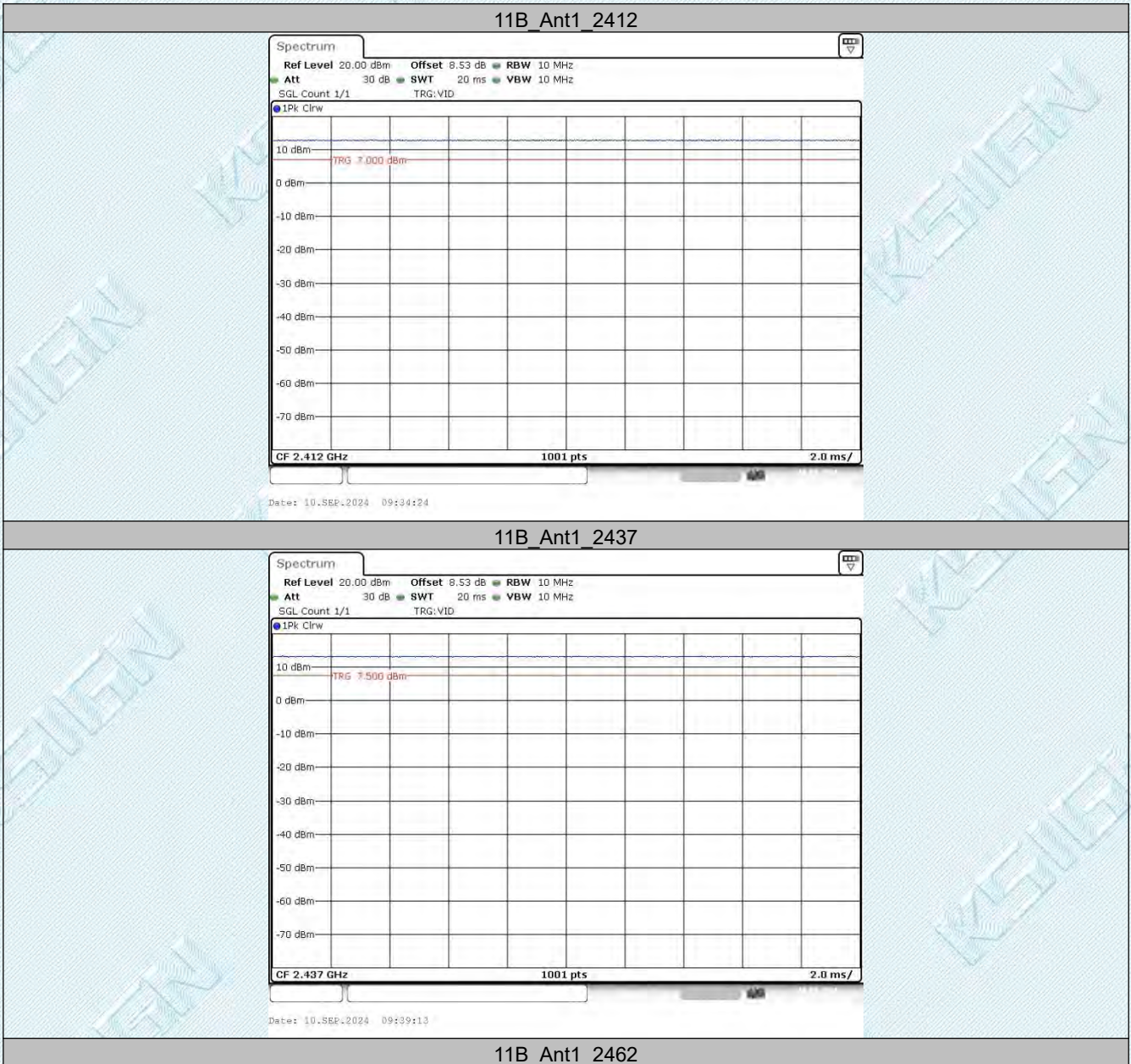

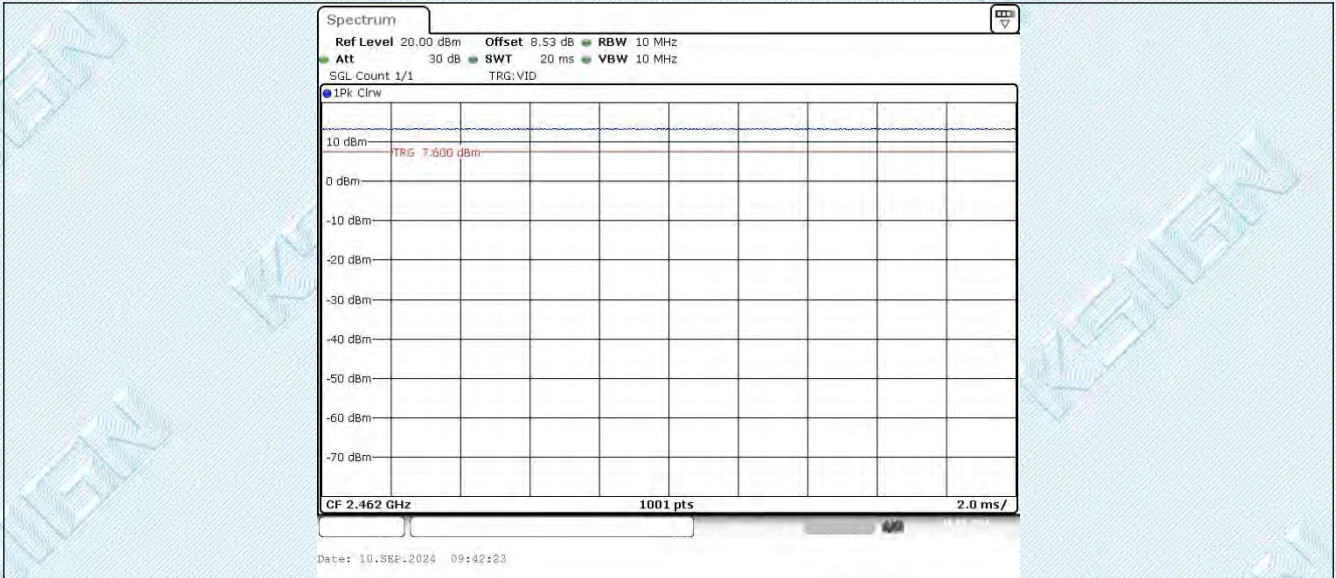

11G_Ant1_2412

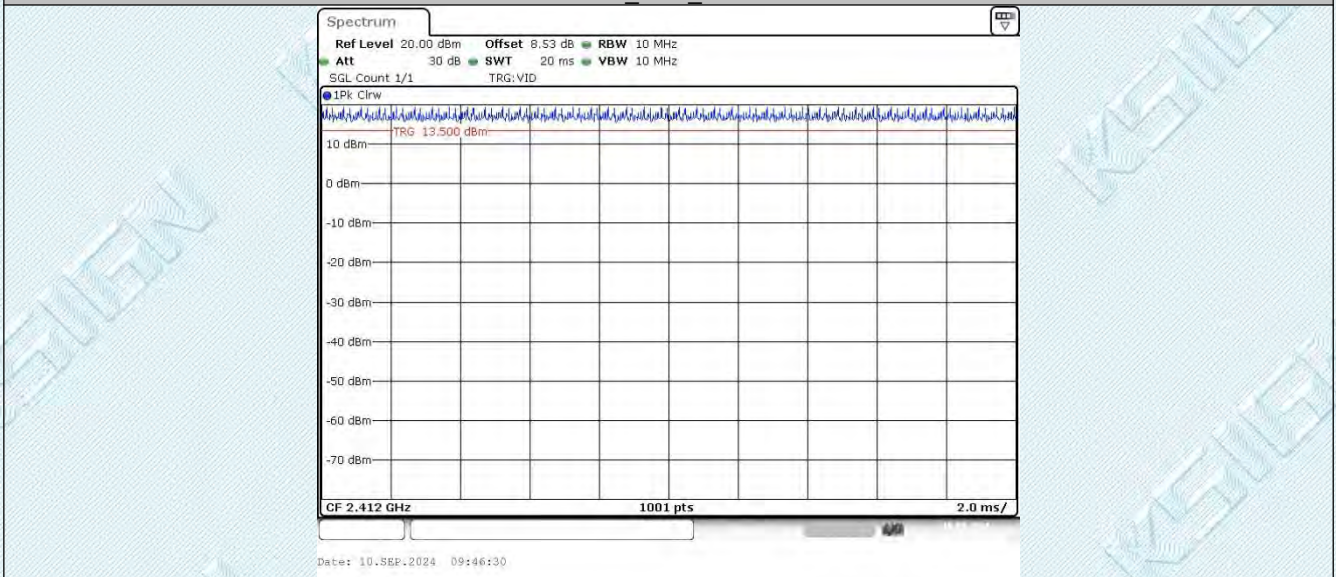

11G_Ant1_2437

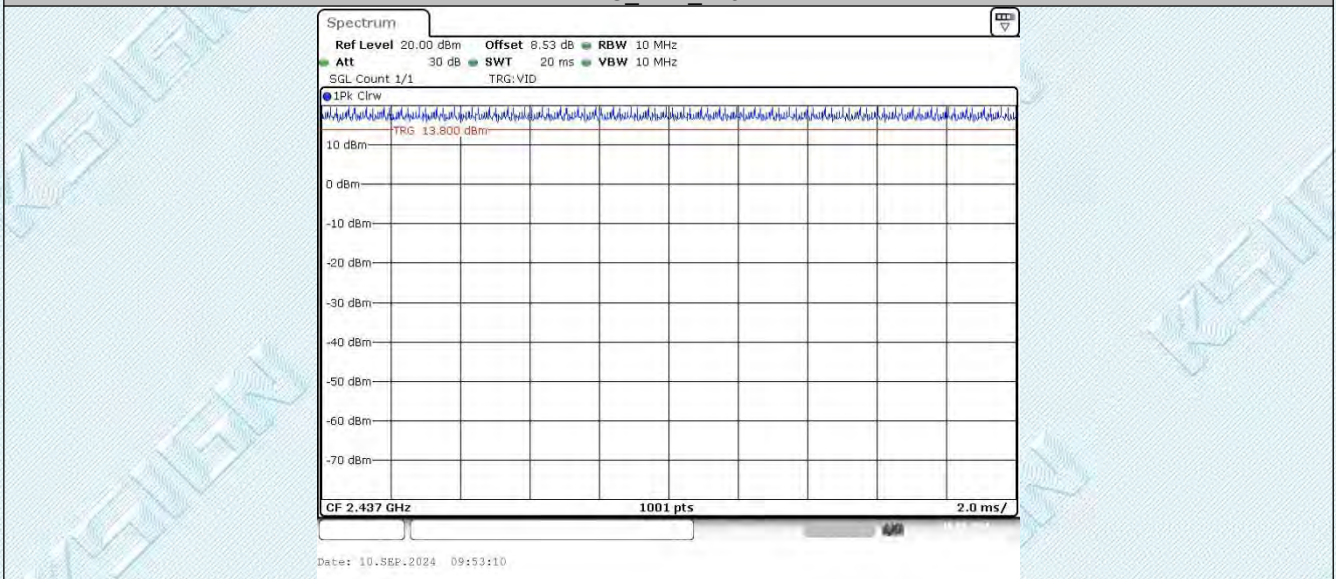

11G_Ant1_2462

TRF No. RF_R1

Add: West Side of 1/F., Building C, Zone A, Fuyuan New Factory, Jiujiu Industrial Park, Minzhu, Shatou, Shajing, Bao'an District, Shenzhen, Guangdong, China

Tel: +(86) 0755-2985 2678 Fax: +(86) 0755-2985 2397 E-mail: info@gdkesign.cn Web: www.gdkesign.com

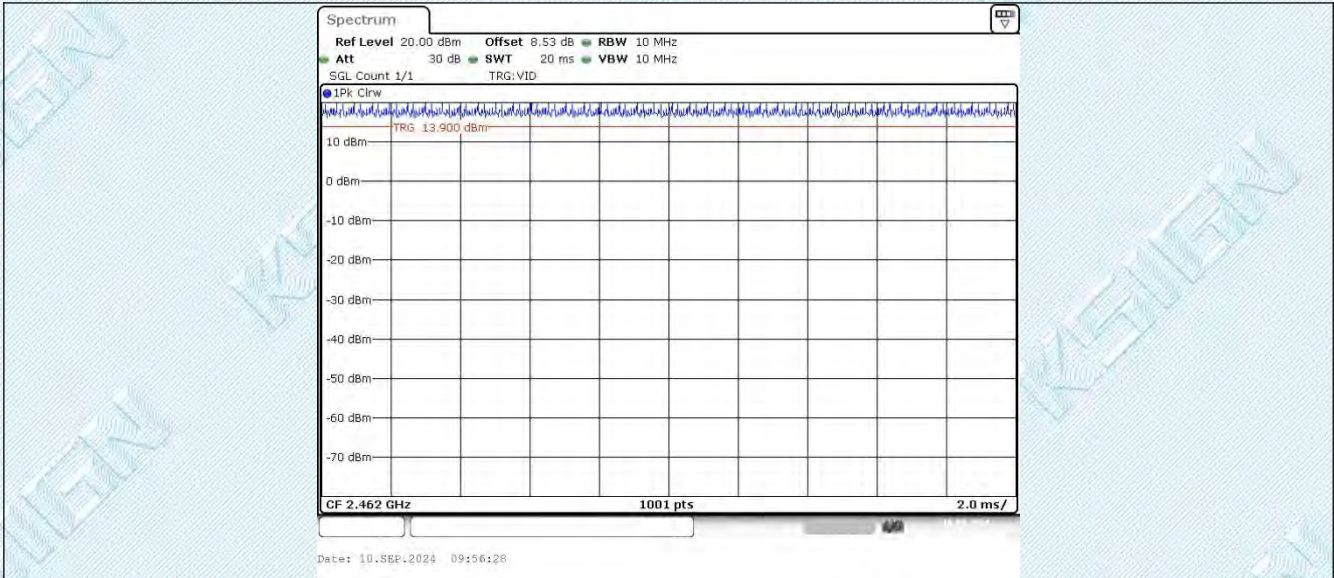

11N20SISO_Ant1_2412

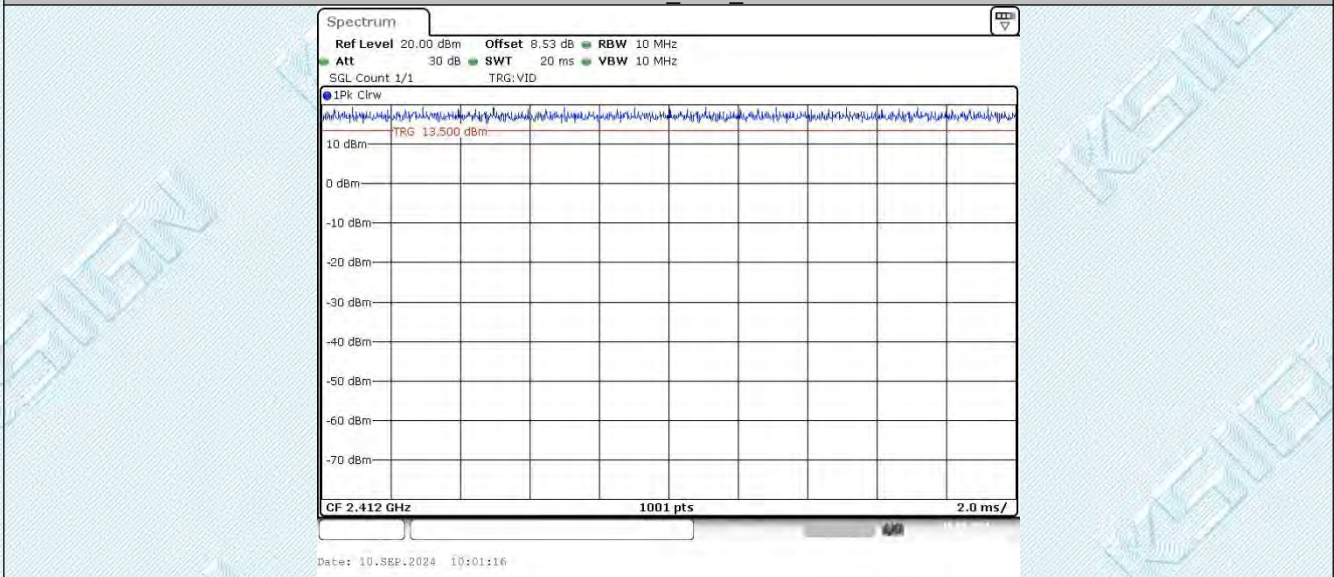

11N20SISO_Ant1_2437

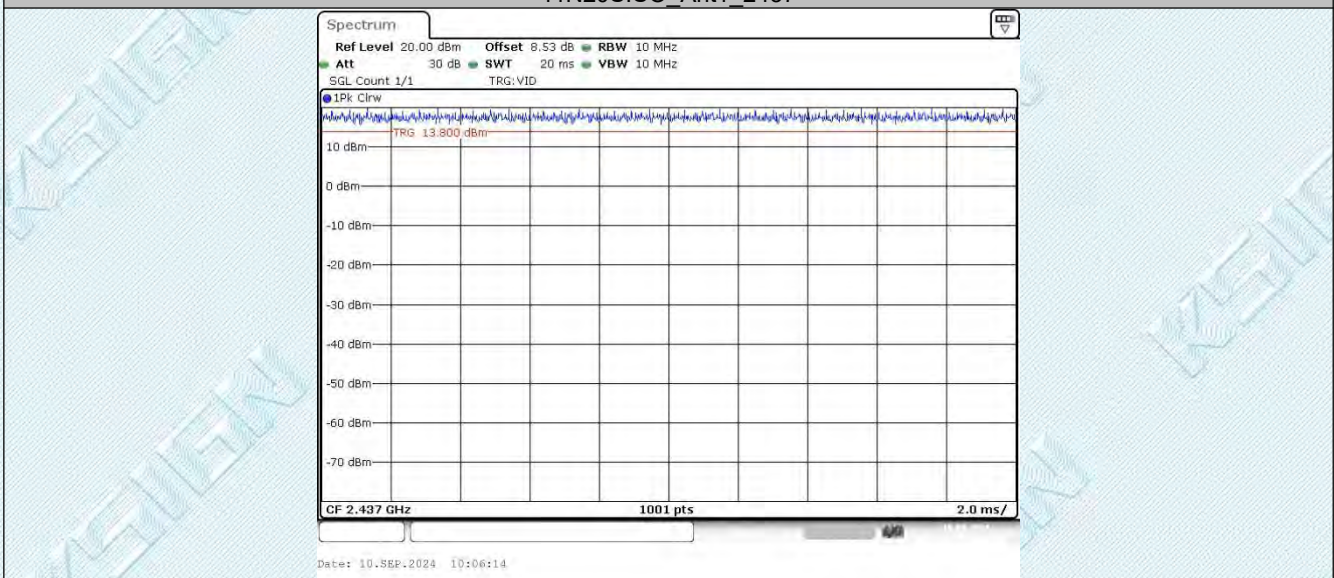

11N20SISO_Ant1_2462

TRF No. RF_R1

Add: West Side of 1/F., Building C, Zone A, Fuyuan New Factory, Jiujiu Industrial Park, Minzhu, Shatou, Shajing, Bao'an District, Shenzhen, Guangdong, China

Tel: +(86) 0755-2985 2678 Fax: +(86) 0755-2985 2397 E-mail: info@gdkesign.cn Web: www.gdkesign.com

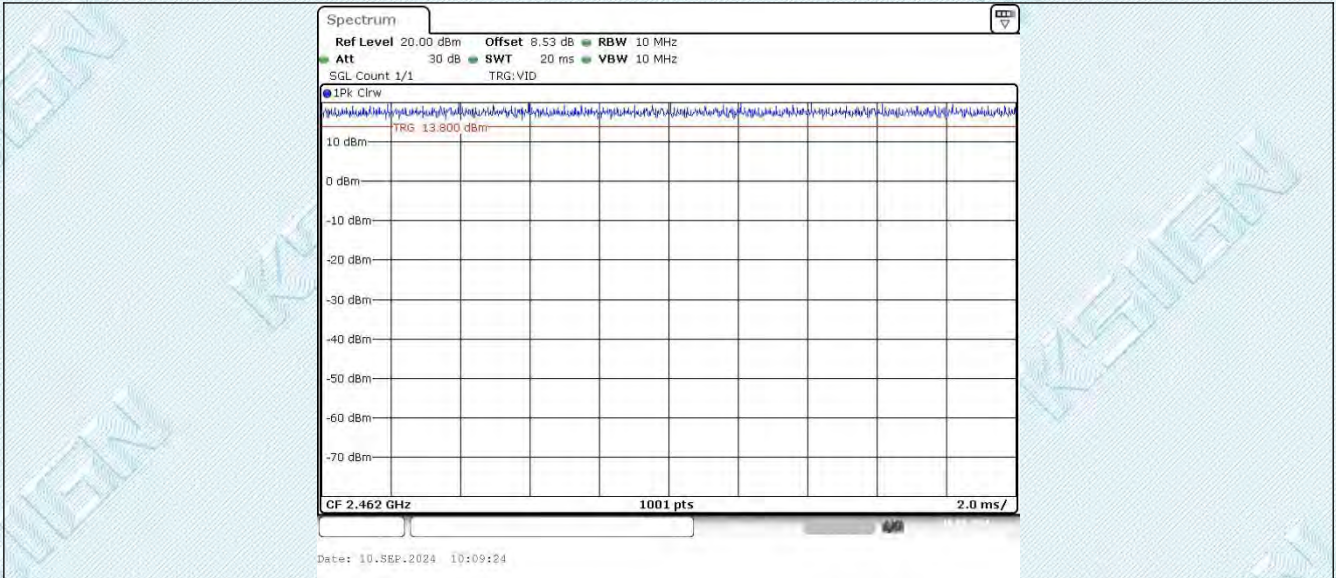

11N40SISO_Ant1_2422

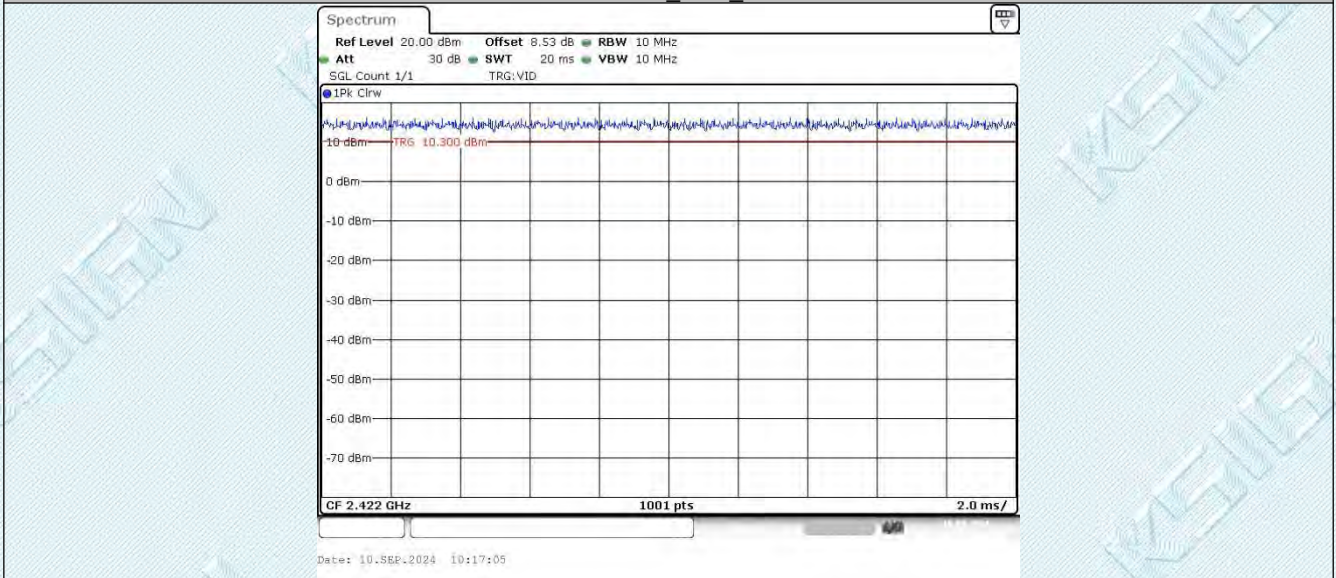

11N40SISO_Ant1_2437

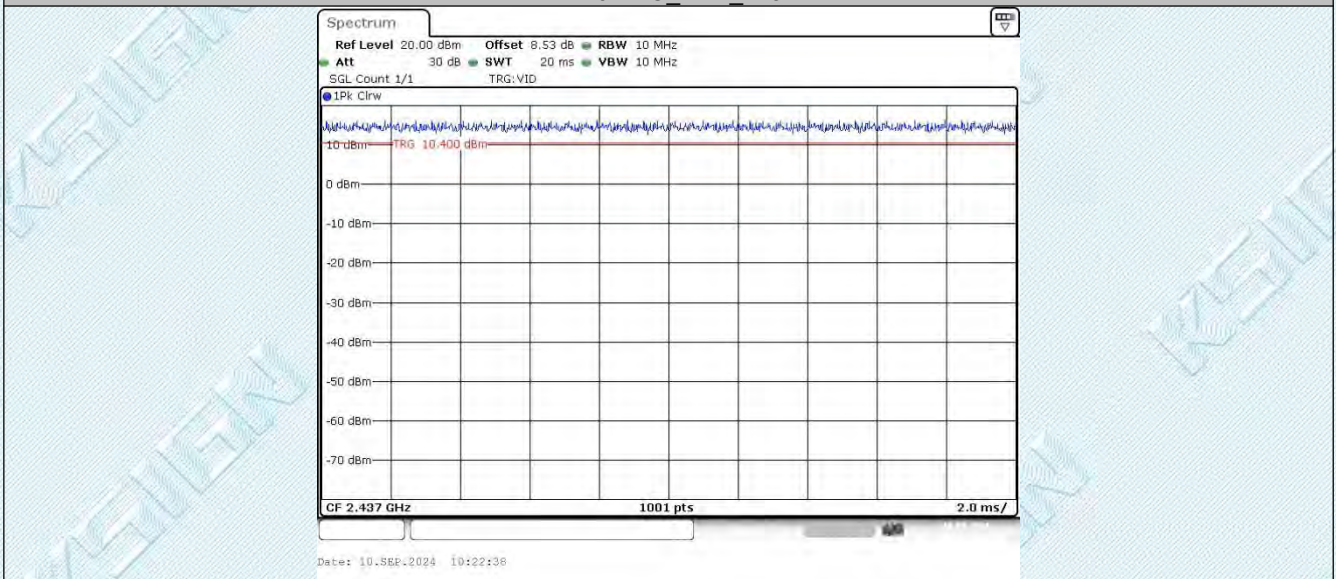

11N40SISO_Ant1_2452

TRF No. RF_R1

Add: West Side of 1/F., Building C, Zone A, Fuyuan New Factory, Jiujiu Industrial Park, Minzhu, Shatou, Shajing, Bao'an District, Shenzhen, Guangdong, China

Tel: +(86) 0755-2985 2678 Fax: +(86) 0755-2985 2397 E-mail: info@gdkesign.cn Web: www.gdkesign.com

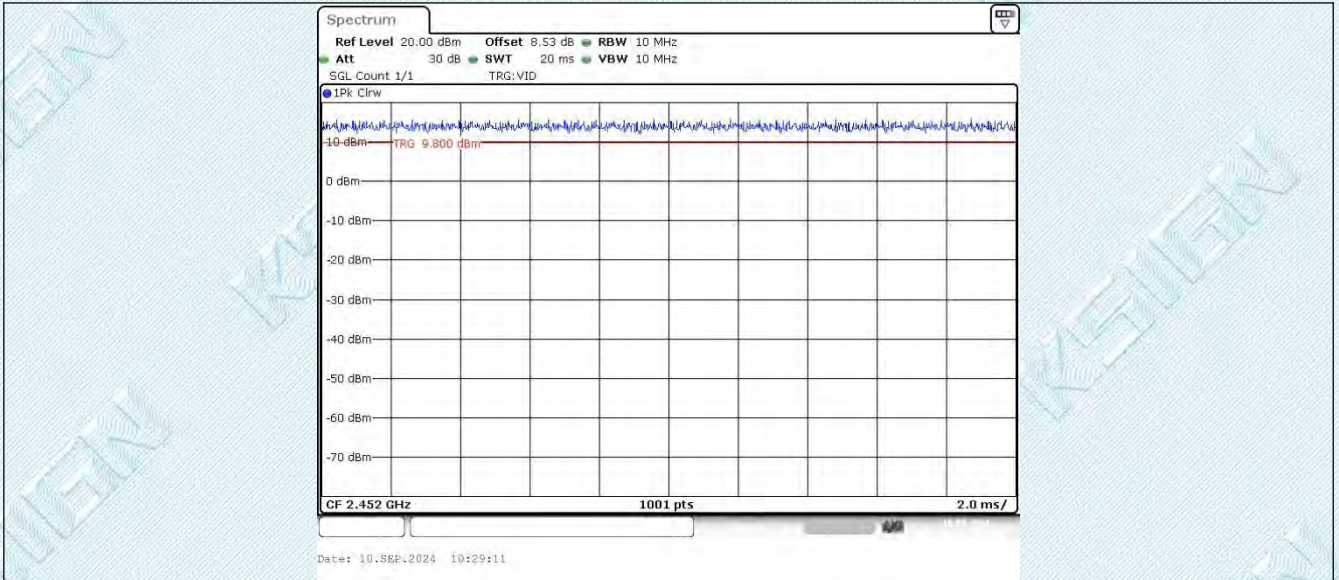

TRF No. RF_R1

Add: West Side of 1/F., Building C, Zone A, Fuyuan New Factory, Jiujiu Industrial Park, Minzhu, Shatou, Shajing, Bao'an District, Shenzhen, Guangdong, China

Tel: +(86) 0755-2985 2678 Fax: +(86) 0755-2985 2397 E-mail: info@gdkesign.cn Web: www.gdkesign.com

--THE END--

Important Notice

1. The results are valid only for the samples submitted.
2. The report is invalid without the "APPROVED Seal" and the "Riding Seam Seal".
3. This report is invalid without the signature of the main inspector, reviewer, or approver.
4. The testing report cannot be partially copied without the written consent of our laboratory.
5. If the report is not stamped with the "CMA" logo, it indicates that the report does not have any social certification effect in China.
6. Product information, customer information, and sample sources are all provided by the client, and we are not responsible for their authenticity.
7. The inspection basis or inspection items marked with "★" are not within the scope of CNAS, CMA and A2LA accreditation in this laboratory.
8. Reports that are transferred, copied, stolen, impersonated, altered, or tampered with in any media form without authorization are invalid.
9. If you have any objections to this report, you can appeal to our unit within 15 days after receiving the report. Failure to do so will not be accepted.
10. For situations where compliance decision needs to be made based on test result, such as when there are no relevant decision rules required by the regulations, standards, or technical specifications used, or when there are no relevant customer requirements, the report issued by our laboratory refer to ILAC-G8:09-2019 and CNAS-GL015:2022 using simple acceptance decision rules.

Laboratory: KSIGN(Guangdong) Testing Co., Ltd.

Address: First Floor West Side, Building C, Zone A, Fuyuan New Factory, Jiujiu Industrial Park, Minzhu Village, Shatou Community, Shajing Street, Bao'an District, Shenzhen City, Guangdong Province, P. R. China. 518104

Tel.: +(86) 0755-29852678

Fax.: +(86) 0755-29852397

E-mail: info@gdksign.cn

Web: www.gdksign.com