

**ELECTROMAGNETIC EMISSIONS
COMPLIANCE REPORT**

Applicant: DIGIMAX INNOVATIVE PRODUCTS LTD.
2F., No.196, Sec.2, Zhongxing Rd., Xindian Dist. New Taipei City

Manufacturer: Digisine Energytech Co., Ltd.
2F., No.196, Sec.2, Zhongxing Rd., Xindian Dist. New Taipei City

Product Name: Hearing Aid

Brand Name: Mimitakara, Digisine, Digimax

Model No.: DP-6KNX, UP-6KNX

Model Difference: For marketing purpose

Report Number: TERF2303000419E2

FCC ID 2BBAZ-6KNX

Date of EUT Received: March 1, 2023

Date of Test: March 15, 2023 ~ March 16, 2023

Issue Date: June 8, 2023

Approved By _____

Arno Hsieh

We hereby certify that:

The above equipment was tested by SGS Taiwan Ltd. Central RF Lab The test data, data evaluation, test procedures, and equipment configurations shown in this report were made in accordance with the procedures given in ANSI C63.10:2013 and the energy emitted by the sample EUT comply with FCC rule part §15.247.

The results of this report relate only to the sample identified in this report.

Unless otherwise stated the results shown in this test report refer only to the sample(s) tested and such sample(s) are retained for 90 days only.
除非另有說明，此報告結果僅對測試之樣品負責，同時此樣品僅保留90天。本報告未經本公司書面許可，不可部份複製。

This document is issued by the Company subject to its General Conditions of Service printed overleaf, available on request or accessible at <http://www.sgs.com.tw/Terms-and-Conditions> and for electronic format documents, subject to Terms and Conditions for Electronic Documents at <http://www.sgs.com.tw/Terms-and-Conditions>. Attention is drawn to the limitation of liability, indemnification and jurisdiction issues defined therein. Any holder of this document is advised that information contained hereon reflects the Company's findings at the time of its intervention only and within the limits of Client's instructions, if any. The Company's sole responsibility is to its Client and this document does not exonerate parties to a transaction from exercising all their rights and obligations under the transaction documents. This document cannot be reproduced except in full, without prior written approval of the Company. Any unauthorized alteration, forgery or falsification of the content or appearance of this document is unlawful and offenders may be prosecuted to the fullest extent of the law.

Revision History

| Report Number | Revision | Description | Issue Date | Revised By | Remark |
|------------------|----------|-------------|--------------|------------|--------|
| TERF2303000419E2 | 00 | Original | June 8, 2023 | Yuri Tsai | |
| | | | | | |
| | | | | | |
| | | | | | |
| | | | | | |
| | | | | | |

Note:

- 1、The remark "" indicates modification of the report upon requests from certification body.

Unless otherwise stated the results shown in this test report refer only to the sample(s) tested and such sample(s) are retained for 90 days only.

除非另有說明，此報告結果僅對測試之樣品負責，同時此樣品僅保留90天。本報告未經本公司書面許可，不可部份複製。

This document is issued by the Company subject to its General Conditions of Service printed overleaf, available on request or accessible at <http://www.sgs.com.tw/Terms-and-Conditions> and for electronic format documents, subject to Terms and Conditions for Electronic Documents at <http://www.sgs.com.tw/Terms-and-Conditions>. Attention is drawn to the limitation of liability, indemnification and jurisdiction issues defined therein. Any holder of this document is advised that information contained hereon reflects the Company's findings at the time of its intervention only and within the limits of Client's instructions, if any. The Company's sole responsibility is to its Client and this document does not exonerate parties to a transaction from exercising all their rights and obligations under the transaction documents. This document cannot be reproduced except in full, without prior written approval of the Company. Any unauthorized alteration, forgery or falsification of the content or appearance of this document is unlawful and offenders may be prosecuted to the fullest extent of the law.

SGS Taiwan Ltd.

No.134,Wu Kung Road, New Taipei Industrial Park, Wuku District, New Taipei City, Taiwan/新北市五股區新北產業園區五工路 134 號

台灣檢驗科技股份有限公司

t (886-2) 2299-3279

f (886-2) 2298-0488

www.sgs.com.tw

Member of SGS Group

Contents

| | | |
|----|--|----|
| 1 | GENERAL INFORMATION | 4 |
| 2 | SYSTEM TEST CONFIGURATION | 6 |
| 3 | SUMMARY OF TEST RESULTS | 9 |
| 4 | DESCRIPTION OF TEST MODES | 10 |
| 5 | MEASUREMENT UNCERTAINTY | 12 |
| 6 | MEASUREMENT EQUIPMENT USED | 13 |
| 7 | CONDUCTED EMISSION TEST | 14 |
| 8 | PEAK OUTPUT POWER MEASUREMENT | 18 |
| 9 | EMISSION BANDWIDTH MEASUREMENT | 20 |
| 10 | CONDUCTED BAND EDGES AND SPURIOUS EMISSION MEASUREMENT | 24 |
| 11 | RADIATED BANDEDGE AND SPURIOUS EMISSION MEASUREMENT | 29 |
| 12 | FREQUENCY SEPARATION | 67 |
| 13 | NUMBER OF HOPPING FREQUENCY | 71 |
| 14 | TIME OF OCCUPANCY (DWELL TIME) | 74 |
| 15 | ANTENNA REQUIREMENT | 79 |

Unless otherwise stated the results shown in this test report refer only to the sample(s) tested and such sample(s) are retained for 90 days only.
 除非另有說明，此報告結果僅對測試之樣品負責，同時此樣品僅保留90天。本報告未經本公司書面許可，不可部份複製。

This document is issued by the Company subject to its General Conditions of Service printed overleaf, available on request or accessible at <http://www.sgs.com.tw/Terms-and-Conditions> and for electronic format documents, subject to Terms and Conditions for Electronic Documents at <http://www.sgs.com.tw/Terms-and-Conditions>. Attention is drawn to the limitation of liability, indemnification and jurisdiction issues defined therein. Any holder of this document is advised that information contained hereon reflects the Company's findings at the time of its intervention only and within the limits of Client's instructions, if any. The Company's sole responsibility is to its Client and this document does not exonerate parties to a transaction from exercising all their rights and obligations under the transaction documents. This document cannot be reproduced except in full, without prior written approval of the Company. Any unauthorized alteration, forgery or falsification of the content or appearance of this document is unlawful and offenders may be prosecuted to the fullest extent of the law.

1 GENERAL INFORMATION

1.1 Product Description

| | |
|------------------------------|--|
| Product Name: | Hearing Aid |
| Brand Name: | Mimitakara, Digisine, Digimax |
| Model No.: | DP-6KNX, UP-6KNX |
| Model Difference: | For marketing purpose |
| Hardware Version: | V1 |
| Firmware Version: | V1 |
| EUT Series No.: | TE_SP_20230301624 |
| Power Supply: | 3.7V from Battery or 5V from USB Cable |
| Test Software (Name/Version) | AWBTRDLAB 1.0.9.22 |

1.2 RF Specification

| | |
|-------------------|------------------------------|
| Radio Technology: | BT BR+EDR |
| Channel number: | 79 channels |
| Modulation type: | GFSK + $\pi/4$ DQPSK + 8DPSK |
| Transmit Power: | 10.83 dBm |
| Frequency Range: | 2.402GHz – 2.480GHz |
| Dwell Time: | $\leq 0.4s$ |

1.3 Antenna Designation

| Antenna Type | Freq. (MHz) | Peak Antenna Gain (dBi) |
|--------------|-------------|-------------------------|
| Chip | 2402 - 2480 | 2.93 |

Note: Antenna information is provided by the applicant.

Unless otherwise stated the results shown in this test report refer only to the sample(s) tested and such sample(s) are retained for 90 days only.
 除非另有說明，此報告結果僅對測試之樣品負責，同時此樣品僅保留90天。本報告未經本公司書面許可，不可部份複製。

This document is issued by the Company subject to its General Conditions of Service printed overleaf, available on request or accessible at <http://www.sgs.com.tw/Terms-and-Conditions> and for electronic format documents, subject to Terms and Conditions for Electronic Documents at <http://www.sgs.com.tw/Terms-and-Conditions>. Attention is drawn to the limitation of liability, indemnification and jurisdiction issues defined therein. Any holder of this document is advised that information contained hereon reflects the Company's findings at the time of its intervention only and within the limits of Client's instructions, if any. The Company's sole responsibility is to its Client and this document does not exonerate parties to a transaction from exercising all their rights and obligations under the transaction documents. This document cannot be reproduced except in full, without prior written approval of the Company. Any unauthorized alteration, forgery or falsification of the content or appearance of this document is unlawful and offenders may be prosecuted to the fullest extent of the law.

1.5 Test Methodology of Applied Standards

FCC Part 15, Subpart C §15.247
 FCC KDB 558074 D01 15.247 Meas. Guidance v05r02
 ANSI C63.10:2013

1.6 Test Facility

| Laboratory | Test Site Address | Test Site Name | FCC Designation number | IC CAB identifier |
|---|---|----------------|------------------------|-------------------|
| SGS Taiwan Ltd. Central RF Lab. (TAF code 3702) | No.134, Wu Kung Road, New Taipei Industrial Park, Wuku District, New Taipei City, Taiwan. | SAC 1 | TW0027 | TW3702 |
| | | SAC 2 | | |
| | | SAC 3 | | |
| | | Conduction 1 | | |
| | | Conducted 1 | | |
| | | Conducted 2 | | |
| | | Conducted 3 | | |
| | | Conducted 4 | | |
| | | Conducted 5 | | |
| | Conducted 6 | | | |
| | No.2, Keji 1st Rd., Guishan District, Taoyuan City, Taiwan 333 | Conduction C | TW0028 | TW3702 |
| | | SAC C | | |
| | | SAC D | | |
| | | SAC G | | |
| | | Conducted A | | |
| | | Conducted B | | |
| | | Conducted C | | |
| | | Conducted D | | |
| | | Conducted E | | |
| Conducted F | | | | |
| Conducted G | | | | |

Note: Test site name is remarked on the equipment list in each section of this report as an indication where measurements occurred in specific test site and address.

1.7 Special Accessories

There is no special accessory used while test was conducted.

1.8 Equipment Modifications

There was no modification incorporated into the EUT.

Unless otherwise stated the results shown in this test report refer only to the sample(s) tested and such sample(s) are retained for 90 days only.
 除非另有說明，此報告結果僅對測試之樣品負責，同時此樣品僅保留90天。本報告未經本公司書面許可，不可部份複製。

This document is issued by the Company subject to its General Conditions of Service printed overleaf, available on request or accessible at <http://www.sgs.com.tw/Terms-and-Conditions> and for electronic format documents, subject to Terms and Conditions for Electronic Documents at <http://www.sgs.com.tw/Terms-and-Conditions>. Attention is drawn to the limitation of liability, indemnification and jurisdiction issues defined therein. Any holder of this document is advised that information contained hereon reflects the Company's findings at the time of its intervention only and within the limits of Client's instructions, if any. The Company's sole responsibility is to its Client and this document does not exonerate parties to a transaction from exercising all their rights and obligations under the transaction documents. This document cannot be reproduced except in full, without prior written approval of the Company. Any unauthorized alteration, forgery or falsification of the content or appearance of this document is unlawful and offenders may be prosecuted to the fullest extent of the law.

2 SYSTEM TEST CONFIGURATION

2.1 EUT Configuration

The EUT configuration for testing is installed on RF field strength measurement to meet the Commissions requirement and operating in a manner which intends to maximize its emission characteristics in a continuous normal application.

2.2 EUT Exercise

An engineering test mode (software/firmware) that applicant provided was utilized to manipulate the EUT into transmit, selection of the test channel, and modulation scheme.

2.3 Test Procedure

2.3.1 Conducted Emissions

The EUT is placed on a table which is 0.8 m above ground plane. Conducted emissions from the EUT measured in the frequency range between 0.15 MHz and 30MHz. The CISPR Quasi-Peak and Average detector mode is employed. The two LISNs provide 50uH/50 ohm of coupling impedance for the measuring instrument. Both lines of the power mains connected to the EUT were checked for maximum conducted interference.

2.3.2 Conducted Test (RF)

The active antenna port of the unlicensed wireless device is connected to the spectrum analyzer with attenuator to protect the instrumentation. If a second antenna port is available, it is tested at one operating frequency, with other port(s) appropriately terminated, to verify it has similar output characteristics as the fully tested port.

2.3.3 Radiated Emissions

The EUT is placed on a turn table. For emissions testing at or below 1 GHz, the table height shall be 0.8 m above the reference ground plane. For emission measurements above 1 GHz, the table height shall be 1.5 m. The turn table shall rotate 360 degrees to determine the position of maximum emission level. EUT is set 3m away from the receiving antenna which varied from 1m to 4m to find out the highest emission. And also, each emission was to be maximized by changing the polarization of receiving antenna both horizontal and vertical. In order to find out the max. emission, the relative positions of this transmitter (EUT) was rotated through three orthogonal axes and measurement procedures for electric field radiated emissions above 1 GHz the EUT measurement is to be made "while keeping the antenna in the 'cone of radiation' from that area and pointed at the area both in azimuth and elevation, with polarization oriented for maximum response." is still within the 3dB illumination BW of the measurement antenna.

Unless otherwise stated the results shown in this test report refer only to the sample(s) tested and such sample(s) are retained for 90 days only.
除非另有說明，此報告結果僅對測試之樣品負責，同時此樣品僅保留90天。本報告未經本公司書面許可，不可部份複製。

This document is issued by the Company subject to its General Conditions of Service printed overleaf, available on request or accessible at <http://www.sgs.com.tw/Terms-and-Conditions> and for electronic format documents, subject to Terms and Conditions for Electronic Documents at <http://www.sgs.com.tw/Terms-and-Conditions>. Attention is drawn to the limitation of liability, indemnification and jurisdiction issues defined therein. Any holder of this document is advised that information contained hereon reflects the Company's findings at the time of its intervention only and within the limits of Client's instructions, if any. The Company's sole responsibility is to its Client and this document does not exonerate parties to a transaction from exercising all their rights and obligations under the transaction documents. This document cannot be reproduced except in full, without prior written approval of the Company. Any unauthorized alteration, forgery or falsification of the content or appearance of this document is unlawful and offenders may be prosecuted to the fullest extent of the law.

2.4 Measurement Results Explanation Example

2.4.1 Radiated Emission Test Sites For Measurements From 9 kHz To 30 MHz

Radiated emission below 30MHz is measured in a 9m*6m*6m semi-anechoic chamber, the measurements correspond to those obtained at an open-field test site.

There is a comparison data of both open-field test site and semi-Anechoic chamber, and the result came out very similar.

2.4.2 For all conducted test items:

The offset level is set in the spectrum analyzer to compensate the RF cable loss and attenuation factor between EUT conducted port and spectrum analyzer. With the offset compensation, the spectrum analyzer reading level is exactly EUT RF output level.

Unless otherwise stated the results shown in this test report refer only to the sample(s) tested and such sample(s) are retained for 90 days only.
除非另有說明，此報告結果僅對測試之樣品負責，同時此樣品僅保留90天。本報告未經本公司書面許可，不可部份複製。

This document is issued by the Company subject to its General Conditions of Service printed overleaf, available on request or accessible at <http://www.sgs.com.tw/Terms-and-Conditions> and for electronic format documents, subject to Terms and Conditions for Electronic Documents at <http://www.sgs.com.tw/Terms-and-Conditions>. Attention is drawn to the limitation of liability, indemnification and jurisdiction issues defined therein. Any holder of this document is advised that information contained hereon reflects the Company's findings at the time of its intervention only and within the limits of Client's instructions, if any. The Company's sole responsibility is to its Client and this document does not exonerate parties to a transaction from exercising all their rights and obligations under the transaction documents. This document cannot be reproduced except in full, without prior written approval of the Company. Any unauthorized alteration, forgery or falsification of the content or appearance of this document is unlawful and offenders may be prosecuted to the fullest extent of the law.

2.5 Test Configuration

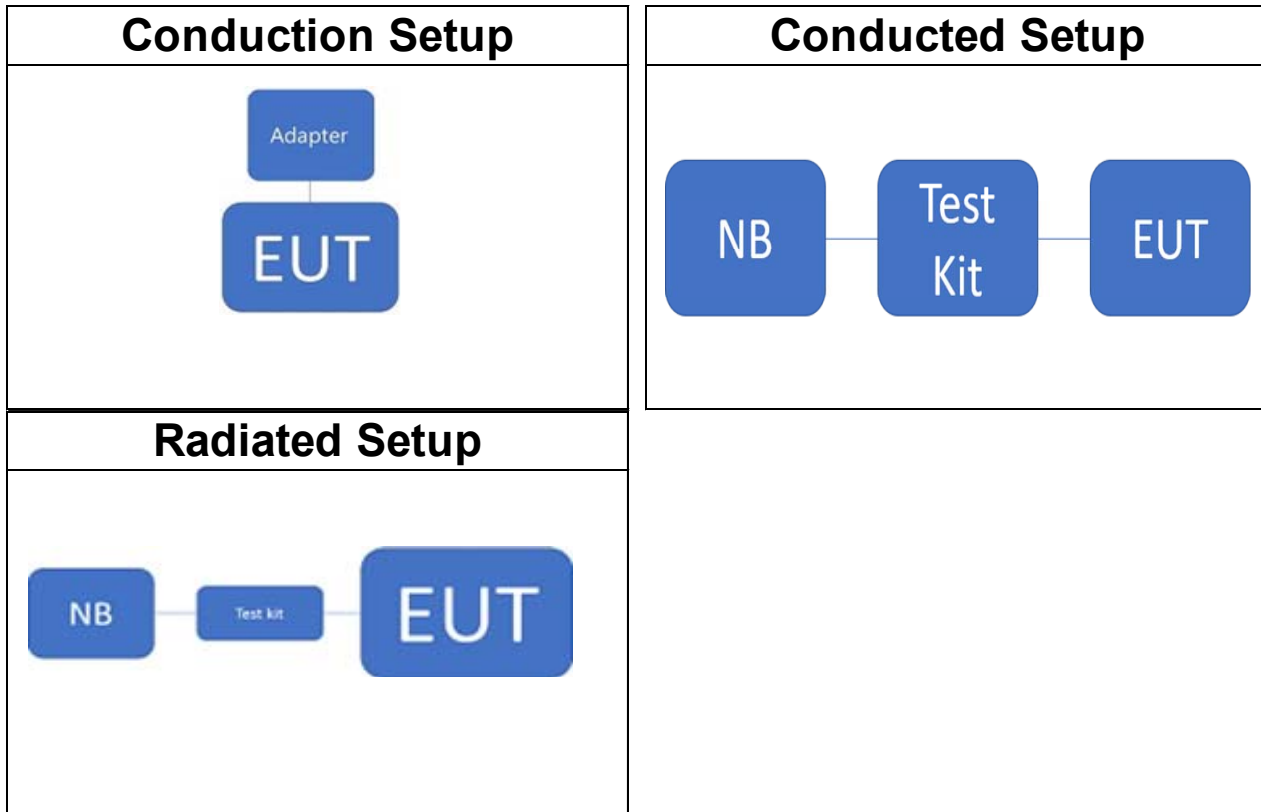

2.6 Control Unit(s)

| AC Power-Line Conducted Emission Test Site: Conduction C | | | | | |
|--|-------------------|--------------|-------------------|-----------|----------|
| EQUIPMENT TYPE | MFR | MODEL NUMBER | SERIAL NUMBER | LAST CAL. | CAL DUE. |
| USB Cable | MI | SJX10ZM | N/A | N/A | N/A |
| Adapter | Lapo | WT-02CA | 4712966931002 | N/A | N/A |
| Conducted Emission Test Site: Conducted F | | | | | |
| EQUIPMENT TYPE | MFR | MODEL NUMBER | SERIAL NUMBER | LAST CAL. | CAL DUE. |
| CP2104 USB TO TTL | YouXin Electronic | CNT-0038 | TE_SP_20230201117 | N/A | N/A |
| Notebook | Lenovo | L480 | P0002332 | N/A | N/A |
| Radiated Emission Test Site: SAC D | | | | | |
| EQUIPMENT TYPE | MFR | MODEL NUMBER | SERIAL NUMBER | LAST CAL. | CAL DUE. |
| CP2104 USB TO TTL | YouXin Electronic | CNT-0038 | TE_SP_20230201117 | N.C.R | N.C.R |
| Notebook | Lenovo | L480 | P0002332 | N.C.R | N.C.R |

Unless otherwise stated the results shown in this test report refer only to the sample(s) tested and such sample(s) are retained for 90 days only.

除非另有說明，此報告結果僅對測試之樣品負責，同時此樣品僅保留90天。本報告未經本公司書面許可，不可部份複製。

This document is issued by the Company subject to its General Conditions of Service printed overleaf, available on request or accessible at <http://www.sgs.com.tw/Terms-and-Conditions> and for electronic format documents, subject to Terms and Conditions for Electronic Documents at <http://www.sgs.com.tw/Terms-and-Conditions>. Attention is drawn to the limitation of liability, indemnification and jurisdiction issues defined therein. Any holder of this document is advised that information contained hereon reflects the Company's findings at the time of its intervention only and within the limits of Client's instructions, if any. The Company's sole responsibility is to its Client and this document does not exonerate parties to a transaction from exercising all their rights and obligations under the transaction documents. This document cannot be reproduced except in full, without prior written approval of the Company. Any unauthorized alteration, forgery or falsification of the content or appearance of this document is unlawful and offenders may be prosecuted to the fullest extent of the law.

3 SUMMARY OF TEST RESULTS

| FCC Rules | Description Of Test | Result |
|----------------------------------|--|-----------|
| §15.207(a) | AC Power Line Conducted Emission | Compliant |
| §15.247(b)(1) | Peak Output Power | Compliant |
| §15.247(a)(1) | Emission Bandwidth | Compliant |
| §15.205 §15.209 §15.247(d) | Conducted & Radiated Band Edge and Spurious Emission | Compliant |
| §15.247(a)(1) | Frequency Separation | Compliant |
| §15.247(a)(1)(iii) | Number of hopping frequency Time of Occupancy | Compliant |
| §15.203 | Antenna Requirement | Compliant |

Unless otherwise stated the results shown in this test report refer only to the sample(s) tested and such sample(s) are retained for 90 days only.

除非另有說明，此報告結果僅對測試之樣品負責，同時此樣品僅保留90天。本報告未經本公司書面許可，不可部份複製。

This document is issued by the Company subject to its General Conditions of Service printed overleaf, available on request or accessible at <http://www.sgs.com.tw/Terms-and-Conditions> and for electronic format documents, subject to Terms and Conditions for Electronic Documents at <http://www.sgs.com.tw/Terms-and-Conditions>. Attention is drawn to the limitation of liability, indemnification and jurisdiction issues defined therein. Any holder of this document is advised that information contained hereon reflects the Company's findings at the time of its intervention only and within the limits of Client's instructions, if any. The Company's sole responsibility is to its Client and this document does not exonerate parties to a transaction from exercising all their rights and obligations under the transaction documents. This document cannot be reproduced except in full, without prior written approval of the Company. Any unauthorized alteration, forgery or falsification of the content or appearance of this document is unlawful and offenders may be prosecuted to the fullest extent of the law.

4 DESCRIPTION OF TEST MODES

4.1 Operated in 2400 ~ 2483.5MHz Band

79 channels are provided for Bluetooth

| ITEM | FREQUENCY | ITEM | FREQUENCY | ITEM | FREQUENCY | ITEM | FREQUENCY |
|------|-----------|------|-----------|------|-----------|------|-----------|
| 1 | 2402 MHz | 21 | 2422 MHz | 41 | 2442 MHz | 71 | 2462 MHz |
| 2 | 2403 MHz | 22 | 2423 MHz | 42 | 2443 MHz | 72 | 2463 MHz |
| 3 | 2404 MHz | 23 | 2424 MHz | 43 | 2444 MHz | 73 | 2464 MHz |
| 4 | 2405 MHz | 24 | 2425 MHz | 44 | 2445 MHz | 74 | 2465 MHz |
| 5 | 2406 MHz | 25 | 2426 MHz | 45 | 2446 MHz | 75 | 2466 MHz |
| 6 | 2407 MHz | 26 | 2427 MHz | 46 | 2447 MHz | 76 | 2467 MHz |
| 7 | 2408 MHz | 27 | 2428 MHz | 47 | 2448 MHz | 77 | 2468 MHz |
| 8 | 2409 MHz | 28 | 2429 MHz | 48 | 2449 MHz | 78 | 2469 MHz |
| 9 | 2410 MHz | 29 | 2430 MHz | 49 | 2450 MHz | 79 | 2470 MHz |
| 10 | 2411 MHz | 30 | 2431 MHz | 50 | 2451 MHz | 70 | 2471 MHz |
| 11 | 2412 MHz | 31 | 2432 MHz | 51 | 2452 MHz | 71 | 2472 MHz |
| 12 | 2413 MHz | 32 | 2433 MHz | 52 | 2453 MHz | 72 | 2473 MHz |
| 13 | 2414 MHz | 33 | 2434 MHz | 53 | 2454 MHz | 73 | 2474 MHz |
| 14 | 2415 MHz | 34 | 2435 MHz | 54 | 2455 MHz | 74 | 2475 MHz |
| 15 | 2416 MHz | 35 | 2436 MHz | 55 | 2456 MHz | 75 | 2476 MHz |
| 16 | 2417 MHz | 36 | 2437 MHz | 56 | 2457 MHz | 76 | 2477 MHz |
| 17 | 2418 MHz | 37 | 2438 MHz | 57 | 2458 MHz | 77 | 2478 MHz |
| 18 | 2419 MHz | 38 | 2439 MHz | 58 | 2459 MHz | 78 | 2479 MHz |
| 19 | 2420 MHz | 39 | 2440 MHz | 59 | 2460 MHz | 79 | 2480 MHz |
| 20 | 2421 MHz | 40 | 2441 MHz | 60 | 2461 MHz | | |

Unless otherwise stated the results shown in this test report refer only to the sample(s) tested and such sample(s) are retained for 90 days only.

除非另有說明，此報告結果僅對測試之樣品負責，同時此樣品僅保留90天。本報告未經本公司書面許可，不可部份複製。

This document is issued by the Company subject to its General Conditions of Service printed overleaf, available on request or accessible at <http://www.sgs.com.tw/Terms-and-Conditions> and for electronic format documents, subject to Terms and Conditions for Electronic Documents at <http://www.sgs.com.tw/Terms-and-Conditions>. Attention is drawn to the limitation of liability, indemnification and jurisdiction issues defined therein. Any holder of this document is advised that information contained hereon reflects the Company's findings at the time of its intervention only and within the limits of Client's instructions, if any. The Company's sole responsibility is to its Client and this document does not exonerate parties to a transaction from exercising all their rights and obligations under the transaction documents. This document cannot be reproduced except in full, without prior written approval of the Company. Any unauthorized alteration, forgery or falsification of the content or appearance of this document is unlawful and offenders may be prosecuted to the fullest extent of the law.

4.2 The Worst Test Modes and Channel Details

- 1 The EUT has been tested under operating condition.
- 2 Test program used to control the EUT for staying in continuous transmitting and receiving mode is programmed.
- 3 The field strength of radiated emission was measured as the EUT positioned in different orthogonal planes (E1/E2/H) based on actual usage of the EUT to pre-scan the emissions for determining the worst case scenario.
- 4 Investigation has been done on all the possible configurations for searching the worst case.

| ANTNNA PORT CONDUCTED TEST | | | | |
|---|-------------------|-------------------------|----------------------------------|---------------------|
| MODE | AVAILABLE CHANNEL | TESTED CHANNEL | MODULATION | PACKET TYPE |
| Peak Output Power, 20dB Band Width | | | | |
| Bluetooth | 0 to 78 | 0,39,78 | GFSK | DH5 |
| | 0 to 78 | 0,39,78 | $\pi/4$ -DQPSK | 2DH5 |
| | 0 to 78 | 0,39,78 | 8-DPSK | 3DH5 |
| Band Edge | | | | |
| Bluetooth | 0 to 78 | 0,78 | GFSK/ $\pi/4$ -DQPSK | DH5/2DH5 |
| Frequency Separation | | | | |
| Bluetooth | 0 to 78 | 0,1,2,38,39,40,76,77,78 | GFSK $\pi/4$ -DQPSK 8-DPSK | DH5 2DH5 3DH5 |
| Number of Hopping Frequency, Hopping Band edge | | | | |
| Bluetooth | 0 to 78 | 0 to 78 | GFSK/ $\pi/4$ -DQPSK | DH5/2DH5 |
| Time of Occupancy(Dwell time) | | | | |
| Bluetooth | 0 to 78 | 39 | GFSK | DH1/DH3/DH5 |
| | | | $\pi/4$ -DQPSK | 2DH1/2DH3/2DH5 |
| | | | 8-DPSK | 3DH1/3DH3/3DH5 |

| MODE | AVAILABLE CHANNEL | TESTED CHANNEL | MODULATION | PACKET TYPE |
|---|-------------------|----------------|----------------------|-------------|
| RADIATED EMISSION TEST (BELOW 1 GHz) | | | | |
| Bluetooth | 0 to 78 | 39 | GFSK/ $\pi/4$ -DQPSK | DH5/2DH5 |
| RADIATED EMISSION TEST (ABOVE 1 GHz) | | | | |
| Bluetooth | 0 to 78 | 0,39,78 | GFSK/ $\pi/4$ -DQPSK | DH5/2DH5 |

Note: The field strength of radiation emission was measured as EUT stand-up position (H mode) and lie down position (E1, E2 mode) for channel Low, Mid and High, the worst case position was reported.

Unless otherwise stated the results shown in this test report refer only to the sample(s) tested and such sample(s) are retained for 90 days only.

除非另有說明，此報告結果僅對測試之樣品負責，同時此樣品僅保留90天。本報告未經本公司書面許可，不可部份複製。

This document is issued by the Company subject to its General Conditions of Service printed overleaf, available on request or accessible at <http://www.sgs.com.tw/Terms-and-Conditions>, and for electronic format documents, subject to Terms and Conditions for Electronic Documents at <http://www.sgs.com.tw/Terms-and-Conditions>. Attention is drawn to the limitation of liability, indemnification and jurisdiction issues defined therein. Any holder of this document is advised that information contained hereon reflects the Company's findings at the time of its intervention only and within the limits of Client's instructions, if any. The Company's sole responsibility is to its Client and this document does not exonerate parties to a transaction from exercising all their rights and obligations under the transaction documents. This document cannot be reproduced except in full, without prior written approval of the Company. Any unauthorized alteration, forgery or falsification of the content or appearance of this document is unlawful and offenders may be prosecuted to the fullest extent of the law.

5 MEASUREMENT UNCERTAINTY

| Test Items | Uncertainty |
|--|-------------|
| AC Power Line Conducted Emission | +/- 2.32 dB |
| Output Power measurement | +/- 1 dB |
| Emission Bandwidth | +/- 1.53 Hz |
| Undesignable radiated emission measurement | +/- 1.68 dB |
| Frequency Separation | +/- 1.53 Hz |
| Number of hopping frequency | +/- 1.53 Hz |
| Time of Occupancy | +/- 1.53 Hz |
| Temperature | +/- 0.7 °C |
| Humidity | +/- 3 % |
| DC / AC Power Source | +/- 1 % |

| Radiated Spurious Emission Measurement Uncertainty | | |
|--|-------------|-----------------|
| Polarization: Vertical | +/- 2.8 dB | 9kHz~30MHz |
| | +/- 4.82 dB | 30MHz - 1000MHz |
| | +/- 4.37 dB | 1GHz - 18GHz |
| | +/- 4.21 dB | 18GHz - 40GHz |
| Polarization: Horizontal | +/- 2.8 dB | 9kHz~30MHz |
| | +/- 4.54 dB | 30MHz - 1000MHz |
| | +/- 4.37 dB | 1GHz - 18GHz |
| | +/- 4.21 dB | 18GHz - 40GHz |

Note:

1. This uncertainty represents an expanded uncertainty expressed at approximately the 95% confidence level using a coverage factor of k=2.
2. The conformity assessment statement in this report is based solely on the test results, measurement uncertainty is excluded.

Unless otherwise stated the results shown in this test report refer only to the sample(s) tested and such sample(s) are retained for 90 days only.
 除非另有說明，此報告結果僅對測試之樣品負責，同時此樣品僅保留90天。本報告未經本公司書面許可，不可部份複製。

This document is issued by the Company subject to its General Conditions of Service printed overleaf, available on request or accessible at <http://www.sgs.com.tw/Terms-and-Conditions> and for electronic format documents, subject to Terms and Conditions for Electronic Documents at <http://www.sgs.com.tw/Terms-and-Conditions>. Attention is drawn to the limitation of liability, indemnification and jurisdiction issues defined therein. Any holder of this document is advised that information contained hereon reflects the Company's findings at the time of its intervention only and within the limits of Client's instructions, if any. The Company's sole responsibility is to its Client and this document does not exonerate parties to a transaction from exercising all their rights and obligations under the transaction documents. This document cannot be reproduced except in full, without prior written approval of the Company. Any unauthorized alteration, forgery or falsification of the content or appearance of this document is unlawful and offenders may be prosecuted to the fullest extent of the law.

6 MEASUREMENT EQUIPMENT USED

6.1 Emission from AC power line

| AC Power-Line Conducted Emission Test Site: Conduction C | | | | | |
|--|--------------------------------|----------------------|---------------------------|------------|------------|
| EQUIPMENT TYPE | MFR | MODEL NUMBER | SERIAL NUMBER | LAST CAL. | CAL DUE. |
| LISN | SCHWARZBECK Mess-Elektronik | NSLK8127 | 973 | 04/13/2022 | 04/12/2023 |
| EMI Test Receiver | R&S | ESCI | 101342 | 04/25/2022 | 04/24/2023 |
| Coaxial Cable | EC Lab | RF-HY-CAB-250 | RF-HY-CAB-250-01 | 03/27/2022 | 03/26/2023 |
| Coaxial Cable | EMC Instruments Corp | EMC5D-BM-BM- 3000 | 1401004 | 03/27/2022 | 03/26/2023 |
| Test Software | audix | e3 | E3 20923 SGS Ver.9 (C) | N.C.R | N.C.R |

6.2 Conducted Measurement

| Conducted Emission Test Site: Conducted F | | | | | |
|---|------------|------------------------|---------------|------------|------------|
| EQUIPMENT TYPE | MFR | MODEL NUMBER | SERIAL NUMBER | LAST CAL. | CAL DUE. |
| Spectrum Analyzer | KEYSIGHT | N9010B | MY59071574 | 06/20/2022 | 06/19/2023 |
| DC Block | PASTERNAK | PE8210 | RF153 | 11/16/2022 | 11/15/2023 |
| Power Meter | Anritsu | ML2496A | 1512003 | 07/26/2022 | 07/25/2023 |
| Power Sensor | Anritsu | MA2411B | 1339378 | 07/26/2022 | 07/25/2023 |
| Test Software | SGS Taiwan | Radio Test Software | Ver.21 | N.C.R | N.C.R |
| Attenuator | Woken | WATT-218FS-10 | RF18 | 11/16/2022 | 11/15/2023 |
| Attenuator | Woken | WATT-218FS-10 | RF20 | 11/16/2022 | 11/15/2023 |

6.3 Radiated Measurement

| Radiated Emission Test Site: SAC D | | | | | |
|------------------------------------|-----------------|-----------------------|---------------------------|------------|------------|
| EQUIPMENT TYPE | MFR | MODEL NUMBER | SERIAL NUMBER | LAST CAL. | CAL DUE. |
| Broadband Antenna | SCHWARZBECK | VULB 9168 | 9168-617 | 12/19/2022 | 12/18/2023 |
| Horn Antenna | Schwarzbeck | BBHA9170 | 184 | 12/30/2022 | 12/29/2023 |
| Horn Antenna | Schwarzbeck | BBHA9170 | 185 | 08/22/2022 | 08/21/2023 |
| Horn Antenna | Schwarzbeck | BBHA9120D | 1341 | 05/31/2022 | 05/30/2023 |
| Loop Antenna | ETS.LINDGREN | 6502 | 143303 | 05/14/2022 | 05/13/2023 |
| 3m Site NSA | SGS | 966 chamber D | N/A | 04/30/2022 | 04/29/2023 |
| Test Software | audix | e3 | E3 20923 SGS Ver.9 (C) | N.C.R | N.C.R |
| Pre-Amplifier | EMC Instruments | EMC18405SEE | 980881 | 10/25/2022 | 10/24/2023 |
| Pre-Amplifier | EMC Instruments | EMC9135 | 980234 | 11/16/2022 | 11/15/2023 |
| Pre-Amplifier | EMC Instruments | EMC12630SE | 980273 | 11/16/2022 | 11/15/2023 |
| Coaxial Cable | Huber+Suhner | RG 214/U | W21.01 | 11/16/2022 | 11/15/2023 |
| Coaxial Cable | Huber Suhner | EMC106-SM-SM- 7200 | 150703 | 11/16/2022 | 11/15/2023 |
| Coaxial Cable | Huber Suhner | SUCOFLEX 104 | MY17413/4 | 11/16/2022 | 11/15/2023 |

NOTE: N.C.R refers to Not Calibrated Required.

Unless otherwise stated the results shown in this test report refer only to the sample(s) tested and such sample(s) are retained for 90 days only.
除非另有說明，此報告結果僅對測試之樣品負責，同時此樣品僅保留90天。本報告未經本公司書面許可，不可部份複製。

This document is issued by the Company subject to its General Conditions of Service printed overleaf, available on request or accessible at <http://www.sgs.com.tw/Terms-and-Conditions> and for electronic format documents, subject to Terms and Conditions for Electronic Documents at <http://www.sgs.com.tw/Terms-and-Conditions>. Attention is drawn to the limitation of liability, indemnification and jurisdiction issues defined therein. Any holder of this document is advised that information contained herein reflects the Company's findings at the time of its intervention only and within the limits of Client's instructions, if any. The Company's sole responsibility is to its Client and this document does not exonerate parties to a transaction from exercising all their rights and obligations under the transaction documents. This document cannot be reproduced except in full, without prior written approval of the Company. Any unauthorized alteration, forgery or falsification of the content or appearance of this document is unlawful and offenders may be prosecuted to the fullest extent of the law.

7 CONDUCTED EMISSION TEST

7.1 Standard Applicable

Frequency within 150 kHz to 30MHz shall not exceed the limit table as below.

| Frequency range MHz | Limits dB(uV) | |
|------------------------|------------------|----------|
| | Quasi-peak | Average |
| 0.15 to 0.50 | 66 to 56 | 56 to 46 |
| 0.50 to 5 | 56 | 46 |
| 5 to 30 | 60 | 50 |

Note

- 1.The lower limit shall apply at the transition frequencies
- 2.The limit decreases linearly with the logarithm of the frequency in the range 0.15 MHz to 0.50 MHz.

7.2 EUT Setup

1. The conducted emission tests were performed in the test site, using the setup in accordance with the ANSI 63.10:2013.
2. The AC/DC Power adaptor of EUT was plug-in LISN. The EUT was placed flushed with the rear of the table.
3. The LISN was connected with 120Vac/60Hz power source.

7.3 Test Setup

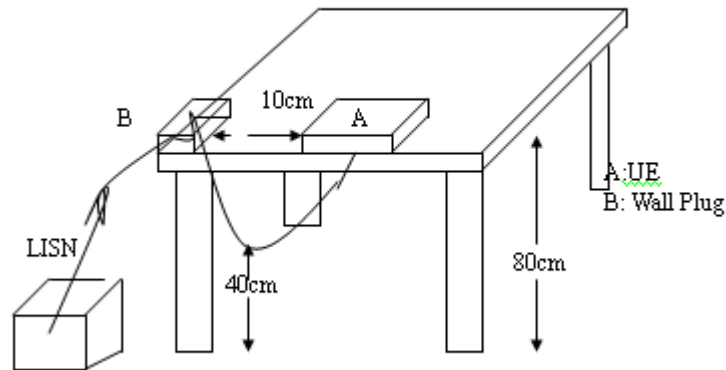

7.4 Measurement Procedure

1. The EUT was placed on a table which is 0.8m above ground plane.
2. Maximum procedure was performed on the six highest emissions to ensure EUT compliance.
3. Repeat above procedures until all frequency measured were complete.

Unless otherwise stated the results shown in this test report refer only to the sample(s) tested and such sample(s) are retained for 90 days only.

除非另有說明，此報告結果僅對測試之樣品負責，同時此樣品僅保留90天。本報告未經本公司書面許可，不可部份複製。
This document is issued by the Company subject to its General Conditions of Service printed overleaf, available on request or accessible at <http://www.sgs.com.tw/Terms-and-Conditions> and for electronic format documents, subject to Terms and Conditions for Electronic Documents at <http://www.sgs.com.tw/Terms-and-Conditions>. Attention is drawn to the limitation of liability, indemnification and jurisdiction issues defined therein. Any holder of this document is advised that information contained hereon reflects the Company's findings at the time of its intervention only and within the limits of Client's instructions, if any. The Company's sole responsibility is to its Client and this document does not exonerate parties to a transaction from exercising all their rights and obligations under the transaction documents. This document cannot be reproduced except in full, without prior written approval of the Company. Any unauthorized alteration, forgery or falsification of the content or appearance of this document is unlawful and offenders may be prosecuted to the fullest extent of the law.

7.5 Measurement Result

Note: Refer to next page for measurement data and plots.

Note2: The * reveals the worst-case results that closest to the limit.

Unless otherwise stated the results shown in this test report refer only to the sample(s) tested and such sample(s) are retained for 90 days only.
除非另有說明，此報告結果僅對測試之樣品負責，同時此樣品僅保留90天。本報告未經本公司書面許可，不可部份複製。

This document is issued by the Company subject to its General Conditions of Service printed overleaf, available on request or accessible at <http://www.sgs.com.tw/Terms-and-Conditions> and for electronic format documents, subject to Terms and Conditions for Electronic Documents at <http://www.sgs.com.tw/Terms-and-Conditions>. Attention is drawn to the limitation of liability, indemnification and jurisdiction issues defined therein. Any holder of this document is advised that information contained hereon reflects the Company's findings at the time of its intervention only and within the limits of Client's instructions, if any. The Company's sole responsibility is to its Client and this document does not exonerate parties to a transaction from exercising all their rights and obligations under the transaction documents. This document cannot be reproduced except in full, without prior written approval of the Company. Any unauthorized alteration, forgery or falsification of the content or appearance of this document is unlawful and offenders may be prosecuted to the fullest extent of the law.

SGS Taiwan Ltd.

No.134,Wu Kung Road, New Taipei Industrial Park, Wuku District, New Taipei City, Taiwan/新北市五股區新北產業園區五工路 134 號

台灣檢驗科技股份有限公司

t (886-2) 2299-3279

f (886-2) 2298-0488

www.sgs.com.tw

Member of SGS Group

AC POWER LINE CONDUCTED EMISSION TEST DATA

| | | | |
|---------------|-------------------|-------------|---------------|
| Report Number | :TERF2303000419E2 | Test Site | :Conduction C |
| Test Mode | :BT | Test Date | :2023-03-15 |
| Power | :120V/60Hz | Temp./Humi. | :22.5/52 |
| Probe | :L1 | Engineer | :Howard Huang |

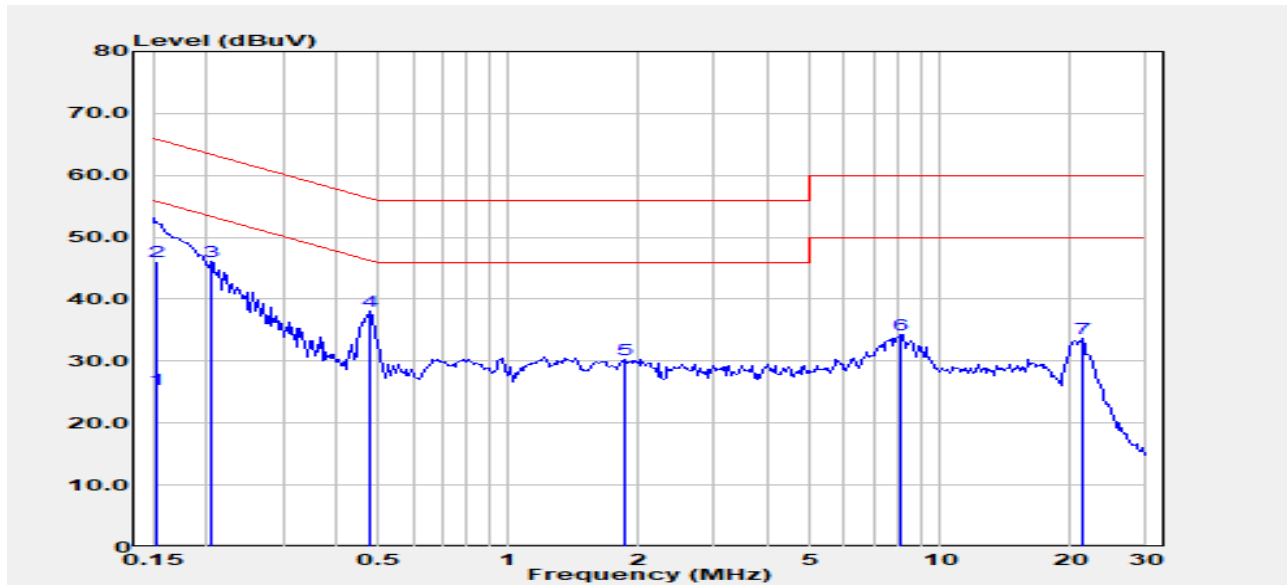

| Freq. MHz | Detector Mode | Spectrum Reading Level dBμV | Factor dB | Actual FS dBμV | Limit dBμV | Margin dB |
|--------------|------------------|-----------------------------------|--------------|----------------------|---------------|--------------|
| 0.153 | Average | 15.10 | 10.27 | 25.37 | 55.82 | -30.45 |
| 0.153 | QP | 35.80 | 10.27 | 46.07 | 65.82 | -19.75 |
| 0.204 | Peak | 35.78 | 10.27 | 46.05 | 63.45 | -17.40 |
| 0.476 | Peak | 27.74 | 10.31 | 38.06 | 56.41 | -18.35 |
| 1.848 | Peak | 19.24 | 11.09 | 30.33 | 56.00 | -25.67 |
| 8.148 | Peak | 23.73 | 10.63 | 34.35 | 60.00 | -25.65 |
| 21.373 | Peak | 22.76 | 10.91 | 33.67 | 60.00 | -26.33 |

Unless otherwise stated the results shown in this test report refer only to the sample(s) tested and such sample(s) are retained for 90 days only.

除非另有說明，此報告結果僅對測試之樣品負責，同時此樣品僅保留90天。本報告未經本公司書面許可，不可部份複製。

This document is issued by the Company subject to its General Conditions of Service printed overleaf, available on request or accessible at <http://www.sgs.com.tw/Terms-and-Conditions> and for electronic format documents, subject to Terms and Conditions for Electronic Documents at <http://www.sgs.com.tw/Terms-and-Conditions>. Attention is drawn to the limitation of liability, indemnification and jurisdiction issues defined therein. Any holder of this document is advised that information contained hereon reflects the Company's findings at the time of its intervention only and within the limits of Client's instructions, if any. The Company's sole responsibility is to its Client and this document does not exonerate parties to a transaction from exercising all their rights and obligations under the transaction documents. This document cannot be reproduced except in full, without prior written approval of the Company. Any unauthorized alteration, forgery or falsification of the content or appearance of this document is unlawful and offenders may be prosecuted to the fullest extent of the law.

Report Number :TERF2303000419E2
 Test Mode :BT
 Power :120V/60Hz
 Probe :N

Test Site :Conduction C
 Test Date :2023-03-15
 Temp./Humi. :22.5/52
 Engineer :Howard Huang

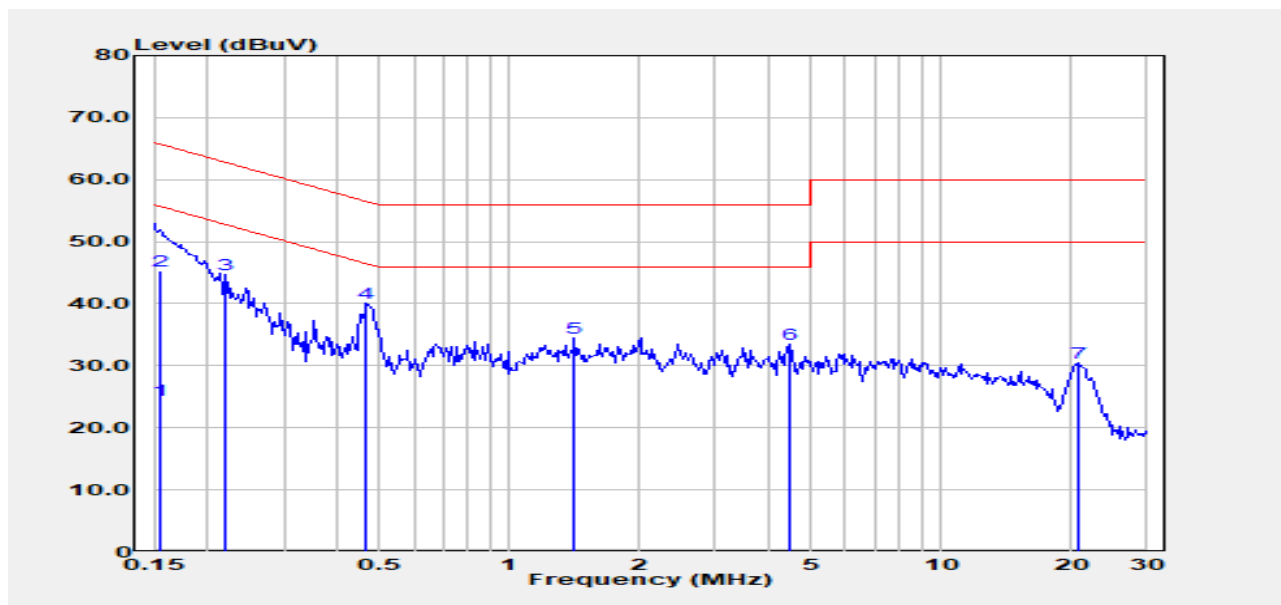

| Freq. MHz | Detector Mode PK/QP/AV | Spectrum Reading Level dB μ V | Factor dB | Actual FS dB μ V | Limit dB μ V | Margin dB |
|--------------|------------------------------|---|--------------|----------------------------|---------------------|--------------|
| 0.155 | Average | 14.10 | 10.28 | 24.38 | 55.74 | -31.36 |
| 0.155 | QP | 35.10 | 10.28 | 45.38 | 65.74 | -20.36 |
| 0.220 | Peak | 34.46 | 10.27 | 44.74 | 62.83 | -18.09 |
| 0.466 | Peak | 29.72 | 10.30 | 40.02 | 56.58 | -16.57 |
| 1.418 | Peak | 23.80 | 10.74 | 34.54 | 56.00 | -21.46 |
| 4.454 | Peak | 22.87 | 10.57 | 33.44 | 56.00 | -22.56 |
| 20.704 | Peak | 19.69 | 10.86 | 30.55 | 60.00 | -29.45 |

Unless otherwise stated the results shown in this test report refer only to the sample(s) tested and such sample(s) are retained for 90 days only.

除非另有說明，此報告結果僅對測試之樣品負責，同時此樣品僅保留90天。本報告未經本公司書面許可，不可部份複製。
 This document is issued by the Company subject to its General Conditions of Service printed overleaf, available on request or accessible at <http://www.sgs.com.tw/Terms-and-Conditions> and for electronic format documents, subject to Terms and Conditions for Electronic Documents at <http://www.sgs.com.tw/Terms-and-Conditions>. Attention is drawn to the limitation of liability, indemnification and jurisdiction issues defined therein. Any holder of this document is advised that information contained hereon reflects the Company's findings at the time of its intervention only and within the limits of Client's instructions, if any. The Company's sole responsibility is to its Client and this document does not exonerate parties to a transaction from exercising all their rights and obligations under the transaction documents. This document cannot be reproduced except in full, without prior written approval of the Company. Any unauthorized alteration, forgery or falsification of the content or appearance of this document is unlawful and offenders may be prosecuted to the fullest extent of the law.

8 PEAK OUTPUT POWER MEASUREMENT

8.1 Standard Applicable

For frequency hopping systems operating in the 2400-2483.5 MHz band employing at least 75 hopping channels, The Limit: 1Watt. For all other frequency hopping systems in the 2400 – 2483.5MHz band: The Limit: 0.125 Watts. The power limit for 1Mbps is 1watt, and 2Mbps, 3Mbps and AFH mode are 0.125 watts.

8.2 Test Setup

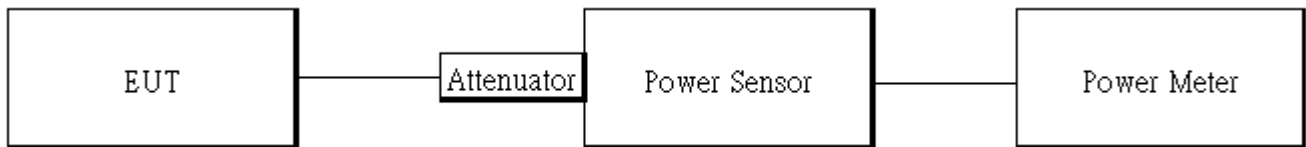

8.3 Measurement Procedure:

1. Place the EUT on the table and set it in transmitting mode.
2. The testing follows ANSI C63.10 Measurement Guidelines.
3. Remove the antenna from the EUT and then connect a low loss RF cable from the antenna port to the power meter or spectrum. (Max Hold, Detector = Peak, RBW >=20dB bandwidth)
4. Record the max. reading.
5. Repeat above procedures until all default test channel is completed.

Unless otherwise stated the results shown in this test report refer only to the sample(s) tested and such sample(s) are retained for 90 days only.
 除非另有說明，此報告結果僅對測試之樣品負責，同時此樣品僅保留90天。本報告未經本公司書面許可，不可部份複製。

This document is issued by the Company subject to its General Conditions of Service printed overleaf, available on request or accessible at <http://www.sgs.com.tw/Terms-and-Conditions> and for electronic format documents, subject to Terms and Conditions for Electronic Documents at <http://www.sgs.com.tw/Terms-and-Conditions>. Attention is drawn to the limitation of liability, indemnification and jurisdiction issues defined therein. Any holder of this document is advised that information contained hereon reflects the Company's findings at the time of its intervention only and within the limits of Client's instructions, if any. The Company's sole responsibility is to its Client and this document does not exonerate parties to a transaction from exercising all their rights and obligations under the transaction documents. This document cannot be reproduced except in full, without prior written approval of the Company. Any unauthorized alteration, forgery or falsification of the content or appearance of this document is unlawful and offenders may be prosecuted to the fullest extent of the law.

8.4 Peak & Average Power Measurement Result

1M BR mode (Peak):

| CH | Freq. (MHz) | Power set | Peak Output Power (dBm) | Output Power (mW) | Limit (mW) |
|------|-------------|-----------|-------------------------|-------------------|------------|
| Low | 2402 | default | 8.92 | 7.798 | 1000 |
| Mid | 2441 | default | 9.12 | 8.166 | 1000 |
| High | 2480 | default | 8.95 | 7.852 | 1000 |

1M BR mode (Average):

| CH | Freq. (MHz) | Power set | Max. Avg. Output include tune up tolerance Power (dBm) | Output Power (mW) | Limit (mW) |
|------|-------------|-----------|--|-------------------|------------|
| Low | 2402 | default | 8.74 | 7.487 | 1000 |
| Mid | 2441 | default | 8.97 | 7.894 | 1000 |
| High | 2480 | default | 8.86 | 7.697 | 1000 |

2M EDR mode (Peak):

| CH | Freq. (MHz) | Power set | Peak Output Power (dBm) | Output Power (mW) | Limit (mW) |
|------|-------------|-----------|-------------------------|-------------------|------------|
| Low | 2402 | default | 10.78 | 11.967 | 125 |
| Mid | 2441 | default | 10.83 | 12.106 | 125 |
| High | 2480 | default | 10.81 | 12.050 | 125 |

2M EDR mode (Average):

| CH | Freq. (MHz) | Power set | Max. Avg. Output include tune up tolerance Power (dBm) | Output Power (mW) | Limit (mW) |
|------|-------------|-----------|--|-------------------|------------|
| Low | 2402 | default | 8.73 | 7.470 | 125 |
| Mid | 2441 | default | 8.79 | 7.574 | 125 |
| High | 2480 | default | 8.77 | 7.539 | 125 |

3M EDR mode (Peak):

| CH | Freq. (MHz) | Power set | Peak Output Power (dBm) | Output Power (mW) | Limit (mW) |
|------|-------------|-----------|-------------------------|-------------------|------------|
| Low | 2402 | default | 10.76 | 11.912 | 125 |
| Mid | 2441 | default | 10.80 | 12.023 | 125 |
| High | 2480 | default | 10.77 | 11.940 | 125 |

3M EDR mode (Average):

| CH | Freq. (MHz) | Power set | Max. Avg. Output include tune up tolerance Power (dBm) | Output Power (mW) | Limit (mW) |
|------|-------------|-----------|--|-------------------|------------|
| Low | 2402 | default | 8.68 | 7.384 | 125 |
| Mid | 2441 | default | 8.75 | 7.504 | 125 |
| High | 2480 | default | 8.71 | 7.435 | 125 |

*Note: Max. Output include tune up tolerance Power measured by using average detector.

Unless otherwise stated the results shown in this test report refer only to the sample(s) tested and such sample(s) are retained for 90 days only.

除非另有說明，此報告結果僅對測試之樣品負責，同時此樣品僅保留90天。本報告未經本公司書面許可，不可部份複製。

This document is issued by the Company subject to its General Conditions of Service printed overleaf, available on request or accessible at <http://www.sgs.com.tw/Terms-and-Conditions> and for electronic format documents, subject to Terms and Conditions for Electronic Documents at <http://www.sgs.com.tw/Terms-and-Conditions>. Attention is drawn to the limitation of liability, indemnification and jurisdiction issues defined therein. Any holder of this document is advised that information contained hereon reflects the Company's findings at the time of its intervention only and within the limits of Client's instructions, if any. The Company's sole responsibility is to its Client and this document does not exonerate parties to a transaction from exercising all their rights and obligations under the transaction documents. This document cannot be reproduced except in full, without prior written approval of the Company. Any unauthorized alteration, forgery or falsification of the content or appearance of this document is unlawful and offenders may be prosecuted to the fullest extent of the law.

9 EMISSION BANDWIDTH MEASUREMENT

9.1 Standard Applicable

For frequency hopping systems operating in the 2400 MHz-2483.5 MHz no limit for 20dB bandwidth.

9.2 Test Setup

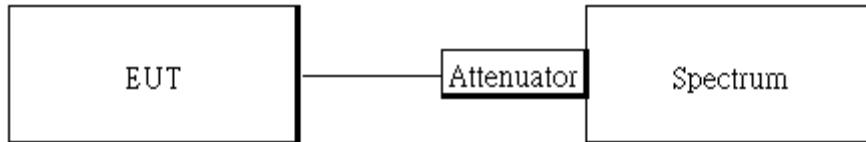

9.3 Measurement Procedure

1. Place the EUT on the table and set it in transmitting mode.
2. The testing follows ANSI C63.10:2013.
3. Remove the antenna from the EUT and then connect a low loss RF cable from the antenna port to the spectrum analyzer.
4. Set the spectrum analyzer as
RBW= 1 % to 5% of OBW ,
VBW = 3 X RBW,
Span= 2 to 5 times of the OBW,
Sweep=auto,
Detector = Peak, and Max hold for 20dB Bandwidth test.
5. Mark the peak frequency and -20dB (upper and lower) frequency
6. Repeat above procedures until all test default channel is completed

Unless otherwise stated the results shown in this test report refer only to the sample(s) tested and such sample(s) are retained for 90 days only.
除非另有說明，此報告結果僅對測試之樣品負責，同時此樣品僅保留90天。本報告未經本公司書面許可，不可部份複製。

This document is issued by the Company subject to its General Conditions of Service printed overleaf, available on request or accessible at <http://www.sgs.com.tw/Terms-and-Conditions> and for electronic format documents, subject to Terms and Conditions for Electronic Documents at <http://www.sgs.com.tw/Terms-and-Conditions>. Attention is drawn to the limitation of liability, indemnification and jurisdiction issues defined therein. Any holder of this document is advised that information contained hereon reflects the Company's findings at the time of its intervention only and within the limits of Client's instructions, if any. The Company's sole responsibility is to its Client and this document does not exonerate parties to a transaction from exercising all their rights and obligations under the transaction documents. This document cannot be reproduced except in full, without prior written approval of the Company. Any unauthorized alteration, forgery or falsification of the content or appearance of this document is unlawful and offenders may be prosecuted to the fullest extent of the law.

9.4 20dB Bandwidth

GFSK

| CH | 20 dB BW (MHz) | 2/3 BW (MHz) |
|------|----------------|--------------|
| Low | 0.9284 | 0.62 |
| Mid | 0.9297 | 0.62 |
| High | 0.9291 | 0.62 |

 $\pi/4$ -DQPSK

| CH | 20 dB BW (MHz) | 2/3 BW (MHz) |
|------|----------------|--------------|
| Low | 1.270 | 0.85 |
| Mid | 1.269 | 0.85 |
| High | 1.269 | 0.85 |

8-DPSK

| CH | 20 dB BW (MHz) | 2/3 BW (MHz) |
|------|----------------|--------------|
| Low | 1.275 | 0.85 |
| Mid | 1.275 | 0.85 |
| High | 1.274 | 0.85 |

Unless otherwise stated the results shown in this test report refer only to the sample(s) tested and such sample(s) are retained for 90 days only.
 除非另有說明，此報告結果僅對測試之樣品負責，同時此樣品僅保留90天。本報告未經本公司書面許可，不可部份複製。

This document is issued by the Company subject to its General Conditions of Service printed overleaf, available on request or accessible at <http://www.sgs.com.tw/Terms-and-Conditions> and for electronic format documents, subject to Terms and Conditions for Electronic Documents at <http://www.sgs.com.tw/Terms-and-Conditions>. Attention is drawn to the limitation of liability, indemnification and jurisdiction issues defined therein. Any holder of this document is advised that information contained hereon reflects the Company's findings at the time of its intervention only and within the limits of Client's instructions, if any. The Company's sole responsibility is to its Client and this document does not exonerate parties to a transaction from exercising all their rights and obligations under the transaction documents. This document cannot be reproduced except in full, without prior written approval of the Company. Any unauthorized alteration, forgery or falsification of the content or appearance of this document is unlawful and offenders may be prosecuted to the fullest extent of the law.

OBW 20dB_GFSK_1M_DH5_2402MHz



OBW 20dB_π/4DQPSK_2M_DH5_2402MHz

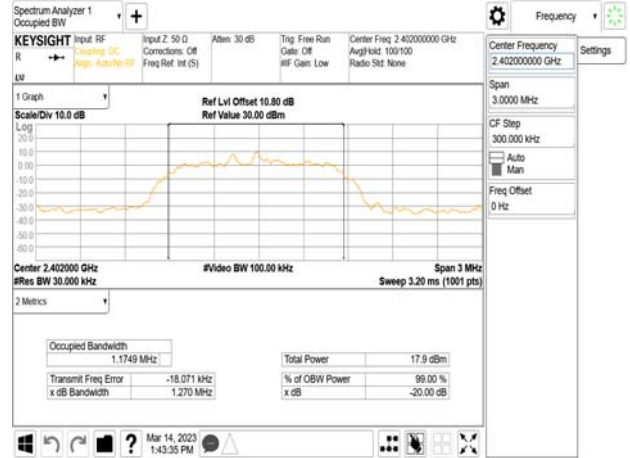

OBW 20dB_GFSK_1M_DH5_2441MHz



OBW 20dB_π/4DQPSK_2M_DH5_2441MHz

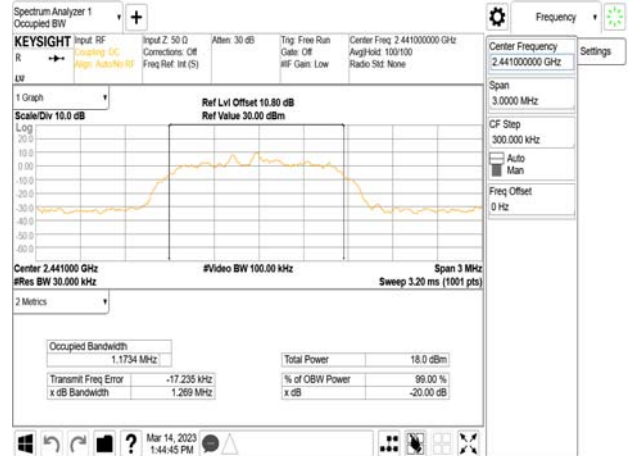

OBW 20dB_GFSK_1M_DH5_2480MHz



OBW 20dB_π/4DQPSK_2M_DH5_2480MHz

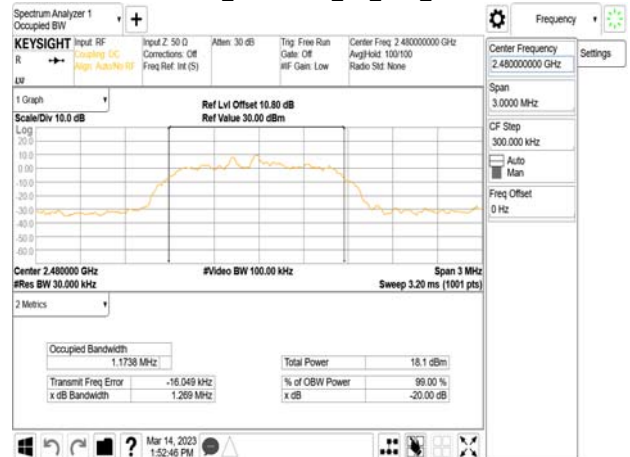

Unless otherwise stated the results shown in this test report refer only to the sample(s) tested and such sample(s) are retained for 90 days only.

除非另有說明，此報告結果僅對測試之樣品負責，同時此樣品僅保留90天。本報告未經本公司書面許可，不可部份複製。

This document is issued by the Company subject to its General Conditions of Service printed overleaf, available on request or accessible at <http://www.sgs.com.tw/Terms-and-Conditions> and for electronic format documents, subject to Terms and Conditions for Electronic Documents at <http://www.sgs.com.tw/Terms-and-Conditions>. Attention is drawn to the limitation of liability, indemnification and jurisdiction issues defined therein. Any holder of this document is advised that information contained hereon reflects the Company's findings at the time of its intervention only and within the limits of Client's instructions, if any. The Company's sole responsibility is to its Client and this document does not exonerate parties to a transaction from exercising all their rights and obligations under the transaction documents. This document cannot be reproduced except in full, without prior written approval of the Company. Any unauthorized alteration, forgery or falsification of the content or appearance of this document is unlawful and offenders may be prosecuted to the fullest extent of the law.

OBW 20dB_8DPSK_3M_DH5_2402MHz

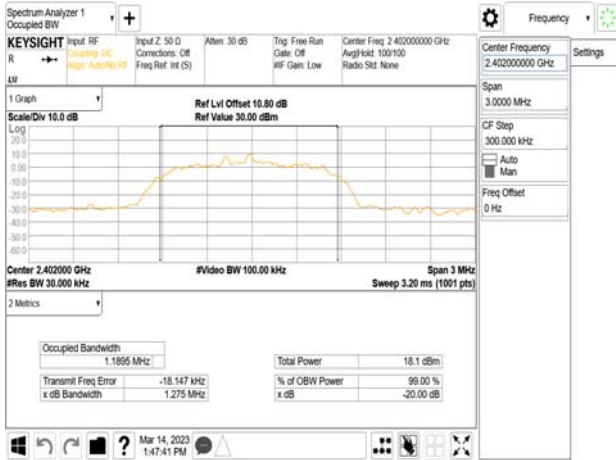

OBW 20dB_8DPSK_3M_DH5_2441MHz

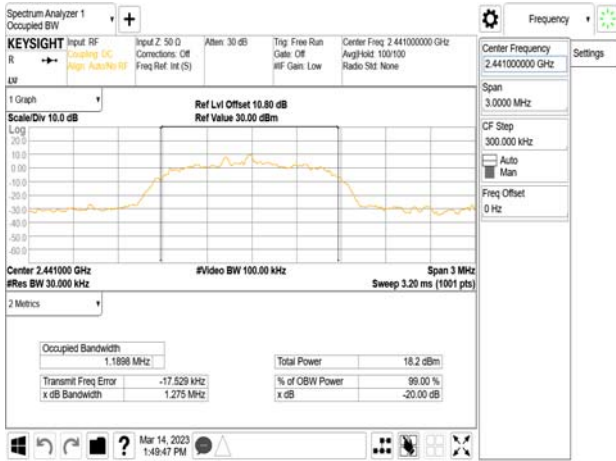

OBW 20dB_8DPSK_3M_DH5_2480MHz

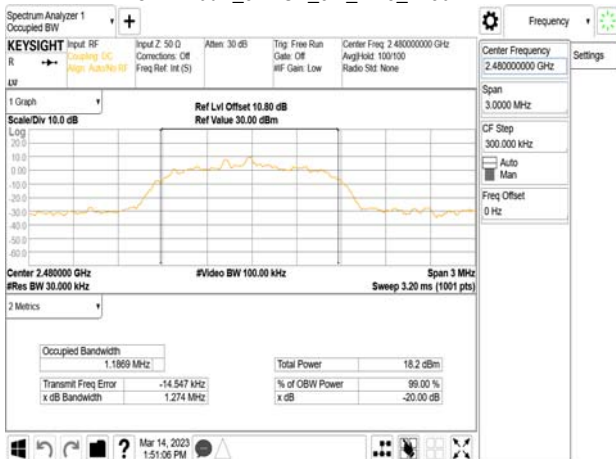

Unless otherwise stated the results shown in this test report refer only to the sample(s) tested and such sample(s) are retained for 90 days only.

除非另有說明，此報告結果僅對測試之樣品負責，同時此樣品僅保留90天。本報告未經本公司書面許可，不可部份複製。

This document is issued by the Company subject to its General Conditions of Service printed overleaf, available on request or accessible at <http://www.sgs.com.tw/Terms-and-Conditions> and for electronic format documents, subject to Terms and Conditions for Electronic Documents at <http://www.sgs.com.tw/Terms-and-Conditions>. Attention is drawn to the limitation of liability, indemnification and jurisdiction issues defined therein. Any holder of this document is advised that information contained hereon reflects the Company's findings at the time of its intervention only and within the limits of Client's instructions, if any. The Company's sole responsibility is to its Client and this document does not exonerate parties to a transaction from exercising all their rights and obligations under the transaction documents. This document cannot be reproduced except in full, without prior written approval of the Company. Any unauthorized alteration, forgery or falsification of the content or appearance of this document is unlawful and offenders may be prosecuted to the fullest extent of the law.

10 CONDUCTED BAND EDGES AND SPURIOUS EMISSION MEASUREMENT

10.1 Standard Applicable

In any 100 kHz bandwidth outside the frequency band in which the spread spectrum or digitally modulated intentional radiator is operating, the radio frequency power that is produced by the intentional radiator shall be at least 20 dB below that in the 100 kHz bandwidth within the band that contains the highest level of the desired power, based on either an RF conducted or a radiated measurement, provided the transmitter demonstrates compliance with the peak conducted power limits. In addition, radiated emissions which fall in the restricted bands, as defined in §15.205(a), must also comply with the radiated emission limits specified in §15.209(a).

10.2 Test Setup

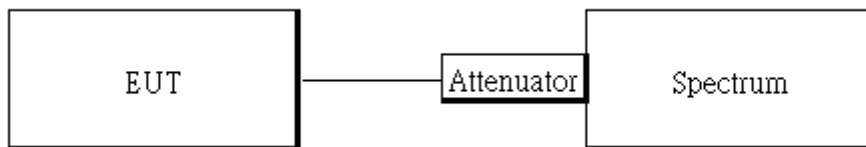

10.3 Measurement Procedure

10.3.1 Conducted Band Edge:

1. Place the EUT on the table and set it in transmitting mode.
2. The testing follows ANSI C63.10:2013.
3. Remove the antenna from the EUT and then connect a low loss RF cable from the antenna port to the spectrum analyzer.
4. Set center frequency of spectrum analyzer = operating frequency.
5. Set the spectrum analyzer as RBW=100 kHz, VBW=300 kHz, Sweep = auto
6. Mark Peak, below 2.4GHz and above 2.4835GHz and record the max. level.
7. Repeat above procedures until all frequency measured were complete.

10.3.2 Conducted Spurious Emission:

1. To connect Antenna Port of EUT to Spectrum.
2. The testing follows ANSI C63.10:2013.
3. Set RBW = 100 kHz & VBW = 300 kHz, Detector =Peak, Sweep = Auto
4. Allow trace to fully stabilize.
5. Use the peak marker function to determine the maximum power level in any 100 kHz band segment within the fundamental EBW.
6. Repeat above procedures until all default test channel measured were complete.

10.4 Measurement Result

See next page for test plots.

Unless otherwise stated the results shown in this test report refer only to the sample(s) tested and such sample(s) are retained for 90 days only.
 除非另有說明，此報告結果僅對測試之樣品負責，同時此樣品僅保留90天。本報告未經本公司書面許可，不可部份複製。

This document is issued by the Company subject to its General Conditions of Service printed overleaf, available on request or accessible at <http://www.sgs.com.tw/Terms-and-Conditions> and for electronic format documents, subject to Terms and Conditions for Electronic Documents at <http://www.sgs.com.tw/Terms-and-Conditions>. Attention is drawn to the limitation of liability, indemnification and jurisdiction issues defined therein. Any holder of this document is advised that information contained hereon reflects the Company's findings at the time of its intervention only and within the limits of Client's instructions, if any. The Company's sole responsibility is to its Client and this document does not exonerate parties to a transaction from exercising all their rights and obligations under the transaction documents. This document cannot be reproduced except in full, without prior written approval of the Company. Any unauthorized alteration, forgery or falsification of the content or appearance of this document is unlawful and offenders may be prosecuted to the fullest extent of the law.

Band Edge_GFSK_1M_DH5_2402MHz



Band Edge_π/4DQPSK_2M_DH5_2480MHz

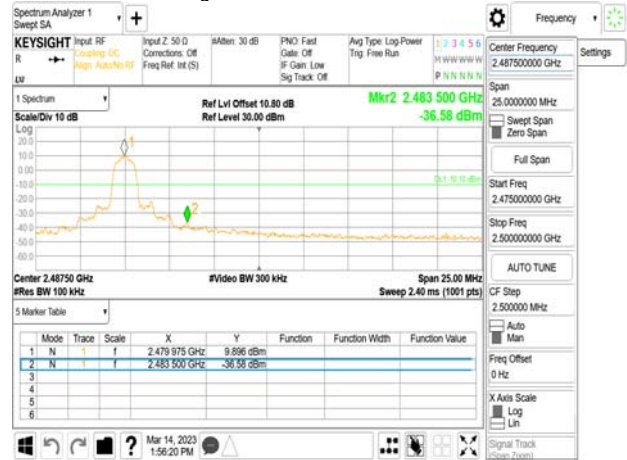

Band Edge_GFSK_1M_DH5_2480MHz

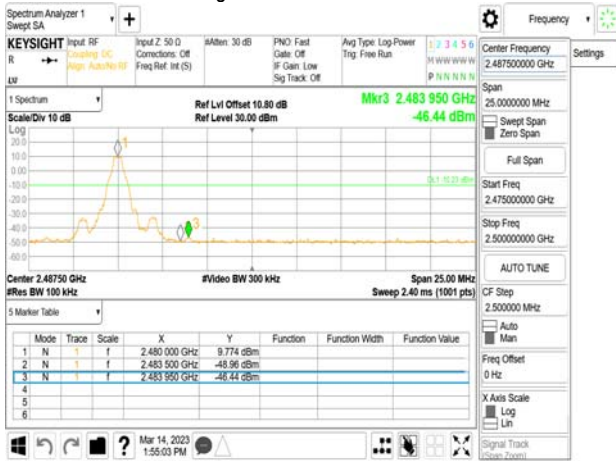

Band Edge_π/4DQPSK_2M_DH5_2402MHz



Unless otherwise stated the results shown in this test report refer only to the sample(s) tested and such sample(s) are retained for 90 days only.

除非另有說明，此報告結果僅對測試之樣品負責，同時此樣品僅保留90天。本報告未經本公司書面許可，不可部份複製。

This document is issued by the Company subject to its General Conditions of Service printed overleaf, available on request or accessible at <http://www.sgs.com.tw/Terms-and-Conditions>, and for electronic format documents, subject to Terms and Conditions for Electronic Documents at <http://www.sgs.com.tw/Terms-and-Conditions>. Attention is drawn to the limitation of liability, indemnification and jurisdiction issues defined therein. Any holder of this document is advised that information contained hereon reflects the Company's findings at the time of its intervention only and within the limits of Client's instructions, if any. The Company's sole responsibility is to its Client and this document does not exonerate parties to a transaction from exercising all their rights and obligations under the transaction documents. This document cannot be reproduced except in full, without prior written approval of the Company. Any unauthorized alteration, forgery or falsification of the content or appearance of this document is unlawful and offenders may be prosecuted to the fullest extent of the law.

Hopping Band Edge_GFSK_1M_DH5_2402MHz

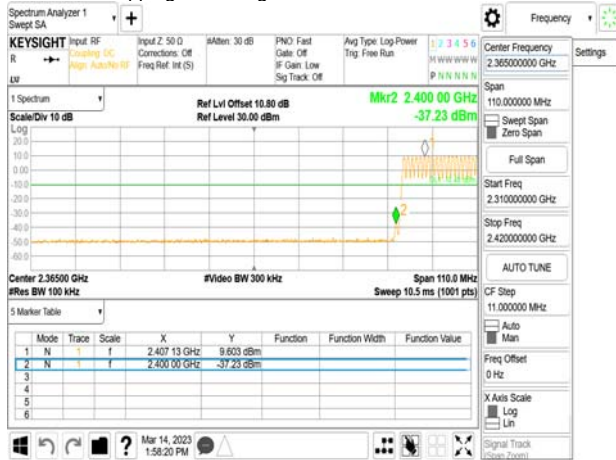

Hopping Band Edge_π/4DQPSK_2M_DH5_2480MHz

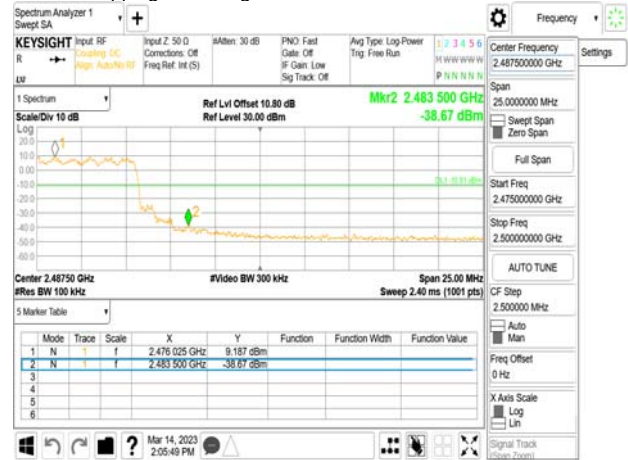

Hopping Band Edge_GFSK_1M_DH5_2480MHz

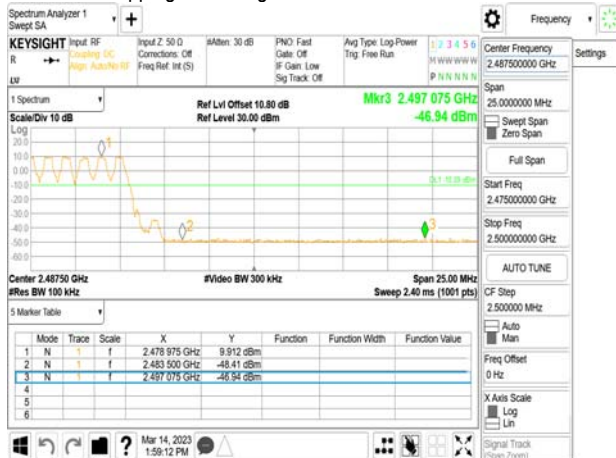

Hopping Band Edge_π/4DQPSK_2M_DH5_2402MHz



Unless otherwise stated the results shown in this test report refer only to the sample(s) tested and such sample(s) are retained for 90 days only.

除非另有說明，此報告結果僅對測試之樣品負責，同時此樣品僅保留90天。本報告未經本公司書面許可，不可部份複製。

This document is issued by the Company subject to its General Conditions of Service printed overleaf, available on request or accessible at <http://www.sgs.com.tw/Terms-and-Conditions> and for electronic format documents, subject to Terms and Conditions for Electronic Documents at <http://www.sgs.com.tw/Terms-and-Conditions>. Attention is drawn to the limitation of liability, indemnification and jurisdiction issues defined therein. Any holder of this document is advised that information contained hereon reflects the Company's findings at the time of its intervention only and within the limits of Client's instructions, if any. The Company's sole responsibility is to its Client and this document does not exonerate parties to a transaction from exercising all their rights and obligations under the transaction documents. This document cannot be reproduced except in full, without prior written approval of the Company. Any unauthorized alteration, forgery or falsification of the content or appearance of this document is unlawful and offenders may be prosecuted to the fullest extent of the law.

Spurious Emission_GFSK_1M_DH5_2402MHz

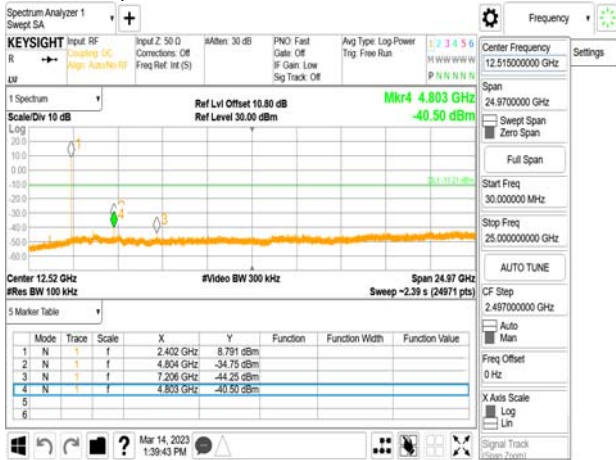

Spurious Emission_π/4QPSK_2M_DH5_2402MHz



Spurious Emission_GFSK_1M_DH5_2441MHz

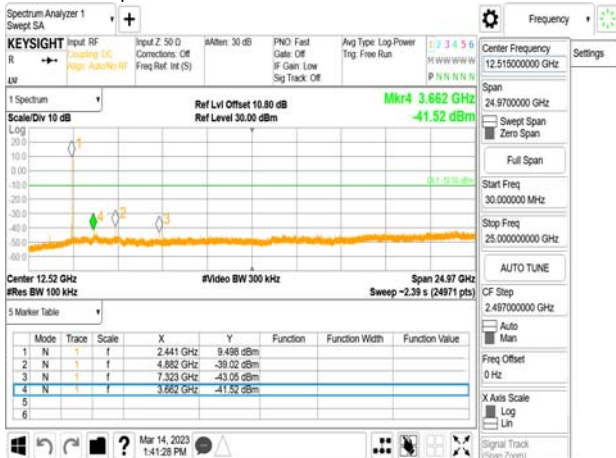

Spurious Emission_π/4QPSK_2M_DH5_2441MHz

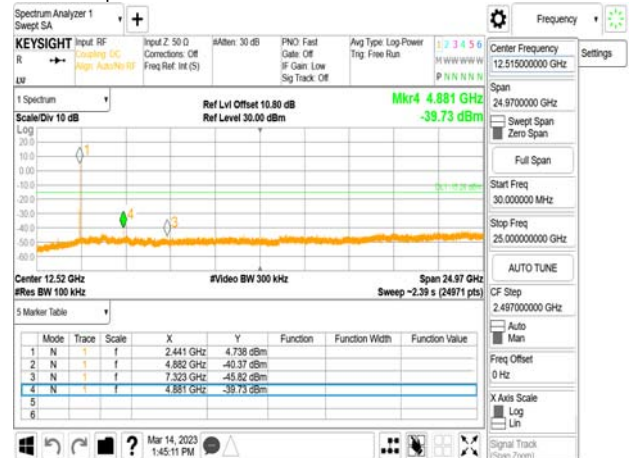

Spurious Emission_GFSK_1M_DH5_2480MHz

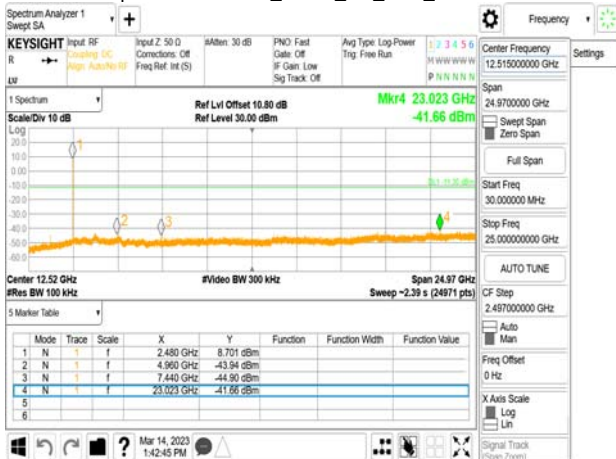

Spurious Emission_π/4QPSK_2M_DH5_2480MHz

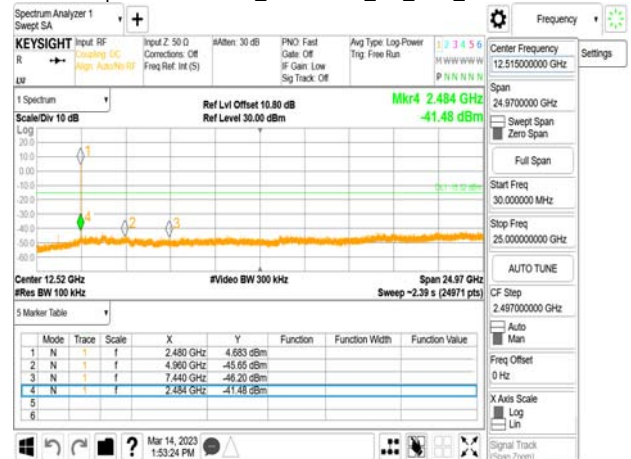

Unless otherwise stated the results shown in this test report refer only to the sample(s) tested and such sample(s) are retained for 90 days only.

除非另有說明，此報告結果僅對測試之樣品負責，同時此樣品僅保留90天。本報告未經本公司書面許可，不可部份複製。

This document is issued by the Company subject to its General Conditions of Service printed overleaf, available on request or accessible at <http://www.sgs.com.tw/Terms-and-Conditions> and for electronic format documents, subject to Terms and Conditions for Electronic Documents at <http://www.sgs.com.tw/Terms-and-Conditions>. Attention is drawn to the limitation of liability, indemnification and jurisdiction issues defined therein. Any holder of this document is advised that information contained hereon reflects the Company's findings at the time of its intervention only and within the limits of Client's instructions, if any. The Company's sole responsibility is to its Client and this document does not exonerate parties to a transaction from exercising all their rights and obligations under the transaction documents. This document cannot be reproduced except in full, without prior written approval of the Company. Any unauthorized alteration, forgery or falsification of the content or appearance of this document is unlawful and offenders may be prosecuted to the fullest extent of the law.

Spurious Emission_8DPSK_3M_DH5_2402MHz

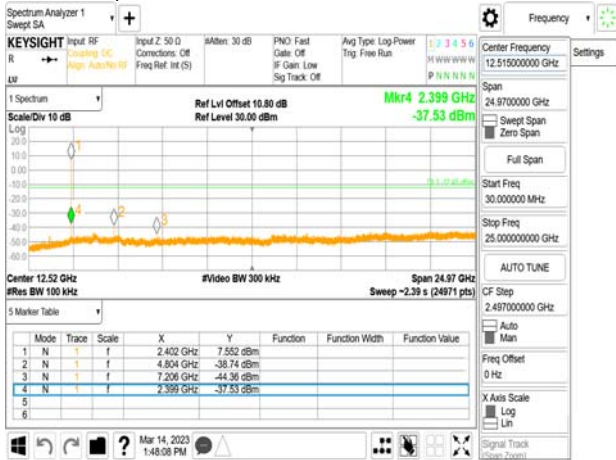

Spurious Emission_8DPSK_3M_DH5_2441MHz

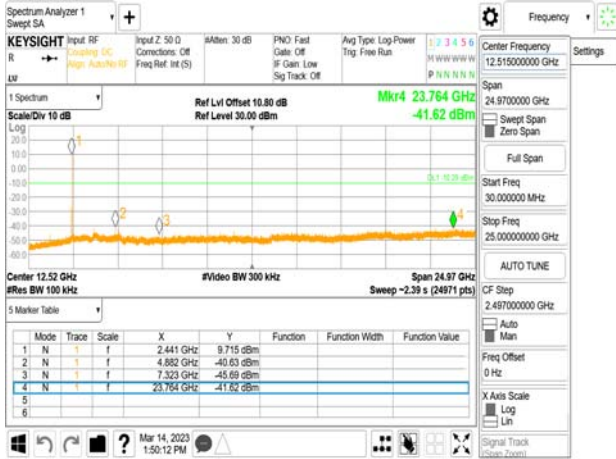

Spurious Emission_8DPSK_3M_DH5_2480MHz

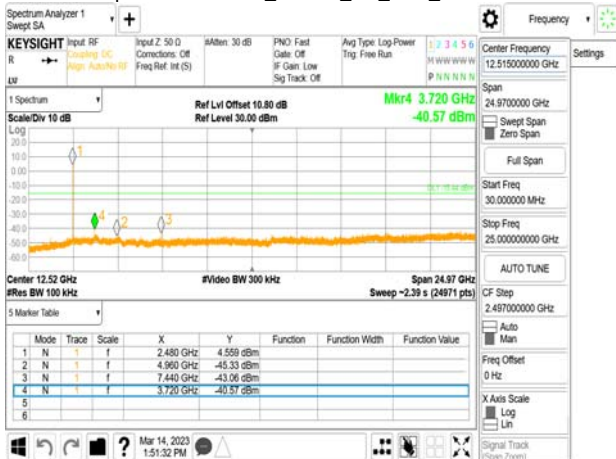

Unless otherwise stated the results shown in this test report refer only to the sample(s) tested and such sample(s) are retained for 90 days only.

除非另有說明，此報告結果僅對測試之樣品負責，同時此樣品僅保留90天。本報告未經本公司書面許可，不可部份複製。

This document is issued by the Company subject to its General Conditions of Service printed overleaf, available on request or accessible at <http://www.sgs.com.tw/Terms-and-Conditions> and for electronic format documents, subject to Terms and Conditions for Electronic Documents at <http://www.sgs.com.tw/Terms-and-Conditions>. Attention is drawn to the limitation of liability, indemnification and jurisdiction issues defined therein. Any holder of this document is advised that information contained hereon reflects the Company's findings at the time of its intervention only and within the limits of Client's instructions, if any. The Company's sole responsibility is to its Client and this document does not exonerate parties to a transaction from exercising all their rights and obligations under the transaction documents. This document cannot be reproduced except in full, without prior written approval of the Company. Any unauthorized alteration, forgery or falsification of the content or appearance of this document is unlawful and offenders may be prosecuted to the fullest extent of the law.

11 RADIATED BANDEDGE AND SPURIOUS EMISSION MEASUREMENT

11.1 Standard Applicable

11.1.1 Duty Cycle Correction Factor

According to 15.35(c), the measurement field strength shall be determined by averaging over one complete pulse train, including blanking intervals, as long as the pulse train does not exceed 0.1 seconds. As an alternative (provided the transmitter operates for longer than 0.1 seconds) or in cases where the pulse train exceeds 0.1 seconds, the measured field strength shall be determined from the average absolute voltage during a 0.1 second interval during which the field strength is at its maximum value. The exact method of calculating the average field strength shall be submitted with any application for certification.

11.1.2 Spurious Emission

In any 100 kHz bandwidth outside the frequency band in which the spread spectrum or digitally modulated intentional radiator is operating, the radio frequency power that is produced by the intentional radiator shall be at least 20 dB below that in the 100 kHz bandwidth within the band that contains the highest level of the desired power, based on either an RF conducted or a radiated measurement, provided the transmitter demonstrates compliance with the peak conducted power limits. In addition, radiated emissions which fall in the restricted bands must also comply with the §15.209 limit as below.

And according to §15.33(a) (1), for an intentional radiator operates below 10GHz, the frequency range of measurements: to the tenth harmonic of the highest fundamental frequency or to 40GHz, whichever is lower.

| Frequency (MHz) | Field strength (microvolts/meter) | Distance (meters) |
|-----------------|-----------------------------------|-------------------|
| 0.009-0.490 | 2400/F(kHz) | 300 |
| 0.490-1.705 | 24000/F(kHz) | 30 |
| 1.705-30 | 30 | 30 |
| 30-88 | 100 | 3 |
| 88-216 | 150 | 3 |
| 216-960 | 200 | 3 |
| Above 960 | 500 | 3 |

Note:

1. The lower limit shall apply at the transition frequencies.

Unless otherwise stated the results shown in this test report refer only to the sample(s) tested and such sample(s) are retained for 90 days only.
 除非另有說明，此報告結果僅對測試之樣品負責，同時此樣品僅保留90天。本報告未經本公司書面許可，不可部份複製。

This document is issued by the Company subject to its General Conditions of Service printed overleaf, available on request or accessible at <http://www.sgs.com.tw/Terms-and-Conditions> and for electronic format documents, subject to Terms and Conditions for Electronic Documents at <http://www.sgs.com.tw/Terms-and-Conditions>. Attention is drawn to the limitation of liability, indemnification and jurisdiction issues defined therein. Any holder of this document is advised that information contained hereon reflects the Company's findings at the time of its intervention only and within the limits of Client's instructions, if any. The Company's sole responsibility is to its Client and this document does not exonerate parties to a transaction from exercising all their rights and obligations under the transaction documents. This document cannot be reproduced except in full, without prior written approval of the Company. Any unauthorized alteration, forgery or falsification of the content or appearance of this document is unlawful and offenders may be prosecuted to the fullest extent of the law.

11.2 Test Setup

11.2.1 Duty Cycle Correction Factor

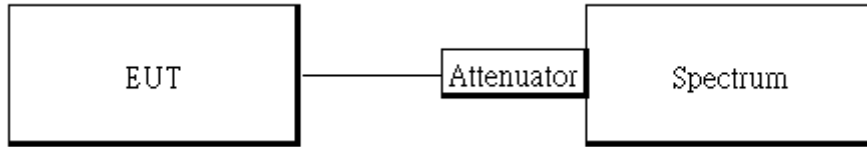

11.2.2 Radiated Emission

(A) Radiated Emission Test Set-Up, Frequency Below 30MHz.

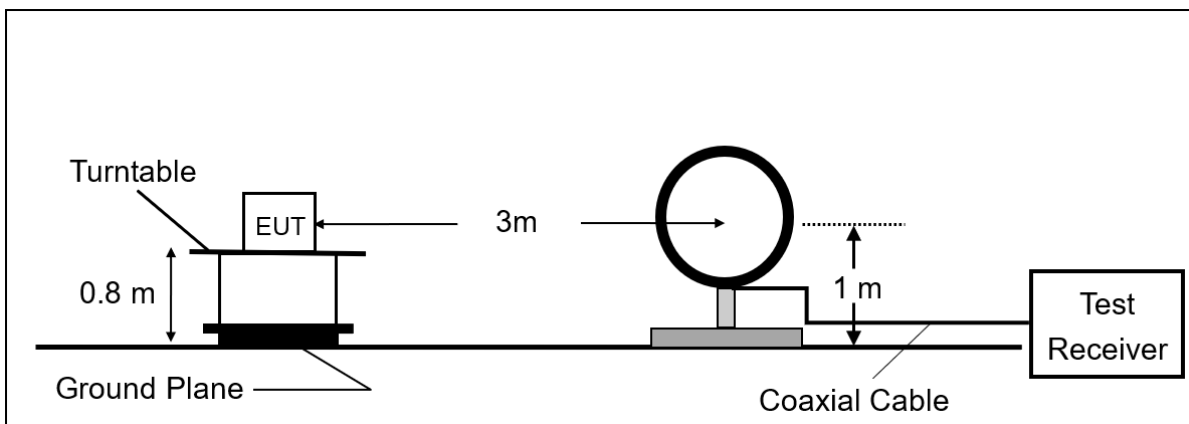

(B) Radiated Emission Test Set-Up, Frequency From 30MHz to 1000MHz.

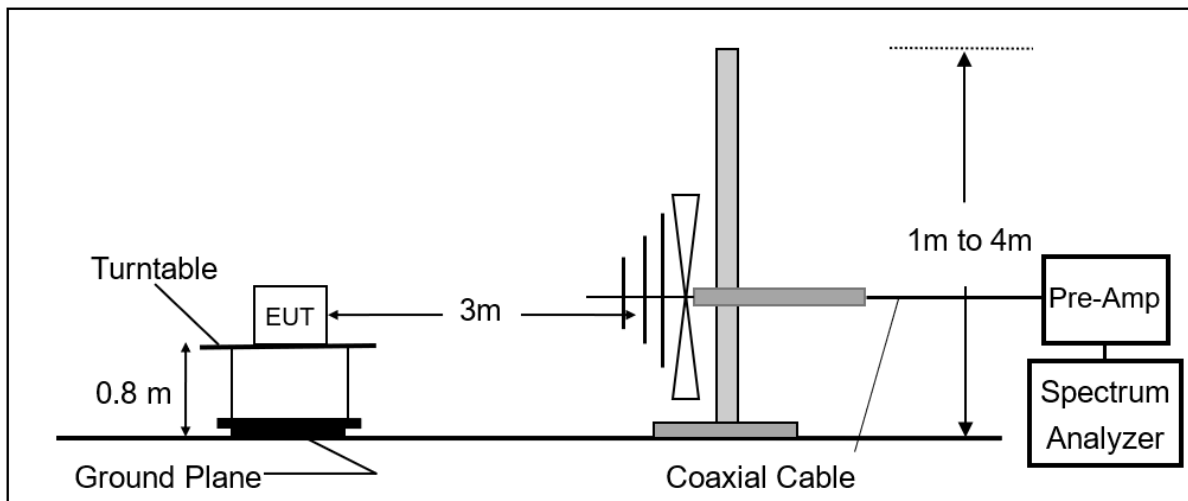

Unless otherwise stated the results shown in this test report refer only to the sample(s) tested and such sample(s) are retained for 90 days only.
 除非另有說明，此報告結果僅對測試之樣品負責，同時此樣品僅保留90天。本報告未經本公司書面許可，不可部份複製。

This document is issued by the Company subject to its General Conditions of Service printed overleaf, available on request or accessible at <http://www.sgs.com.tw/Terms-and-Conditions> and for electronic format documents, subject to Terms and Conditions for Electronic Documents at <http://www.sgs.com.tw/Terms-and-Conditions>. Attention is drawn to the limitation of liability, indemnification and jurisdiction issues defined therein. Any holder of this document is advised that information contained hereon reflects the Company's findings at the time of its intervention only and within the limits of Client's instructions, if any. The Company's sole responsibility is to its Client and this document does not exonerate parties to a transaction from exercising all their rights and obligations under the transaction documents. This document cannot be reproduced except in full, without prior written approval of the Company. Any unauthorized alteration, forgery or falsification of the content or appearance of this document is unlawful and offenders may be prosecuted to the fullest extent of the law.

(C) Radiated Emission Test Set-Up, Frequency Above 1 GHz.

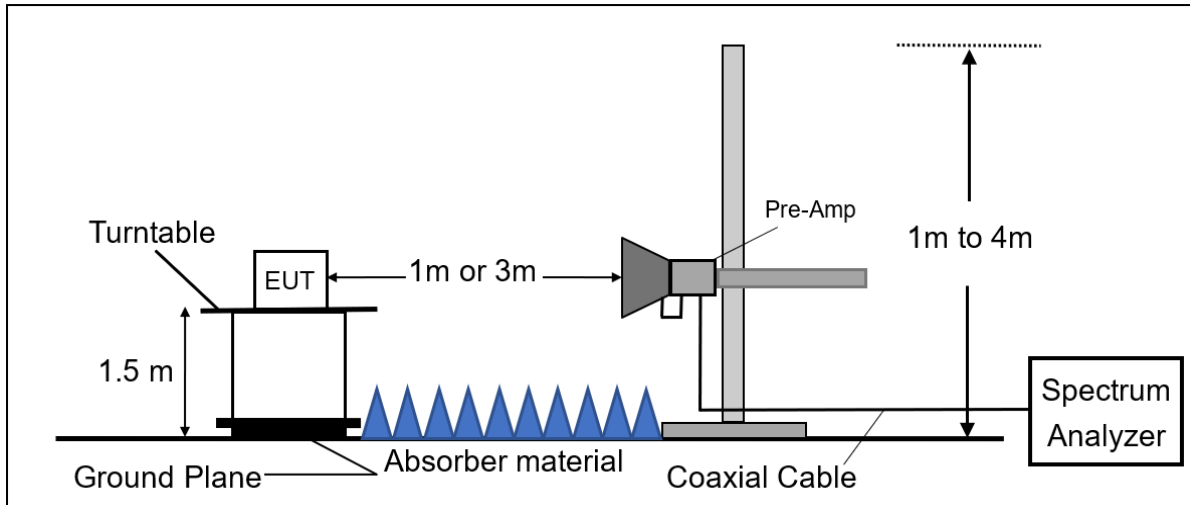

11.3 Measurement Procedure

11.3.1 Duty Cycle Correction Factor

1. Adjust and configure any EUT switches, controls, or input data streams to ensure that the EUT is transmitting or encoded to obtain the “worst-case” pulse ON time.
2. The testing follows ANSI C63.10:2013.
3. Remove the antenna from the EUT and then connect a low loss RF cable from the antenna port to the spectrum analyzer.
4. Set center frequency of spectrum analyzer = operating frequency.
5. Set the spectrum analyzer as RBW, VBW=1MHz, 3MHz, Span = 0Hz , Detector = Peak, Adjust Sweep=100ms.
6. Repeat above procedures until all frequency of the interest measured were complete.

11.3.2 Radiated Emission

1. The testing follows the Measurement Procedure of ANSI C63.10:2013.
2. The EUT was placed on a turn table with 0.8m for frequency < 1GHz and 1.5m for frequency > 1GHz above ground plane.
3. The turn table shall rotate 360 degrees to determine the position of maximum emission level.
4. EUT is set 3m away from the receiving antenna which varied from 1m to 4m to find out the highest emissions.
5. Set the spectrum analyzer as RBW=100 kHz and VBW=300 kHz for Peak Detector (PK) at frequency between 30MHz and 1 GHz.
6. Use receiver mode as RBW=120 kHz for Quasi-peak (QP) at frequency between 30MHz and 1 GHz.

Unless otherwise stated the results shown in this test report refer only to the sample(s) tested and such sample(s) are retained for 90 days only.
 除非另有說明，此報告結果僅對測試之樣品負責，同時此樣品僅保留90天。本報告未經本公司書面許可，不可部份複製。

This document is issued by the Company subject to its General Conditions of Service printed overleaf, available on request or accessible at <http://www.sgs.com.tw/Terms-and-Conditions> and for electronic format documents, subject to Terms and Conditions for Electronic Documents at <http://www.sgs.com.tw/Terms-and-Conditions>. Attention is drawn to the limitation of liability, indemnification and jurisdiction issues defined therein. Any holder of this document is advised that information contained hereon reflects the Company's findings at the time of its intervention only and within the limits of Client's instructions, if any. The Company's sole responsibility is to its Client and this document does not exonerate parties to a transaction from exercising all their rights and obligations under the transaction documents. This document cannot be reproduced except in full, without prior written approval of the Company. Any unauthorized alteration, forgery or falsification of the content or appearance of this document is unlawful and offenders may be prosecuted to the fullest extent of the law.

7. Set the spectrum analyzer as RBW=1 MHz, VBW=3 MHz for Maximum Emission Measurements at frequency above 1 GHz.
8. According to C63.10:2013 Section 7.5 Procedure for determining the average value of pulsed emissions with duty cycle correction factor $20 \log (T_{on}/100ms)$.
9. When measurement procedures for electric field radiated emissions above 1 GHz the EUT measurement is to be made "while keeping the antenna in the 'cone of radiation' from that area and pointed at the area both in azimuth and elevation, with polarization oriented for maximum response." is still within the 3dB illumination BW of the measurement antenna.
10. Maximum procedure was performed on the six highest emissions to ensure EUT compliance.
11. And also, each emission was to be maximized by changing the polarization of receiving antenna both horizontal and vertical.
12. Repeat above procedures until all default test channel measured were complete.

11.4 Field Strength Calculation

The field strength is calculated by adding the Antenna Factor and Cable Factor and subtracting the Amplifier Gain and Duty Cycle Correction Factor (if any) from the measured reading. The basic equation with a sample calculation is as follows:

$$FS = RA + AF + CL - AG$$

Where *FS = Field Strength*

CL = Cable Attenuation Factor (Cable Loss)

RA = Reading Amplitude

AG = Amplifier Gain

AF = Antenna Factor

The limit of the emission level is expressed in dBuV/m, which converts $20 \cdot \log(uV/m)$

Actual FS(dBμV/m) = SPA. Reading level(dBμV) + Factor(dB)

Factor(dB) = Antenna Factor(dBμV/m) + Cable Loss(dB) – Pre_Amplifier Gain(dB)

Average value(dBμV/m)=Peak Actual FS(dBμV/m)+ Duty Cycle Correction Factor(dB)

Duty Cycle Correction Factor(dB) = $20 \log (T_{on}/100 \text{ ms})$

11.5 Test Results of Radiated Spurious Emissions form 9 kHz to 30 MHz

The low frequency, which started from 9 kHz to 30MHz, was pre-scanned and the result which was 20dB lower than the limit per 15.31(o) was not reported.

Unless otherwise stated the results shown in this test report refer only to the sample(s) tested and such sample(s) are retained for 90 days only.
除非另有說明，此報告結果僅對測試之樣品負責，同時此樣品僅保留90天。本報告未經本公司書面許可，不可部份複製。

This document is issued by the Company subject to its General Conditions of Service printed overleaf, available on request or accessible at <http://www.sgs.com.tw/Terms-and-Conditions> and for electronic format documents, subject to Terms and Conditions for Electronic Documents at <http://www.sgs.com.tw/Terms-and-Conditions>. Attention is drawn to the limitation of liability, indemnification and jurisdiction issues defined therein. Any holder of this document is advised that information contained hereon reflects the Company's findings at the time of its intervention only and within the limits of Client's instructions, if any. The Company's sole responsibility is to its Client and this document does not exonerate parties to a transaction from exercising all their rights and obligations under the transaction documents. This document cannot be reproduced except in full, without prior written approval of the Company. Any unauthorized alteration, forgery or falsification of the content or appearance of this document is unlawful and offenders may be prosecuted to the fullest extent of the law.

11.6 Measurement Result:

11.6.1 Duty Cycle Correction Factor

| | | | |
|--|--------|----|--|
| BR | | | |
| Time ON of 100ms: | 5.800 | ms | |
| Duty Cycle=5.8ms / 100ms: | 0.058 | % | |
| Duty Cycle correction factor=20 LOG 0.058= | -24.73 | dB | |

| | | | |
|--|--------|----|--|
| EDR 2M | | | |
| Time ON of 100ms: | 5.800 | ms | |
| Duty Cycle=5.8ms / 100ms: | 0.058 | % | |
| Duty Cycle correction factor=20 LOG 0.058= | -24.73 | dB | |

Unless otherwise stated the results shown in this test report refer only to the sample(s) tested and such sample(s) are retained for 90 days only.
 除非另有說明，此報告結果僅對測試之樣品負責，同時此樣品僅保留90天。本報告未經本公司書面許可，不可部份複製。

This document is issued by the Company subject to its General Conditions of Service printed overleaf, available on request or accessible at <http://www.sgs.com.tw/Terms-and-Conditions> and for electronic format documents, subject to Terms and Conditions for Electronic Documents at <http://www.sgs.com.tw/Terms-and-Conditions>. Attention is drawn to the limitation of liability, indemnification and jurisdiction issues defined therein. Any holder of this document is advised that information contained hereon reflects the Company's findings at the time of its intervention only and within the limits of Client's instructions, if any. The Company's sole responsibility is to its Client and this document does not exonerate parties to a transaction from exercising all their rights and obligations under the transaction documents. This document cannot be reproduced except in full, without prior written approval of the Company. Any unauthorized alteration, forgery or falsification of the content or appearance of this document is unlawful and offenders may be prosecuted to the fullest extent of the law.

11.6.2 Duty Cycle test plot

BR

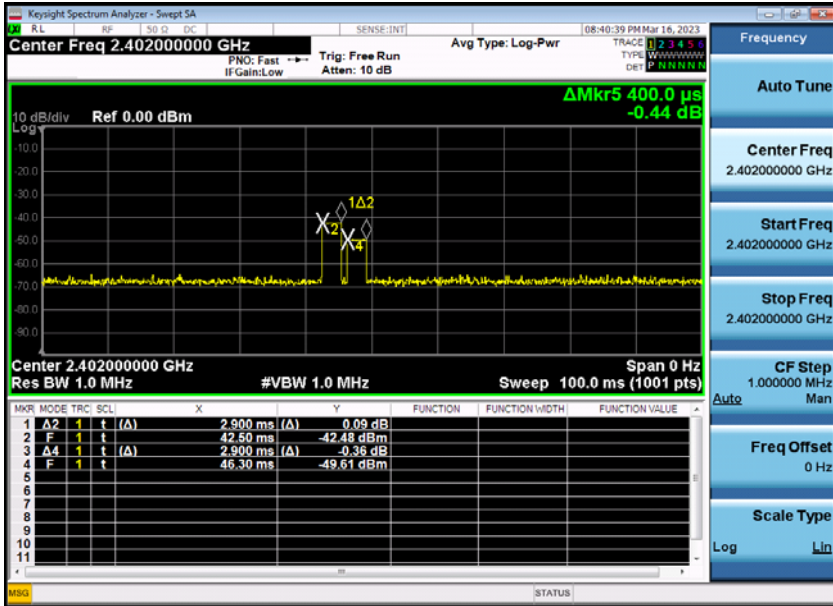

EDR

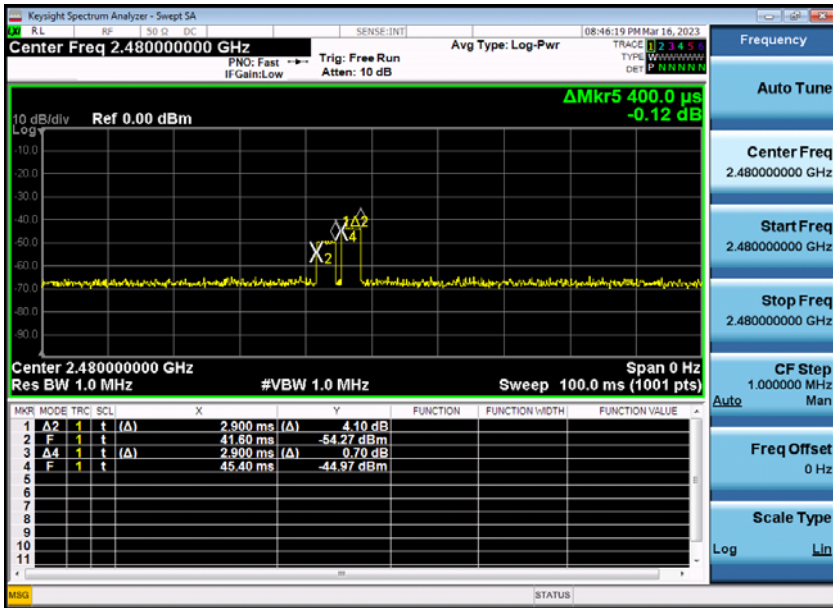

Unless otherwise stated the results shown in this test report refer only to the sample(s) tested and such sample(s) are retained for 90 days only.

除非另有說明，此報告結果僅對測試之樣品負責，同時此樣品僅保留90天。本報告未經本公司書面許可，不可部份複製。

This document is issued by the Company subject to its General Conditions of Service printed overleaf, available on request or accessible at <http://www.sgs.com.tw/Terms-and-Conditions> and for electronic format documents, subject to Terms and Conditions for Electronic Documents at <http://www.sgs.com.tw/Terms-and-Conditions>. Attention is drawn to the limitation of liability, indemnification and jurisdiction issues defined therein. Any holder of this document is advised that information contained hereon reflects the Company's findings at the time of its intervention only and within the limits of Client's instructions, if any. The Company's sole responsibility is to its Client and this document does not exonerate parties to a transaction from exercising all their rights and obligations under the transaction documents. This document cannot be reproduced except in full, without prior written approval of the Company. Any unauthorized alteration, forgery or falsification of the content or appearance of this document is unlawful and offenders may be prosecuted to the fullest extent of the law.

11.6.3 Bandedge Result

Report Number :TERF2303000419E2
 Operation Mode :BR
 Test Frequency :2402 MHz
 Test Mode :Bandedge
 EUT Pol :E2 Plane

Test Site :SAC D
 Test Date :2023-03-16
 Temp./Humi. :21.0/57
 Antenna Pol. :Vertical
 Engineer :Howard Huang

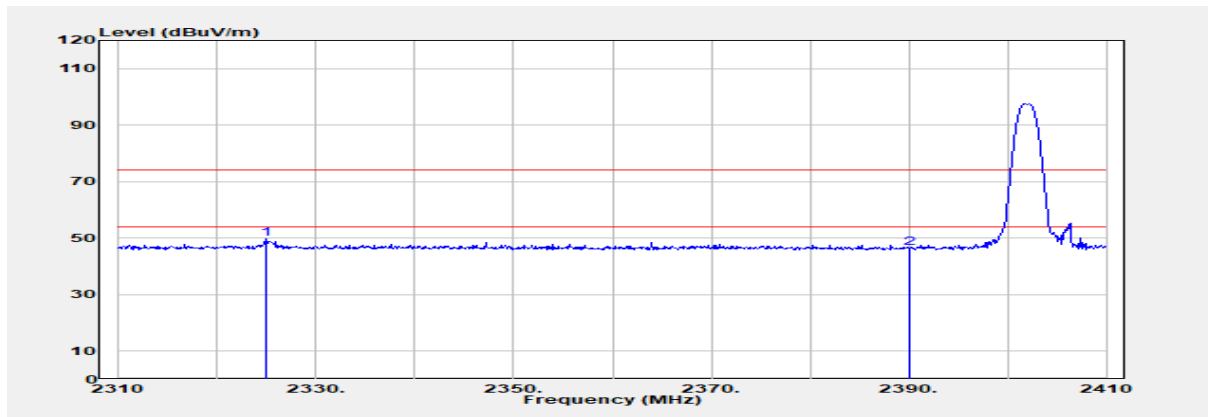

| Freq. MHz | Detector Mode PK/QP/AV | Spectrum Reading Level dB μ V | Factor dB | Actual FS dB μ V/m | Limit @3m dB μ V/m | Margin dB |
|--------------|------------------------------|---|--------------|------------------------------|------------------------------|--------------|
|--------------|------------------------------|---|--------------|------------------------------|------------------------------|--------------|

| | | | | | | |
|----------|------|-------|-------|-------|-------|--------|
| 2325.000 | Peak | 56.51 | -6.83 | 49.67 | 74.00 | -24.33 |
| 2390.000 | Peak | 53.53 | -7.04 | 46.48 | 74.00 | -27.52 |

| Freq. MHz | Detector Mode AV | Peak Actual FS (dB μ V/m) | Duty Cycle Factor (dB) | Average Value (dB μ V/m) | Average Limit@3m (dB μ V/m) | Margin (dB) |
|--------------|------------------------|-------------------------------------|------------------------------|------------------------------------|---------------------------------------|----------------|
|--------------|------------------------|-------------------------------------|------------------------------|------------------------------------|---------------------------------------|----------------|

| | | | | | | |
|----------|---------|-------|--------|-------|-------|--------|
| 2325.000 | Average | 49.67 | -24.73 | 24.94 | 54.00 | -29.06 |
| 2390.000 | Average | 46.48 | -24.73 | 21.75 | 54.00 | -32.25 |

Unless otherwise stated the results shown in this test report refer only to the sample(s) tested and such sample(s) are retained for 90 days only.

除非另有說明，此報告結果僅對測試之樣品負責，同時此樣品僅保留90天。本報告未經本公司書面許可，不可部份複製。

This document is issued by the Company subject to its General Conditions of Service printed overleaf, available on request or accessible at <http://www.sgs.com.tw/Terms-and-Conditions> and for electronic format documents, subject to Terms and Conditions for Electronic Documents at <http://www.sgs.com.tw/Terms-and-Conditions>. Attention is drawn to the limitation of liability, indemnification and jurisdiction issues defined therein. Any holder of this document is advised that information contained hereon reflects the Company's findings at the time of its intervention only and within the limits of Client's instructions, if any. The Company's sole responsibility is to its Client and this document does not exonerate parties to a transaction from exercising all their rights and obligations under the transaction documents. This document cannot be reproduced except in full, without prior written approval of the Company. Any unauthorized alteration, forgery or falsification of the content or appearance of this document is unlawful and offenders may be prosecuted to the fullest extent of the law.

Report Number :TERF2303000419E2
 Operation Mode :BR
 Test Frequency :2402 MHz
 Test Mode :Bandedge
 EUT Pol :E2 Plane

Test Site :SAC D
 Test Date :2023-03-16
 Temp./Humi. :21.0/57
 Antenna Pol. :Horizontal
 Engineer :Howard Huang

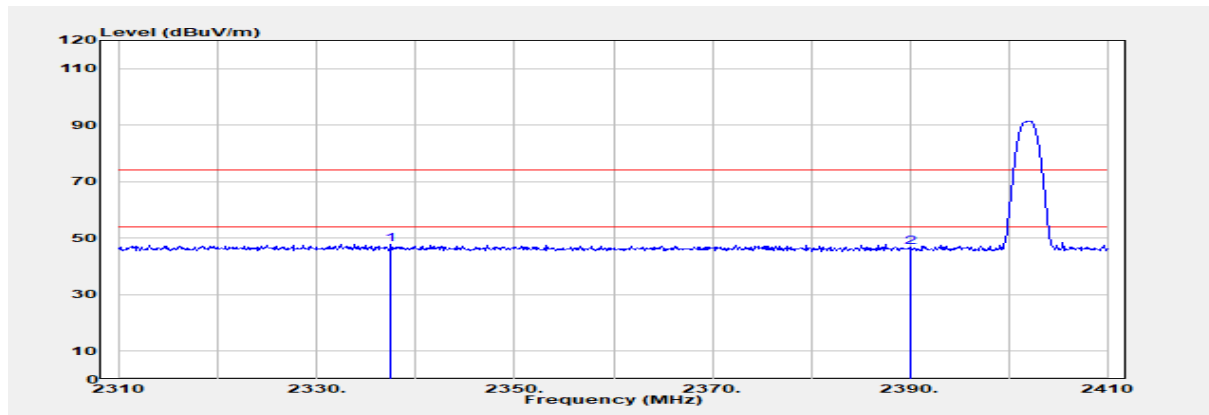

| Freq. MHz | Detector Mode PK/QP/AV | Spectrum Reading Level dB μ V | Factor dB | Actual FS dB μ V/m | Limit @3m dB μ V/m | Margin dB |
|--------------|------------------------------|---|--------------|------------------------------|------------------------------|--------------|
| 2337.500 | Peak | 54.63 | -6.87 | 47.76 | 74.00 | -26.24 |
| 2390.000 | Peak | 53.93 | -7.04 | 46.88 | 74.00 | -27.12 |

| Freq. MHz | Detector Mode AV | Peak Actual FS (dB μ V/m) | Duty Cycle Factor (dB) | Average Value (dBuV/m) | Average Limit@3m (dBuV/m) | Margin (dB) |
|--------------|------------------------|-------------------------------------|------------------------------|------------------------------|---------------------------------|----------------|
| 2337.500 | Average | 47.76 | -24.73 | 23.03 | 54.00 | -30.97 |
| 2390.000 | Average | 46.88 | -24.73 | 22.15 | 54.00 | -31.85 |

Unless otherwise stated the results shown in this test report refer only to the sample(s) tested and such sample(s) are retained for 90 days only.

除非另有說明，此報告結果僅對測試之樣品負責，同時此樣品僅保留90天。本報告未經本公司書面許可，不可部份複製。

This document is issued by the Company subject to its General Conditions of Service printed overleaf, available on request or accessible at <http://www.sgs.com.tw/Terms-and-Conditions> and for electronic format documents, subject to Terms and Conditions for Electronic Documents at <http://www.sgs.com.tw/Terms-and-Conditions>. Attention is drawn to the limitation of liability, indemnification and jurisdiction issues defined therein. Any holder of this document is advised that information contained hereon reflects the Company's findings at the time of its intervention only and within the limits of Client's instructions, if any. The Company's sole responsibility is to its Client and this document does not exonerate parties to a transaction from exercising all their rights and obligations under the transaction documents. This document cannot be reproduced except in full, without prior written approval of the Company. Any unauthorized alteration, forgery or falsification of the content or appearance of this document is unlawful and offenders may be prosecuted to the fullest extent of the law.

Report Number :TERF2303000419E2

Test Site :SAC D

Operation Mode :BR

Test Date :2023-03-16

Test Frequency :2480 MHz

Temp./Humi. :21.0/57

Test Mode :Bandedge

Antenna Pol. :Vertical

EUT Pol :E2 Plane

Engineer :Howard Huang

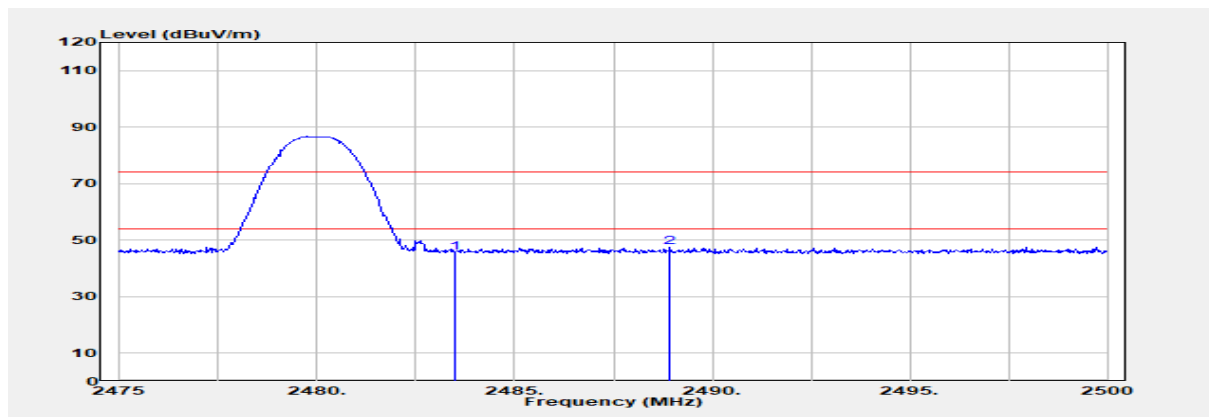

| Freq. MHz | Detector Mode PK/QP/AV | Spectrum Reading Level dB μ V | Factor dB | Actual FS dB μ V/m | Limit @3m dB μ V/m | Margin dB |
|--------------|------------------------------|---|--------------|------------------------------|------------------------------|--------------|
|--------------|------------------------------|---|--------------|------------------------------|------------------------------|--------------|

| | | | | | | |
|----------|------|-------|-------|-------|-------|--------|
| 2483.500 | Peak | 52.87 | -7.20 | 45.67 | 74.00 | -28.33 |
| 2488.925 | Peak | 54.60 | -7.22 | 47.38 | 74.00 | -26.62 |

| Freq. MHz | Detector Mode AV | Peak Actual FS (dB μ V/m) | Duty Cycle Factor (dB) | Average Value (dBuV/m) | Average Limit@3m (dBuV/m) | Margin (dB) |
|--------------|------------------------|-------------------------------------|------------------------------|------------------------------|---------------------------------|----------------|
|--------------|------------------------|-------------------------------------|------------------------------|------------------------------|---------------------------------|----------------|

| | | | | | | |
|----------|---------|-------|--------|-------|-------|--------|
| 2483.500 | Average | 45.67 | -24.73 | 20.94 | 54.00 | -33.06 |
| 2488.925 | Average | 47.38 | -24.73 | 22.65 | 54.00 | -31.35 |

Unless otherwise stated the results shown in this test report refer only to the sample(s) tested and such sample(s) are retained for 90 days only.

除非另有說明，此報告結果僅對測試之樣品負責，同時此樣品僅保留90天。本報告未經本公司書面許可，不可部份複製。

This document is issued by the Company subject to its General Conditions of Service printed overleaf, available on request or accessible at <http://www.sgs.com.tw/Terms-and-Conditions> and for electronic format documents, subject to Terms and Conditions for Electronic Documents at <http://www.sgs.com.tw/Terms-and-Conditions>. Attention is drawn to the limitation of liability, indemnification and jurisdiction issues defined therein. Any holder of this document is advised that information contained hereon reflects the Company's findings at the time of its intervention only and within the limits of Client's instructions, if any. The Company's sole responsibility is to its Client and this document does not exonerate parties to a transaction from exercising all their rights and obligations under the transaction documents. This document cannot be reproduced except in full, without prior written approval of the Company. Any unauthorized alteration, forgery or falsification of the content or appearance of this document is unlawful and offenders may be prosecuted to the fullest extent of the law.

Report Number :TERF2303000419E2

Test Site :SAC D

Operation Mode :BR

Test Date :2023-03-16

Test Frequency :2480 MHz

Temp./Humi. :21.0/57

Test Mode :Bandedge

Antenna Pol. :Horizontal

EUT Pol :E2 Plane

Engineer :Howard Huang

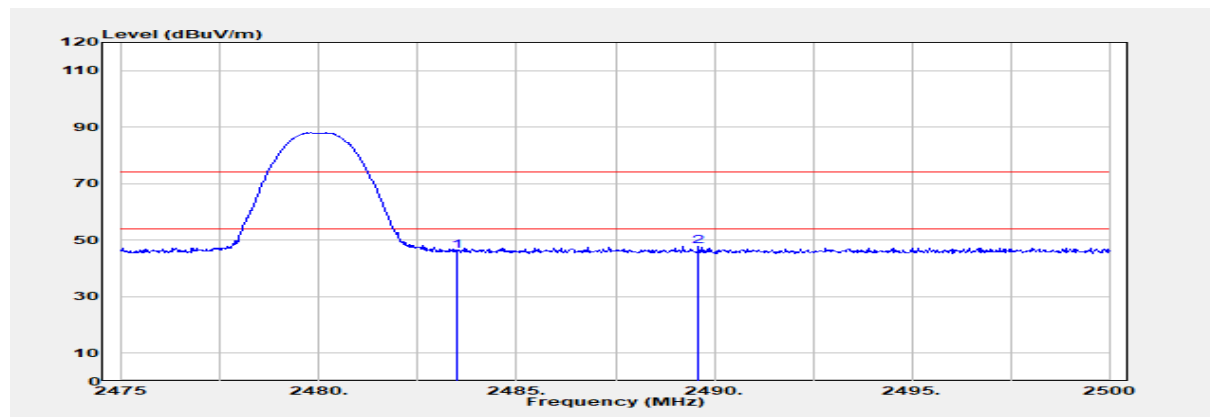

| Freq. MHz | Detector Mode PK/QP/AV | Spectrum Reading Level dB μ V | Factor dB | Actual FS dB μ V/m | Limit @3m dB μ V/m | Margin dB |
|--------------|------------------------------|---|--------------|------------------------------|------------------------------|--------------|
| 2483.500 | Peak | 53.49 | -7.20 | 46.30 | 74.00 | -27.70 |
| 2489.600 | Peak | 55.01 | -7.22 | 47.78 | 74.00 | -26.22 |

| Freq. MHz | Detector Mode AV | Peak Actual FS (dB μ V/m) | Duty Cycle Factor (dB) | Average Value (dBuV/m) | Average Limit@3m (dBuV/m) | Margin (dB) |
|--------------|------------------------|-------------------------------------|------------------------------|------------------------------|---------------------------------|----------------|
| 2483.500 | Average | 46.30 | -24.73 | 21.57 | 54.00 | -32.43 |
| 2489.600 | Average | 47.78 | -24.73 | 23.05 | 54.00 | -30.95 |

Unless otherwise stated the results shown in this test report refer only to the sample(s) tested and such sample(s) are retained for 90 days only.

除非另有說明，此報告結果僅對測試之樣品負責，同時此樣品僅保留90天。本報告未經本公司書面許可，不可部份複製。
 This document is issued by the Company subject to its General Conditions of Service printed overleaf, available on request or accessible at <http://www.sgs.com.tw/Terms-and-Conditions> and for electronic format documents, subject to Terms and Conditions for Electronic Documents at <http://www.sgs.com.tw/Terms-and-Conditions>. Attention is drawn to the limitation of liability, indemnification and jurisdiction issues defined therein. Any holder of this document is advised that information contained hereon reflects the Company's findings at the time of its intervention only and within the limits of Client's instructions, if any. The Company's sole responsibility is to its Client and this document does not exonerate parties to a transaction from exercising all their rights and obligations under the transaction documents. This document cannot be reproduced except in full, without prior written approval of the Company. Any unauthorized alteration, forgery or falsification of the content or appearance of this document is unlawful and offenders may be prosecuted to the fullest extent of the law.

Report Number :TERF2303000419E2
 Operation Mode :BR HOPPING
 Test Frequency :2402 MHz
 Test Mode :Bandedge
 EUT Pol :E2 Plane

Test Site :SAC D
 Test Date :2023-03-16
 Temp./Humi. :21.0/57
 Antenna Pol. :Vertical
 Engineer :Howard Huang

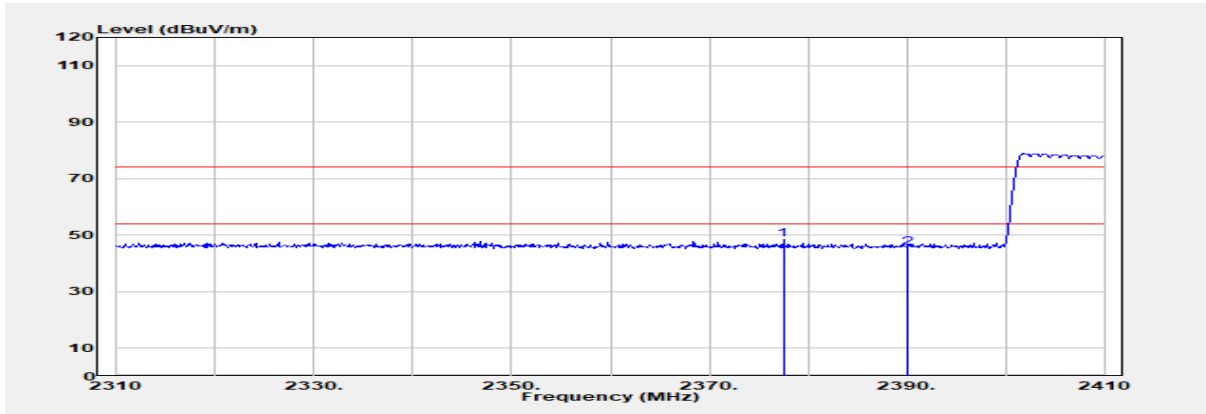

| Freq. MHz | Detector Mode PK/QP/AV | Spectrum Reading Level dB μ V | Factor dB | Actual FS dB μ V/m | Limit @3m dB μ V/m | Margin dB |
|--------------|------------------------------|---|--------------|------------------------------|------------------------------|--------------|
| 2377.500 | Peak | 55.40 | -7.00 | 48.39 | 74.00 | -25.61 |
| 2390.000 | Peak | 52.68 | -7.04 | 45.64 | 74.00 | -28.36 |

| Freq. MHz | Detector Mode AV | Peak Actual FS (dB μ V/m) | Duty Cycle Factor (dB) | Average Value (dBuV/m) | Average Limit@3m (dBuV/m) | Margin (dB) |
|--------------|------------------------|-------------------------------------|------------------------------|------------------------------|---------------------------------|----------------|
| 2377.500 | Average | 48.39 | -24.73 | 23.66 | 54.00 | -30.34 |
| 2390.000 | Average | 45.64 | -24.73 | 20.91 | 54.00 | -33.09 |

Unless otherwise stated the results shown in this test report refer only to the sample(s) tested and such sample(s) are retained for 90 days only.

除非另有說明，此報告結果僅對測試之樣品負責，同時此樣品僅保留90天。本報告未經本公司書面許可，不可部份複製。

This document is issued by the Company subject to its General Conditions of Service printed overleaf, available on request or accessible at <http://www.sgs.com.tw/Terms-and-Conditions> and for electronic format documents, subject to Terms and Conditions for Electronic Documents at <http://www.sgs.com.tw/Terms-and-Conditions>. Attention is drawn to the limitation of liability, indemnification and jurisdiction issues defined therein. Any holder of this document is advised that information contained hereon reflects the Company's findings at the time of its intervention only and within the limits of Client's instructions, if any. The Company's sole responsibility is to its Client and this document does not exonerate parties to a transaction from exercising all their rights and obligations under the transaction documents. This document cannot be reproduced except in full, without prior written approval of the Company. Any unauthorized alteration, forgery or falsification of the content or appearance of this document is unlawful and offenders may be prosecuted to the fullest extent of the law.

Report Number :TERF2303000419E2
 Operation Mode :BR HOPPING
 Test Frequency :2402 MHz
 Test Mode :Bandedge
 EUT Pol :E2 Plane

Test Site :SAC D
 Test Date :2023-03-16
 Temp./Humi. :21.0/57
 Antenna Pol. :Horizontal
 Engineer :Howard Huang

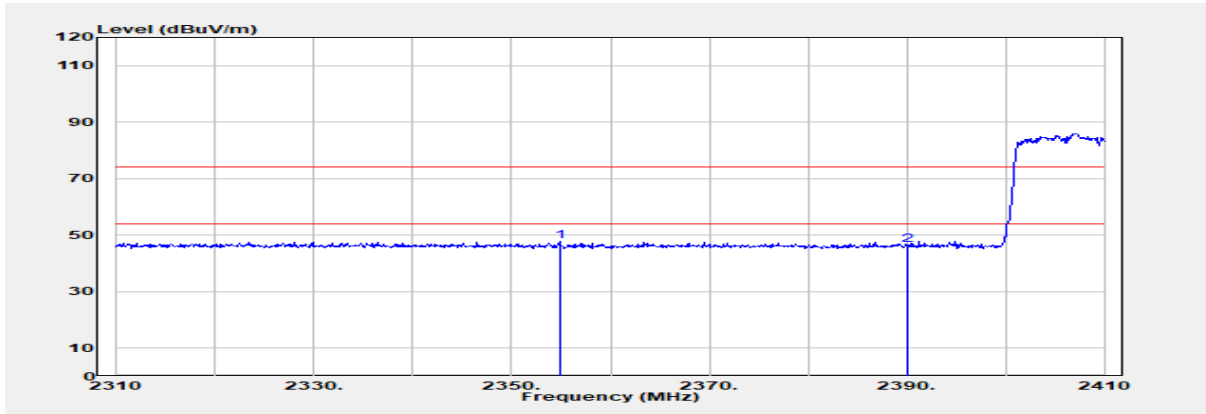

| Freq. MHz | Detector Mode PK/QP/AV | Spectrum Reading Level dB μ V | Factor dB | Actual FS dB μ V/m | Limit @3m dB μ V/m | Margin dB |
|--------------|------------------------------|---|--------------|------------------------------|------------------------------|--------------|
| 2354.900 | Peak | 54.66 | -6.93 | 47.73 | 74.00 | -26.27 |
| 2390.000 | Peak | 53.68 | -7.04 | 46.64 | 74.00 | -27.36 |

| Freq. MHz | Detector Mode AV | Peak Actual FS (dB μ V/m) | Duty Cycle Factor (dB) | Average Value (dBuV/m) | Average Limit@3m (dBuV/m) | Margin (dB) |
|--------------|------------------------|-------------------------------------|------------------------------|------------------------------|---------------------------------|----------------|
| 2354.900 | Average | 47.73 | -24.73 | 23.00 | 54.00 | -31.00 |
| 2390.000 | Average | 46.64 | -24.73 | 21.91 | 54.00 | -32.09 |

Unless otherwise stated the results shown in this test report refer only to the sample(s) tested and such sample(s) are retained for 90 days only.

除非另有說明，此報告結果僅對測試之樣品負責，同時此樣品僅保留90天。本報告未經本公司書面許可，不可部份複製。

This document is issued by the Company subject to its General Conditions of Service printed overleaf, available on request or accessible at <http://www.sgs.com.tw/Terms-and-Conditions> and for electronic format documents, subject to Terms and Conditions for Electronic Documents at <http://www.sgs.com.tw/Terms-and-Conditions>. Attention is drawn to the limitation of liability, indemnification and jurisdiction issues defined therein. Any holder of this document is advised that information contained hereon reflects the Company's findings at the time of its intervention only and within the limits of Client's instructions, if any. The Company's sole responsibility is to its Client and this document does not exonerate parties to a transaction from exercising all their rights and obligations under the transaction documents. This document cannot be reproduced except in full, without prior written approval of the Company. Any unauthorized alteration, forgery or falsification of the content or appearance of this document is unlawful and offenders may be prosecuted to the fullest extent of the law.

Report Number :TERF2303000419E2

Test Site :SAC D

Operation Mode :BR HOPPING

Test Date :2023-03-16

Test Frequency :2480 MHz

Temp./Humi. :21.0/57

Test Mode :Bandedge

Antenna Pol. :Vertical

EUT Pol :E2 Plane

Engineer :Howard Huang

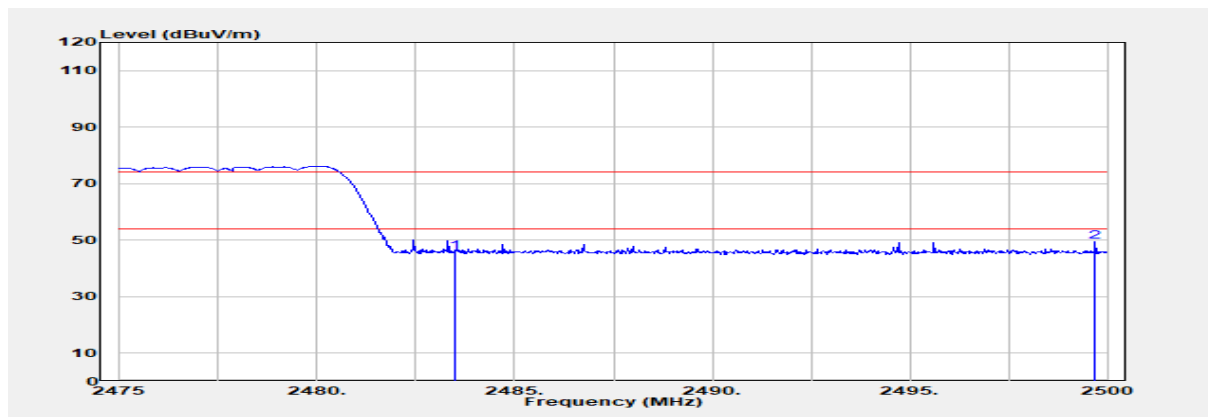

| Freq. MHz | Detector Mode PK/QP/AV | Spectrum Reading Level dB μ V | Factor dB | Actual FS dB μ V/m | Limit @3m dB μ V/m | Margin dB |
|--------------|------------------------------|---|--------------|------------------------------|------------------------------|--------------|
|--------------|------------------------------|---|--------------|------------------------------|------------------------------|--------------|

| | | | | | | |
|----------|------|-------|-------|-------|-------|--------|
| 2483.500 | Peak | 52.95 | -7.20 | 45.75 | 74.00 | -28.25 |
| 2499.700 | Peak | 56.61 | -7.27 | 49.35 | 74.00 | -24.65 |

| Freq. MHz | Detector Mode AV | Peak Actual FS (dB μ V/m) | Duty Cycle Factor (dB) | Average Value (dBuV/m) | Average Limit@3m (dBuV/m) | Margin (dB) |
|--------------|------------------------|-------------------------------------|------------------------------|------------------------------|---------------------------------|----------------|
|--------------|------------------------|-------------------------------------|------------------------------|------------------------------|---------------------------------|----------------|

| | | | | | | |
|----------|---------|-------|--------|-------|-------|--------|
| 2483.500 | Average | 45.75 | -24.73 | 21.02 | 54.00 | -32.98 |
| 2499.700 | Average | 49.35 | -24.73 | 24.62 | 54.00 | -29.38 |

Unless otherwise stated the results shown in this test report refer only to the sample(s) tested and such sample(s) are retained for 90 days only.

除非另有說明，此報告結果僅對測試之樣品負責，同時此樣品僅保留90天。本報告未經本公司書面許可，不可部份複製。

This document is issued by the Company subject to its General Conditions of Service printed overleaf, available on request or accessible at <http://www.sgs.com.tw/Terms-and-Conditions> and for electronic format documents, subject to Terms and Conditions for Electronic Documents at <http://www.sgs.com.tw/Terms-and-Conditions>. Attention is drawn to the limitation of liability, indemnification and jurisdiction issues defined therein. Any holder of this document is advised that information contained hereon reflects the Company's findings at the time of its intervention only and within the limits of Client's instructions, if any. The Company's sole responsibility is to its Client and this document does not exonerate parties to a transaction from exercising all their rights and obligations under the transaction documents. This document cannot be reproduced except in full, without prior written approval of the Company. Any unauthorized alteration, forgery or falsification of the content or appearance of this document is unlawful and offenders may be prosecuted to the fullest extent of the law.

Report Number :TERF2303000419E2
 Operation Mode :BR HOPPING
 Test Frequency :2480 MHz
 Test Mode :Bandedge
 EUT Pol :E2 Plane

Test Site :SAC D
 Test Date :2023-03-16
 Temp./Humi. :21.0/57
 Antenna Pol. :Horizontal
 Engineer :Howard Huang

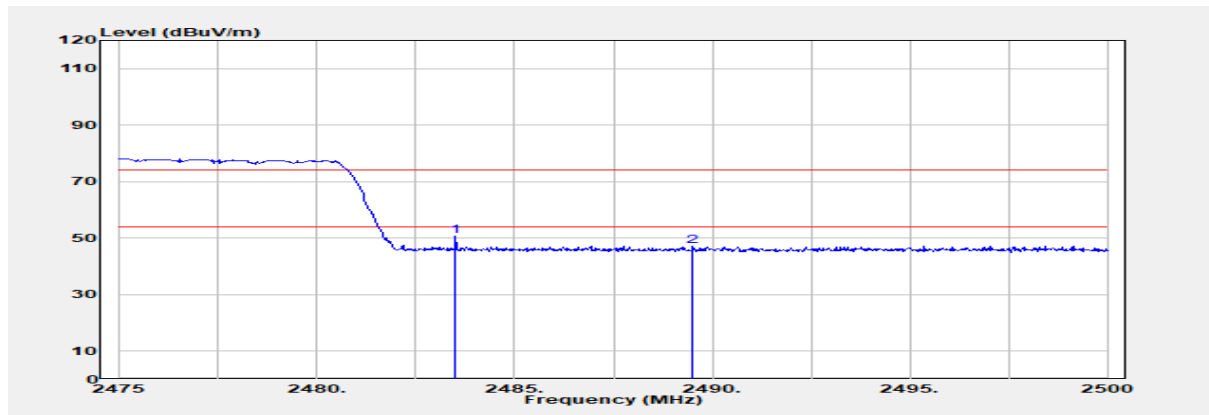

| Freq. MHz | Detector Mode PK/QP/AV | Spectrum Reading Level dB μ V | Factor dB | Actual FS dB μ V/m | Limit @3m dB μ V/m | Margin dB |
|--------------|------------------------------|---|--------------|------------------------------|------------------------------|--------------|
| 2483.500 | Peak | 57.89 | -7.20 | 50.69 | 74.00 | -23.31 |
| 2489.500 | Peak | 54.40 | -7.22 | 47.17 | 74.00 | -26.83 |

| Freq. MHz | Detector Mode AV | Peak Actual FS (dB μ V/m) | Duty Cycle Factor (dB) | Average Value (dBuV/m) | Average Limit@3m (dBuV/m) | Margin (dB) |
|--------------|------------------------|-------------------------------------|------------------------------|------------------------------|---------------------------------|----------------|
| 2483.500 | Average | 50.69 | -24.73 | 25.96 | 54.00 | -28.04 |
| 2489.500 | Average | 47.17 | -24.73 | 22.44 | 54.00 | -31.56 |

Unless otherwise stated the results shown in this test report refer only to the sample(s) tested and such sample(s) are retained for 90 days only.

除非另有說明，此報告結果僅對測試之樣品負責，同時此樣品僅保留90天。本報告未經本公司書面許可，不可部份複製。

This document is issued by the Company subject to its General Conditions of Service printed overleaf, available on request or accessible at <http://www.sgs.com.tw/Terms-and-Conditions> and for electronic format documents, subject to Terms and Conditions for Electronic Documents at <http://www.sgs.com.tw/Terms-and-Conditions>. Attention is drawn to the limitation of liability, indemnification and jurisdiction issues defined therein. Any holder of this document is advised that information contained hereon reflects the Company's findings at the time of its intervention only and within the limits of Client's instructions, if any. The Company's sole responsibility is to its Client and this document does not exonerate parties to a transaction from exercising all their rights and obligations under the transaction documents. This document cannot be reproduced except in full, without prior written approval of the Company. Any unauthorized alteration, forgery or falsification of the content or appearance of this document is unlawful and offenders may be prosecuted to the fullest extent of the law.

Report Number :TERF2303000419E2

Test Site :SAC D

Operation Mode :EDR 2M

Test Date :2023-03-16

Test Frequency :2402 MHz

Temp./Humi. :21.0/57

Test Mode :Bandedge

Antenna Pol. :Vertical

EUT Pol :E2 Plane

Engineer :Howard Huang

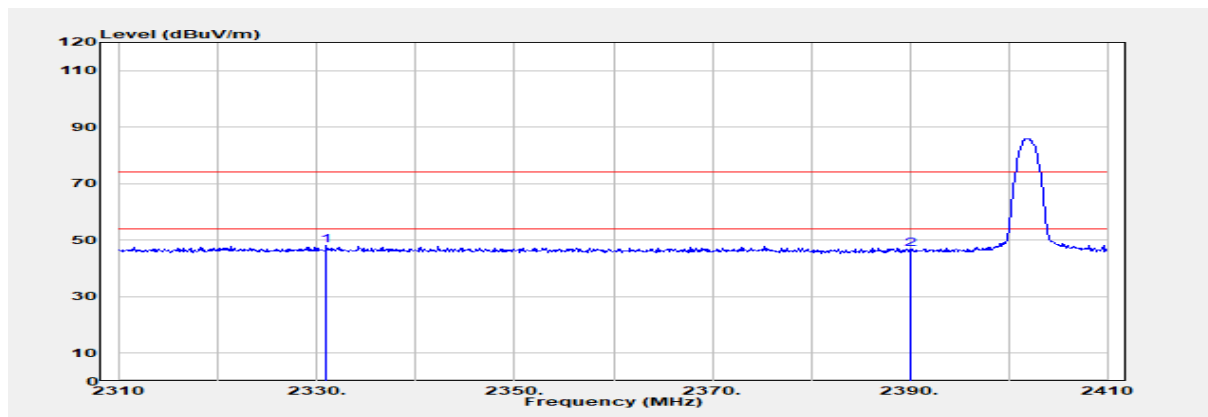

| Freq. MHz | Detector Mode PK/QP/AV | Spectrum Reading Level dB μ V | Factor dB | Actual FS dB μ V/m | Limit @3m dB μ V/m | Margin dB |
|--------------|------------------------------|---|--------------|------------------------------|------------------------------|--------------|
| 2330.900 | Peak | 54.86 | -6.85 | 48.01 | 74.00 | -25.99 |
| 2390.000 | Peak | 53.82 | -7.04 | 46.78 | 74.00 | -27.22 |

| Freq. MHz | Detector Mode AV | Peak Actual FS (dB μ V/m) | Duty Cycle Factor (dB) | Average Value (dBuV/m) | Average Limit@3m (dBuV/m) | Margin (dB) |
|--------------|------------------------|-------------------------------------|------------------------------|------------------------------|---------------------------------|----------------|
| 2330.900 | Average | 48.01 | -24.73 | 23.28 | 54.00 | -30.72 |
| 2390.000 | Average | 46.78 | -24.73 | 22.05 | 54.00 | -31.95 |

Unless otherwise stated the results shown in this test report refer only to the sample(s) tested and such sample(s) are retained for 90 days only.

除非另有說明，此報告結果僅對測試之樣品負責，同時此樣品僅保留90天。本報告未經本公司書面許可，不可部份複製。

This document is issued by the Company subject to its General Conditions of Service printed overleaf, available on request or accessible at <http://www.sgs.com.tw/Terms-and-Conditions> and for electronic format documents, subject to Terms and Conditions for Electronic Documents at <http://www.sgs.com.tw/Terms-and-Conditions>. Attention is drawn to the limitation of liability, indemnification and jurisdiction issues defined therein. Any holder of this document is advised that information contained hereon reflects the Company's findings at the time of its intervention only and within the limits of Client's instructions, if any. The Company's sole responsibility is to its Client and this document does not exonerate parties to a transaction from exercising all their rights and obligations under the transaction documents. This document cannot be reproduced except in full, without prior written approval of the Company. Any unauthorized alteration, forgery or falsification of the content or appearance of this document is unlawful and offenders may be prosecuted to the fullest extent of the law.

Report Number :TERF2303000419E2
 Operation Mode :EDR 2M
 Test Frequency :2402 MHz
 Test Mode :Bandedge
 EUT Pol :E2 Plane

Test Site :SAC D
 Test Date :2023-03-16
 Temp./Humi. :21.0/57
 Antenna Pol. :Horizontal
 Engineer :Howard Huang

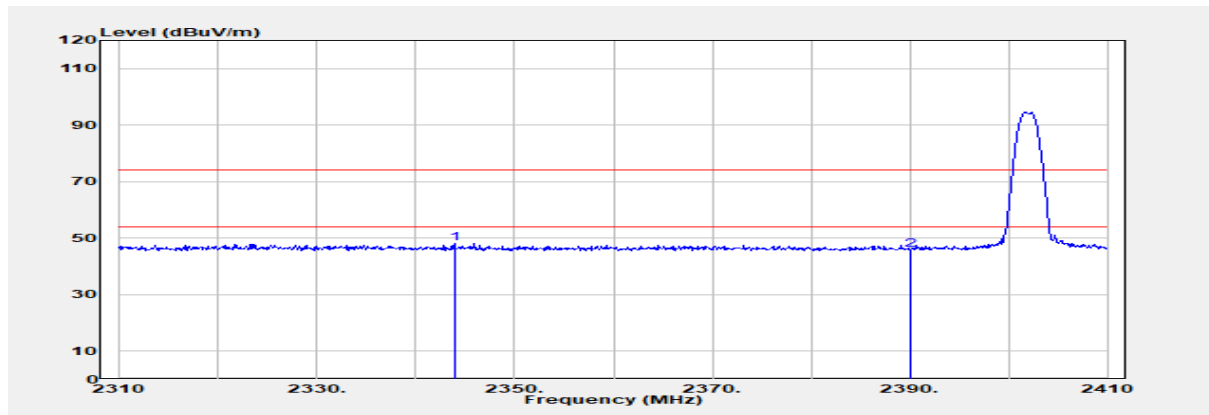

| Freq. MHz | Detector Mode PK/QP/AV | Spectrum Reading Level dB μ V | Factor dB | Actual FS dB μ V/m | Limit @3m dB μ V/m | Margin dB |
|--------------|------------------------------|---|--------------|------------------------------|------------------------------|--------------|
| 2343.900 | Peak | 54.91 | -6.89 | 48.02 | 74.00 | -25.98 |
| 2390.000 | Peak | 52.78 | -7.04 | 45.73 | 74.00 | -28.27 |

| Freq. MHz | Detector Mode AV | Peak Actual FS (dB μ V/m) | Duty Cycle Factor (dB) | Average Value (dBuV/m) | Average Limit@3m (dBuV/m) | Margin (dB) |
|--------------|------------------------|-------------------------------------|------------------------------|------------------------------|---------------------------------|----------------|
| 2343.900 | Average | 48.02 | -24.73 | 23.29 | 54.00 | -30.71 |
| 2390.000 | Average | 45.73 | -24.73 | 21.00 | 54.00 | -33.00 |

Unless otherwise stated the results shown in this test report refer only to the sample(s) tested and such sample(s) are retained for 90 days only.

除非另有說明，此報告結果僅對測試之樣品負責，同時此樣品僅保留90天。本報告未經本公司書面許可，不可部份複製。

This document is issued by the Company subject to its General Conditions of Service printed overleaf, available on request or accessible at <http://www.sgs.com.tw/Terms-and-Conditions> and for electronic format documents, subject to Terms and Conditions for Electronic Documents at <http://www.sgs.com.tw/Terms-and-Conditions>. Attention is drawn to the limitation of liability, indemnification and jurisdiction issues defined therein. Any holder of this document is advised that information contained hereon reflects the Company's findings at the time of its intervention only and within the limits of Client's instructions, if any. The Company's sole responsibility is to its Client and this document does not exonerate parties to a transaction from exercising all their rights and obligations under the transaction documents. This document cannot be reproduced except in full, without prior written approval of the Company. Any unauthorized alteration, forgery or falsification of the content or appearance of this document is unlawful and offenders may be prosecuted to the fullest extent of the law.

Report Number :TERF2303000419E2

Test Site :SAC D

Operation Mode :EDR 2M

Test Date :2023-03-16

Test Frequency :2480 MHz

Temp./Humi. :21.0/57

Test Mode :Bandedge

Antenna Pol. :Vertical

EUT Pol :E2 Plane

Engineer :Howard Huang

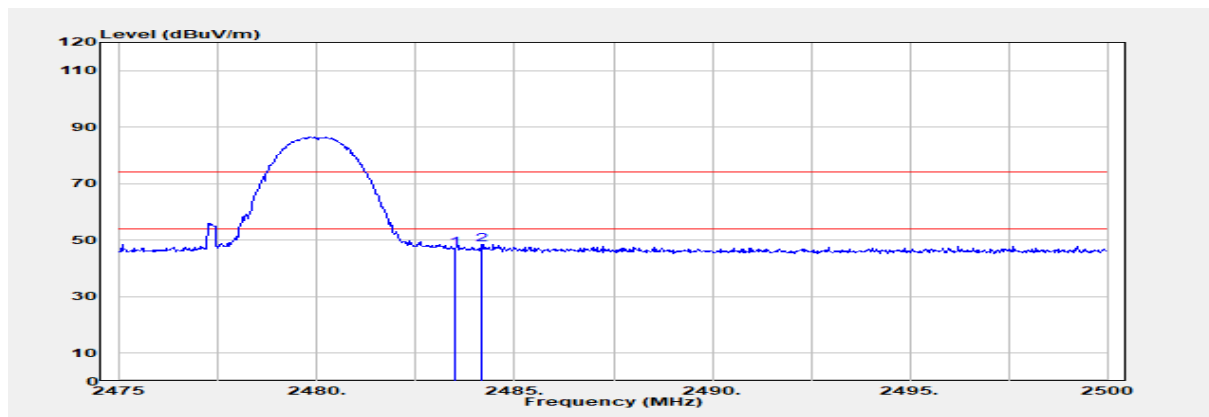

| Freq. MHz | Detector Mode PK/QP/AV | Spectrum Reading Level dB μ V | Factor dB | Actual FS dB μ V/m | Limit @3m dB μ V/m | Margin dB |
|--------------|------------------------------|---|--------------|------------------------------|------------------------------|--------------|
|--------------|------------------------------|---|--------------|------------------------------|------------------------------|--------------|

| | | | | | | |
|----------|------|-------|-------|-------|-------|--------|
| 2483.500 | Peak | 54.34 | -7.20 | 47.14 | 74.00 | -26.86 |
| 2484.175 | Peak | 55.79 | -7.20 | 48.59 | 74.00 | -25.41 |

| Freq. MHz | Detector Mode AV | Peak Actual FS (dB μ V/m) | Duty Cycle Factor (dB) | Average Value (dBuV/m) | Average Limit@3m (dBuV/m) | Margin (dB) |
|--------------|------------------------|-------------------------------------|------------------------------|------------------------------|---------------------------------|----------------|
|--------------|------------------------|-------------------------------------|------------------------------|------------------------------|---------------------------------|----------------|

| | | | | | | |
|----------|---------|-------|--------|-------|-------|--------|
| 2483.500 | Average | 47.14 | -24.73 | 22.41 | 54.00 | -31.59 |
| 2484.175 | Average | 48.59 | -24.73 | 23.86 | 54.00 | -30.14 |

Unless otherwise stated the results shown in this test report refer only to the sample(s) tested and such sample(s) are retained for 90 days only.

除非另有說明，此報告結果僅對測試之樣品負責，同時此樣品僅保留90天。本報告未經本公司書面許可，不可部份複製。

This document is issued by the Company subject to its General Conditions of Service printed overleaf, available on request or accessible at <http://www.sgs.com.tw/Terms-and-Conditions> and for electronic format documents, subject to Terms and Conditions for Electronic Documents at <http://www.sgs.com.tw/Terms-and-Conditions>. Attention is drawn to the limitation of liability, indemnification and jurisdiction issues defined therein. Any holder of this document is advised that information contained hereon reflects the Company's findings at the time of its intervention only and within the limits of Client's instructions, if any. The Company's sole responsibility is to its Client and this document does not exonerate parties to a transaction from exercising all their rights and obligations under the transaction documents. This document cannot be reproduced except in full, without prior written approval of the Company. Any unauthorized alteration, forgery or falsification of the content or appearance of this document is unlawful and offenders may be prosecuted to the fullest extent of the law.

Report Number :TERF2303000419E2

Test Site :SAC D

Operation Mode :EDR 2M

Test Date :2023-03-16

Test Frequency :2480 MHz

Temp./Humi. :21.0/57

Test Mode :Bandedge

Antenna Pol. :Horizontal

EUT Pol :E2 Plane

Engineer :Howard Huang

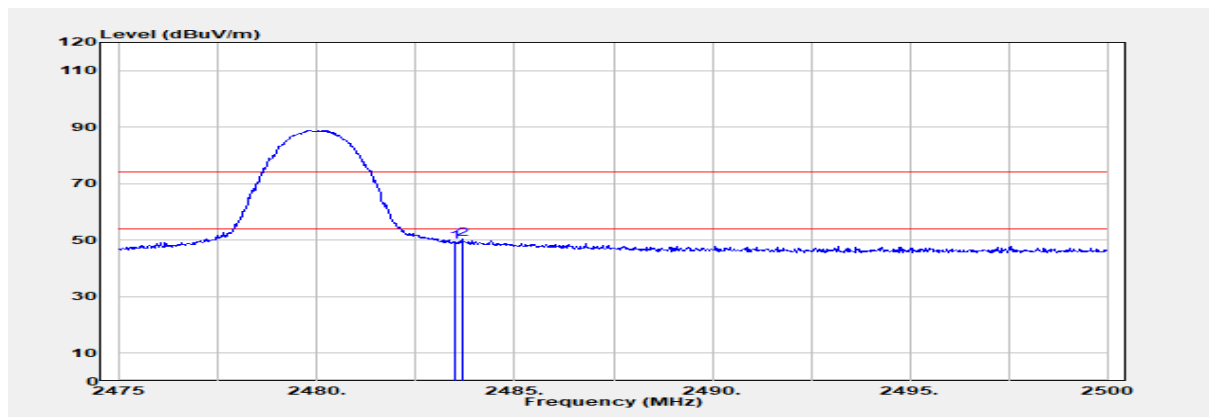

| Freq. MHz | Detector Mode PK/QP/AV | Spectrum Reading Level dB μ V | Factor dB | Actual FS dB μ V/m | Limit @3m dB μ V/m | Margin dB |
|--------------|------------------------------|---|--------------|------------------------------|------------------------------|--------------|
|--------------|------------------------------|---|--------------|------------------------------|------------------------------|--------------|

| | | | | | | |
|----------|------|-------|-------|-------|-------|--------|
| 2483.500 | Peak | 56.72 | -7.20 | 49.52 | 74.00 | -24.48 |
| 2483.675 | Peak | 57.46 | -7.20 | 50.27 | 74.00 | -23.73 |

| Freq. MHz | Detector Mode AV | Peak Actual FS (dB μ V/m) | Duty Cycle Factor (dB) | Average Value (dBuV/m) | Average Limit@3m (dBuV/m) | Margin (dB) |
|--------------|------------------------|-------------------------------------|------------------------------|------------------------------|---------------------------------|----------------|
|--------------|------------------------|-------------------------------------|------------------------------|------------------------------|---------------------------------|----------------|

| | | | | | | |
|----------|---------|-------|--------|-------|-------|--------|
| 2483.500 | Average | 49.52 | -24.73 | 24.79 | 54.00 | -29.21 |
| 2483.675 | Average | 50.27 | -24.73 | 25.54 | 54.00 | -28.46 |

Unless otherwise stated the results shown in this test report refer only to the sample(s) tested and such sample(s) are retained for 90 days only.

除非另有說明，此報告結果僅對測試之樣品負責，同時此樣品僅保留90天。本報告未經本公司書面許可，不可部份複製。

This document is issued by the Company subject to its General Conditions of Service printed overleaf, available on request or accessible at <http://www.sgs.com.tw/Terms-and-Conditions> and for electronic format documents, subject to Terms and Conditions for Electronic Documents at <http://www.sgs.com.tw/Terms-and-Conditions>. Attention is drawn to the limitation of liability, indemnification and jurisdiction issues defined therein. Any holder of this document is advised that information contained hereon reflects the Company's findings at the time of its intervention only and within the limits of Client's instructions, if any. The Company's sole responsibility is to its Client and this document does not exonerate parties to a transaction from exercising all their rights and obligations under the transaction documents. This document cannot be reproduced except in full, without prior written approval of the Company. Any unauthorized alteration, forgery or falsification of the content or appearance of this document is unlawful and offenders may be prosecuted to the fullest extent of the law.

Report Number :TERF2303000419E2
 Operation Mode :EDR 2M HOPPING
 Test Frequency :2402 MHz
 Test Mode :Bandedge
 EUT Pol :E2 Plane

Test Site :SAC D
 Test Date :2023-03-16
 Temp./Humi. :21.0/57
 Antenna Pol. :Vertical
 Engineer :Howard Huang

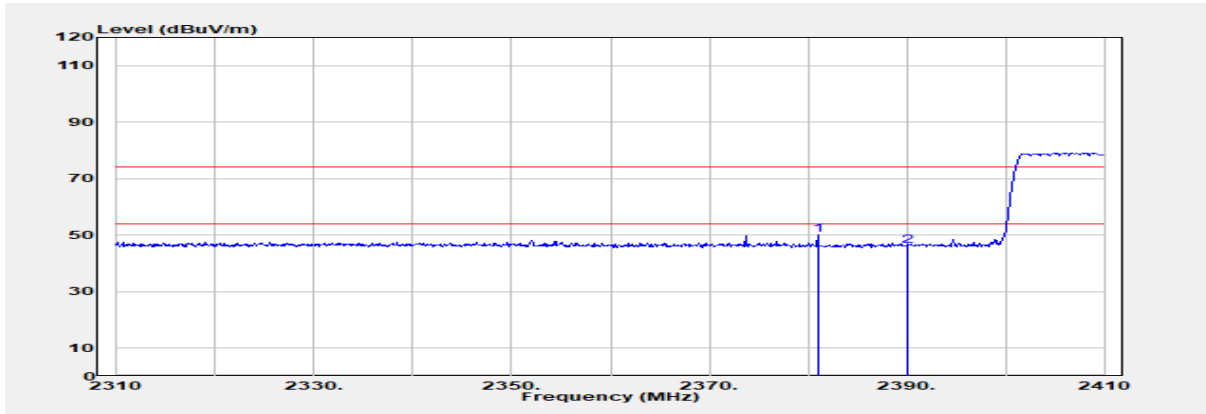

| Freq. MHz | Detector Mode PK/QP/AV | Spectrum Reading Level dB μ V | Factor dB | Actual FS dB μ V/m | Limit @3m dB μ V/m | Margin dB |
|--------------|------------------------------|---|--------------|------------------------------|------------------------------|--------------|
| 2381.000 | Peak | 57.18 | -7.01 | 50.17 | 74.00 | -23.83 |
| 2390.000 | Peak | 53.34 | -7.04 | 46.30 | 74.00 | -27.70 |

| Freq. MHz | Detector Mode AV | Peak Actual FS (dB μ V/m) | Duty Cycle Factor (dB) | Average Value (dBuV/m) | Average Limit@3m (dBuV/m) | Margin (dB) |
|--------------|------------------------|-------------------------------------|------------------------------|------------------------------|---------------------------------|----------------|
| 2381.000 | Average | 50.17 | -24.73 | 25.44 | 54.00 | -28.56 |
| 2390.000 | Average | 46.30 | -24.73 | 21.57 | 54.00 | -32.43 |

Unless otherwise stated the results shown in this test report refer only to the sample(s) tested and such sample(s) are retained for 90 days only.

除非另有說明，此報告結果僅對測試之樣品負責，同時此樣品僅保留90天。本報告未經本公司書面許可，不可部份複製。
 This document is issued by the Company subject to its General Conditions of Service printed overleaf, available on request or accessible at <http://www.sgs.com.tw/Terms-and-Conditions> and for electronic format documents, subject to Terms and Conditions for Electronic Documents at <http://www.sgs.com.tw/Terms-and-Conditions>. Attention is drawn to the limitation of liability, indemnification and jurisdiction issues defined therein. Any holder of this document is advised that information contained hereon reflects the Company's findings at the time of its intervention only and within the limits of Client's instructions, if any. The Company's sole responsibility is to its Client and this document does not exonerate parties to a transaction from exercising all their rights and obligations under the transaction documents. This document cannot be reproduced except in full, without prior written approval of the Company. Any unauthorized alteration, forgery or falsification of the content or appearance of this document is unlawful and offenders may be prosecuted to the fullest extent of the law.

Report Number :TERF2303000419E2
 Operation Mode :EDR 2M HOPPING
 Test Frequency :2402 MHz
 Test Mode :Bandedge
 EUT Pol :E2 Plane

Test Site :SAC D
 Test Date :2023-03-16
 Temp./Humi. :21.0/57
 Antenna Pol. :Horizontal
 Engineer :Howard Huang

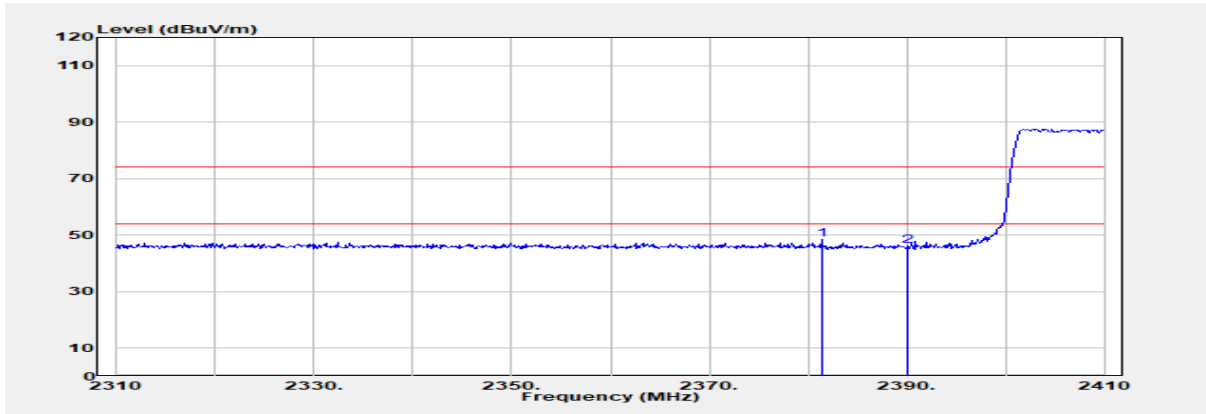

| Freq. MHz | Detector Mode PK/QP/AV | Spectrum Reading Level dB μ V | Factor dB | Actual FS dB μ V/m | Limit @3m dB μ V/m | Margin dB |
|--------------|------------------------------|---|--------------|------------------------------|------------------------------|--------------|
| 2381.400 | Peak | 55.47 | -7.02 | 48.45 | 74.00 | -25.55 |
| 2390.000 | Peak | 53.14 | -7.04 | 46.09 | 74.00 | -27.91 |

| Freq. MHz | Detector Mode AV | Peak Actual FS (dB μ V/m) | Duty Cycle Factor (dB) | Average Value (dBuV/m) | Average Limit@3m (dBuV/m) | Margin (dB) |
|--------------|------------------------|-------------------------------------|------------------------------|------------------------------|---------------------------------|----------------|
| 2381.400 | Average | 48.45 | -24.73 | 23.72 | 54.00 | -30.28 |
| 2390.000 | Average | 46.09 | -24.73 | 21.36 | 54.00 | -32.64 |

Unless otherwise stated the results shown in this test report refer only to the sample(s) tested and such sample(s) are retained for 90 days only.

除非另有說明，此報告結果僅對測試之樣品負責，同時此樣品僅保留90天。本報告未經本公司書面許可，不可部份複製。

This document is issued by the Company subject to its General Conditions of Service printed overleaf, available on request or accessible at <http://www.sgs.com.tw/Terms-and-Conditions> and for electronic format documents, subject to Terms and Conditions for Electronic Documents at <http://www.sgs.com.tw/Terms-and-Conditions>. Attention is drawn to the limitation of liability, indemnification and jurisdiction issues defined therein. Any holder of this document is advised that information contained hereon reflects the Company's findings at the time of its intervention only and within the limits of Client's instructions, if any. The Company's sole responsibility is to its Client and this document does not exonerate parties to a transaction from exercising all their rights and obligations under the transaction documents. This document cannot be reproduced except in full, without prior written approval of the Company. Any unauthorized alteration, forgery or falsification of the content or appearance of this document is unlawful and offenders may be prosecuted to the fullest extent of the law.

Report Number :TERF2303000419E2
 Operation Mode :EDR 2M HOPPING
 Test Frequency :2480 MHz
 Test Mode :Bandedge
 EUT Pol :E2 Plane

Test Site :SAC D
 Test Date :2023-03-16
 Temp./Humi. :21.0/57
 Antenna Pol. :Vertical
 Engineer :Howard Huang

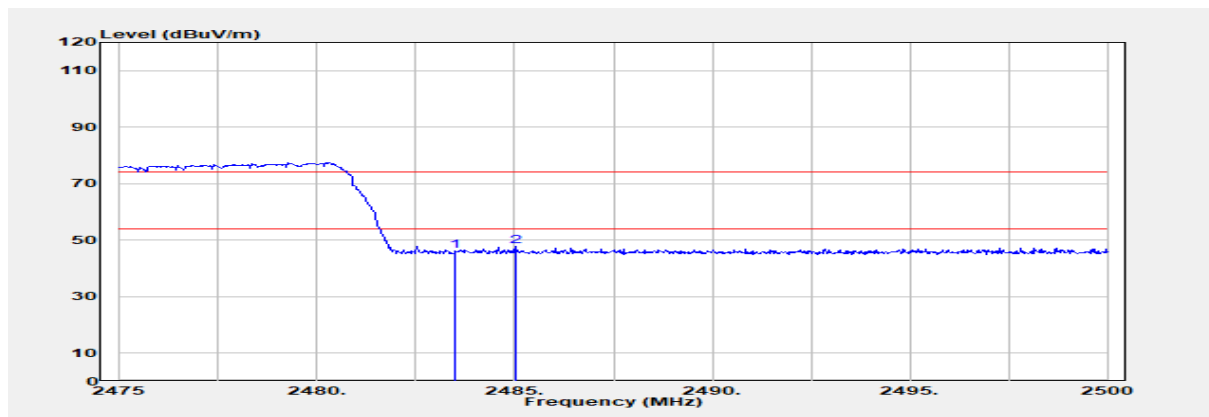

| Freq. MHz | Detector Mode PK/QP/AV | Spectrum Reading Level dB μ V | Factor dB | Actual FS dB μ V/m | Limit @3m dB μ V/m | Margin dB |
|--------------|------------------------------|---|--------------|------------------------------|------------------------------|--------------|
| 2483.500 | Peak | 53.26 | -7.20 | 46.06 | 74.00 | -27.94 |
| 2485.025 | Peak | 55.03 | -7.20 | 47.83 | 74.00 | -26.17 |

| Freq. MHz | Detector Mode AV | Peak Actual FS (dB μ V/m) | Duty Cycle Factor (dB) | Average Value (dBuV/m) | Average Limit@3m (dBuV/m) | Margin (dB) |
|--------------|------------------------|-------------------------------------|------------------------------|------------------------------|---------------------------------|----------------|
| 2483.500 | Average | 46.06 | -24.73 | 21.33 | 54.00 | -32.67 |
| 2485.025 | Average | 47.83 | -24.73 | 23.10 | 54.00 | -30.90 |

Unless otherwise stated the results shown in this test report refer only to the sample(s) tested and such sample(s) are retained for 90 days only.

除非另有說明，此報告結果僅對測試之樣品負責，同時此樣品僅保留90天。本報告未經本公司書面許可，不可部份複製。

This document is issued by the Company subject to its General Conditions of Service printed overleaf, available on request or accessible at <http://www.sgs.com.tw/Terms-and-Conditions> and for electronic format documents, subject to Terms and Conditions for Electronic Documents at <http://www.sgs.com.tw/Terms-and-Conditions>. Attention is drawn to the limitation of liability, indemnification and jurisdiction issues defined therein. Any holder of this document is advised that information contained hereon reflects the Company's findings at the time of its intervention only and within the limits of Client's instructions, if any. The Company's sole responsibility is to its Client and this document does not exonerate parties to a transaction from exercising all their rights and obligations under the transaction documents. This document cannot be reproduced except in full, without prior written approval of the Company. Any unauthorized alteration, forgery or falsification of the content or appearance of this document is unlawful and offenders may be prosecuted to the fullest extent of the law.

Report Number :TERF2303000419E2
 Operation Mode :EDR 2M HOPPING
 Test Frequency :2480 MHz
 Test Mode :Bandedge
 EUT Pol :E2 Plane

Test Site :SAC D
 Test Date :2023-03-16
 Temp./Humi. :21.0/57
 Antenna Pol. :Horizontal
 Engineer :Howard Huang

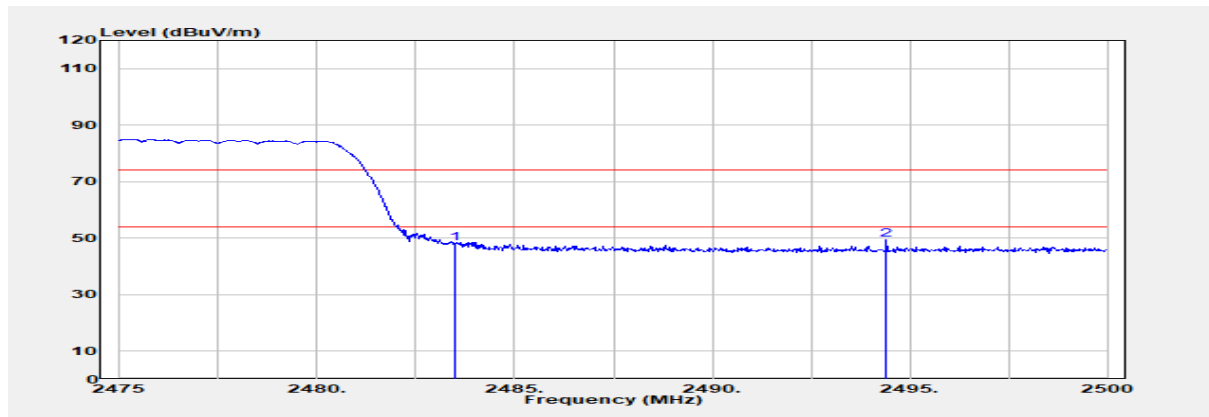

| Freq. MHz | Detector Mode PK/QP/AV | Spectrum Reading Level dB μ V | Factor dB | Actual FS dB μ V/m | Limit @3m dB μ V/m | Margin dB |
|--------------|------------------------------|---|--------------|------------------------------|------------------------------|--------------|
| 2483.500 | Peak | 55.48 | -7.20 | 48.29 | 74.00 | -25.71 |
| 2494.400 | Peak | 56.61 | -7.24 | 49.36 | 74.00 | -24.64 |

| Freq. MHz | Detector Mode AV | Peak Actual FS (dB μ V/m) | Duty Cycle Factor (dB) | Average Value (dBuV/m) | Average Limit@3m (dBuV/m) | Margin (dB) |
|--------------|------------------------|-------------------------------------|------------------------------|------------------------------|---------------------------------|----------------|
| 2483.500 | Average | 48.29 | -24.73 | 23.56 | 54.00 | -30.44 |
| 2494.400 | Average | 49.36 | -24.73 | 24.63 | 54.00 | -29.37 |

Unless otherwise stated the results shown in this test report refer only to the sample(s) tested and such sample(s) are retained for 90 days only.

除非另有說明，此報告結果僅對測試之樣品負責，同時此樣品僅保留90天。本報告未經本公司書面許可，不可部份複製。

This document is issued by the Company subject to its General Conditions of Service printed overleaf, available on request or accessible at <http://www.sgs.com.tw/Terms-and-Conditions> and for electronic format documents, subject to Terms and Conditions for Electronic Documents at <http://www.sgs.com.tw/Terms-and-Conditions>. Attention is drawn to the limitation of liability, indemnification and jurisdiction issues defined therein. Any holder of this document is advised that information contained hereon reflects the Company's findings at the time of its intervention only and within the limits of Client's instructions, if any. The Company's sole responsibility is to its Client and this document does not exonerate parties to a transaction from exercising all their rights and obligations under the transaction documents. This document cannot be reproduced except in full, without prior written approval of the Company. Any unauthorized alteration, forgery or falsification of the content or appearance of this document is unlawful and offenders may be prosecuted to the fullest extent of the law.

11.6.4 Radiated Spurious Emission

Report Number :TERF2303000419E2

Test Site :SAC D

Operation Mode :BR

Test Date :2023-03-16

Test Frequency :2441 MHz

Temp./Humi. :21.3/56

Test Mode :Tx

Antenna Pol. :Vertical

EUT Pol :E2 Plane

Engineer :Howard Huang

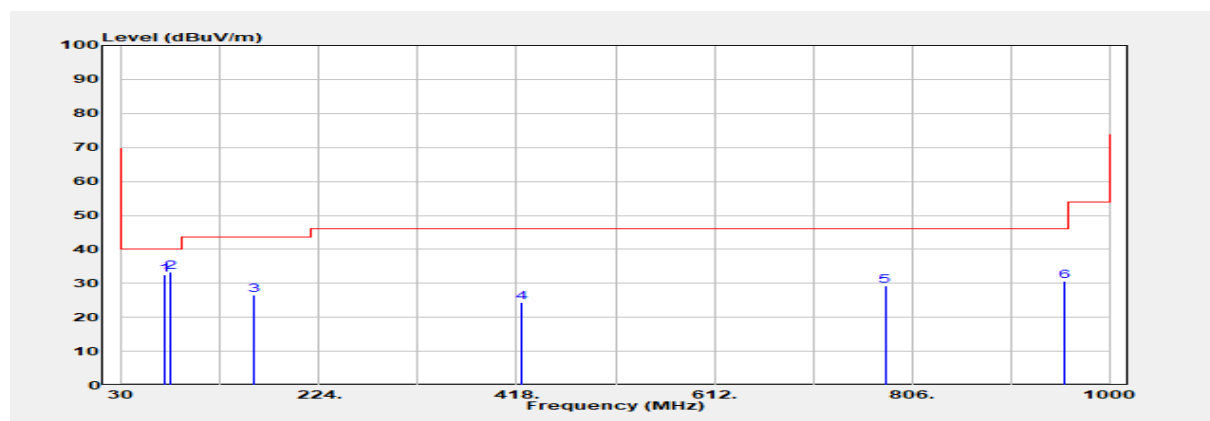

| Freq. MHz | Detector Mode PK/QP/AV | Spectrum Reading Level dB μ V | Factor dB | Actual FS dB μ V/m | Limit @3m dB μ V/m | Margin dB |
|--------------|------------------------------|---|--------------|------------------------------|------------------------------|--------------|
| 71.710 | Peak | 52.15 | -19.74 | 32.40 | 40.00 | -7.60 |
| 78.500 | Peak | 54.89 | -21.66 | 33.23 | 40.00 | -6.77 |
| 159.010 | Peak | 42.68 | -16.11 | 26.56 | 43.50 | -16.94 |
| 422.850 | Peak | 37.35 | -13.06 | 24.30 | 46.00 | -21.70 |
| 779.810 | Peak | 36.23 | -6.96 | 29.27 | 46.00 | -16.73 |
| 956.350 | Peak | 35.09 | -4.46 | 30.63 | 46.00 | -15.37 |

Unless otherwise stated the results shown in this test report refer only to the sample(s) tested and such sample(s) are retained for 90 days only.
 除非另有說明，此報告結果僅對測試之樣品負責，同時此樣品僅保留90天。本報告未經本公司書面許可，不可部份複製。

This document is issued by the Company subject to its General Conditions of Service printed overleaf, available on request or accessible at <http://www.sgs.com.tw/Terms-and-Conditions> and for electronic format documents, subject to Terms and Conditions for Electronic Documents at <http://www.sgs.com.tw/Terms-and-Conditions>. Attention is drawn to the limitation of liability, indemnification and jurisdiction issues defined therein. Any holder of this document is advised that information contained hereon reflects the Company's findings at the time of its intervention only and within the limits of Client's instructions, if any. The Company's sole responsibility is to its Client and this document does not exonerate parties to a transaction from exercising all their rights and obligations under the transaction documents. This document cannot be reproduced except in full, without prior written approval of the Company. Any unauthorized alteration, forgery or falsification of the content or appearance of this document is unlawful and offenders may be prosecuted to the fullest extent of the law.

Report Number :TERF2303000419E2
 Operation Mode :BR
 Test Frequency :2441 MHz
 Test Mode :Tx
 EUT Pol :E2 Plane

Test Site :SAC D
 Test Date :2023-03-16
 Temp./Humi. :21.3/56
 Antenna Pol. :Horizontal
 Engineer :Howard Huang

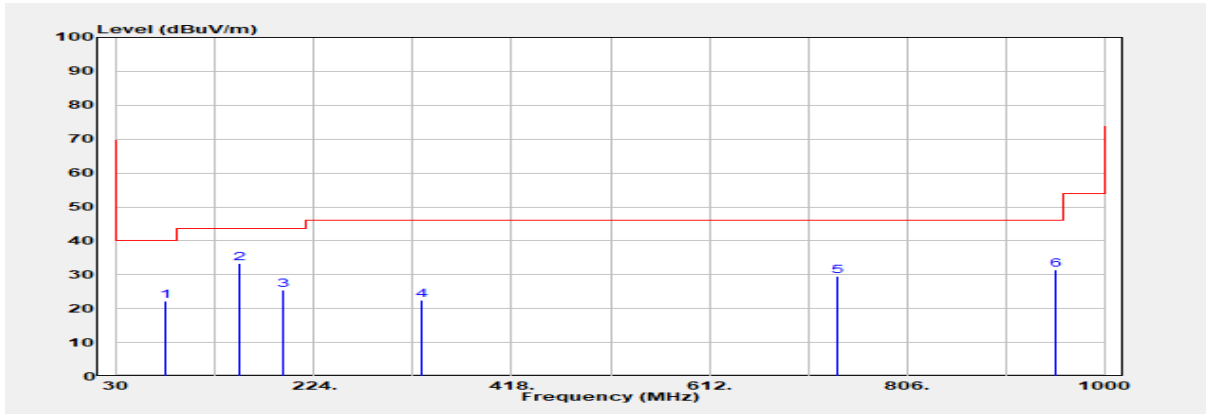

| Freq. MHz | Detector Mode PK/QP/AV | Spectrum Reading Level dB μ V | Factor dB | Actual FS dB μ V/m | Limit @3m dB μ V/m | Margin dB |
|--------------|------------------------------|---|--------------|------------------------------|------------------------------|--------------|
| 78.500 | Peak | 43.81 | -21.66 | 22.15 | 40.00 | -17.85 |
| 151.250 | Peak | 49.88 | -16.44 | 33.44 | 43.50 | -10.06 |
| 192.960 | Peak | 44.85 | -19.40 | 25.45 | 43.50 | -18.05 |
| 329.730 | Peak | 37.57 | -15.05 | 22.52 | 46.00 | -23.48 |
| 737.130 | Peak | 36.28 | -6.83 | 29.45 | 46.00 | -16.55 |
| 951.500 | Peak | 35.85 | -4.47 | 31.39 | 46.00 | -14.61 |

Unless otherwise stated the results shown in this test report refer only to the sample(s) tested and such sample(s) are retained for 90 days only.

除非另有說明，此報告結果僅對測試之樣品負責，同時此樣品僅保留90天。本報告未經本公司書面許可，不可部份複製。
 This document is issued by the Company subject to its General Conditions of Service printed overleaf, available on request or accessible at <http://www.sgs.com.tw/Terms-and-Conditions> and for electronic format documents, subject to Terms and Conditions for Electronic Documents at <http://www.sgs.com.tw/Terms-and-Conditions>. Attention is drawn to the limitation of liability, indemnification and jurisdiction issues defined therein. Any holder of this document is advised that information contained hereon reflects the Company's findings at the time of its intervention only and within the limits of Client's instructions, if any. The Company's sole responsibility is to its Client and this document does not exonerate parties to a transaction from exercising all their rights and obligations under the transaction documents. This document cannot be reproduced except in full, without prior written approval of the Company. Any unauthorized alteration, forgery or falsification of the content or appearance of this document is unlawful and offenders may be prosecuted to the fullest extent of the law.

Report Number :TERF2303000419E2
 Operation Mode :EDR 2M
 Test Frequency :2441 MHz
 Test Mode :Tx
 EUT Pol :E2 Plane

Test Site :SAC D
 Test Date :2023-03-16
 Temp./Humi. :21.3/56
 Antenna Pol. :Vertical
 Engineer :Howard Huang

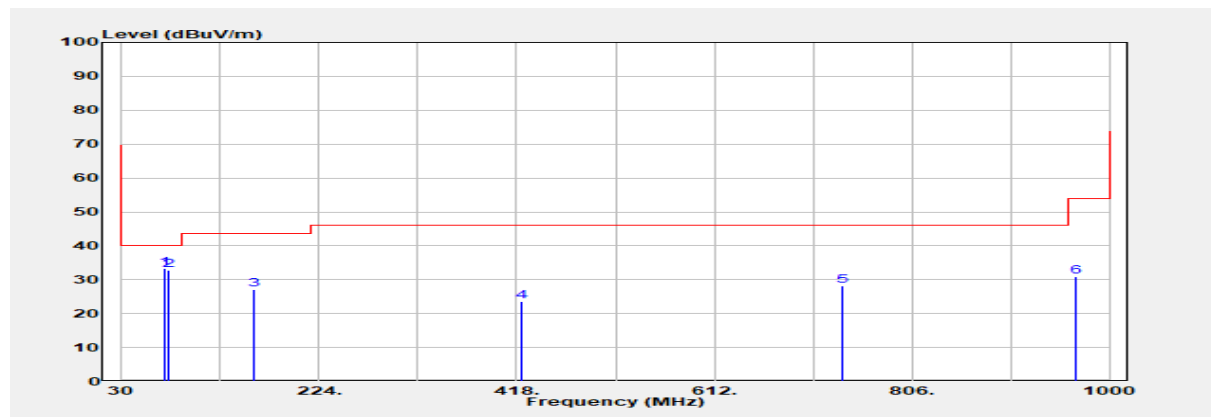

| Freq. MHz | Detector Mode PK/QP/AV | Spectrum Reading Level dB μ V | Factor dB | Actual FS dB μ V/m | Limit @3m dB μ V/m | Margin dB |
|--------------|------------------------------|---|--------------|------------------------------|------------------------------|--------------|
| 71.710 | Peak | 53.12 | -19.74 | 33.38 | 40.00 | -6.62 |
| 76.560 | Peak | 53.82 | -21.10 | 32.73 | 40.00 | -7.27 |
| 159.010 | Peak | 43.34 | -16.11 | 27.23 | 43.50 | -16.27 |
| 422.850 | Peak | 36.59 | -13.06 | 23.54 | 46.00 | -22.46 |
| 738.100 | Peak | 34.95 | -6.80 | 28.15 | 46.00 | -17.85 |
| 967.020 | Peak | 35.20 | -4.21 | 30.99 | 54.00 | -23.01 |

Unless otherwise stated the results shown in this test report refer only to the sample(s) tested and such sample(s) are retained for 90 days only.

除非另有說明，此報告結果僅對測試之樣品負責，同時此樣品僅保留90天。本報告未經本公司書面許可，不可部份複製。

This document is issued by the Company subject to its General Conditions of Service printed overleaf, available on request or accessible at <http://www.sgs.com.tw/Terms-and-Conditions> and for electronic format documents, subject to Terms and Conditions for Electronic Documents at <http://www.sgs.com.tw/Terms-and-Conditions>. Attention is drawn to the limitation of liability, indemnification and jurisdiction issues defined therein. Any holder of this document is advised that information contained hereon reflects the Company's findings at the time of its intervention only and within the limits of Client's instructions, if any. The Company's sole responsibility is to its Client and this document does not exonerate parties to a transaction from exercising all their rights and obligations under the transaction documents. This document cannot be reproduced except in full, without prior written approval of the Company. Any unauthorized alteration, forgery or falsification of the content or appearance of this document is unlawful and offenders may be prosecuted to the fullest extent of the law.

Report Number :TERF2303000419E2
 Operation Mode :EDR 2M
 Test Frequency :2441 MHz
 Test Mode :Tx
 EUT Pol :E2 Plane

Test Site :SAC D
 Test Date :2023-03-16
 Temp./Humi. :21.3/56
 Antenna Pol. :Horizontal
 Engineer :Howard Huang

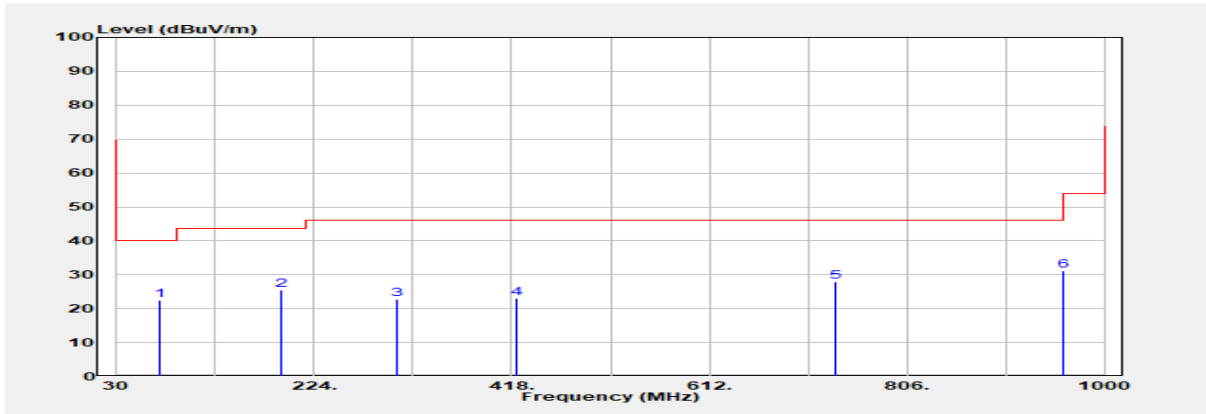

| Freq. MHz | Detector Mode PK/QP/AV | Spectrum Reading Level dB μ V | Factor dB | Actual FS dB μ V/m | Limit @3m dB μ V/m | Margin dB |
|--------------|------------------------------|---|--------------|------------------------------|------------------------------|--------------|
| 71.710 | Peak | 42.15 | -19.74 | 22.41 | 40.00 | -17.59 |
| 191.990 | Peak | 44.66 | -19.29 | 25.37 | 43.50 | -18.13 |
| 304.510 | Peak | 38.75 | -16.01 | 22.74 | 46.00 | -23.26 |
| 422.850 | Peak | 36.01 | -13.06 | 22.96 | 46.00 | -23.04 |
| 736.160 | Peak | 34.70 | -6.85 | 27.85 | 46.00 | -18.15 |
| 959.260 | Peak | 35.51 | -4.43 | 31.08 | 46.00 | -14.92 |

Unless otherwise stated the results shown in this test report refer only to the sample(s) tested and such sample(s) are retained for 90 days only.

除非另有說明，此報告結果僅對測試之樣品負責，同時此樣品僅保留90天。本報告未經本公司書面許可，不可部份複製。
 This document is issued by the Company subject to its General Conditions of Service printed overleaf, available on request or accessible at <http://www.sgs.com.tw/Terms-and-Conditions> and for electronic format documents, subject to Terms and Conditions for Electronic Documents at <http://www.sgs.com.tw/Terms-and-Conditions>. Attention is drawn to the limitation of liability, indemnification and jurisdiction issues defined therein. Any holder of this document is advised that information contained hereon reflects the Company's findings at the time of its intervention only and within the limits of Client's instructions, if any. The Company's sole responsibility is to its Client and this document does not exonerate parties to a transaction from exercising all their rights and obligations under the transaction documents. This document cannot be reproduced except in full, without prior written approval of the Company. Any unauthorized alteration, forgery or falsification of the content or appearance of this document is unlawful and offenders may be prosecuted to the fullest extent of the law.

Report Number :TERF2303000419E2

Test Site :SAC D

Operation Mode :BR

Test Date :2023-03-16

Test Frequency :2402 MHz

Temp./Humi. :21.3/56

Test Mode :Tx

Antenna Pol. :Vertical

EUT Pol :E2 Plane

Engineer :Howard Huang

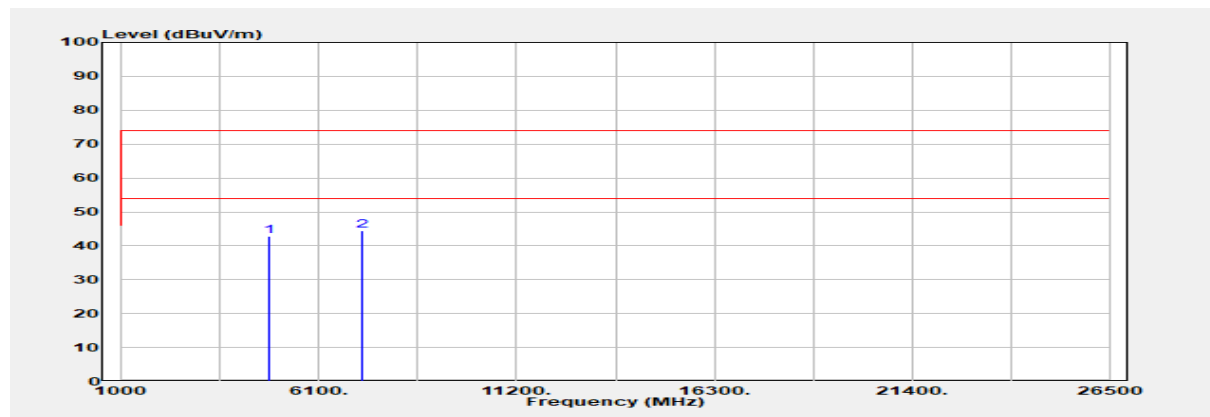

| Freq. MHz | Detector Mode PK/QP/AV | Spectrum Reading Level dB μ V | Factor dB | Actual FS dB μ V/m | Limit @3m dB μ V/m | Margin dB |
|--------------|------------------------------|---|--------------|------------------------------|------------------------------|--------------|
| 4804.000 | Peak | 44.76 | -2.06 | 42.70 | 74.00 | -31.30 |
| 7206.000 | Peak | 40.24 | 4.26 | 44.49 | 74.00 | -29.51 |

| Freq. MHz | Detector Mode AV | Peak Actual FS (dB μ V/m) | Duty Cycle Factor (dB) | Average Value (dBuV/m) | Average Limit@3m (dBuV/m) | Margin (dB) |
|--------------|------------------------|-------------------------------------|------------------------------|------------------------------|---------------------------------|----------------|
| 4804.000 | Average | 42.70 | -24.73 | 17.97 | 54.00 | -36.03 |
| 7206.000 | Average | 44.49 | -24.73 | 19.76 | 54.00 | -34.24 |

Unless otherwise stated the results shown in this test report refer only to the sample(s) tested and such sample(s) are retained for 90 days only.

除非另有說明，此報告結果僅對測試之樣品負責，同時此樣品僅保留90天。本報告未經本公司書面許可，不可部份複製。
This document is issued by the Company subject to its General Conditions of Service printed overleaf, available on request or accessible at <http://www.sgs.com.tw/Terms-and-Conditions> and for electronic format documents, subject to Terms and Conditions for Electronic Documents at <http://www.sgs.com.tw/Terms-and-Conditions>. Attention is drawn to the limitation of liability, indemnification and jurisdiction issues defined therein. Any holder of this document is advised that information contained hereon reflects the Company's findings at the time of its intervention only and within the limits of Client's instructions, if any. The Company's sole responsibility is to its Client and this document does not exonerate parties to a transaction from exercising all their rights and obligations under the transaction documents. This document cannot be reproduced except in full, without prior written approval of the Company. Any unauthorized alteration, forgery or falsification of the content or appearance of this document is unlawful and offenders may be prosecuted to the fullest extent of the law.

Report Number :TERF2303000419E2
 Operation Mode :BR
 Test Frequency :2402 MHz
 Test Mode :Tx
 EUT Pol :E2 Plane

Test Site :SAC D
 Test Date :2023-03-16
 Temp./Humi. :21.3/56
 Antenna Pol. :Horizontal
 Engineer :Howard Huang

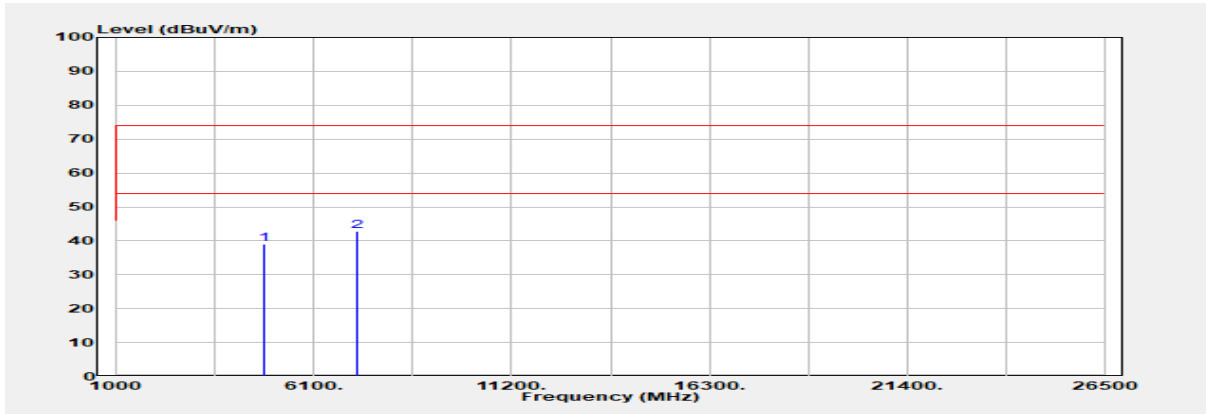

| Freq. MHz | Detector Mode PK/QP/AV | Spectrum Reading Level dB μ V | Factor dB | Actual FS dB μ V/m | Limit @3m dB μ V/m | Margin dB |
|--------------|------------------------------|---|------------------------------|------------------------------|---------------------------------|----------------|
| 4804.000 | Peak | 41.08 | -2.06 | 39.02 | 74.00 | -34.98 |
| 7206.000 | Peak | 38.54 | 4.26 | 42.79 | 74.00 | -31.21 |
| Freq. MHz | Detector Mode AV | Peak Actual FS (dB μ V/m) | Duty Cycle Factor (dB) | Average Value (dBuV/m) | Average Limit@3m (dBuV/m) | Margin (dB) |
| 4804.000 | Average | 39.02 | -24.73 | 14.29 | 54.00 | -39.71 |
| 7206.000 | Average | 42.79 | -24.73 | 18.06 | 54.00 | -35.94 |

Unless otherwise stated the results shown in this test report refer only to the sample(s) tested and such sample(s) are retained for 90 days only.

除非另有說明，此報告結果僅對測試之樣品負責，同時此樣品僅保留90天。本報告未經本公司書面許可，不可部份複製。
 This document is issued by the Company subject to its General Conditions of Service printed overleaf, available on request or accessible at <http://www.sgs.com.tw/Terms-and-Conditions> and for electronic format documents, subject to Terms and Conditions for Electronic Documents at <http://www.sgs.com.tw/Terms-and-Conditions>. Attention is drawn to the limitation of liability, indemnification and jurisdiction issues defined therein. Any holder of this document is advised that information contained hereon reflects the Company's findings at the time of its intervention only and within the limits of Client's instructions, if any. The Company's sole responsibility is to its Client and this document does not exonerate parties to a transaction from exercising all their rights and obligations under the transaction documents. This document cannot be reproduced except in full, without prior written approval of the Company. Any unauthorized alteration, forgery or falsification of the content or appearance of this document is unlawful and offenders may be prosecuted to the fullest extent of the law.

Report Number :TERF2303000419E2

Test Site :SAC D

Operation Mode :BR

Test Date :2023-03-16

Test Frequency :2441 MHz

Temp./Humi. :21.3/56

Test Mode :Tx

Antenna Pol. :Vertical

EUT Pol :E2 Plane

Engineer :Howard Huang

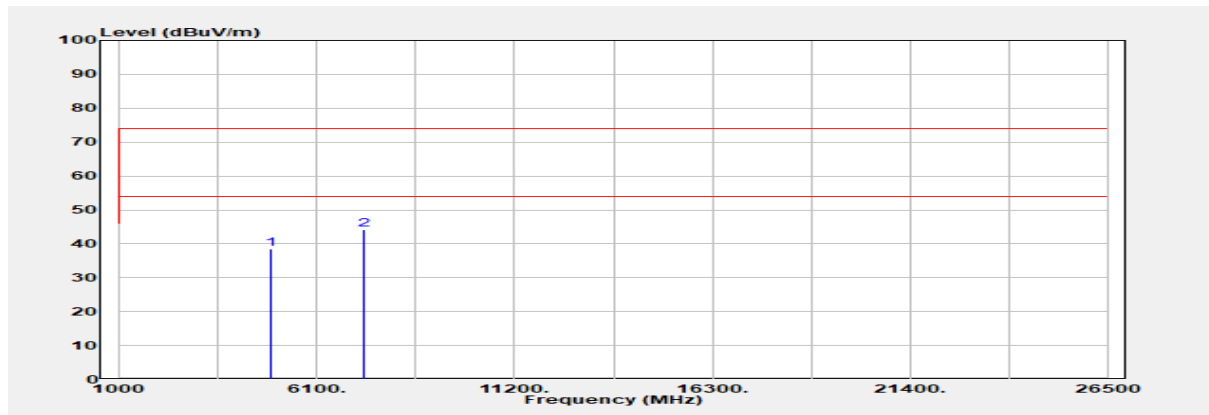

| Freq. MHz | Detector Mode PK/QP/AV | Spectrum Reading Level dB μ V | Factor dB | Actual FS dB μ V/m | Limit @3m dB μ V/m | Margin dB |
|--------------|------------------------------|---|--------------|------------------------------|------------------------------|--------------|
| 4882.000 | Peak | 40.60 | -2.12 | 38.47 | 74.00 | -35.53 |
| 7323.000 | Peak | 39.52 | 4.73 | 44.24 | 74.00 | -29.76 |

| Freq. MHz | Detector Mode AV | Peak Actual FS (dB μ V/m) | Duty Cycle Factor (dB) | Average Value (dBuV/m) | Average Limit@3m (dBuV/m) | Margin (dB) |
|--------------|------------------------|-------------------------------------|------------------------------|------------------------------|---------------------------------|----------------|
| 4882.000 | Average | 38.47 | -24.73 | 13.74 | 54.00 | -40.26 |
| 7323.000 | Average | 44.24 | -24.73 | 19.51 | 54.00 | -34.49 |

Unless otherwise stated the results shown in this test report refer only to the sample(s) tested and such sample(s) are retained for 90 days only.
 除非另有說明，此報告結果僅對測試之樣品負責，同時此樣品僅保留90天。本報告未經本公司書面許可，不可部份複製。

This document is issued by the Company subject to its General Conditions of Service printed overleaf, available on request or accessible at <http://www.sgs.com.tw/Terms-and-Conditions> and for electronic format documents, subject to Terms and Conditions for Electronic Documents at <http://www.sgs.com.tw/Terms-and-Conditions>. Attention is drawn to the limitation of liability, indemnification and jurisdiction issues defined therein. Any holder of this document is advised that information contained hereon reflects the Company's findings at the time of its intervention only and within the limits of Client's instructions, if any. The Company's sole responsibility is to its Client and this document does not exonerate parties to a transaction from exercising all their rights and obligations under the transaction documents. This document cannot be reproduced except in full, without prior written approval of the Company. Any unauthorized alteration, forgery or falsification of the content or appearance of this document is unlawful and offenders may be prosecuted to the fullest extent of the law.

Report Number :TERF2303000419E2
 Operation Mode :BR
 Test Frequency :2441 MHz
 Test Mode :Tx
 EUT Pol :E2 Plane

Test Site :SAC D
 Test Date :2023-03-16
 Temp./Humi. :21.3/56
 Antenna Pol. :Horizontal
 Engineer :Howard Huang

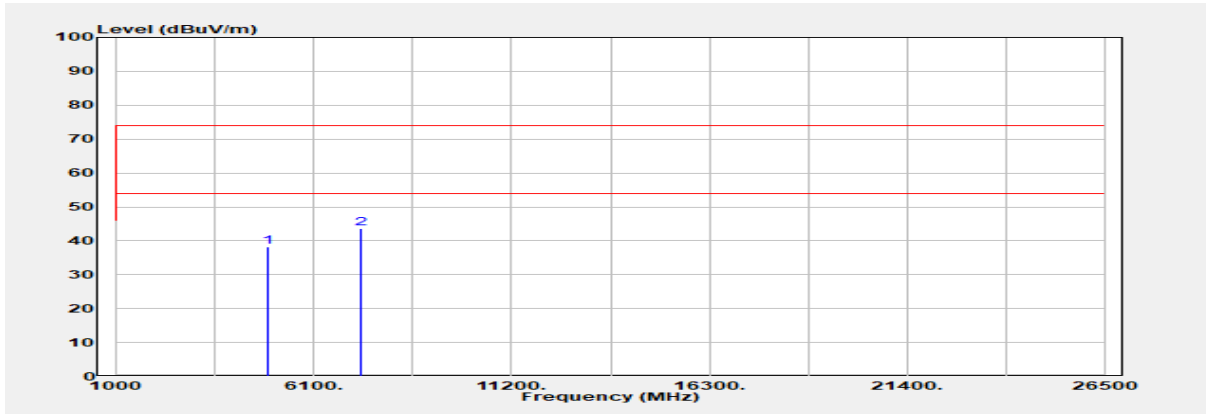

| Freq. MHz | Detector Mode PK/QP/AV | Spectrum Reading Level dB μ V | Factor dB | Actual FS dB μ V/m | Limit @3m dB μ V/m | Margin dB |
|--------------|------------------------------|---|------------------------------|------------------------------|---------------------------------|----------------|
| 4882.000 | Peak | 40.23 | -2.12 | 38.10 | 74.00 | -35.90 |
| 7323.000 | Peak | 38.83 | 4.73 | 43.56 | 74.00 | -30.44 |
| Freq. MHz | Detector Mode AV | Peak Actual FS (dB μ V/m) | Duty Cycle Factor (dB) | Average Value (dBuV/m) | Average Limit@3m (dBuV/m) | Margin (dB) |
| 4882.000 | Average | 38.10 | -24.73 | 13.37 | 54.00 | -40.63 |
| 7323.000 | Average | 43.56 | -24.73 | 18.83 | 54.00 | -35.17 |

Unless otherwise stated the results shown in this test report refer only to the sample(s) tested and such sample(s) are retained for 90 days only.

除非另有說明，此報告結果僅對測試之樣品負責，同時此樣品僅保留90天。本報告未經本公司書面許可，不可部份複製。
 This document is issued by the Company subject to its General Conditions of Service printed overleaf, available on request or accessible at <http://www.sgs.com.tw/Terms-and-Conditions> and for electronic format documents, subject to Terms and Conditions for Electronic Documents at <http://www.sgs.com.tw/Terms-and-Conditions>. Attention is drawn to the limitation of liability, indemnification and jurisdiction issues defined therein. Any holder of this document is advised that information contained hereon reflects the Company's findings at the time of its intervention only and within the limits of Client's instructions, if any. The Company's sole responsibility is to its Client and this document does not exonerate parties to a transaction from exercising all their rights and obligations under the transaction documents. This document cannot be reproduced except in full, without prior written approval of the Company. Any unauthorized alteration, forgery or falsification of the content or appearance of this document is unlawful and offenders may be prosecuted to the fullest extent of the law.

Report Number :TERF2303000419E2

Test Site :SAC D

Operation Mode :BR

Test Date :2023-03-16

Test Frequency :2480 MHz

Temp./Humi. :21.3/56

Test Mode :Tx

Antenna Pol. :Vertical

EUT Pol :E2 Plane

Engineer :Howard Huang

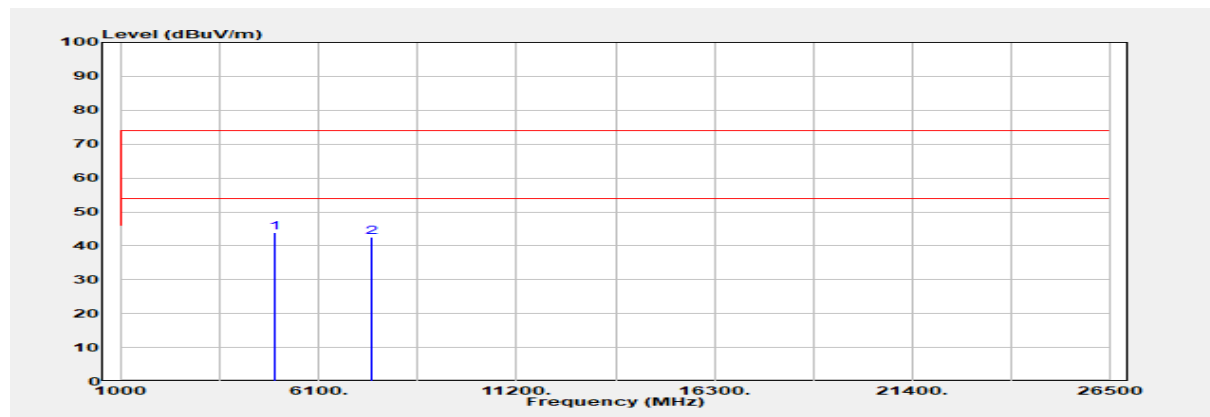

| Freq. MHz | Detector Mode PK/QP/AV | Spectrum Reading Level dB μ V | Factor dB | Actual FS dB μ V/m | Limit @3m dB μ V/m | Margin dB |
|--------------|------------------------------|---|------------------------------|------------------------------|---------------------------------|----------------|
| 4960.000 | Peak | 45.58 | -1.59 | 43.99 | 74.00 | -30.01 |
| 7440.000 | Peak | 38.62 | 3.95 | 42.57 | 74.00 | -31.43 |
| Freq. MHz | Detector Mode AV | Peak Actual FS (dB μ V/m) | Duty Cycle Factor (dB) | Average Value (dBuV/m) | Average Limit@3m (dBuV/m) | Margin (dB) |
| 4960.000 | Average | 43.99 | -24.73 | 19.26 | 54.00 | -34.74 |
| 7440.000 | Average | 42.57 | -24.73 | 17.84 | 54.00 | -36.16 |

Unless otherwise stated the results shown in this test report refer only to the sample(s) tested and such sample(s) are retained for 90 days only.

除非另有說明，此報告結果僅對測試之樣品負責，同時此樣品僅保留90天。本報告未經本公司書面許可，不可部份複製。
This document is issued by the Company subject to its General Conditions of Service printed overleaf, available on request or accessible at <http://www.sgs.com.tw/Terms-and-Conditions> and for electronic format documents, subject to Terms and Conditions for Electronic Documents at <http://www.sgs.com.tw/Terms-and-Conditions>. Attention is drawn to the limitation of liability, indemnification and jurisdiction issues defined therein. Any holder of this document is advised that information contained hereon reflects the Company's findings at the time of its intervention only and within the limits of Client's instructions, if any. The Company's sole responsibility is to its Client and this document does not exonerate parties to a transaction from exercising all their rights and obligations under the transaction documents. This document cannot be reproduced except in full, without prior written approval of the Company. Any unauthorized alteration, forgery or falsification of the content or appearance of this document is unlawful and offenders may be prosecuted to the fullest extent of the law.

Report Number :TERF2303000419E2

Test Site :SAC D

Operation Mode :BR

Test Date :2023-03-16

Test Frequency :2480 MHz

Temp./Humi. :21.3/56

Test Mode :Tx

Antenna Pol. :Horizontal

EUT Pol :E2 Plane

Engineer :Howard Huang

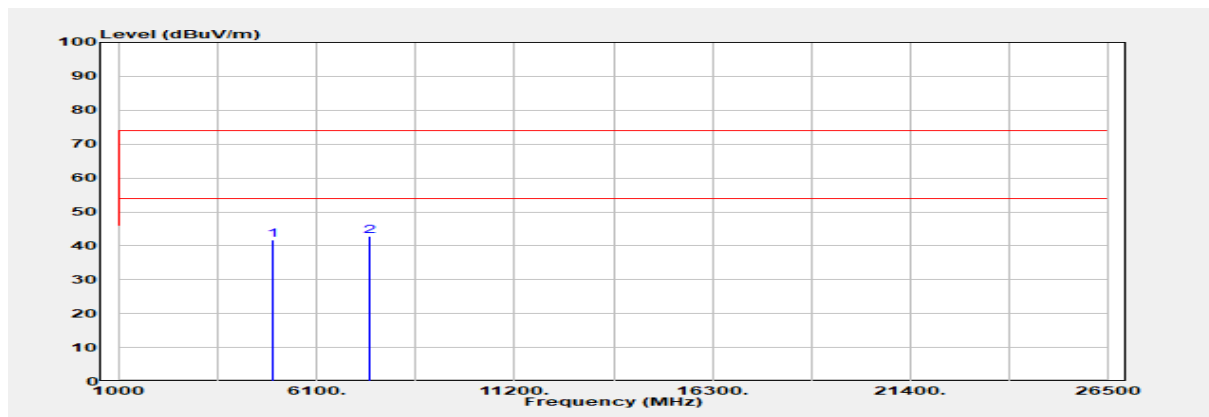

| Freq. MHz | Detector Mode PK/QP/AV | Spectrum Reading Level dB μ V | Factor dB | Actual FS dB μ V/m | Limit @3m dB μ V/m | Margin dB |
|--------------|------------------------------|---|------------------------------|------------------------------|---------------------------------|----------------|
| 4960.000 | Peak | 43.46 | -1.59 | 41.86 | 74.00 | -32.14 |
| 7440.000 | Peak | 38.77 | 3.95 | 42.72 | 74.00 | -31.28 |
| Freq. MHz | Detector Mode AV | Peak Actual FS (dB μ V/m) | Duty Cycle Factor (dB) | Average Value (dBuV/m) | Average Limit@3m (dBuV/m) | Margin (dB) |
| 4960.000 | Average | 41.86 | -24.73 | 17.13 | 54.00 | -36.87 |
| 7440.000 | Average | 42.72 | -24.73 | 17.99 | 54.00 | -36.01 |

Unless otherwise stated the results shown in this test report refer only to the sample(s) tested and such sample(s) are retained for 90 days only.

除非另有說明，此報告結果僅對測試之樣品負責，同時此樣品僅保留90天。本報告未經本公司書面許可，不可部份複製。
This document is issued by the Company subject to its General Conditions of Service printed overleaf, available on request or accessible at <http://www.sgs.com.tw/Terms-and-Conditions> and for electronic format documents, subject to Terms and Conditions for Electronic Documents at <http://www.sgs.com.tw/Terms-and-Conditions>. Attention is drawn to the limitation of liability, indemnification and jurisdiction issues defined therein. Any holder of this document is advised that information contained hereon reflects the Company's findings at the time of its intervention only and within the limits of Client's instructions, if any. The Company's sole responsibility is to its Client and this document does not exonerate parties to a transaction from exercising all their rights and obligations under the transaction documents. This document cannot be reproduced except in full, without prior written approval of the Company. Any unauthorized alteration, forgery or falsification of the content or appearance of this document is unlawful and offenders may be prosecuted to the fullest extent of the law.

Report Number :TERF2303000419E2

Test Site :SAC D

Operation Mode :EDR 2M

Test Date :2023-03-16

Test Frequency :2402 MHz

Temp./Humi. :21.3/56

Test Mode :Tx

Antenna Pol. :Vertical

EUT Pol :E2 Plane

Engineer :Howard Huang

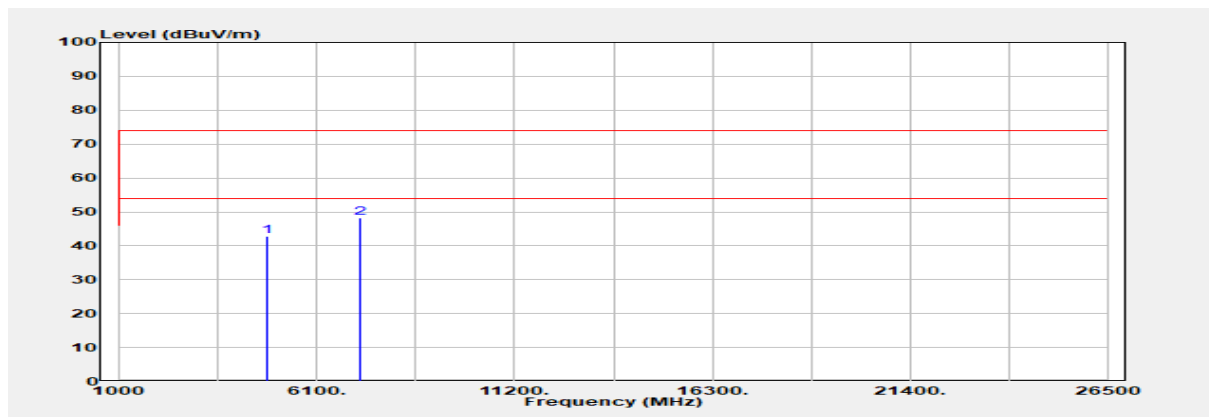

| Freq. MHz | Detector Mode PK/QP/AV | Spectrum Reading Level dBμV | Factor dB | Actual FS dBμV/m | Limit @3m dBμV/m | Margin dB |
|--------------|------------------------------|-----------------------------------|------------------------------|------------------------------|---------------------------------|----------------|
| 4804.000 | Peak | 44.83 | -2.06 | 42.77 | 74.00 | -31.23 |
| 7206.000 | Peak | 43.99 | 4.26 | 48.25 | 74.00 | -25.75 |
| Freq. MHz | Detector Mode AV | Peak Actual FS (dBμV/m) | Duty Cycle Factor (dB) | Average Value (dBuV/m) | Average Limit@3m (dBuV/m) | Margin (dB) |
| 4804.000 | Average | 42.77 | -24.73 | 18.04 | 54.00 | -35.96 |
| 7206.000 | Average | 48.25 | -24.73 | 23.52 | 54.00 | -30.48 |

Unless otherwise stated the results shown in this test report refer only to the sample(s) tested and such sample(s) are retained for 90 days only.

除非另有說明，此報告結果僅對測試之樣品負責，同時此樣品僅保留90天。本報告未經本公司書面許可，不可部份複製。
This document is issued by the Company subject to its General Conditions of Service printed overleaf, available on request or accessible at <http://www.sgs.com.tw/Terms-and-Conditions> and for electronic format documents, subject to Terms and Conditions for Electronic Documents at <http://www.sgs.com.tw/Terms-and-Conditions>. Attention is drawn to the limitation of liability, indemnification and jurisdiction issues defined therein. Any holder of this document is advised that information contained hereon reflects the Company's findings at the time of its intervention only and within the limits of Client's instructions, if any. The Company's sole responsibility is to its Client and this document does not exonerate parties to a transaction from exercising all their rights and obligations under the transaction documents. This document cannot be reproduced except in full, without prior written approval of the Company. Any unauthorized alteration, forgery or falsification of the content or appearance of this document is unlawful and offenders may be prosecuted to the fullest extent of the law.

Report Number :TERF2303000419E2
 Operation Mode :EDR 2M
 Test Frequency :2402 MHz
 Test Mode :Tx
 EUT Pol :E2 Plane

Test Site :SAC D
 Test Date :2023-03-16
 Temp./Humi. :21.3/56
 Antenna Pol. :Horizontal
 Engineer :Howard Huang

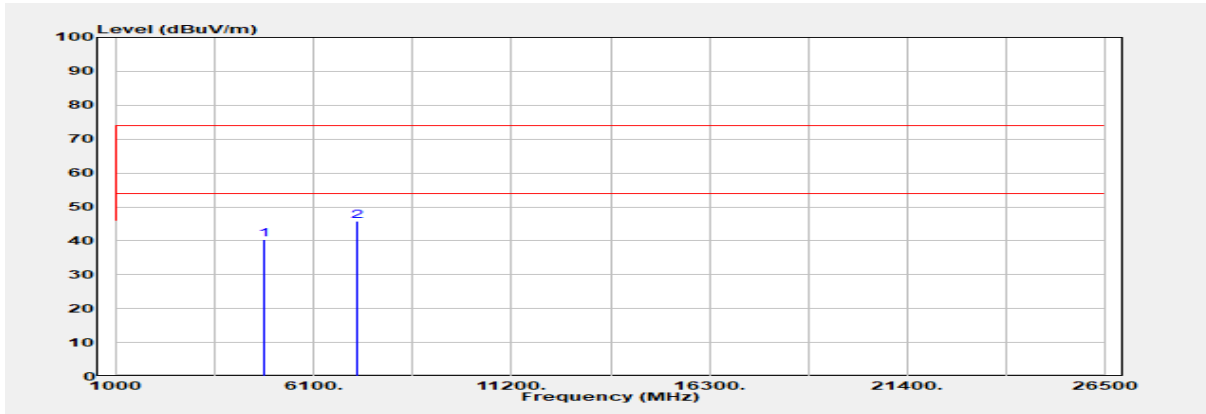

| Freq. MHz | Detector Mode PK/QP/AV | Spectrum Reading Level dB μ V | Factor dB | Actual FS dB μ V/m | Limit @3m dB μ V/m | Margin dB |
|--------------|------------------------------|---|------------------------------|------------------------------|---------------------------------|----------------|
| 4804.000 | Peak | 42.51 | -2.06 | 40.46 | 74.00 | -33.54 |
| 7206.000 | Peak | 41.42 | 4.26 | 45.68 | 74.00 | -28.32 |
| Freq. MHz | Detector Mode AV | Peak Actual FS (dB μ V/m) | Duty Cycle Factor (dB) | Average Value (dBuV/m) | Average Limit@3m (dBuV/m) | Margin (dB) |
| 4804.000 | Average | 40.46 | -24.73 | 15.73 | 54.00 | -38.27 |
| 7206.000 | Average | 45.68 | -24.73 | 20.95 | 54.00 | -33.05 |

Unless otherwise stated the results shown in this test report refer only to the sample(s) tested and such sample(s) are retained for 90 days only.

除非另有說明，此報告結果僅對測試之樣品負責，同時此樣品僅保留90天。本報告未經本公司書面許可，不可部份複製。

This document is issued by the Company subject to its General Conditions of Service printed overleaf, available on request or accessible at <http://www.sgs.com.tw/Terms-and-Conditions> and for electronic format documents, subject to Terms and Conditions for Electronic Documents at <http://www.sgs.com.tw/Terms-and-Conditions>. Attention is drawn to the limitation of liability, indemnification and jurisdiction issues defined therein. Any holder of this document is advised that information contained hereon reflects the Company's findings at the time of its intervention only and within the limits of Client's instructions, if any. The Company's sole responsibility is to its Client and this document does not exonerate parties to a transaction from exercising all their rights and obligations under the transaction documents. This document cannot be reproduced except in full, without prior written approval of the Company. Any unauthorized alteration, forgery or falsification of the content or appearance of this document is unlawful and offenders may be prosecuted to the fullest extent of the law.

Report Number :TERF2303000419E2
 Operation Mode :EDR 2M
 Test Frequency :2441 MHz
 Test Mode :Tx
 EUT Pol :E2 Plane

Test Site :SAC D
 Test Date :2023-03-16
 Temp./Humi. :21.3/56
 Antenna Pol. :Vertical
 Engineer :Howard Huang

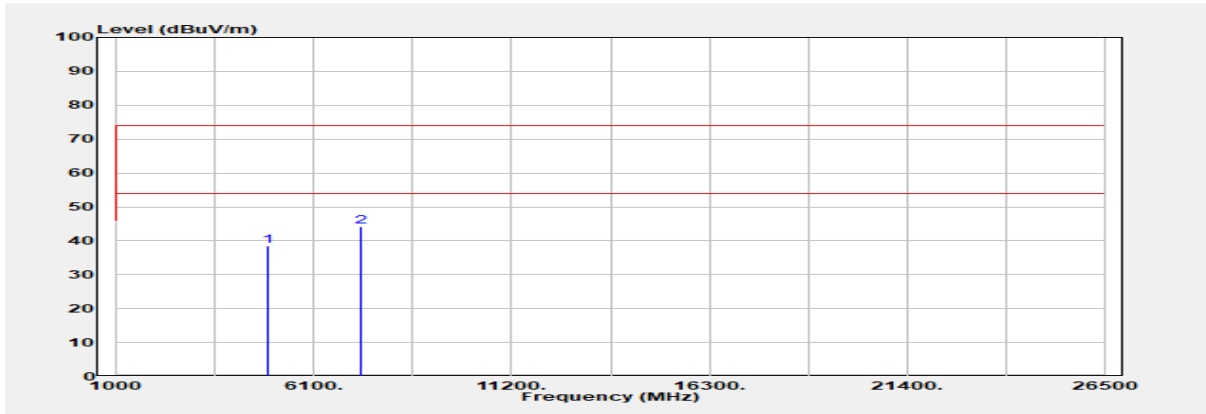

| Freq. MHz | Detector Mode PK/QP/AV | Spectrum Reading Level dB μ V | Factor dB | Actual FS dB μ V/m | Limit @3m dB μ V/m | Margin dB |
|--------------|------------------------------|---|------------------------------|------------------------------|---------------------------------|----------------|
| 4882.000 | Peak | 40.54 | -2.12 | 38.42 | 74.00 | -35.58 |
| 7323.000 | Peak | 39.48 | 4.73 | 44.21 | 74.00 | -29.79 |
| Freq. MHz | Detector Mode AV | Peak Actual FS (dB μ V/m) | Duty Cycle Factor (dB) | Average Value (dBuV/m) | Average Limit@3m (dBuV/m) | Margin (dB) |
| 4882.000 | Average | 38.42 | -24.73 | 13.69 | 54.00 | -40.31 |
| 7323.000 | Average | 44.21 | -24.73 | 19.48 | 54.00 | -34.52 |

Unless otherwise stated the results shown in this test report refer only to the sample(s) tested and such sample(s) are retained for 90 days only.

除非另有說明，此報告結果僅對測試之樣品負責，同時此樣品僅保留90天。本報告未經本公司書面許可，不可部份複製。
 This document is issued by the Company subject to its General Conditions of Service printed overleaf, available on request or accessible at <http://www.sgs.com.tw/Terms-and-Conditions> and for electronic format documents, subject to Terms and Conditions for Electronic Documents at <http://www.sgs.com.tw/Terms-and-Conditions>. Attention is drawn to the limitation of liability, indemnification and jurisdiction issues defined therein. Any holder of this document is advised that information contained hereon reflects the Company's findings at the time of its intervention only and within the limits of Client's instructions, if any. The Company's sole responsibility is to its Client and this document does not exonerate parties to a transaction from exercising all their rights and obligations under the transaction documents. This document cannot be reproduced except in full, without prior written approval of the Company. Any unauthorized alteration, forgery or falsification of the content or appearance of this document is unlawful and offenders may be prosecuted to the fullest extent of the law.

Report Number :TERF2303000419E2
 Operation Mode :EDR 2M
 Test Frequency :2441 MHz
 Test Mode :Tx
 EUT Pol :E2 Plane

Test Site :SAC D
 Test Date :2023-03-16
 Temp./Humi. :21.3/56
 Antenna Pol. :Horizontal
 Engineer :Howard Huang

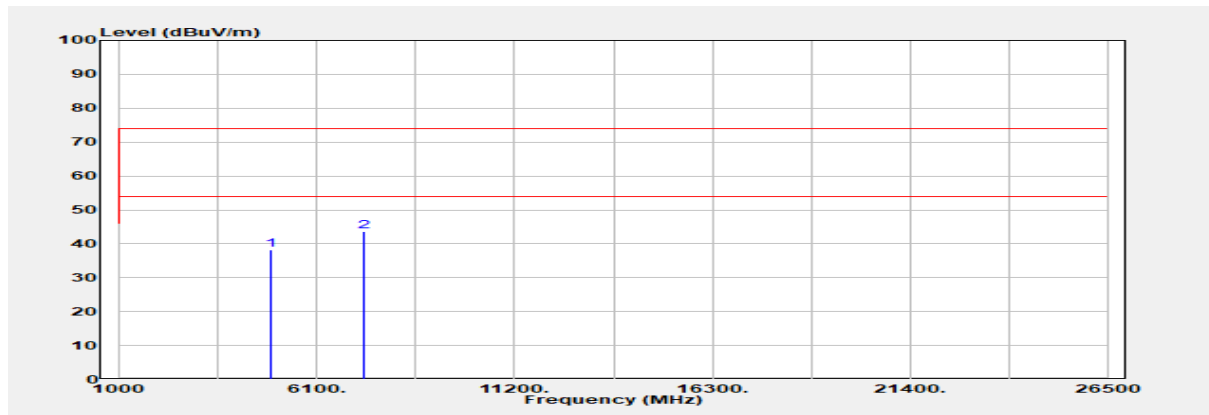

| Freq. MHz | Detector Mode PK/QP/AV | Spectrum Reading Level dB μ V | Factor dB | Actual FS dB μ V/m | Limit @3m dB μ V/m | Margin dB |
|--------------|------------------------------|---|------------------------------|------------------------------|---------------------------------|----------------|
| 4882.000 | Peak | 40.23 | -2.12 | 38.11 | 74.00 | -35.89 |
| 7323.000 | Peak | 38.98 | 4.73 | 43.71 | 74.00 | -30.29 |
| Freq. MHz | Detector Mode AV | Peak Actual FS (dB μ V/m) | Duty Cycle Factor (dB) | Average Value (dBuV/m) | Average Limit@3m (dBuV/m) | Margin (dB) |
| 4882.000 | Average | 38.11 | -24.73 | 13.38 | 54.00 | -40.62 |
| 7323.000 | Average | 43.71 | -24.73 | 18.98 | 54.00 | -35.02 |

Unless otherwise stated the results shown in this test report refer only to the sample(s) tested and such sample(s) are retained for 90 days only.
 除非另有說明，此報告結果僅對測試之樣品負責，同時此樣品僅保留90天。本報告未經本公司書面許可，不可部份複製。

This document is issued by the Company subject to its General Conditions of Service printed overleaf, available on request or accessible at <http://www.sgs.com.tw/Terms-and-Conditions> and for electronic format documents, subject to Terms and Conditions for Electronic Documents at <http://www.sgs.com.tw/Terms-and-Conditions>. Attention is drawn to the limitation of liability, indemnification and jurisdiction issues defined therein. Any holder of this document is advised that information contained hereon reflects the Company's findings at the time of its intervention only and within the limits of Client's instructions, if any. The Company's sole responsibility is to its Client and this document does not exonerate parties to a transaction from exercising all their rights and obligations under the transaction documents. This document cannot be reproduced except in full, without prior written approval of the Company. Any unauthorized alteration, forgery or falsification of the content or appearance of this document is unlawful and offenders may be prosecuted to the fullest extent of the law.

Report Number :TERF2303000419E2
 Operation Mode :EDR 2M
 Test Frequency :2480 MHz
 Test Mode :Tx
 EUT Pol :E2 Plane

Test Site :SAC D
 Test Date :2023-03-16
 Temp./Humi. :21.3/56
 Antenna Pol. :Vertical
 Engineer :Howard Huang

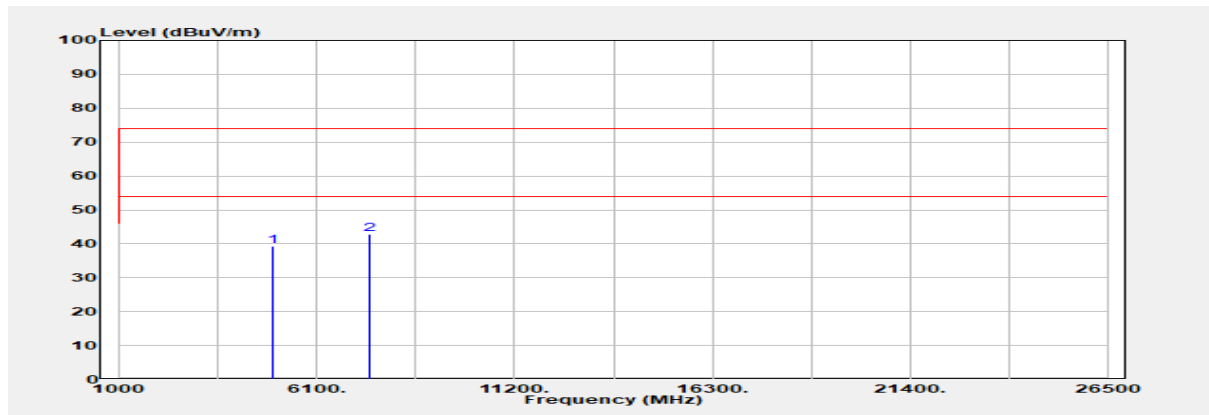

| Freq. MHz | Detector Mode PK/QP/AV | Spectrum Reading Level dB μ V | Factor dB | Actual FS dB μ V/m | Limit @3m dB μ V/m | Margin dB |
|--------------|------------------------------|---|------------------------------|------------------------------|---------------------------------|----------------|
| 4960.000 | Peak | 40.88 | -1.59 | 39.28 | 74.00 | -34.72 |
| 7440.000 | Peak | 38.95 | 3.95 | 42.90 | 74.00 | -31.10 |
| Freq. MHz | Detector Mode AV | Peak Actual FS (dB μ V/m) | Duty Cycle Factor (dB) | Average Value (dBuV/m) | Average Limit@3m (dBuV/m) | Margin (dB) |
| 4960.000 | Average | 39.28 | -24.73 | 14.55 | 54.00 | -39.45 |
| 7440.000 | Average | 42.90 | -24.73 | 18.17 | 54.00 | -35.83 |

Unless otherwise stated the results shown in this test report refer only to the sample(s) tested and such sample(s) are retained for 90 days only.

除非另有說明，此報告結果僅對測試之樣品負責，同時此樣品僅保留90天。本報告未經本公司書面許可，不可部份複製。

This document is issued by the Company subject to its General Conditions of Service printed overleaf, available on request or accessible at <http://www.sgs.com.tw/Terms-and-Conditions> and for electronic format documents, subject to Terms and Conditions for Electronic Documents at <http://www.sgs.com.tw/Terms-and-Conditions>. Attention is drawn to the limitation of liability, indemnification and jurisdiction issues defined therein. Any holder of this document is advised that information contained hereon reflects the Company's findings at the time of its intervention only and within the limits of Client's instructions, if any. The Company's sole responsibility is to its Client and this document does not exonerate parties to a transaction from exercising all their rights and obligations under the transaction documents. This document cannot be reproduced except in full, without prior written approval of the Company. Any unauthorized alteration, forgery or falsification of the content or appearance of this document is unlawful and offenders may be prosecuted to the fullest extent of the law.

Report Number :TERF2303000419E2
 Operation Mode :EDR 2M
 Test Frequency :2480 MHz
 Test Mode :Tx
 EUT Pol :E2 Plane

Test Site :SAC D
 Test Date :2023-03-16
 Temp./Humi. :21.3/56
 Antenna Pol. :Horizontal
 Engineer :Howard Huang

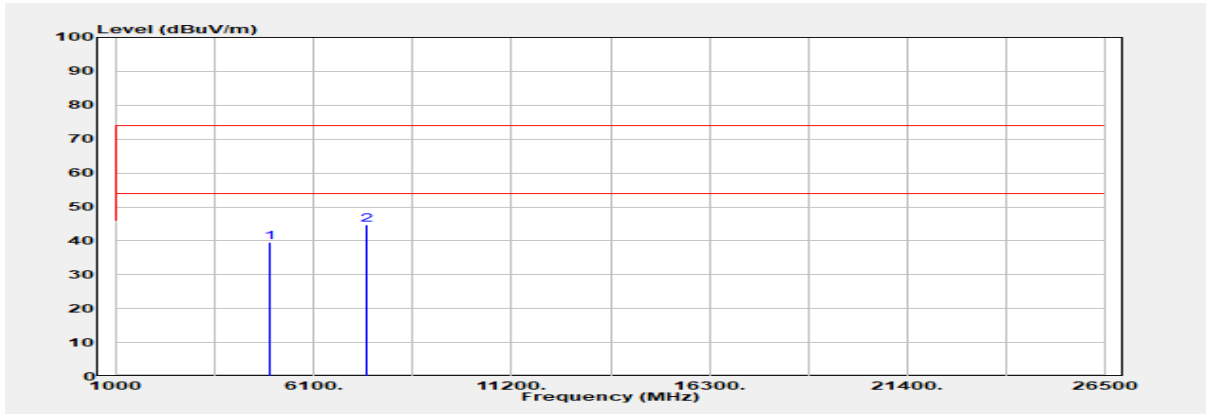

| Freq. MHz | Detector Mode PK/QP/AV | Spectrum Reading Level dB μ V | Factor dB | Actual FS dB μ V/m | Limit @3m dB μ V/m | Margin dB |
|--------------|------------------------------|---|------------------------------|------------------------------|---------------------------------|----------------|
| 4960.000 | Peak | 41.27 | -1.59 | 39.67 | 74.00 | -34.33 |
| 7440.000 | Peak | 40.83 | 3.95 | 44.78 | 74.00 | -29.22 |
| Freq. MHz | Detector Mode AV | Peak Actual FS (dB μ V/m) | Duty Cycle Factor (dB) | Average Value (dBuV/m) | Average Limit@3m (dBuV/m) | Margin (dB) |
| 4960.000 | Average | 39.67 | -24.73 | 14.94 | 54.00 | -39.06 |
| 7440.000 | Average | 44.78 | -24.73 | 20.05 | 54.00 | -33.95 |

Unless otherwise stated the results shown in this test report refer only to the sample(s) tested and such sample(s) are retained for 90 days only.

除非另有說明，此報告結果僅對測試之樣品負責，同時此樣品僅保留90天。本報告未經本公司書面許可，不可部份複製。
 This document is issued by the Company subject to its General Conditions of Service printed overleaf, available on request or accessible at <http://www.sgs.com.tw/Terms-and-Conditions> and for electronic format documents, subject to Terms and Conditions for Electronic Documents at <http://www.sgs.com.tw/Terms-and-Conditions>. Attention is drawn to the limitation of liability, indemnification and jurisdiction issues defined therein. Any holder of this document is advised that information contained hereon reflects the Company's findings at the time of its intervention only and within the limits of Client's instructions, if any. The Company's sole responsibility is to its Client and this document does not exonerate parties to a transaction from exercising all their rights and obligations under the transaction documents. This document cannot be reproduced except in full, without prior written approval of the Company. Any unauthorized alteration, forgery or falsification of the content or appearance of this document is unlawful and offenders may be prosecuted to the fullest extent of the law.

12 FREQUENCY SEPARATION

12.1 Standard Applicable

Frequency hopping systems shall have hopping channel carrier frequencies separated by minimum of 25 kHz or the $\frac{2}{3} \times 20\text{dB}$ bandwidth of the hopping channel, whichever is greater.

12.2 Test Setup

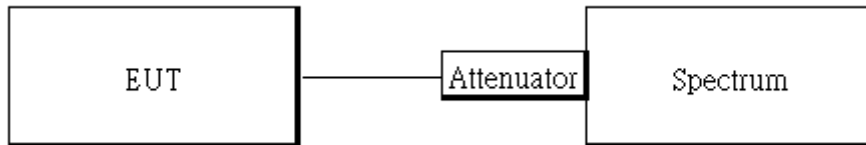

12.3 Measurement Procedure

1. Place the EUT on the table and set it in transmitting mode.
2. The testing follows ANSI C63.10:2013.
3. Remove the antenna from the EUT and then connect a low loss RF cable from the antenna port to the spectrum analyzer.
4. Set center frequency of spectrum analyzer = middle of hopping channel.
5. Set the RBW approximately 30% of the channel spacing, $\text{VBW} \geq \text{RBW}$.
6. Adjust Span to Wide enough to capture the peaks of two adjacent channels.
7. Sweep = auto.
8. Max hold. Mark 3 Peaks of hopping channel and record the 3 peaks frequency.

12.4 Measurement Result

| Channel separation (MHz) | Limit | Result |
|--------------------------|--|--------|
| 1 | $\geq 25 \text{ kHz}$ or $\frac{2}{3}$ times 20dB bandwidth | PASS |

Unless otherwise stated the results shown in this test report refer only to the sample(s) tested and such sample(s) are retained for 90 days only.

除非另有說明，此報告結果僅對測試之樣品負責，同時此樣品僅保留90天。本報告未經本公司書面許可，不可部份複製。
This document is issued by the Company subject to its General Conditions of Service printed overleaf, available on request or accessible at <http://www.sgs.com.tw/Terms-and-Conditions> and for electronic format documents, subject to Terms and Conditions for Electronic Documents at <http://www.sgs.com.tw/Terms-and-Conditions>. Attention is drawn to the limitation of liability, indemnification and jurisdiction issues defined therein. Any holder of this document is advised that information contained hereon reflects the Company's findings at the time of its intervention only and within the limits of Client's instructions, if any. The Company's sole responsibility is to its Client and this document does not exonerate parties to a transaction from exercising all their rights and obligations under the transaction documents. This document cannot be reproduced except in full, without prior written approval of the Company. Any unauthorized alteration, forgery or falsification of the content or appearance of this document is unlawful and offenders may be prosecuted to the fullest extent of the law.

GFSK_1M_DH5_CH0CH1CH2



GFSK_1M_DH5_CH38CH39CH40

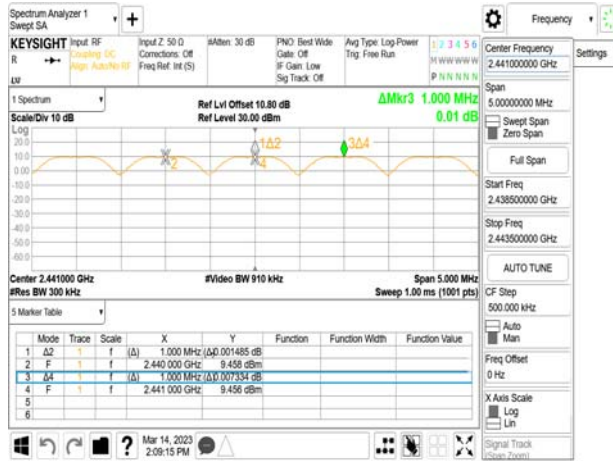

GFSK_1M_DH5_CH76CH77CH78



Unless otherwise stated the results shown in this test report refer only to the sample(s) tested and such sample(s) are retained for 90 days only.

除非另有說明，此報告結果僅對測試之樣品負責，同時此樣品僅保留90天。本報告未經本公司書面許可，不可部份複製。

This document is issued by the Company subject to its General Conditions of Service printed overleaf, available on request or accessible at <http://www.sgs.com.tw/Terms-and-Conditions> and for electronic format documents, subject to Terms and Conditions for Electronic Documents at <http://www.sgs.com.tw/Terms-and-Conditions>. Attention is drawn to the limitation of liability, indemnification and jurisdiction issues defined therein. Any holder of this document is advised that information contained hereon reflects the Company's findings at the time of its intervention only and within the limits of Client's instructions, if any. The Company's sole responsibility is to its Client and this document does not exonerate parties to a transaction from exercising all their rights and obligations under the transaction documents. This document cannot be reproduced except in full, without prior written approval of the Company. Any unauthorized alteration, forgery or falsification of the content or appearance of this document is unlawful and offenders may be prosecuted to the fullest extent of the law.

$\pi/4$ DQPSK_2M_DH5_CH0CH1CH2



$\pi/4$ DQPSK_2M_DH5_CH38CH39CH40



$\pi/4$ DQPSK_2M_DH5_CH76CH77CH78



Unless otherwise stated the results shown in this test report refer only to the sample(s) tested and such sample(s) are retained for 90 days only.

除非另有說明，此報告結果僅對測試之樣品負責，同時此樣品僅保留90天。本報告未經本公司書面許可，不可部份複製。

This document is issued by the Company subject to its General Conditions of Service printed overleaf, available on request or accessible at <http://www.sgs.com.tw/Terms-and-Conditions> and for electronic format documents, subject to Terms and Conditions for Electronic Documents at <http://www.sgs.com.tw/Terms-and-Conditions>. Attention is drawn to the limitation of liability, indemnification and jurisdiction issues defined therein. Any holder of this document is advised that information contained hereon reflects the Company's findings at the time of its intervention only and within the limits of Client's instructions, if any. The Company's sole responsibility is to its Client and this document does not exonerate parties to a transaction from exercising all their rights and obligations under the transaction documents. This document cannot be reproduced except in full, without prior written approval of the Company. Any unauthorized alteration, forgery or falsification of the content or appearance of this document is unlawful and offenders may be prosecuted to the fullest extent of the law.

8DPSK_3M_DH5_CH0CH1CH2



8DPSK_3M_DH5_CH38CH39CH40



8DPSK_3M_DH5_CH76CH77CH78



Unless otherwise stated the results shown in this test report refer only to the sample(s) tested and such sample(s) are retained for 90 days only.

除非另有說明，此報告結果僅對測試之樣品負責，同時此樣品僅保留90天。本報告未經本公司書面許可，不可部份複製。

This document is issued by the Company subject to its General Conditions of Service printed overleaf, available on request or accessible at <http://www.sgs.com.tw/Terms-and-Conditions> and for electronic format documents, subject to Terms and Conditions for Electronic Documents at <http://www.sgs.com.tw/Terms-and-Conditions>. Attention is drawn to the limitation of liability, indemnification and jurisdiction issues defined therein. Any holder of this document is advised that information contained herein reflects the Company's findings at the time of its intervention only and within the limits of Client's instructions, if any. The Company's sole responsibility is to its Client and this document does not exonerate parties to a transaction from exercising all their rights and obligations under the transaction documents. This document cannot be reproduced except in full, without prior written approval of the Company. Any unauthorized alteration, forgery or falsification of the content or appearance of this document is unlawful and offenders may be prosecuted to the fullest extent of the law.

13 NUMBER OF HOPPING FREQUENCY

13.1 Standard Applicable

Frequency hopping systems operating in the 2400MHz-2483.5 MHz bands shall use at least 15 hopping frequencies.

13.2 Test Setup

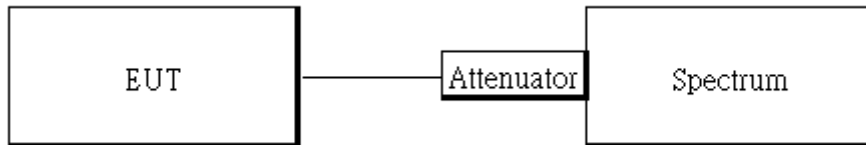

13.3 Measurement Procedure

1. Place the EUT on the table and set it in transmitting mode.
2. The testing follows ANSI C63.10:2013.
3. Remove the antenna from the EUT and then connect a low loss RF cable from the antenna port to the spectrum analyzer.
4. Set spectrum analyzer Start=2400MHz, Stop = 2483.5MHz, Sweep = auto.
5. Set the spectrum analyzer as RBW = 30% of the channel spacing, VBW \geq RBW., Detector = Peak
6. Max hold, view and count how many channel in the band.

13.4 Measurement Result

Tabular Data of Total Channel Number

| | <i>Channel Number</i> | <i>Limit</i> |
|-------------------------------|-----------------------|---------------|
| 2.4 GHz – 2.441 GHz | 40 | >15 |
| 2.441 GHz – 2.4835 GHz | 39 | |
| 2.4 GHz ~2.4835 GHz | (40+39) = 79 | |

Unless otherwise stated the results shown in this test report refer only to the sample(s) tested and such sample(s) are retained for 90 days only.
 除非另有說明，此報告結果僅對測試之樣品負責，同時此樣品僅保留90天。本報告未經本公司書面許可，不可部份複製。

This document is issued by the Company subject to its General Conditions of Service printed overleaf, available on request or accessible at <http://www.sgs.com.tw/Terms-and-Conditions> and for electronic format documents, subject to Terms and Conditions for Electronic Documents at <http://www.sgs.com.tw/Terms-and-Conditions>. Attention is drawn to the limitation of liability, indemnification and jurisdiction issues defined therein. Any holder of this document is advised that information contained hereon reflects the Company's findings at the time of its intervention only and within the limits of Client's instructions, if any. The Company's sole responsibility is to its Client and this document does not exonerate parties to a transaction from exercising all their rights and obligations under the transaction documents. This document cannot be reproduced except in full, without prior written approval of the Company. Any unauthorized alteration, forgery or falsification of the content or appearance of this document is unlawful and offenders may be prosecuted to the fullest extent of the law.

GFSK_1M_DH5_2400-2441



GFSK_1M_DH5_2441-2480

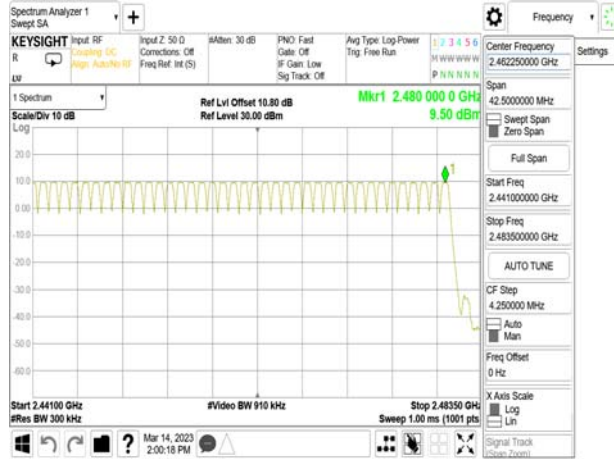

Unless otherwise stated the results shown in this test report refer only to the sample(s) tested and such sample(s) are retained for 90 days only.

除非另有說明，此報告結果僅對測試之樣品負責，同時此樣品僅保留90天。本報告未經本公司書面許可，不可部份複製。

This document is issued by the Company subject to its General Conditions of Service printed overleaf, available on request or accessible at <http://www.sgs.com.tw/Terms-and-Conditions> and for electronic format documents, subject to Terms and Conditions for Electronic Documents at <http://www.sgs.com.tw/Terms-and-Conditions>. Attention is drawn to the limitation of liability, indemnification and jurisdiction issues defined therein. Any holder of this document is advised that information contained hereon reflects the Company's findings at the time of its intervention only and within the limits of Client's instructions, if any. The Company's sole responsibility is to its Client and this document does not exonerate parties to a transaction from exercising all their rights and obligations under the transaction documents. This document cannot be reproduced except in full, without prior written approval of the Company. Any unauthorized alteration, forgery or falsification of the content or appearance of this document is unlawful and offenders may be prosecuted to the fullest extent of the law.

$\pi/4$ DQPSK_2M_DH5_2400-2441

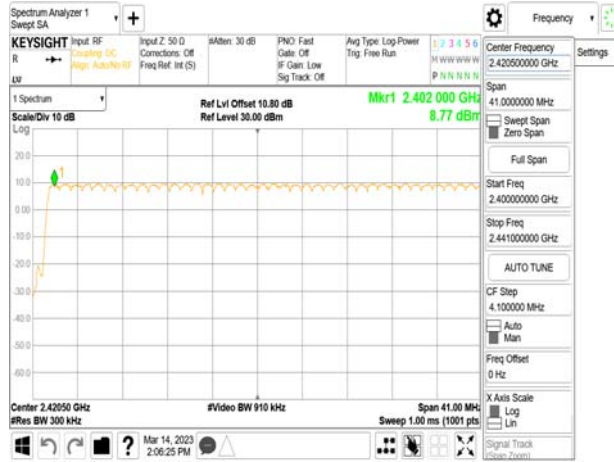

$\pi/4$ DQPSK_2M_DH5_2441-2480

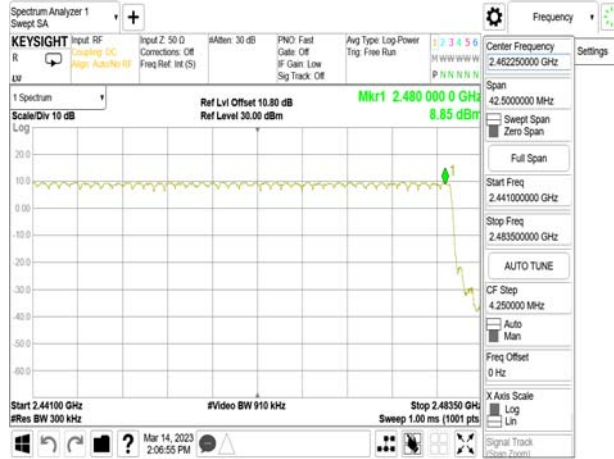

Unless otherwise stated the results shown in this test report refer only to the sample(s) tested and such sample(s) are retained for 90 days only.

除非另有說明，此報告結果僅對測試之樣品負責，同時此樣品僅保留90天。本報告未經本公司書面許可，不可部份複製。

This document is issued by the Company subject to its General Conditions of Service printed overleaf, available on request or accessible at <http://www.sgs.com.tw/Terms-and-Conditions> and for electronic format documents, subject to Terms and Conditions for Electronic Documents at <http://www.sgs.com.tw/Terms-and-Conditions>. Attention is drawn to the limitation of liability, indemnification and jurisdiction issues defined therein. Any holder of this document is advised that information contained hereon reflects the Company's findings at the time of its intervention only and within the limits of Client's instructions, if any. The Company's sole responsibility is to its Client and this document does not exonerate parties to a transaction from exercising all their rights and obligations under the transaction documents. This document cannot be reproduced except in full, without prior written approval of the Company. Any unauthorized alteration, forgery or falsification of the content or appearance of this document is unlawful and offenders may be prosecuted to the fullest extent of the law.

14 TIME OF OCCUPANCY (DWELL TIME)

14.1 Standard Applicable

Frequency hopping systems operating in the 2400MHz-2483.5MHz. The average time of occupancy on any frequency shall not greater than 0.4 s within period of 0.4 seconds multiplied by the number of hopping channel employed.

14.2 Test Setup

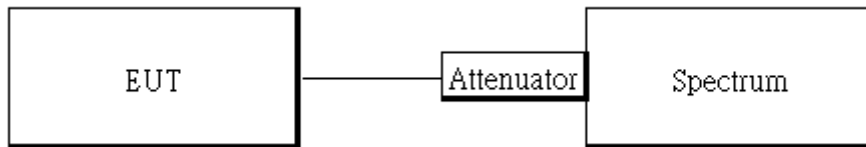

14.3 Measurement Procedure

1. Place the EUT on the table and set it in transmitting mode.
2. The testing follows ANSI C63.10:2013.
3. Remove the antenna from the EUT and then connect a low loss RF cable from the antenna port to the spectrum analyzer.
4. Set center frequency of spectrum analyzer = operating frequency.
5. Set the spectrum analyzer as RBW, VBW=1MHz, 3MHz, Span = 0Hz , Detector = Peak, Adjust Sweep = 2~8ms.
6. Repeat above procedures until all frequency of the interest measured were complete.

Formula Deduced: time occupancy of one time slot X Hopping rate / total slot in one channel / total channel that hops X period of working channels.

Where, standard hopping rate is 1600 hops/s, slot in one channel for DH1, DH3, and DH5 is 2, 4, and 6, respectively.

DH1 consists of single time slot of the uplink, and one slot of the downlink Total Slot: 2

DH3 consists of three time slot of the uplink, and one slot of the downlink. Total Slot: 4

DH5 consists of five time slot of the uplink, and one slot of the downlink. Total Slot: 6

Note: the result of the complete test default channel at 1Mbps is recorded on the test report, 2Mbps, and 3Mbps only records the measurement result at middle channel that reveals no much deviation.

Unless otherwise stated the results shown in this test report refer only to the sample(s) tested and such sample(s) are retained for 90 days only.

除非另有說明，此報告結果僅對測試之樣品負責，同時此樣品僅保留90天。本報告未經本公司書面許可，不可部份複製。
This document is issued by the Company subject to its General Conditions of Service printed overleaf, available on request or accessible at <http://www.sgs.com.tw/Terms-and-Conditions> and for electronic format documents, subject to Terms and Conditions for Electronic Documents at <http://www.sgs.com.tw/Terms-and-Conditions>. Attention is drawn to the limitation of liability, indemnification and jurisdiction issues defined therein. Any holder of this document is advised that information contained hereon reflects the Company's findings at the time of its intervention only and within the limits of Client's instructions, if any. The Company's sole responsibility is to its Client and this document does not exonerate parties to a transaction from exercising all their rights and obligations under the transaction documents. This document cannot be reproduced except in full, without prior written approval of the Company. Any unauthorized alteration, forgery or falsification of the content or appearance of this document is unlawful and offenders may be prosecuted to the fullest extent of the law.

14.4 Measurement Result

GFSK (1Mbps)

| Channel | PACKET TYPE | Measurement Result (ms) | Limit (ms) |
|---------|-------------|-------------------------|------------|
| Mid | DH1 | 152.00 | 400ms |
| | DH3 | 278.40 | 400ms |
| | DH5 | 316.80 | 400ms |

$\pi/4$ DQPSK (2Mbps)

| Channel | PACKET TYPE | Measurement Result (ms) | Limit (ms) |
|---------|-------------|-------------------------|------------|
| Mid | 2DH1 | 156.80 | 400ms |
| | 2DH3 | 281.60 | 400ms |
| | 2DH5 | 318.40 | 400ms |

8-DPSK (3Mbps)

| Channel | PACKET TYPE | Measurement Result (ms) | Limit (ms) |
|---------|-------------|-------------------------|------------|
| Mid | 3DH1 | 156.80 | 400ms |
| | 3DH3 | 281.60 | 400ms |
| | 3DH5 | 318.40 | 400ms |

Unless otherwise stated the results shown in this test report refer only to the sample(s) tested and such sample(s) are retained for 90 days only.
 除非另有說明，此報告結果僅對測試之樣品負責，同時此樣品僅保留90天。本報告未經本公司書面許可，不可部份複製。

This document is issued by the Company subject to its General Conditions of Service printed overleaf, available on request or accessible at <http://www.sgs.com.tw/Terms-and-Conditions> and for electronic format documents, subject to Terms and Conditions for Electronic Documents at <http://www.sgs.com.tw/Terms-and-Conditions>. Attention is drawn to the limitation of liability, indemnification and jurisdiction issues defined therein. Any holder of this document is advised that information contained hereon reflects the Company's findings at the time of its intervention only and within the limits of Client's instructions, if any. The Company's sole responsibility is to its Client and this document does not exonerate parties to a transaction from exercising all their rights and obligations under the transaction documents. This document cannot be reproduced except in full, without prior written approval of the Company. Any unauthorized alteration, forgery or falsification of the content or appearance of this document is unlawful and offenders may be prosecuted to the fullest extent of the law.

GFSK (1Mbps):

| | | | | | | | | | | |
|--------|---------------|---|-------|---|-------------|---|------|---|--------|------|
| CH Mid | DH1 time slot | = | 0.475 | * | (1600/2/79) | * | 31.6 | = | 152.00 | (ms) |
| | DH3 time slot | = | 1.740 | * | (1600/4/79) | * | 31.6 | = | 278.40 | (ms) |
| | DH5 time slot | = | 2.970 | * | (1600/6/79) | * | 31.6 | = | 316.80 | (ms) |

$\pi/4$ -DQPSK (2Mbps):

| | | | | | | | | | | |
|--------|----------------|---|-------|---|-------------|---|------|---|--------|------|
| CH Mid | 2DH1 time slot | = | 0.490 | * | (1600/2/79) | * | 31.6 | = | 156.80 | (ms) |
| | 2DH3 time slot | = | 1.760 | * | (1600/4/79) | * | 31.6 | = | 281.60 | (ms) |
| | 2DH5 time slot | = | 2.985 | * | (1600/6/79) | * | 31.6 | = | 318.40 | (ms) |

8-DPSK (3Mbps):

| | | | | | | | | | | |
|--------|----------------|---|-------|---|-------------|---|------|---|--------|------|
| CH Mid | 3DH1 time slot | = | 0.490 | * | (1600/2/79) | * | 31.6 | = | 156.80 | (ms) |
| | 3DH3 time slot | = | 1.760 | * | (1600/4/79) | * | 31.6 | = | 281.60 | (ms) |
| | 3DH5 time slot | = | 2.985 | * | (1600/6/79) | * | 31.6 | = | 318.40 | (ms) |

A period time = 0.4 (s) * 79 = 31.6 (s)

Unless otherwise stated the results shown in this test report refer only to the sample(s) tested and such sample(s) are retained for 90 days only.
 除非另有說明，此報告結果僅對測試之樣品負責，同時此樣品僅保留90天。本報告未經本公司書面許可，不可部份複製。

This document is issued by the Company subject to its General Conditions of Service printed overleaf, available on request or accessible at <http://www.sgs.com.tw/Terms-and-Conditions> and for electronic format documents, subject to Terms and Conditions for Electronic Documents at <http://www.sgs.com.tw/Terms-and-Conditions>. Attention is drawn to the limitation of liability, indemnification and jurisdiction issues defined therein. Any holder of this document is advised that information contained hereon reflects the Company's findings at the time of its intervention only and within the limits of Client's instructions, if any. The Company's sole responsibility is to its Client and this document does not exonerate parties to a transaction from exercising all their rights and obligations under the transaction documents. This document cannot be reproduced except in full, without prior written approval of the Company. Any unauthorized alteration, forgery or falsification of the content or appearance of this document is unlawful and offenders may be prosecuted to the fullest extent of the law.

Dwell Time_GFSK_1M_DH1_2441MHz



Dwell Time_π/4DQPSK_2M_DH1_2441MHz



Dwell Time_GFSK_1M_DH3_2441MHz



Dwell Time_π/4DQPSK_2M_DH3_2441MHz

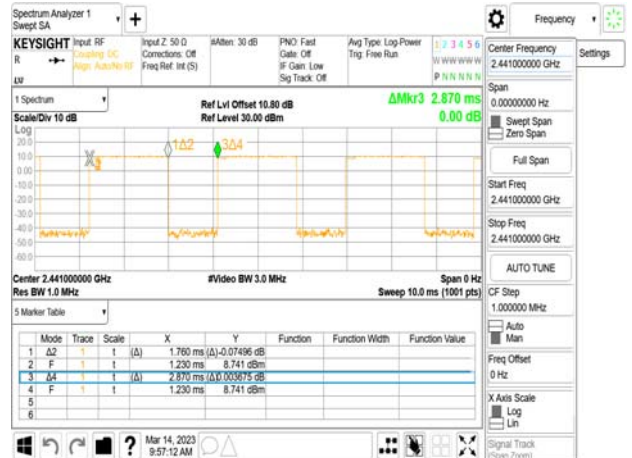

Dwell Time_GFSK_1M_DH5_2441MHz



Dwell Time_π/4DQPSK_2M_DH5_2441MHz

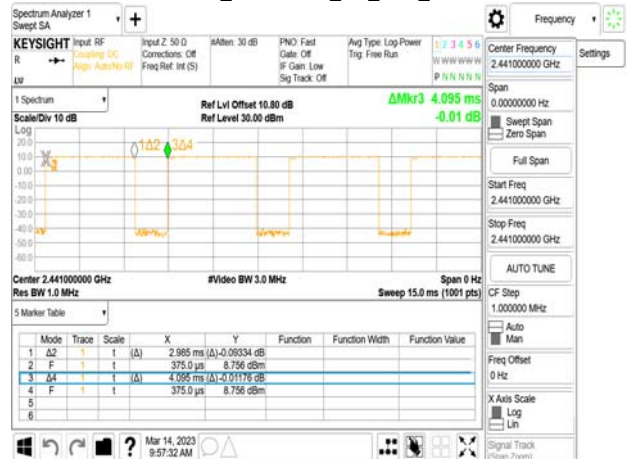

Unless otherwise stated the results shown in this test report refer only to the sample(s) tested and such sample(s) are retained for 90 days only.

除非另有說明，此報告結果僅對測試之樣品負責，同時此樣品僅保留90天。本報告未經本公司書面許可，不可部份複製。

This document is issued by the Company subject to its General Conditions of Service printed overleaf, available on request or accessible at <http://www.sgs.com.tw/Terms-and-Conditions> and for electronic format documents, subject to Terms and Conditions for Electronic Documents at <http://www.sgs.com.tw/Terms-and-Conditions>. Attention is drawn to the limitation of liability, indemnification and jurisdiction issues defined therein. Any holder of this document is advised that information contained hereon reflects the Company's findings at the time of its intervention only and within the limits of Client's instructions, if any. The Company's sole responsibility is to its Client and this document does not exonerate parties to a transaction from exercising all their rights and obligations under the transaction documents. This document cannot be reproduced except in full, without prior written approval of the Company. Any unauthorized alteration, forgery or falsification of the content or appearance of this document is unlawful and offenders may be prosecuted to the fullest extent of the law.

Dwell Time_8DPSK_3M_DH1_2441MHz

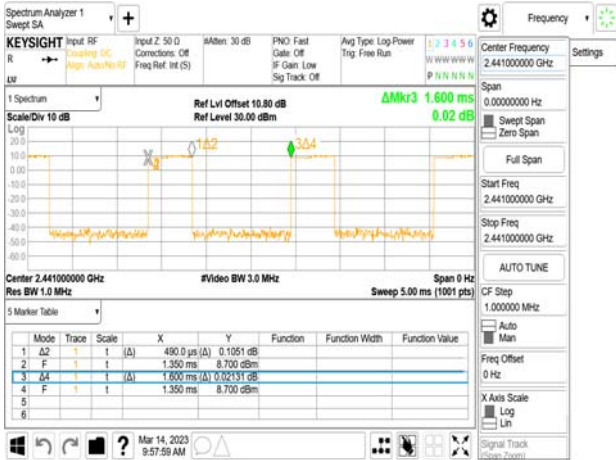

Dwell Time_8DPSK_3M_DH3_2441MHz



Dwell Time_8DPSK_3M_DH5_2441MHz



Unless otherwise stated the results shown in this test report refer only to the sample(s) tested and such sample(s) are retained for 90 days only.

除非另有說明，此報告結果僅對測試之樣品負責，同時此樣品僅保留90天。本報告未經本公司書面許可，不可部份複製。

This document is issued by the Company subject to its General Conditions of Service printed overleaf, available on request or accessible at <http://www.sgs.com.tw/Terms-and-Conditions> and for electronic format documents, subject to Terms and Conditions for Electronic Documents at <http://www.sgs.com.tw/Terms-and-Conditions>. Attention is drawn to the limitation of liability, indemnification and jurisdiction issues defined therein. Any holder of this document is advised that information contained hereon reflects the Company's findings at the time of its intervention only and within the limits of Client's instructions, if any. The Company's sole responsibility is to its Client and this document does not exonerate parties to a transaction from exercising all their rights and obligations under the transaction documents. This document cannot be reproduced except in full, without prior written approval of the Company. Any unauthorized alteration, forgery or falsification of the content or appearance of this document is unlawful and offenders may be prosecuted to the fullest extent of the law.

15 ANTENNA REQUIREMENT

15.1 Standard Applicable

An intentional radiator shall be designed to ensure that no antenna other than that furnished by the responsible party shall be used with the device. The use of a permanently attached antenna or of an antenna that uses a unique coupling to the intentional radiator shall be considered sufficient to comply with the provisions of this section. The manufacturer may design the unit so that a broken antenna can be replaced by the user, but the use of a standard antenna jack or electrical connector is prohibited. This requirement does not apply to carrier current devices or to devices operated under the provisions of §§ 15.211, 15.213, 15.217, 15.219, 15.221, or § 15.236. Further, this requirement does not apply to intentional radiators that must be professionally installed, such as perimeter protection systems and some field disturbance sensors, or to other intentional radiators which, in accordance with § 15.31(d), must be measured at the installation site. However, the installer shall be responsible for ensuring that the proper antenna is employed so that the limits in this part are not exceeded.

15.2 Antenna Connected Construction

The antenna complies with this requirement and no consideration of replacement. Please see EUT photo for details.

~ End of Report ~

Unless otherwise stated the results shown in this test report refer only to the sample(s) tested and such sample(s) are retained for 90 days only.
除非另有說明，此報告結果僅對測試之樣品負責，同時此樣品僅保留90天。本報告未經本公司書面許可，不可部份複製。

This document is issued by the Company subject to its General Conditions of Service printed overleaf, available on request or accessible at <http://www.sgs.com.tw/Terms-and-Conditions> and for electronic format documents, subject to Terms and Conditions for Electronic Documents at <http://www.sgs.com.tw/Terms-and-Conditions>. Attention is drawn to the limitation of liability, indemnification and jurisdiction issues defined therein. Any holder of this document is advised that information contained hereon reflects the Company's findings at the time of its intervention only and within the limits of Client's instructions, if any. The Company's sole responsibility is to its Client and this document does not exonerate parties to a transaction from exercising all their rights and obligations under the transaction documents. This document cannot be reproduced except in full, without prior written approval of the Company. Any unauthorized alteration, forgery or falsification of the content or appearance of this document is unlawful and offenders may be prosecuted to the fullest extent of the law.