



FCC TEST REPORT
FCC ID:2BB7B-F1

Report Number..... : ZHT-240425022E-2

Date of Test..... : Apr. 25, 2024 to May 21, 2024

Date of issue..... : May 21, 2024

Test Result..... : PASS

Testing Laboratory..... : Guangdong Zhonghan Testing Technology Co., Ltd.

Address : Room 104, Building 1, Yibaolai Industrial Park, Qiaotou Community, Fuhai Street, Bao'an District, Shenzhen, Guangdong, China

Applicant's name : Shenzhen Qingfen Tingxiu Information Technology Co. Ltd

Address : 2405-06, Baotai Building, 182 Design Park, 182 Bulan Road, Lilang Community, Nanwan Street, Longgang District, Shenzhen

Manufacturer's name : Shenzhen Qingfen Tingxiu Information Technology Co. Ltd

Address : 2405-06, Baotai Building, 182 Design Park, 182 Bulan Road, Lilang Community, Nanwan Street, Longgang District, Shenzhen

Test specification:

Standard : FCC CFR Title 47 Part 15 Subpart C Section 15.247

Test procedure : KDB558074 D01 15.247 Meas Guidance v05r02
ANSI C63.10:2013

Non-standard test method : N/A

This device described above has been tested by ZHT, and the test results show that the equipment under test (EUT) is in compliance with the FCC requirements. And it is applicable only to the tested sample identified in the report.

This report shall not be reproduced except in full, without the written approval of ZHT, this document may be altered or revised by ZHT, personal only, and shall be noted in the revision of the document.

Product name..... : MINIPC

Trademark : FIREBAT

Model/Type reference : F1, MN56, A8, Z8

Model Difference : F1 is tested model, other models are derivative models .The models are identical in circuit, only different on the model names, size and shape. So the test data of F1 can represent the remaining models.

Ratings..... : Adapter: KT120A1900630B3
Input: 100-240V~50/60Hz 1.8A
Output: 19.0V, 6.3A 119.7W



Testing procedure and testing location:

Testing Laboratory.....: Guangdong Zhonghan Testing Technology Co., Ltd.

Address.....: Room 104, Building 1, Yibaolai Industrial Park, Qiaotou Community, Fuhai Street, Bao'an District, Shenzhen, Guangdong, China

Tested by (name + signature): Leon Li

Leon Li

Reviewer (name + signature).....: Baret Wu

Baret Wu

Approved (name + signature): Levi Lee

Levi Lee



Table of Contents

	Page
1. VERSION.....	5
2. SUMMARY OF TEST RESULTS.....	6
2.1 TEST FACILITY.....	7
2.2 MEASUREMENT UNCERTAINTY.....	7
3. GENERAL INFORMATION.....	8
3.1 GENERAL DESCRIPTION OF EUT.....	8
3.2 DESCRIPTION OF TEST MODES.....	9
3.3 BLOCK DIGRAM SHOWING THE CONFIGURATION OF SYSTEM TESTED.....	10
3.4 DESCRIPTION OF SUPPORT UNITS(CONDUCTED MODE).....	10
3.5EQUIPMENTS LIST FOR ALL TEST ITEMS.....	11
4. EMC EMISSION TEST.....	14
4.1 CONDUCTED EMISSION MEASUREMENT.....	14
4.1.1 POWER LINE CONDUCTED EMISSION Limits.....	14
4.1.2 TEST PROCEDURE.....	14
4.1.3 DEVIATION FROM TEST STANDARD.....	14
4.1.4 TEST SETUP.....	15
4.1.5 EUT OPERATING CONDITIONS.....	15
4.2 RADIATED EMISSION MEASUREMENT.....	18
4.2.1 RADIATED EMISSION LIMITS.....	18
4.2.2 TEST PROCEDURE.....	18
4.2.3 DEVIATION FROM TEST STANDARD.....	19
4.2.4 TEST SETUP.....	19
4.2.5 EUT OPERATING CONDITIONS.....	20
4.2.6 TEST RESULTS.....	20
5. RADIATED BAND EMISSIONMEASUREMENT.....	25
5.1 TEST REQUIREMENT:.....	25
5.2 TEST PROCEDURE.....	25
5.3 DEVIATION FROM TEST STANDARD.....	25
5.4 TEST SETUP.....	26
5.5 EUT OPERATING CONDITIONS.....	26
5.6 TEST RESULT.....	27
6. POWER SPECTRAL DENSITY TEST.....	29
6.1 APPLIED PROCEDURES / LIMIT.....	29
6.2 TEST PROCEDURE.....	29
6.3 DEVIATION FROM STANDARD.....	29
6.4 TEST SETUP.....	29
6.5 EUT OPERATION CONDITIONS.....	29



- 6.6 TEST RESULT30
- 7. CHANNEL BANDWIDTH31
 - 7.1 APPLIED PROCEDURES / LIMIT31
 - 7.2 TEST PROCEDURE.....31
 - 7.3 DEVIATION FROM STANDARD31
 - 7.4 TEST SETUP31
 - 7.5 EUT OPERATION CONDITIONS.....31
 - 7.6 TEST RESULT32
- 8. OUTPUT POWER TEST33
 - 8.1 APPLIED PROCEDURES/LIMIT33
 - 8.2 TEST PROCEDURE.....33
 - 8.3 DEVIATION FROM STANDARD33
 - 8.4 TEST SETUP33
 - 8.5 EUT OPERATION CONDITIONS.....33
 - 8.6 TEST RESULT33
- 9. CONDUCTED BAND EDGE AND SPURIOUS EMISSION.....34
 - 9.1 APPLICABLE STANDARD34
 - 9.2 TEST PROCEDURE.....34
 - 9.3 DEVIATION FROM STANDARD34
 - 9.4 TEST SETUP34
 - 9.5 EUT OPERATION CONDITIONS.....34
 - 9.6 TEST RESULTS34
- 10. ANTENNA REQUIREMENT.....35
- 11. APPENDIX WIFI36
 - 11.1 DUTY CYCLE36
 - 11.2 MAXIMUM AVERAGE CONDUCTED OUTPUT POWER49
 - 11.3 MAXIMUM PEAK CONDUCTED OUTPUT POWER.....62
 - 11.3 -6DB BANDWIDTH75
 - 11.4 OCCUPIED CHANNEL BANDWIDTH88
 - 11.5 MAXIMUM POWER SPECTRAL DENSITY LEVEL.....101
 - 11.6 BAND EDGE114
 - 11.7 CONDUCTED RF SPURIOUS EMISSION131
- 12. TEST SETUP PHOTO156
- 13. EUT CONSTRUCTIONAL DETAILS.....156



1. VERSION

Report No.	Version	Description	Approved
ZHT-240425022E-2	Rev.01	Initial issue of report	May 21, 2024



2. SUMMARY OF TEST RESULTS

Test procedures according to the technical standards:

FCC Part15 (15.247) , Subpart C			
Standard Section	Test Item	Result	Remark
FCC part 15.203/15.247 (b)(4)	Antenna requirement	PASS	
FCC part 15.207	AC Power Line Conducted Emission	PASS	
FCC part 15.247 (b)(3)	Conducted Peak Output Power	PASS	
FCC part 15.247 (a)(2)	Channel Bandwidth	PASS	
FCC part 15.247 (e)	Power Spectral Density	PASS	
FCC part 15.247(d)	Band Edge	PASS	
FCC part 15.205/15.209	Spurious Emission	PASS	

NOTE:

(1) " N/A" denotes test is not applicable in this Test Report

(2)WIFI antenna 1 and antenna 2 cannot be transmitted at the same time



2.1 TEST FACILITY

Guangdong Zhonghan Testing Technology Co., Ltd.
Add. : Room 104, Building 1, Yibaolai Industrial Park, Qiaotou Community, Fuhai Street, Bao'an District, Shenzhen, Guangdong, China

FCC Registration Number:255941
Designation Number: CN0325
IC Registered No.: 29832
CAB identifier: CN0143

2.2 MEASUREMENT UNCERTAINTY

The reported uncertainty of measurement $y \pm U$, where expanded uncertainty U is based on a standard uncertainty multiplied by a coverage factor of $k=2$, providing a level of confidence of approximately 95 %.

No.	Item	Uncertainty
1	Conducted Emission Test	$\pm 1.38\text{dB}$
2	RF conducted power	$\pm 0.16\text{dB}$
3	Conducted spurious emissions	$\pm 0.21\text{dB}$
4	All radiated emissions (9k-30MHz)	$\pm 4.68\text{dB}$
5	All radiated emissions (<1G)	$\pm 4.68\text{dB}$
6	All radiated emissions (>1G)	$\pm 4.89\text{dB}$
7	Temperature	$\pm 0.5^\circ\text{C}$
8	Humidity	$\pm 2\%$
9	Occupied Bandwidth	$\pm 4.96\%$



3. GENERAL INFORMATION

3.1 GENERAL DESCRIPTION OF EUT

Product Name:	MINIPC
Test Model No.:	F1
Hardware Version:	V1.0
Software Version:	V1.0
Sample(s) Status:	Engineer sample
Channel numbers:	802.11b/802.11g /802.11n(HT20):11, /802.11n(HT40):7
Operation Frequency:	802.11b/802.11g /802.11n(HT20): 2412-2462MHz/802.11n(HT40): 2422-2452MHz
Channel separation:	5MHz
Modulation technology:	IEEE 802.11b: DQPSK/DBPSK/DSSS/CCK IEEE 802.11g: QPSK/BPSK/16QAM/64QAM/OFDM IEEE 802.11n: QPSK/BPSK/16QAM/64QAM/OFDM
Antenna Type:	FPC Antenna
Antenna gain:	5.07dBi
Power supply:	Adapter: KT120A1900630B3 Input: 100-240V~50/60Hz 1.8A Output: 19.0V, 6.3A 119.7W

.....



Operation Frequency each of channel							
Channel	Frequency	Channel	Frequency	Channel	Frequency	Channel	Frequency
1	2412MHz	4	2427MHz	7	2442MHz	10	2457MHz
2	2417MHz	5	2432MHz	8	2447MHz	11	2462MHz
3	2422MHz	6	2437MHz	9	2452MHz	X	

Note:

In section 15.31(m), regards to the operating frequency range over 10 MHz, the Lowest frequency, the middle frequency, and the highest frequency of channel were selected to perform the test, and the selected channel see below:

Test channel	Frequency (MHz)
	802.11b/802.11g/802.11n(HT20)
Lowest channel	2412MHz
Middle channel	2437MHz
Highest channel	2462MHz

Test channel	Frequency (MHz)
	802.11n(HT40)
Lowest channel	2422MHz
Middle channel	2437MHz
Highest channel	2452MHz

3.2 DESCRIPTION OF TEST MODES

Transmitting mode	Keep the EUT in continuously transmitting mode			
Remark: EUT use new battery during the test, the duty cycle >98%, the test voltage was tuned from 85% to 115% of the nominal rated supply voltage, and found that the worst case was under the nominal rated supply condition. So the report just shows that condition's data.				
We have verified the construction and function in typical operation. All the test modes were carried out with the EUT in transmitting operation, which was shown in this test report and defined as follows:				
Pre-scan all kind of data rate in lowest channel, and found the follow list which it was worst case.				
Mode	802.11b	802.11g	802.11n(HT20)	802.11n(HT40)
Data rate	1Mbps	6Mbps	6.5Mbps	13.5Mbps



3.3 BLOCK DIGRAM SHOWING THE CONFIGURATION OF SYSTEM TESTED

Radiated Emission

EUT

Conducted Spurious

EUT

3.4 DESCRIPTION OF SUPPORT UNITS(CONDUCTED MODE)

The EUT has been tested as an independent unit together with other necessary accessories or support units. The following support units or accessories were used to form a representative test configuration during the tests.

Item	Equipment	Mfr/Brand	Model/Type No.	Series No.	Note

Item	Shielded Type	Ferrite Core	Length	Note

Note:

- (1) The support equipment was authorized by Declaration of Confirmation.
- (2) For detachable type I/O cable should be specified the length in cm in 『Length』 column.



3.5EQUIPMENTS LIST FOR ALL TEST ITEMS

Radiation Test equipment

Item	Equipment	Manufacturer	Model	Serial No.	Last Cal.	Next Cal.
1	Receiver	R&S	ESCI	100874	May 10, 2024	May 09, 2025
2	Loop antenna	EMCI	LAP600	272	May 10, 2024	May 09, 2025
3	Amplifier	Schwarzbeck	BBV 9743 B	00378	May 10, 2024	May 09, 2025
4	Amplifier	Schwarzbeck	BBV 9718 B	00040	May 10, 2024	May 09, 2025
5	Bilog Antenna	Schwarzbeck	VULB9162	00498	Aug. 04, 2023	Aug. 03, 2024
6	Horn Antenna	Schwarzbeck	BBHA9120D	02623	Aug. 04, 2023	Aug. 03, 2024
7	Horn Antenna	A.H.SYSTEMS	SAS574	588	May 10, 2024	May 09, 2025
8	Amplifier	AEROFLEX	100KHz-40GHz	097	May 10, 2024	May 09, 2025
9	Spectrum Analyzer	R&S	FSV40	101413	Aug. 04, 2023	Aug. 03, 2024
10	966 Anechoic Chamber	EMToni	9m6m6m	/	Nov. 25, 2021	Nov. 24, 2024
11	Spectrum Analyzer	KEYSIGHT	N9020A	MY53420208	May 10, 2024	May 09, 2025
12	WIDBAND RADIO COMMUNICATION TESTER	R&S	CMW500	109863	May 10, 2024	May 09, 2025
13	Single Generator	Agilent	N5182A	MY48180575	May 10, 2024	May 09, 2025
14	Power Sensor	MWRFtest	MW100-RFCB	/	May 10, 2024	May 09, 2025
15	Power Amplifier Shielding Room	EMToni	2m3m3m	/	Nov. 25, 2021	Nov. 24, 2024



Conduction Test equipment

Equipment	Manufacturer	Model	Serial No.	Last Cal.	Next Cal.
Receiver	R&S	ESCI	100874	May 10, 2024	May 09, 2025
LISN	R&S	ENV216	102794	May 10, 2024	May 09, 2025
ISN CAT 6	Schwarzbeck	NTFM 8158	00318	May 10, 2024	May 09, 2025
ISN CAT 5	Schwarzbeck	CAT5 8158	00343	May 10, 2024	May 09, 2025
Capacitive Voltage Probe	Schwarzbeck	CVP 9222 C	00101	May 10, 2024	May 09, 2025
Current Transformer Clamp	Schwarzbeck	SW 9605	SW9605 #209	May 10, 2024	May 09, 2025
CE Shielding Room	EMToni	9m4m3m	/	Nov. 25, 2021	Nov. 24, 2024

Conducted Test equipment

Item	Equipment	Manufacturer	Model	Serial No.	Last Cal.	Next Cal.
1	Spectrum Analyzer	R&S	FSV40	101413	May 10, 2024	May 09, 2025
2	Spectrum Analyzer	KEYSIGHT	N9020A	MY53420208	May 10, 2024	May 09, 2025
3	Power Sensor	MWRTest	MW100-RFCB	/	May 10, 2024	May 09, 2025





4. EMC EMISSION TEST

4.1 CONDUCTED EMISSION MEASUREMENT

Test Requirement:	FCC Part15 C Section 15.207
Test Method:	ANSI C63.10:2013
Test Frequency Range:	150KHz to 30MHz
Receiver setup:	RBW=9KHz, VBW=30KHz, Sweep time=auto

4.1.1 POWER LINE CONDUCTED EMISSION Limits

FREQUENCY (MHz)	Limit (dBuV)		Standard
	Quasi-peak	Average	
0.15 -0.5	66 - 56 *	56 - 46 *	FCC
0.50 -5.0	56.00	46.00	FCC
5.0 -30.0	60.00	50.00	FCC

Note:

(1) *Decreases with the logarithm of the frequency.

4.1.2 TEST PROCEDURE

- a. The EUT was placed 0.8 meters from the horizontal ground plane with EUT being connected to the power mains through a line impedance stabilization network (LISN). All other support equipments powered from additional LISN(s). The LISN provide 50 Ohm/ 50uH of coupling impedance for the measuring instrument.
- b. Interconnecting cables that hang closer than 40 cm to the ground plane shall be folded back and forth in the center forming a bundle 30 to 40 cm long.
- c. I/O cables that are not connected to a peripheral shall be bundled in the center. The end of the cable may be terminated, if required, using the correct terminating impedance. The overall length shall not exceed 1 m.
- d. LISN at least 80 cm from nearest part of EUT chassis.
- e. For the actual test configuration, please refer to the related Item –EUT Test Photos.

4.1.3 DEVIATION FROM TEST STANDARD

No deviation

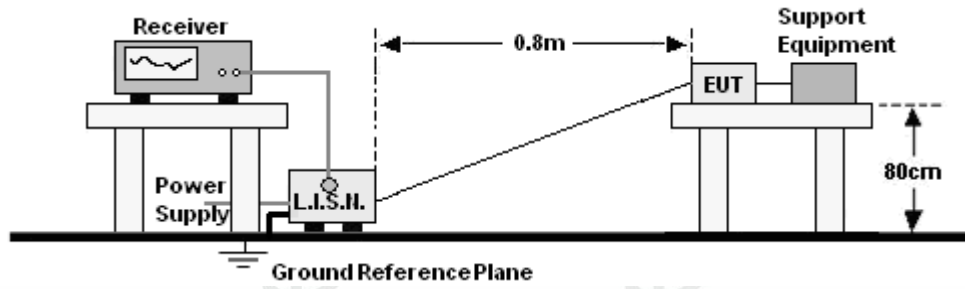

4.1.5 EUT OPERATING CONDITIONS

The EUT was configured for testing in a typical fashion (as a customer would normally use it). The EUT has been programmed to continuously transmit during test. This operating condition was tested and used to collect the included data.



4.1.6 test result

Temperature:	24.3°C	Relative Humidity :	50%
Pressure:	101kPa	Phase :	L
Test Voltage:	AC 120V/60Hz		

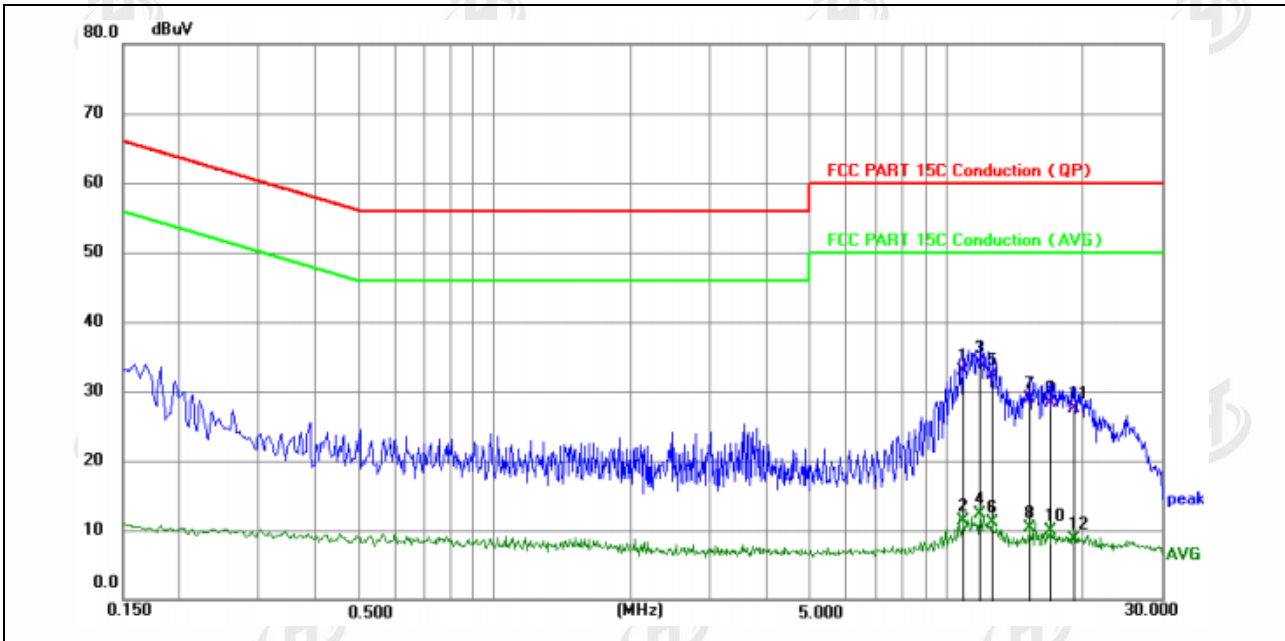

No.	Frequency (MHz)	Reading (dBuV)	Factor (dB)	Level (dBuV)	Limit (dBuV)	Margin (dB)	Detector	P/F
1	10.9184	22.83	10.08	32.91	60.00	-27.09	QP	P
2	10.9184	1.16	10.08	11.24	50.00	-38.76	AVG	P
3 *	11.9310	23.94	10.09	34.03	60.00	-25.97	QP	P
4	11.9310	2.14	10.09	12.23	50.00	-37.77	AVG	P
5	12.6464	22.12	10.09	32.21	60.00	-27.79	QP	P
6	12.6464	0.92	10.09	11.01	50.00	-38.99	AVG	P
7	15.2430	18.72	10.10	28.82	60.00	-31.18	QP	P
8	15.2430	0.24	10.10	10.34	50.00	-39.66	AVG	P
9	16.9755	18.21	10.10	28.31	60.00	-31.69	QP	P
10	16.9755	-0.15	10.10	9.95	50.00	-40.05	AVG	P
11	19.1580	17.46	10.11	27.57	60.00	-32.43	QP	P
12	19.1580	-1.45	10.11	8.66	50.00	-41.34	AVG	P

Notes:

1. An initial pre-scan was performed on the line and neutral lines with peak detector.
2. Quasi-Peak and Average measurement were performed at the frequencies with maximized peak emission.
3. Measurement Level = Reading level + Correct Factor
4. The test data shows only the worst case 802.11b mode (Low Channel:2412MHz).



Temperature:	24.3°C	Relative Humidity :	50%
Pressure:	101kPa	Phase :	N
Test Voltage:	AC 120V/60Hz		

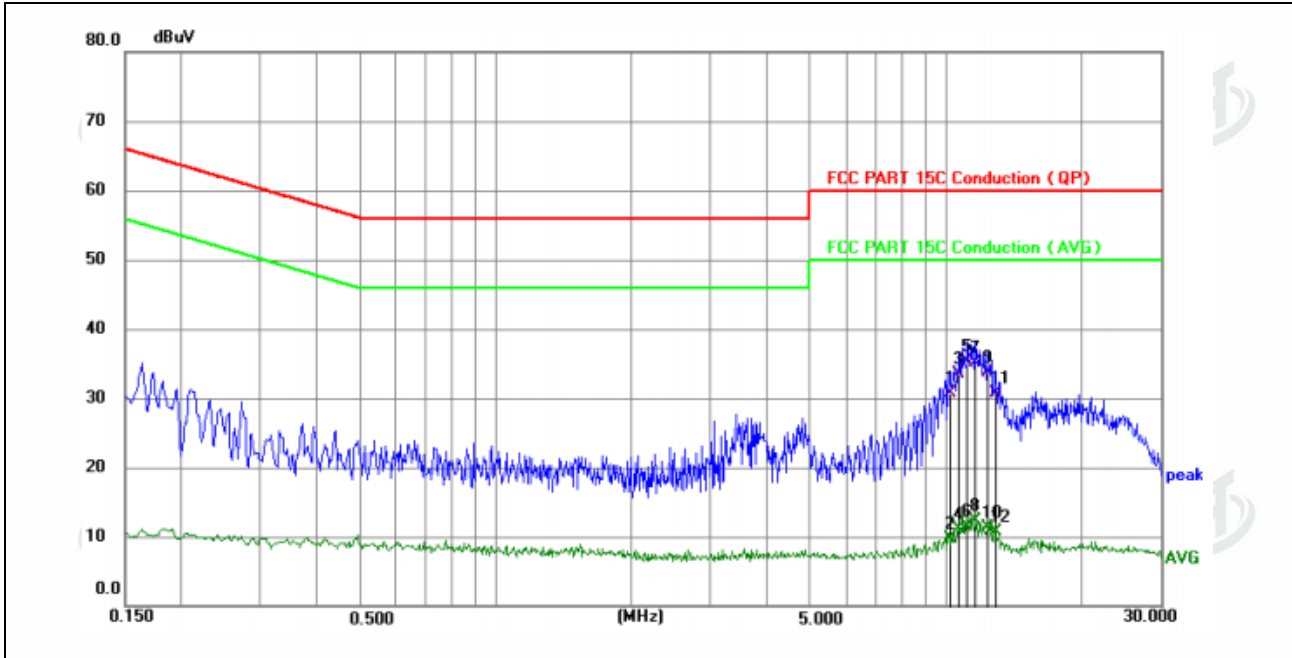

No.	Frequency (MHz)	Reading (dBuV)	Factor (dB)	Level (dBuV)	Limit (dBuV)	Margin (dB)	Detector	P/F
1	10.1791	20.57	10.08	30.65	60.00	-29.35	QP	P
2	10.1791	-0.42	10.08	9.66	50.00	-40.34	AVG	P
3	10.6763	23.46	10.08	33.54	60.00	-26.46	QP	P
4	10.6763	1.09	10.08	11.17	50.00	-38.83	AVG	P
5 *	11.1385	25.13	10.08	35.21	60.00	-24.79	QP	P
6	11.1385	1.50	10.08	11.58	50.00	-38.42	AVG	P
7	11.6208	25.03	10.08	35.11	60.00	-24.89	QP	P
8	11.6208	2.18	10.08	12.26	50.00	-37.74	AVG	P
9	12.3182	23.60	10.09	33.69	60.00	-26.31	QP	P
10	12.3182	1.18	10.09	11.27	50.00	-38.73	AVG	P
11	12.8516	20.71	10.09	30.80	60.00	-29.20	QP	P
12	12.8516	0.56	10.09	10.65	50.00	-39.35	AVG	P

Notes:

1. An initial pre-scan was performed on the line and neutral lines with peak detector.
2. Quasi-Peak and Average measurement were performed at the frequencies with maximized peak emission.
3. Measurement Level = Reading level + Correct Factor
4. The test data shows only the worst case 802.11b mode (Low Channel:2412MHz).



Test Requirement:	FCC Part15 C Section 15.209				
Test Method:	ANSI C63.10:2013				
Test Frequency Range:	9kHz to 25GHz				
Test site:	Measurement Distance: 3m				
Receiver setup:	Frequency	Detector	RBW	VBW	Value
	9KHz-150KHz	Quasi-peak	200Hz	600Hz	Quasi-peak
	150KHz-30MHz	Quasi-peak	9KHz	30KHz	Quasi-peak
	30MHz-1GHz	Quasi-peak	100KHz	300KHz	Quasi-peak
	Above 1GHz	Peak	1MHz	3MHz	Peak
Peak		1MHz	10Hz	Average	

4.2.1 RADIATED EMISSION LIMITS

Frequencies (MHz)	Field Strength (micorvolts/meter)	Measurement Distance (meters)
0.009~0.490	2400/F(KHz)	300
0.490~1.705	24000/F(KHz)	30
1.705~30.0	30	30
30~88	100	3
88~216	150	3
216~960	200	3
Above 960	500	3

LIMITS OF RADIATED EMISSION MEASUREMENT

FREQUENCY (MHz)	Limit (dBuV/m) (at 3M)	
	PEAK	AVERAGE
Above 1000	74	54

Notes:

- (1) The limit for radiated test was performed according to FCC PART 15C.
- (2) The tighter limit applies at the band edges.
- (3) Emission level (dBuV/m)=20log Emission level (uV/m).

4.2.2 TEST PROCEDURE

Below 1GHz test procedure as below:

- a. The EUT was placed on the top of a rotating table 0.8 meters above the ground at a 3 meter semi-anechoiccamber. The table was rotated 360 degrees to determine the position of the highest radiation.
- b. The EUT was set 3 meters away from the interference-receiving antenna, which was mounted on the top of available-height antenna tower.

- c. The antenna height is varied from one meter to four meters above the ground to determine the maximum value of the field strength. Both horizontal and vertical polarizations of the antenna are set to make the measurement.
- d. For each suspected emission, the EUT was arranged to its worst case and then the antenna was tuned to heights from 1 meter to 4 meters (for the test frequency of below 30MHz, the antenna was tuned to heights 1meter) and the rotatable table was turned from 0 degrees to 360 degrees to find the maximum reading.
- e. The test-receiver system was set to Peak Detect Function and Specified Bandwidth with Maximum Hold Mode.
- f. If the emission level of the EUT in peak mode was 10dB lower than the limit specified, then testing could be stopped and the peak values of the EUT would be reported. Otherwise the emissions that did not have 10dBmargin would be re-tested one by one using peak, quasi-peak or average method as specified and then reported in a data sheet.

Above 1GHz test procedure as below:

- g. Different between above is the test site, change from Semi- Anechoic Chamber to fully Anechoic Chamber and change form table 0.8 meter to 1.5 meter(Above 18GHz the distance is 1 meter and table is 1.5 meter).
- h. Test the EUT in the lowest channel ,the middle channel ,the Highest channel

Note:

Both horizontal and vertical antenna polarities were tested and performed pretest to three orthogonal axis. The worst case emissions were reported

4.2.3 DEVIATION FROM TEST STANDARD

No deviation

4.2.4 TEST SETUP

(A) Radiated Emission Test-Up Frequency Below 30MHz

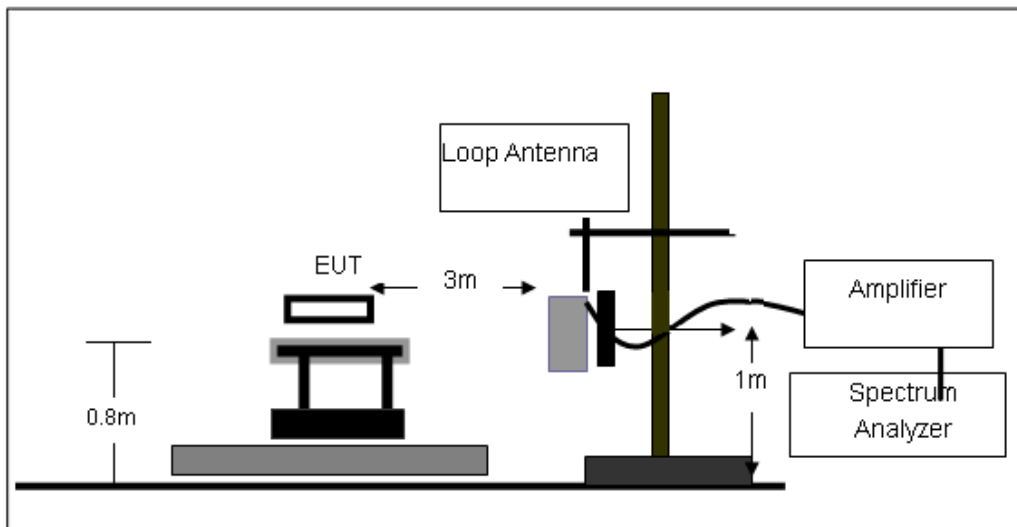

(B) Radiated Emission Test-Up Frequency 30MHz~1GHz

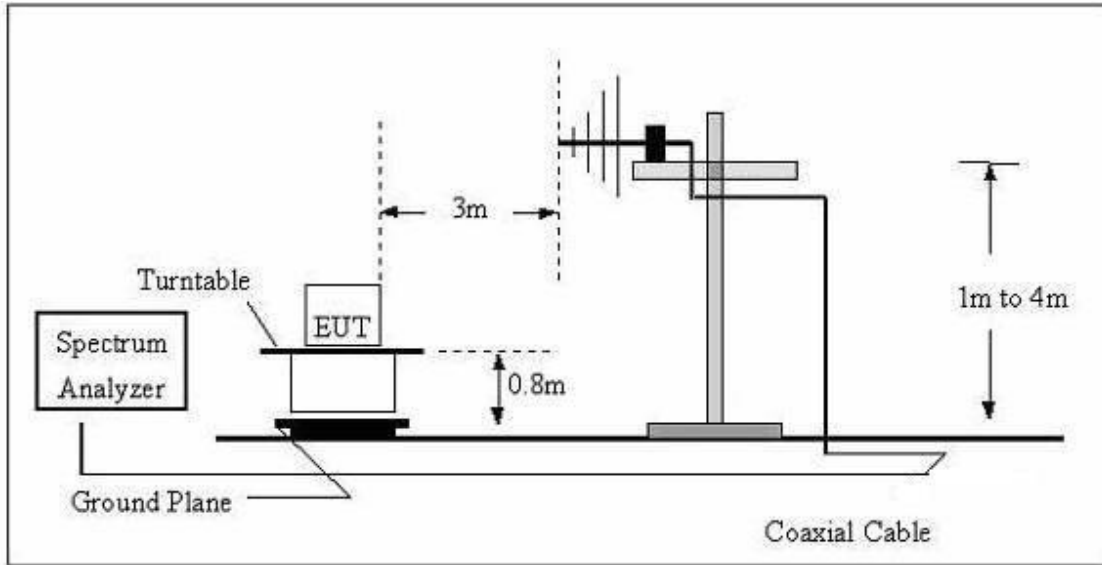

(C) Radiated Emission Test-Up Frequency Above 1GHz

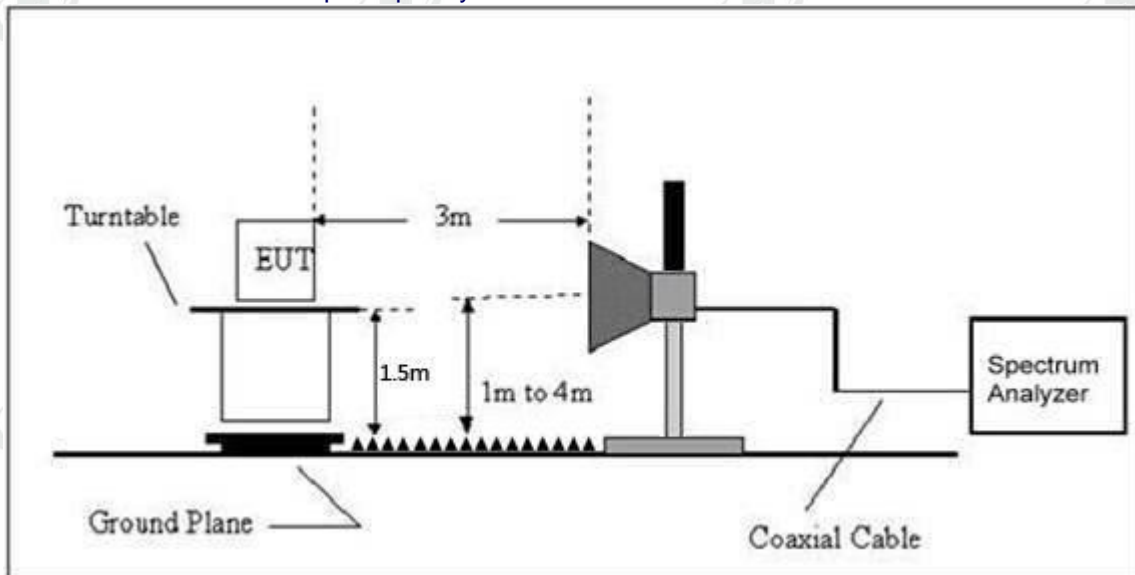

4.2.5 EUT OPERATING CONDITIONS

The EUT tested system was configured as the statements of 2.4 Unless otherwise a special operating condition is specified in the follows during the testing.

4.2.6 TEST RESULTS

Between 9KHz – 30MHz

The emission from 9 kHz to 30MHz was pre-tested and found the result was 20dB lower than the limit, and according to 15.31(o) & RSS-Gen 6.13, the test result no need to reported.



Between 30MHz – 1GHz

Temperature :	25.1°C	Relative Humidity :	50%
Pressure :	101kPa	Polarization :	Horizontal
Test Voltage :	AC 120V		

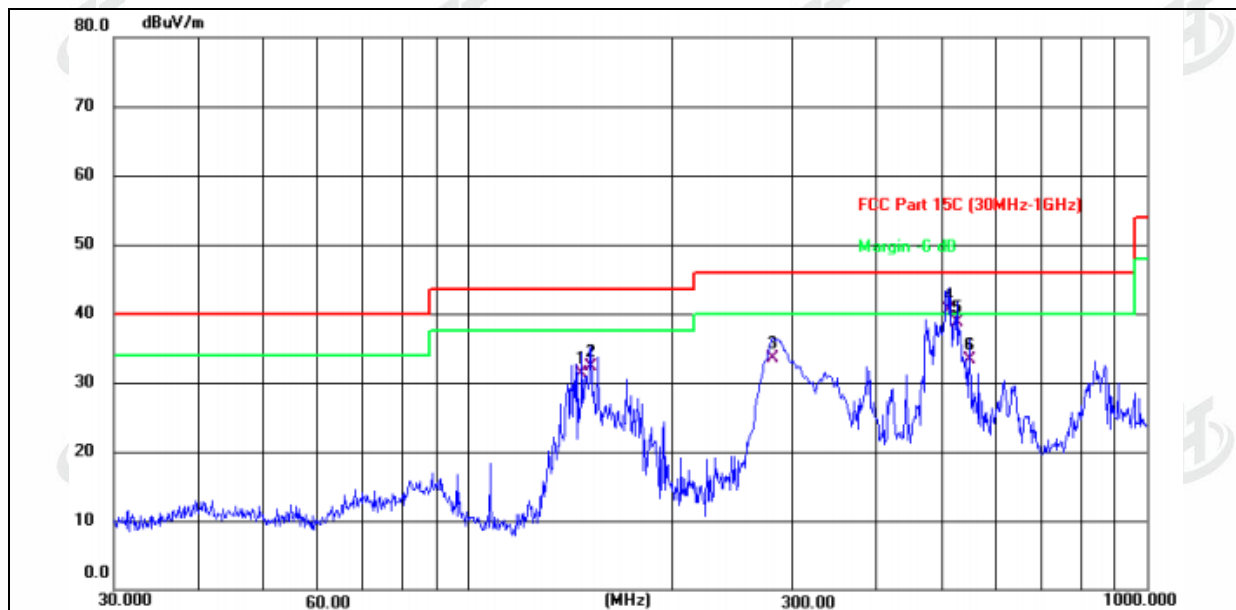

No.	Frequency (MHz)	Reading (dBuV)	Factor (dB/m)	Level (dBuV/m)	Limit (dBuV/m)	Margin (dB)	Detector
1	146.8876	46.77	-15.38	31.39	43.50	-12.11	QP
2	151.5972	47.60	-15.30	32.30	43.50	-11.20	QP
3	281.0074	48.56	-15.02	33.54	46.00	-12.46	QP
4 *	511.8352	50.18	-9.58	40.60	46.00	-5.40	QP
5	524.5541	47.94	-9.27	38.67	46.00	-7.33	QP
6	549.0193	42.02	-8.64	33.38	46.00	-12.62	QP



Temperature :	25.1°C	Relative Humidity :	50%
Pressure :	101kPa	Polarization :	Vertical
Test Voltage :	AC 120V		



No.	Frequency (MHz)	Reading (dBuV)	Factor (dB/m)	Level (dBuV/m)	Limit (dBuV/m)	Margin (dB)	Detector
1	39.7146	38.41	-14.33	24.08	40.00	-15.92	QP
2	56.0007	39.82	-15.49	24.33	40.00	-15.67	QP
3 !	150.5377	54.25	-15.24	39.01	43.50	-4.49	QP
4	170.1947	47.36	-16.37	30.99	43.50	-12.51	QP
5 *	520.8882	51.06	-9.36	41.70	46.00	-4.30	QP
6	603.5391	43.59	-7.32	36.27	46.00	-9.73	QP

Remarks:

- 1.Final Level =Receiver Read level + Antenna Factor + Cable Loss – Preamplifier Factor
- 2.The emission levels of other frequencies are very lower than the limit and not show in test report.
- 3.The test data shows only the worst case 802.11b mode (Low Channel:2412MHz).



1GHz~25GHz

Polar (H/V)	Frequency (MHz)	Meter Reading (dBuV)	Pre-amplifier (dB)	Cable Loss (dB)	Antenna Factor (dB)	Emission Level (dBuV/m)	Limits (dBuV/m)	Margin (dB)	Detect or Type
802.11b									
Low Channel:2412MHz									
V	4824.00	57.33	30.55	5.77	24.66	57.21	74	-16.79	Pk
V	4824.00	43.27	30.55	5.77	24.66	43.15	54	-10.85	AV
H	4824.00	57.67	30.33	6.32	24.55	58.21	74	-15.79	Pk
H	4824.00	43.7	30.33	6.32	24.55	44.24	54	-9.76	AV
Middle Channel:2437MHz									
V	4874.00	55.03	30.55	5.77	24.66	54.91	74	-19.09	Pk
V	4874.00	43.99	30.55	5.77	24.66	43.87	54	-10.13	AV
H	4874.00	59.32	30.33	6.32	24.55	59.86	74	-14.14	Pk
H	4874.00	42.89	30.33	6.32	24.55	43.43	54	-10.57	AV
High Channel:2462MHz									
V	4924.00	58.47	30.55	5.77	24.66	58.35	74	-15.65	Pk
V	4924.00	41.62	30.55	5.77	24.66	41.5	54	-12.5	AV
H	4924.00	58.06	30.33	6.32	24.55	58.6	74	-15.4	Pk
H	4924.00	43.12	30.33	6.32	24.55	43.66	54	-10.34	AV
802.11g									
Low Channel:2412MHz									
V	4824.00	57.82	30.55	5.77	24.66	57.7	74	-16.3	Pk
V	4824.00	41.35	30.55	5.77	24.66	41.23	54	-12.77	AV
H	4824.00	55.26	30.33	6.32	24.55	55.8	74	-18.2	Pk
H	4824.00	41.18	30.33	6.32	24.55	41.72	54	-12.28	AV
Middle Channel:2437MHz									
V	4874.00	59.55	30.55	5.77	24.66	59.43	74	-14.57	Pk
V	4874.00	41.56	30.55	5.77	24.66	41.44	54	-12.56	AV
H	4874.00	58.87	30.33	6.32	24.55	59.41	74	-14.59	Pk
H	4874.00	41.4	30.33	6.32	24.55	41.94	54	-12.06	AV
High Channel:2462MHz									
V	4924.00	57.59	30.55	5.77	24.66	57.47	74	-16.53	Pk
V	4924.00	44.94	30.55	5.77	24.66	44.82	54	-9.18	AV
H	4924.00	56.77	30.33	6.32	24.55	57.31	74	-16.69	Pk
H	4924.00	41.52	30.33	6.32	24.55	42.06	54	-11.94	AV
802.11n 20									
Low Channel:2412MHz									
V	4824.00	57.68	30.55	5.77	24.66	57.56	74	-16.44	Pk
V	4824.00	42.82	30.55	5.77	24.66	42.7	54	-11.3	AV
H	4824.00	58.61	30.33	6.32	24.55	59.15	74	-14.85	Pk
H	4824.00	44.68	30.33	6.32	24.55	45.22	54	-8.78	AV
Middle Channel:2437MHz									
V	4874.00	57.66	30.55	5.77	24.66	57.54	74	-16.46	Pk
V	4874.00	42.77	30.55	5.77	24.66	42.65	54	-11.35	AV
H	4874.00	56.16	30.33	6.32	24.55	56.7	74	-17.3	Pk
	4874.00	44.05	30.33	6.32	24.55	44.59	54	-9.41	AV
High Channel:2462MHz									
V	4924.00	58.36	30.55	5.77	24.66	58.24	74	-15.76	Pk
V	4924.00	41.9	30.55	5.77	24.66	41.78	54	-12.22	AV
H	4924.00	56.35	30.33	6.32	24.55	56.89	74	-17.11	Pk
H	4924.00	41.98	30.33	6.32	24.55	42.52	54	-11.48	AV
802.11n 40									
Low Channel:2422MHz									
V	4844.00	58.48	30.55	5.77	24.66	58.36	74	-15.64	Pk
V	4844.00	41.82	30.55	5.77	24.66	41.7	54	-12.3	AV



H	4844.00	58.6	30.33	6.32	24.55	59.14	74	-14.86	Pk
H	4844.00	41.13	30.33	6.32	24.55	41.67	54	-12.33	AV
Middle Channel:2437MHz									
V	4874.00	59.93	30.55	5.77	24.66	59.81	74	-14.19	Pk
V	4874.00	41.24	30.55	5.77	24.66	41.12	54	-12.88	AV
H	4874.00	55.12	30.33	6.32	24.55	55.66	74	-18.34	Pk
H	4874.00	43.54	30.33	6.32	24.55	44.08	54	-9.92	AV
High Channel:2452MHz									
V	4904.00	58.97	30.55	5.77	24.66	58.85	74	-15.15	Pk
V	4904.00	41.51	30.55	5.77	24.66	41.39	54	-12.61	AV
H	4904.00	55.28	30.33	6.32	24.55	55.82	74	-18.18	Pk
H	4904.00	44.5	30.33	6.32	24.55	45.04	54	-8.96	AV

Remark:

1. Emission Level = Meter Reading + Antenna Factor + Cable Loss – Pre-amplifier, Margin= Emission Level - Limit
2. If peak below the average limit, the average emission was no test.
3. The amplitude of spurious emissions which are attenuated by more than 20dB below the permissible value has no need to be reported.
4. For above 1GHz, the test result of peak was 20dB below to the limit of peak, which can be compliant to the average limit, so just peak value was recorded.



5. RADIATED BAND EMISSION MEASUREMENT

5.1 TEST REQUIREMENT:

Test Requirement:	FCC Part15 C Section 15.209 and 15.205				
Test Method:	ANSI C63.10: 2013				
Test Frequency Range:	All of the restrict bands were tested, only the worst band's (2310MHz to 2500MHz) data was showed.				
Test site:	Measurement Distance: 3m				
Receiver setup:	Frequency	Detector	RBW	VBW	Value
	Above 1GHz	Peak	1MHz	3MHz	Peak
		Average	1MHz	3MHz	Average

LIMITS OF RADIATED EMISSION MEASUREMENT (Above 1000MHz)

FREQUENCY (MHz)	Class B (dBuV/m) (at 3M)	
	PEAK	AVERAGE
Above 1000	74	54

Notes:

- (1) The limit for radiated test was performed according to FCC PART 15C.
- (2) The tighter limit applies at the band edges.
- (3) Emission level (dBuV/m)=20log Emission level (uV/m).

5.2 TEST PROCEDURE

Above 1GHz test procedure as below:

- a. 1. The EUT was placed on the top of a rotating table 1.5 meters above the ground at a 3 meter camber. The table was rotated 360 degrees to determine the position of the highest radiation.
- b. The EUT was set 3 meters away from the interference-receiving antenna, which was mounted on the top of a variable-height antenna tower.
- c. The antenna height is varied from one meter to four meters above the ground to determine the maximum value of the field strength. Both horizontal and vertical polarizations of the antenna are set to make the measurement.
- d. For each suspected emission, the EUT was arranged to its worst case and then the antenna was tuned to heights from 1 meter to 4 meters and the rota table was turned from 0 degrees to 360 degrees to find the maximum reading.
- e. The test-receiver system was set to Peak Detect Function and Specified Bandwidth with Maximum Hold Mode.
- f. If the emission level of the EUT in peak mode was 10dB lower than the limit specified, then testing could be stopped and the peak values of the EUT would be reported. Otherwise the emissions that did not have 10dBmargin would be re-tested one by one using peak, quasi-peak or average method as specified and then reported in a data sheet.
- g. Test the EUT in the lowest channel, the Highest channel

Note:

Both horizontal and vertical antenna polarities were tested and performed pretest to three orthogonal axis. The worst case emissions were reported

5.3 DEVIATION FROM TEST STANDARD

No deviation

Radiated Emission Test-Up Frequency Above 1GHz

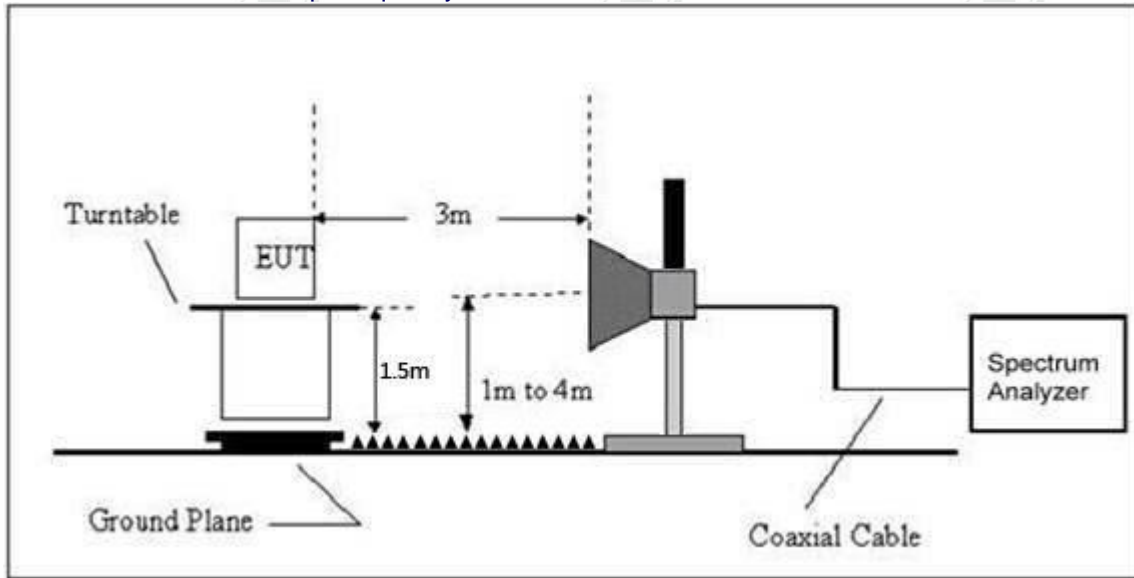

5.5 EUT OPERATING CONDITIONS

The EUT tested system was configured as the statements of 2.3 Unless otherwise a special operating condition is specified in the follows during the testing.



5.6 TEST RESULT

	Polar (H/V)	Frequency (MHz)	Meter Reading (dBuV)	Pre-amplifier (dB)	Cable Loss (dB)	Antenna Factor (dB/m)	Emission level (dBuV/m)	Limit (dBuV/m)	Margin (dB)	Detector Type	Result
802.11b	Low Channel 2412MHz										
	H	2390.00	62.04	30.22	4.85	23.98	60.65	74.00	-13.35	PK	PASS
	H	2390.00	46.23	30.22	4.85	23.98	44.84	54.00	-9.16	AV	PASS
	H	2400.00	62.54	30.22	4.85	23.98	61.15	74.00	-12.85	PK	PASS
	H	2400.00	47.66	30.22	4.85	23.98	46.27	54.00	-7.73	AV	PASS
	V	2390.00	63.00	30.22	4.85	23.98	61.61	74.00	-12.39	PK	PASS
	V	2390.00	48.69	30.22	4.85	23.98	47.30	54.00	-6.70	AV	PASS
	V	2400.00	61.20	30.22	4.85	23.98	59.81	74.00	-14.19	PK	PASS
	V	2400.00	47.50	30.22	4.85	23.98	46.11	54.00	-7.89	AV	PASS
	High Channel 2462MHz										
	H	2483.50	59.03	30.22	4.85	23.98	57.64	74.00	-16.36	AV	PASS
	H	2483.50	46.45	30.22	4.85	23.98	45.06	54.00	-8.94	PK	PASS
	H	2500.00	59.88	30.22	4.85	23.98	58.49	74.00	-15.51	AV	PASS
	H	2500.00	47.08	30.22	4.85	23.98	45.69	54.00	-8.31	PK	PASS
	V	2483.50	62.52	30.22	4.85	23.98	61.13	74.00	-12.87	AV	PASS
	V	2483.50	48.03	30.22	4.85	23.98	46.64	54.00	-7.36	PK	PASS
V	2500.00	61.11	30.22	4.85	23.98	59.72	74.00	-14.28	AV	PASS	
V	2500.00	46.68	30.22	4.85	23.98	45.29	54.00	-8.71	AV	PASS	
802.11g	Low Channel 2412MHz										
	H	2390.00	61.31	30.22	4.85	23.98	59.92	74.00	-14.08	PK	PASS
	H	2390.00	46.33	30.22	4.85	23.98	44.94	54.00	-9.06	AV	PASS
	H	2400.00	60.00	30.22	4.85	23.98	58.61	74.00	-15.39	PK	PASS
	H	2400.00	47.04	30.22	4.85	23.98	45.65	54.00	-8.35	AV	PASS
	V	2390.00	60.15	30.22	4.85	23.98	58.76	74.00	-15.24	PK	PASS
	V	2390.00	48.68	30.22	4.85	23.98	47.29	54.00	-6.71	AV	PASS
	V	2400.00	61.99	30.22	4.85	23.98	60.60	74.00	-13.40	PK	PASS
	V	2400.00	47.53	30.22	4.85	23.98	46.14	54.00	-7.86	AV	PASS
	High Channel 2462MHz										
	H	2483.50	61.01	30.22	4.85	23.98	59.62	74.00	-14.38	PK	PASS
	H	2483.50	47.09	30.22	4.85	23.98	45.70	54.00	-8.30	AV	PASS
	H	2500.00	61.17	30.22	4.85	23.98	59.78	74.00	-14.22	PK	PASS
	H	2500.00	48.42	30.22	4.85	23.98	47.03	54.00	-6.97	AV	PASS
	V	2483.50	60.19	30.22	4.85	23.98	58.80	74.00	-15.20	PK	PASS
	V	2483.50	47.56	30.22	4.85	23.98	46.17	54.00	-7.83	AV	PASS
V	2500.00	61.40	30.22	4.85	23.98	60.01	74.00	-13.99	PK	PASS	
V	2500.00	47.12	30.22	4.85	23.98	45.73	54.00	-8.27	AV	PASS	
802.11n20	Low Channel 2412MHz										
	H	2390.00	59.70	30.22	4.85	23.98	58.31	74.00	-15.69	PK	PASS
	H	2390.00	47.86	30.22	4.85	23.98	46.47	54.00	-7.53	AV	PASS
	H	2400.00	61.18	30.22	4.85	23.98	59.79	74.00	-14.21	PK	PASS
	H	2400.00	48.39	30.22	4.85	23.98	47.00	54.00	-7.00	AV	PASS
	V	2390.00	62.67	30.22	4.85	23.98	61.28	74.00	-12.72	PK	PASS
	V	2390.00	48.36	30.22	4.85	23.98	46.97	54.00	-7.03	AV	PASS
	V	2400.00	59.88	30.22	4.85	23.98	58.49	74.00	-15.51	PK	PASS
	V	2400.00	46.26	30.22	4.85	23.98	44.87	54.00	-9.13	AV	PASS
	High Channel 2462MHz										
	H	2483.50	62.71	30.22	4.85	23.98	61.32	74.00	-12.68	PK	PASS
	H	2483.50	46.99	30.22	4.85	23.98	45.60	54.00	-8.40	AV	PASS
	H	2500.00	61.02	30.22	4.85	23.98	59.63	74.00	-14.37	PK	PASS
	H	2500.00	47.74	30.22	4.85	23.98	46.35	54.00	-7.65	AV	PASS
	V	2483.50	61.14	30.22	4.85	23.98	59.75	74.00	-14.25	PK	PASS
	V	2483.50	46.10	30.22	4.85	23.98	44.71	54.00	-9.29	AV	PASS



	V	2500.00	61.23	30.22	4.85	23.98	59.84	74.00	-14.16	PK	PASS
	V	2500.00	46.74	30.22	4.85	23.98	45.35	54.00	-8.65	AV	PASS
	Low Channel 2422MHz										
	H	2390.00	61.22	30.22	4.85	23.98	59.83	74.00	-14.17	PK	PASS
	H	2390.00	48.35	30.22	4.85	23.98	46.96	54.00	-7.04	AV	PASS
	H	2400.00	61.52	30.22	4.85	23.98	60.13	74.00	-13.87	PK	PASS
	H	2400.00	47.99	30.22	4.85	23.98	46.60	54.00	-7.40	AV	PASS
	V	2390.00	60.94	30.22	4.85	23.98	59.55	74.00	-14.45	PK	PASS
	V	2390.00	46.34	30.22	4.85	23.98	44.95	54.00	-9.05	AV	PASS
	V	2400.00	61.18	30.22	4.85	23.98	59.79	74.00	-14.21	PK	PASS
	V	2400.00	47.49	30.22	4.85	23.98	46.10	54.00	-7.90	AV	PASS
	High Channel 2452MHz										
	H	2483.50	61.36	30.22	4.85	23.98	59.97	74.00	-14.03	PK	PASS
	H	2483.50	46.27	30.22	4.85	23.98	44.88	54.00	-9.12	AV	PASS
	H	2500.00	60.19	30.22	4.85	23.98	58.80	74.00	-15.20	PK	PASS
	H	2500.00	48.38	30.22	4.85	23.98	46.99	54.00	-7.01	AV	PASS
	V	2483.50	61.30	30.22	4.85	23.98	59.91	74.00	-14.09	PK	PASS
	V	2483.50	47.66	30.22	4.85	23.98	46.27	54.00	-7.73	AV	PASS
	V	2500.00	62.48	30.22	4.85	23.98	61.09	74.00	-12.91	PK	PASS
	V	2500.00	48.90	30.22	4.85	23.98	47.51	54.00	-6.49	AV	PASS

Remark:

1. Emission Level = Meter Reading + Antenna Factor + Cable Loss – Pre-amplifier, Margin= Emission Level - Limit



6. POWER SPECTRAL DENSITY TEST

Test Requirement:	FCC Part15 C Section 15.247 (e)
Test Method:	KDB558074 D0115.247 Meas Guidancev05r02

6.1 APPLIED PROCEDURES / LIMIT

FCC Part15 (15.247) , Subpart C				
Section	Test Item	Limit	Frequency Range (MHz)	Result
15.247	Power Spectral Density	8dBm/3kHz	2400-2483.5	PASS

6.2 TEST PROCEDURE

1. Set analyzer center frequency to DTS channel center frequency.
2. Set the span to 1.5 times the DTS bandwidth.
3. Set the RBW to: $3\text{ kHz} \leq \text{RBW} \leq 100\text{ kHz}$.
4. Set the VBW $\geq 3 \times \text{RBW}$.
5. Detector = peak.
6. Sweep time = auto couple.
7. Trace mode = max hold.
8. Allow trace to fully stabilize.
9. Use the peak marker function to determine the maximum amplitude level within the RBW.
10. If measured value exceeds limit, reduce RBW (no less than 3 kHz) and repeat.

6.3 DEVIATION FROM STANDARD

No deviation.

6.4 TEST SETUP



6.5 EUT OPERATION CONDITIONS

The EUT tested system was configured as the statements of 2.1 Unless otherwise a special operating condition is specified in the follows during the testing.



Temperature :	25.9°C	Relative Humidity :	52%
Pressure :	101kPa	Test Voltage :	AC 120V

Please refer to APPENDIX WIFI



7. CHANNEL BANDWIDTH

Test Requirement:	FCC Part15 C Section 15.247 (a)(2)
Test Method:	KDB558074 D0115.247 Meas Guidancev05r02

7.1 APPLIED PROCEDURES / LIMIT

FCC Part15 (15.247) , Subpart C				
Section	Test Item	Limit	Frequency Range (MHz)	Result
15.247(a)(2)	Bandwidth	$\geq 500\text{KHz}$ (6dB bandwidth)	2400-2483.5	PASS

7.2 TEST PROCEDURE

1. Set RBW = 100 kHz.
2. Set the video bandwidth (VBW) $\geq 3 \times$ RBW.
3. Detector = Peak.
4. Trace mode = max hold.
5. Sweep = auto couple.
6. Allow the trace to stabilize.
7. Measure the maximum width of the emission that is constrained by the frequencies associated with the two outermost amplitude points (upper and lower frequencies) that are attenuated by 6 dB relative to the maximum level measured in the fundamental emission.

7.3 DEVIATION FROM STANDARD

No deviation.

7.4 TEST SETUP

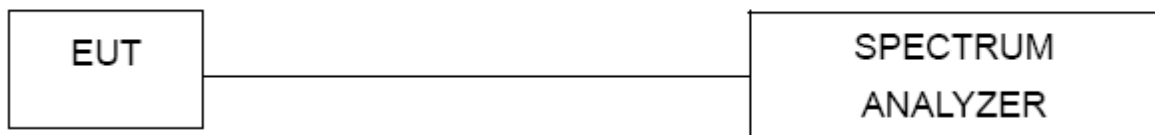

7.5 EUT OPERATION CONDITIONS

The EUT tested system was configured as the statements of 2.4 Unless otherwise a special operating condition is specified in the follows during the testing.



Temperature :	25.8°C	Relative Humidity :	52%
Pressure :	101kPa	Test Voltage :	AC 120V
Test Mode :	TX Mode		

Please refer to APPENDIX WIFI



8. OUTPUT POWER TEST

Test Requirement:	FCC Part15 C Section 15.247 (b)(3)
Test Method:	KDB558074 D0115.247 Meas Guidancev05r02

8.1 APPLIED PROCEDURES/LIMIT

FCC Part15 (15.247) , Subpart C				
Section	Test Item	Limit	Frequency Range (MHz)	Result
15.247(b)(3)	Peak Output Power	1 watt or 30dBm	2400-2483.5	PASS

8.2 TEST PROCEDURE

- a. The EUT was directly connected to the Spectrum analyzer

8.3 DEVIATION FROM STANDARD

No deviation.

8.4 TEST SETUP

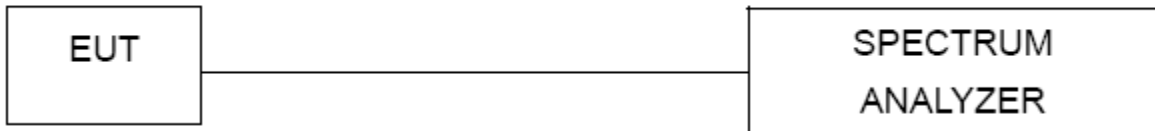

8.5 EUT OPERATION CONDITIONS

1. Remove the antenna from the EUT and then connect a low RF cable from the antenna port to the spectrum.
2. Set the spectrum analyzer: RBW = 1MHz. VBW =3MHz. Sweep = auto; Detector Function = Peak.
3. Keep the EUT in transmitting at lowest, medium and highest channel individually. Record the max value.

8.6 TEST RESULT

Temperature :	25.3°C	Relative Humidity :	55%
Pressure :	101kPa	Test Voltage :	AC 120V

Please refer to APPENDIX WIFI



9. CONDUCTED BAND EDGE AND SPURIOUS EMISSION

Test Requirement:	FCC Part15 C Section 15.247 (d)
Test Method:	KDB558074 D0115.247 Meas Guidanceev05r02

9.1 APPLICABLE STANDARD

in any 100 kHz bandwidth outside the frequency bands in which the spread spectrum intentional radiator is operating, the radio frequency power that is produced by the intentional radiator shall be at least 20dB below that in the 100kHz bandwidth within the band that contains the highest level of the desired power, In addition, radiated emissions which fall in the restricted bands, as defined in§15.205(a), must also comply with the radiated emission limits specified in15.209(a).

9.2 TEST PROCEDURE

Using the following spectrum analyzer setting:

- A) Set the RBW = 100KHz.
- B) Set the VBW = 300KHz.
- C) Sweep time = auto couple.
- D) Detector function = peak.
- E) Trace mode = max hold.
- F) Allow trace to fully stabilize.

9.3 DEVIATION FROM STANDARD

No deviation.

9.4 TEST SETUP

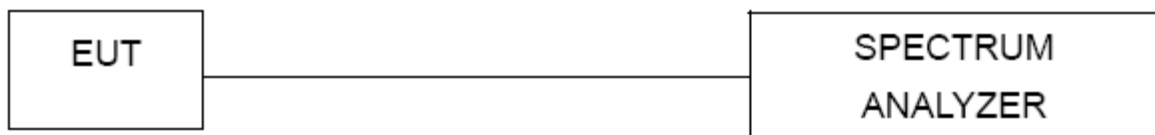

9.5 EUT OPERATION CONDITIONS

The EUT tested system was configured as the statements of 2.4 Unless otherwise a special operating condition is specified in the follows during the testing.

9.6 TEST RESULTS

Please refer to APPENDIX WIFI



10. ANTENNA REQUIREMENT

Standard requirement:	FCC Part15 C Section 15.203 /247(b)(4)
15.203 requirement: An intentional radiator shall be designed to ensure that no antenna other than that furnished by the responsible party shall be used with the device. The use of a permanently attached antenna or of an antenna that uses a unique coupling to the intentional radiator, the manufacturer may design the unit so that a broken antenna can be replaced by the user, but the use of a standard antenna jack or electrical connector is prohibited.	
15.247(b) (4) requirement: (4) The conducted output power limit specified in paragraph (b) of this section is based on the use of antennas with directional gains that do not exceed 6 dBi. Except as shown in paragraph (c) of this section, if transmitting antennas of directional gain greater than 6 dBi are used, the conducted output power from the intentional radiator shall be reduced below the stated values in paragraphs (b)(1), (b)(2), and (b)(3) of this section, as appropriate, by the amount in dB that the directional gain of the antenna exceeds 6 dBi.	
EUT Antenna: The antenna is FPC Antenna, the best case gain of the antenna is 5.07dBi, reference to the appendix II for details	



11. APPENDIX WIFI

11.1 DUTY CYCLE

Mode	Frequency (MHz)	Antenna	Duty Cycle (%)	Correction Factor (dB)	1/T (kHz)
b	2412	Ant1	89.13	0.5	0.12
b	2437	Ant1	89.13	0.5	0.12
b	2462	Ant1	89.13	0.5	0.12
b	2412	Ant2	89.13	0.5	0.12
b	2437	Ant2	89.02	0.51	0.12
b	2462	Ant2	89.13	0.5	0.12
g	2412	Ant1	57.38	2.41	0.74
g	2437	Ant1	57.81	2.38	0.73
g	2462	Ant1	57.63	2.39	0.74
g	2412	Ant2	57.38	2.41	0.74
g	2437	Ant2	57.63	2.39	0.74
g	2462	Ant2	57.38	2.41	0.74
n20	2412	Ant1	55.95	2.52	0.79
n20	2437	Ant1	55.95	2.52	0.79
n20	2462	Ant1	56.14	2.51	0.78
n20	2412	Ant2	56.14	2.51	0.78
n20	2437	Ant2	56.14	2.51	0.78
n20	2462	Ant2	56.14	2.51	0.78
n40	2422	Ant1	39.02	4.09	1.56
n40	2437	Ant1	39.02	4.09	1.56
n40	2452	Ant1	38.65	4.13	1.59
n40	2422	Ant2	38.41	4.16	1.59
n40	2437	Ant2	38.41	4.16	1.59
n40	2452	Ant2	39.02	4.09	1.56



Test Graphs Duty Cycle NVNT b 2412MHz Ant1

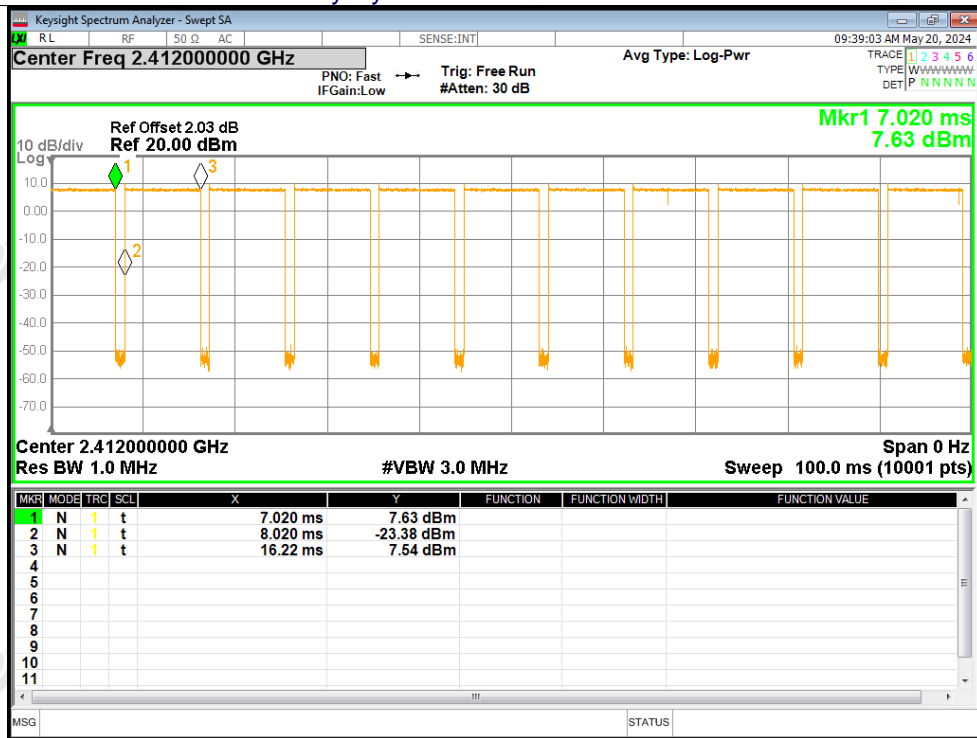

Duty Cycle NVNT b 2437MHz Ant1

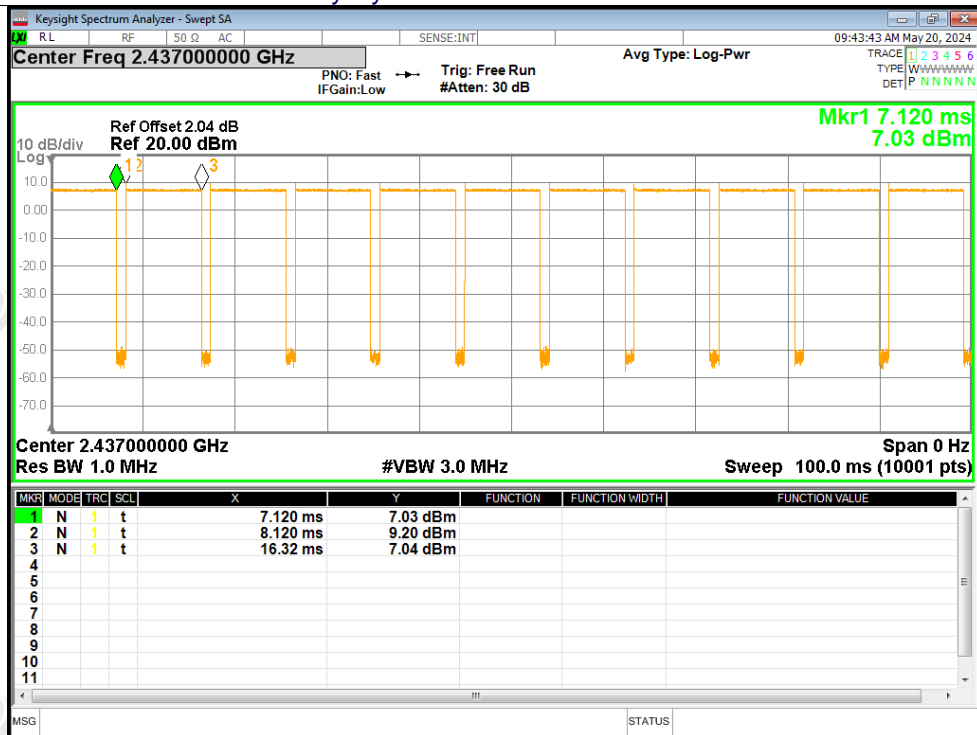



Duty Cycle NVNT b 2462MHz Ant1

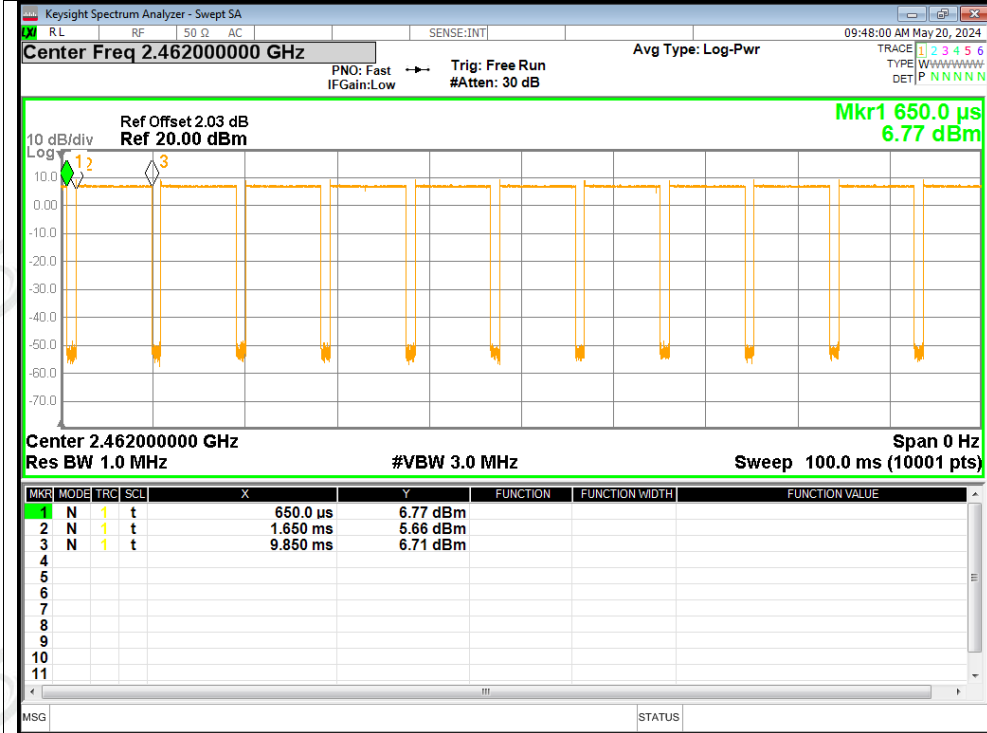

Duty Cycle NVNT b 2412MHz Ant2

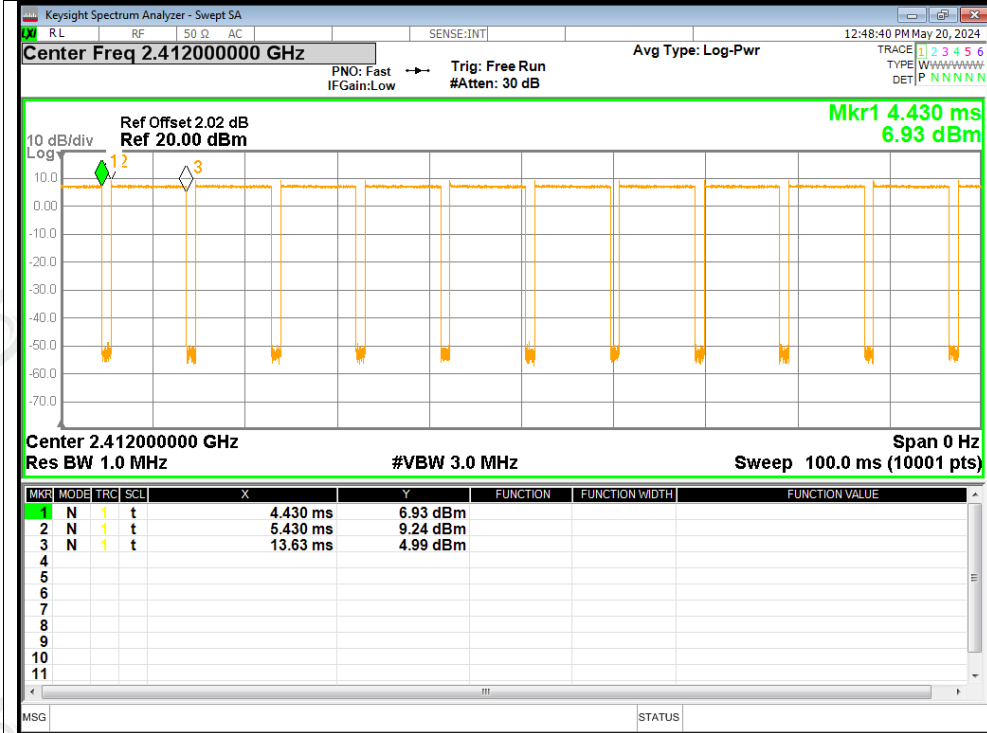



Duty Cycle NVNT b 2437MHz Ant2

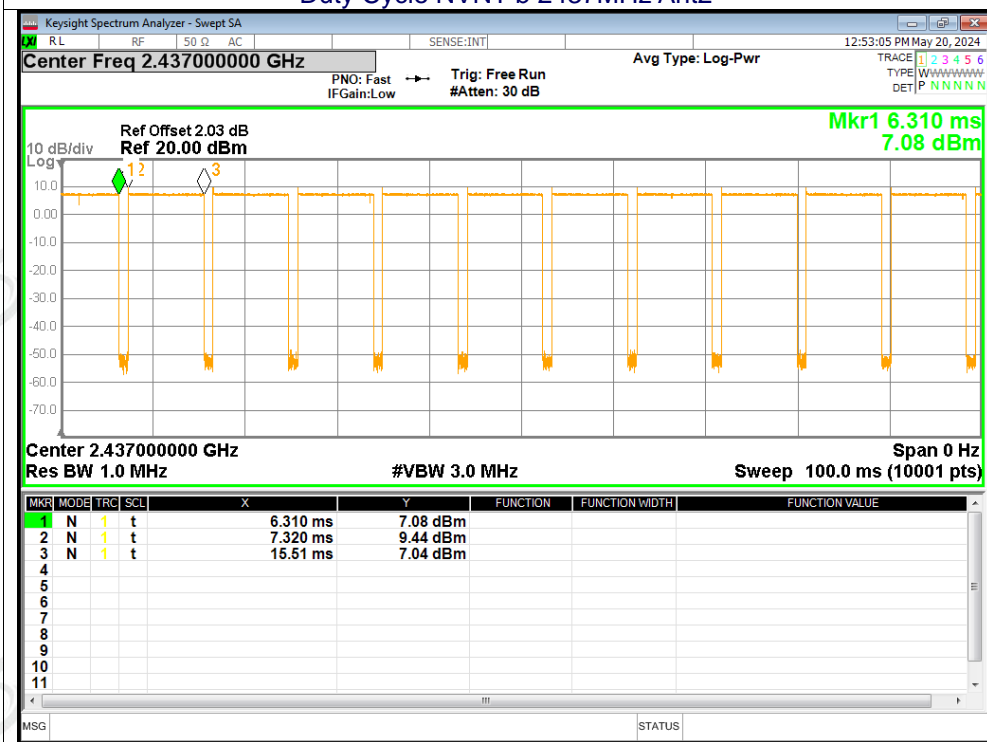

Duty Cycle NVNT b 2462MHz Ant2

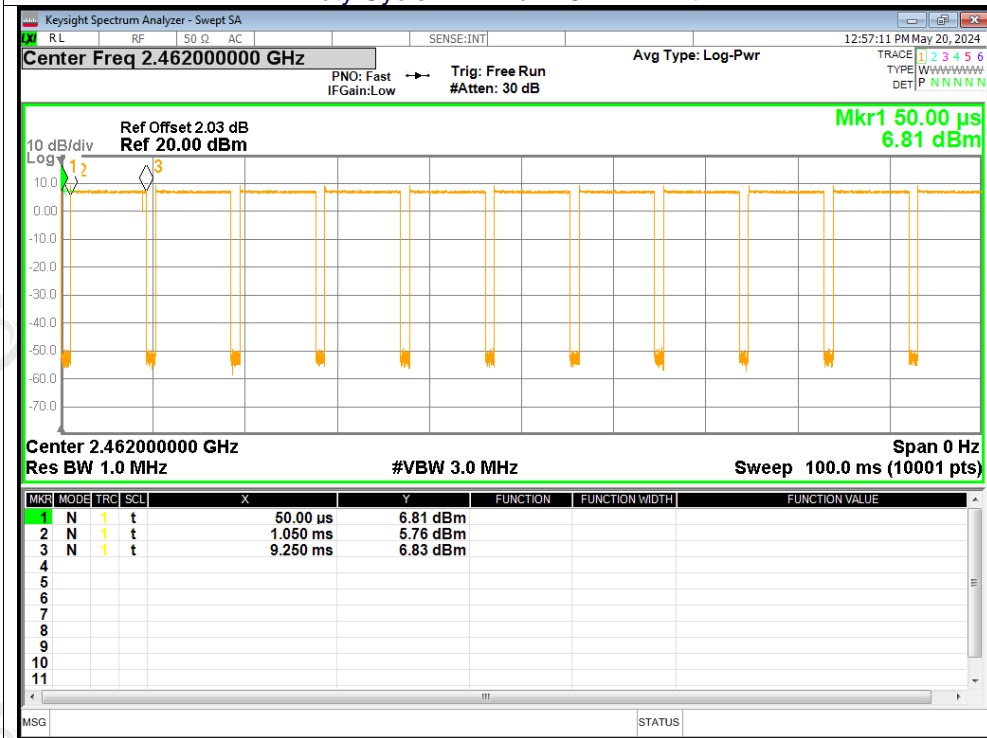



Duty Cycle NVNT g 2412MHz Ant1

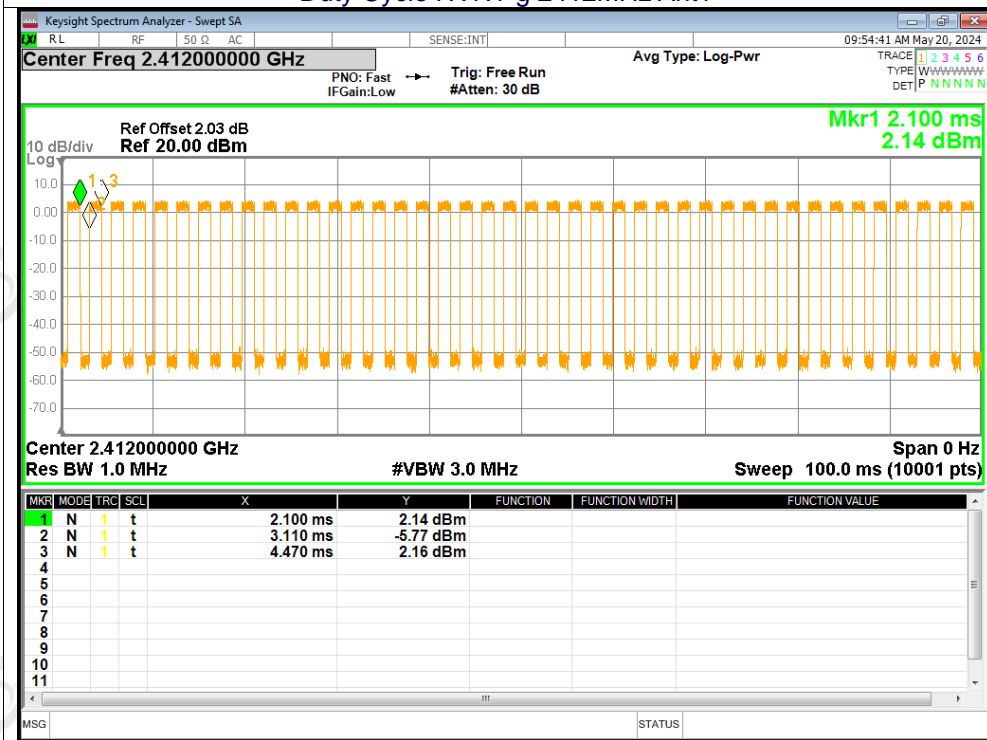

Duty Cycle NVNT g 2437MHz Ant1

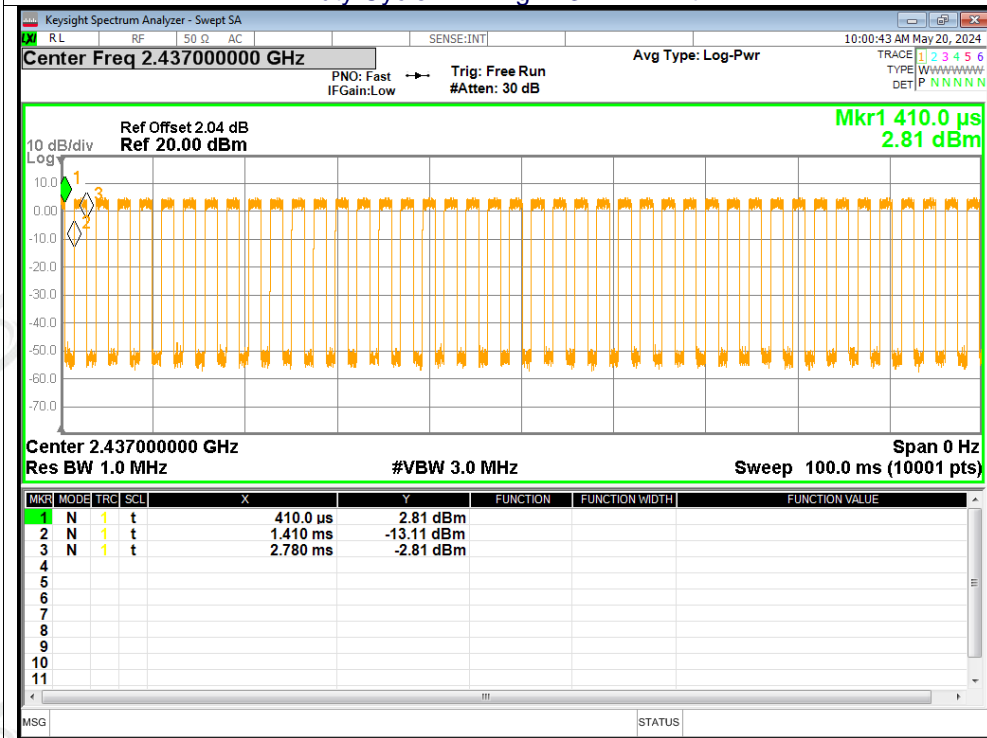



Duty Cycle NVNT g 2462MHz Ant1

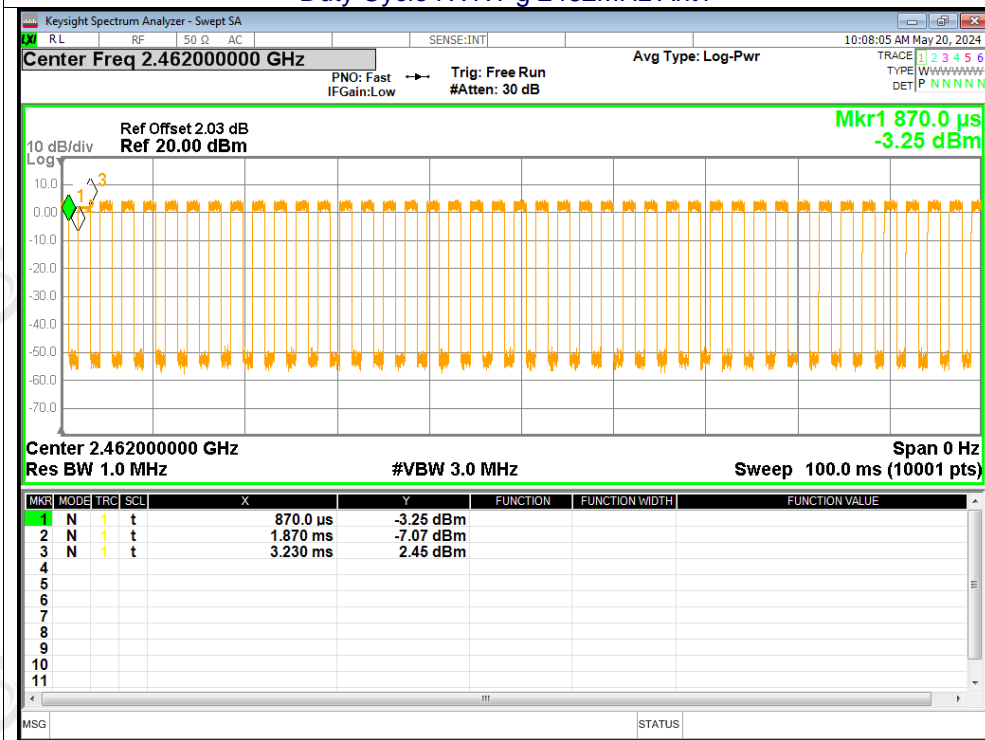

Duty Cycle NVNT g 2412MHz Ant2

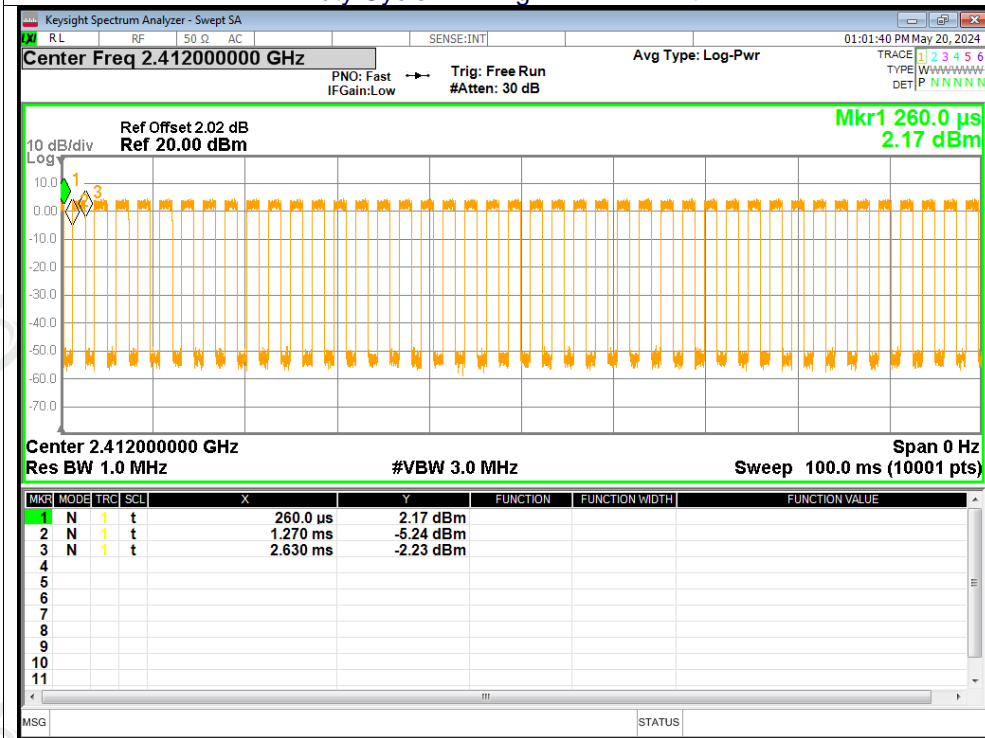



Duty Cycle NVNT g 2437MHz Ant2

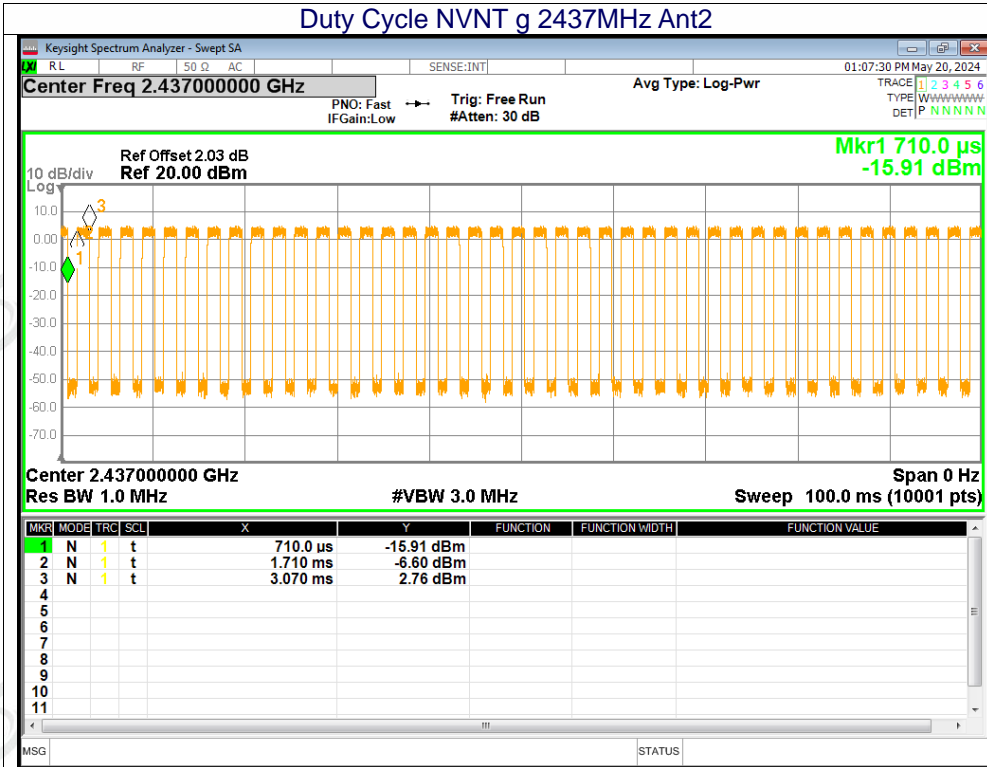

Duty Cycle NVNT g 2462MHz Ant2

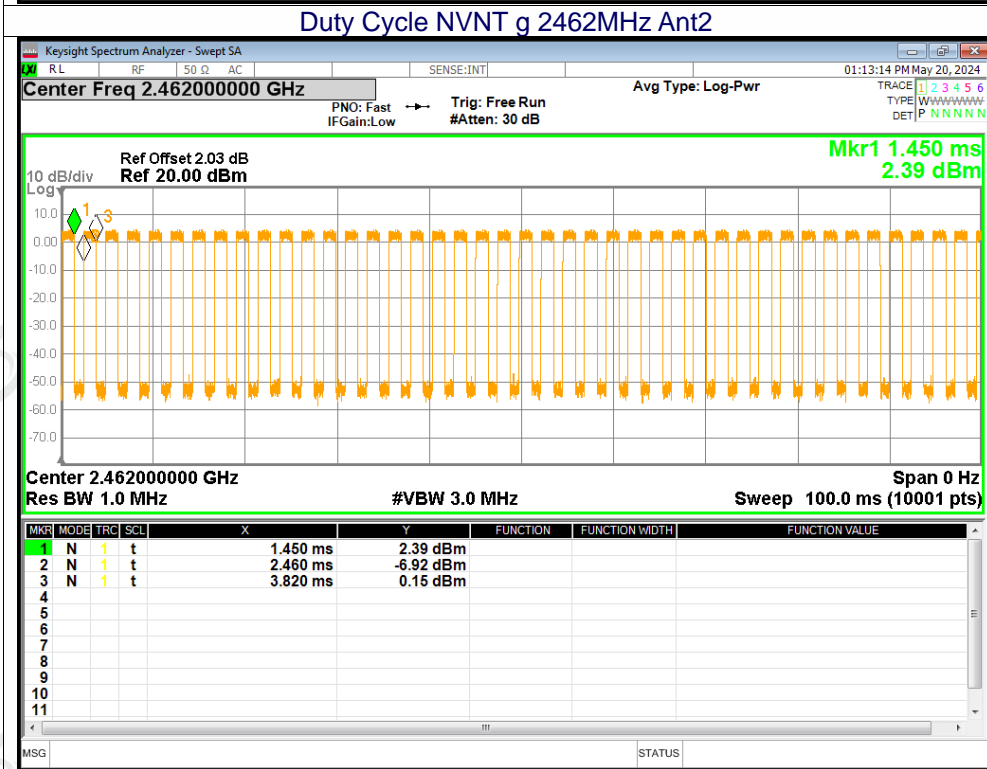



Duty Cycle NVNT n20 2412MHz Ant1

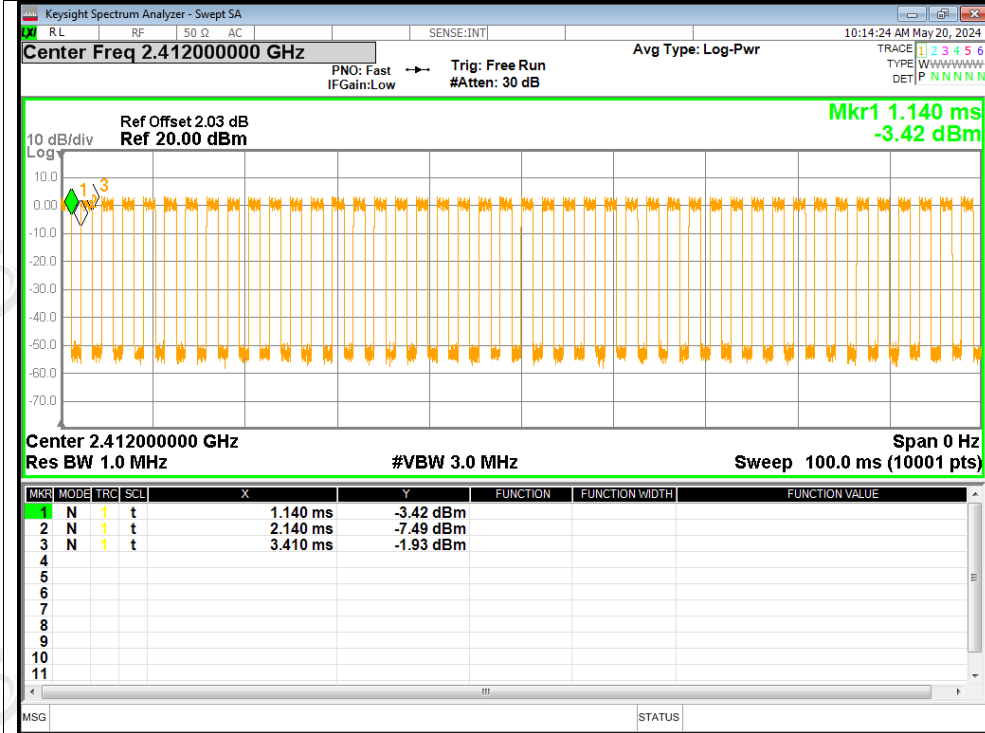

Duty Cycle NVNT n20 2437MHz Ant1

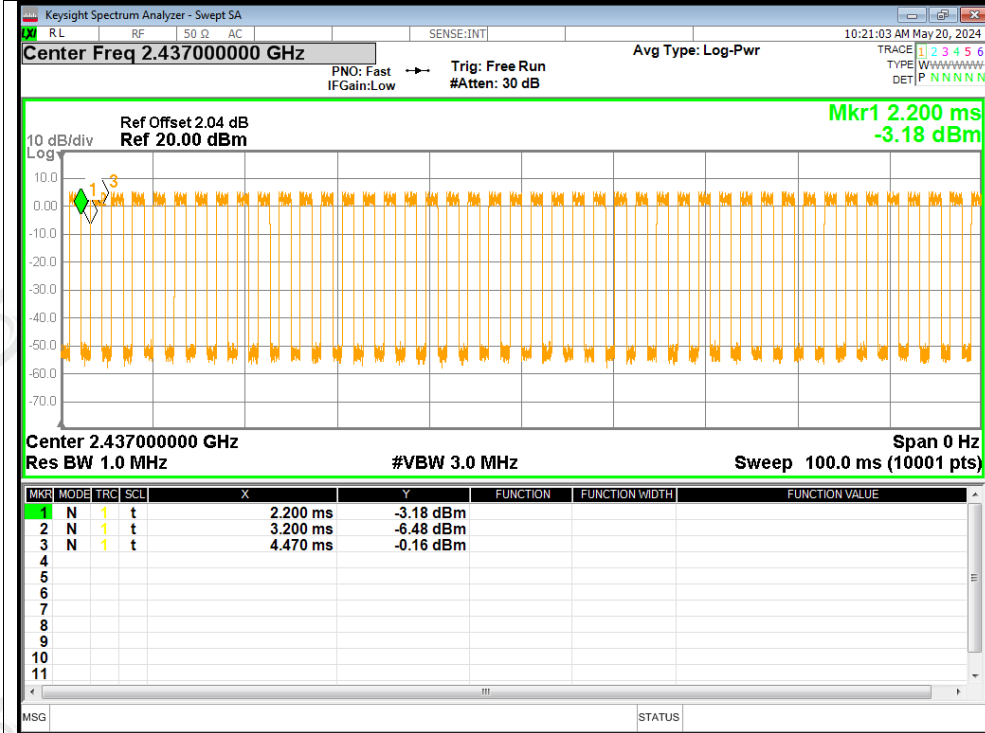



Duty Cycle NVNT n20 2462MHz Ant1

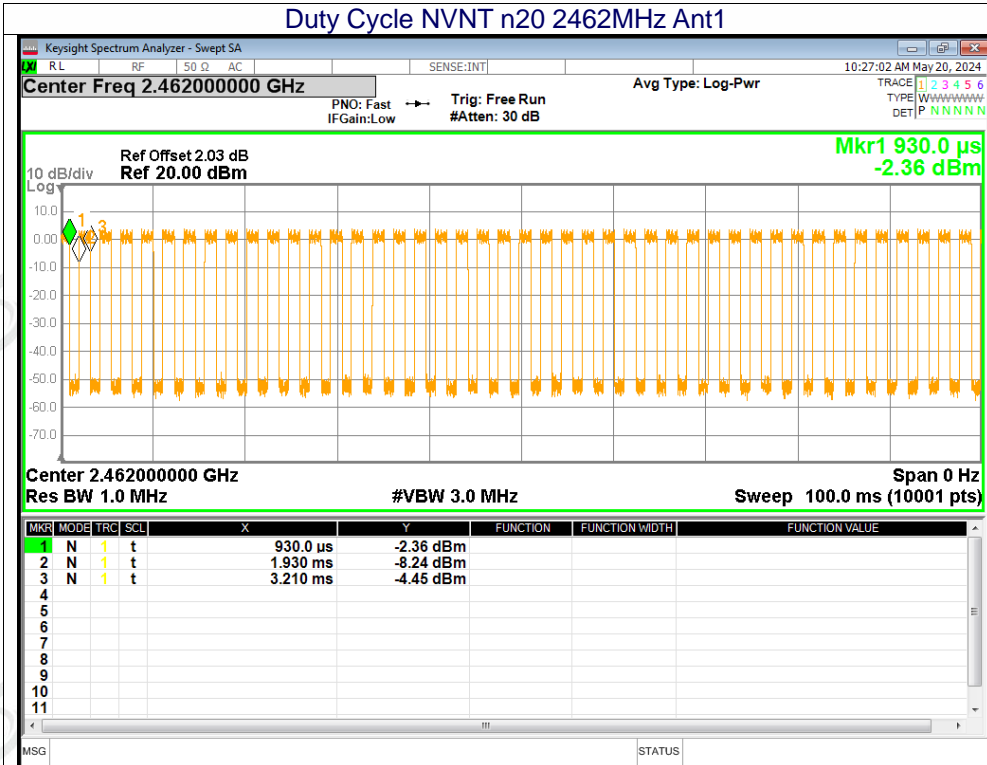

Duty Cycle NVNT n20 2412MHz Ant2

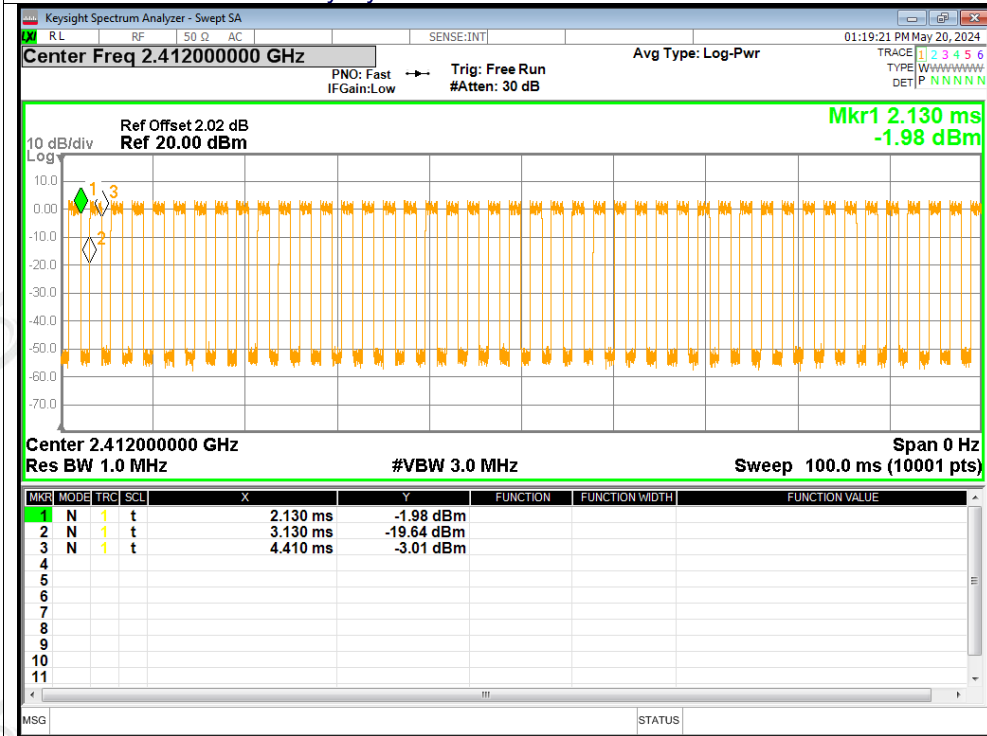



Duty Cycle NVNT n20 2437MHz Ant2

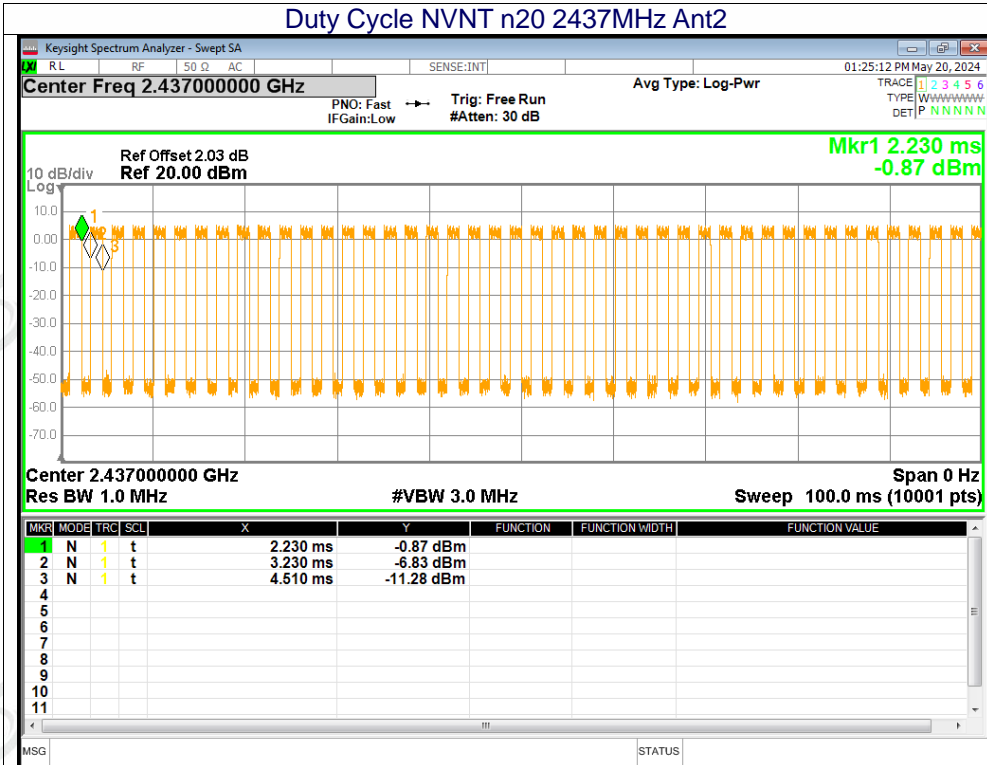

Duty Cycle NVNT n20 2462MHz Ant2

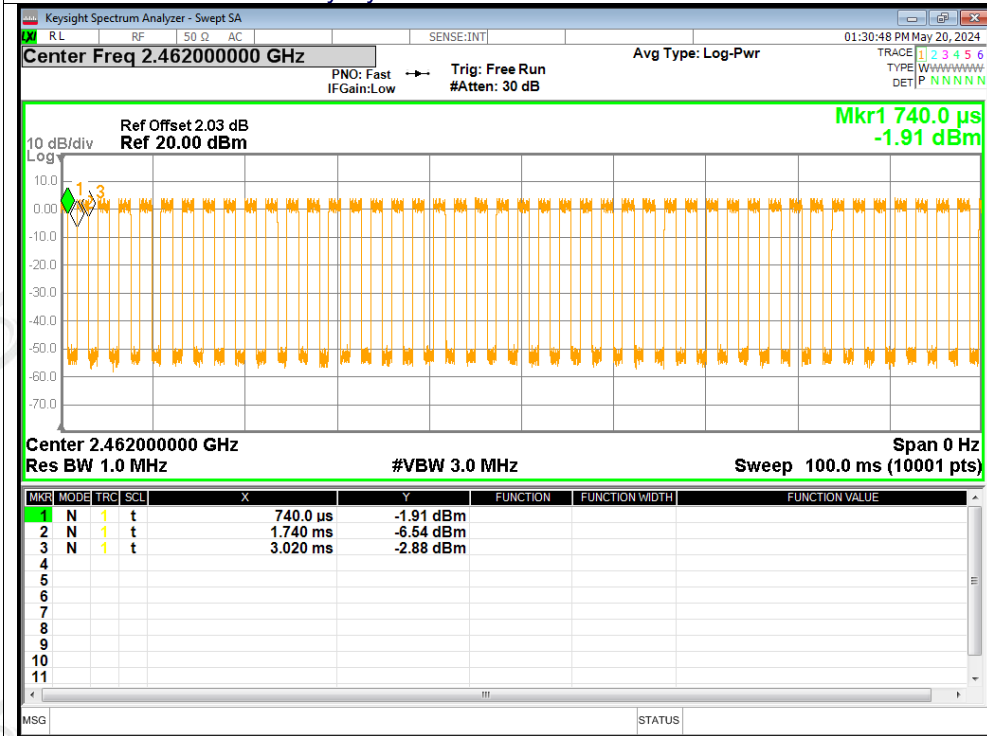



Duty Cycle NVNT n40 2422MHz Ant1

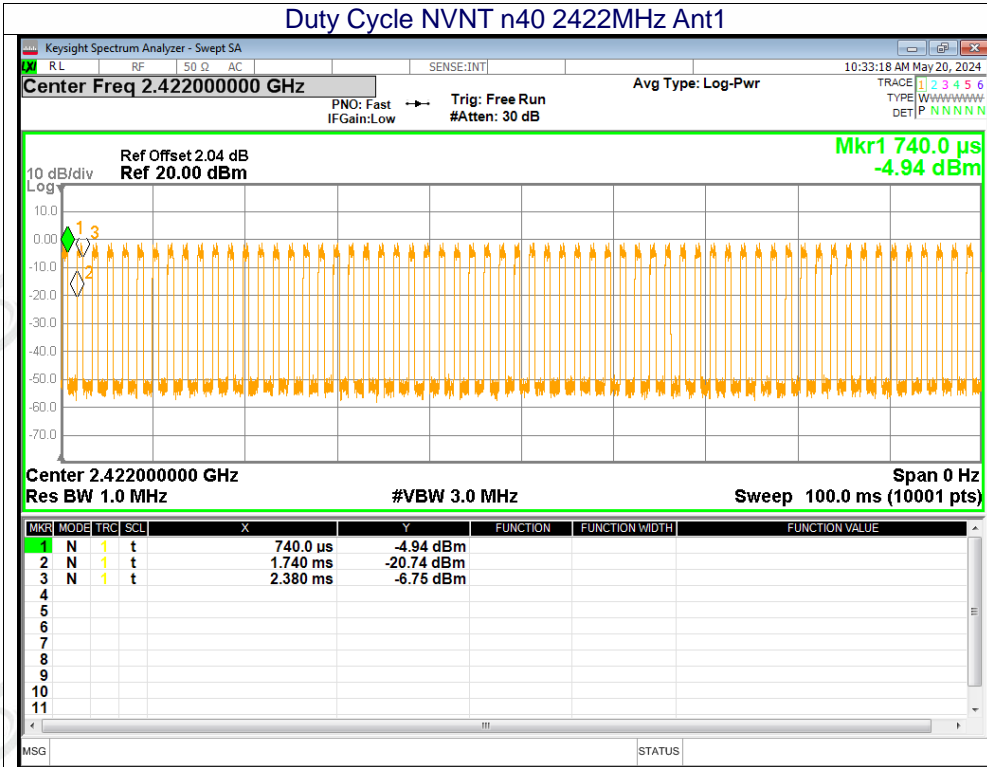

Duty Cycle NVNT n40 2437MHz Ant1

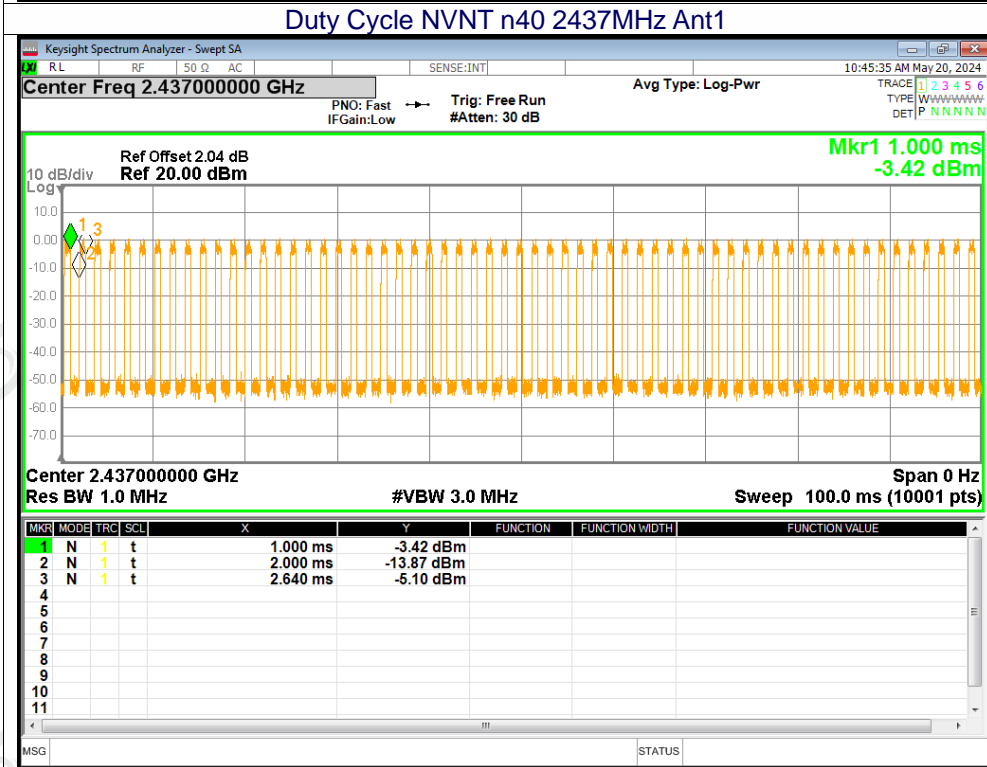



Duty Cycle NVNT n40 2452MHz Ant1

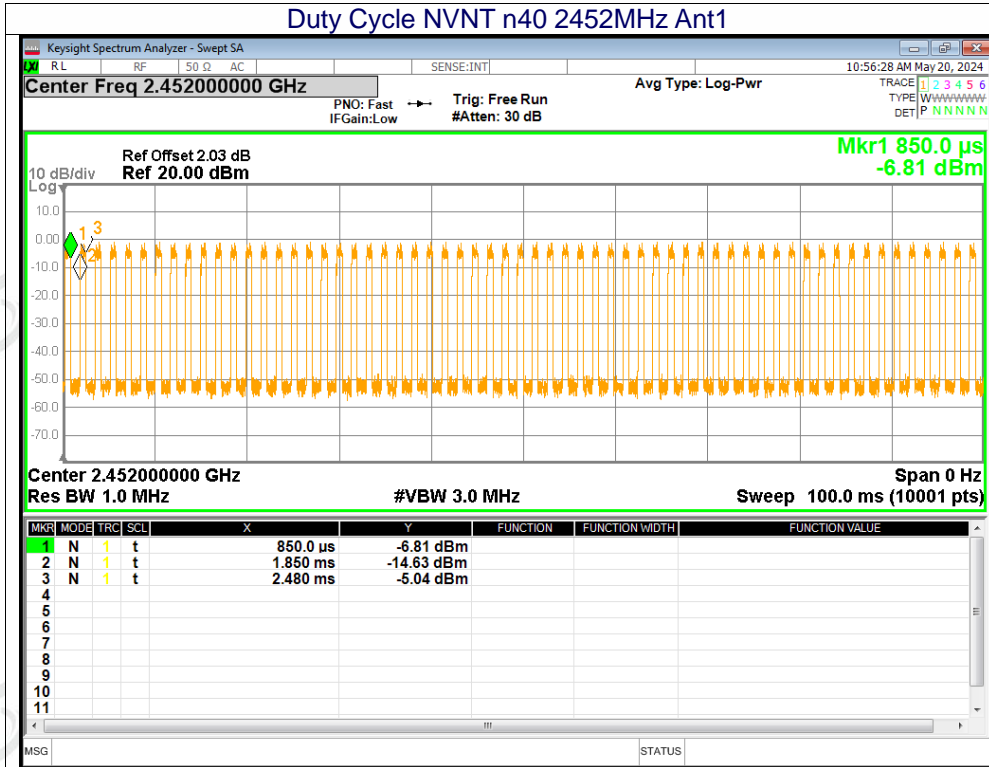

Duty Cycle NVNT n40 2422MHz Ant2

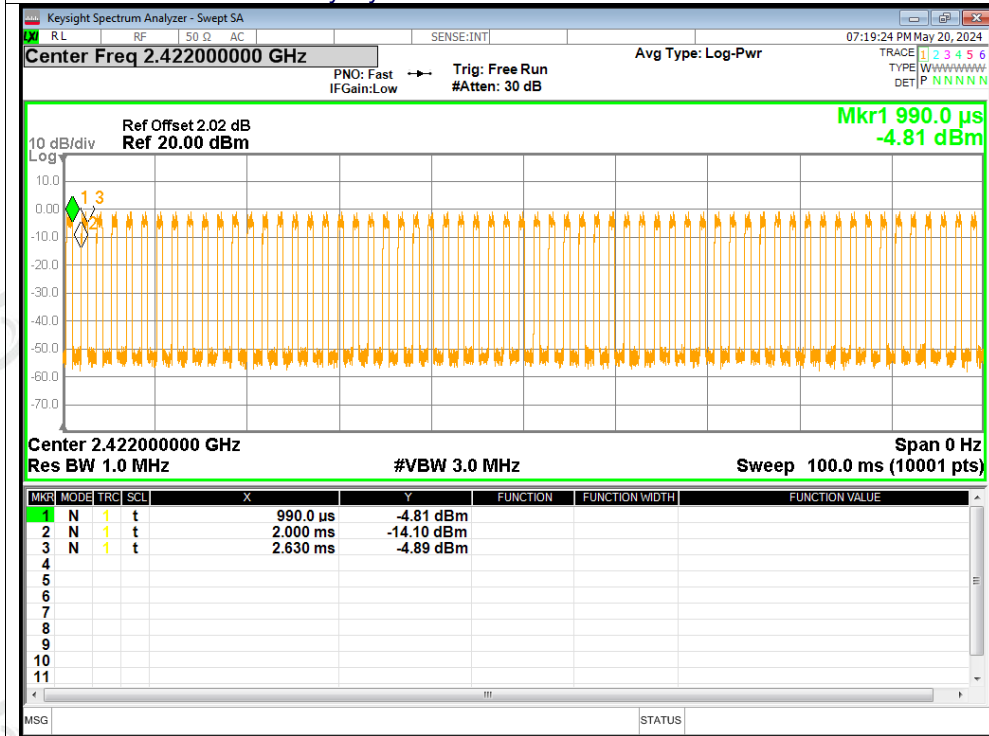



Duty Cycle NVNT n40 2437MHz Ant2

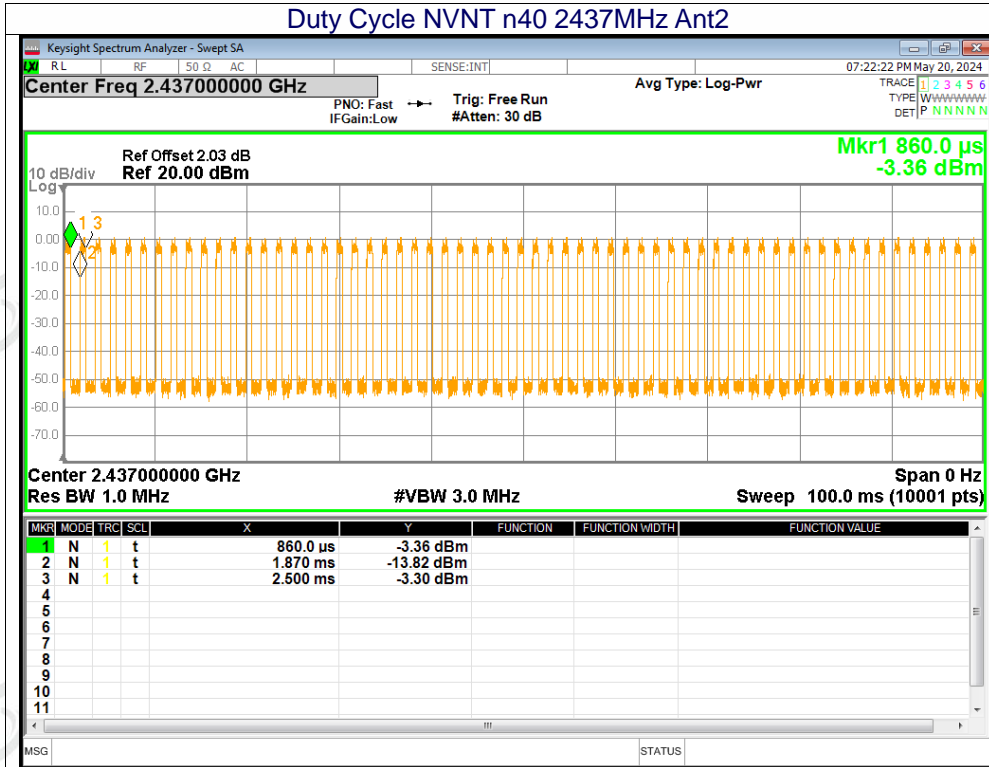

Duty Cycle NVNT n40 2452MHz Ant2

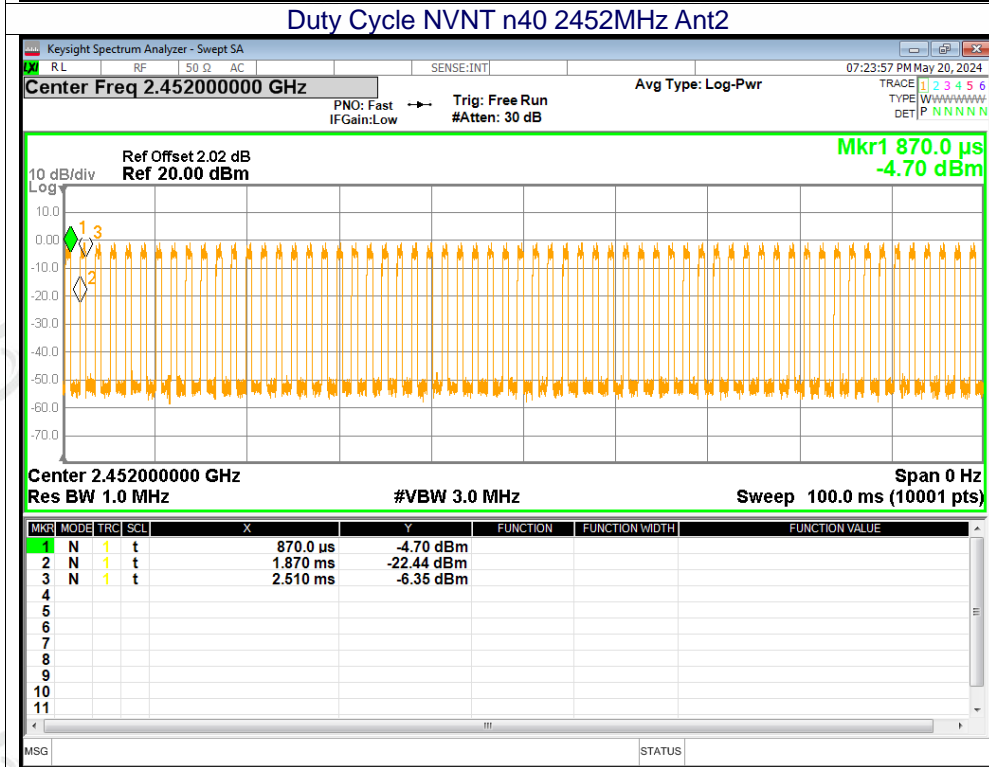



11.2 MAXIMUM AVERAGE CONDUCTED OUTPUT POWER

Mode	Frequency (MHz)	Antenna	Total Power (dBm)	Limit (dBm)	Verdict
b	2412	Ant1	13.28	30	Pass
b	2437	Ant1	12.95	30	Pass
b	2462	Ant1	12.67	30	Pass
b	2412	Ant2	13	30	Pass
b	2437	Ant2	12.86	30	Pass
b	2462	Ant2	12.68	30	Pass
g	2412	Ant1	10.95	30	Pass
g	2437	Ant1	11.07	30	Pass
g	2462	Ant1	10.55	30	Pass
g	2412	Ant2	10.57	30	Pass
g	2437	Ant2	11.16	30	Pass
g	2462	Ant2	10.73	30	Pass
n20	2412	Ant1	8.72	30	Pass
n20	2437	Ant1	10.85	30	Pass
n20	2462	Ant1	9.74	30	Pass
n20	2412	Ant2	8.78	30	Pass
n20	2437	Ant2	11.14	30	Pass
n20	2462	Ant2	9.74	30	Pass
n40	2422	Ant1	9.69	30	Pass
n40	2437	Ant1	11.38	30	Pass
n40	2452	Ant1	9.51	30	Pass
n40	2422	Ant2	10.79	30	Pass
n40	2437	Ant2	11.72	30	Pass
n40	2452	Ant2	9.94	30	Pass



Test Graphs Average Power NVNT b 2412MHz Ant1

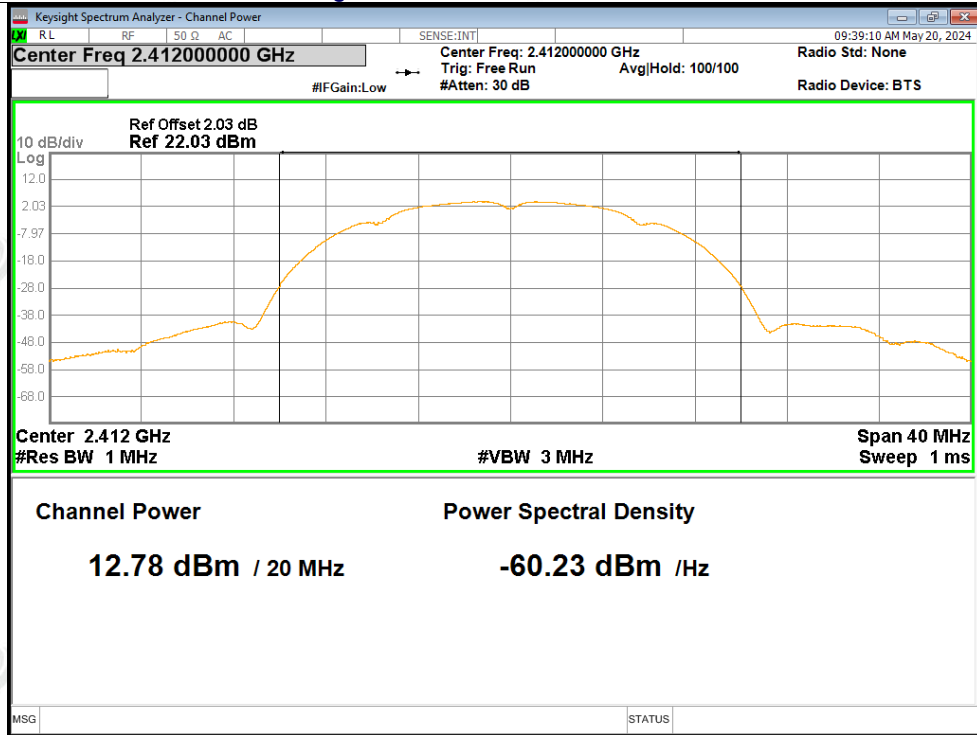

Average Power NVNT b 2437MHz Ant1

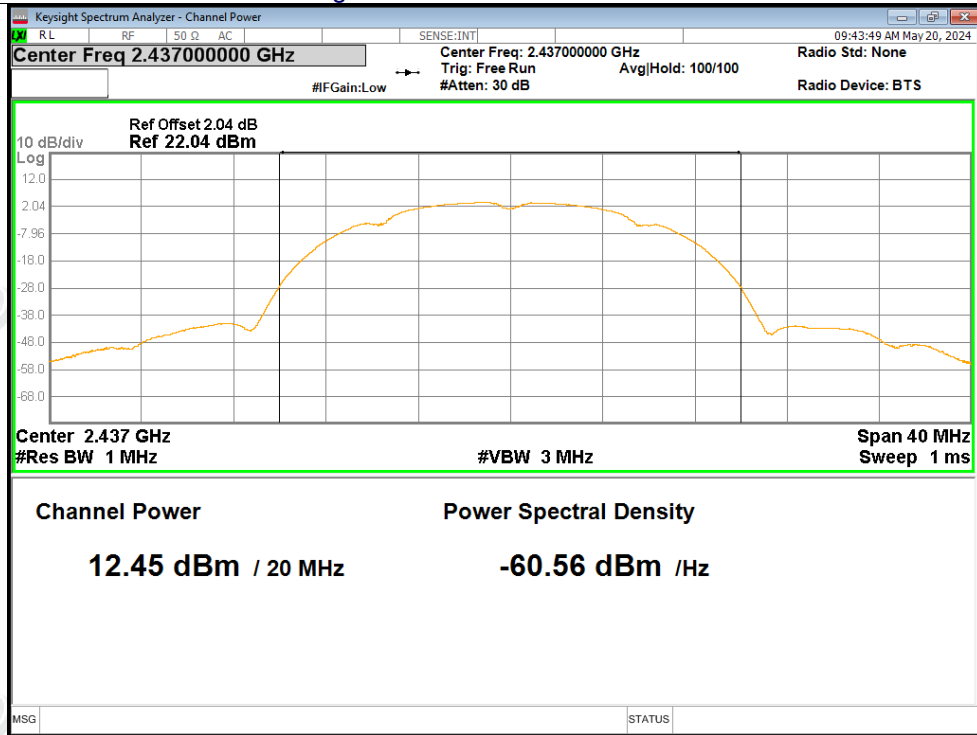



Average Power NVNT b 2462MHz Ant1

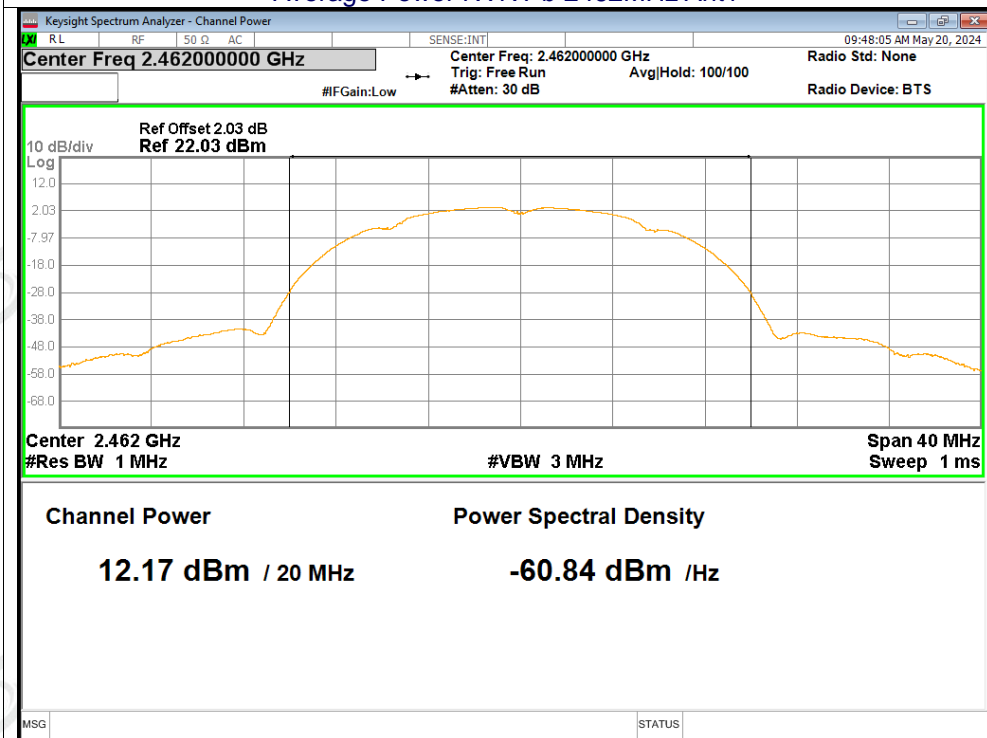

Average Power NVNT b 2412MHz Ant2

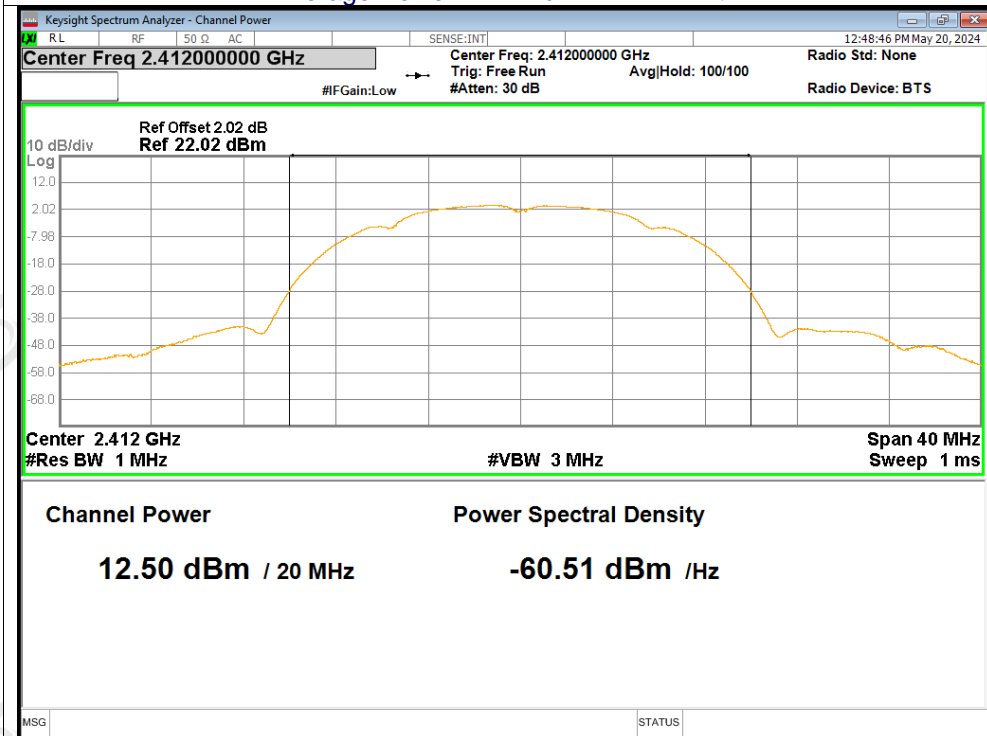



Average Power NVNT b 2437MHz Ant2

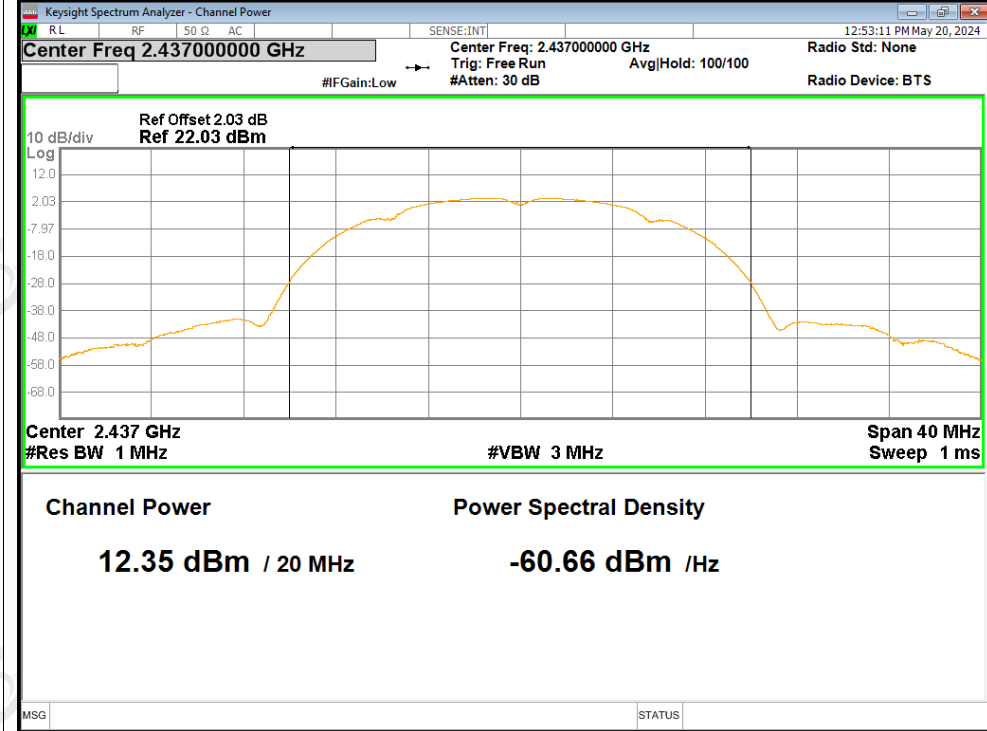

Average Power NVNT b 2462MHz Ant2

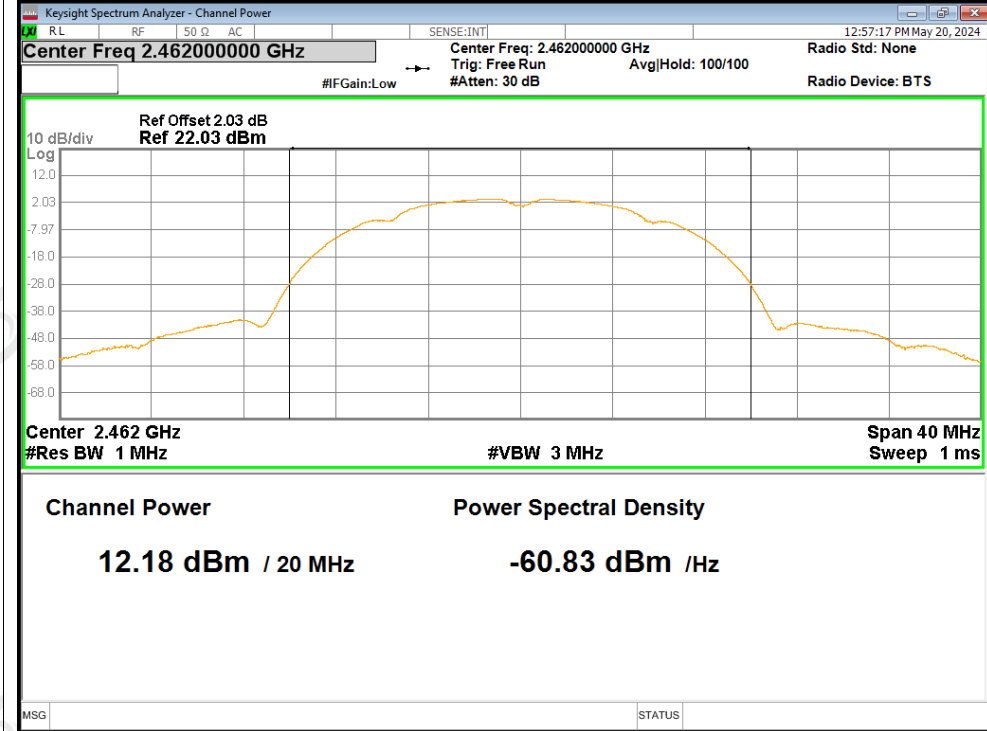



Average Power NVNT g 2412MHz Ant1

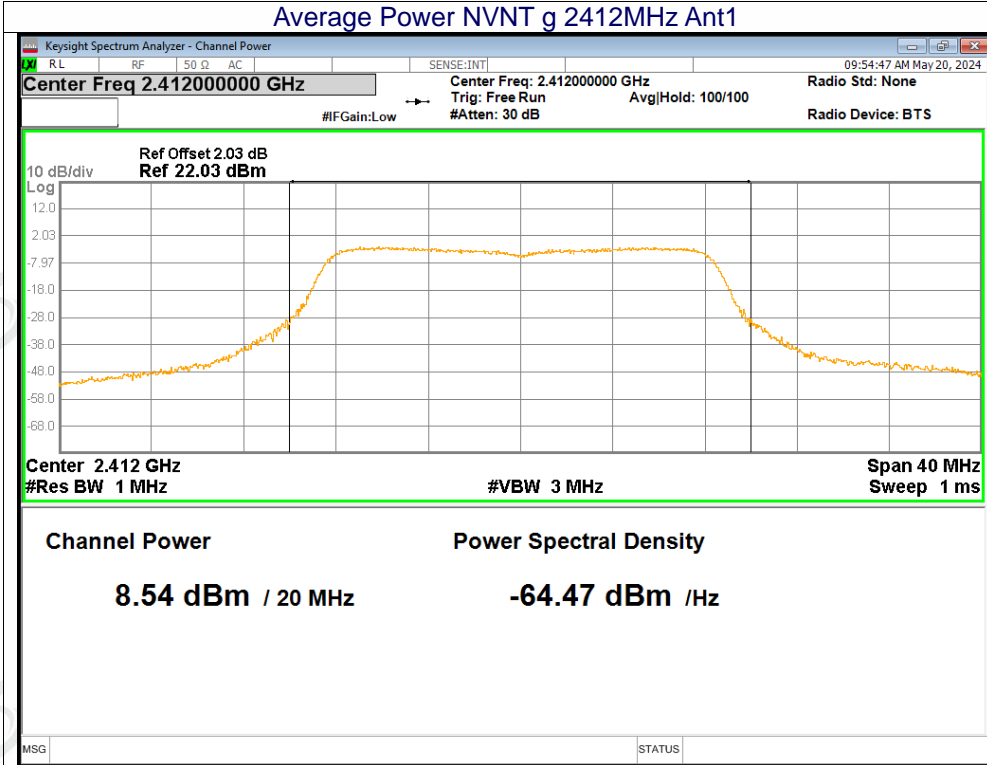

Average Power NVNT g 2437MHz Ant1

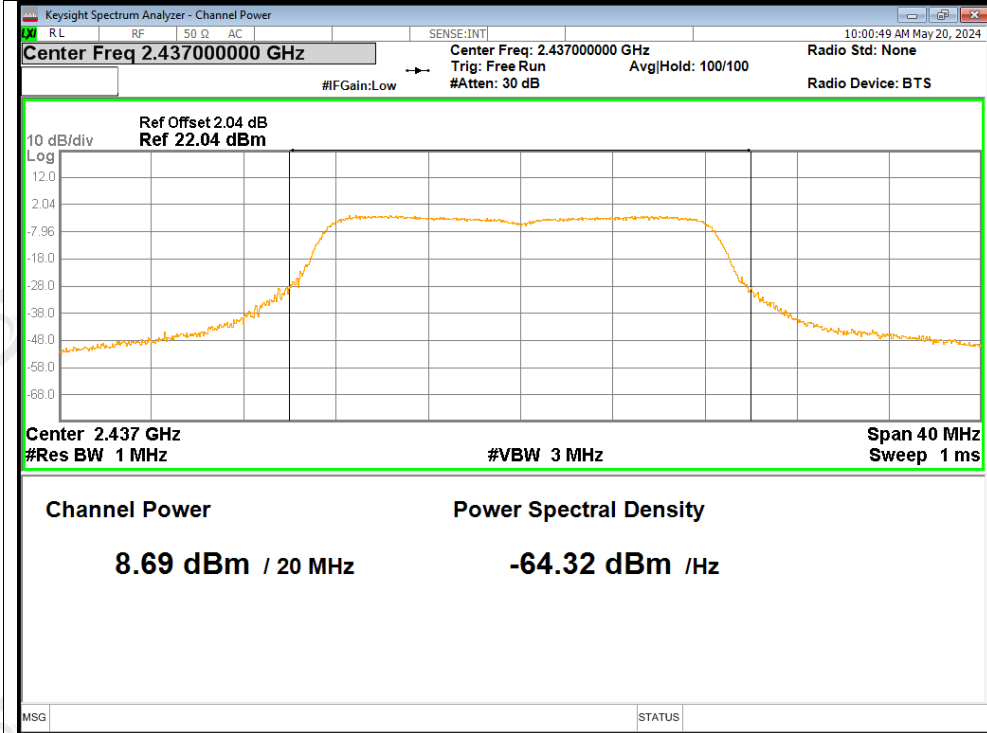



Average Power NVNT g 2462MHz Ant1

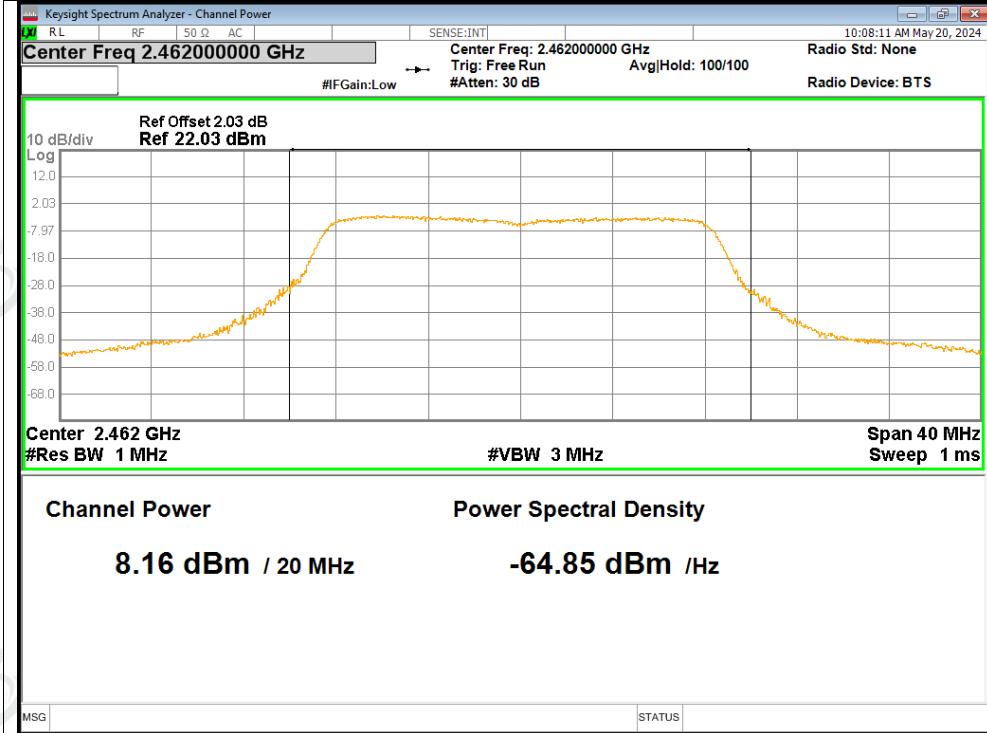

Average Power NVNT g 2412MHz Ant2

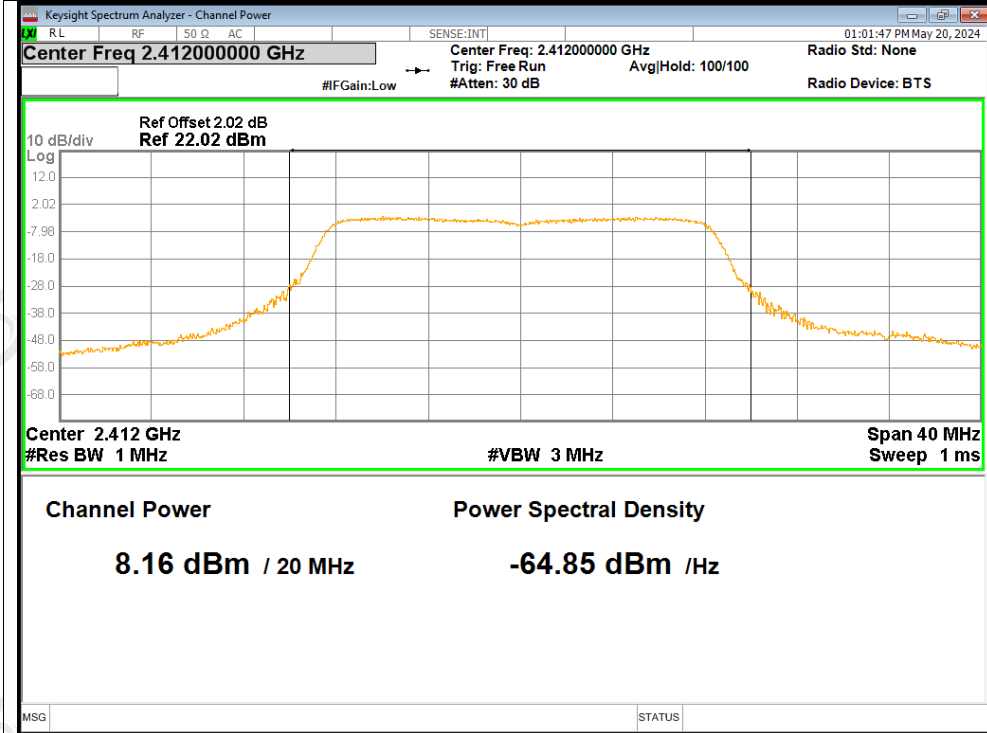



Average Power NVNT g 2437MHz Ant2

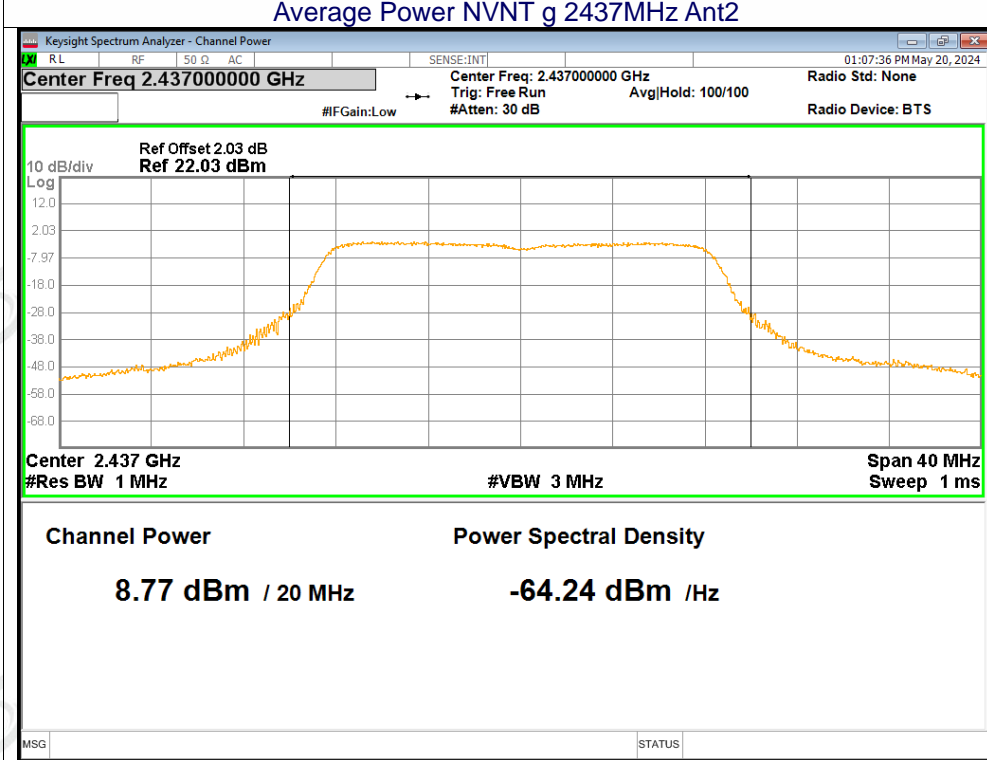

Average Power NVNT g 2462MHz Ant2

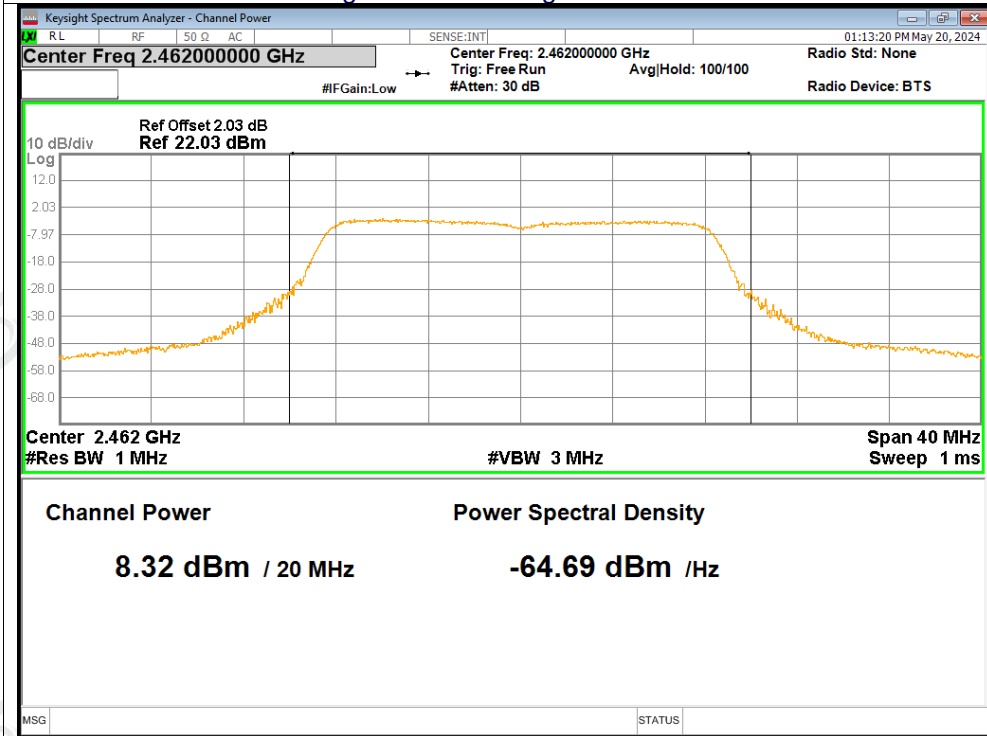



Average Power NVNT n20 2412MHz Ant1

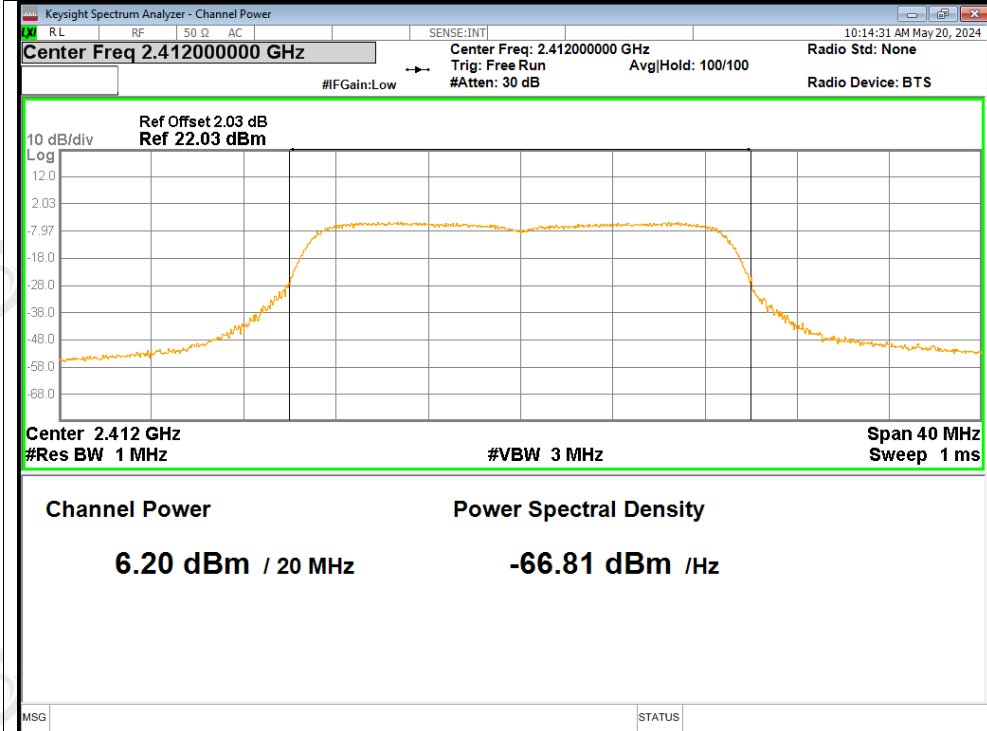

Average Power NVNT n20 2437MHz Ant1

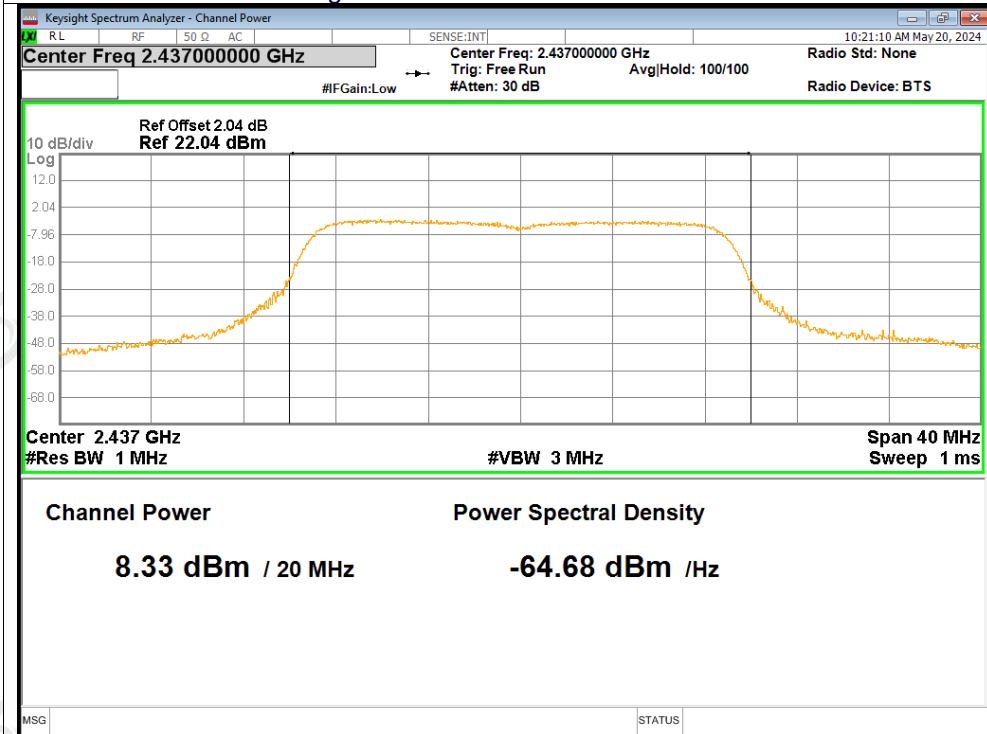



Average Power NVNT n20 2462MHz Ant1

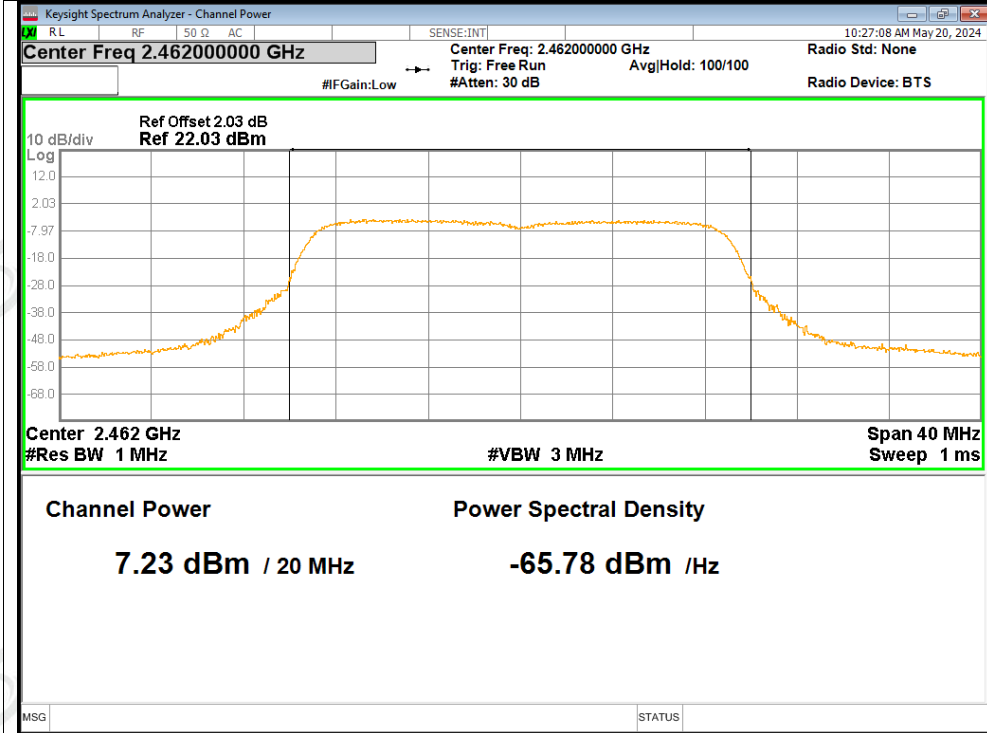

Average Power NVNT n20 2412MHz Ant2

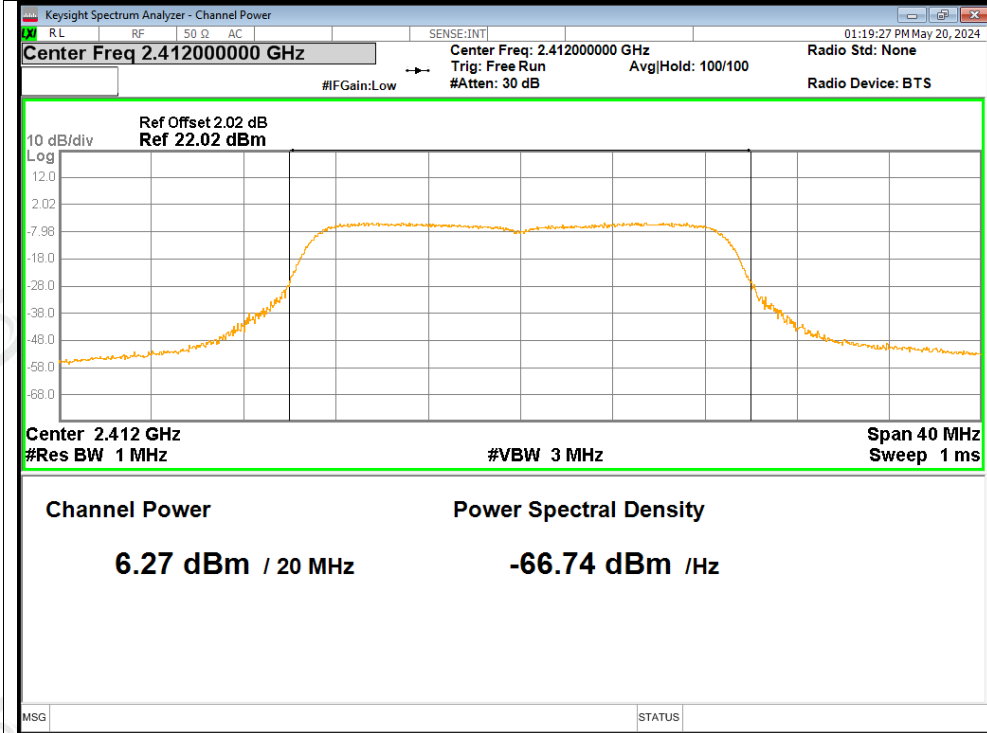



Average Power NVNT n20 2437MHz Ant2

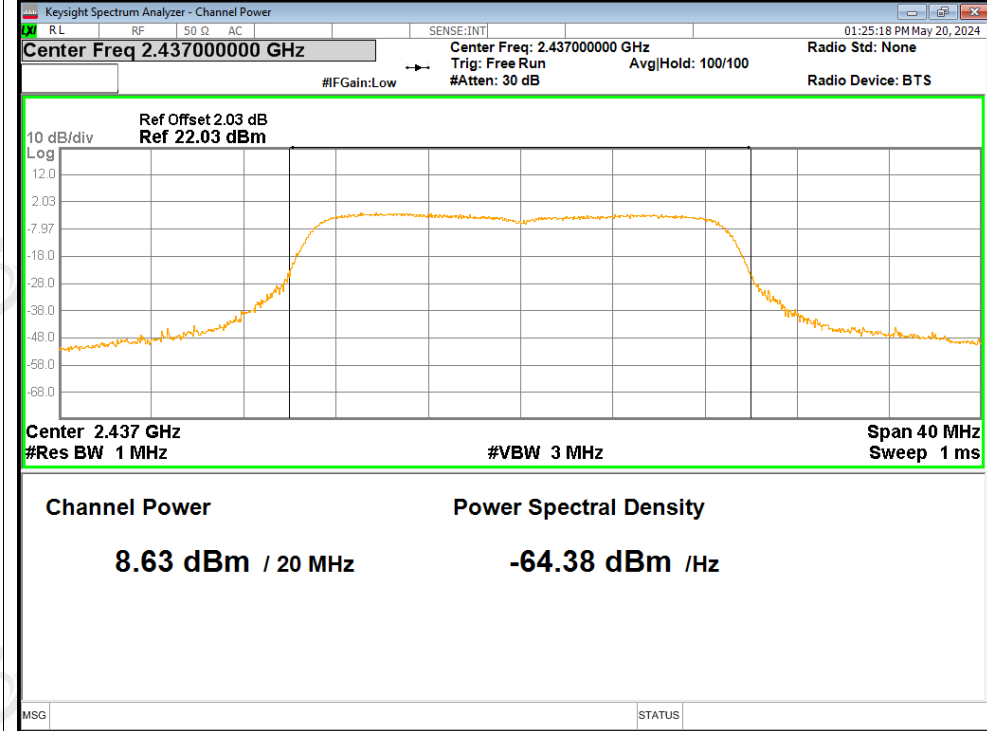

Average Power NVNT n20 2462MHz Ant2

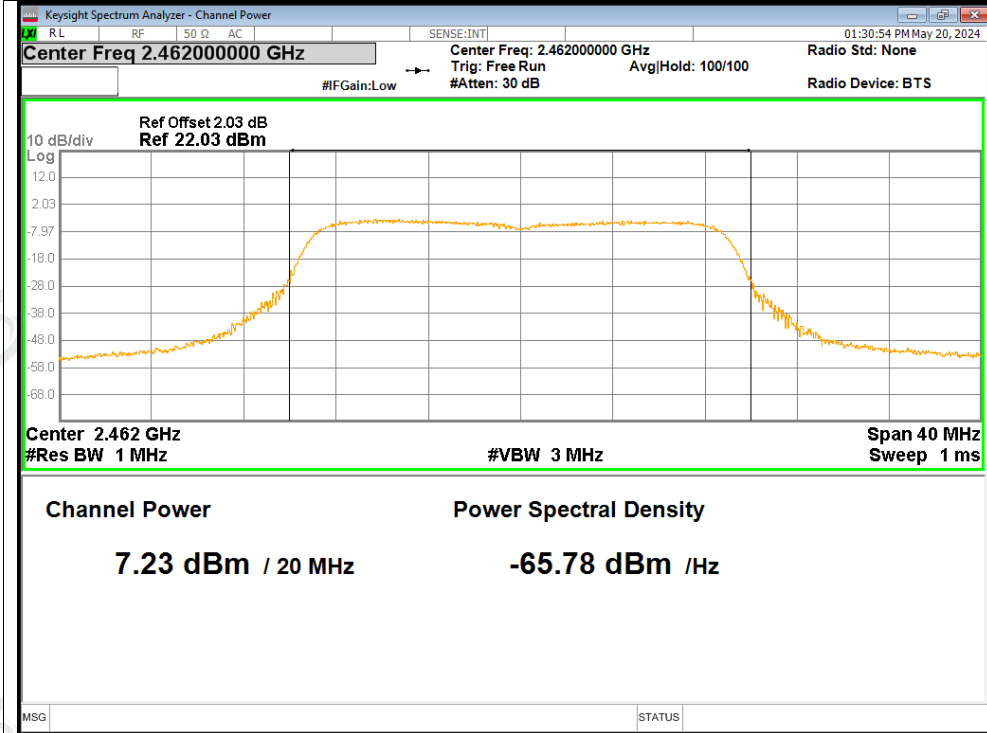



Average Power NVNT n40 2422MHz Ant1

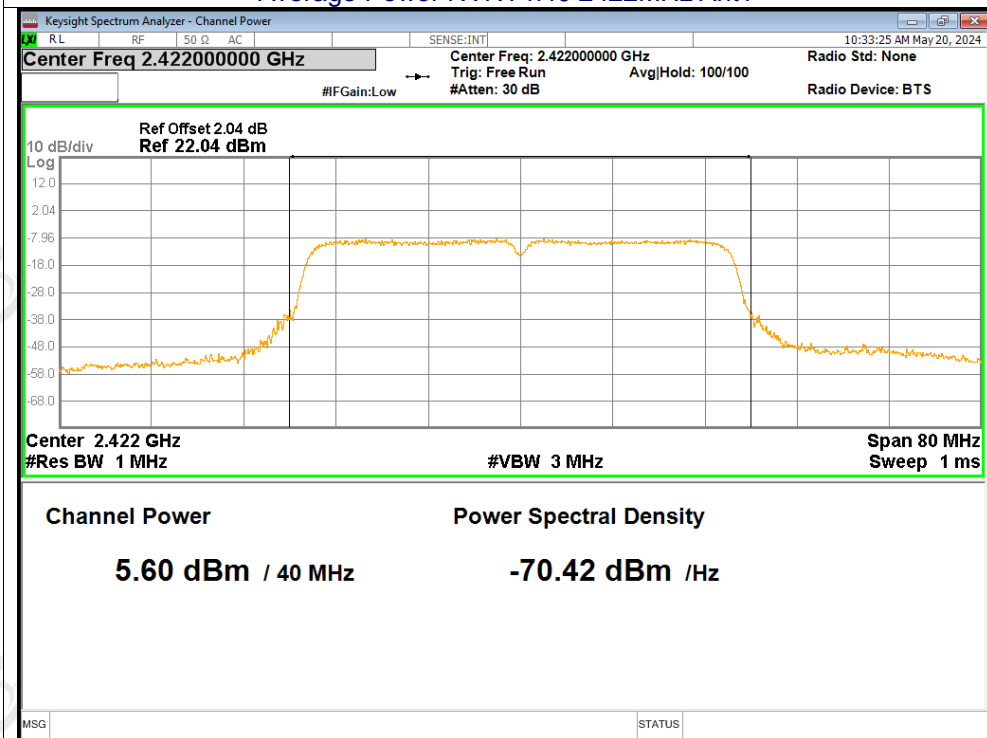

Average Power NVNT n40 2437MHz Ant1

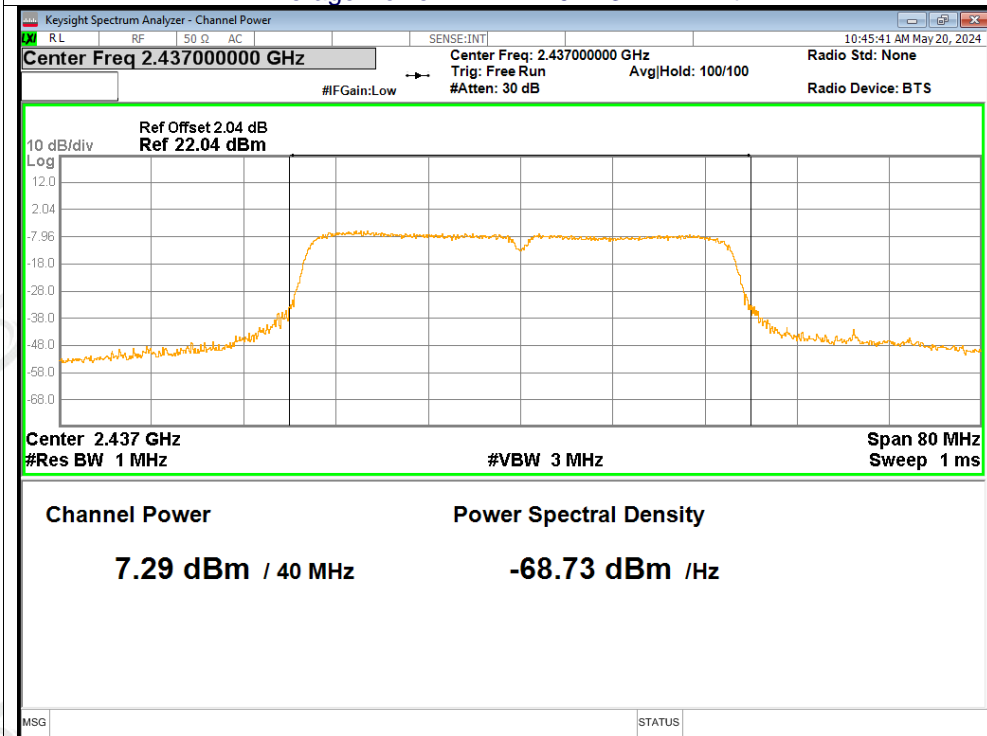



Average Power NVNT n40 2452MHz Ant1

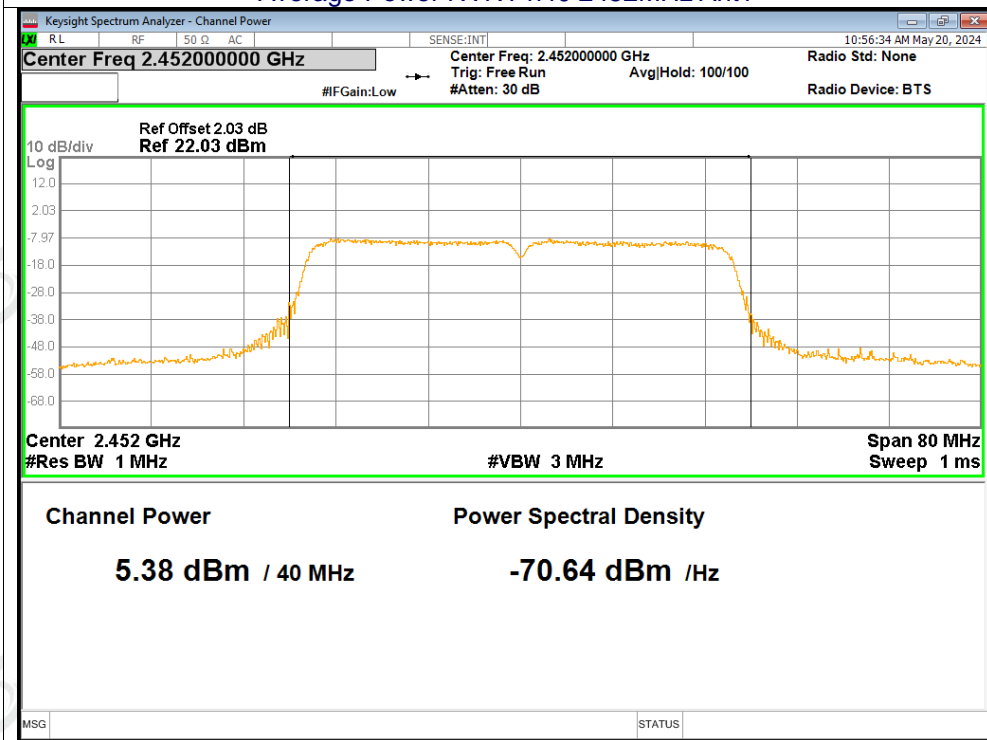

Average Power NVNT n40 2422MHz Ant2

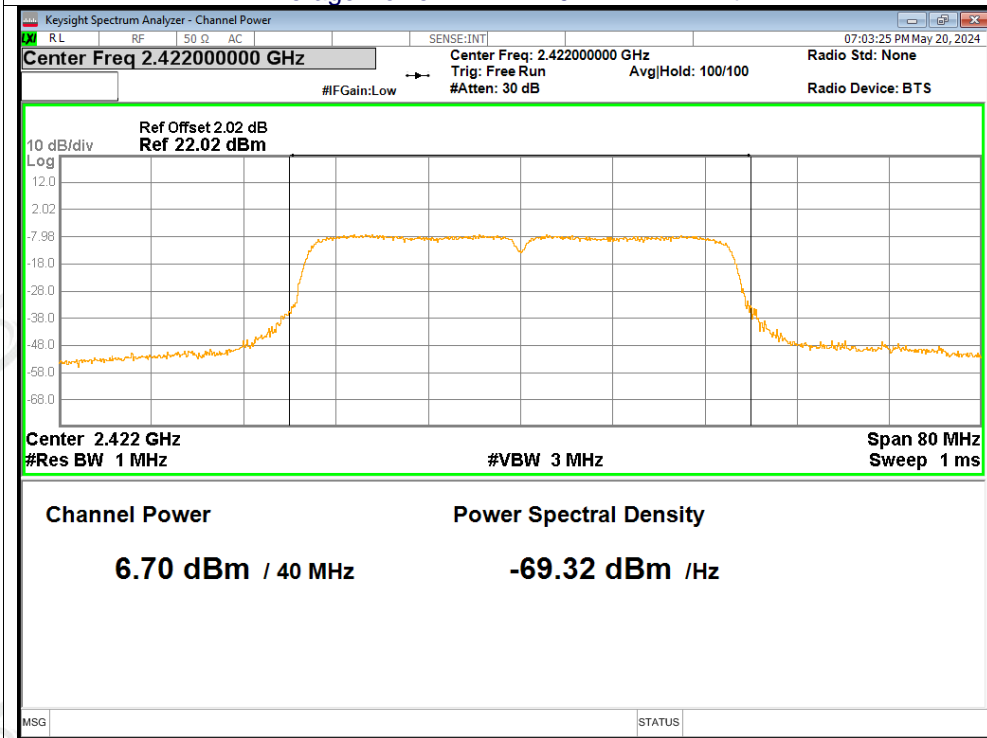



Average Power NVNT n40 2437MHz Ant2

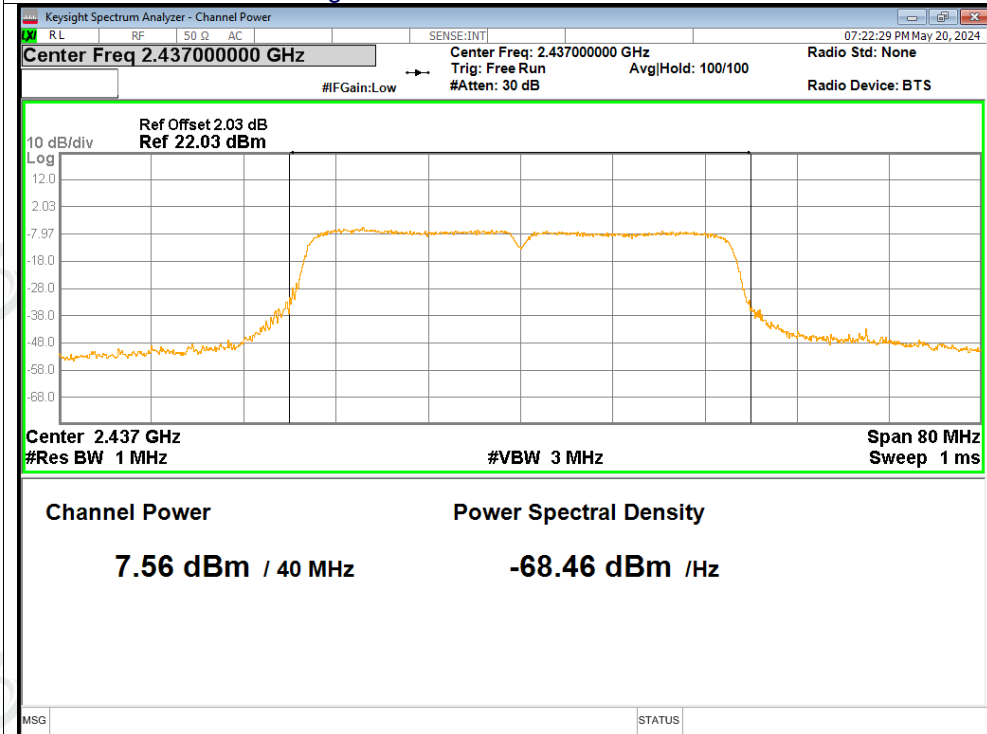

Average Power NVNT n40 2452MHz Ant2

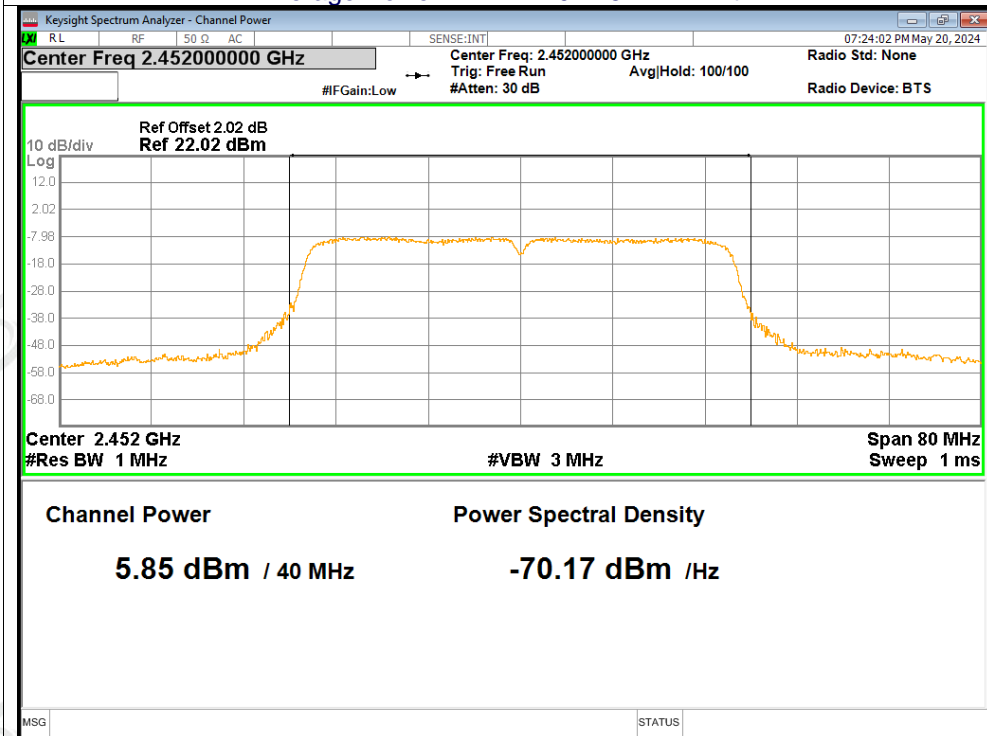



11.3 MAXIMUM PEAK CONDUCTED OUTPUT POWER

Mode	Frequency (MHz)	Antenna	Total Power (dBm)	Limit (dBm)	Verdict
b	2412	Ant1	14.72	30	Pass
b	2437	Ant1	14.29	30	Pass
b	2462	Ant1	14.05	30	Pass
b	2412	Ant2	14.35	30	Pass
b	2437	Ant2	14.29	30	Pass
b	2462	Ant2	14.1	30	Pass
g	2412	Ant1	14.88	30	Pass
g	2437	Ant1	15.19	30	Pass
g	2462	Ant1	14.8	30	Pass
g	2412	Ant2	14.82	30	Pass
g	2437	Ant2	15.17	30	Pass
g	2462	Ant2	14.87	30	Pass
n20	2412	Ant1	13.14	30	Pass
n20	2437	Ant1	15.21	30	Pass
n20	2462	Ant1	13.74	30	Pass
n20	2412	Ant2	13.13	30	Pass
n20	2437	Ant2	15.17	30	Pass
n20	2462	Ant2	13.91	30	Pass
n40	2422	Ant1	13.85	30	Pass
n40	2437	Ant1	15.55	30	Pass
n40	2452	Ant1	13.97	30	Pass
n40	2422	Ant2	14.79	30	Pass
n40	2437	Ant2	15.77	30	Pass
n40	2452	Ant2	14.12	30	Pass



Test Graphs Peak Power NVNT b 2412MHz Ant1

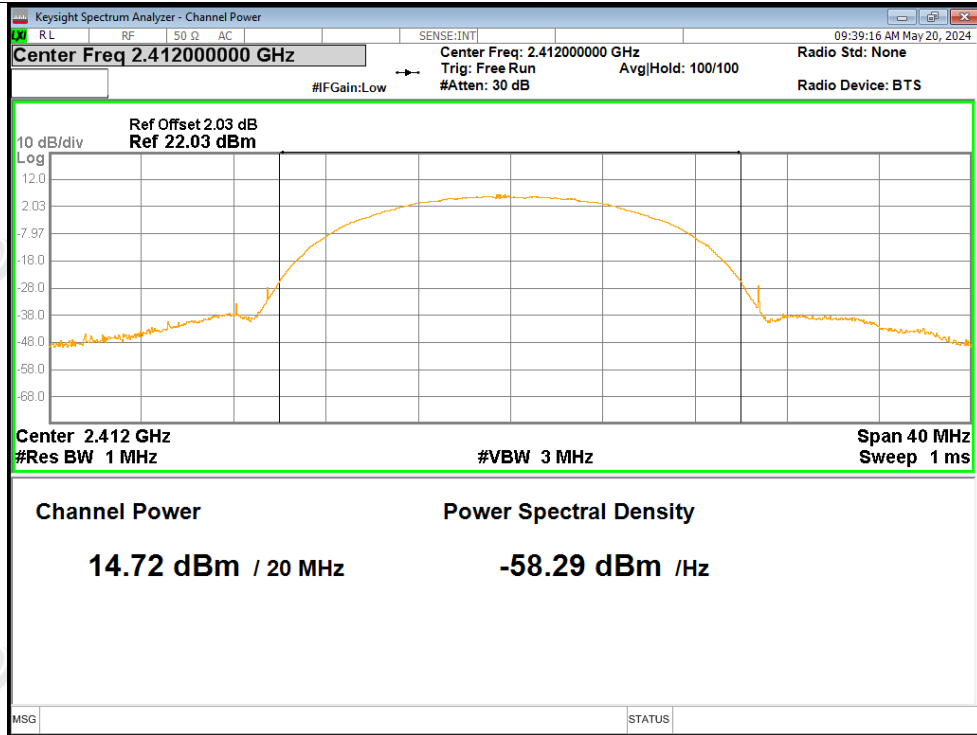

Peak Power NVNT b 2437MHz Ant1

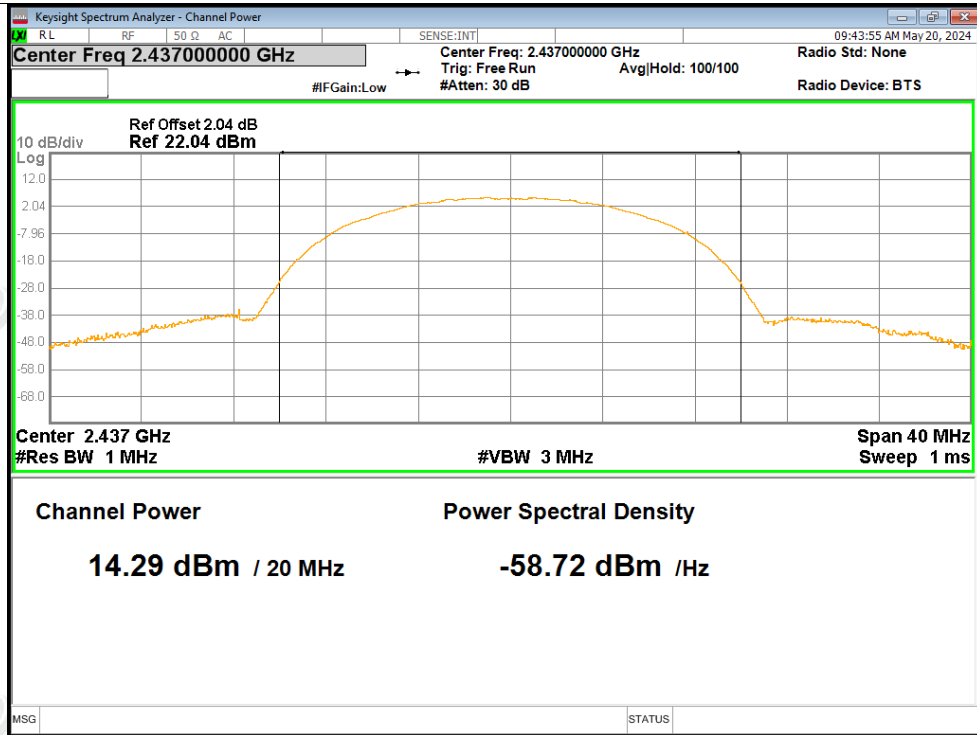



Peak Power NVNT b 2462MHz Ant1

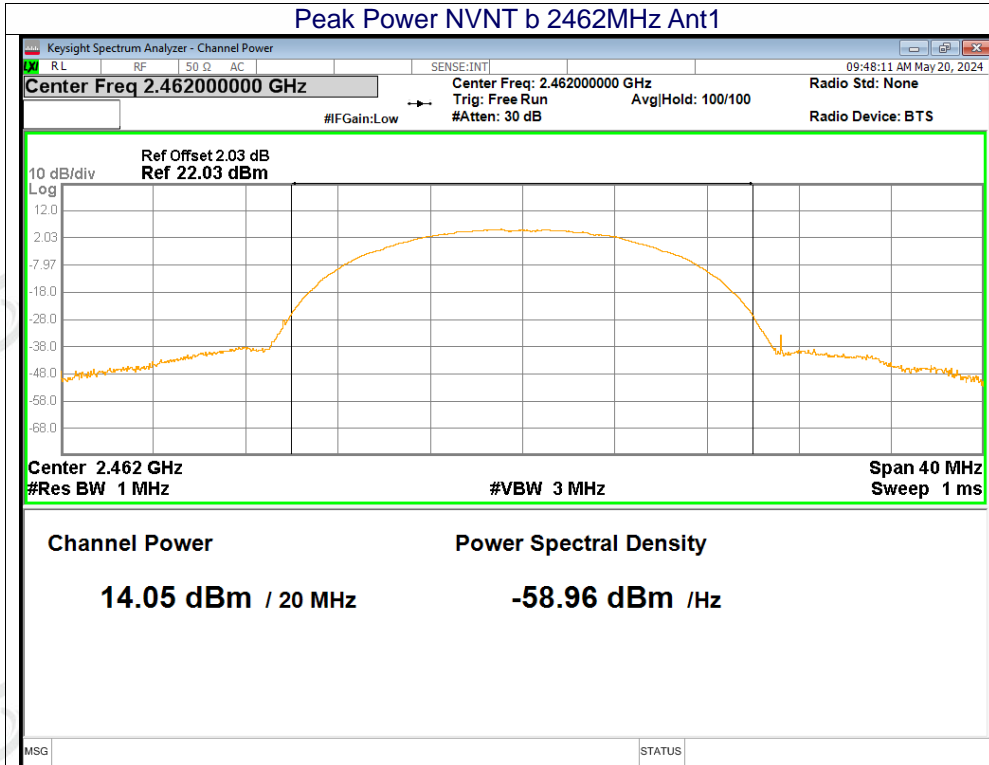

Peak Power NVNT b 2412MHz Ant2

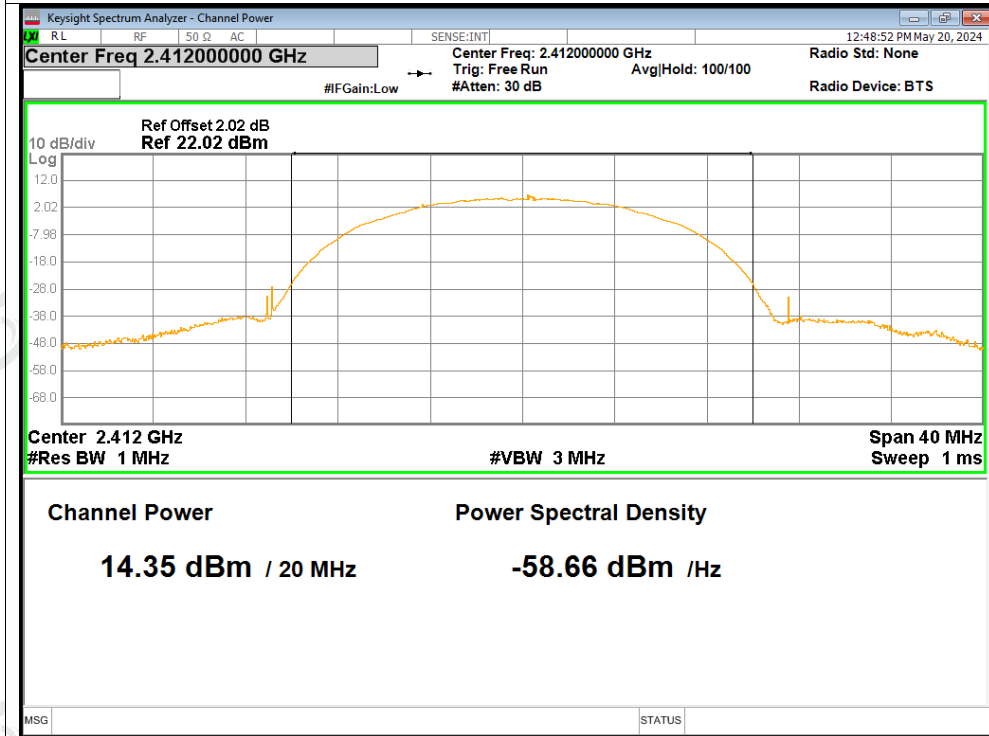



Peak Power NVNT b 2437MHz Ant2

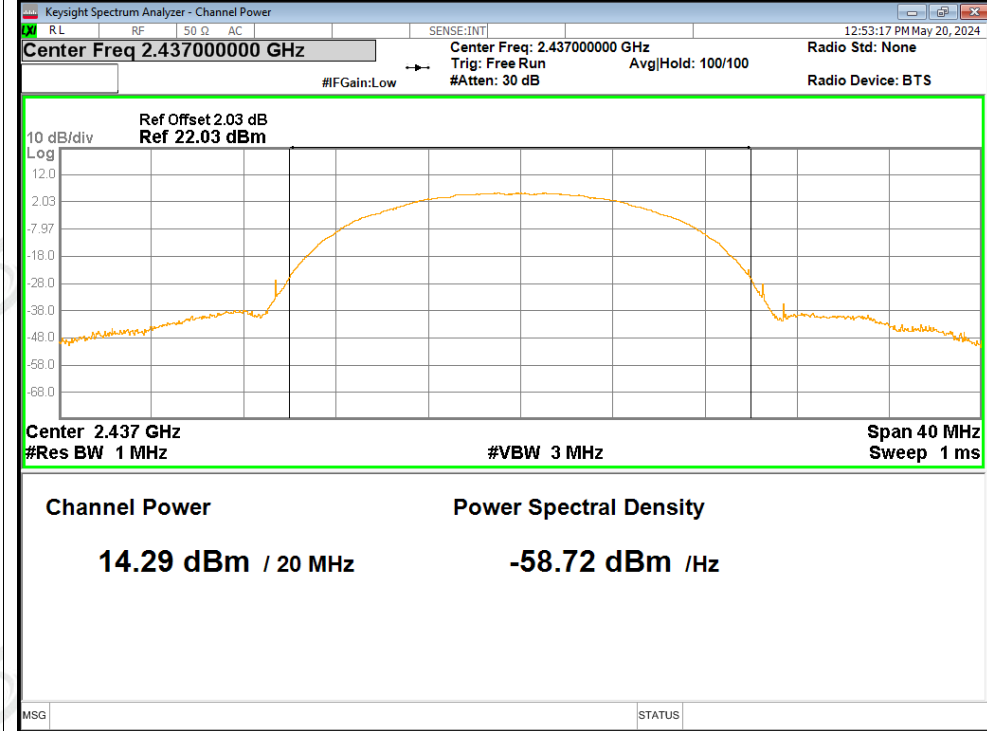

Peak Power NVNT b 2462MHz Ant2

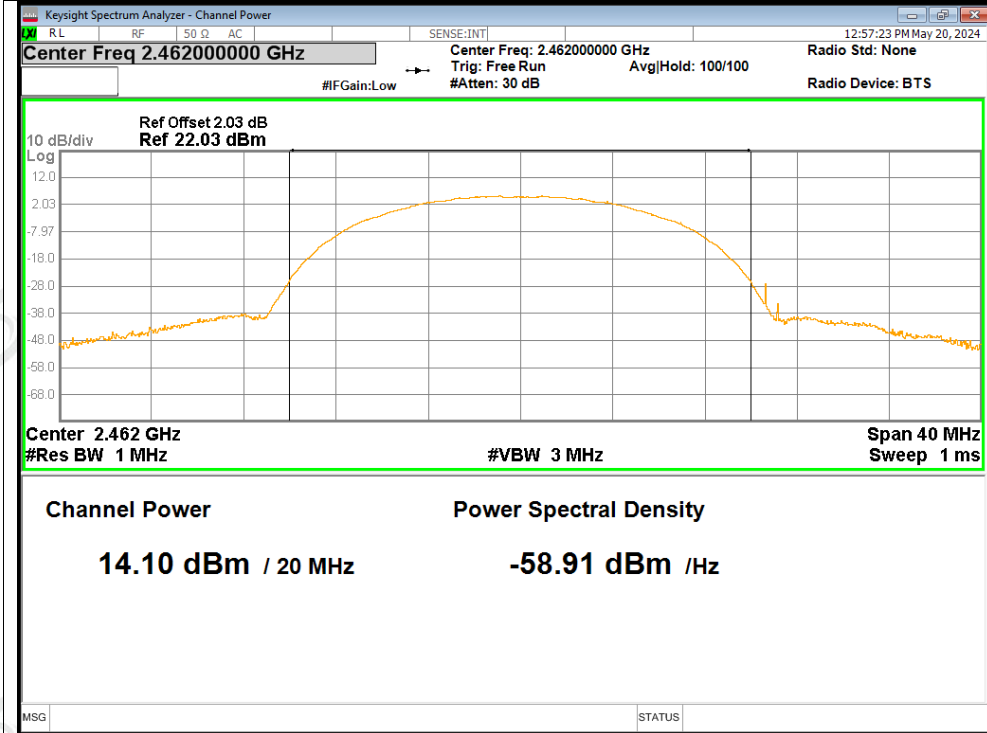



Peak Power NVNT g 2412MHz Ant1

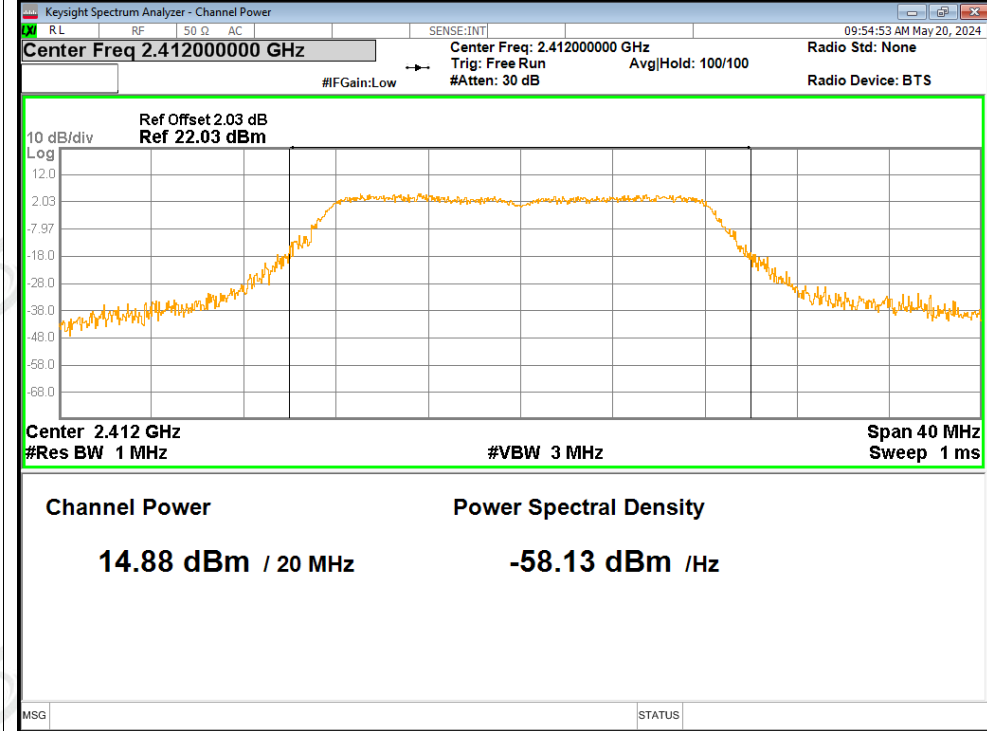

Peak Power NVNT g 2437MHz Ant1

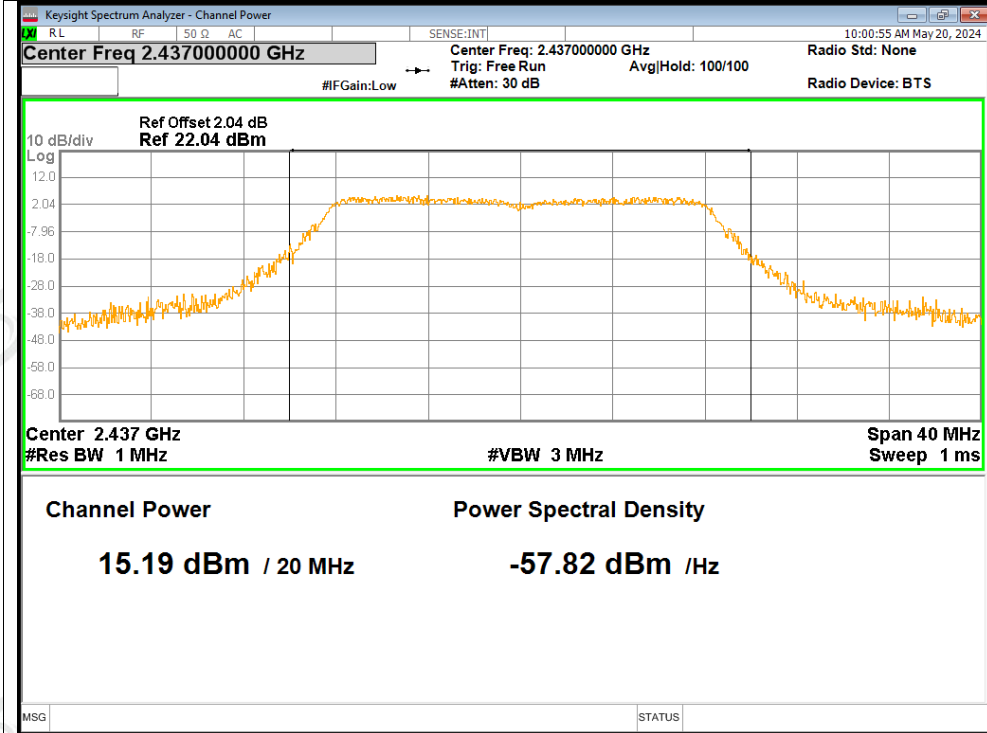



Peak Power NVNT g 2462MHz Ant1

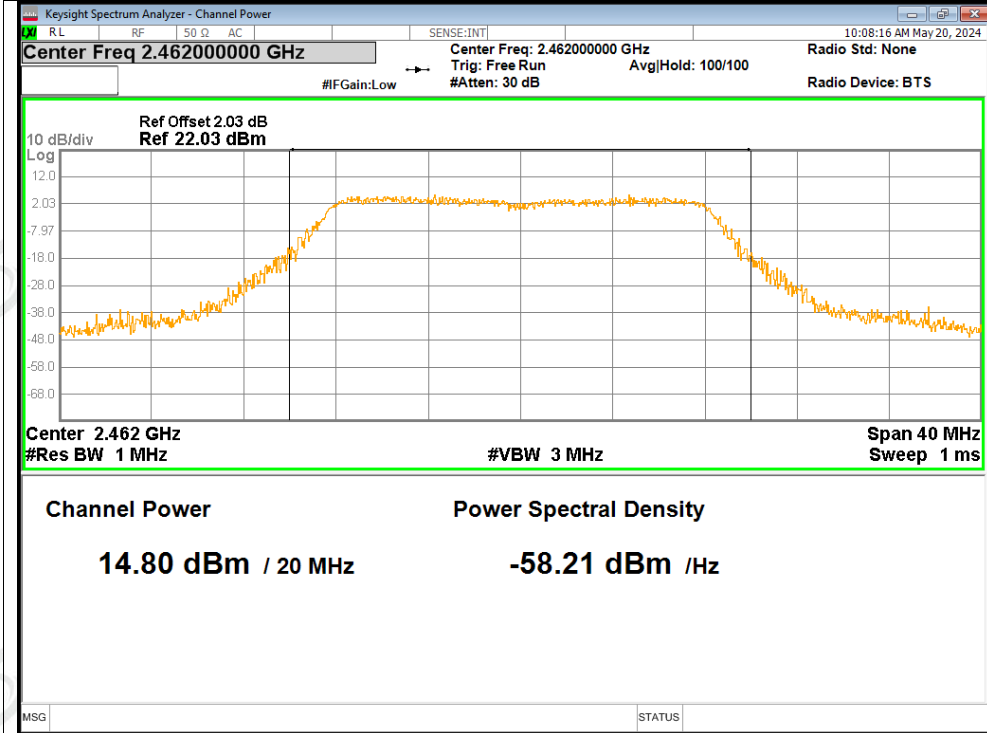

Peak Power NVNT g 2412MHz Ant2

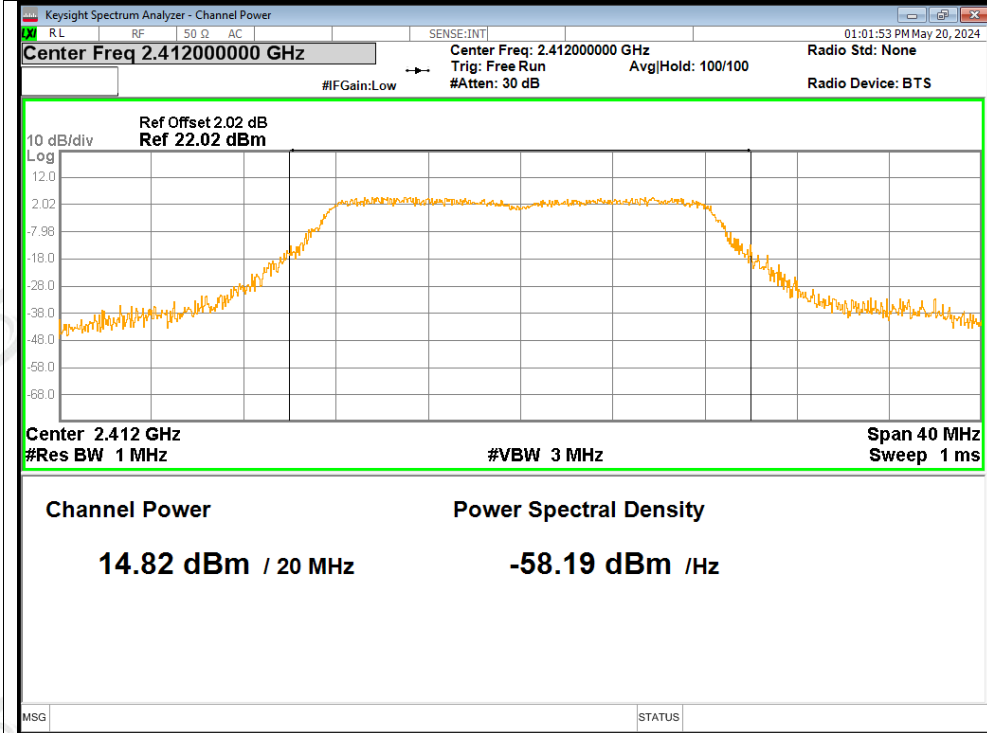



Peak Power NVNT g 2437MHz Ant2

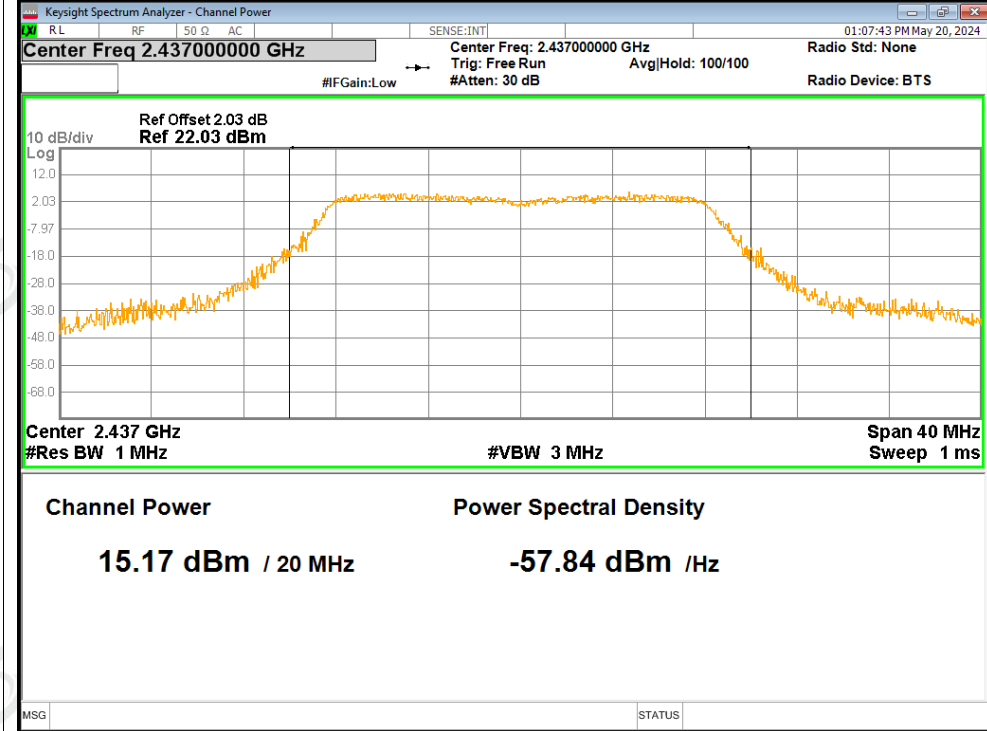

Peak Power NVNT g 2462MHz Ant2

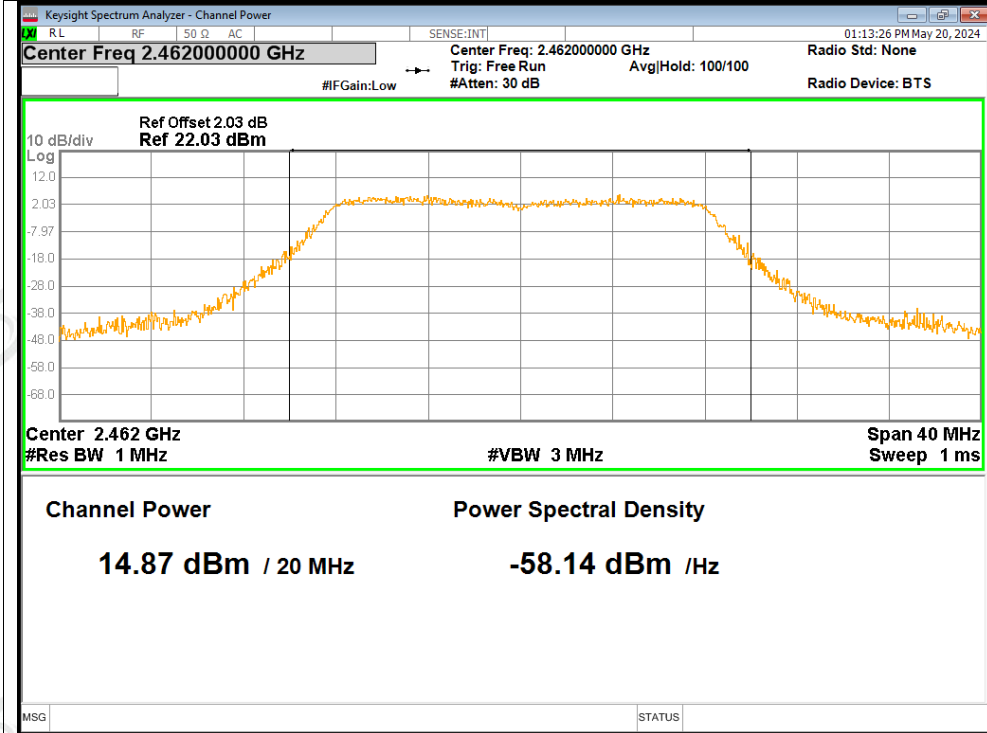



Peak Power NVNT n20 2412MHz Ant1

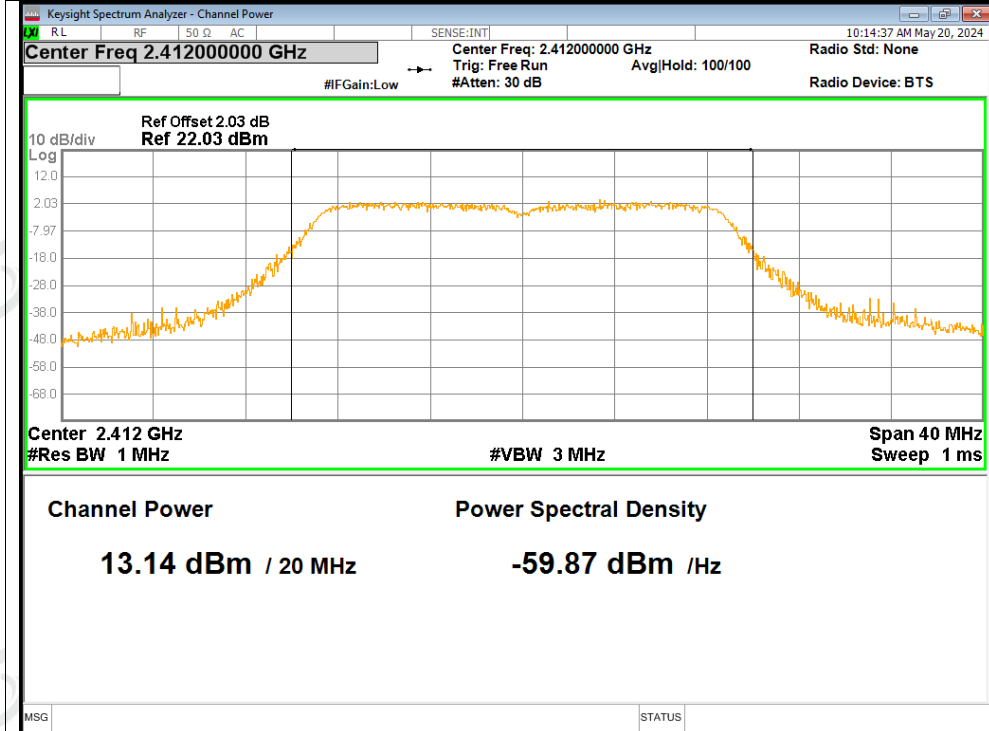

Peak Power NVNT n20 2437MHz Ant1

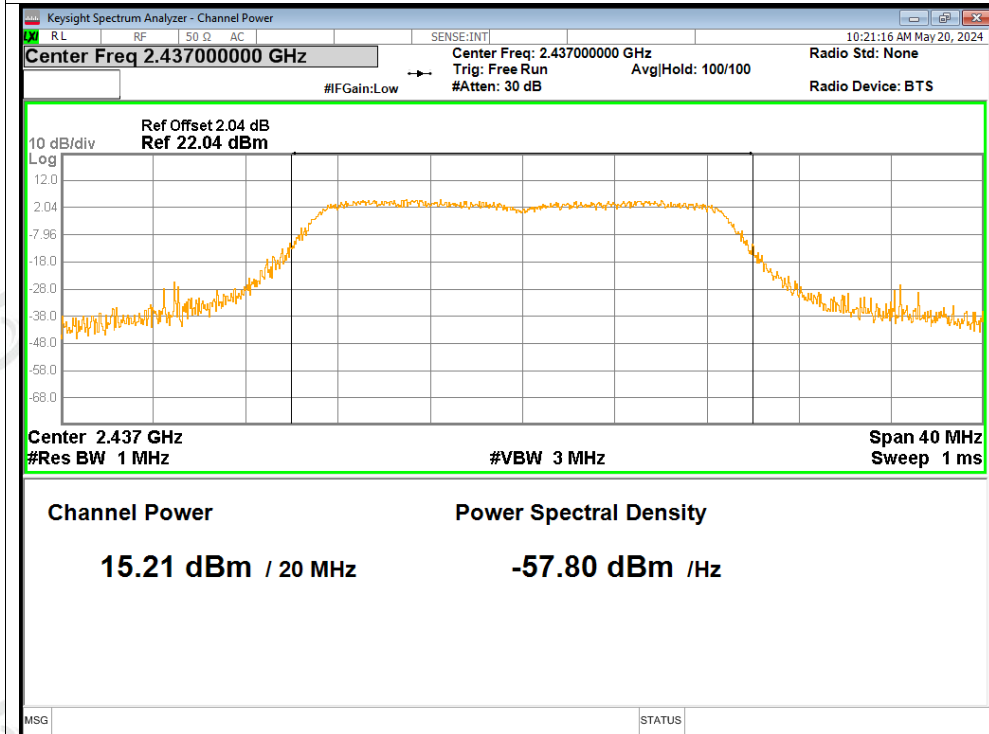



Peak Power NVNT n20 2462MHz Ant1

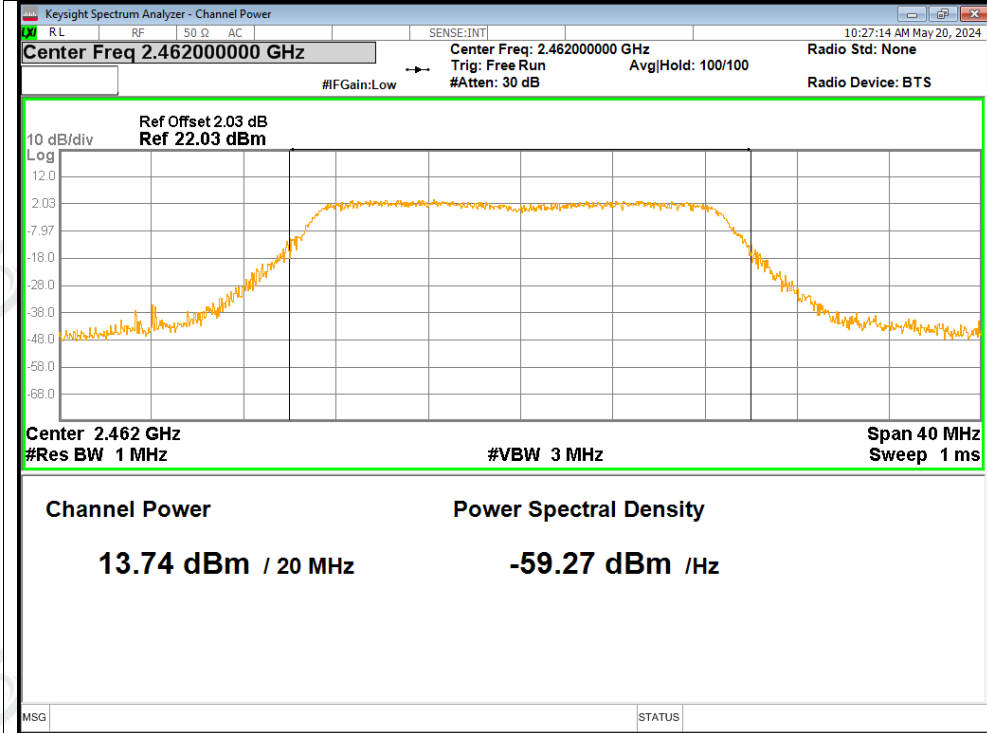

Peak Power NVNT n20 2412MHz Ant2

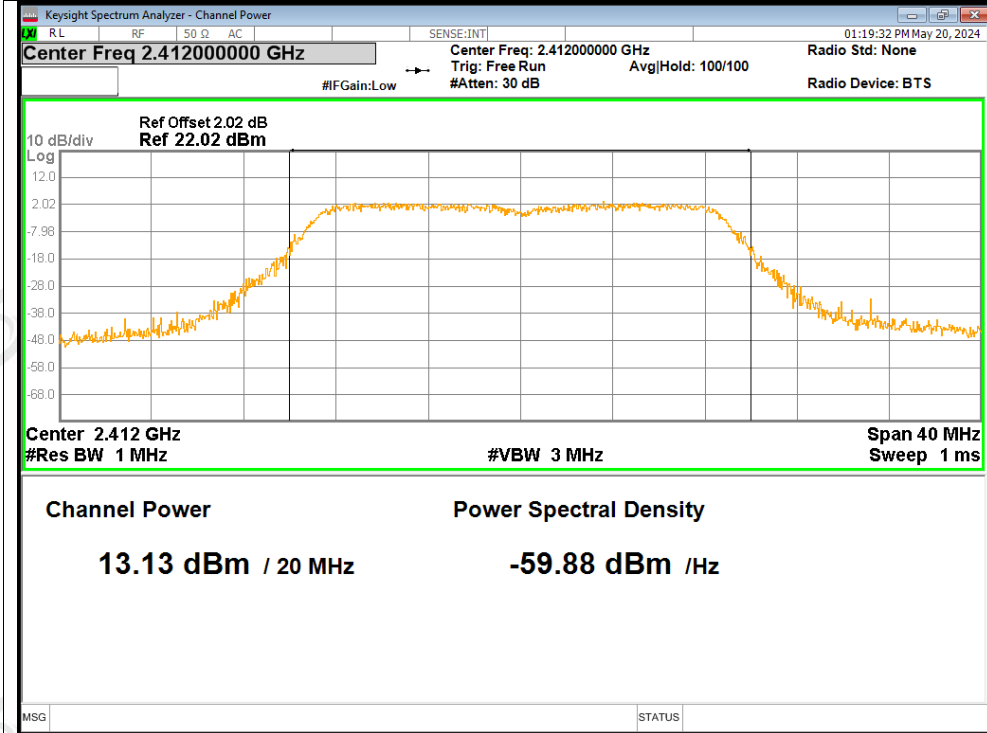



Peak Power NVNT n20 2437MHz Ant2

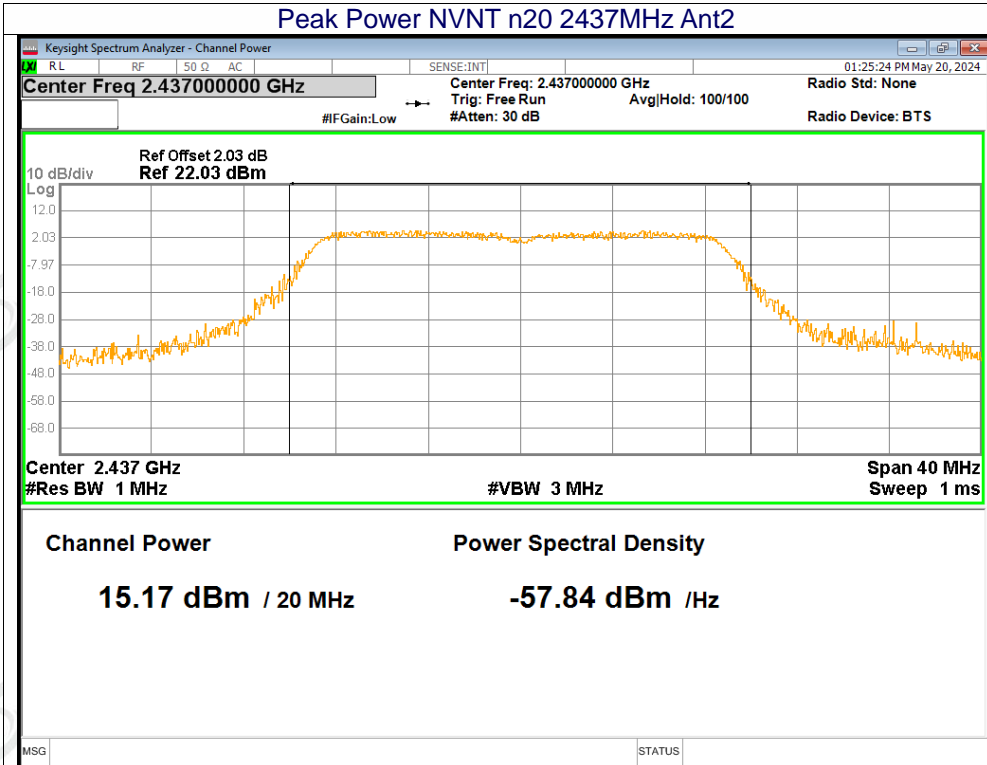

Peak Power NVNT n20 2462MHz Ant2

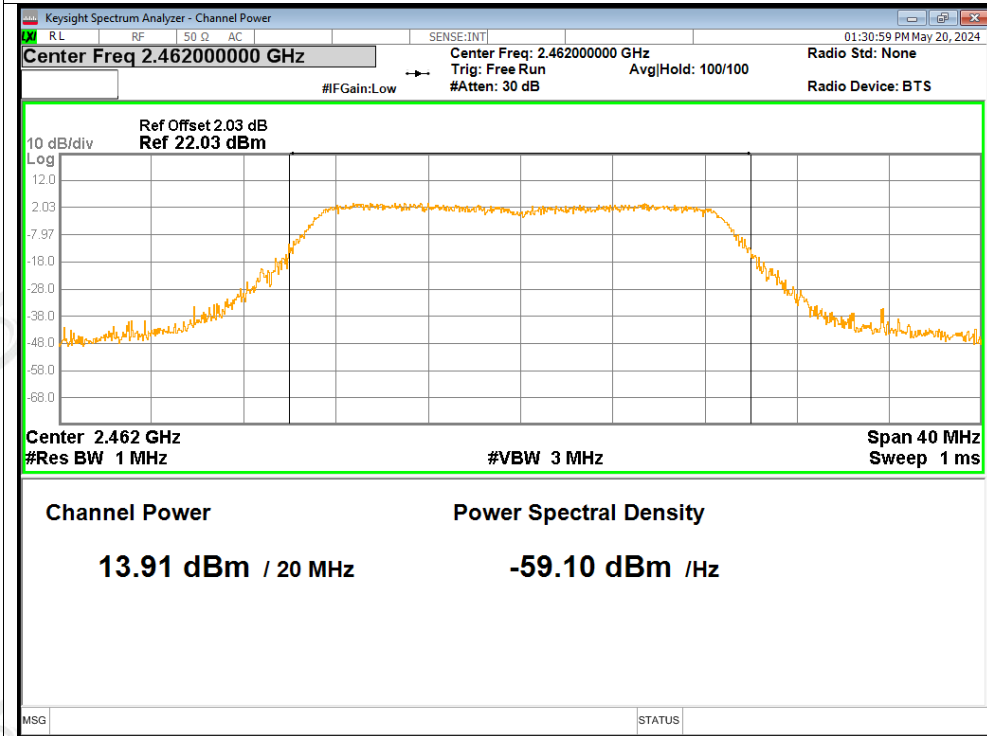



Peak Power NVNT n40 2422MHz Ant1

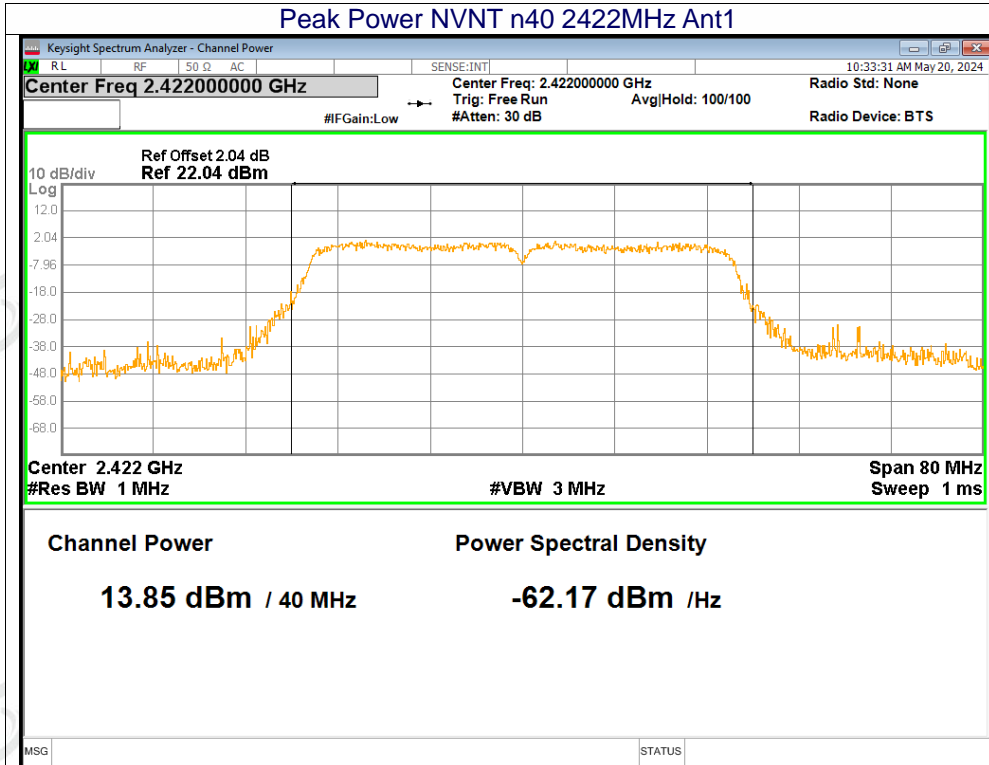

Peak Power NVNT n40 2437MHz Ant1

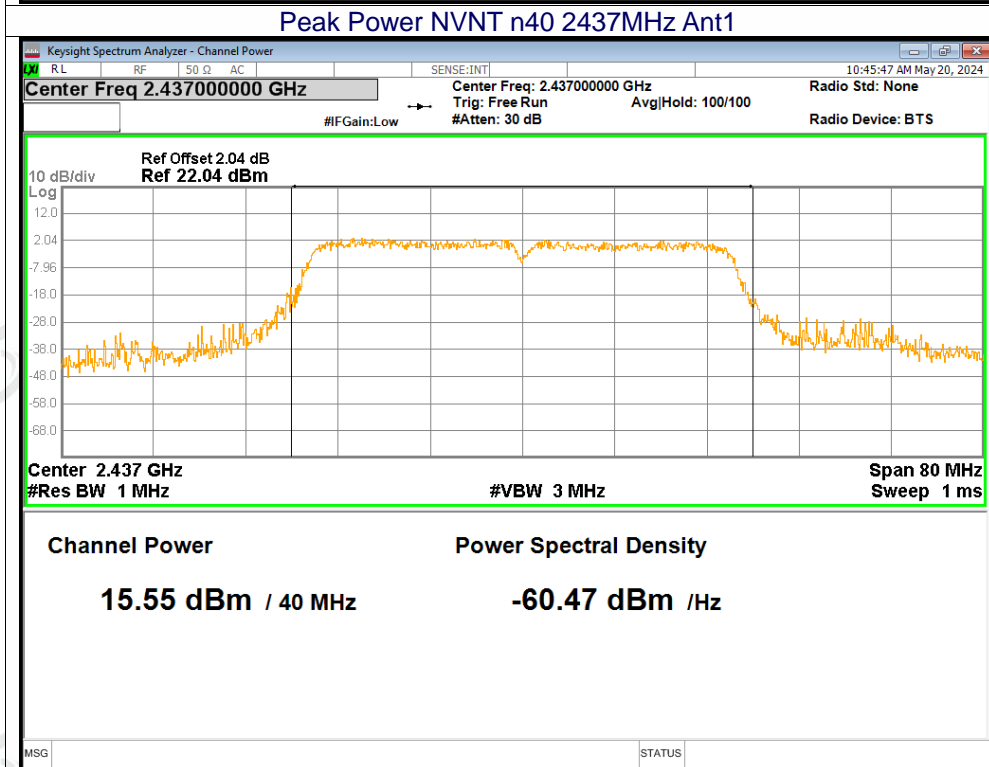



Peak Power NVNT n40 2452MHz Ant1

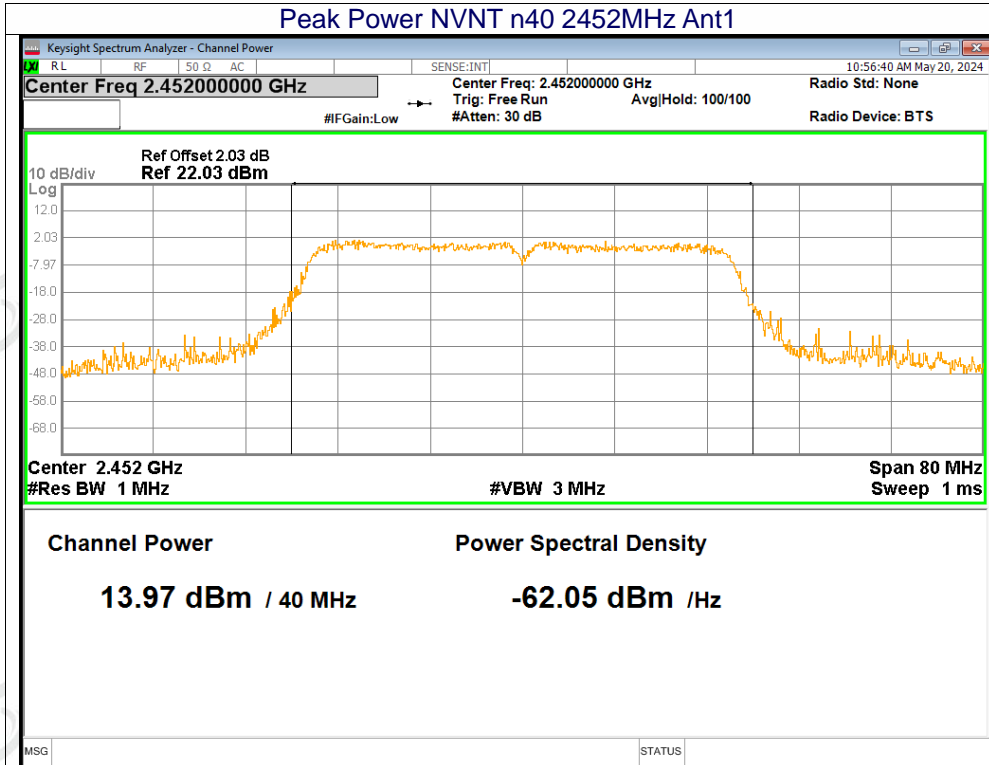

Peak Power NVNT n40 2422MHz Ant2

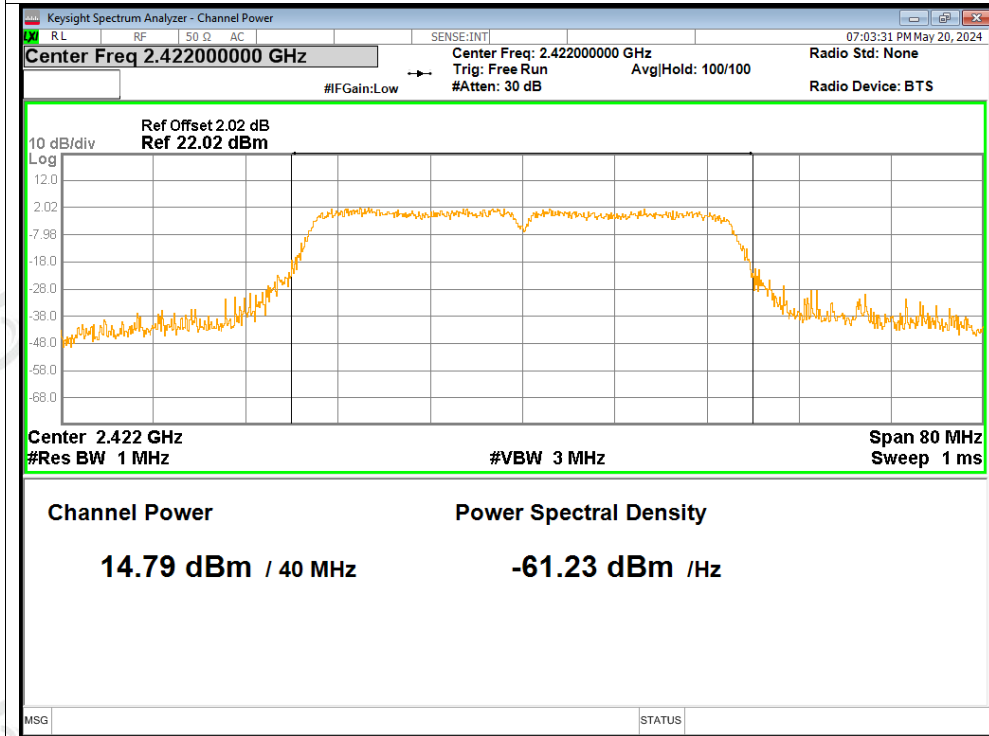



Peak Power NVNT n40 2437MHz Ant2

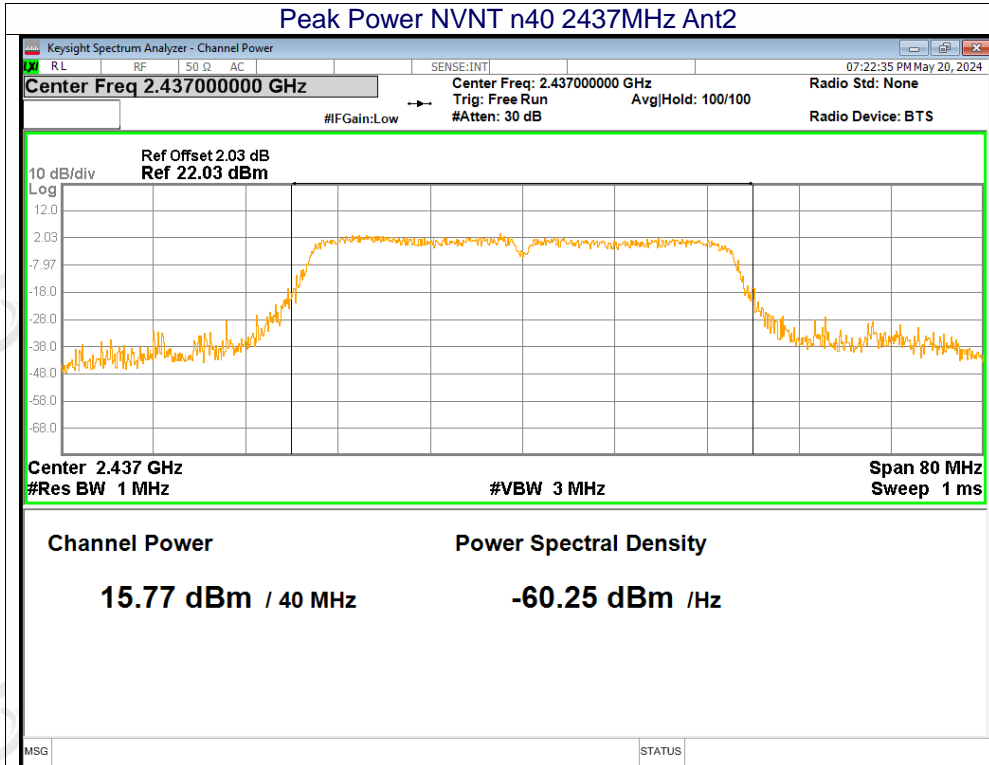

Peak Power NVNT n40 2452MHz Ant2

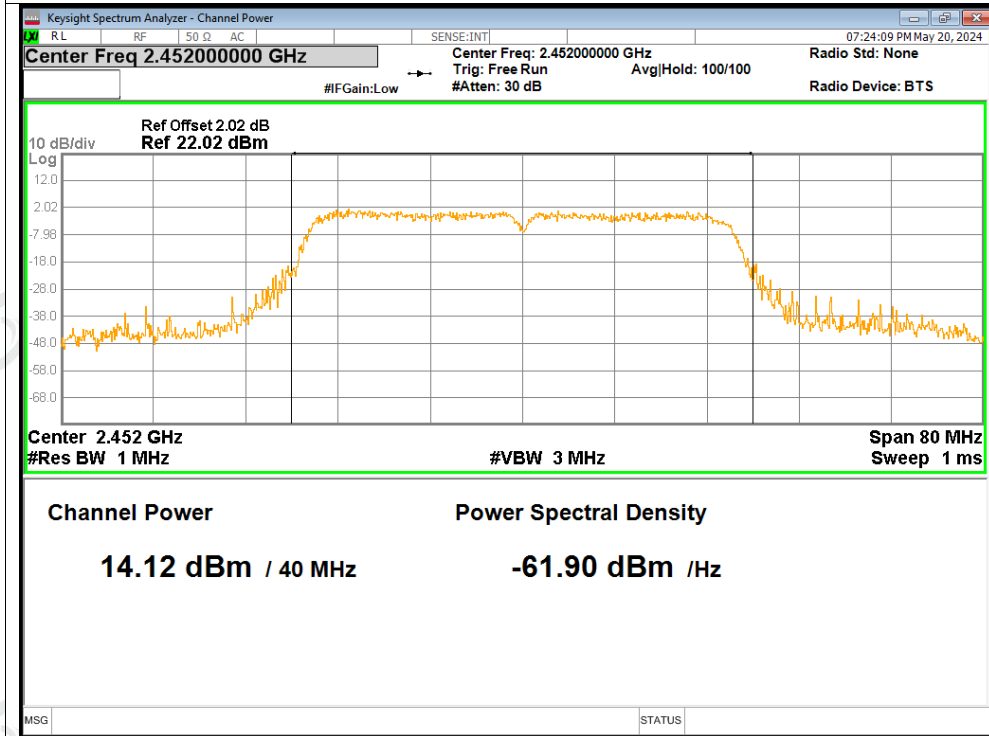



Mode	Frequency (MHz)	Antenna	-6 dB Bandwidth (MHz)	Limit -6 dB Bandwidth (MHz)	Verdict
b	2412	Ant1	10.063	0.5	Pass
b	2437	Ant1	10.069	0.5	Pass
b	2462	Ant1	10.071	0.5	Pass
b	2412	Ant2	10.061	0.5	Pass
b	2437	Ant2	10.051	0.5	Pass
b	2462	Ant2	10.07	0.5	Pass
g	2412	Ant1	16.051	0.5	Pass
g	2437	Ant1	16.073	0.5	Pass
g	2462	Ant1	16.339	0.5	Pass
g	2412	Ant2	16.327	0.5	Pass
g	2437	Ant2	16.335	0.5	Pass
g	2462	Ant2	16.439	0.5	Pass
n20	2412	Ant1	16.988	0.5	Pass
n20	2437	Ant1	17.268	0.5	Pass
n20	2462	Ant1	16.821	0.5	Pass
n20	2412	Ant2	16.533	0.5	Pass
n20	2437	Ant2	15.902	0.5	Pass
n20	2462	Ant2	17.268	0.5	Pass
n40	2422	Ant1	34.695	0.5	Pass
n40	2437	Ant1	35.042	0.5	Pass
n40	2452	Ant1	35.299	0.5	Pass
n40	2422	Ant2	34.979	0.5	Pass
n40	2437	Ant2	33.836	0.5	Pass
n40	2452	Ant2	35.107	0.5	Pass



Test Graphs

-6dB Bandwidth NVNT b 2412MHz Ant1

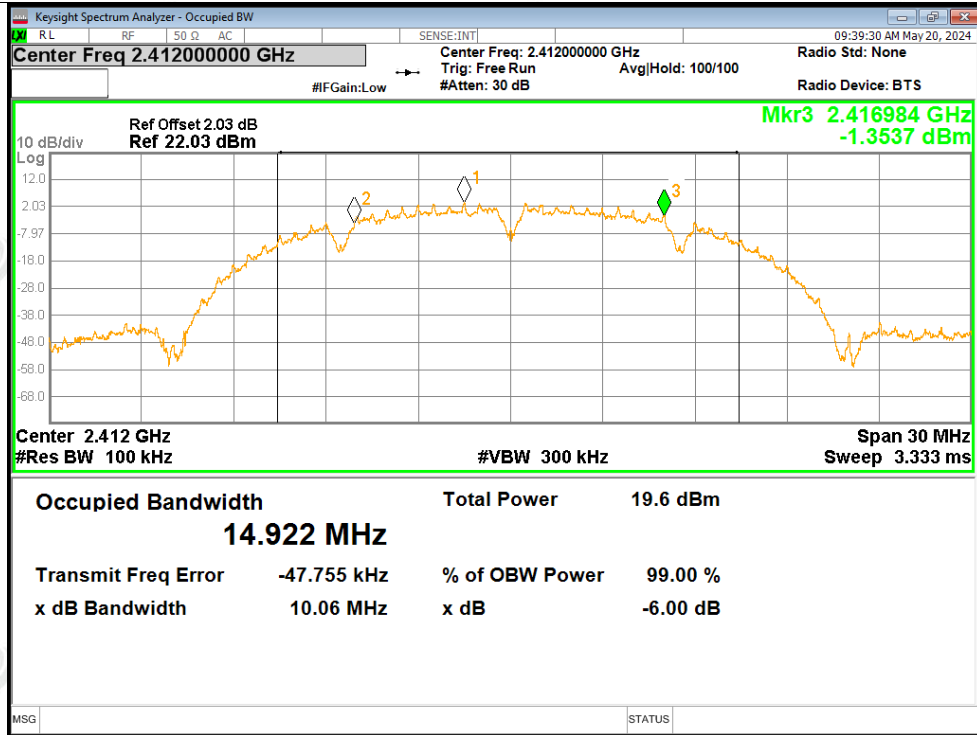

-6dB Bandwidth NVNT b 2437MHz Ant1

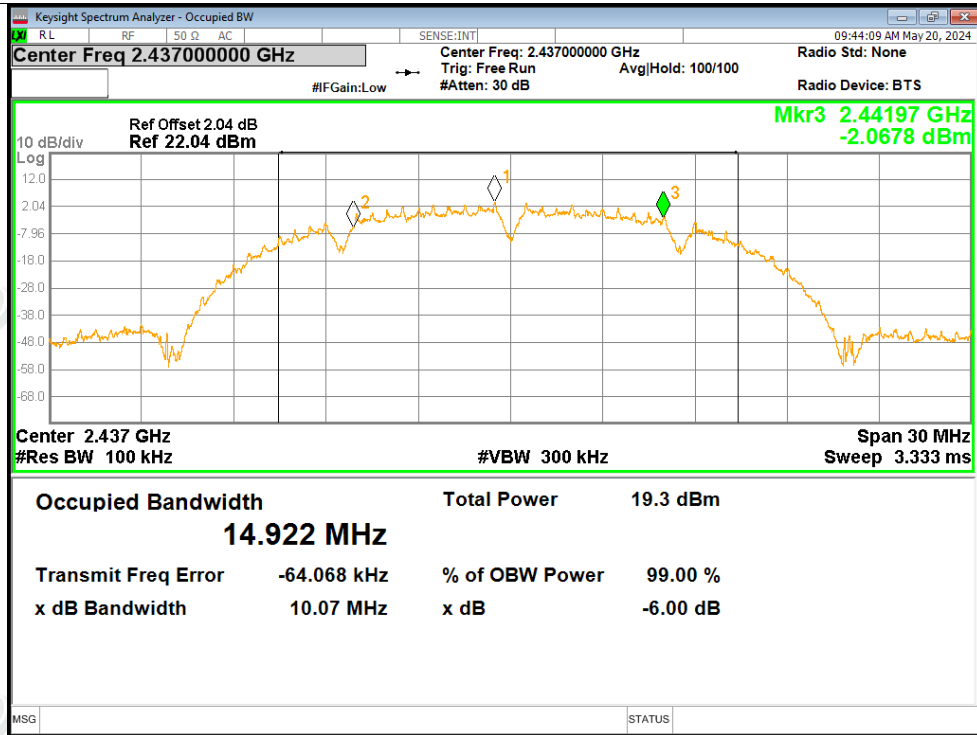



-6dB Bandwidth NVNT b 2462MHz Ant1

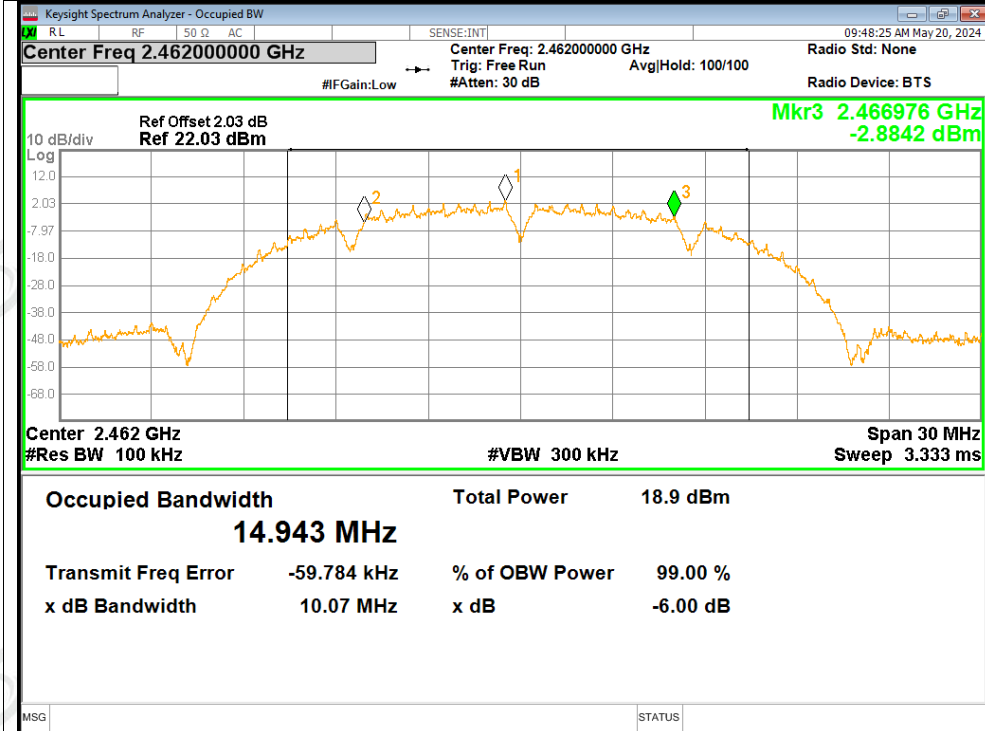

-6dB Bandwidth NVNT b 2412MHz Ant2

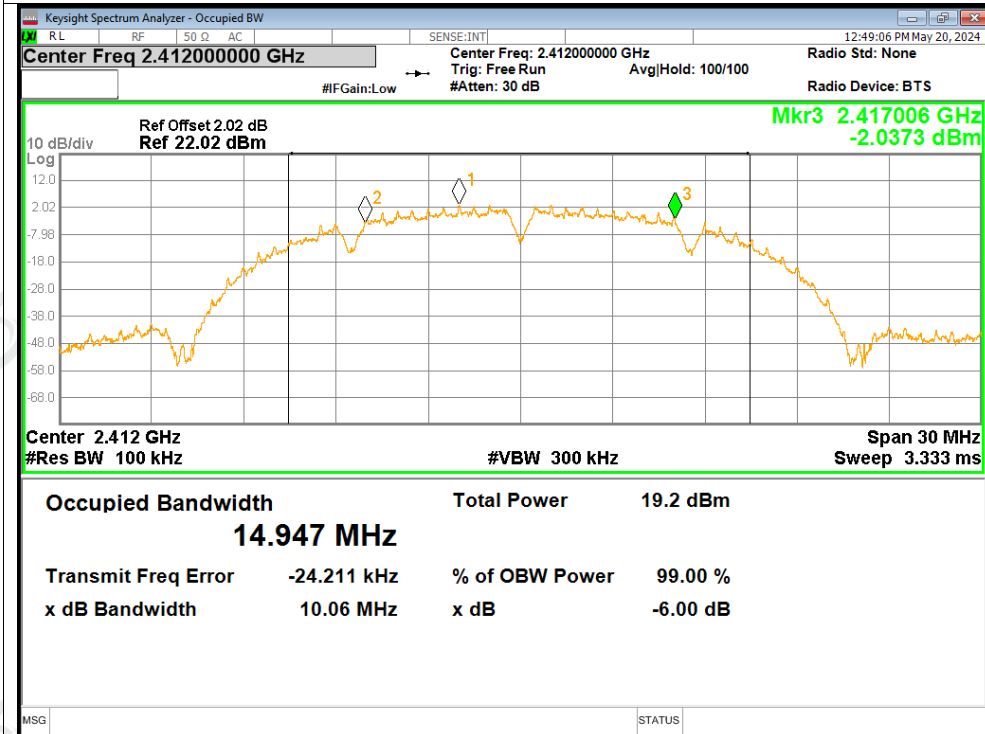



-6dB Bandwidth NVNT b 2437MHz Ant2

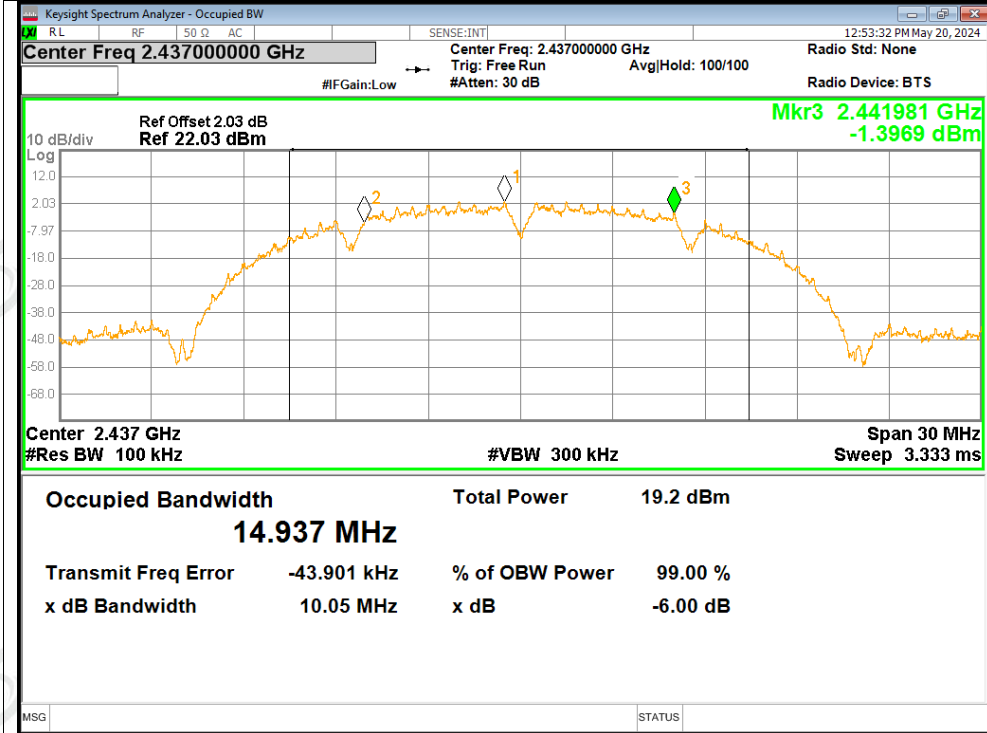

-6dB Bandwidth NVNT b 2462MHz Ant2

