



FCC TEST REPORT

FCC ID: 2BB7B-F1

Report Number..... : ZHT-240425022E

Date of Test..... : Apr. 25, 2024 to May 21, 2024

Date of issue : May 21, 2024

Test Result : PASS

Testing Laboratory..... : Guangdong Zhonghan Testing Technology Co., Ltd.

Address : Room 104, Building 1, Yibaolai Industrial Park, Qiaotou Community, Fuhai Street, Bao'an District, Shenzhen, Guangdong, China

Applicant's name : Shenzhen Qingfen Tingxiu Information Technology Co. Ltd

Address : 2405-06, Baotai Building, 182 Design Park, 182 Bulan Road, Lilang Community, Nanwan Street, Longgang District, Shenzhen

Manufacturer's name : Shenzhen Qingfen Tingxiu Information Technology Co. Ltd

Address : 2405-06, Baotai Building, 182 Design Park, 182 Bulan Road, Lilang Community, Nanwan Street, Longgang District, Shenzhen

Test specification:

Standard..... : FCC CFR Title 47 Part 15 Subpart C Section 15.247

Test procedure..... : ANSI C63.10:2013

Non-standard test method : N/A

This device described above has been tested by ZHT, and the test results show that the equipment under test (EUT) is in compliance with the FCC requirements. And it is applicable only to the tested sample identified in the report.

This report shall not be reproduced except in full, without the written approval of ZHT, this document may be altered or revised by ZHT, personal only, and shall be noted in the revision of the document.

Product name..... : MINIPC

Trademark : FIREBAT

Model/Type reference : F1, MN56, A8, Z8

Model difference : F1 is tested model, other models are derivative models .The models are identical in circuit, only different on the model names, size and shape. So the test data of F1 can represent the remaining models.

Ratings..... : Adapter: KT120A1900630B3
Input: 100-240V~50/60Hz 1.8A
Output: 19.0V, 6.3A 119.7W



Testing procedure and testing location:

Testing Laboratory: Guangdong Zhonghan Testing Technology Co., Ltd.

Address.....: Room 104, Building 1, Yibaolai Industrial Park, Qiaotou Community, Fuhai Street, Bao'an District, Shenzhen, Guangdong, China

Tested by (name + signature): Leon Li

Leon Li

Reviewer (name + signature).....: Baret Wu

Baret Wu

Approved (name + signature): Levi Lee

Levi Lee



Table of Contents

	Page
1. VERSION	5
2. TEST SUMMARY	6
2.1 TEST FACILITY	7
2.2 MEASUREMENT UNCERTAINTY.....	7
3. GENERAL INFORMATION	8
3.1 GENERAL DESCRIPTION OF EUT.....	8
3.2 Test Setup Configuration.....	9
3.3 Support Equipment.....	10
3.4 Test Mode.....	10
3.5 EQUIPMENTS LIST FOR ALL TEST ITEMS.....	11
4. EMC EMISSION TEST	13
4.1 Conducted emissions	13
4.1.1 POWER LINE CONDUCTED EMISSION Limits.....	13
4.1.2 TEST PROCEDURE.....	13
4.1.3 DEVIATION FROM TEST STANDARD.....	13
4.1.4 TEST SETUP.....	14
4.1.5 EUT OPERATING CONDITIONS.....	14
4.1.6 Test Result.....	14
4.2 Radiated emissions	17
4.2.1 Radiated Emission Limits.....	17
4.2.2 TEST PROCEDURE.....	17
4.2.3 DEVIATION FROM TEST STANDARD.....	18
4.2.4 TEST SETUP.....	18
4.2.5 EUT OPERATING CONDITIONS.....	19
4.2.6 TEST RESULTS.....	20
5. RADIATED BAND EMISSION MEASUREMENT	28
5.1 Test Requirement:	28
5.2 TEST PROCEDURE.....	28
5.3 DEVIATION FROM TEST STANDARD.....	29
5.4 TEST SETUP.....	29
5.5 EUT OPERATING CONDITIONS.....	29
5.6 TEST RESULT.....	30
6. CONDUCTED BAND EDGE AND SPURIOUS EMISSION	32
6.1 Limit	32
6.2 Test Setup.....	32
6.3 Test procedure.....	32
6.4 DEVIATION FROM STANDARD.....	32
6.5 Test Result.....	33
BAND EDGE	33
BAND EDGE(HOPPING)	40
CONDUCTED RF SPURIOUS EMISSION	47
7. 20DB&99% BANDWIDTH	57
7.1 Test Setup.....	57
7.2 Limit	57
7.3 Test procedure.....	57
7.4 DEVIATION FROM STANDARD.....	57
7.5 Test Result.....	57
8. MAXIMUM PEAK OUTPUT POWER	68
8.1 Block Diagram Of Test Setup	68
8.2 Limit	68
8.3 Test procedure.....	68
8.4 DEVIATION FROM STANDARD.....	68
8.5 Test Result.....	68
9. HOPPING CHANNEL SEPARATION	74
9.1 Test Setup.....	74
9.2 Test procedure.....	74



9.3 DEVIATION FROM STANDARD	74
9.4 Test Result	74
10.NUMBER OF HOPPING FREQUENCY	77
10.1 Test Setup	77
10.2 Test procedure	77
10.3 DEVIATION FROM STANDARD	77
10.4 Test Result	78
11. DWELL TIME	83
11.1 Test Setup	83
11.2 Test procedure	83
11.3 DEVIATION FROM STANDARD	83
11.4 Test Result	84
12. ANTENNA REQUIREMENT	94
13. TEST SETUP PHOTO	95
14. EUT CONSTRUCTIONAL DETAILS	95



1. VERSION

Report No.	Version	Description	Approved
ZHT-240425022E	Rev.01	Initial issue of report	May 21, 2024



2. TEST SUMMARY

Test procedures according to the technical standards:

FCC Part15 (15.247) , Subpart C			
Standard Section	Test Item	Result	Remark
FCC part 15.203/15.247 (b)(4)	Antenna Requirement	PASS	
15.207	AC Power Line Conducted Emission	PASS	
15.247 (b)(1)	Conducted Peak Output Power	PASS	
15.247 (a)(1)	20dB Occupied Bandwidth 99% OCB	PASS	
15.247 (a)(1)	Carrier Frequencies Separation	PASS	
15.247 (a)(1)(iii)	Hopping Channel Number	PASS	
15.247 (a)(1)(iii)	Dwell Time	PASS	
15.205/15.209	Radiated Emission and Restricted Band	PASS	
15.247(d)	Conducted Unwanted emissions and Band Edge	PASS	

NOTE:

(1) "N/A" denotes test is not applicable in this Test Report



2.1 TEST FACILITY

Guangdong Zhonghan Testing Technology Co., Ltd.
Add. : Room 104, Building 1, Yibaolai Industrial Park, Qiaotou Community, Fuhai Street, Bao'an District, Shenzhen, Guangdong, China

FCC Registration Number:255941
Designation Number: CN0325
IC Registered No.: 29832
CAB identifier: CN0143

2.2 MEASUREMENT UNCERTAINTY

The reported uncertainty of measurement $y \pm U$, where expanded uncertainty U is based on a standard uncertainty multiplied by a coverage factor of $k=2$, providing a level of confidence of approximately 95 %.

No.	Item	Uncertainty
1	Conducted Emission Test	$\pm 1.38\text{dB}$
2	RF conducted power	$\pm 0.16\text{dB}$
3	Conducted spurious emissions	$\pm 0.21\text{dB}$
4	All radiated emissions (9k-30MHz)	$\pm 4.68\text{dB}$
5	All radiated emissions (<1G)	$\pm 4.68\text{dB}$
6	All radiated emissions (>1G)	$\pm 4.89\text{dB}$
7	Temperature	$\pm 0.5^\circ\text{C}$
8	Humidity	$\pm 2\%$
9	Occupied Bandwidth	$\pm 4.96\text{dB}$



3. GENERAL INFORMATION

3.1 GENERAL DESCRIPTION OF EUT

Product Name:	MINIPC
Test Model No.:	F1
Hardware Version:	V1.0
Software Version:	V1.0
Sample(s) Status:	Engineer sample
Channel numbers:	79
Channel separation:	2402MHz-2480MHz
Modulation technology:	GFSK, $\pi/4$ DQPSK, 8DPSK
Antenna Type:	FPC Antenna
Antenna gain:	5.07dBi
Power supply:	Adapter: KT120A1900630B3 Input: 100-240V~50/60Hz 1.8A Output: 19.0V, 6.3A 119.7W
Sample Number:	240428036E-1#



Operation Frequency each of channel							
Channel	Frequency	Channel	Frequency	Channel	Frequency	Channel	Frequency
1	2402MHz	21	2422MHz	41	2442MHz	61	2462MHz
2	2403MHz	22	2423MHz	42	2443MHz	62	2463MHz
3	2404MHz	23	2424MHz	43	2444MHz	63	2464MHz
4	2405MHz	24	2425MHz	44	2445MHz	64	2465MHz
5	2406MHz	25	2426MHz	45	2446MHz	65	2466MHz
6	2407MHz	26	2427MHz	46	2447MHz	66	2467MHz
7	2408MHz	27	2428MHz	47	2448MHz	67	2468MHz
8	2409MHz	28	2429MHz	48	2449MHz	68	2469MHz
9	2410MHz	29	2430MHz	49	2450MHz	69	2470MHz
10	2411MHz	30	2431MHz	50	2451MHz	70	2471MHz
11	2412MHz	31	2432MHz	51	2452MHz	71	2472MHz
12	2413MHz	32	2433MHz	52	2453MHz	72	2473MHz
13	2414MHz	33	2434MHz	53	2454MHz	73	2474MHz
14	2415MHz	34	2435MHz	54	2455MHz	74	2475MHz
15	2416MHz	35	2436MHz	55	2456MHz	75	2476MHz
16	2417MHz	36	2437MHz	56	2457MHz	76	2477MHz
17	2418MHz	37	2438MHz	57	2458MHz	77	2478MHz
18	2419MHz	38	2439MHz	58	2459MHz	78	2479MHz
19	2420MHz	39	2440MHz	59	2460MHz	79	2480MHz
20	2421MHz	40	2441MHz	60	2461MHz		

Note:

In section 15.31(m), regards to the operating frequency range over 10 MHz, the Lowest frequency, the middle frequency, and the highest frequency of channel were selected to perform the test, and the selected channel see below:

Test channel	Frequency
The lowest channel	2402MHz
The middle channel	2441MHz
The Highest channel	2480MHz

3.2 Test Setup Configuration

Conducted Emission

EUT

Radiated Emission

EUT



3.3 Support Equipment

The EUT has been tested as an independent unit together with other necessary accessories or support units. The following support units or accessories were used to form a representative test configuration during the tests.

Item	Equipment	Mfr/Brand	Model/Type No.	Series No.	Note

Item	Shielded Type	Ferrite Core	Length	Note

Note:

- (1) The support equipment was authorized by Declaration of Confirmation.
- (2) For detachable type I/O cable should be specified the length in cm in 『Length』 column.
- (3) The test software is the Bluetooth RF Test Tool which can set the EUT into the individual test modes.TX Power:7

3.4 Test Mode

Transmitting mode	Keep the EUT in continuously transmitting mode.
Remark: During the test, the test voltage was tuned from 85% to 115% of the nominal rated supply voltage, and found that the worst case was under the nominal rated supply condition. So the report just shows that condition's data.	



3.5 EQUIPMENTS LIST FOR ALL TEST ITEMS

Radiation Test equipment

Item	Equipment	Manufacturer	Model	Serial No.	Last Cal.	Next Cal.
1	Receiver	R&S	ESCI	100874	May 10, 2024	May 09, 2025
2	Loop antenna	EMCI	LAP600	272	May 10, 2024	May 09, 2025
3	Amplifier	Schwarzbeck	BBV 9743 B	00378	May 10, 2024	May 09, 2025
4	Amplifier	Schwarzbeck	BBV 9718 B	00040	May 10, 2024	May 09, 2025
5	Bilog Antenna	Schwarzbeck	VULB9168	00498	Aug. 04, 2023	Aug. 03, 2024
6	Horn Antenna	Schwarzbeck	BBHA9120D	02623	May 16, 2024	May 15, 2025
7	Horn Antenna	A.H.SYSTEMS	SAS574	588	May 10, 2024	May 09, 2025
8	Amplifier	AEROFLEX	100KHz-40GHz	097	May 10, 2024	May 09, 2025
9	Spectrum Analyzer	R&S	FSV40	101413	May 16, 2024	May 15, 2025
10	966 Anechoic Chamber	EMToni	9m6m6m	/	Nov. 25, 2021	Nov. 24, 2024
11	Spectrum Analyzer	KEYSIGHT	N9020A	MY53420208	May 10, 2024	May 09, 2025
12	WIDBAND RADIO COMMUNICATION TESTER	R&S	CMW500	109863	May 10, 2024	May 09, 2025
13	Single Generator	Agilent	N5182A	MY48180575	May 10, 2024	May 09, 2025
14	Power Sensor	MWRFtest	MW100-RFCB	/	May 10, 2024	May 09, 2025
15	Power Amplifier Shielding Room	EMToni	2m3m3m	/	Nov. 25, 2021	Nov. 24, 2024



Conduction Test equipment

Equipment	Manufacturer	Model	Serial No.	Last Cal.	Next Cal.
Receiver	R&S	ESCI	100874	May 10, 2024	May 09, 2025
LISN	R&S	ENV216	102794	May 10, 2024	May 09, 2025
ISN CAT 6	Schwarzbeck	NTFM 8158	00318	May 10, 2024	May 09, 2025
ISN CAT 5	Schwarzbeck	CAT5 8158	00343	May 10, 2024	May 09, 2025
Capacitive Voltage Probe	Schwarzbeck	CVP 9222 C	00101	May 10, 2024	May 09, 2025
Current Transformer Clamp	Schwarzbeck	SW 9605	SW9605 #209	May 10, 2024	May 09, 2025
CE Shielding Room	EMToni	9m4m3m	/	Nov. 25, 2021	Nov. 24, 2024

Conducted Test equipment

Item	Equipment	Manufacturer	Model	Serial No.	Last Cal.	Next Cal.
1	Spectrum Analyzer	R&S	FSV40	101413	May 10, 2024	May 09, 2025
2	Spectrum Analyzer	KEYSIGHT	N9020A	MY53420208	May 10, 2024	May 09, 2025
3	Power Sensor	MWRftest	MW100-RFCB	/	May 10, 2024	May 09, 2025



4. EMC EMISSION TEST

4.1 Conducted emissions

Test Requirement:	FCC Part15 C Section 15.207, RSS-Gen 8.8
Test Method:	ANSI C63.10:2013
Test Frequency Range:	150KHz to 30MHz
Receiver setup:	RBW=9KHz, VBW=30KHz, Sweep time=auto

4.1.1 POWER LINE CONDUCTED EMISSION Limits

FREQUENCY (MHz)	Limit (dBuV)		Standard
	Quasi-peak	Average	
0.15 -0.5	66 - 56 *	56 - 46 *	FCC
0.50 -5.0	56.00	46.00	FCC
5.0 -30.0	60.00	50.00	FCC

Note:

(1) *Decreases with the logarithm of the frequency.

4.1.2 TEST PROCEDURE

- a. The EUT was placed 0.8 meters from the horizontal ground plane with EUT being connected to the power mains through a line impedance stabilization network (LISN). All other support equipments powered from additional LISN(s). The LISN provide 50 Ohm/ 50uH of coupling impedance for the measuring instrument.
- b. Interconnecting cables that hang closer than 40 cm to the ground plane shall be folded back and forth in the center forming a bundle 30 to 40 cm long.
- c. I/O cables that are not connected to a peripheral shall be bundled in the center. The end of the cable may be terminated, if required, using the correct terminating impedance. The overall length shall not exceed 1 m.
- d. LISN at least 80 cm from nearest part of EUT chassis.
- e. For the actual test configuration, please refer to the related Item –EUT Test Photos.

4.1.3 DEVIATION FROM TEST STANDARD

No deviation

4.1.4 TEST SETUP

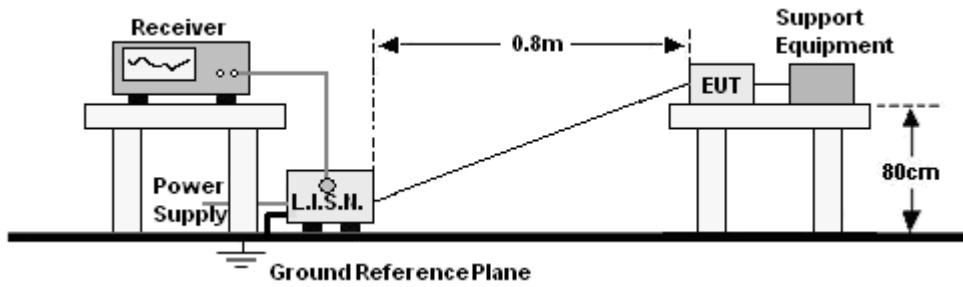

4.1.5 EUT OPERATING CONDITIONS

The EUT was configured for testing in a typical fashion (as a customer would normally use it). The EUT has been programmed to continuously transmit during test. This operating condition was tested and used to collect the included data.

4.1.6 Test Result



Temperature:	24.3°C	Relative Humidity :	50%
Pressure:	101kPa	Phase :	L
Test Voltage:	AC 120V/60Hz		

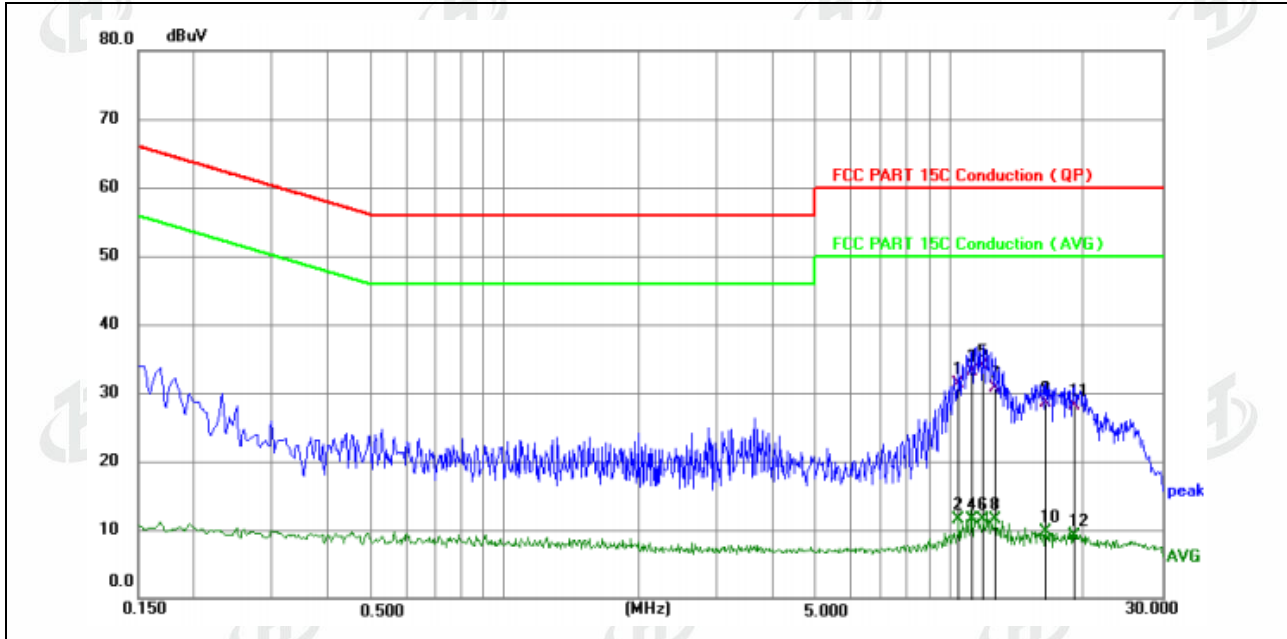

No.	Frequency (MHz)	Reading (dBuV)	Factor (dB)	Level (dBuV)	Limit (dBuV)	Margin (dB)	Detector	P/F
1	10.4640	21.23	10.08	31.31	60.00	-28.69	QP	P
2	10.4640	1.37	10.08	11.45	50.00	-38.55	AVG	P
3	11.2200	23.07	10.08	33.15	60.00	-26.85	QP	P
4	11.2200	1.38	10.08	11.46	50.00	-38.54	AVG	P
5 *	11.9310	23.79	10.09	33.88	60.00	-26.12	QP	P
6	11.9310	1.36	10.09	11.45	50.00	-38.55	AVG	P
7	12.6823	20.60	10.09	30.69	60.00	-29.31	QP	P
8	12.6823	1.46	10.09	11.55	50.00	-38.45	AVG	P
9	16.4850	18.35	10.10	28.45	60.00	-31.55	QP	P
10	16.4850	-0.30	10.10	9.80	50.00	-40.20	AVG	P
11	19.1173	17.98	10.11	28.09	60.00	-31.91	QP	P
12	19.1173	-1.05	10.11	9.06	50.00	-40.94	AVG	P

Notes:

1. An initial pre-scan was performed on the line and neutral lines with peak detector.
2. Quasi-Peak and Average measurement were performed at the frequencies with maximized peak emission.
3. Measurement Level = Reading level + Correct Factor
4. The test data shows only the worst case Low Channel:2402MHz.



Temperature:	24.3°C	Relative Humidity :	50%
Pressure:	101kPa	Phase :	N
Test Voltage:	AC 120V/60Hz		

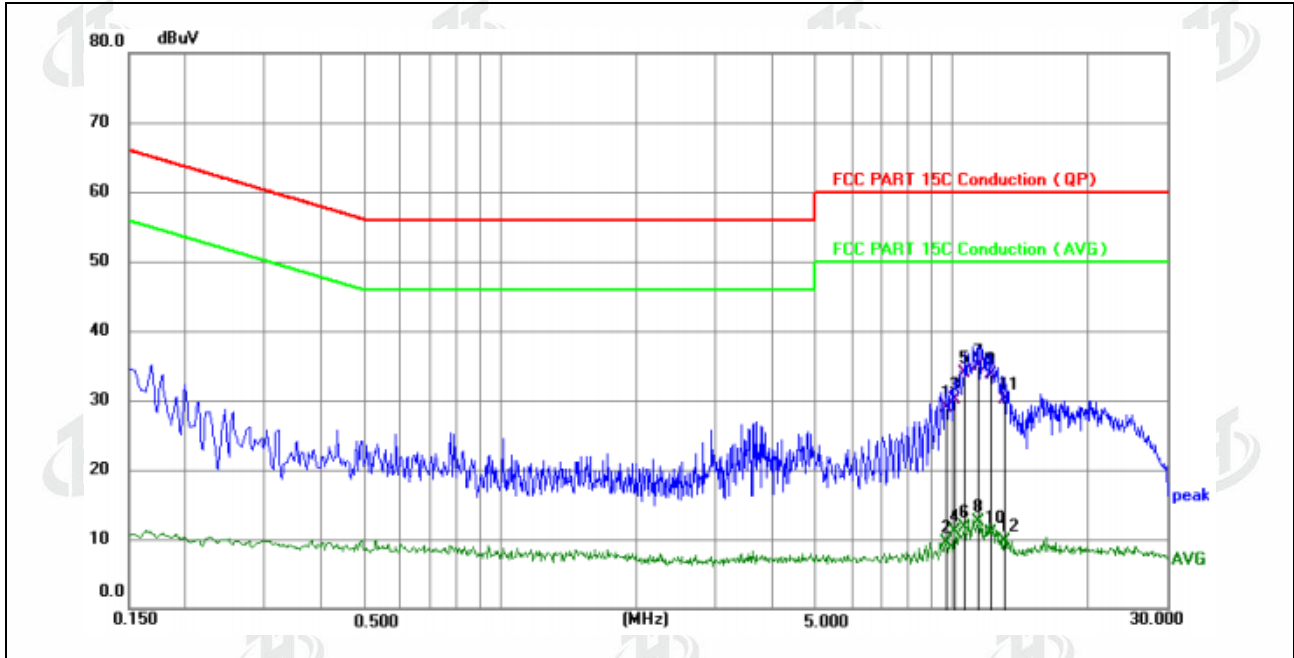

No.	Frequency (MHz)	Reading (dBuV)	Factor (dB)	Level (dBuV)	Limit (dBuV)	Margin (dB)	Detector	P/F
1	9.7051	18.85	10.09	28.94	60.00	-31.06	QP	P
2	9.7051	-0.65	10.09	9.44	50.00	-40.56	AVG	P
3	10.1254	19.97	10.08	30.05	60.00	-29.95	QP	P
4	10.1254	1.04	10.08	11.12	50.00	-38.88	AVG	P
5	10.6763	23.80	10.08	33.88	60.00	-26.12	QP	P
6	10.6763	1.69	10.08	11.77	50.00	-38.23	AVG	P
7 *	11.4376	24.91	10.08	34.99	60.00	-25.01	QP	P
8	11.4376	2.40	10.08	12.48	50.00	-37.52	AVG	P
9	12.1884	23.60	10.09	33.69	60.00	-26.31	QP	P
10	12.1884	0.88	10.09	10.97	50.00	-39.03	AVG	P
11	13.0575	20.09	10.09	30.18	60.00	-29.82	QP	P
12	13.0575	-0.30	10.09	9.79	50.00	-40.21	AVG	P

Notes:

1. An initial pre-scan was performed on the line and neutral lines with peak detector.
2. Quasi-Peak and Average measurement were performed at the frequencies with maximized peak emission.
3. Measurement Level = Reading level + Correct Factor
4. The test data shows only the worst case Low Channel:2402MHz.



4.2 Radiated emissions

Test Requirement:	FCC Part15 C Section 15.209, RSS-Gen 8.9, RSS-Gen 8.10				
Test Method:	ANSI C63.10:2013				
Test Frequency Range:	9kHz to 25GHz				
Test site:	Measurement Distance: 3m				
Receiver setup:	Frequency	Detector	RBW	VBW	Value
	9KHz-150KHz	Quasi-peak	200Hz	600Hz	Quasi-peak
	150KHz-30MHz	Quasi-peak	9KHz	30KHz	Quasi-peak
	30MHz-1GHz	Quasi-peak	100KHz	300KHz	Quasi-peak
	Above 1GHz	Peak	1MHz	3MHz	Peak
Average		1MHz	10Hz	Average	

4.2.1 Radiated Emission Limits

Frequencies (MHz)	Field Strength (micorvolts/meter)	Measurement Distance (meters)
0.009~0.490	2400/F(KHz)	300
0.490~1.705	24000/F(KHz)	30
1.705~30.0	30	30
30~88	100	3
88~216	150	3
216~960	200	3
Above 960	500	3

LIMITS OF RADIATED EMISSION MEASUREMENT

FREQUENCY (MHz)	Limit (dBuV/m) (at 3M)	
	PEAK	AVERAGE
Above 1000	74	54

Notes:

- (1) The limit for radiated test was performed according to FCC PART 15C.
- (2) The tighter limit applies at the band edges.
- (3) Emission level (dBuV/m)=20log Emission level (uV/m).

4.2.2 TEST PROCEDURE

Below 1GHz test procedure as below:

- a. The EUT was placed on the top of a rotating table 0.8 meters above the ground at a 3 meter semi-anechoic chamber. The table was rotated 360 degrees to determine the position of the highest radiation.
- b. The EUT was set 3 meters away from the interference-receiving antenna, which was mounted on the top of a variable-height antenna tower.
- c. The antenna height is varied from one meter to four meters above the ground to determine the maximum value of the field strength. Both horizontal and vertical polarizations of the antenna are set to make the measurement.

- d. For each suspected emission, the EUT was arranged to its worst case and then the antenna was tuned to heights from 1 meter to 4 meters (for the test frequency of below 30MHz, the antenna was tuned to heights 1 meter) and the rotatable table was turned from 0 degrees to 360 degrees to find the maximum reading.
- e. The test-receiver system was set to Peak Detect Function and Specified Bandwidth with Maximum Hold Mode.
- f. If the emission level of the EUT in peak mode was 10dB lower than the limit specified, then testing could be stopped and the peak values of the EUT would be reported. Otherwise the emissions that did not have 10dB margin would be re-tested one by one using peak, quasi-peak or average method as specified and then reported in a data sheet.

Above 1GHz test procedure as below:

- g. Different between above is the test site, change from Semi- Anechoic Chamber to fully Anechoic Chamber and change form table 0.8 metre to 1.5 metre(Above 18GHz the distance is 1 meter and table is 1.5 metre).
- h. Test the EUT in the lowest channel ,the middle channel ,the Highest channel

Note:

Both horizontal and vertical antenna polarities were tested and performed pretest to three orthogonal axis. The worst case emissions were reported

4.2.3 DEVIATION FROM TEST STANDARD

No deviation

4.2.4 TEST SETUP

(A) Radiated Emission Test-Up Frequency Below 30MHz

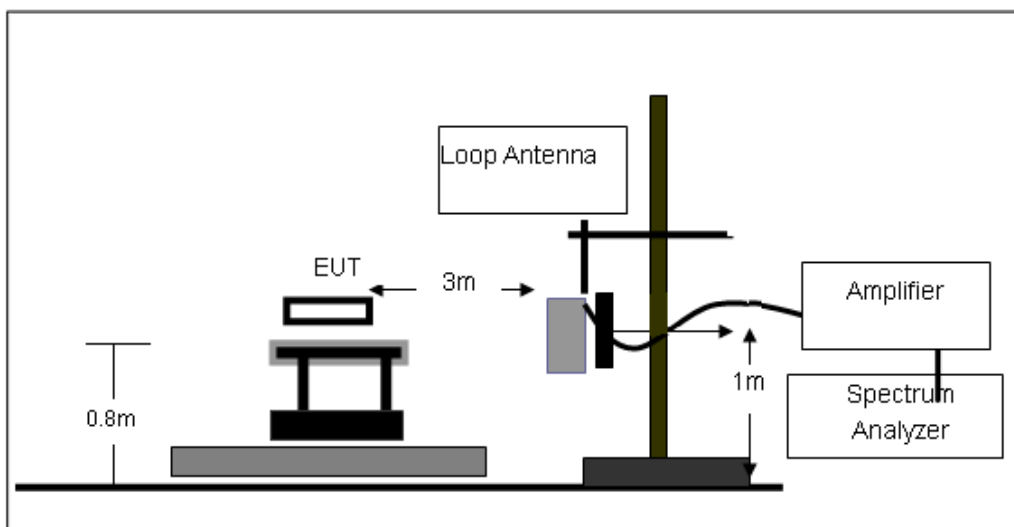

(B) Radiated Emission Test-Up Frequency 30MHz~1GHz

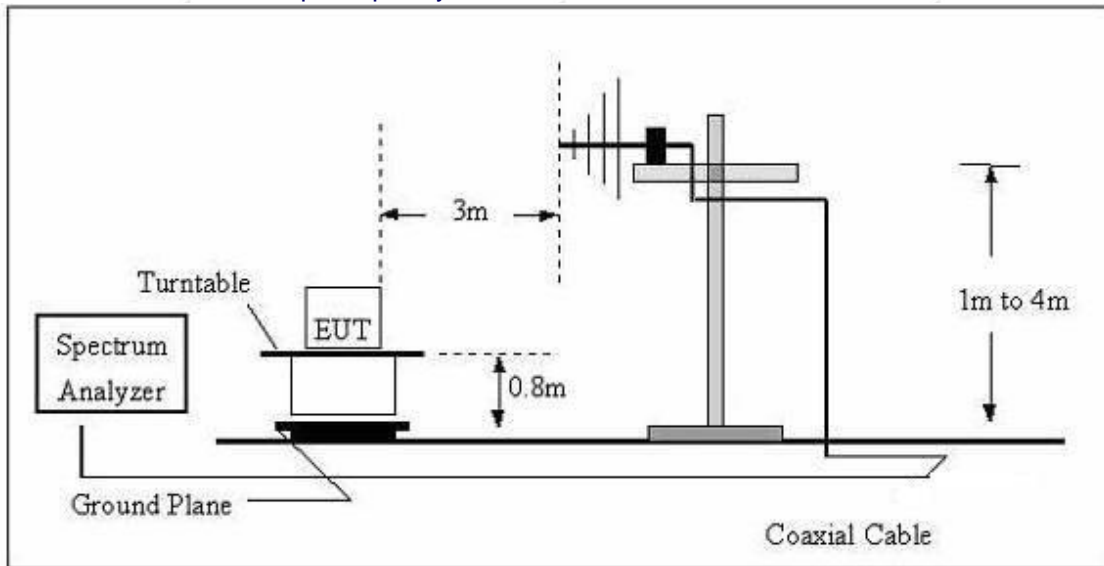

(C) Radiated Emission Test-Up Frequency Above 1GHz

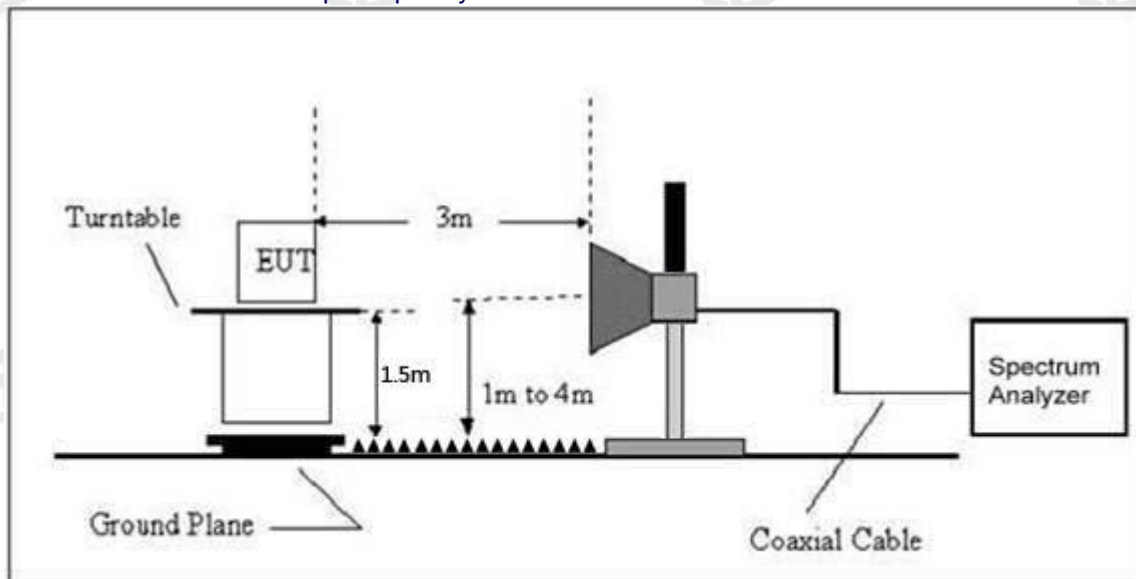

4.2.5 EUT OPERATING CONDITIONS

The EUT tested system was configured as the statements of 2.4 Unless otherwise a special operating condition is specified in the follows during the testing.



4.2.6 TEST RESULTS

Between 9KHz – 30MHz

The emission from 9 kHz to 30MHz was pre-tested and found the result was 20dB lower than the limit, and according to 15.31(o), the test result no need to reported.

Between 30MHz – 1GHz

Temperature:	25.2°C	Relative Humidity:	50%
Pressure:	1010kPa	Polarization:	Horizontal
Test Voltage:	AC 120V/60Hz		

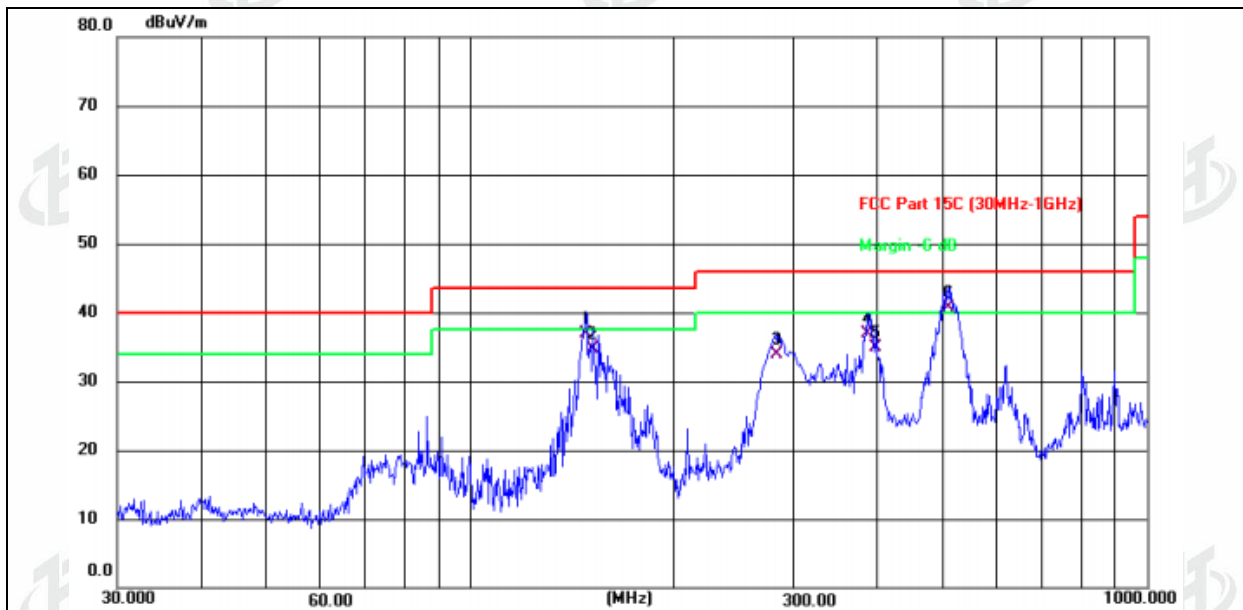

No.	Frequency (MHz)	Reading (dBuV)	Factor (dB/m)	Level (dBuV/m)	Limit (dBuV/m)	Margin (dB)	Detector
1	147.9214	52.15	-15.31	36.84	43.50	-6.66	QP
2	151.5972	50.08	-15.30	34.78	43.50	-8.72	QP
3	282.9851	48.94	-14.96	33.98	46.00	-12.02	QP
4	386.6338	49.24	-12.29	36.95	46.00	-9.05	QP
5	397.6334	46.84	-12.02	34.82	46.00	-11.18	QP
6 *	508.2582	50.42	-9.68	40.74	46.00	-5.26	QP



Temperature:	25.2°C	Relative Humidity:	50%
Pressure:	1010kPa	Polarization:	Vertical
Test Voltage:	AC 120V/60Hz		



No.	Frequency (MHz)	Reading (dBuV)	Factor (dB/m)	Level (dBuV/m)	Limit (dBuV/m)	Margin (dB)	Detector
1	73.8756	47.04	-18.09	28.95	40.00	-11.05	QP
2	148.4410	52.36	-15.29	37.07	43.50	-6.43	QP
3	153.7385	51.19	-15.42	35.77	43.50	-7.73	QP
4 *	511.8352	49.24	-9.58	39.66	46.00	-6.34	QP
5	530.1013	48.04	-9.13	38.91	46.00	-7.09	QP
6	833.3171	37.15	-3.82	33.33	46.00	-12.67	QP

Remarks:

1. Final Level = Receiver Read level + Antenna Factor + Cable Loss
2. The emission levels of other frequencies are very lower than the limit and not show in test report.
3. The test data shows only the worst case GFSK mode (Low Channel: 2402MHz).



1GHz~25GHz

GFSK

Polar (H/V)	Frequency	Meter Reading	Pre-amplifier	Cable Loss	Antenna Factor	Emission Level	Limits	Margin	Detector Type
	(MHz)	(dBuV)	(dB)	(dB)	(dB)	(dBuV/m)	(dBuV/m)	(dB)	
Low Channel:2402MHz									
V	4804.00	59.22	30.55	5.77	24.66	59.1	74	-14.9	Pk
V	4804.00	43.55	30.55	5.77	24.66	43.43	54	-10.57	AV
V	7206.00	56.6	30.33	6.32	24.55	57.14	74	-16.86	Pk
V	7206.00	44.5	30.33	6.32	24.55	45.04	54	-8.96	AV
V	9608.00	55.71	30.55	5.77	24.66	55.59	74	-18.41	Pk
V	9608.00	43.86	30.55	5.77	24.66	43.74	54	-10.26	AV
V	12010.00	59.78	30.33	6.32	24.55	60.32	74	-13.68	Pk
V	12010.00	41.67	30.33	6.32	24.55	42.21	54	-11.79	AV
H	4804.00	56.08	30.55	5.77	24.66	55.96	74	-18.04	Pk
H	4804.00	41.5	30.55	5.77	24.66	41.38	54	-12.62	AV
H	7206.00	58.91	30.33	6.32	24.55	59.45	74	-14.55	Pk
H	7206.00	44.46	30.33	6.32	24.55	45	54	-9	AV
H	9608.00	58.33	30.55	5.77	24.66	58.21	74	-15.79	Pk
H	9608.00	41.42	30.55	5.77	24.66	41.3	54	-12.7	AV
H	12010.00	57.24	30.33	6.32	24.55	57.78	74	-16.22	Pk
H	12010.00	41.32	30.33	6.32	24.55	41.86	54	-12.14	AV

Polar (H/V)	Frequency	Meter Reading	Pre-amplifier	Cable Loss	Antenna Factor	Emission Level	Limits	Margin	Detector Type
	(MHz)	(dBuV)	(dB)	(dB)	(dB)	(dBuV/m)	(dBuV/m)	(dB)	
Middle Channel:2441MHz									
V	4882.00	58.98	30.55	5.77	24.66	58.86	74	-15.14	Pk
V	4882.00	41.24	30.55	5.77	24.66	41.12	54	-12.88	AV
V	7323.00	58.37	30.33	6.32	24.55	58.91	74	-15.09	Pk
V	7323.00	42.67	30.33	6.32	24.55	43.21	54	-10.79	AV
V	9764.00	57.03	30.55	5.77	24.66	56.91	74	-17.09	Pk
V	9764.00	42.71	30.55	5.77	24.66	42.59	54	-11.41	AV
V	12205.00	55.25	30.33	6.32	24.55	55.79	74	-18.21	Pk
V	12205.00	44.89	30.33	6.32	24.55	45.43	54	-8.57	AV
H	4882.00	57.98	30.55	5.77	24.66	57.86	74	-16.14	Pk
H	4882.00	41.67	30.55	5.77	24.66	41.55	54	-12.45	AV
H	7323.00	55.09	30.33	6.32	24.55	55.63	74	-18.37	Pk
H	7323.00	44.51	30.33	6.32	24.55	45.05	54	-8.95	AV
H	9764.00	56.81	30.55	5.77	24.66	56.69	74	-17.31	Pk
H	9764.00	41.83	30.55	5.77	24.66	41.71	54	-12.29	AV
H	12205.00	56.15	30.33	6.32	24.55	56.69	74	-17.31	Pk
H	12205.00	44.71	30.33	6.32	24.55	45.25	54	-8.75	AV



Polar (H/V)	Frequency	Meter Reading	Pre-amplifier	Cable Loss	Antenna Factor	Emission Level	Limits	Margin	Detector Type
	(MHz)	(dBuV)	(dB)	(dB)	(dB)	(dBuV/m)	(dBuV/m)	(dB)	
High Channel:2480MHz									
V	4960.00	56.15	30.55	5.77	24.66	56.03	74	-17.97	Pk
V	4960.00	41.5	30.55	5.77	24.66	41.38	54	-12.62	AV
V	7440.00	55.29	30.33	6.32	24.55	55.83	74	-18.17	Pk
V	7440.00	44.23	30.33	6.32	24.55	44.77	54	-9.23	AV
V	9920.00	58.94	30.55	5.77	24.66	58.82	74	-15.18	Pk
V	9920.00	41.33	30.55	5.77	24.66	41.21	54	-12.79	AV
V	12400.00	56.73	30.33	6.32	24.55	57.27	74	-16.73	Pk
V	12400.00	41.43	30.33	6.32	24.55	41.97	54	-12.03	AV
H	4960.00	58.45	30.55	5.77	24.66	58.33	74	-15.67	Pk
H	4960.00	41.96	30.55	5.77	24.66	41.84	54	-12.16	AV
H	7440.00	57.35	30.33	6.32	24.55	57.89	74	-16.11	Pk
H	7440.00	43.8	30.33	6.32	24.55	44.34	54	-9.66	AV
H	9920.00	56.54	30.55	5.77	24.66	56.42	74	-17.58	Pk
H	9920.00	44.02	30.55	5.77	24.66	43.9	54	-10.1	AV
H	12400.00	57.04	30.33	6.32	24.55	57.58	74	-16.42	Pk
H	12400.00	44	30.33	6.32	24.55	44.54	54	-9.46	AV

Remark:

- Emission Level = Meter Reading + Antenna Factor + Cable Loss – Pre-amplifier,
Margin= Emission Level - Limit
- If peak below the average limit, the average emission was no test.
- The amplitude of spurious emissions which are attenuated by more than 20dB below the permissible value has no need to be reported.



π/4DQPSK

Polar (H/V)	Frequency	Meter Reading	Pre-amplifier	Cable Loss	Antenna Factor	Emission Level	Limits	Margin	Detector Type
	(MHz)	(dBuV)	(dB)	(dB)	(dB)	(dBuV/m)	(dBuV/m)	(dB)	
Low Channel:2402MHz									
V	4804.00	57.9	30.55	5.77	24.66	57.78	74	-16.22	Pk
V	4804.00	43.42	30.55	5.77	24.66	43.3	54	-10.7	AV
V	7206.00	58.61	30.33	6.32	24.55	59.15	74	-14.85	Pk
V	7206.00	44.53	30.33	6.32	24.55	45.07	54	-8.93	AV
V	9608.00	58.9	30.55	5.77	24.66	58.78	74	-15.22	Pk
V	9608.00	41.99	30.55	5.77	24.66	41.87	54	-12.13	AV
V	12010.00	55.79	30.33	6.32	24.55	56.33	74	-17.67	Pk
V	12010.00	42.75	30.33	6.32	24.55	43.29	54	-10.71	AV
H	4804.00	55.67	30.55	5.77	24.66	55.55	74	-18.45	Pk
H	4804.00	41.81	30.55	5.77	24.66	41.69	54	-12.31	AV
H	7206.00	56.55	30.33	6.32	24.55	57.09	74	-16.91	Pk
H	7206.00	43	30.33	6.32	24.55	43.54	54	-10.46	AV
H	9608.00	56.71	30.55	5.77	24.66	56.59	74	-17.41	Pk
H	9608.00	41.42	30.55	5.77	24.66	41.3	54	-12.7	AV
H	12010.00	58.14	30.33	6.32	24.55	58.68	74	-15.32	Pk
H	12010.00	41.57	30.33	6.32	24.55	42.11	54	-11.89	AV

Polar (H/V)	Frequency	Meter Reading	Pre-amplifier	Cable Loss	Antenna Factor	Emission Level	Limits	Margin	Detector Type
	(MHz)	(dBuV)	(dB)	(dB)	(dB)	(dBuV/m)	(dBuV/m)	(dB)	
Middle Channel:2441MHz									
V	4882.00	57.05	30.55	5.77	24.66	56.93	74	-17.07	Pk
V	4882.00	41.54	30.55	5.77	24.66	41.42	54	-12.58	AV
V	7323.00	57.88	30.33	6.32	24.55	58.42	74	-15.58	Pk
V	7323.00	42.03	30.33	6.32	24.55	42.57	54	-11.43	AV
V	9764.00	59.07	30.55	5.77	24.66	58.95	74	-15.05	Pk
V	9764.00	42.29	30.55	5.77	24.66	42.17	54	-11.83	AV
V	12205.00	56.82	30.33	6.32	24.55	57.36	74	-16.64	Pk
V	12205.00	43.39	30.33	6.32	24.55	43.93	54	-10.07	AV
H	4882.00	58.73	30.55	5.77	24.66	58.61	74	-15.39	Pk
H	4882.00	41.97	30.55	5.77	24.66	41.85	54	-12.15	AV
H	7323.00	58.05	30.33	6.32	24.55	58.59	74	-15.41	Pk
H	7323.00	43.13	30.33	6.32	24.55	43.67	54	-10.33	AV
H	9764.00	56.15	30.55	5.77	24.66	56.03	74	-17.97	Pk
H	9764.00	42.49	30.55	5.77	24.66	42.37	54	-11.63	AV
H	12205.00	59.24	30.33	6.32	24.55	59.78	74	-14.22	Pk
H	12205.00	44.76	30.33	6.32	24.55	45.3	54	-8.7	AV



Polar (H/V)	Frequency	Meter Reading	Pre-amplifier	Cable Loss	Antenna Factor	Emission Level	Limits	Margin	Detector Type
	(MHz)	(dBuV)	(dB)	(dB)	(dB)	(dBuV/m)	(dBuV/m)	(dB)	
High Channel:2480MHz									
V	4960.00	55.19	30.55	5.77	24.66	55.07	74	-18.93	Pk
V	4960.00	41.34	30.55	5.77	24.66	41.22	54	-12.78	AV
V	7440.00	57.75	30.33	6.32	24.55	58.29	74	-15.71	Pk
V	7440.00	43.87	30.33	6.32	24.55	44.41	54	-9.59	AV
V	9920.00	58.98	30.55	5.77	24.66	58.86	74	-15.14	Pk
V	9920.00	41.96	30.55	5.77	24.66	41.84	54	-12.16	AV
V	12400.00	58.21	30.33	6.32	24.55	58.75	74	-15.25	Pk
V	12400.00	41.06	30.33	6.32	24.55	41.6	54	-12.4	AV
H	4960.00	57.47	30.55	5.77	24.66	57.35	74	-16.65	Pk
H	4960.00	41.73	30.55	5.77	24.66	41.61	54	-12.39	AV
H	7440.00	55.78	30.33	6.32	24.55	56.32	74	-17.68	Pk
H	7440.00	44.57	30.33	6.32	24.55	45.11	54	-8.89	AV
H	9920.00	58.68	30.55	5.77	24.66	58.56	74	-15.44	Pk
H	9920.00	44.82	30.55	5.77	24.66	44.7	54	-9.3	AV
H	12400.00	55.07	30.33	6.32	24.55	55.61	74	-18.39	Pk
H	12400.00	44.38	30.33	6.32	24.55	44.92	54	-9.08	AV

Remark:

1. Emission Level = Meter Reading + Antenna Factor + Cable Loss – Pre-amplifier,
Margin= Emission Level - Limit
2. If peak below the average limit, the average emission was no test.
3. The amplitude of spurious emissions which are attenuated by more than 20dB below the permissible value has no need to be reported.



8DPSK

Polar (H/V)	Frequency	Meter Reading	Pre-amplifier	Cable Loss	Antenna Factor	Emission Level	Limits	Margin	Detector Type
	(MHz)	(dBuV)	(dB)	(dB)	(dB)	(dBuV/m)	(dBuV/m)	(dB)	
Low Channel:2402MHz									
V	4804.00	59.85	30.55	5.77	24.66	59.73	74	-14.27	Pk
V	4804.00	42.71	30.55	5.77	24.66	42.59	54	-11.41	AV
V	7206.00	58.2	30.33	6.32	24.55	58.74	74	-15.26	Pk
V	7206.00	41.45	30.33	6.32	24.55	41.99	54	-12.01	AV
V	9608.00	59.11	30.55	5.77	24.66	58.99	74	-15.01	Pk
V	9608.00	44.71	30.55	5.77	24.66	44.59	54	-9.41	AV
V	12010.00	57.11	30.33	6.32	24.55	57.65	74	-16.35	Pk
V	12010.00	41.43	30.33	6.32	24.55	41.97	54	-12.03	AV
H	4804.00	58.43	30.55	5.77	24.66	58.31	74	-15.69	Pk
H	4804.00	41.73	30.55	5.77	24.66	41.61	54	-12.39	AV
H	7206.00	59.98	30.33	6.32	24.55	60.52	74	-13.48	Pk
H	7206.00	43.85	30.33	6.32	24.55	44.39	54	-9.61	AV
H	9608.00	57.78	30.55	5.77	24.66	57.66	74	-16.34	Pk
H	9608.00	41.07	30.55	5.77	24.66	40.95	54	-13.05	AV
H	12010.00	55.96	30.33	6.32	24.55	56.5	74	-17.5	Pk
H	12010.00	41.14	30.33	6.32	24.55	41.68	54	-12.32	AV

Polar (H/V)	Frequency	Meter Reading	Pre-amplifier	Cable Loss	Antenna Factor	Emission Level	Limits	Margin	Detector Type
	(MHz)	(dBuV)	(dB)	(dB)	(dB)	(dBuV/m)	(dBuV/m)	(dB)	
Middle Channel:2441MHz									
V	4882.00	55.15	30.55	5.77	24.66	55.03	74	-18.97	Pk
V	4882.00	41.15	30.55	5.77	24.66	41.03	54	-12.97	AV
V	7323.00	57.77	30.33	6.32	24.55	58.31	74	-15.69	Pk
V	7323.00	41.7	30.33	6.32	24.55	42.24	54	-11.76	AV
V	9764.00	59.55	30.55	5.77	24.66	59.43	74	-14.57	Pk
V	9764.00	43.32	30.55	5.77	24.66	43.2	54	-10.8	AV
V	12205.00	57.55	30.33	6.32	24.55	58.09	74	-15.91	Pk
V	12205.00	43.15	30.33	6.32	24.55	43.69	54	-10.31	AV
H	4882.00	59.14	30.55	5.77	24.66	59.02	74	-14.98	Pk
H	4882.00	44.72	30.55	5.77	24.66	44.6	54	-9.4	AV
H	7323.00	59.32	30.33	6.32	24.55	59.86	74	-14.14	Pk
H	7323.00	44.56	30.33	6.32	24.55	45.1	54	-8.9	AV
H	9764.00	55.62	30.55	5.77	24.66	55.5	74	-18.5	Pk
H	9764.00	42.31	30.55	5.77	24.66	42.19	54	-11.81	AV
H	12205.00	55.58	30.33	6.32	24.55	56.12	74	-17.88	Pk
H	12205.00	43.41	30.33	6.32	24.55	43.95	54	-10.05	AV



Polar (H/V)	Frequency	Meter Reading	Pre-amplifier	Cable Loss	Antenna Factor	Emission Level	Limits	Margin	Detector Type
	(MHz)	(dBuV)	(dB)	(dB)	(dB)	(dBuV/m)	(dBuV/m)	(dB)	
High Channel:2480MHz									
V	4960.00	55.66	30.55	5.77	24.66	55.54	74	-18.46	Pk
V	4960.00	41.23	30.55	5.77	24.66	41.11	54	-12.89	AV
V	7440.00	57.59	30.33	6.32	24.55	58.13	74	-15.87	Pk
V	7440.00	42.66	30.33	6.32	24.55	43.2	54	-10.8	AV
V	9920.00	56.38	30.55	5.77	24.66	56.26	74	-17.74	Pk
V	9920.00	41.24	30.55	5.77	24.66	41.12	54	-12.88	AV
V	12400.00	55.47	30.33	6.32	24.55	56.01	74	-17.99	Pk
V	12400.00	41.61	30.33	6.32	24.55	42.15	54	-11.85	AV
H	4960.00	55	30.55	5.77	24.66	54.88	74	-19.12	Pk
H	4960.00	41.34	30.55	5.77	24.66	41.22	54	-12.78	AV
H	7440.00	55.82	30.33	6.32	24.55	56.36	74	-17.64	Pk
H	7440.00	41.61	30.33	6.32	24.55	42.15	54	-11.85	AV
H	9920.00	57.18	30.55	5.77	24.66	57.06	74	-16.94	Pk
H	9920.00	44.41	30.55	5.77	24.66	44.29	54	-9.71	AV
H	12400.00	57.83	30.33	6.32	24.55	58.37	74	-15.63	Pk
H	12400.00	41.36	30.33	6.32	24.55	41.9	54	-12.1	AV

Remark:

1. Emission Level = Meter Reading + Antenna Factor + Cable Loss – Pre-amplifier,
Margin= Emission Level - Limit
2. If peak below the average limit, the average emission was no test.
3. The amplitude of spurious emissions which are attenuated by more than 20dB below the permissible value has no need to be reported.

5. RADIATED BAND EMISSION MEASUREMENT

5.1 Test Requirement:

Test Requirement:	FCC Part15 C Section 15.209 and 15.205, RSS-Gen 8.9, RSS-Gen 8.10				
Test Method:	ANSI C63.10: 2013				
Test Frequency Range:	All of the restrict bands were tested, only the worst band's (2310MHz to 2500MHz) data was showed.				
Test site:	Measurement Distance: 3m				
Receiver setup:	Frequency	Detector	RBW	VBW	Value
	Above 1GHz	Peak	1MHz	3MHz	Peak
		Average	1MHz	3MHz	Average

LIMITS OF RADIATED EMISSION MEASUREMENT (Above 1000MHz)

FREQUENCY (MHz)	Limit (dBuV/m) (at 3M)	
	PEAK	AVERAGE
Above 1000	74	54

Notes:

- (1) The limit for radiated test was performed according to FCC PART 15C.
- (2) The tighter limit applies at the band edges.
- (3) Emission level (dBuV/m)=20log Emission level (uV/m).

Spectrum Parameter	Setting
Attenuation	Auto
Start Frequency	2300MHz
Stop Frequency	2520
RB / VB (emission in restricted band)	1 MHz / 1 MHz for Peak, 1 MHz / 10Hz for Average

5.2 TEST PROCEDURE

Above 1GHz test procedure as below:

- a. 1. The EUT was placed on the top of a rotating table 1.5 meters above the ground at a 3 meter camber. The table was rotated 360 degrees to determine the position of the highest radiation.
- b. The EUT was set 3 meters away from the interference-receiving antenna, which was mounted on the top of a variable-height antenna tower.
- c. The antenna height is varied from one meter to four meters above the ground to determine the maximum value of the field strength. Both horizontal and vertical polarizations of the antenna are set to make the measurement.
- d. For each suspected emission, the EUT was arranged to its worst case and then the antenna was tuned to heights from 1 meter to 4 meters and the rota table was turned from 0 degrees to 360 degrees to find the maximum reading.
- e. The test-receiver system was set to Peak Detect Function and Specified Bandwidth with Maximum Hold Mode.
- f. If the emission level of the EUT in peak mode was 10dB lower than the limit specified, then testing could be stopped and the peak values of the EUT would be reported. Otherwise the emissions that did not have 10dB margin would be re-tested one by one using peak, quasi-peak or average method as specified and then reported in a data sheet.
- g. Test the EUT in the lowest channel,the Highest channel

Note:

Both horizontal and vertical antenna polarities were tested and performed pretest to three orthogonal axis. The worst case emissions were reported

5.3 DEVIATION FROM TEST STANDARD

No deviation

5.4 TEST SETUP

Radiated Emission Test-Up Frequency Above 1GHz

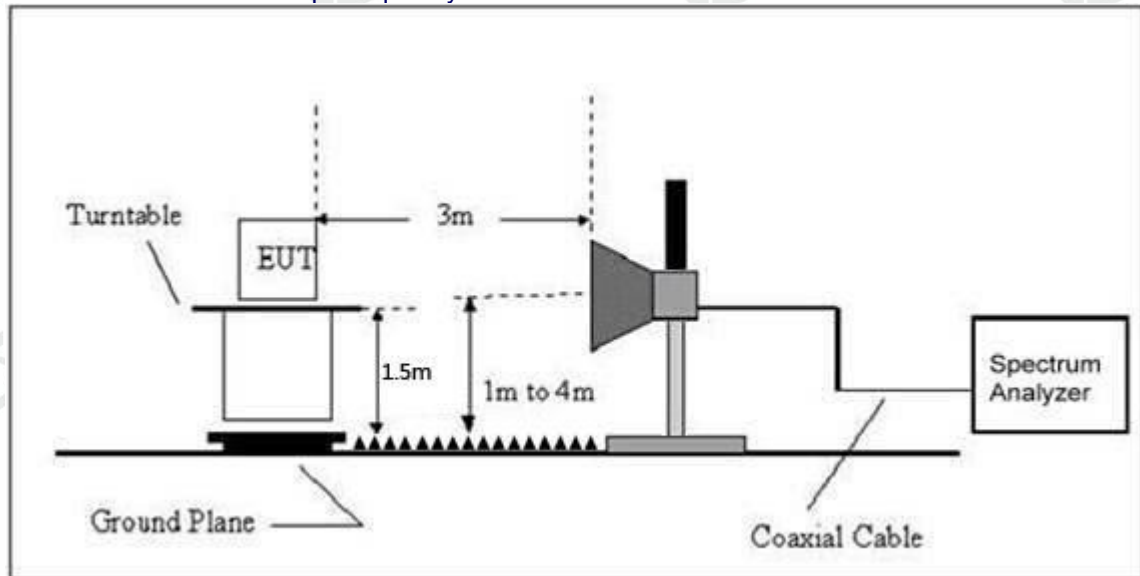

5.5 EUT OPERATING CONDITIONS

The EUT tested system was configured as the statements of 2.3 Unless otherwise a special operating condition is specified in the follows during the testing.



5.6 TEST RESULT

	Polar (H/V)	Frequency (MHz)	Meter Reading (dBuV)	Pre-amplifier (dB)	Cable Loss (dB)	Antenna Factor (dB/m)	Emission level (dBuV/m)	Limit (dBuV/m)	Margin (dB)	Detector Type	Result
GFSK	Low Channel: 2402MHz										
	H	2390.00	59.99	30.22	4.85	23.98	58.60	74.00	-15.40	PK	PASS
	H	2390.00	47.66	30.22	4.85	23.98	46.27	54.00	-7.73	AV	PASS
	H	2400.00	61.37	30.22	4.85	23.98	59.98	74.00	-14.02	PK	PASS
	H	2400.00	47.42	30.22	4.85	23.98	46.03	54.00	-7.97	AV	PASS
	V	2390.00	59.12	30.22	4.85	23.98	57.73	74.00	-16.27	PK	PASS
	V	2390.00	48.85	30.22	4.85	23.98	47.46	54.00	-6.54	AV	PASS
	V	2400.00	61.96	30.22	4.85	23.98	60.57	74.00	-13.43	PK	PASS
	V	2400.00	47.87	30.22	4.85	23.98	46.48	54.00	-7.52	AV	PASS
	High Channel: 2480MHz										
	H	2483.50	59.17	30.22	4.85	23.98	57.78	74.00	-16.22	PK	PASS
	H	2483.50	46.50	30.22	4.85	23.98	45.11	54.00	-8.89	AV	PASS
	H	2500.00	59.96	30.22	4.85	23.98	58.57	74.00	-15.43	PK	PASS
	H	2500.00	48.03	30.22	4.85	23.98	46.64	54.00	-7.36	AV	PASS
	V	2483.50	60.86	30.22	4.85	23.98	59.47	74.00	-14.53	PK	PASS
	V	2483.50	48.50	30.22	4.85	23.98	47.11	54.00	-6.89	AV	PASS
V	2500.00	62.79	30.22	4.85	23.98	61.40	74.00	-12.60	PK	PASS	
V	2500.00	47.32	30.22	4.85	23.98	45.93	54.00	-8.07	AV	PASS	
π/4DQPSK	Low Channel: 2402MHz										
	H	2390.00	59.01	30.22	4.85	23.98	57.62	74.00	-16.38	PK	PASS
	H	2390.00	47.82	30.22	4.85	23.98	46.43	54.00	-7.57	AV	PASS
	H	2400.00	61.55	30.22	4.85	23.98	60.16	74.00	-13.84	PK	PASS
	H	2400.00	47.03	30.22	4.85	23.98	45.64	54.00	-8.36	AV	PASS
	V	2390.00	62.53	30.22	4.85	23.98	61.14	74.00	-12.86	PK	PASS
	V	2390.00	48.95	30.22	4.85	23.98	47.56	54.00	-6.44	AV	PASS
	V	2400.00	62.12	30.22	4.85	23.98	60.73	74.00	-13.27	PK	PASS
	V	2400.00	46.49	30.22	4.85	23.98	45.10	54.00	-8.90	AV	PASS
	High Channel: 2480MHz										
	H	2483.50	59.76	30.22	4.85	23.98	58.37	74.00	-15.63	PK	PASS
	H	2483.50	47.01	30.22	4.85	23.98	45.62	54.00	-8.38	AV	PASS
	H	2500.00	61.19	30.22	4.85	23.98	59.80	74.00	-14.20	PK	PASS
	H	2500.00	46.01	30.22	4.85	23.98	44.62	54.00	-9.38	AV	PASS
	V	2483.50	59.62	30.22	4.85	23.98	58.23	74.00	-15.77	PK	PASS
	V	2483.50	47.06	30.22	4.85	23.98	45.67	54.00	-8.33	AV	PASS
V	2500.00	61.42	30.22	4.85	23.98	60.03	74.00	-13.97	PK	PASS	
V	2500.00	48.16	30.22	4.85	23.98	46.77	54.00	-7.23	AV	PASS	



Low Channel: 2402MHz												
8DPSK	H	2390.00	60.87	30.22	4.85	23.98	59.48	74.00	-14.52	PK	PASS	
	H	2390.00	48.63	30.22	4.85	23.98	47.24	54.00	-6.76	AV	PASS	
	H	2400.00	59.71	30.22	4.85	23.98	58.32	74.00	-15.68	PK	PASS	
	H	2400.00	46.28	30.22	4.85	23.98	44.89	54.00	-9.11	AV	PASS	
	V	2390.00	59.01	30.22	4.85	23.98	57.62	74.00	-16.38	PK	PASS	
	V	2390.00	48.95	30.22	4.85	23.98	47.56	54.00	-6.44	AV	PASS	
	V	2400.00	61.78	30.22	4.85	23.98	60.39	74.00	-13.61	PK	PASS	
	V	2400.00	46.40	30.22	4.85	23.98	45.01	54.00	-8.99	AV	PASS	
	High Channel: 2480MHz											
	H	2483.50	59.73	30.22	4.85	23.98	58.34	74.00	-15.66	PK	PASS	
	H	2483.50	47.34	30.22	4.85	23.98	45.95	54.00	-8.05	AV	PASS	
	H	2500.00	59.67	30.22	4.85	23.98	58.28	74.00	-15.72	PK	PASS	
	H	2500.00	47.09	30.22	4.85	23.98	45.70	54.00	-8.30	AV	PASS	
	V	2483.50	61.57	30.22	4.85	23.98	60.18	74.00	-13.82	PK	PASS	
	V	2483.50	47.60	30.22	4.85	23.98	46.21	54.00	-7.79	AV	PASS	
	V	2500.00	61.82	30.22	4.85	23.98	60.43	74.00	-13.57	PK	PASS	
V	2500.00	48.40	30.22	4.85	23.98	47.01	54.00	-6.99	AV	PASS		
Remark:												
1. Emission Level = Meter Reading + Antenna Factor + Cable Loss – Pre-amplifier, Margin= Emission Level - Limit												



6. CONDUCTED BAND EDGE AND SPURIOUS EMISSION

Test Requirement:	FCC Part15 C Section 15.247 (d), RSS-247 5.5
Test Method:	ANSI C63.10

6.1 Limit

In any 100 kHz bandwidth outside the frequency band in which the spread spectrum or digitally modulated intentional radiator is operating, the radio frequency power that is produced by the intentional radiator shall be at least 20 dB below that in the 100 kHz bandwidth within the band that contains the highest level of the desired power, based on either an RF con-ducted or a radiated measurement, pro-vided the transmitter demonstrates compliance with the peak conducted power limits. If the transmitter com-plies with the conducted power limits based on the use of RMS averaging over a time interval, as permitted under paragraph (b)(3) of this section, the attenuation required under this paragraph shall be 30 dB instead of 20 dB. Attenuation below the general limits specified in §15.209(a) is not required.

According to RSS-247§5.5 and RSS-Gen§8.9, In any 100 kHz bandwidth outside the frequency band in which the spread spectrum or digitally modulated intentional radiator is operating, the radio frequency power that is produced by the intentional radiator shall be at least 20 dB below that in the 100 kHz bandwidth within the band that contains the highest level of the desired power, based on either an RF conducted or a radiated measurement. Attenuation below the general limits specified in Section 15.209(a) or RSS-Gen is not required.

6.2 Test Setup

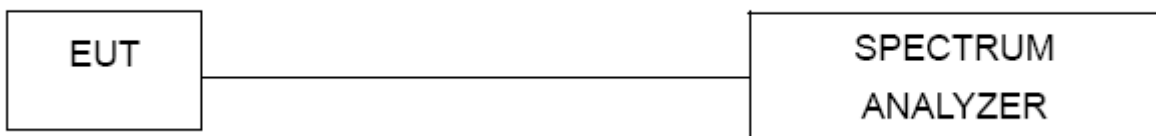

6.3 Test procedure

Using the following spectrum analyzer setting:

- A) Set the RBW = 100KHz.
- B) Set the VBW = 300KHz.
- C) Sweep time = auto couple.
- D) Detector function = peak.
- E) Trace mode = max hold.
- F) Allow trace to fully stabilize.

6.4 DEVIATION FROM STANDARD

No deviation.



6.5 Test Result

Band Edge

Condition	Mode	Frequency (MHz)	Antenna	Hopping Mode	Max Value (dBc)	Limit (dBc)	Verdict
NVNT	1-DH5	2402	Ant1	No-Hopping	-57.22	-20	Pass
NVNT	1-DH5	2480	Ant1	No-Hopping	-54.89	-20	Pass
NVNT	2-DH5	2402	Ant1	No-Hopping	-58.27	-20	Pass
NVNT	2-DH5	2480	Ant1	No-Hopping	-56.27	-20	Pass
NVNT	3-DH5	2402	Ant1	No-Hopping	-57.67	-20	Pass
NVNT	3-DH5	2480	Ant1	No-Hopping	-59	-20	Pass

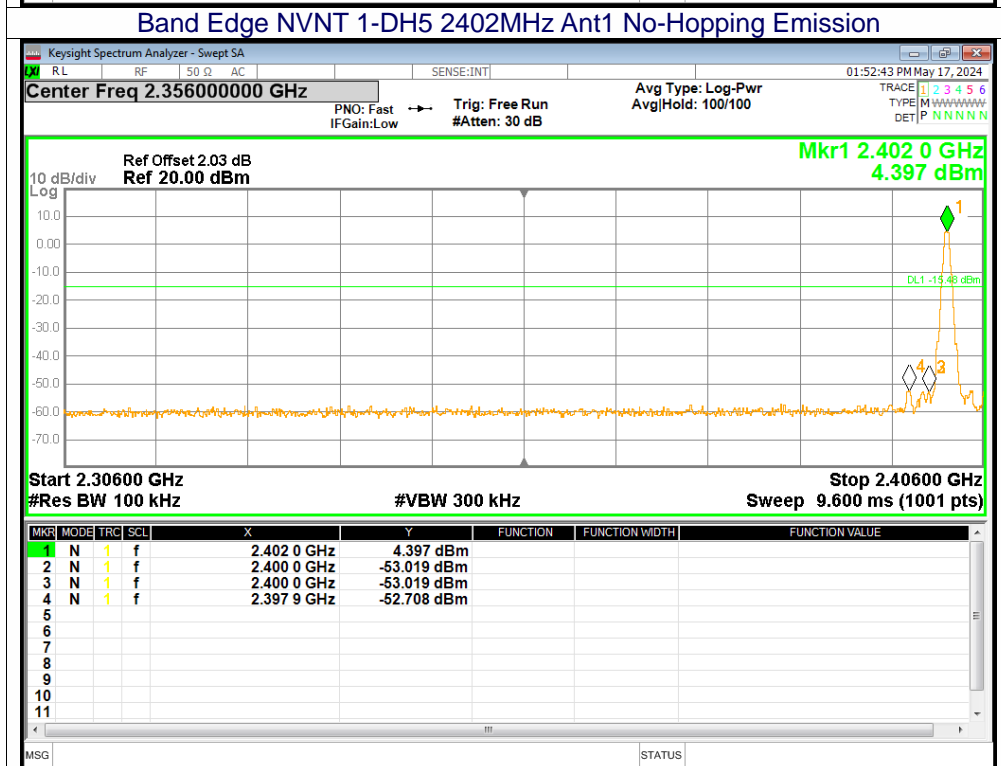
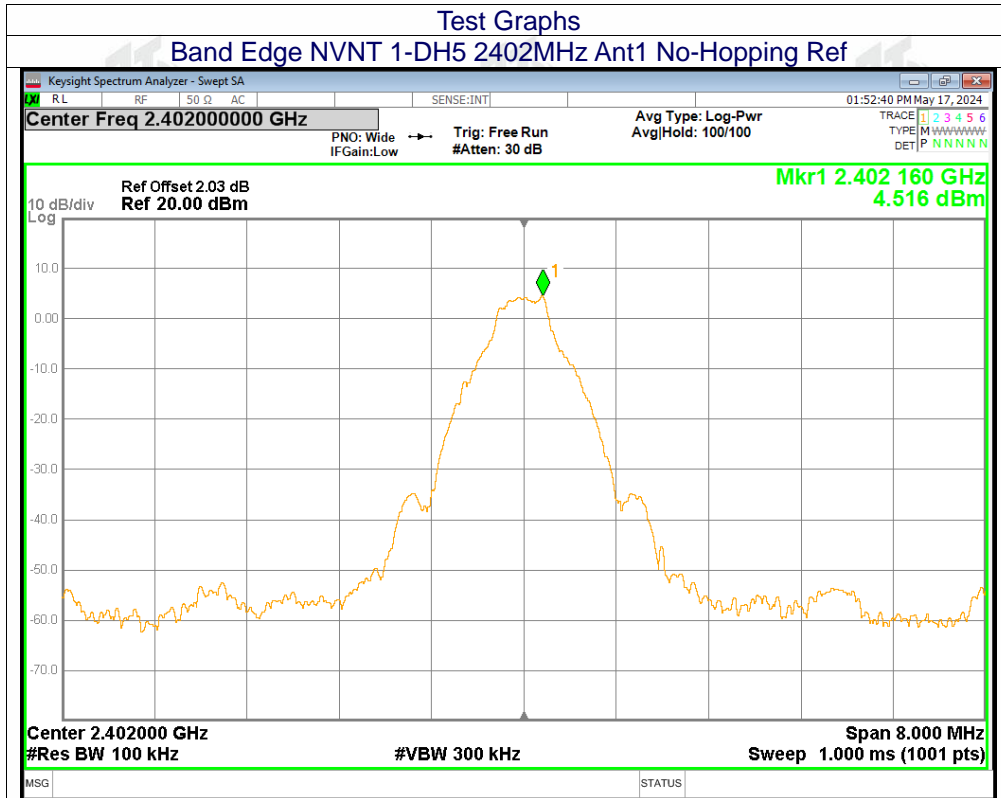

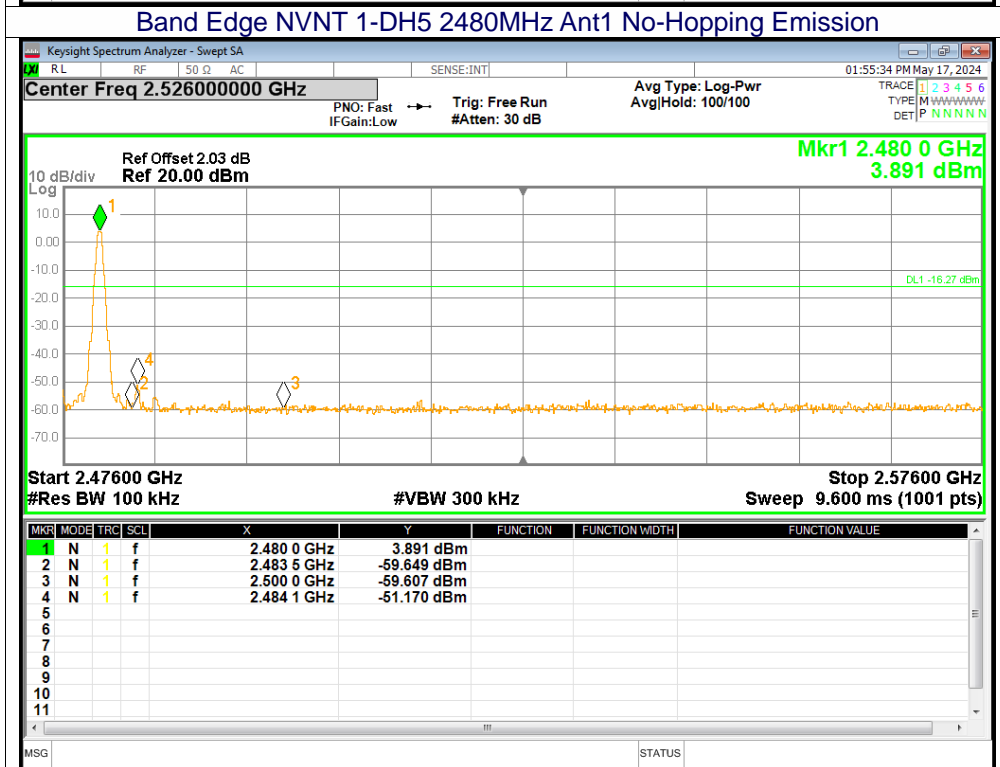
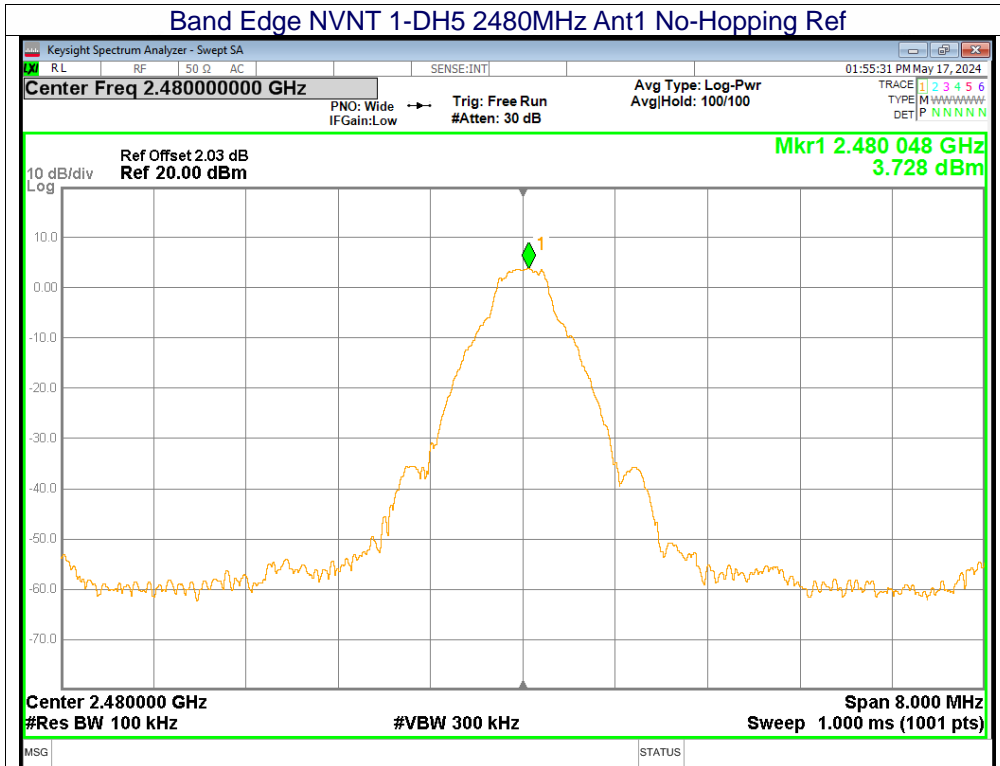

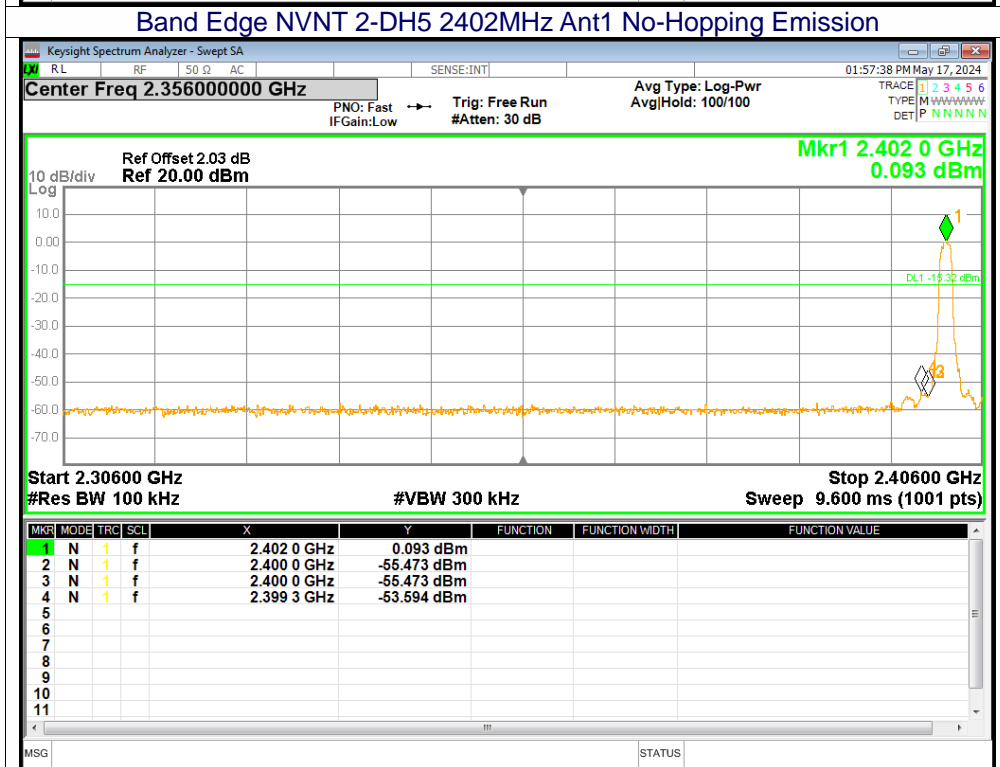
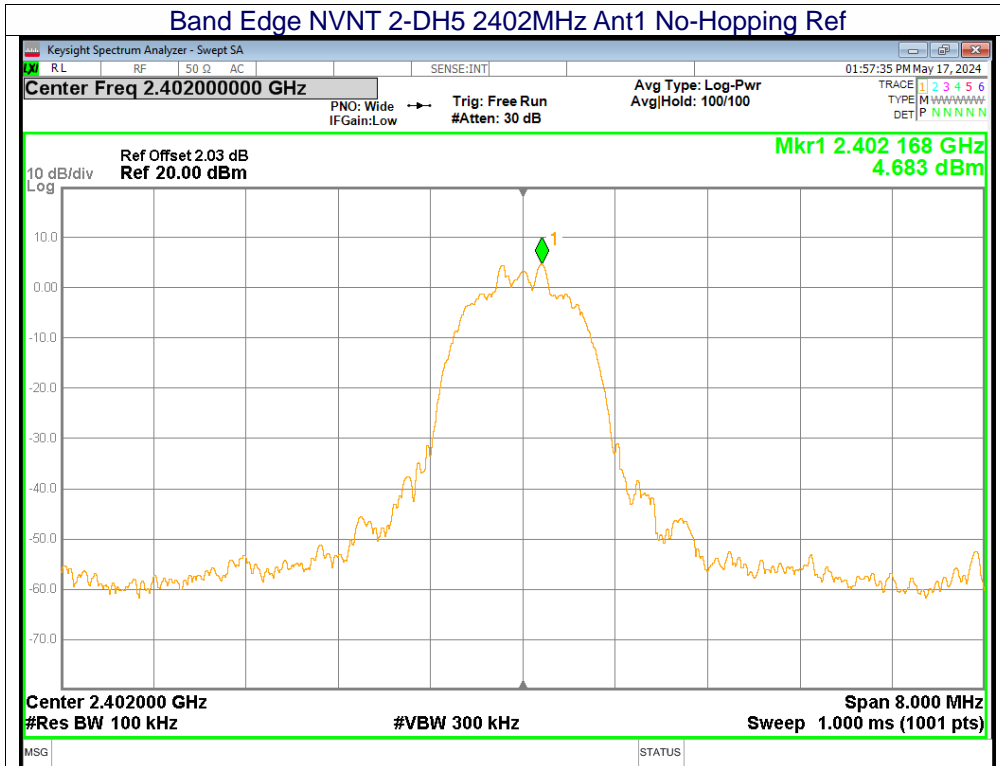

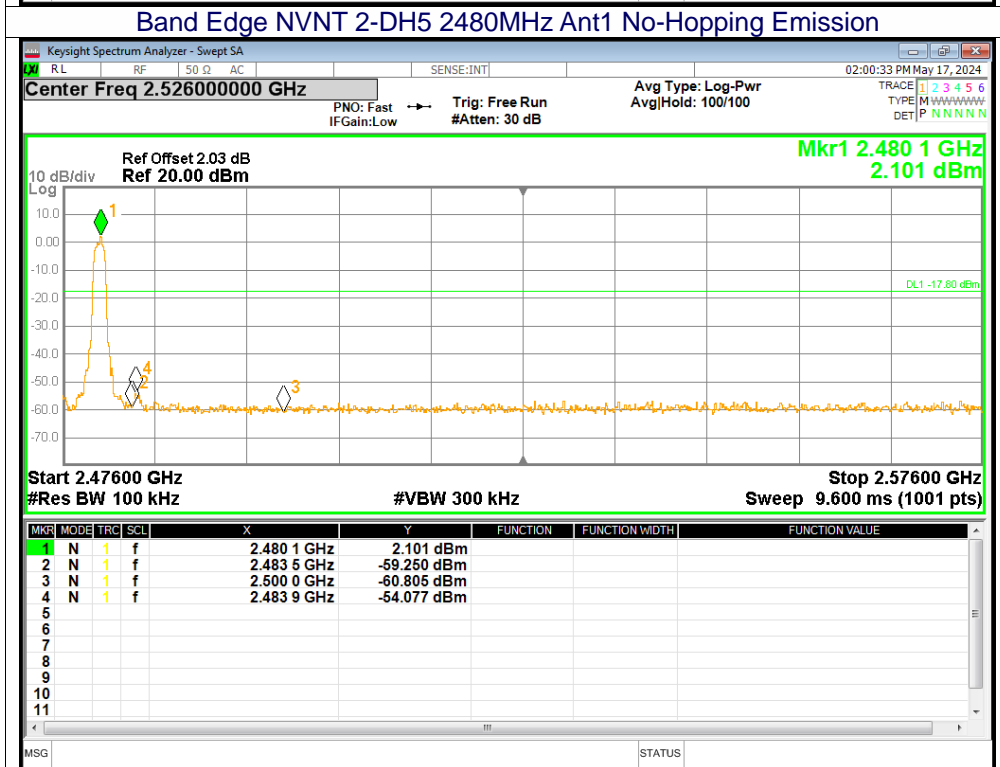
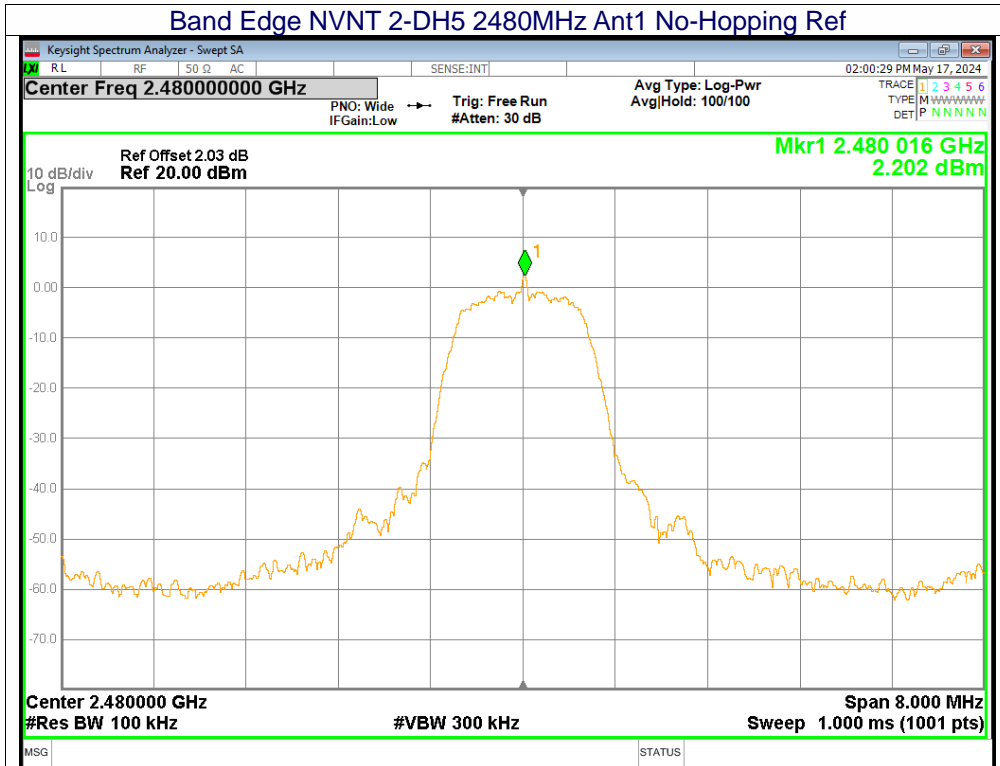

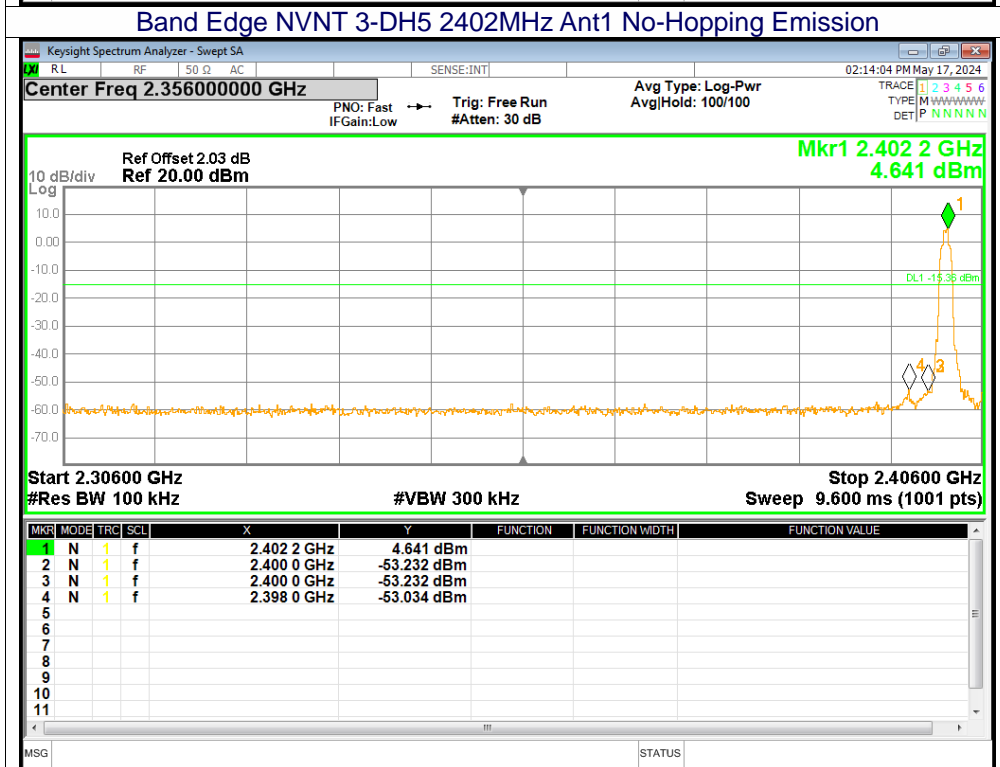
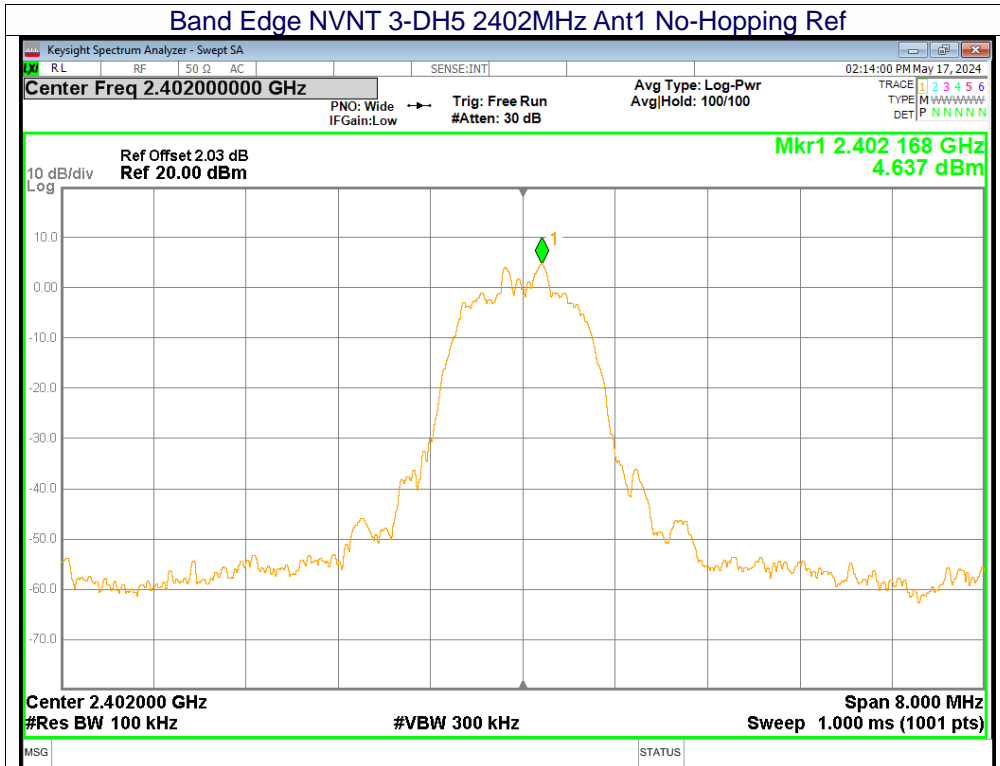

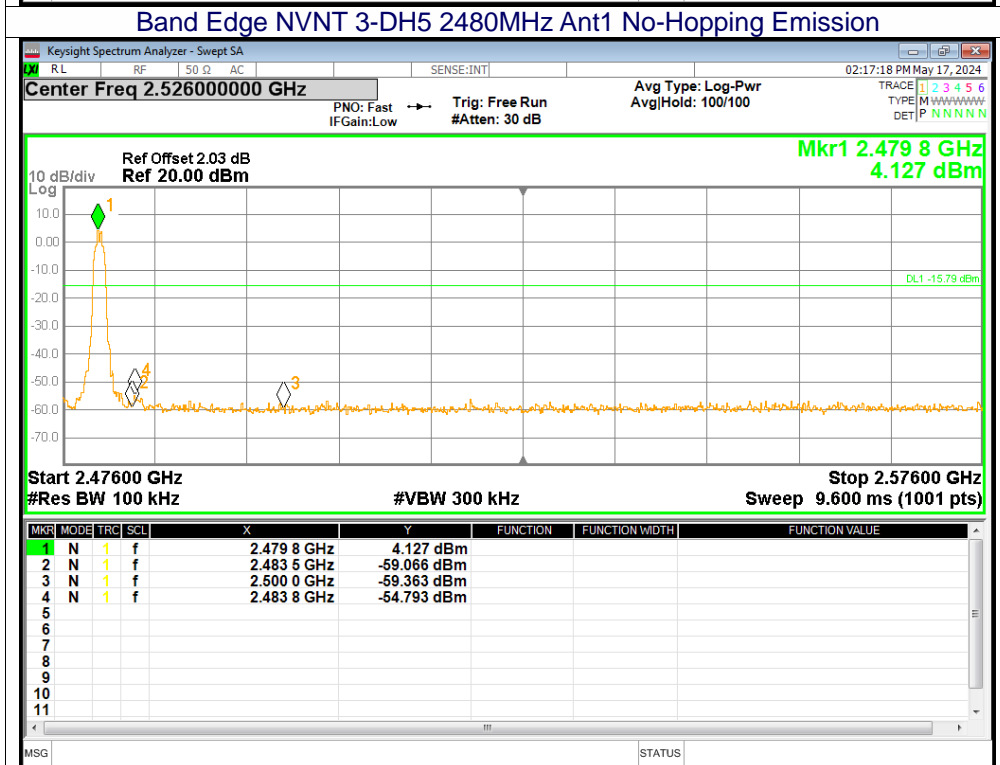
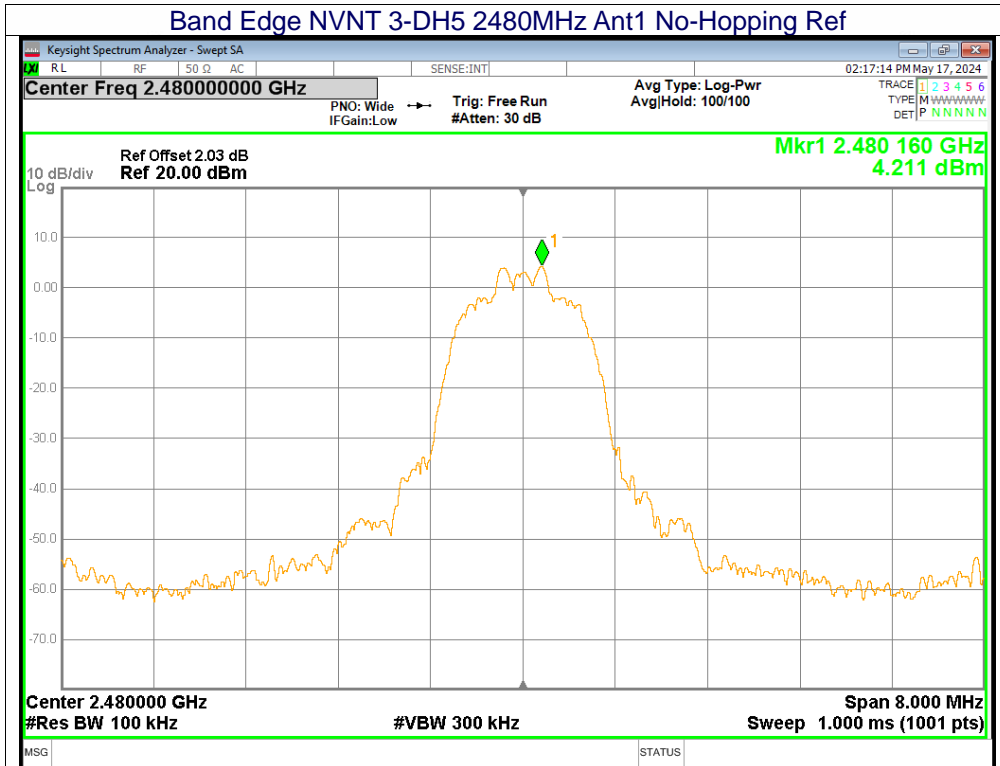



Band Edge(Hopping)

Condition	Mode	Frequency (MHz)	Antenna	Hopping Mode	Max Value (dBc)	Limit (dBc)	Verdict
NVNT	1-DH5	2402	Ant1	Hopping	-60.81	-20	Pass
NVNT	1-DH5	2480	Ant1	Hopping	-56.71	-20	Pass
NVNT	2-DH5	2402	Ant1	Hopping	-62.31	-20	Pass
NVNT	2-DH5	2480	Ant1	Hopping	-61.57	-20	Pass
NVNT	3-DH5	2402	Ant1	Hopping	-61.84	-20	Pass
NVNT	3-DH5	2480	Ant1	Hopping	-61.76	-20	Pass

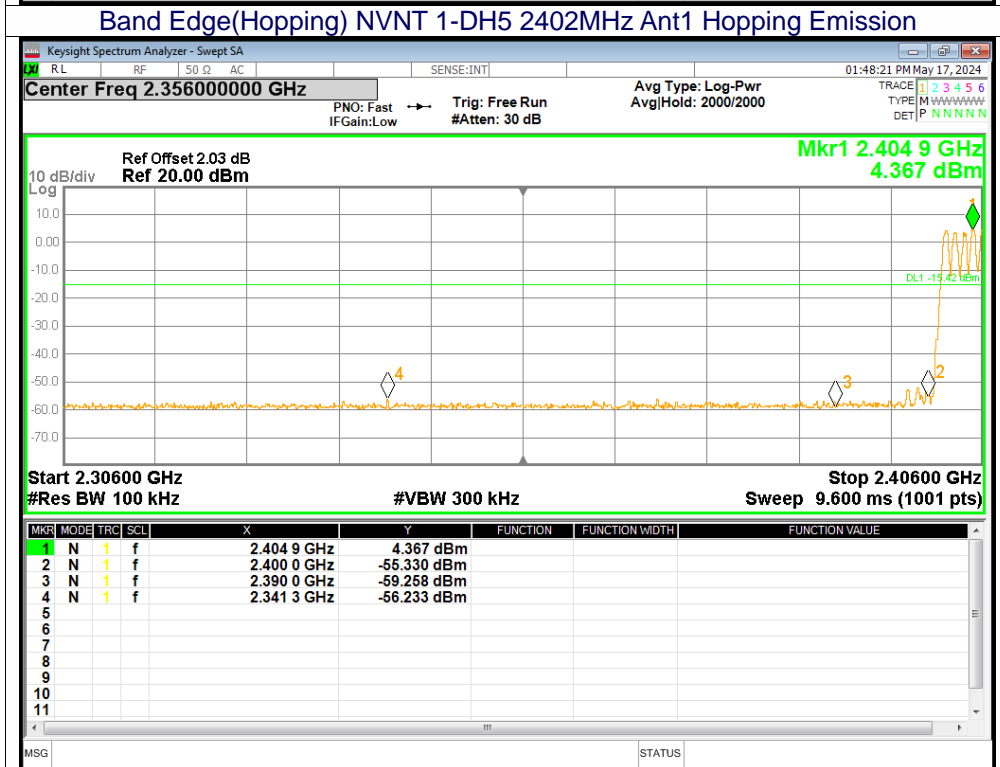
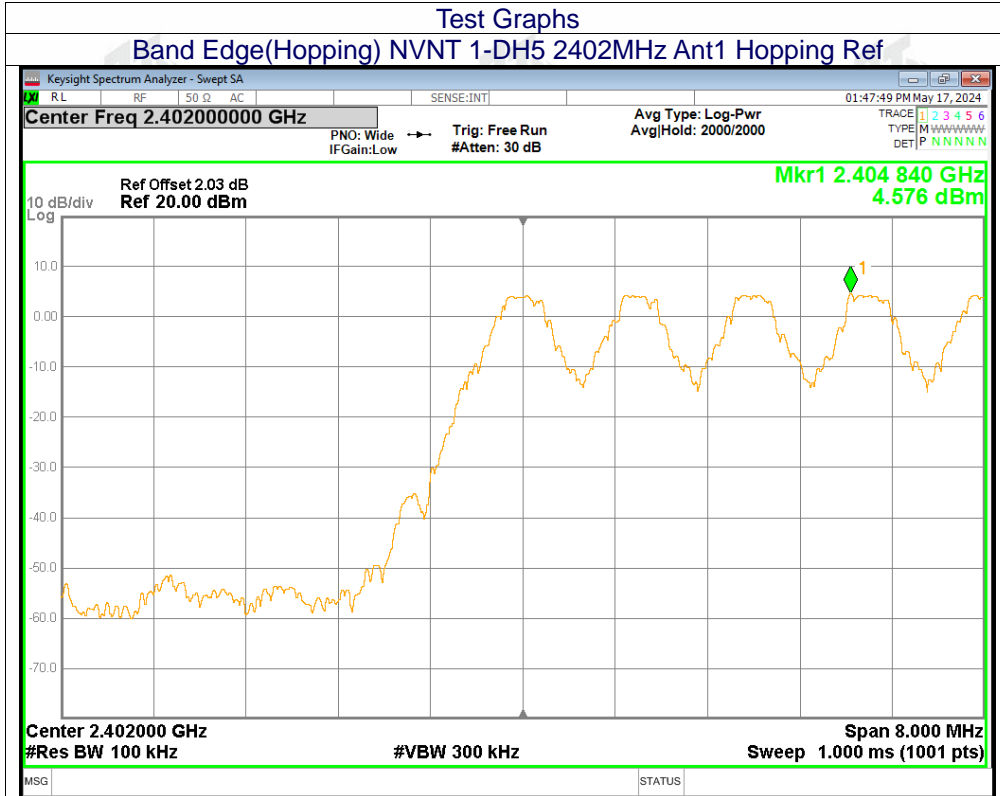

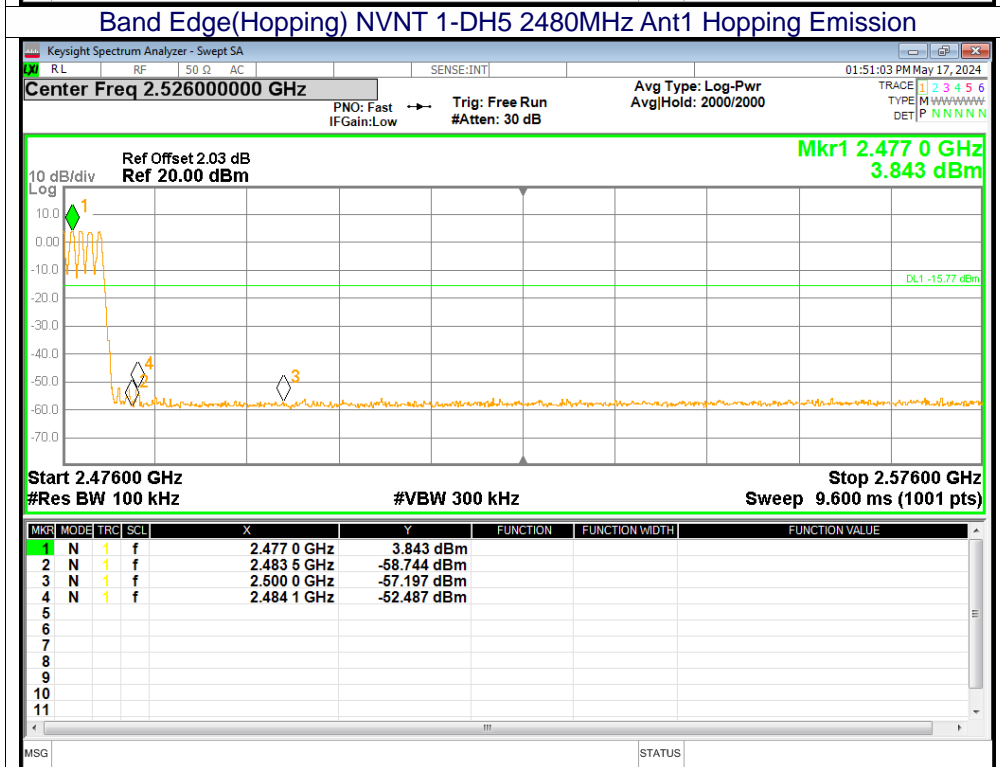
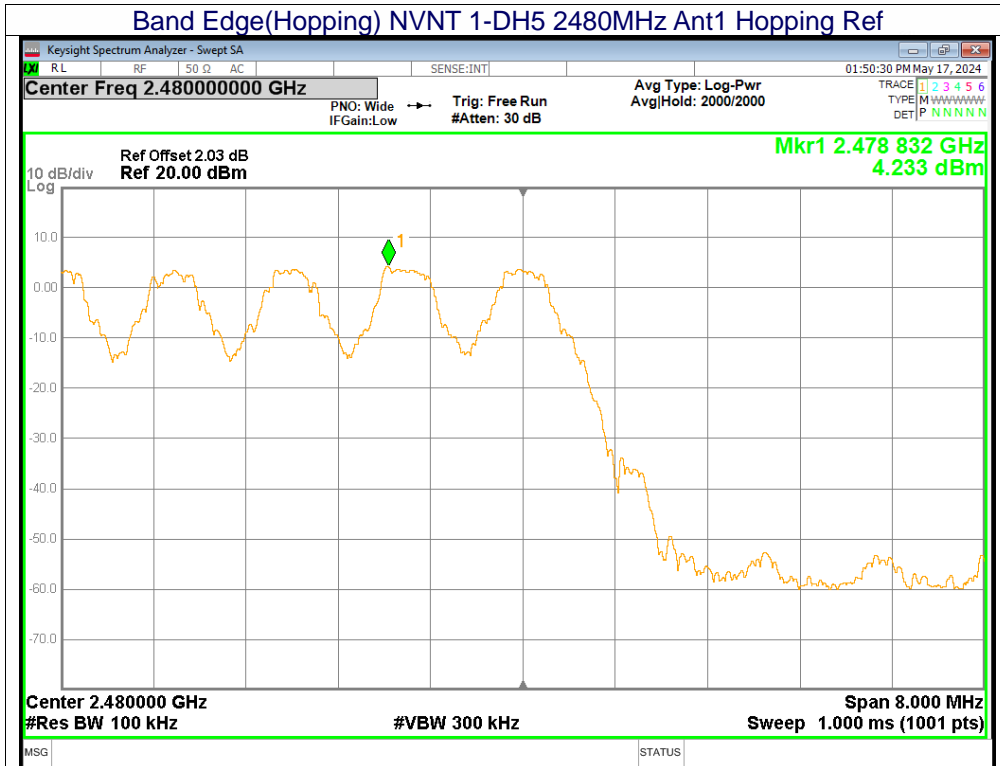

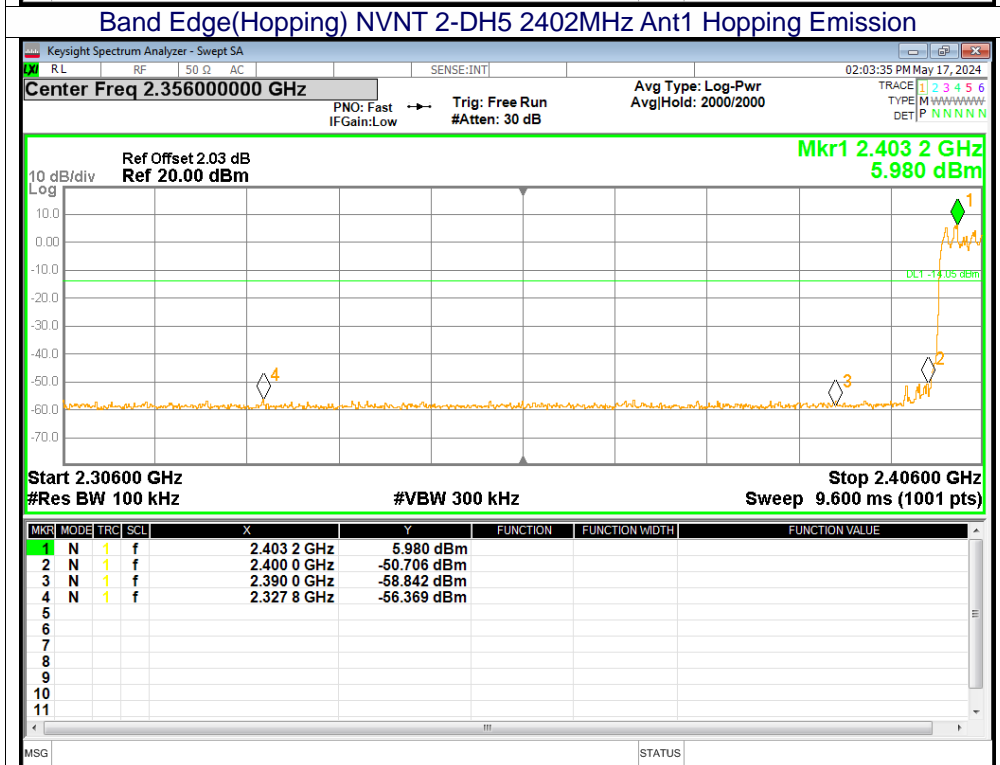
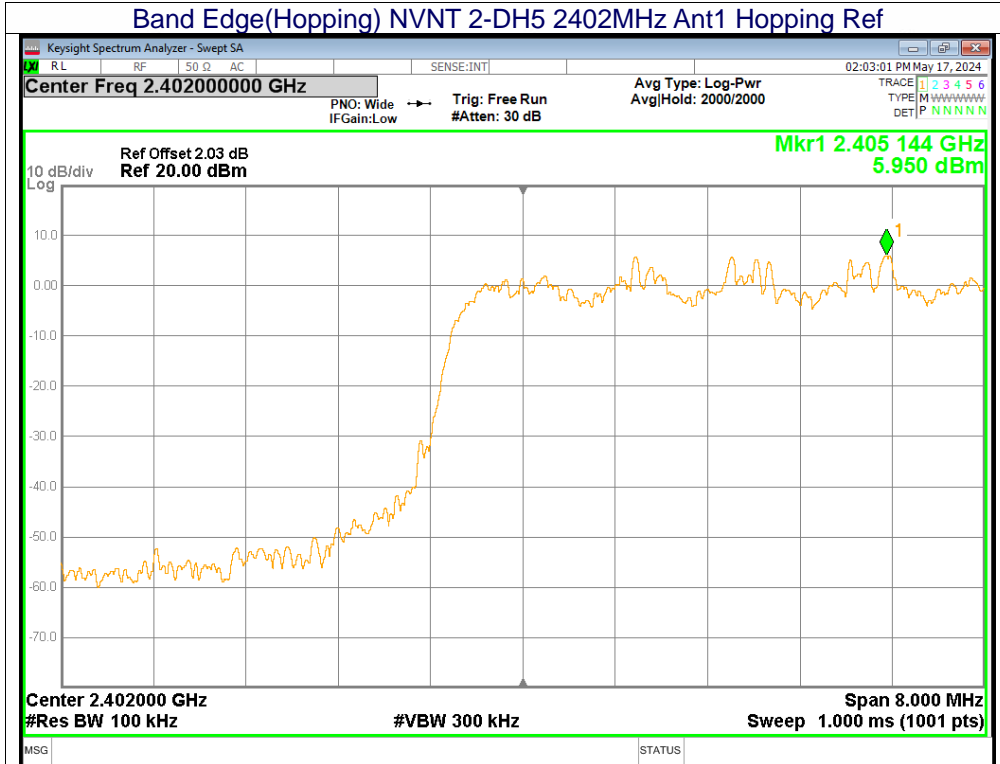

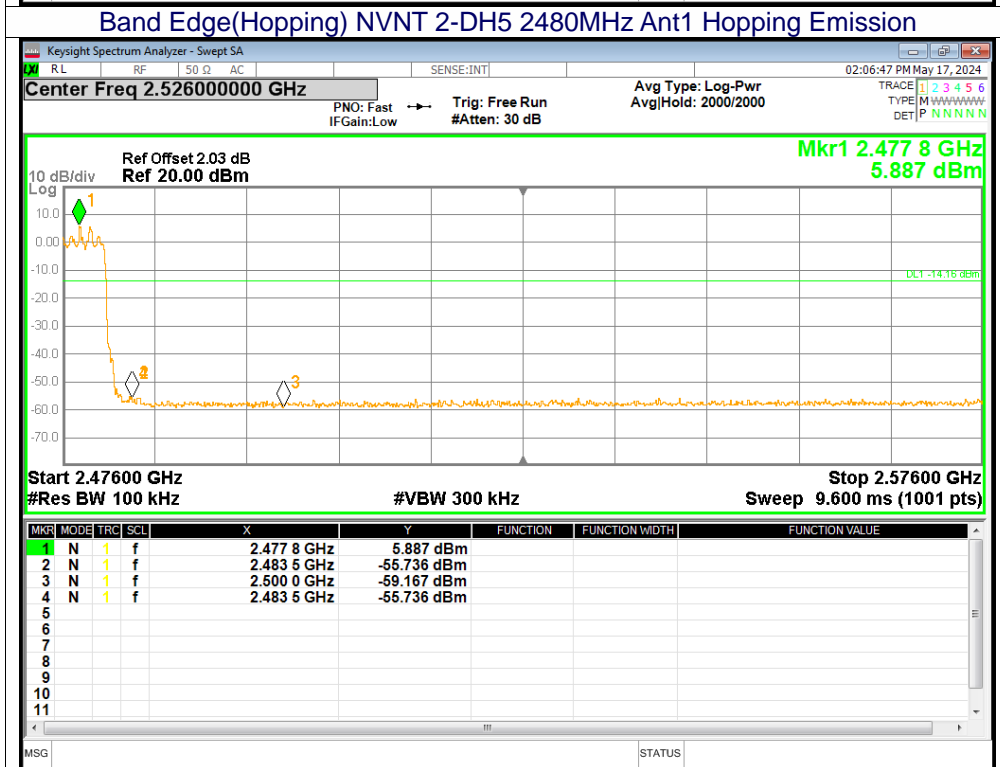
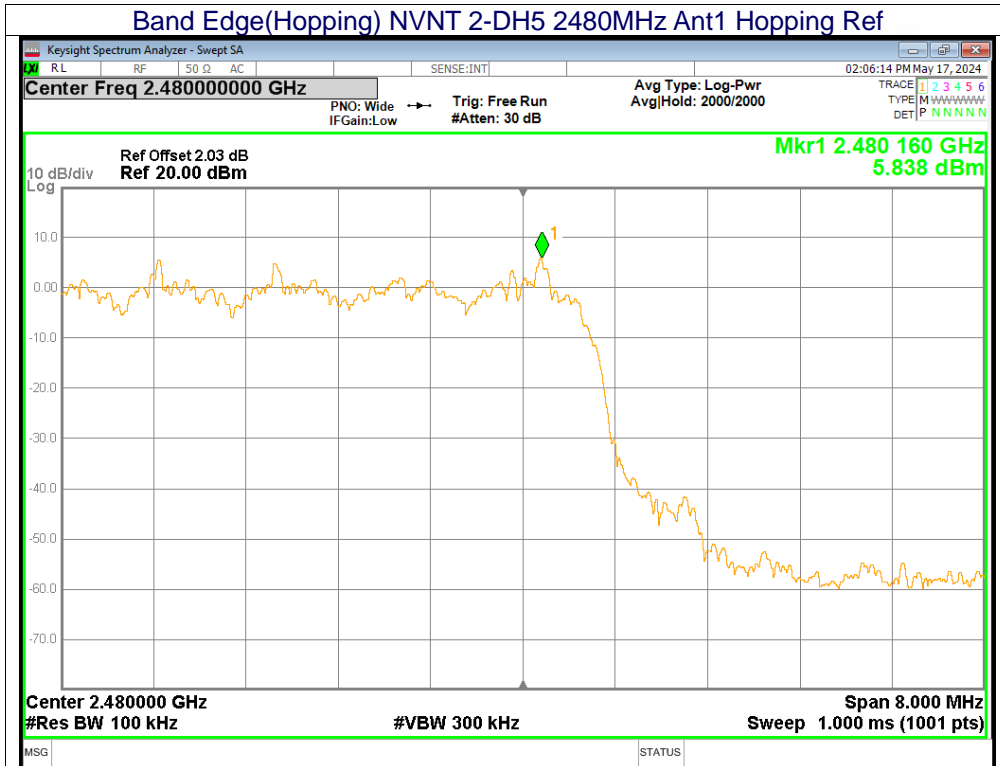

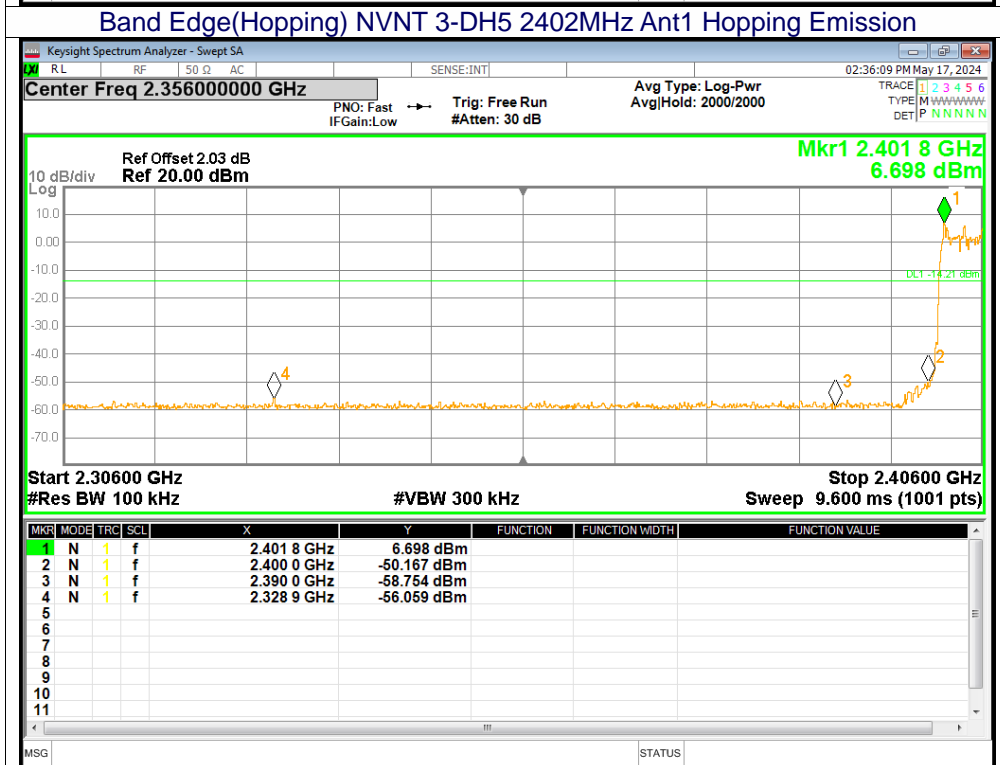
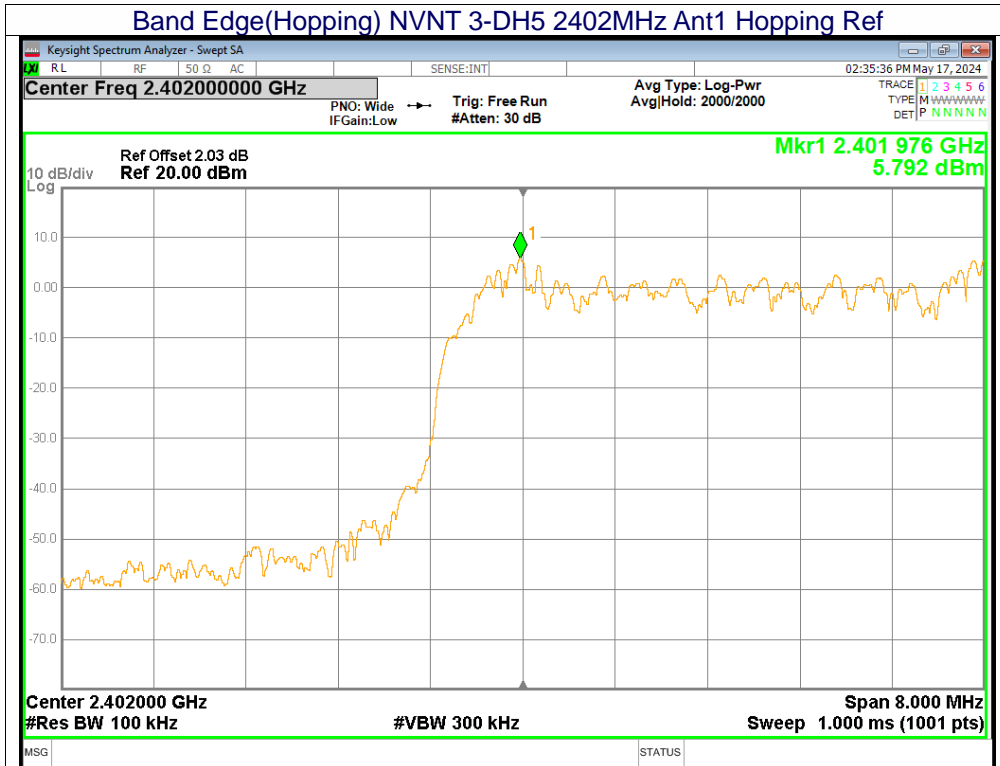

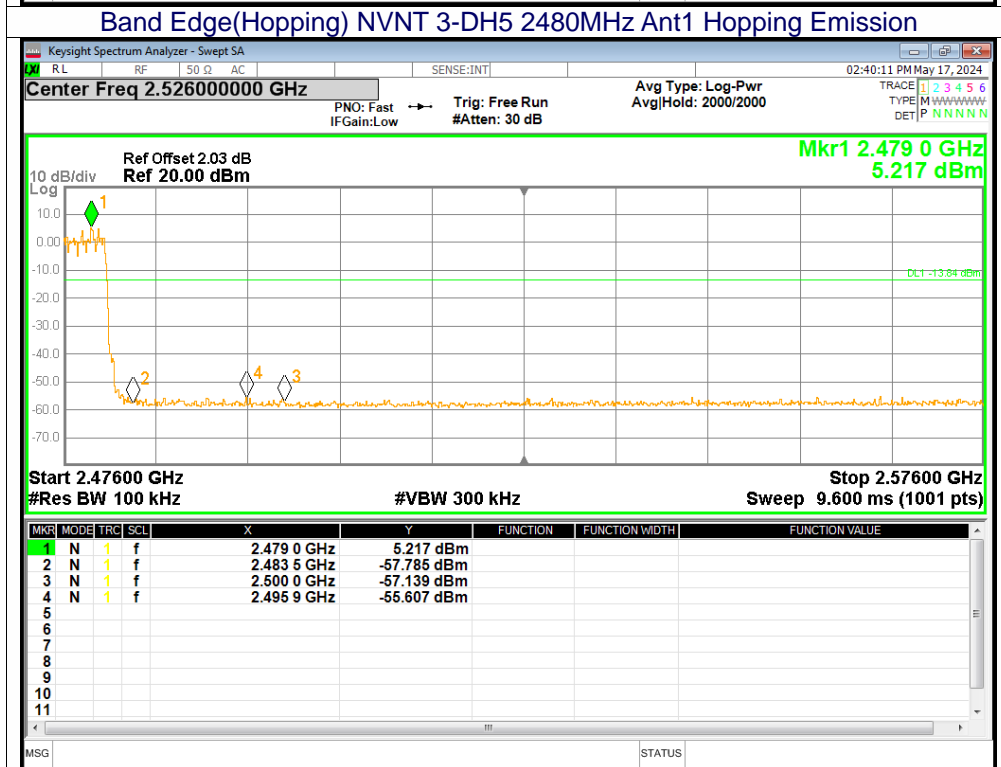
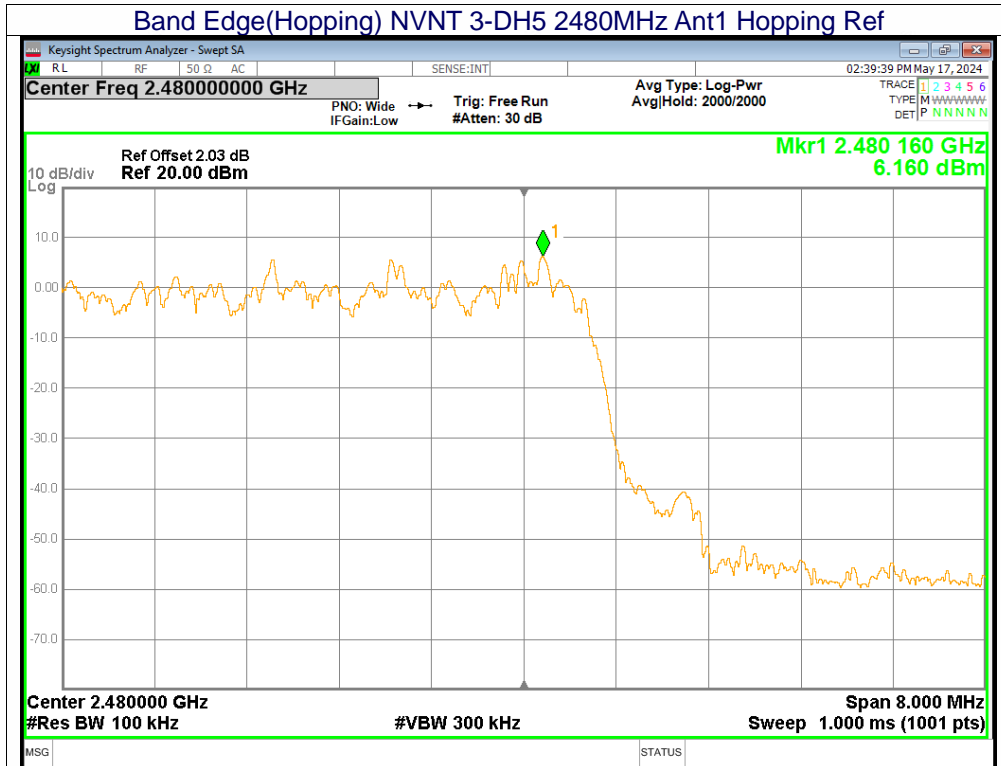



Conducted RF Spurious Emission

Condition	Mode	Frequency (MHz)	Antenna	Max Value (dBc)	Limit (dBc)	Verdict
NVNT	1-DH5	2402	Ant1	-60.67	-20	Pass
NVNT	1-DH5	2441	Ant1	-60.53	-20	Pass
NVNT	1-DH5	2480	Ant1	-60.35	-20	Pass
NVNT	2-DH5	2402	Ant1	-60.84	-20	Pass
NVNT	2-DH5	2441	Ant1	-60.74	-20	Pass
NVNT	2-DH5	2480	Ant1	-60.47	-20	Pass
NVNT	3-DH5	2402	Ant1	-60.46	-20	Pass
NVNT	3-DH5	2441	Ant1	-61.39	-20	Pass
NVNT	3-DH5	2480	Ant1	-61.1	-20	Pass

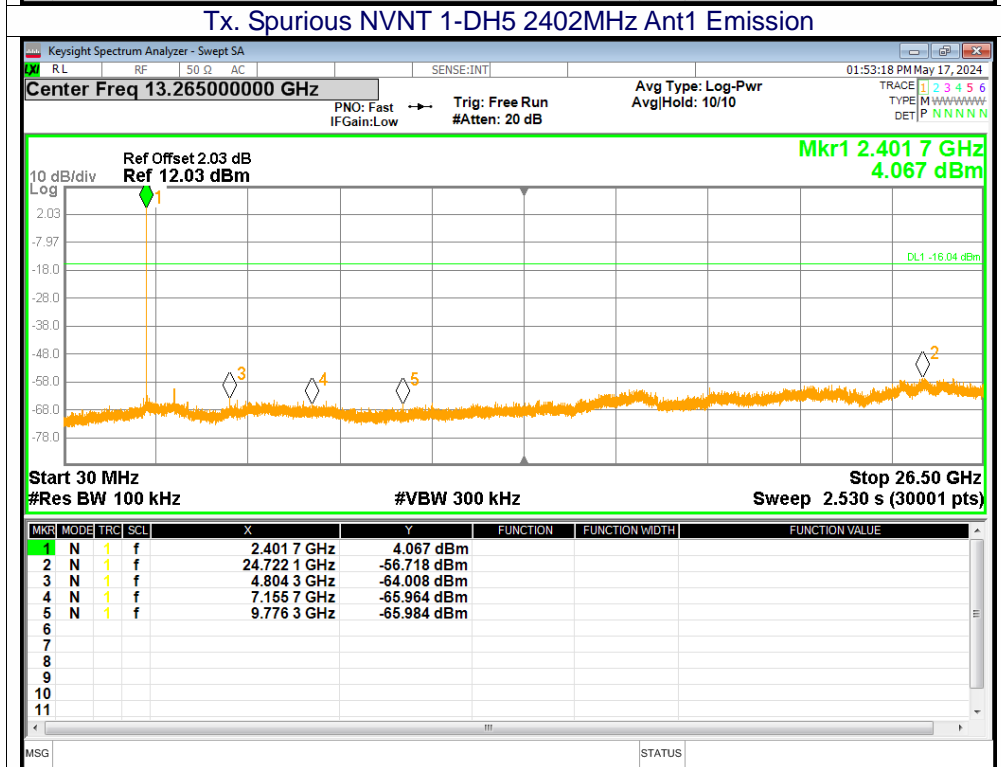
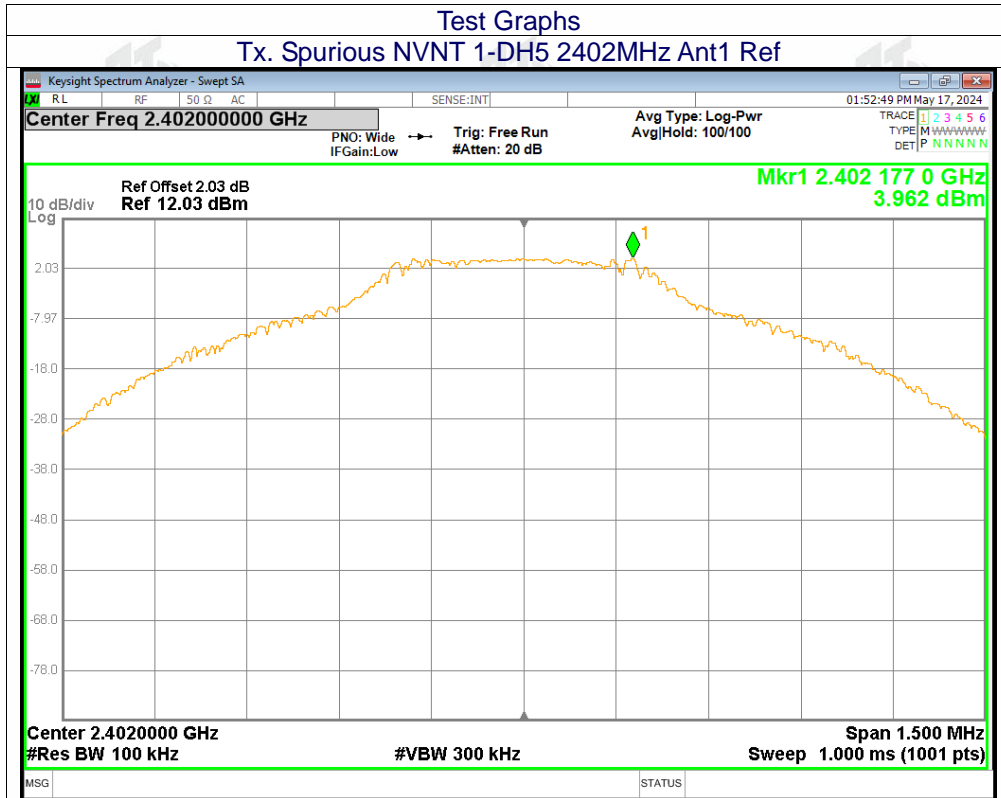

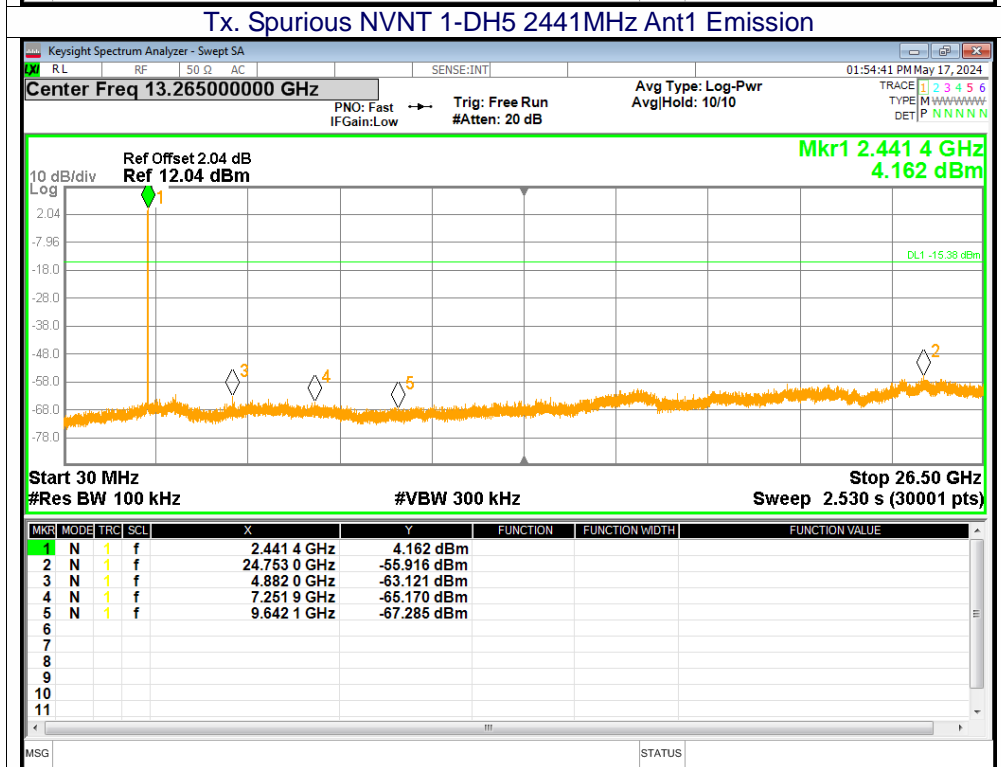
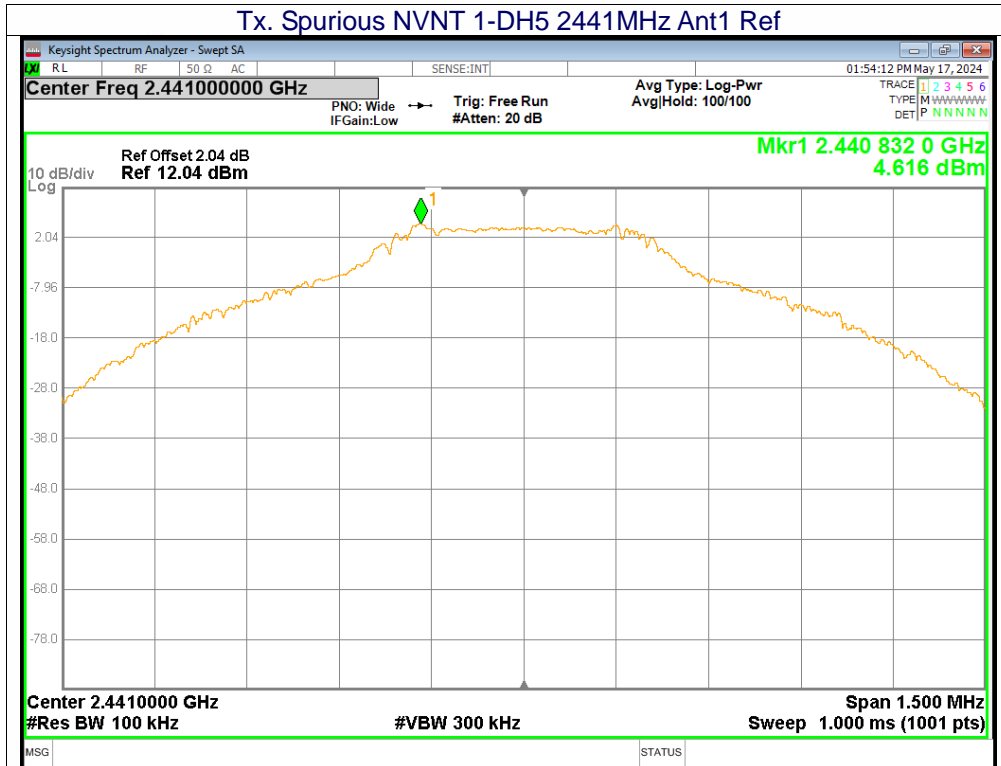

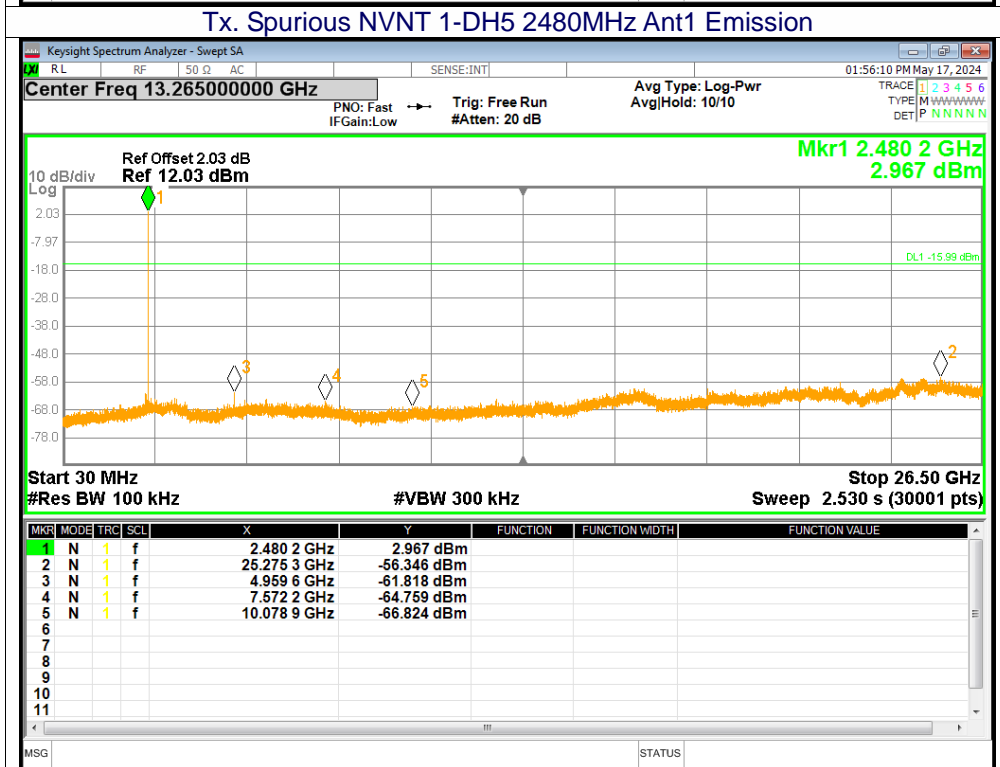
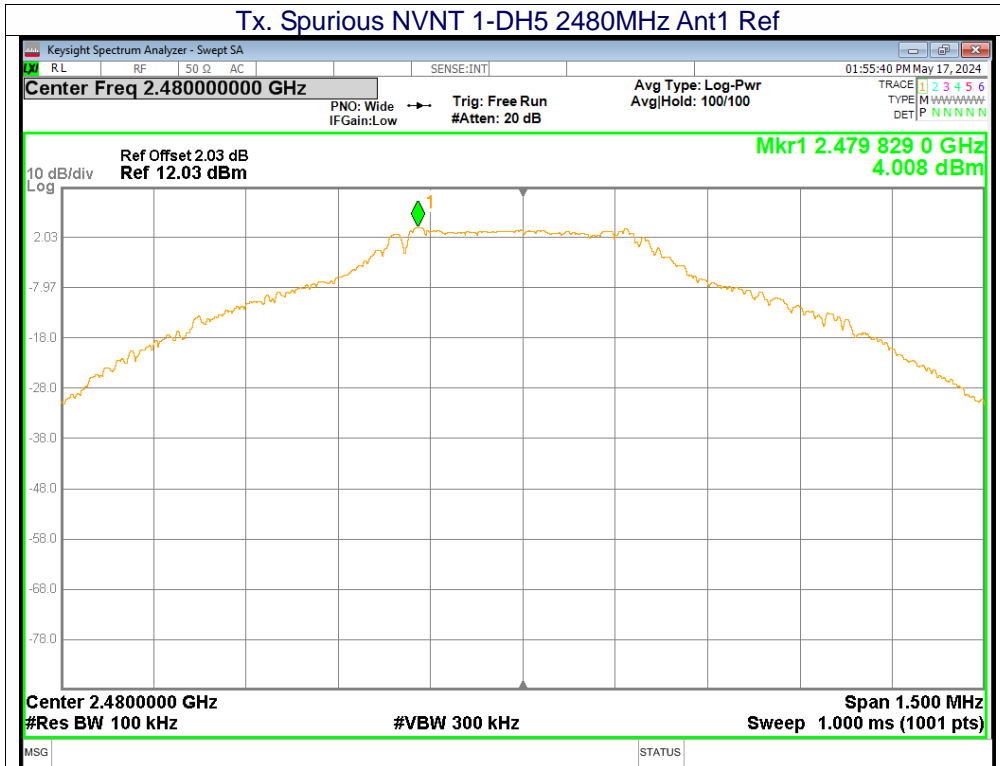

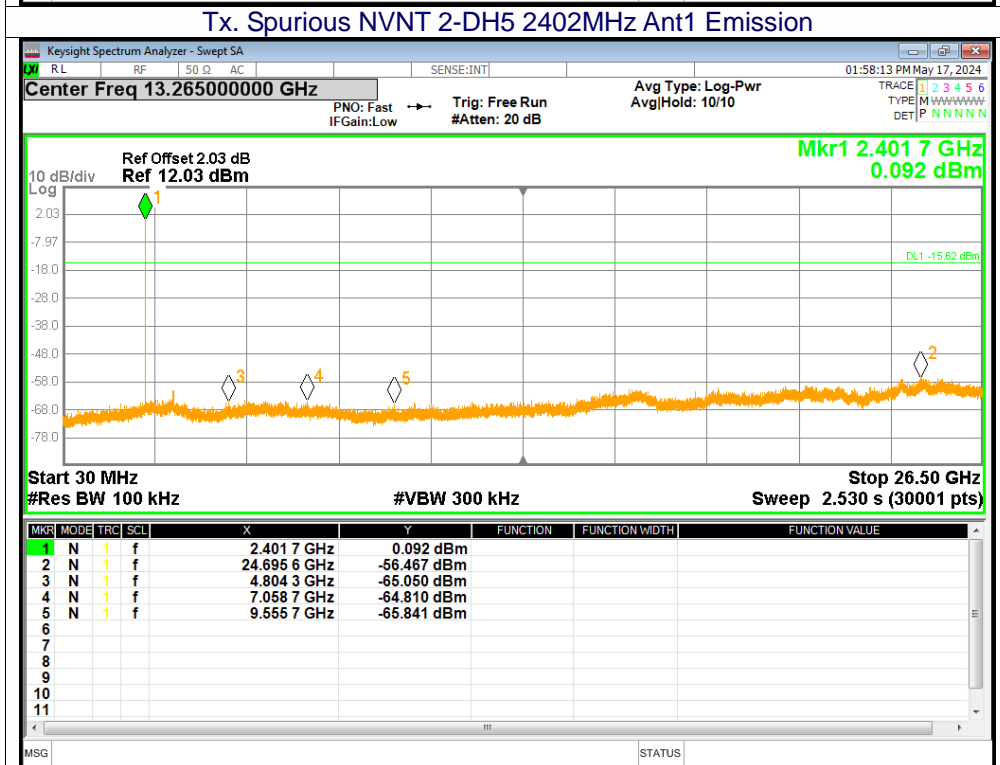
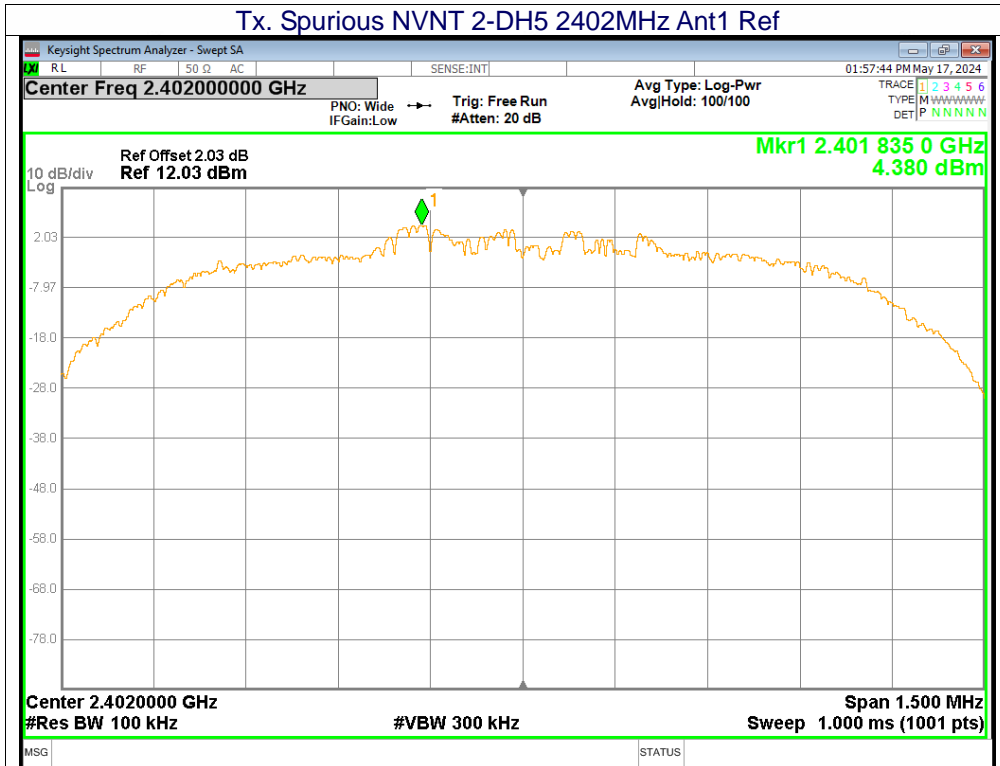

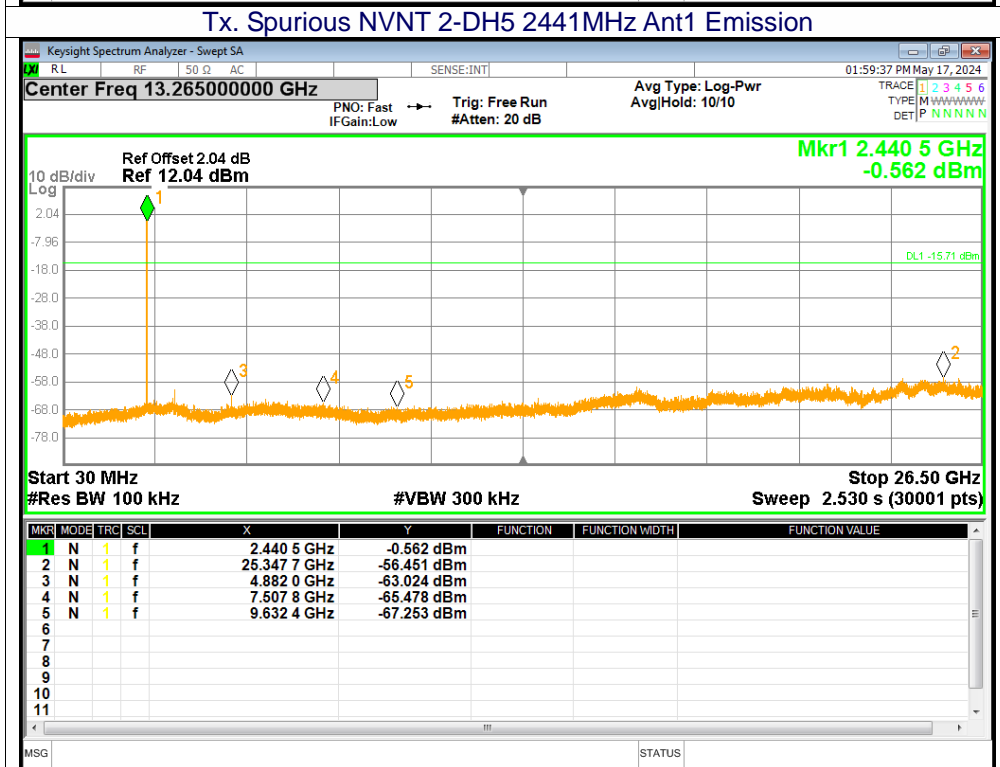
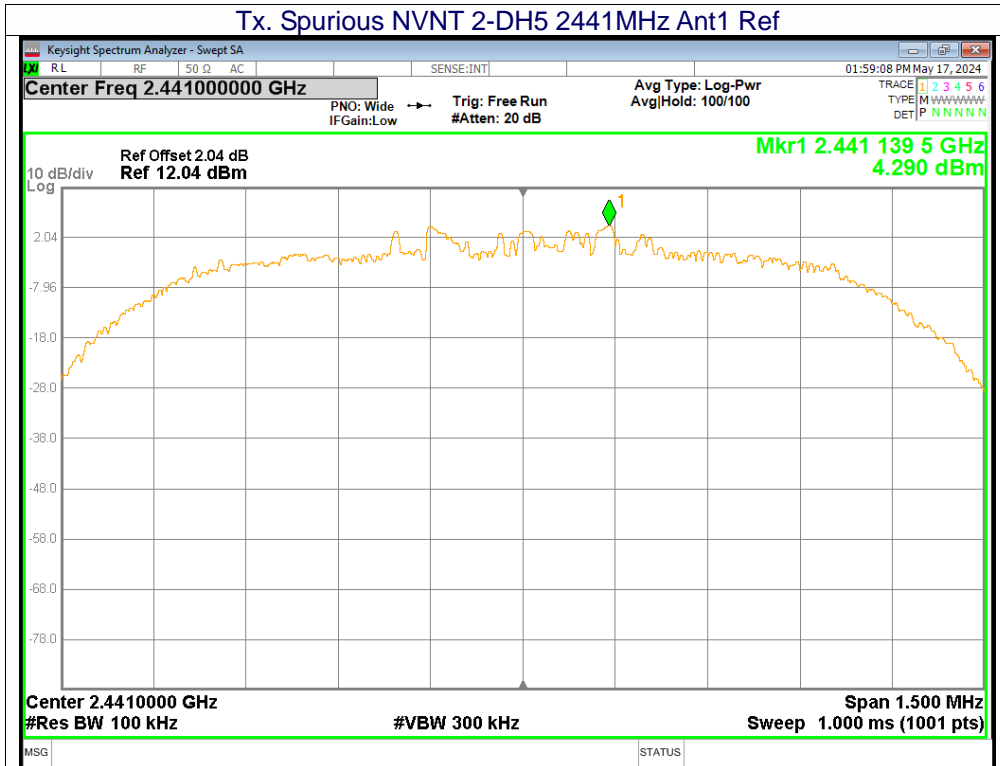

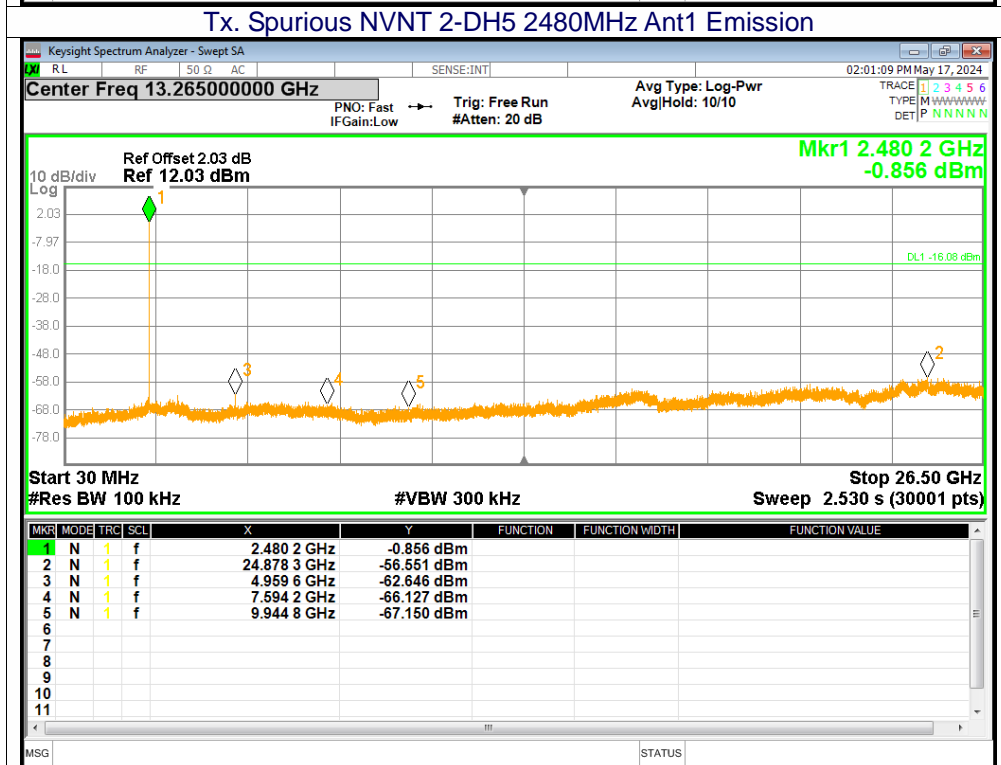
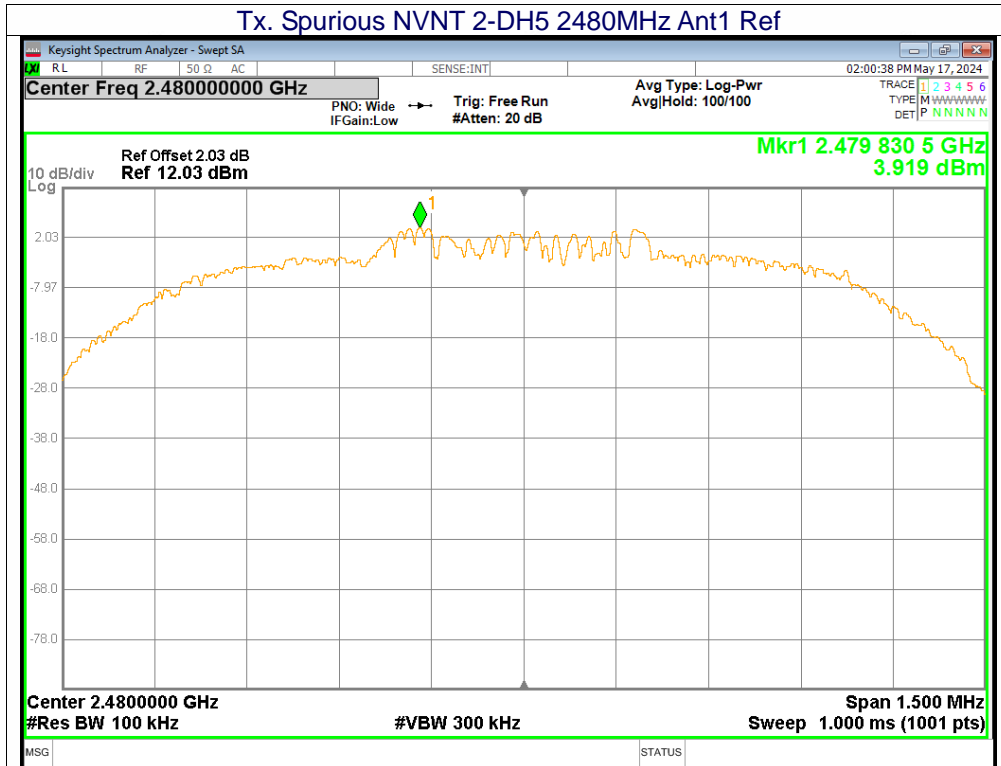

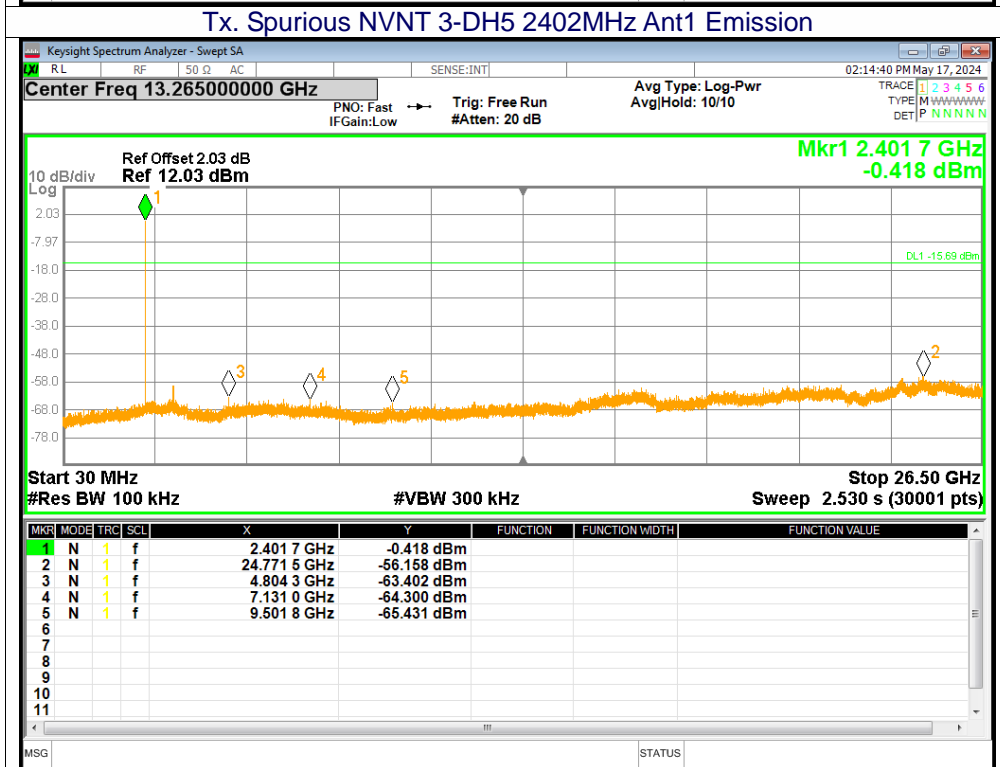
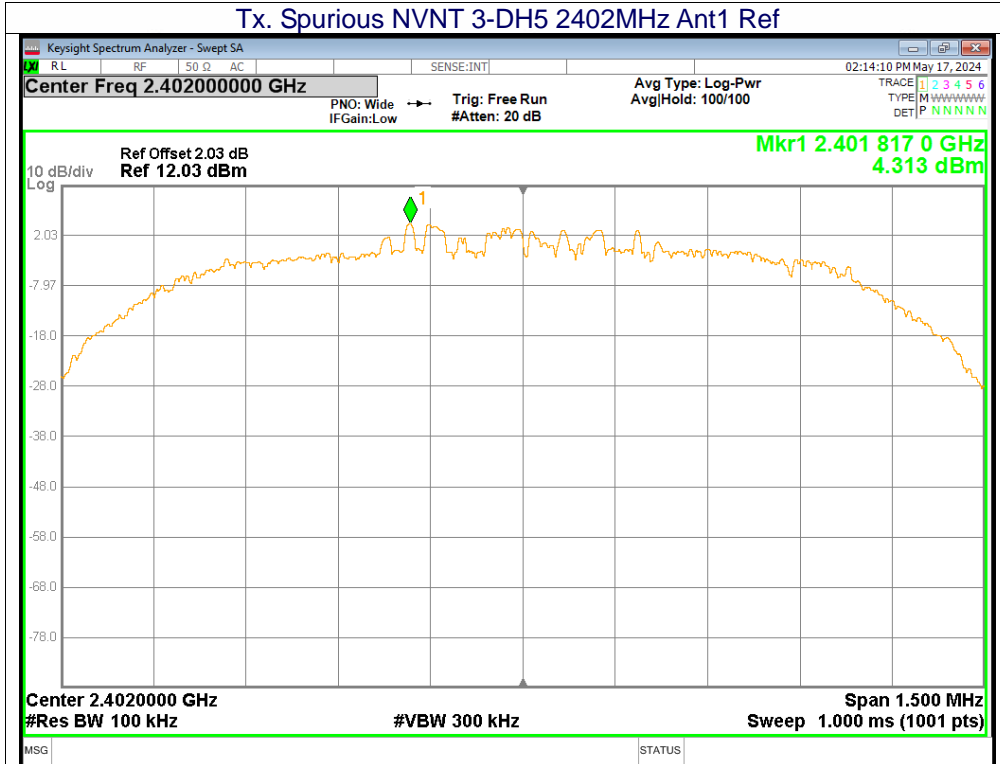

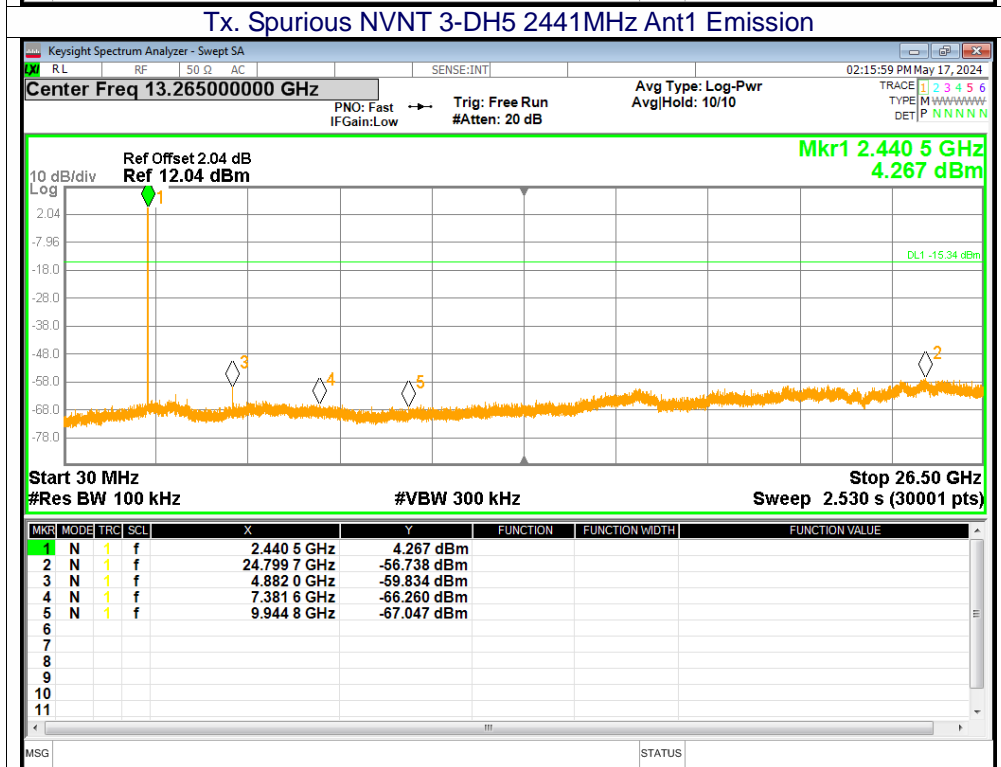
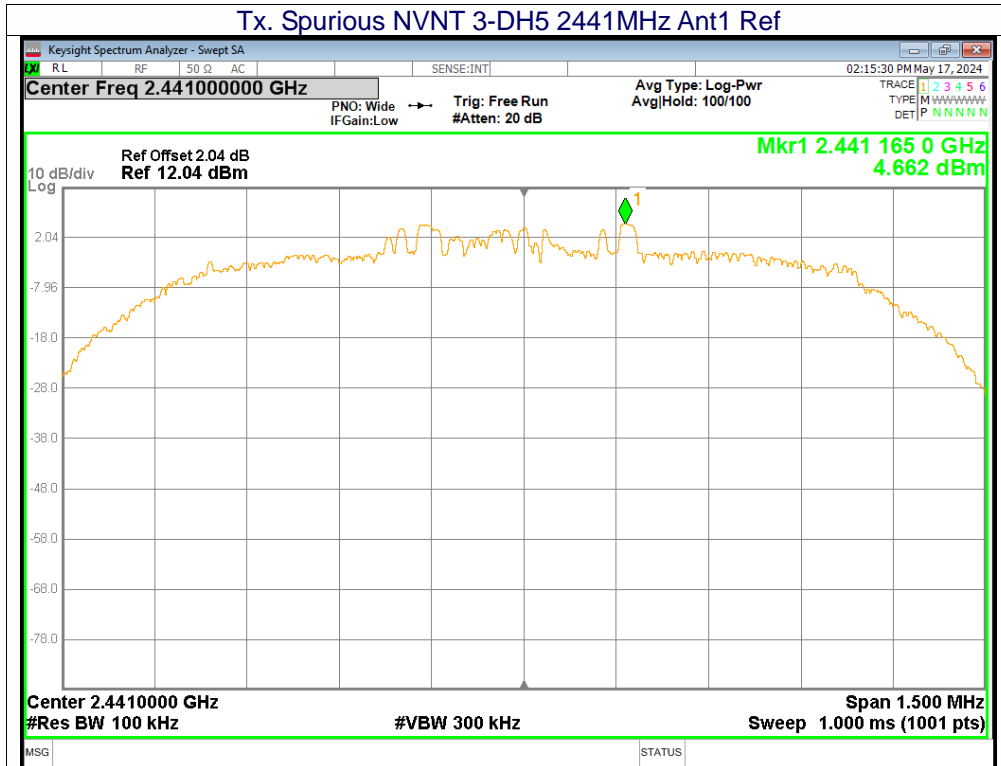

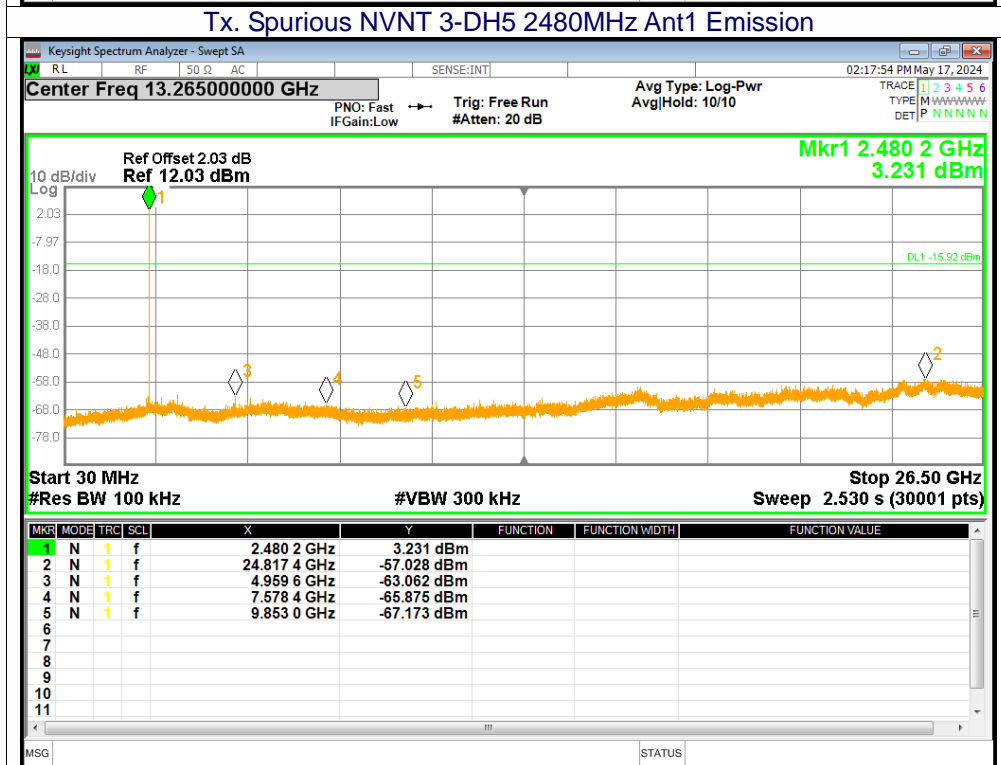
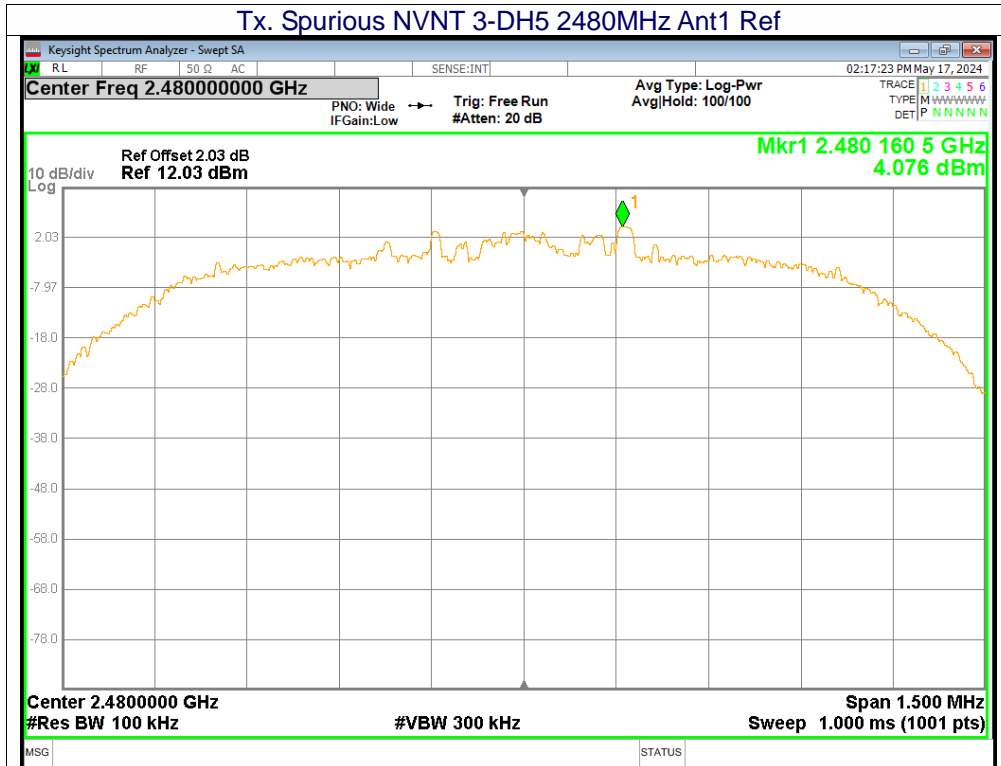



7. 20DB&99% BANDWIDTH

Test Requirement:	FCC Part15 C Section 15.247 (a)(1), RSS 247 5.1, RSS-Gen 6.7
Test Method:	ANSI C63.10:2013

7.1 Test Setup

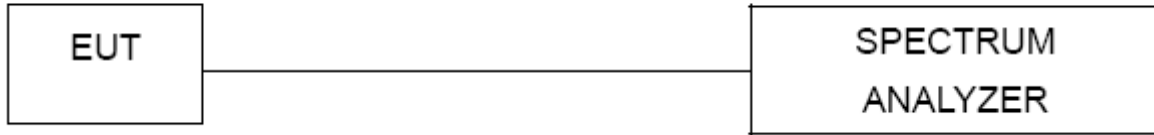

7.2 Limit

According to RSS-247§5.1(a)& §5.1(b), Frequency hopping systems shall have hopping channel carrier frequencies separated by a minimum of 25 kHz or the 20 dB bandwidth of the hopping channel, whichever is greater. Alternatively, frequency hopping systems operating in the 2400-2483.5 MHz band may have hopping channel carrier frequencies that are separated by 25 kHz or two-thirds of the 20 dB bandwidth of the hopping channel, whichever is greater, provided the systems operate with an output power no greater than 125 mW. The system shall hop to channel frequencies that are selected at the system hopping rate from a pseudo randomly ordered list of hopping frequencies. Each frequency must be used equally on the average by each transmitter. The system receivers shall have input bandwidths that match the hopping channel bandwidths of their corresponding transmitters and shall shift frequencies in synchronization with the transmitted signals.

7.3 Test procedure

1. Set RBW = 30 kHz.
2. Set the video bandwidth (VBW) ≥ 3 x RBW.
3. Detector = Peak.
4. Trace mode = max hold.
5. Sweep = auto couple.
6. Allow the trace to stabilize.
7. Measure the maximum width of the emission that is constrained by the frequencies associated with the two outermost amplitude points (upper and lower frequencies) that are attenuated by 6 dB relative to the maximum level measured in the fundamental emission.
8. The transmitter output was connected to the spectrum analyzer through an attenuator. The bandwidth of the fundamental frequency was measured by spectrum analyzer with 30KHz RBW and 100 KHz VBW record the 99% bandwidth.

7.4 DEVIATION FROM STANDARD

No deviation.

7.5 Test Result

Mode	Test channel	20dB Emission Bandwidth (MHz)	99%Bandwidth (MHz)	Result
GFSK	Lowest	0.957	0.88	Pass
	Middle	0.956	0.865	
	Highest	0.956	0.868	
π/4DQPSK	Lowest	1.224	1.153	Pass
	Middle	1.268	1.162	
	Highest	1.272	1.15	
8DPSK	Lowest	1.279	1.159	Pass
	Middle	1.216	1.16	
	Highest	1.218	1.163	

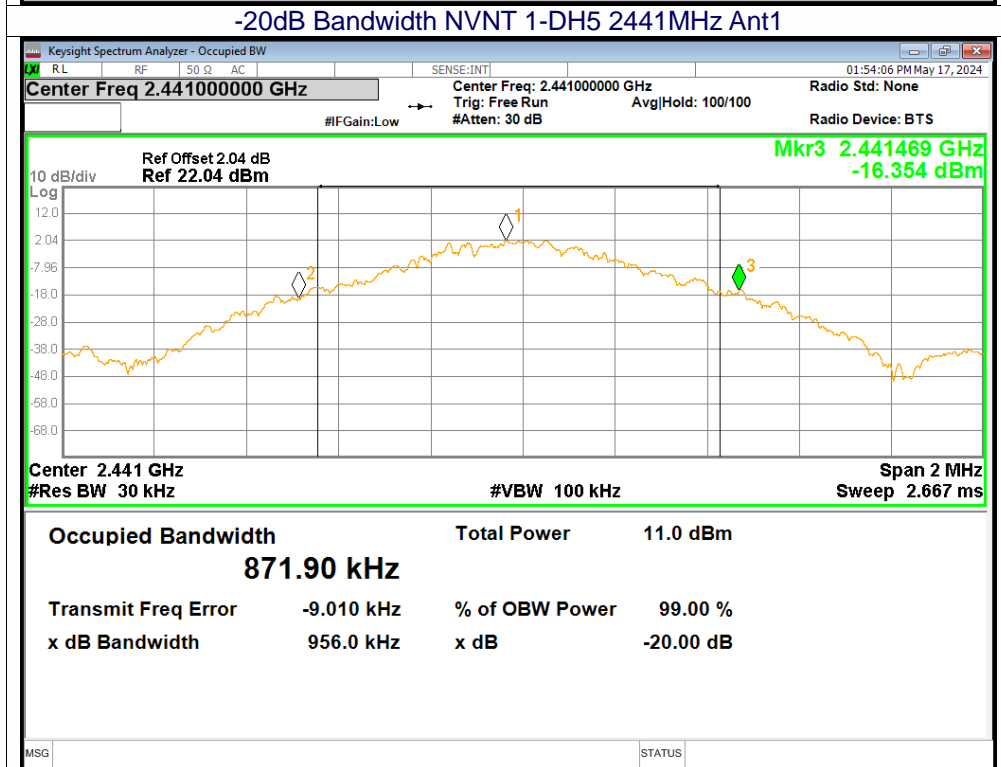
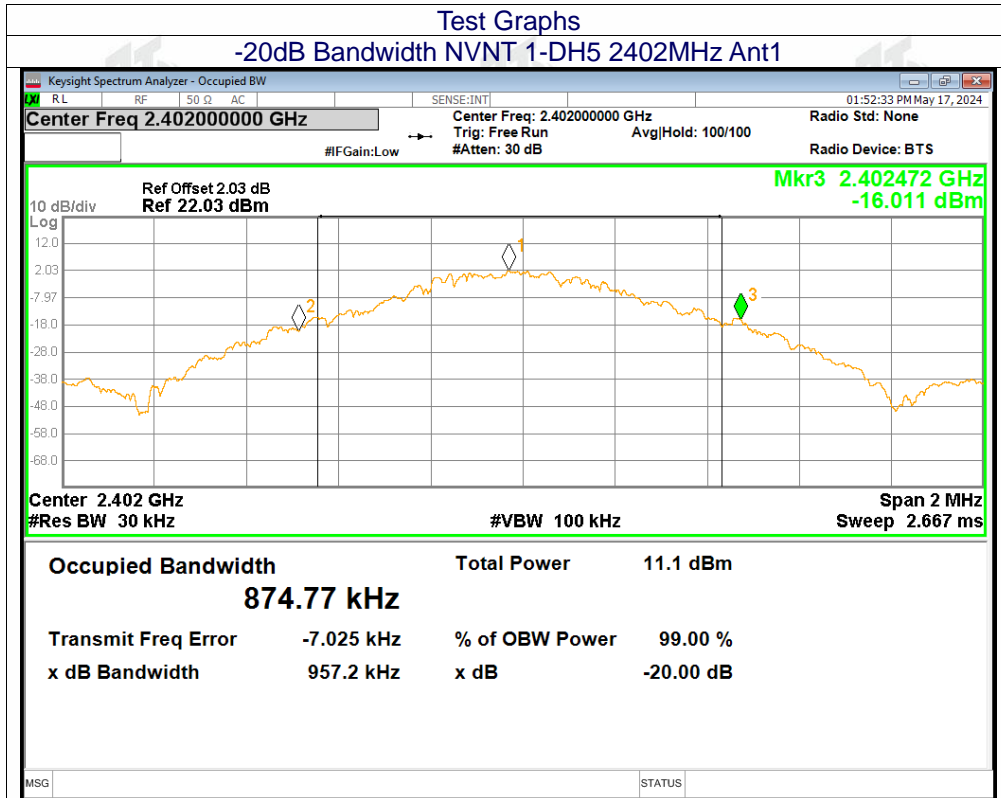

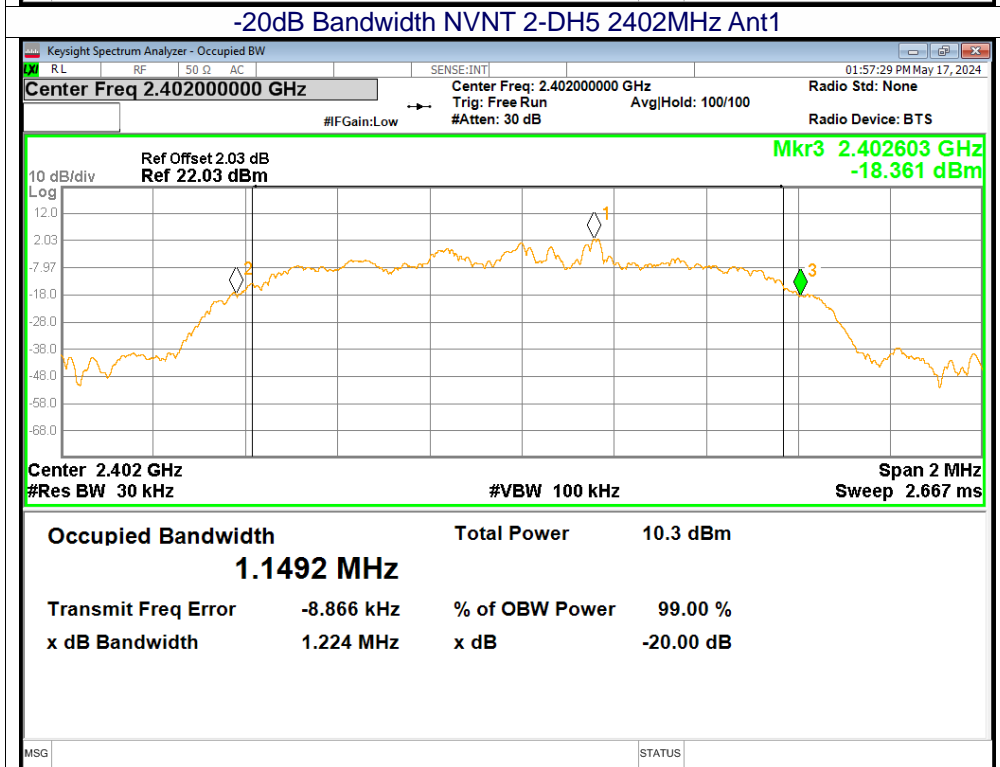
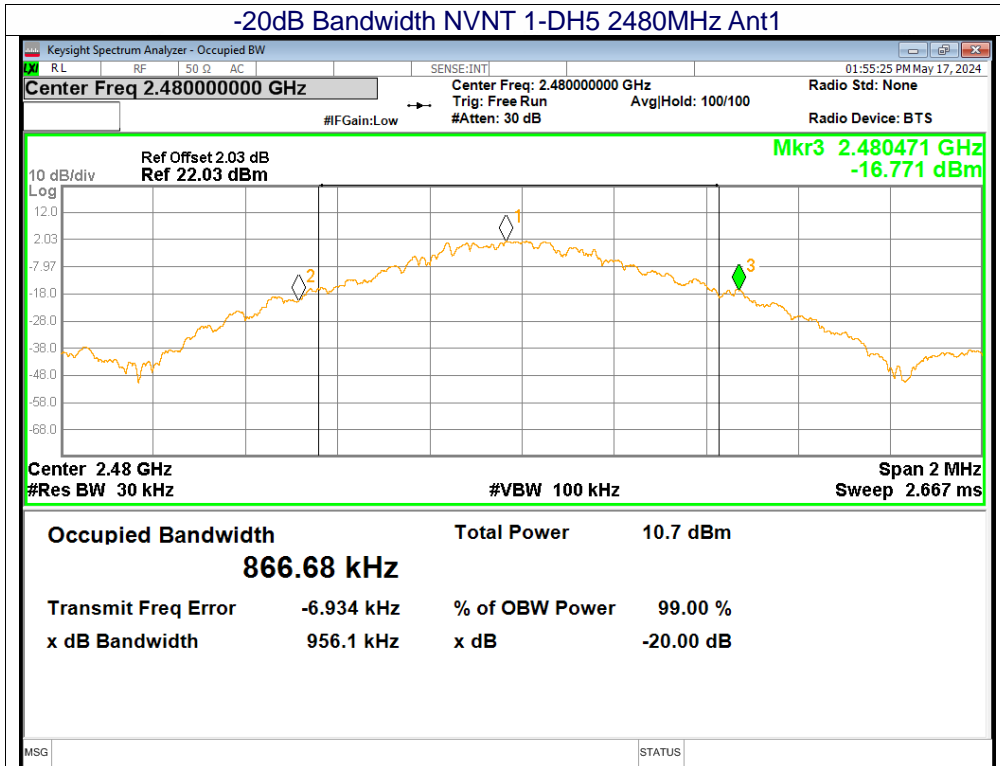

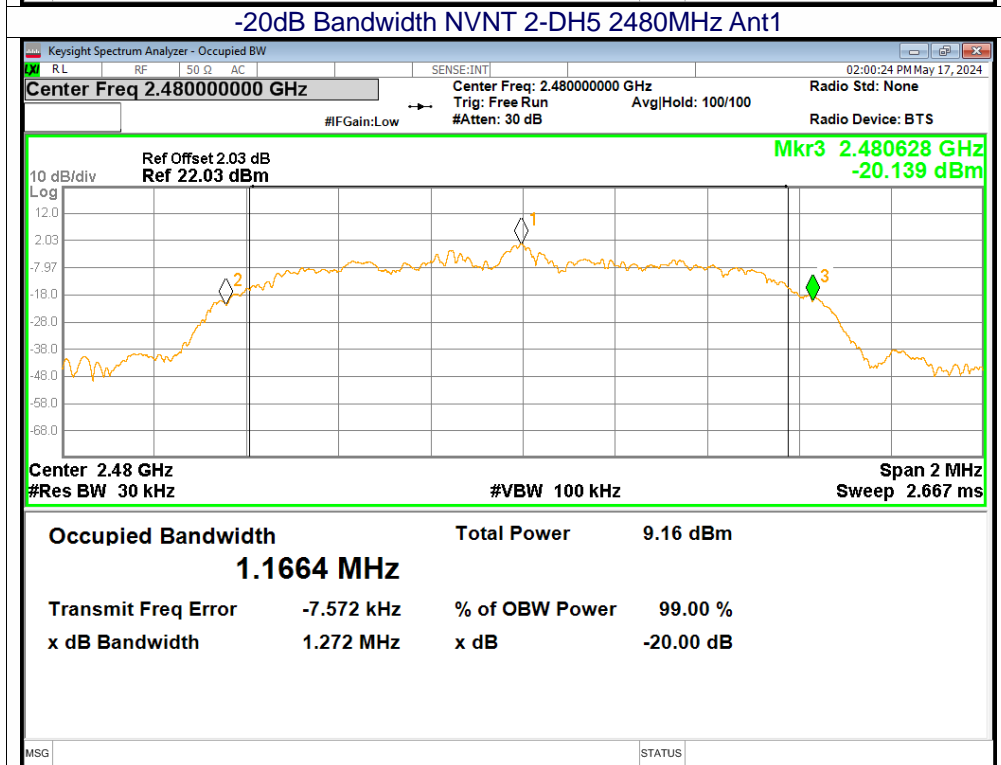
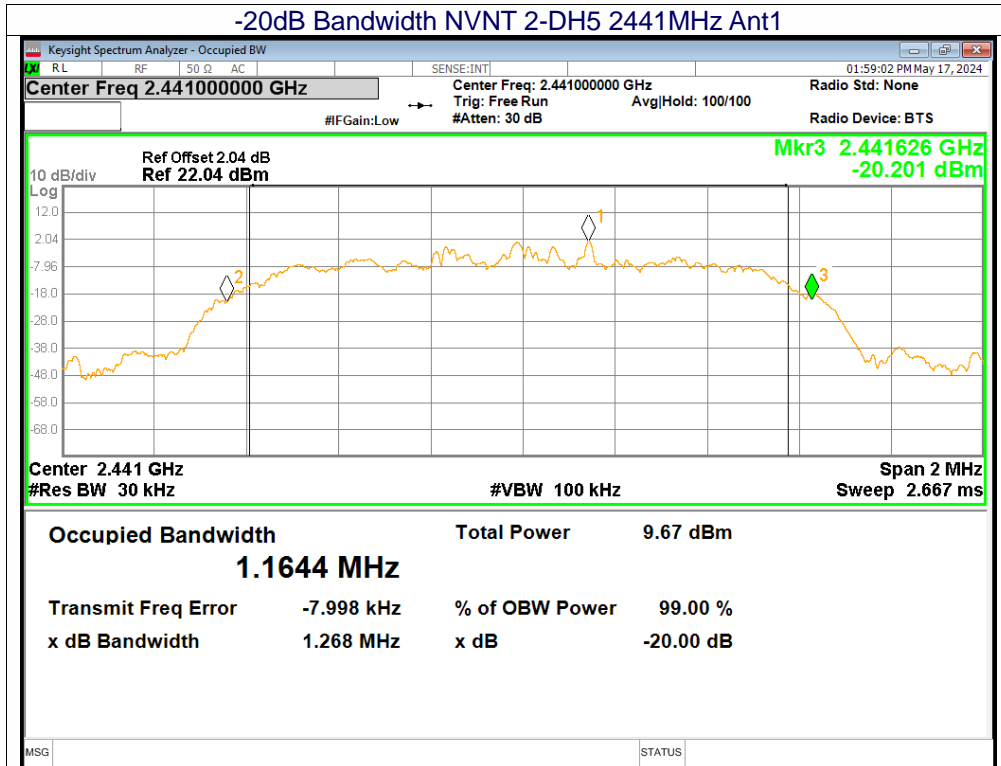

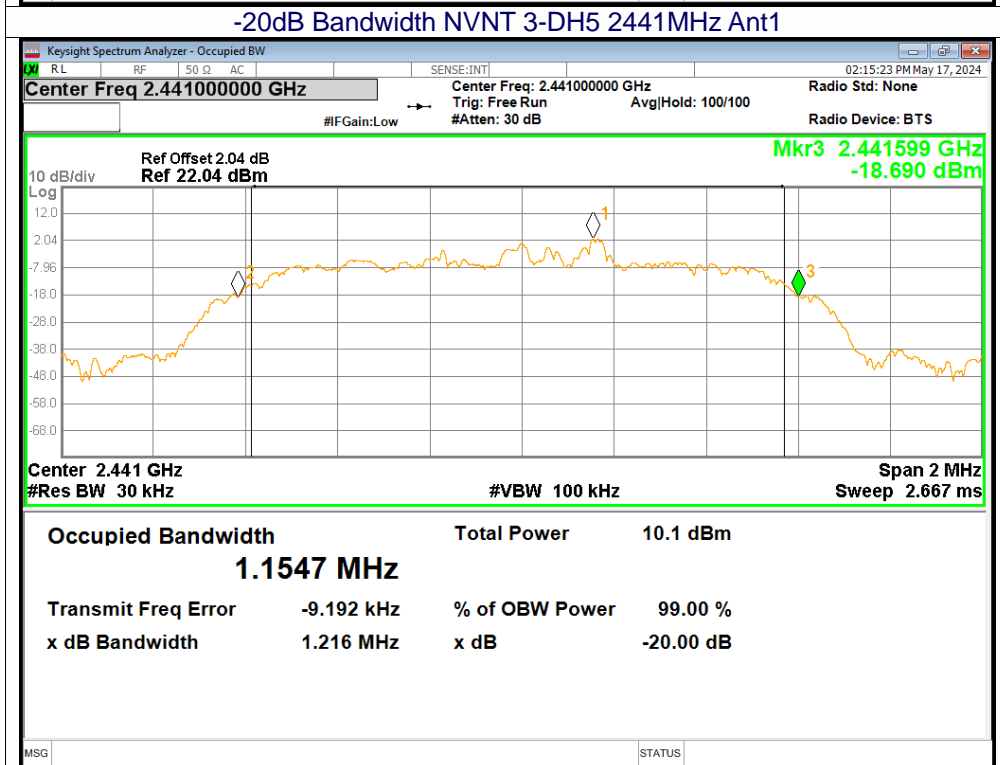
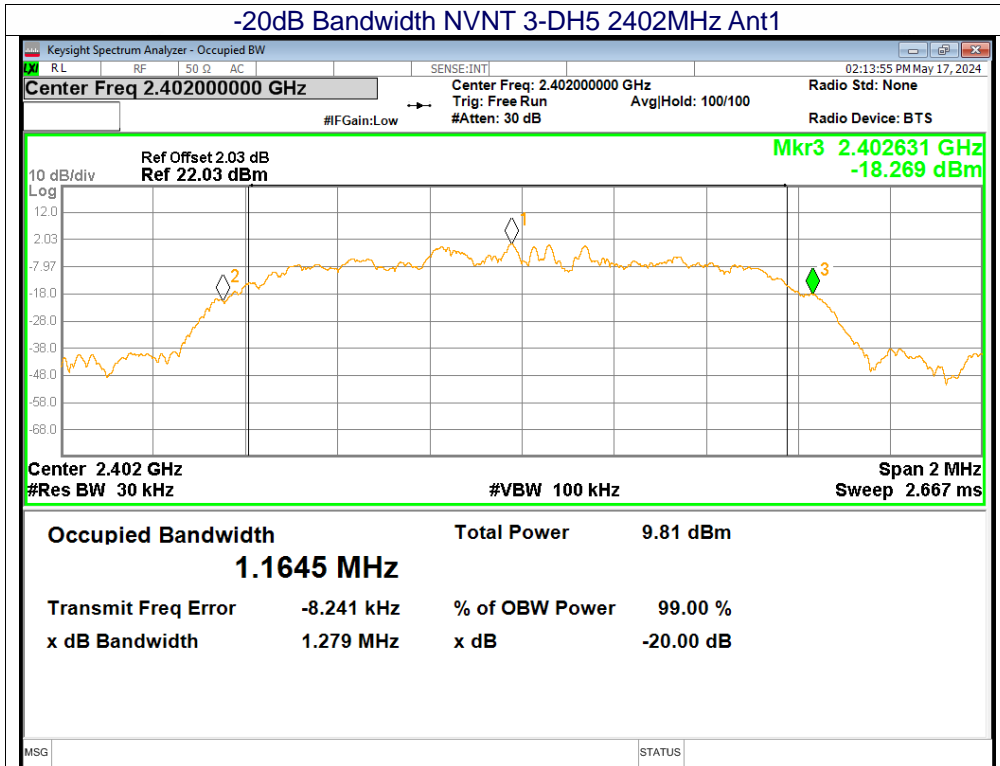

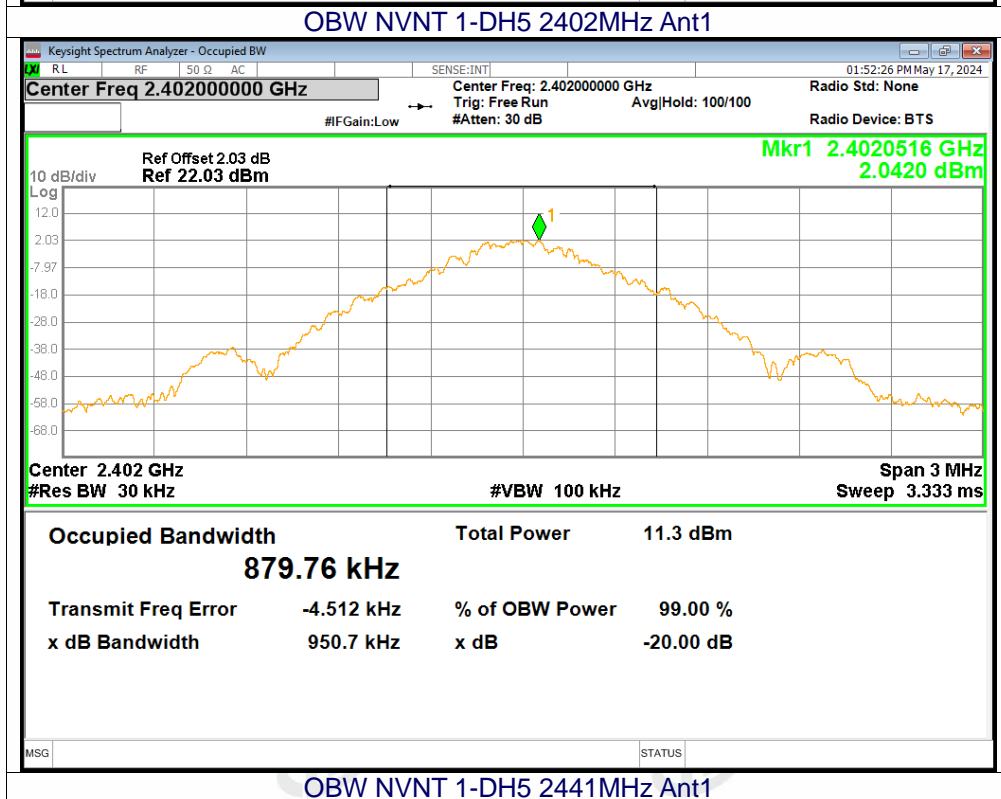
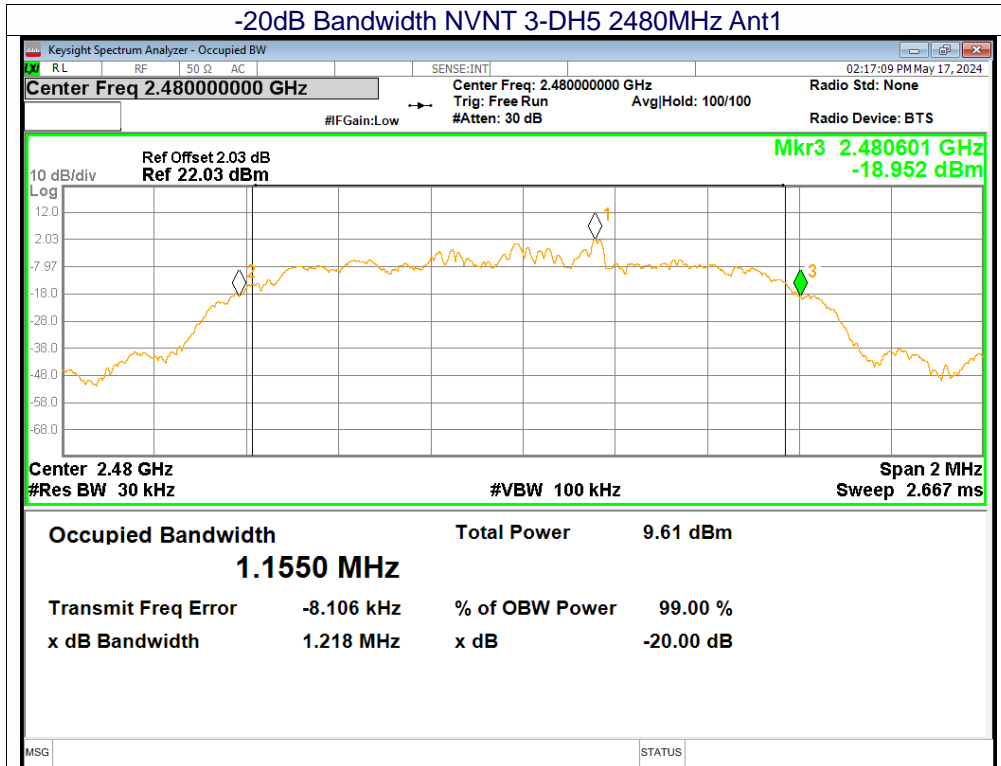

OBW NVNT 1-DH5 2441MHz Ant1

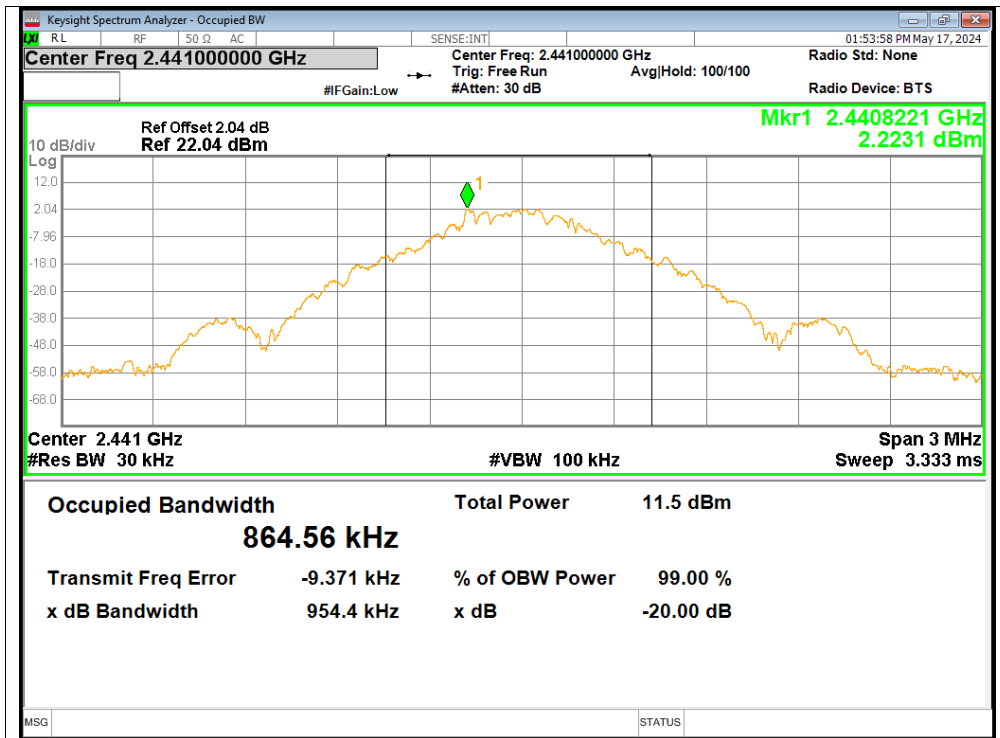

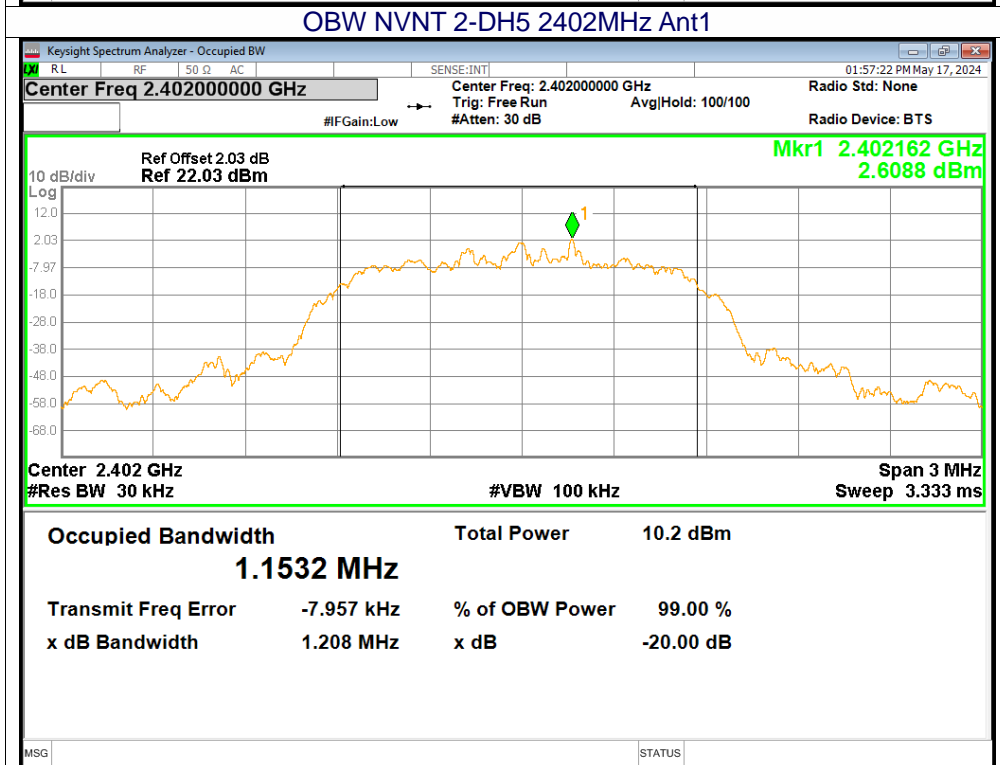
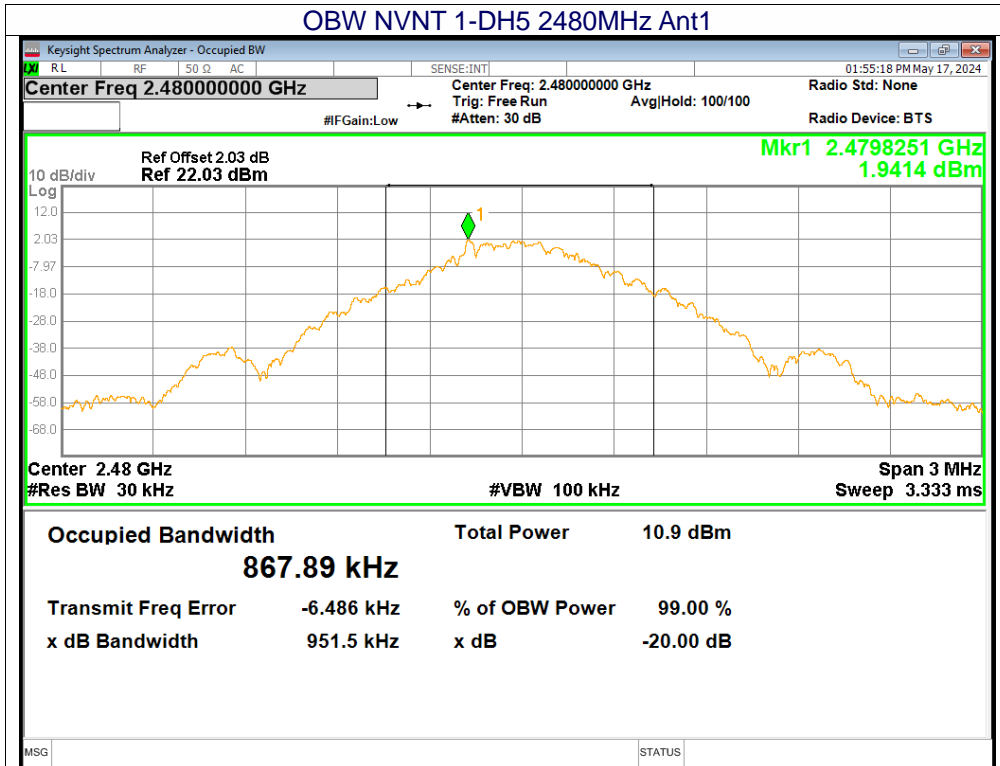

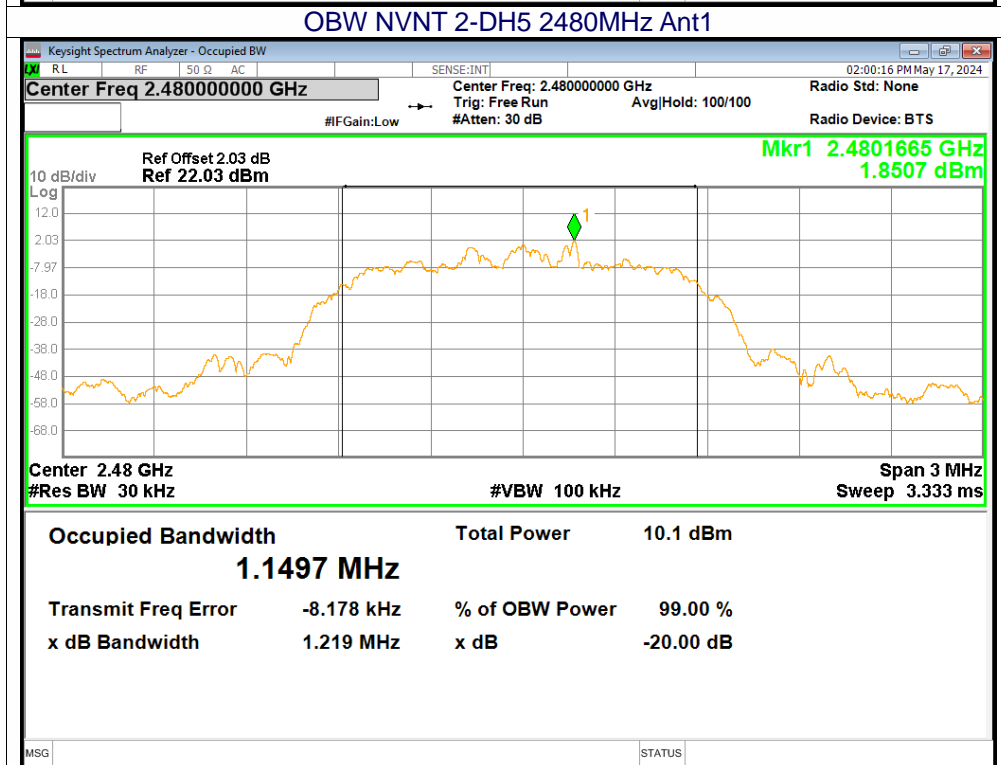
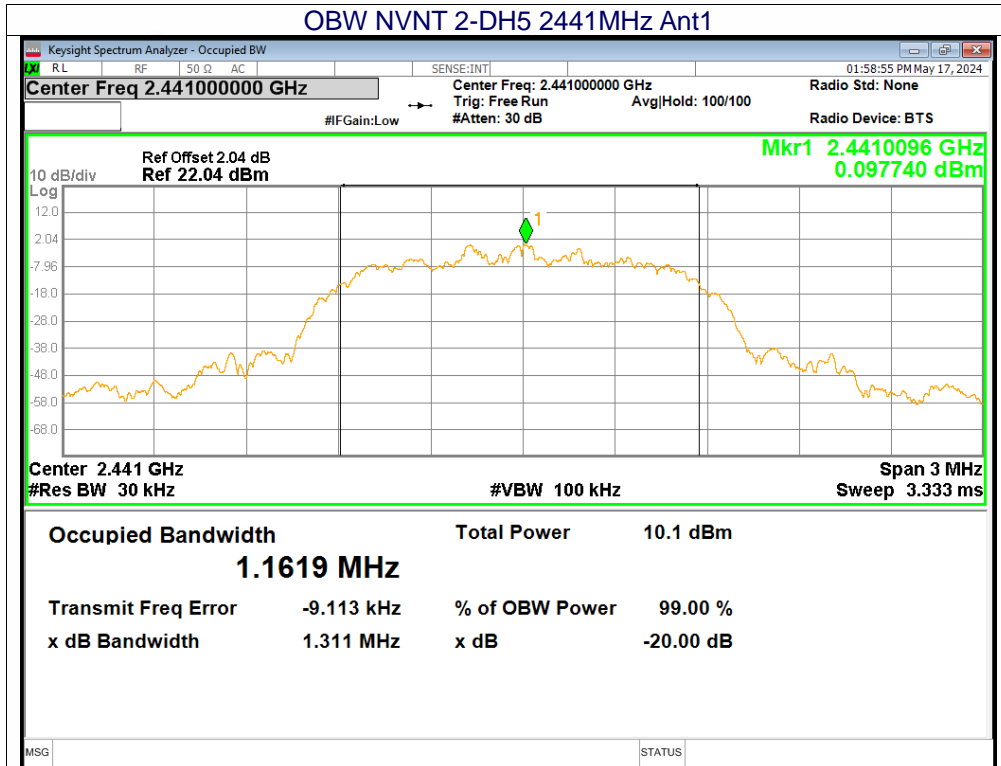

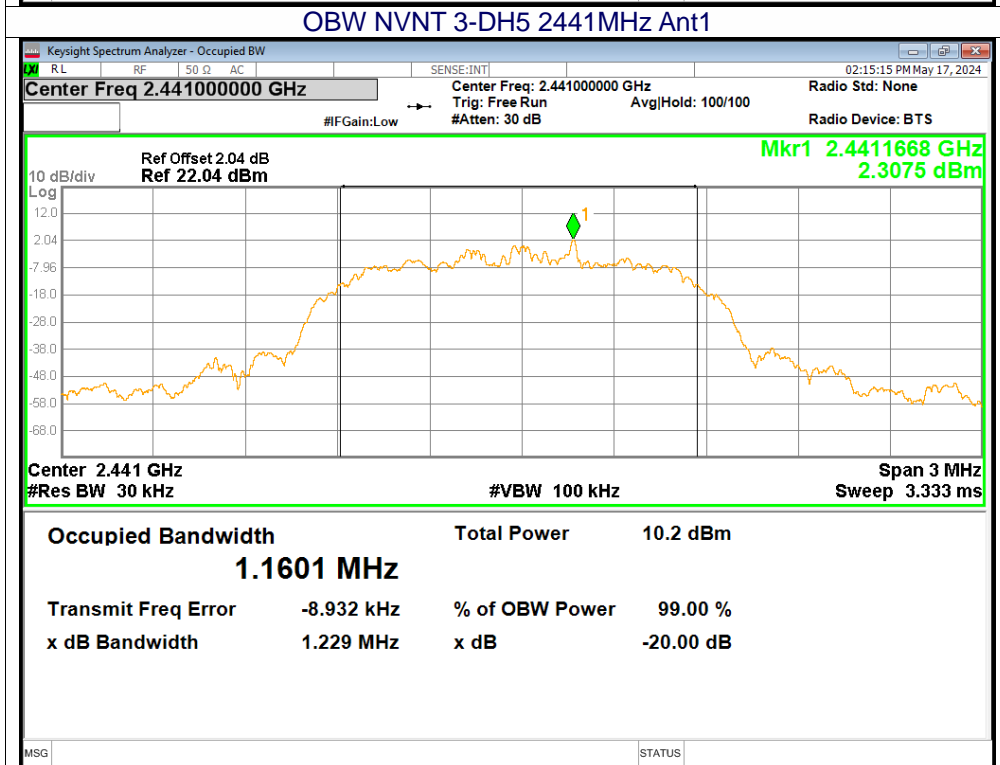
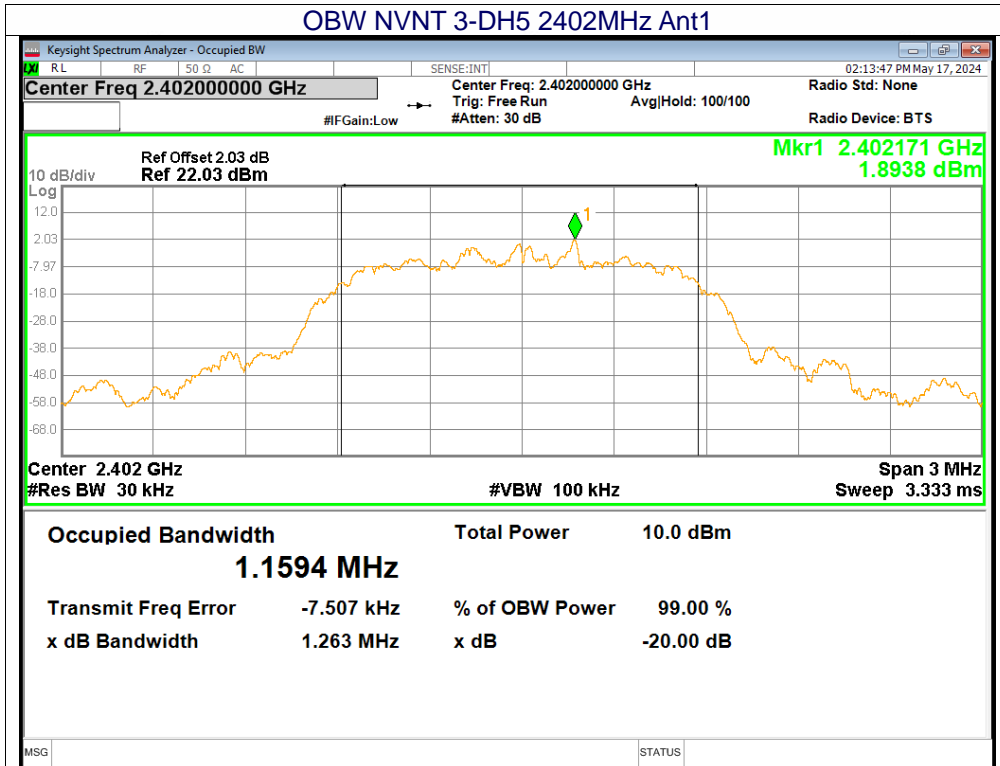

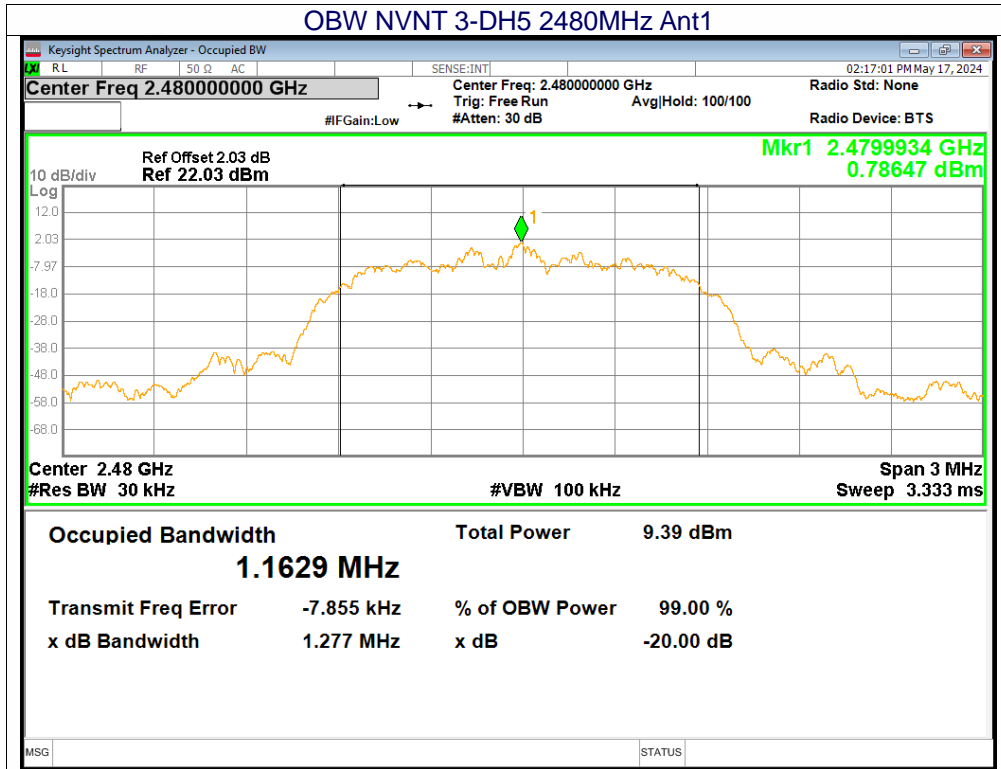

8. Maximum Peak Output Power

Test Requirement:	FCC Part15 C Section 15.247 (b)(1), RSS 247 5.4 (b)
Test Method:	ANSI C63.10:2013

8.1 Block Diagram Of Test Setup

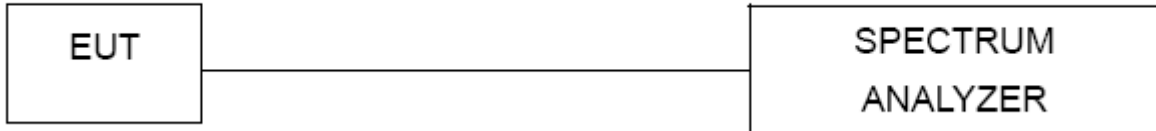

8.2 Limit

For frequency hopping systems operating in the 2400-2483.5 MHz band employing at least 75 non-overlapping hopping channels, and all frequency hopping systems in the 5725-5850 MHz band: 1 watt. For all other frequency hopping systems in the 2400-2483.5 MHz band: 0.125 watts.

For FHSs operating in the band 2400-2483.5 MHz, the maximum peak conducted output power shall not exceed 1.0 W if the hopset uses 75 or more hopping channels; the maximum peak conducted output power shall not exceed 0.125 W if the hopset uses less than 75 hopping channels. The e.i.r.p. shall not exceed 4 W.

8.3 Test procedure

1. Remove the antenna from the EUT and then connect a low RF cable from the antenna port to the spectrum.
2. Set the spectrum analyzer: RBW = 2MHz. VBW =6MHz. Sweep = auto; Detector Function = Peak.
3. Keep the EUT in transmitting at lowest, medium and highest channel individually. Record the max value.

8.4 DEVIATION FROM STANDARD

No deviation.

8.5 Test Result

Mode	Test channel	Peak Output Power (dBm)	Peak Output Power Limit (dBm)	E.I.R.P (dBm)	Result
GFSK	Lowest	4.78	30.00	36	Pass
	Middle	4.82			
	Highest	4.3			
π/4DQPSK	Lowest	4.78	30.00	36	Pass
	Middle	4.86			
	Highest	4.37			
8DPSK	Lowest	4.85	30.00	36	Pass
	Middle	4.88			
	Highest	4.31			

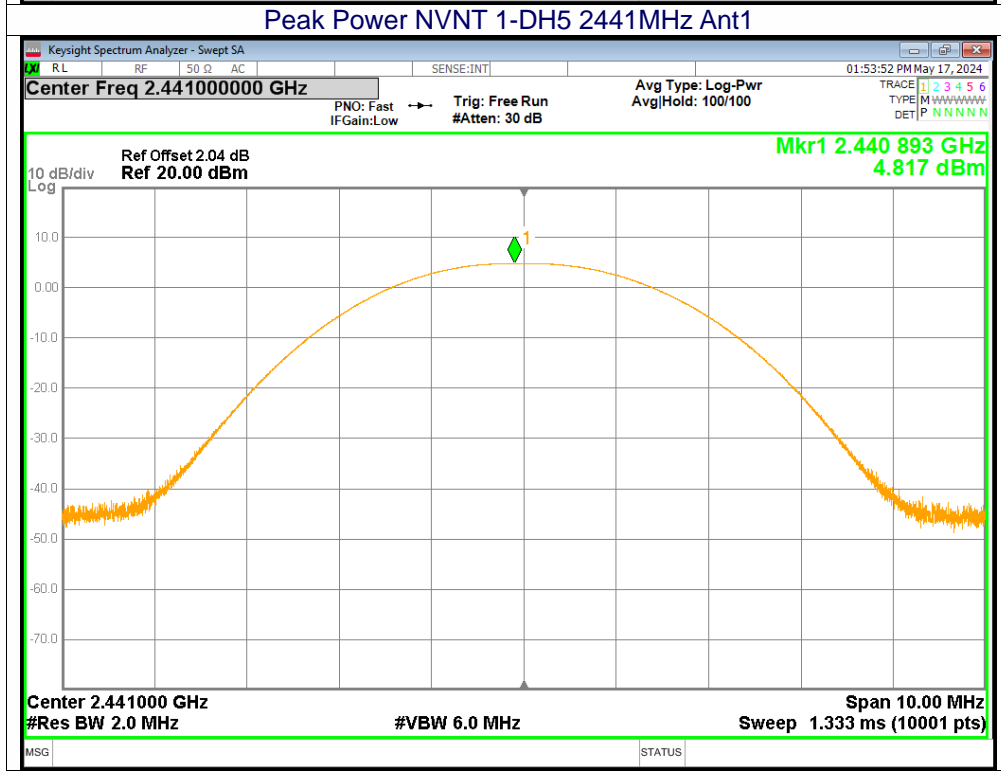
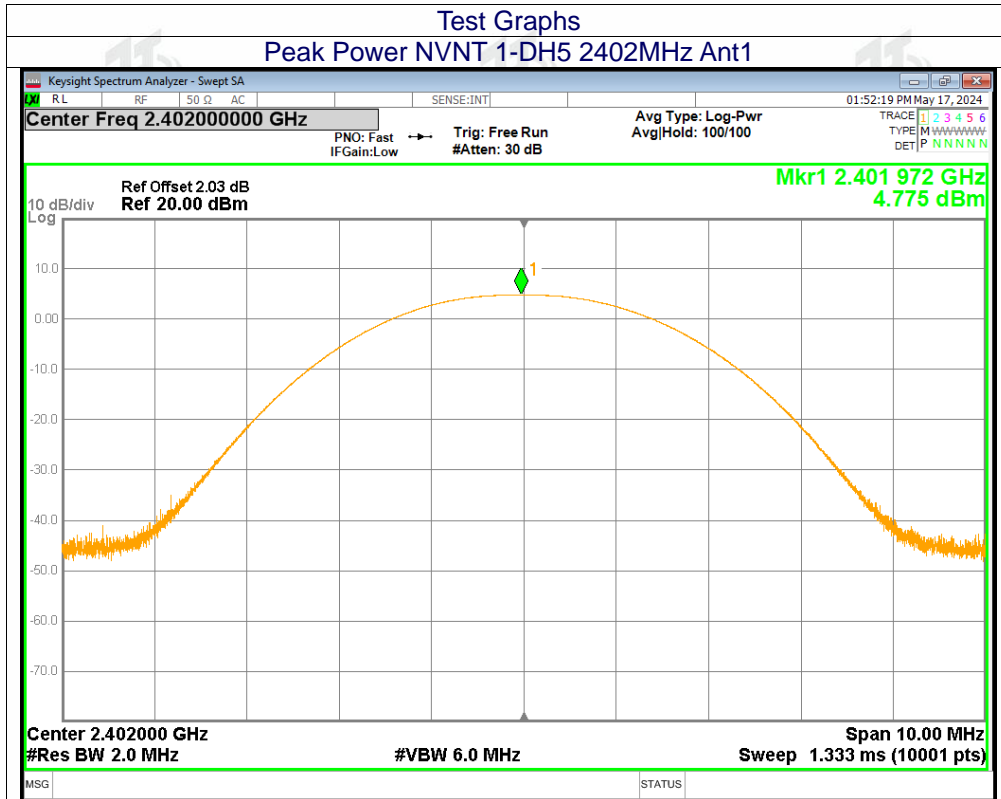

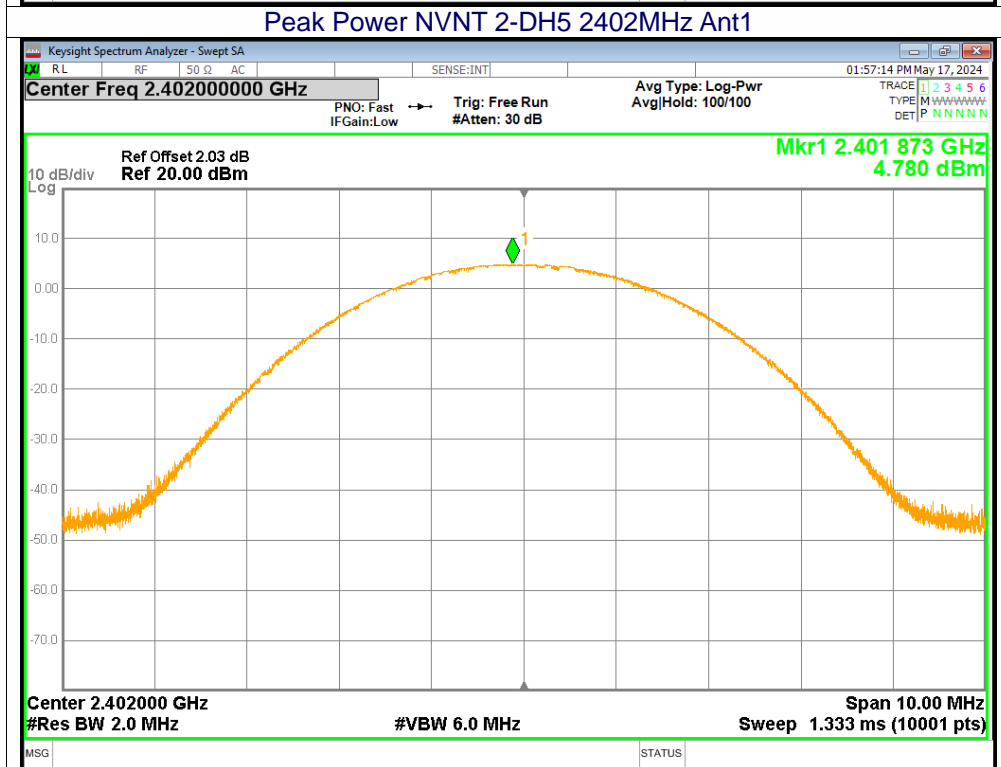
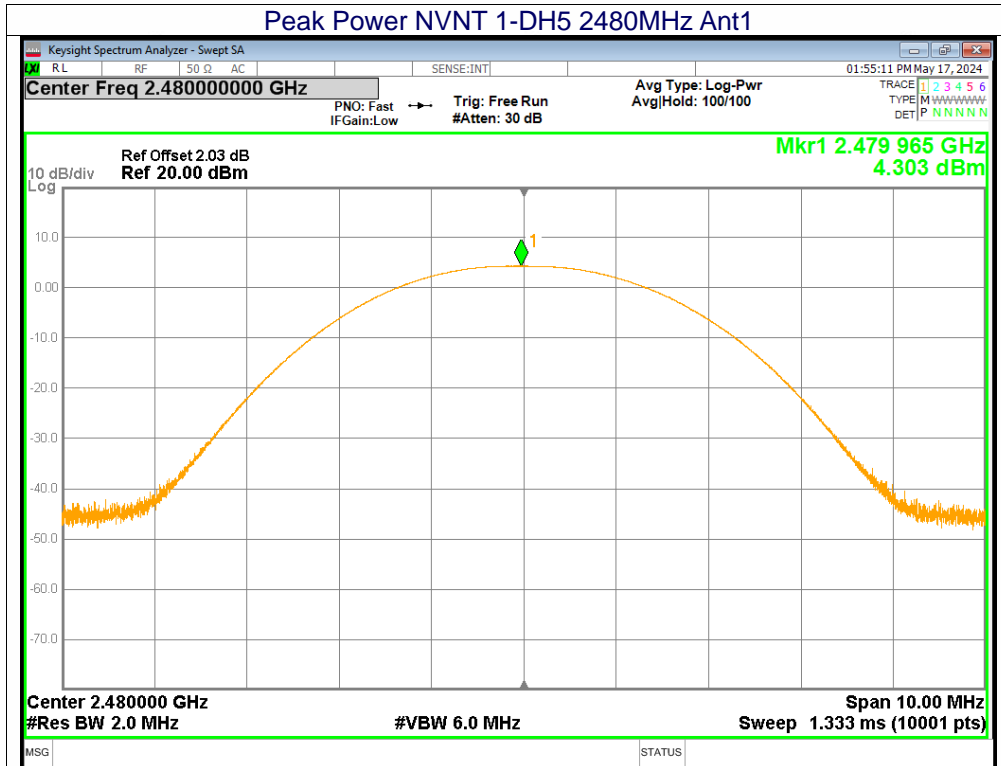

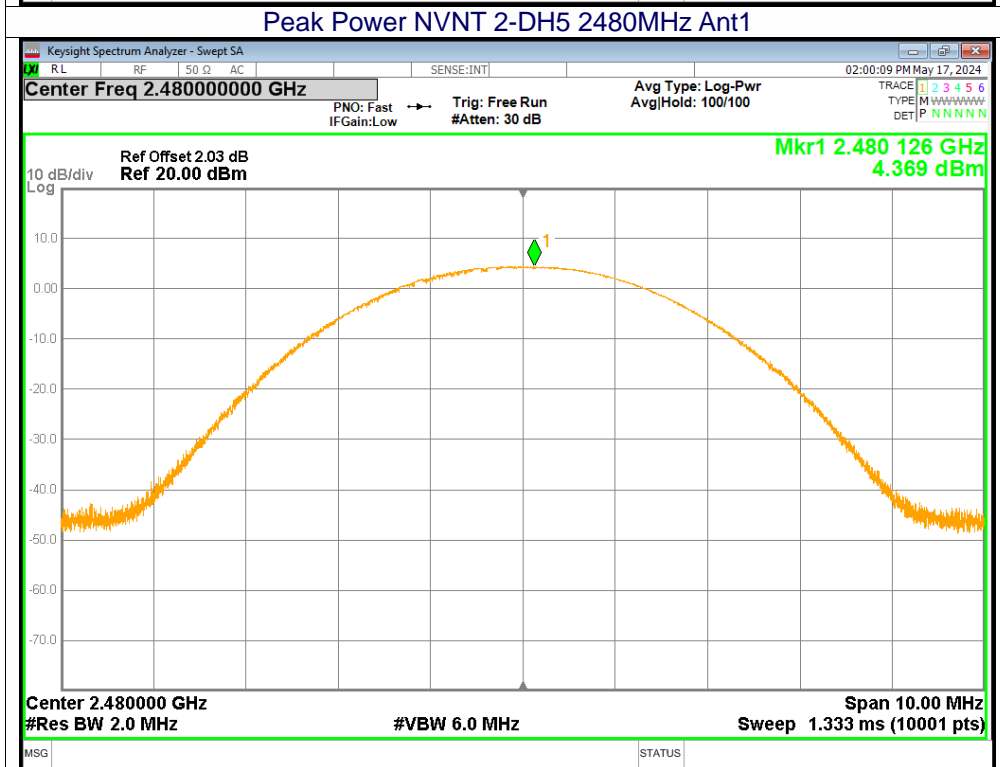
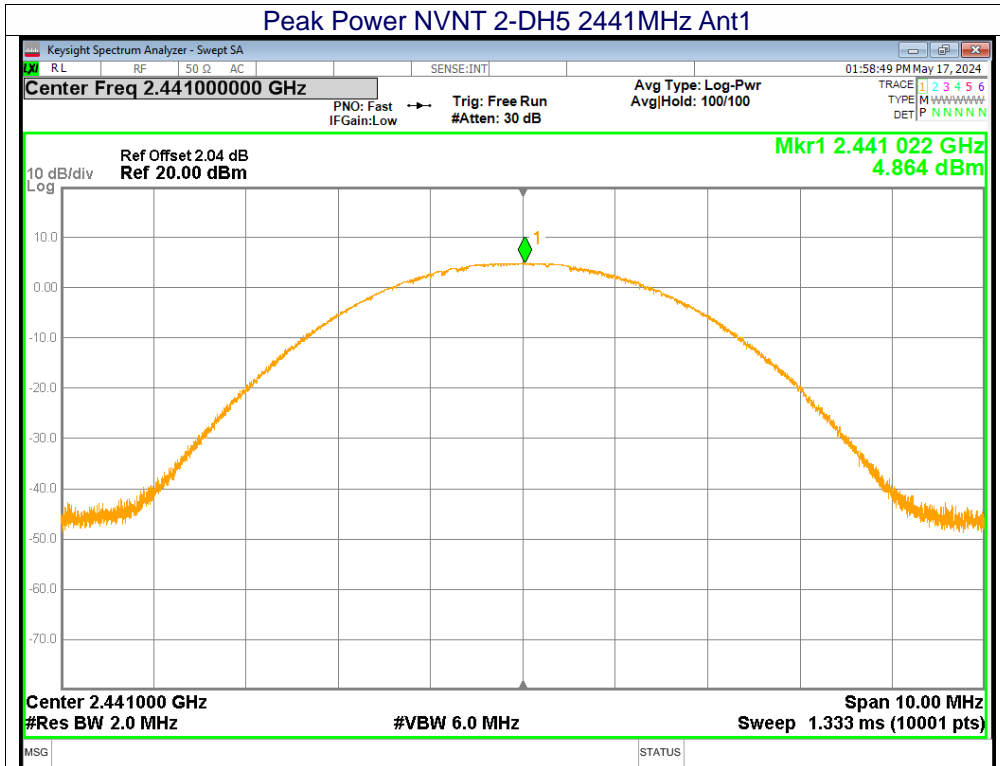

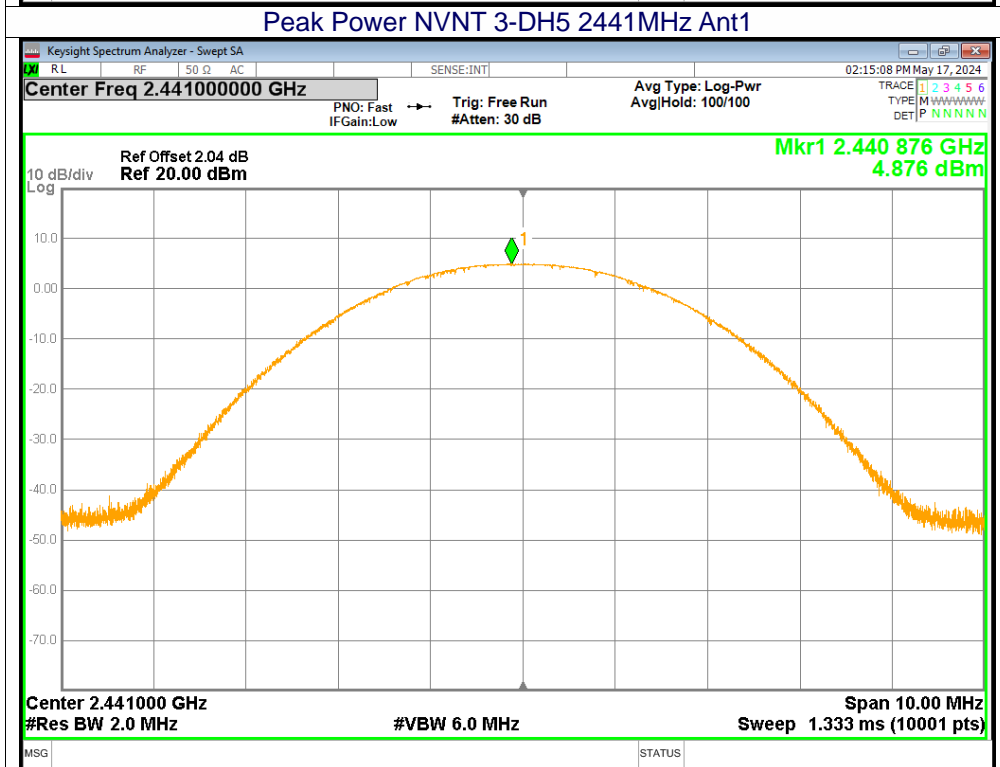
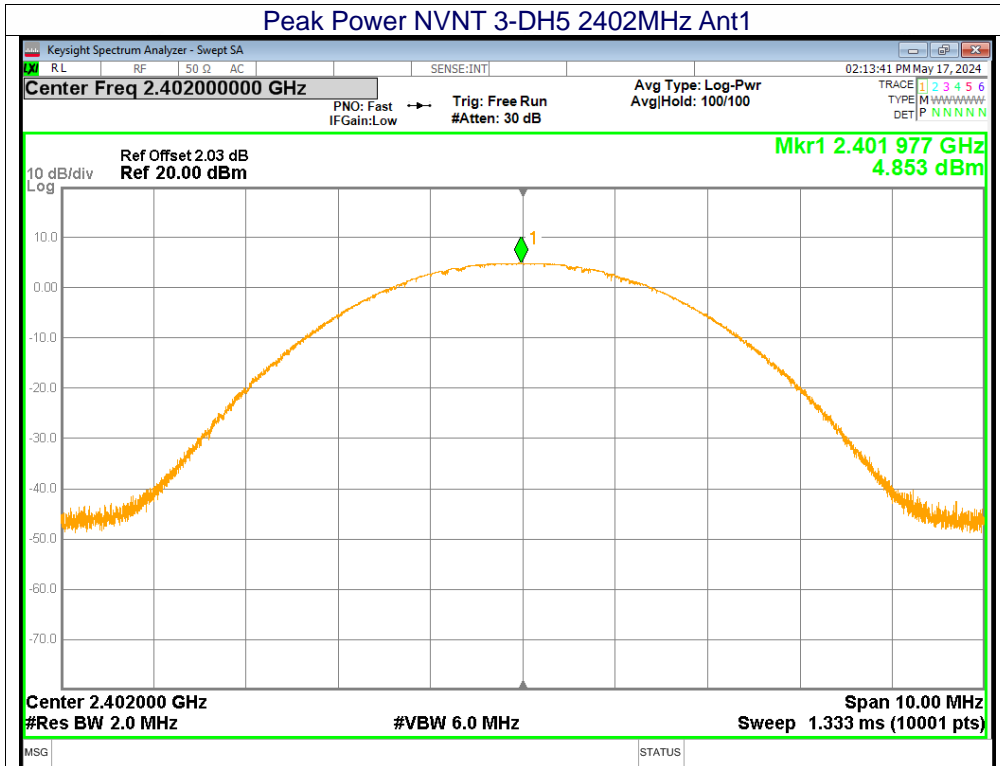

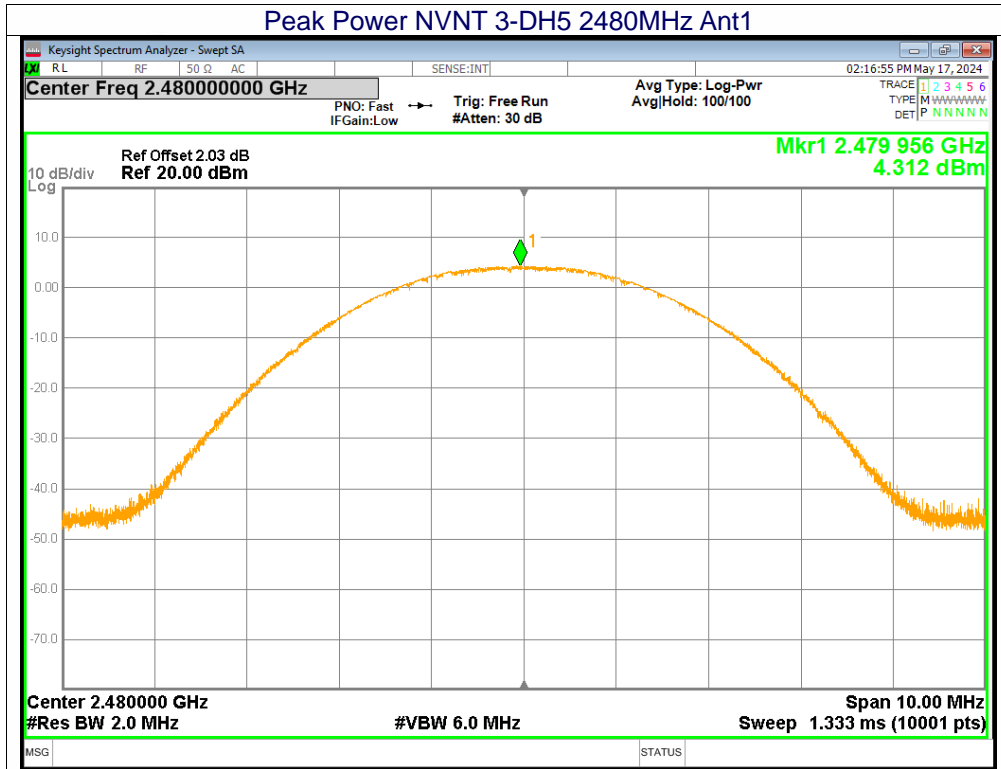

9. HOPPING CHANNEL SEPARATION

Test Requirement:	FCC Part15 C Section 15.247 (a)(1), RSS 247 5.1
Test Method:	ANSI C63.10:2013
Receiver setup:	RBW=30KHz, VBW=100KHz, detector=Peak
Limit:	GFSK: 20dB bandwidth $\pi/4$ -DQPSK & 8DSK: 0.025MHz or 2/3 of the 20dB bandwidth (whichever is greater)

9.1 Test Setup

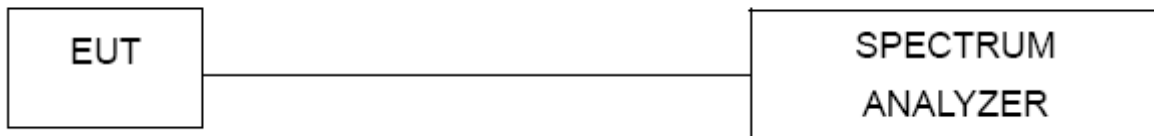

9.2 Test procedure

1. Remove the antenna from the EUT and then connect a low RF cable from the antenna port to the spectrum.
2. Set the spectrum analyzer: RBW = 30kHz. VBW = 100kHz , Span = 2.0MHz. Sweep = auto; Detector Function = Peak. Trace = Max hold.
3. Allow the trace to stabilize. Use the marker-delta function to determine the separation between the peaks of the adjacent channels. The limit is specified in one of the subparagraphs of this Section Submit this plot.

9.3 DEVIATION FROM STANDARD

No deviation.

9.4 Test Result

Modulation	Separation (MHz)	Limit(MHz)	Result
GFSK	1.138	0.025	PASS
$\pi/4$ DQPSK	0.98	0.848	PASS
8DPSK	1.216	0.812	PASS

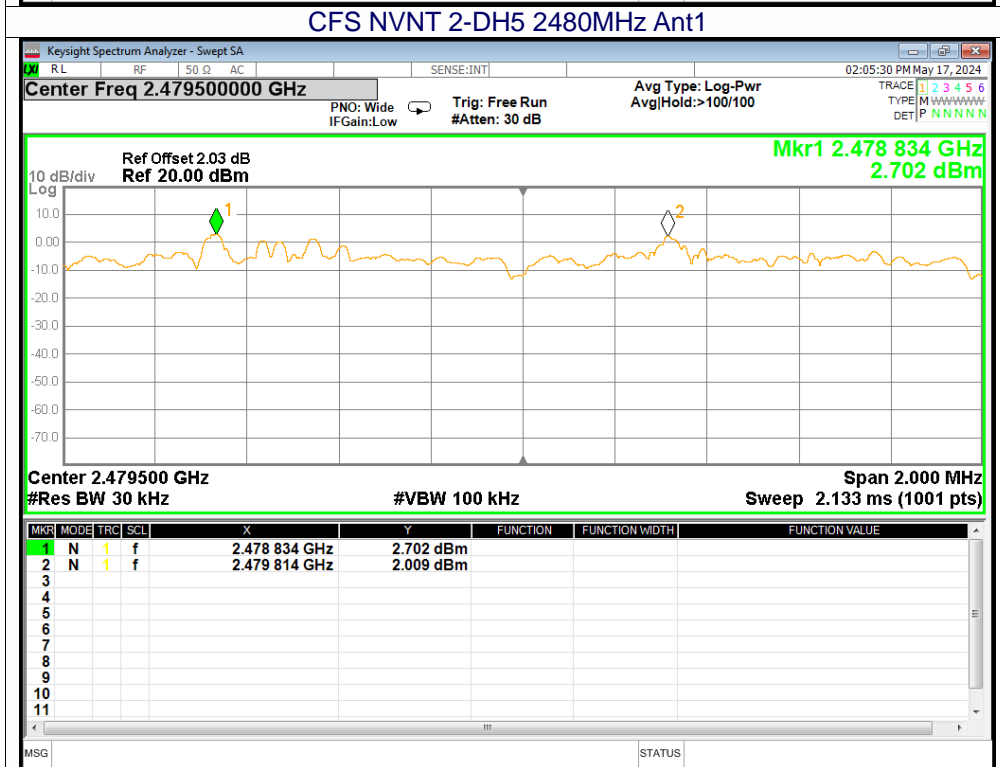
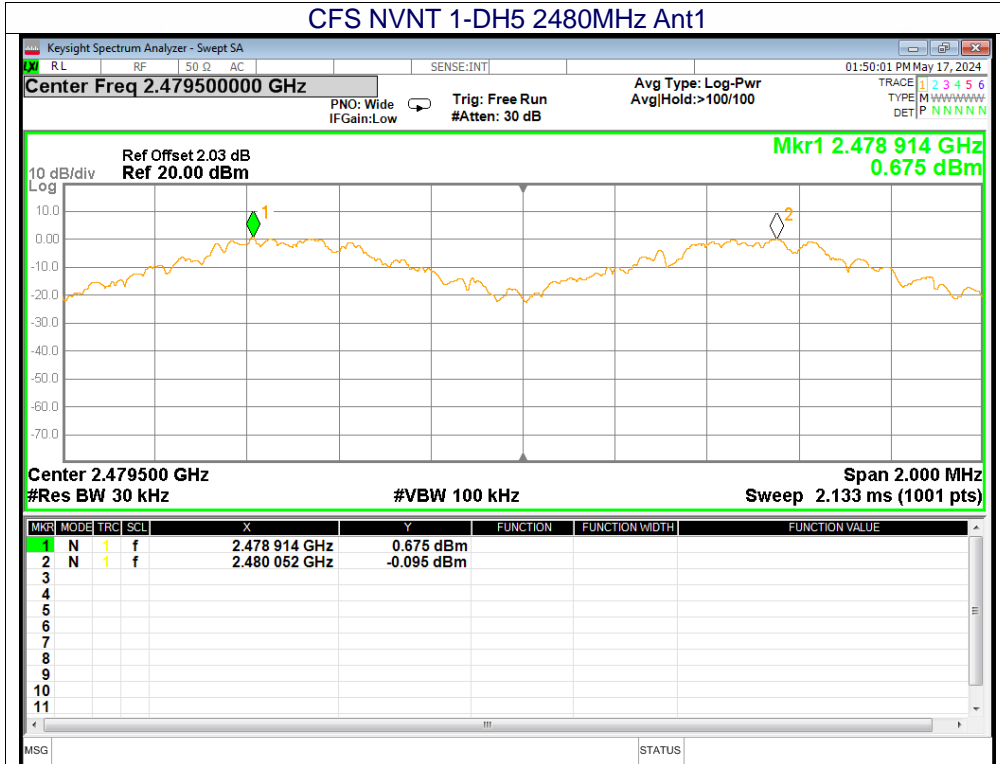

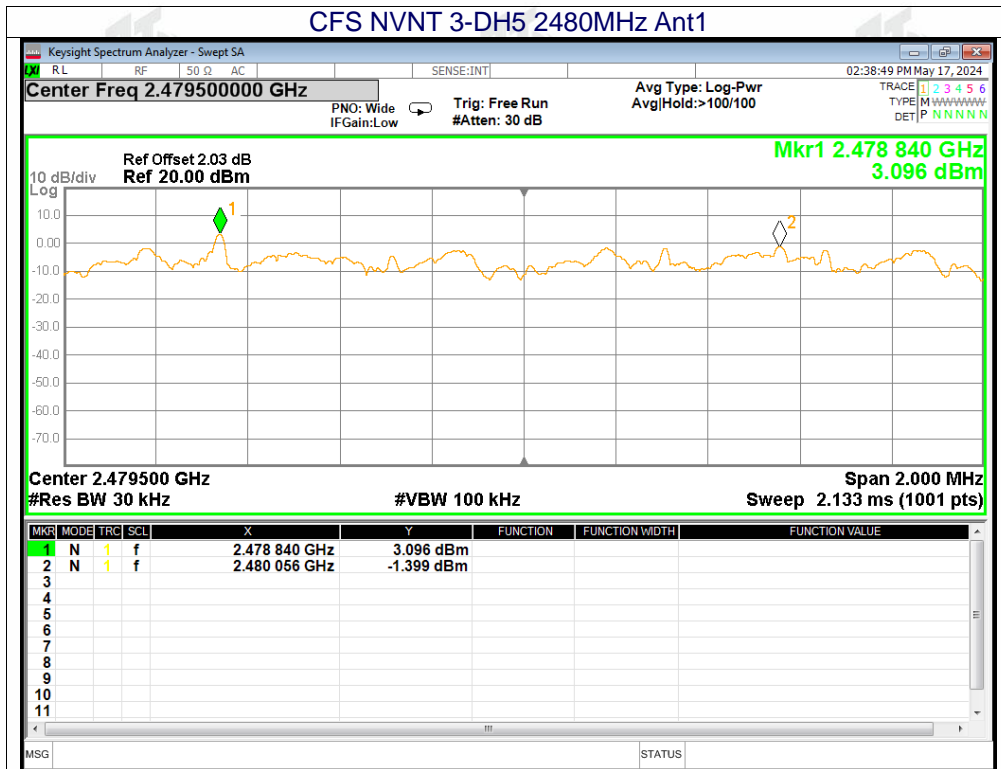



10.NUMBER OF HOPPING FREQUENCY

Test Requirement:	FCC Part15 C Section 15.247 (a)(1)(iii), RSS-247 5.1
Test Method:	ANSI C63.10:2013
Receiver setup:	RBW=100kHz, VBW=300kHz, Frequency range=2400MHz-2483.5MHz, Detector=Peak
Limit:	15 channels

10.1 Test Setup

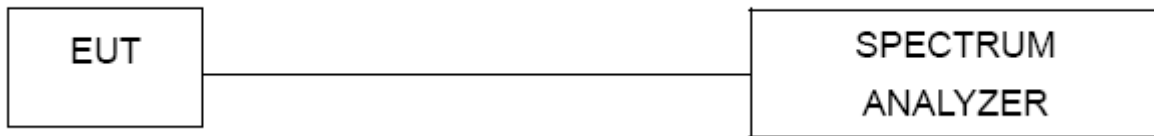

10.2 Test procedure

1. Remove the antenna from the EUT and then connect a low RF cable from the antenna port to the spectrum.
2. Set the spectrum analyzer: RBW = 100kHz. VBW = 300kHz. Sweep = auto; Detector Function = Peak. Trace = Max hold.
3. Allow the trace to stabilize. It may prove necessary to break the span up to sections. in order to clearly show all of the hopping frequencies. The limit is specified in one of the subparagraphs of this Section.
4. Set the spectrum analyzer: Start Frequency = 2.4GHz, Stop Frequency = 2.4835GHz. Sweep=auto;

10.3 DEVIATION FROM STANDARD

No deviation.



10.4 Test Result

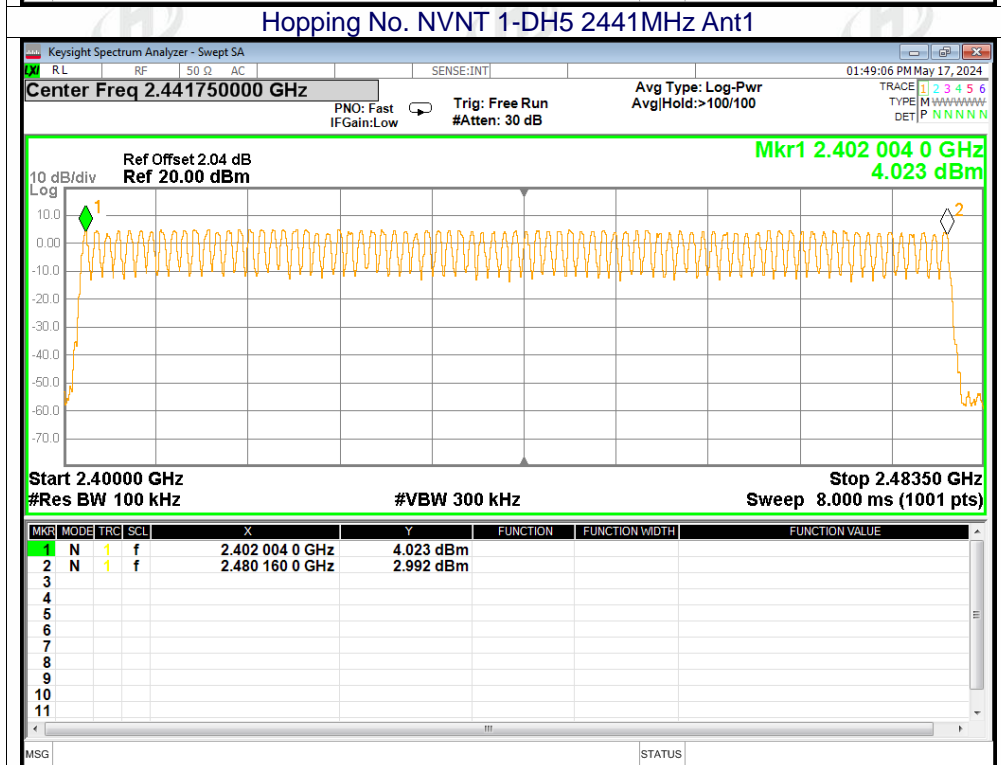
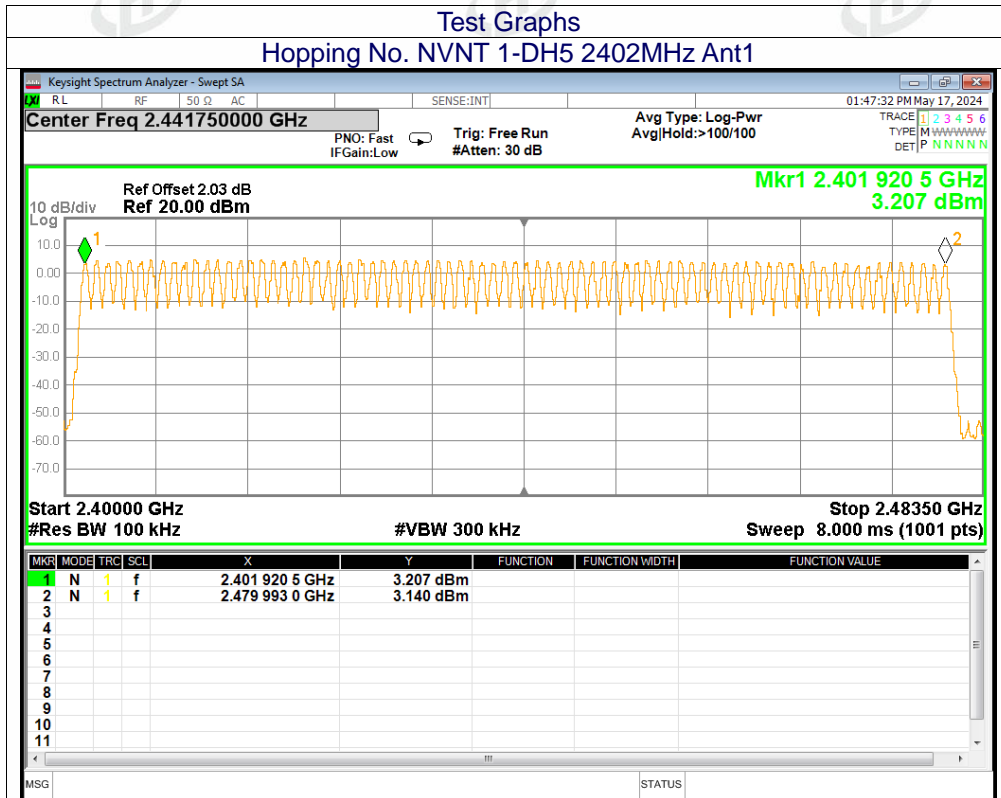

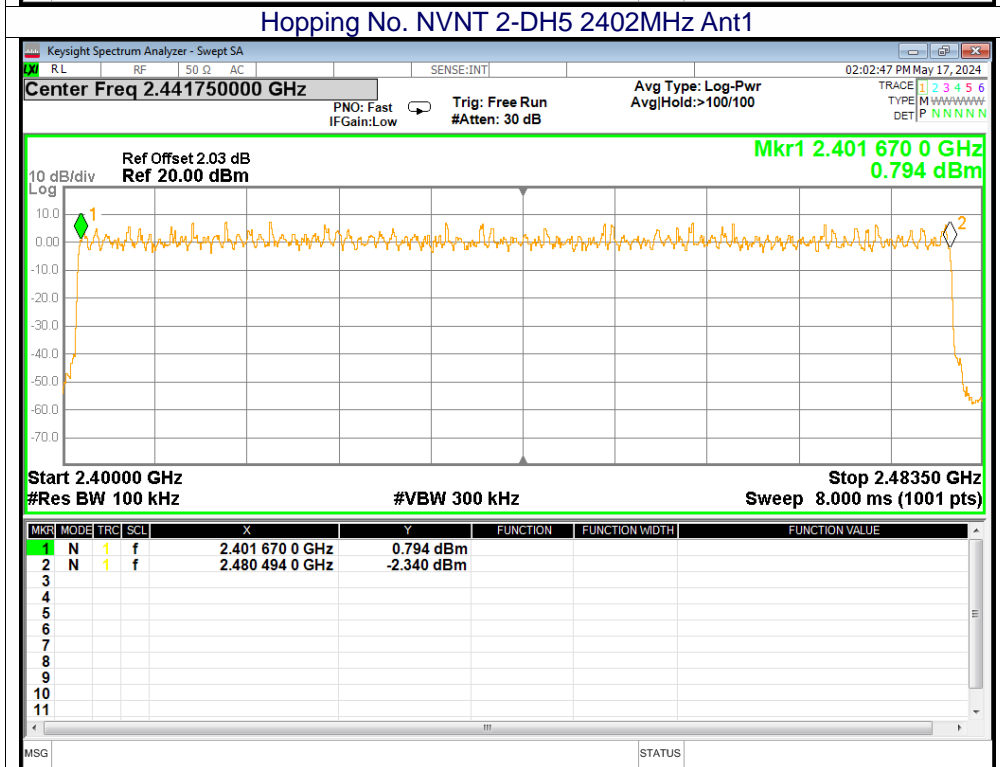
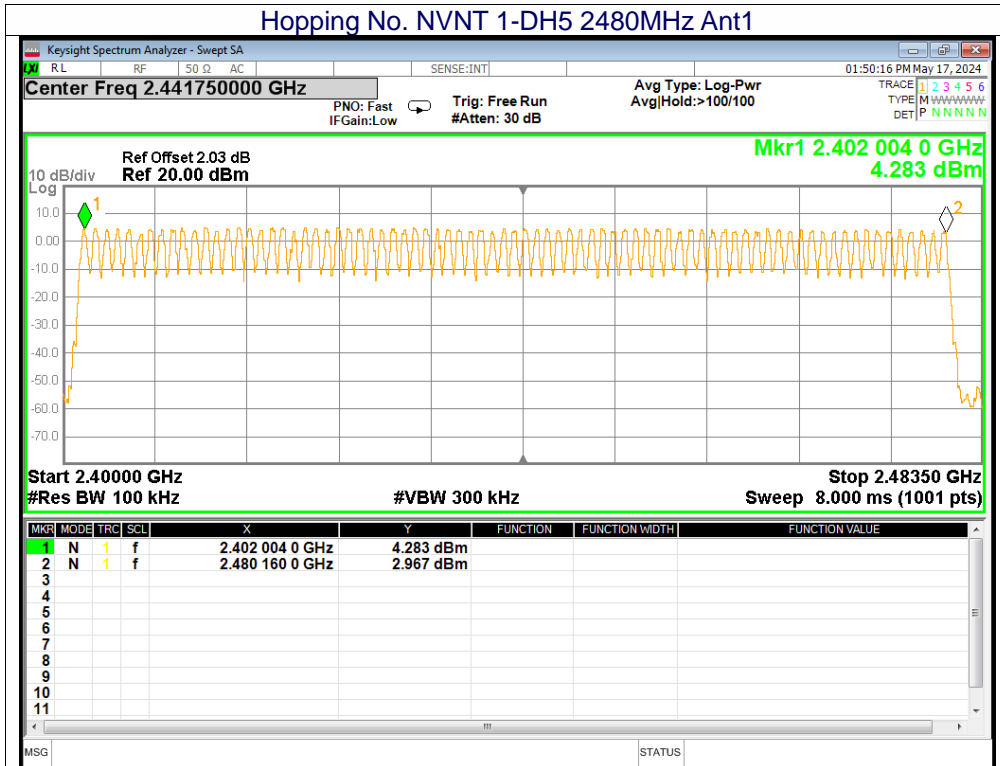

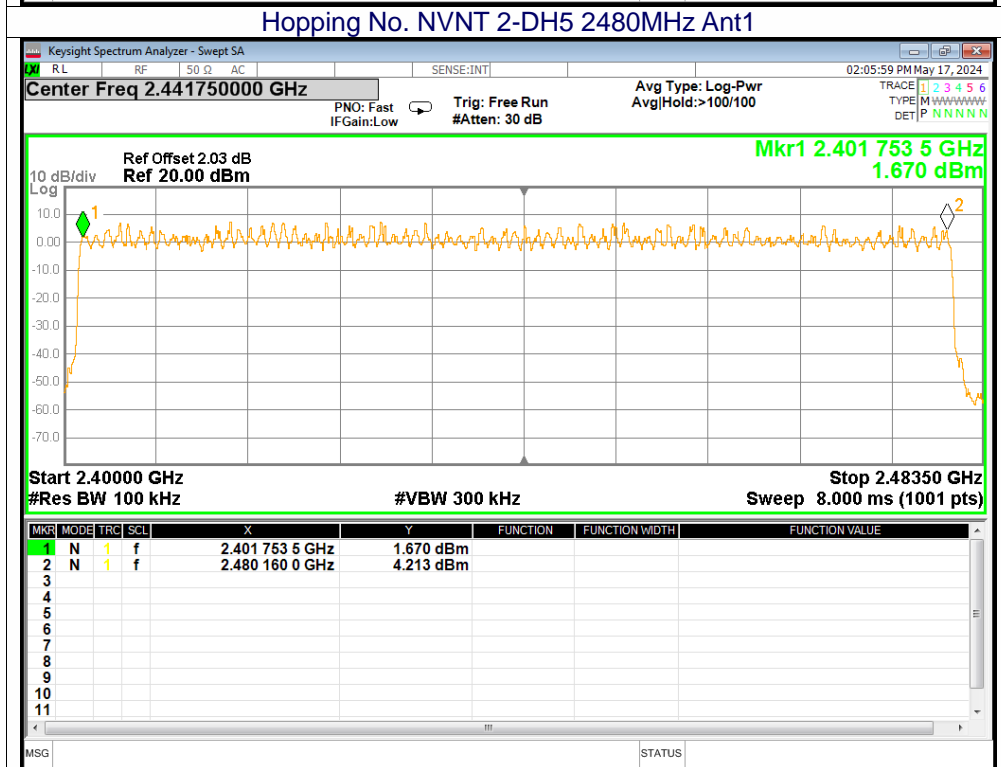
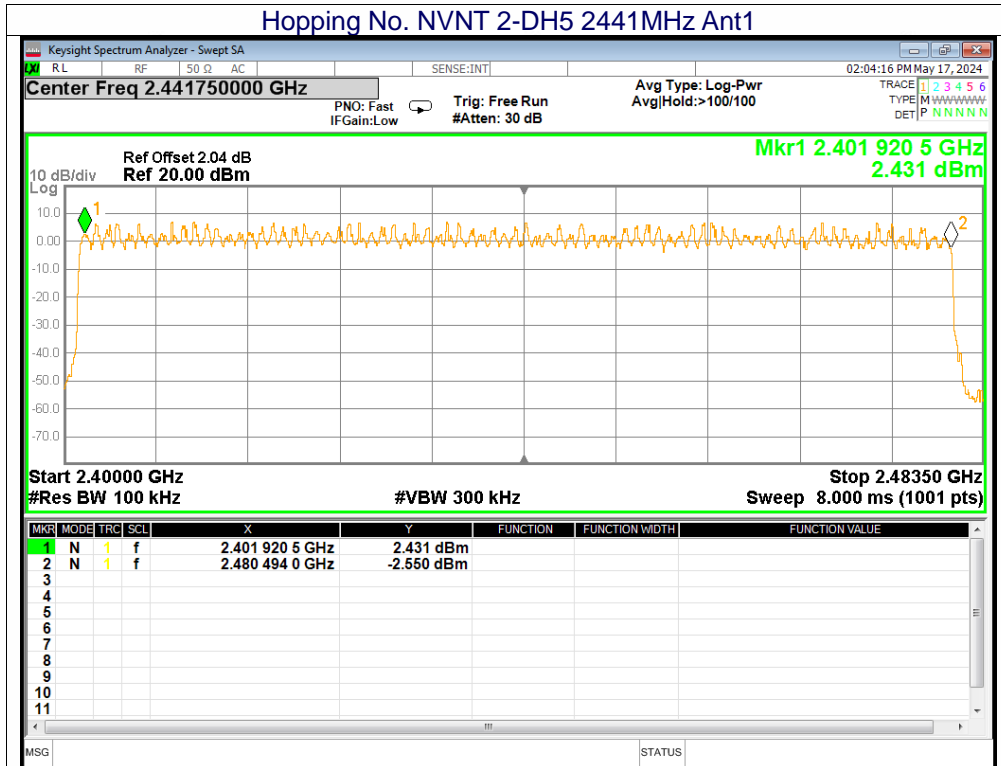

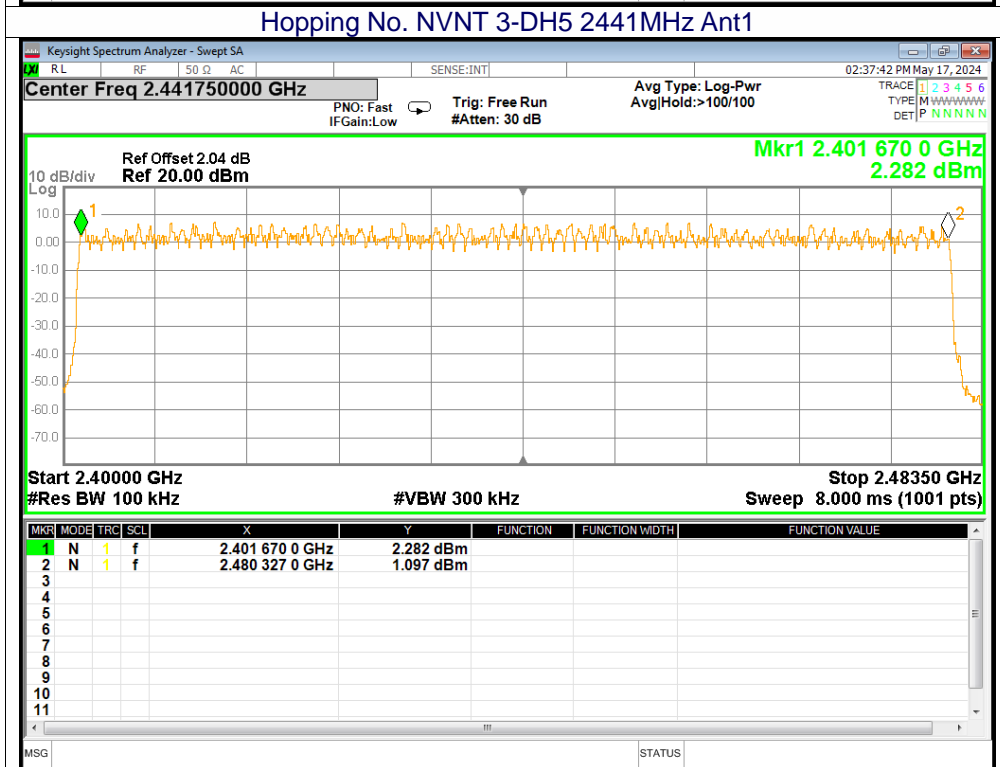
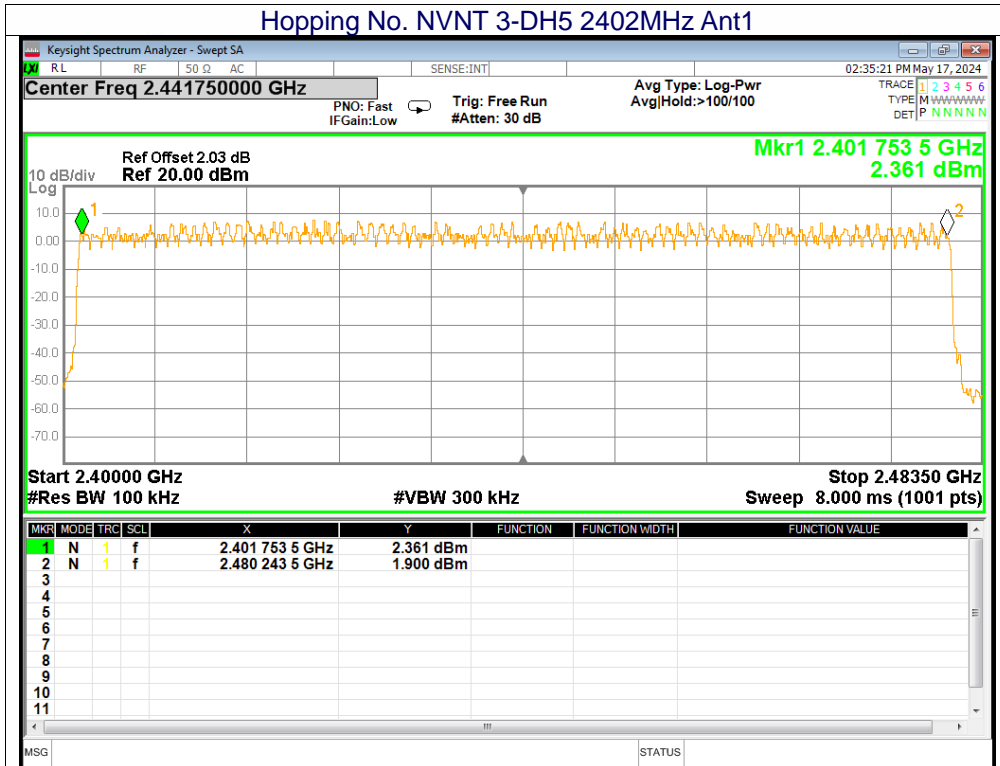

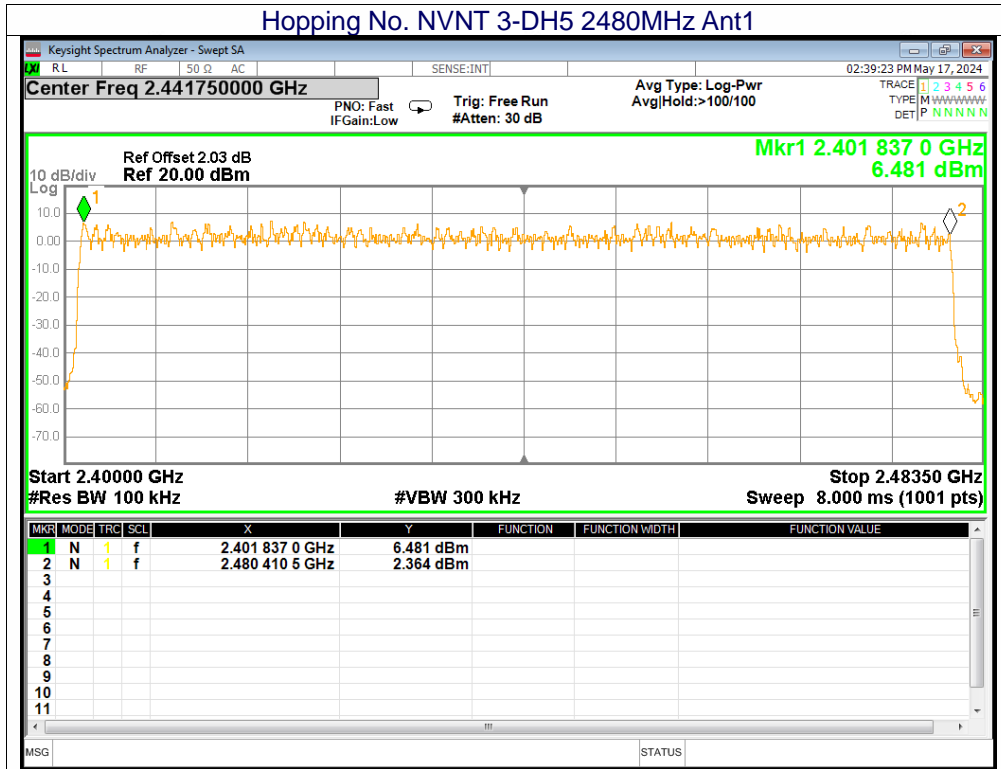

11. DWELL TIME

Test Requirement:	FCC Part15 C Section 15.247 (a)(1)(iii), RSS-247 5.1
Test Method:	ANSI C63.10:2013
Receiver setup:	RBW=1MHz, VBW=3MHz, Span=0Hz, Detector=Peak
Limit:	0.4 Second

11.1 Test Setup

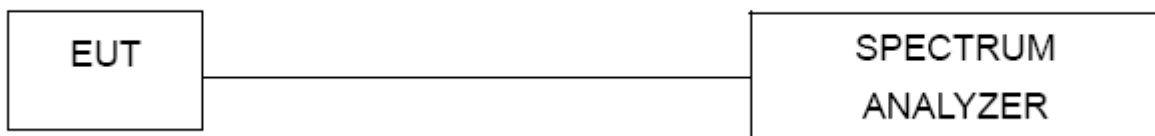

11.2 Test procedure

1. Remove the antenna from the EUT and then connect a low RF cable from the antenna port to the spectrum.
2. Set spectrum analyzer span = 0Hz;
3. Set RBW = 1MHz and VBW = 3MHz. Sweep = as necessary to capture the entire dwell time per hopping channel. Set the EUT for DH5, DH3 and DH1 packet transmitting.
4. Use the marker-delta function to determine the dwell time. If this value varies with different modes of operation (e.g.. data rate. modulation format. etc.). repeat this test for each variation. The limit is specified in one of the subparagraphs of this Section. Submit this plot(s).

11.3 DEVIATION FROM STANDARD

No deviation.



11.4 Test Result

Mode	Frequency (MHz)	Pulse Time (ms)	Total Dwell Time (ms)	Burst Count	Period Time (ms)	Limit (ms)	Verdict
1-DH1	2441	0.383	121.028	316	31600	400	Pass
1-DH3	2441	1.639	254.045	155	31600	400	Pass
1-DH5	2441	2.887	326.231	113	31600	400	Pass
2-DH1	2441	0.391	123.947	317	31600	400	Pass
2-DH3	2441	1.643	267.809	163	31600	400	Pass
2-DH5	2441	2.891	318.01	110	31600	400	Pass
3-DH1	2441	0.392	124.264	317	31600	400	Pass
3-DH3	2441	1.642	257.794	157	31600	400	Pass
3-DH5	2441	2.893	306.658	106	31600	400	Pass

Remarks:

The test period: T= 0.4 Second/Channel x 79 Channel = 31.6 s

(1 / 2 / 3)-DH1: Dwell time (ms) = Pulse Time (ms) * [1600 / (2 * 79)] * 31.6s

(1 / 2 / 3)-DH3: Dwell time (ms) = Pulse Time (ms) * [1600 / (4 * 79)] * 31.6s

(1 / 2 / 3)-DH5: Dwell time (ms) = Pulse Time (ms) * [1600 / (6 * 79)] * 31.6s

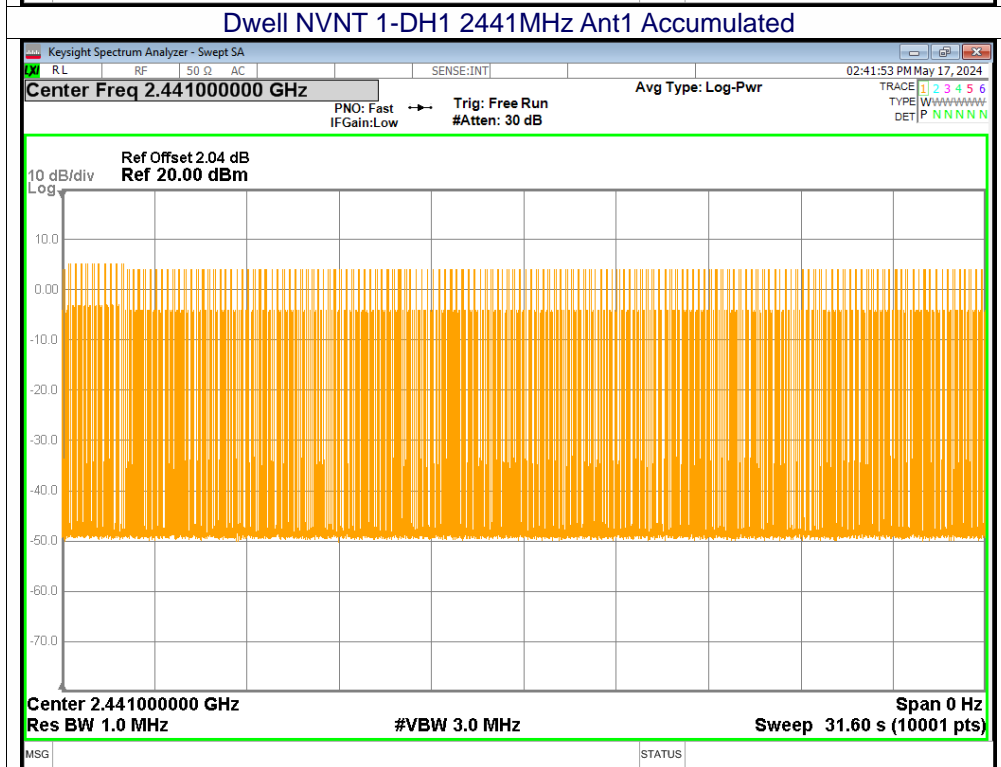
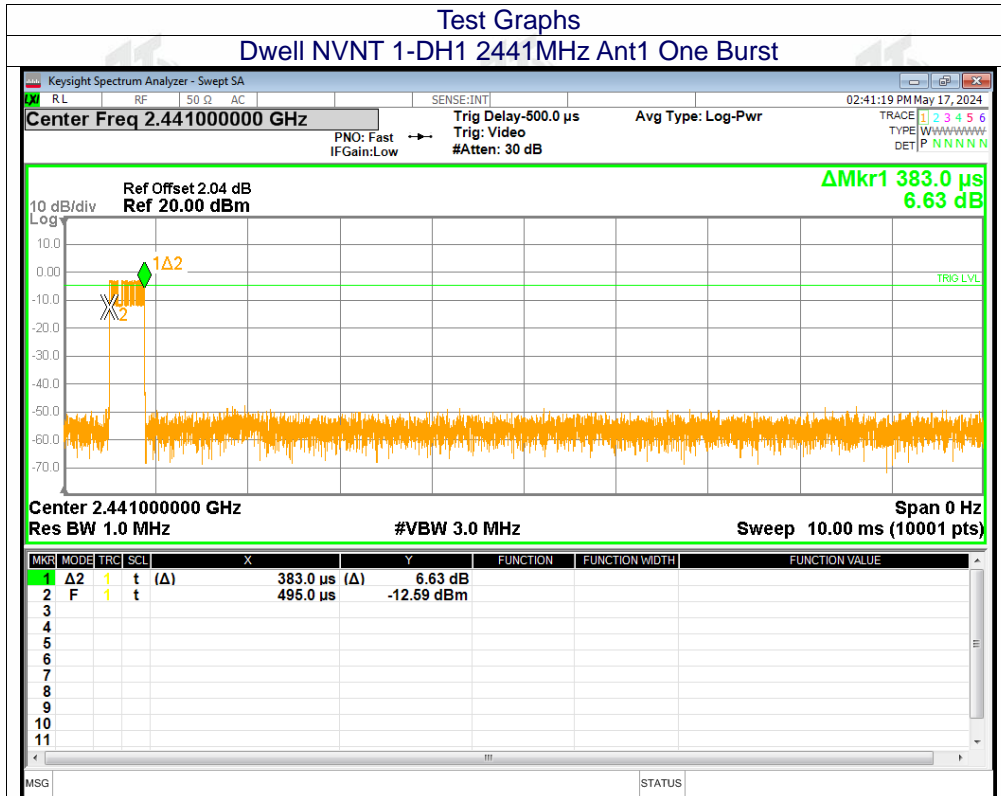

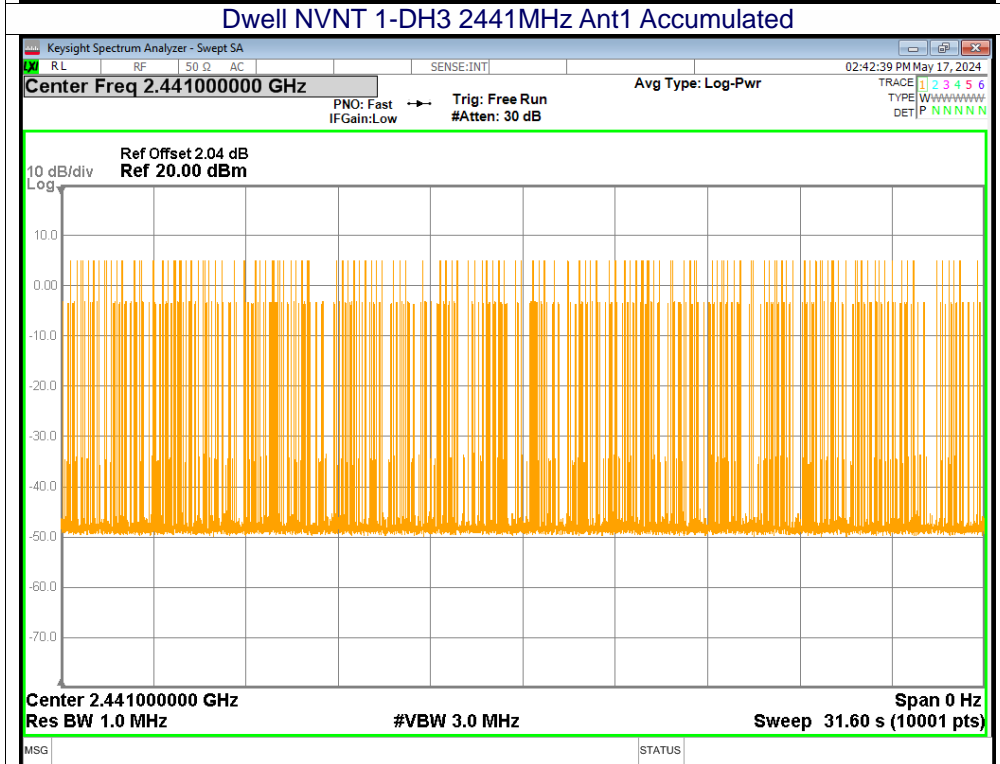
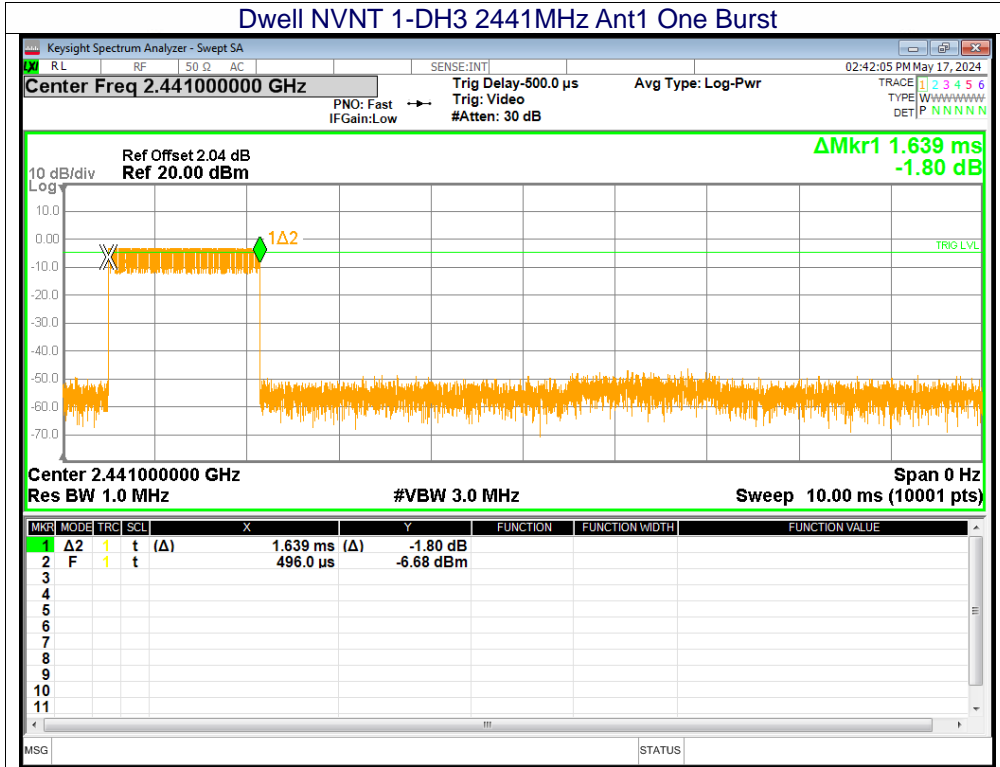

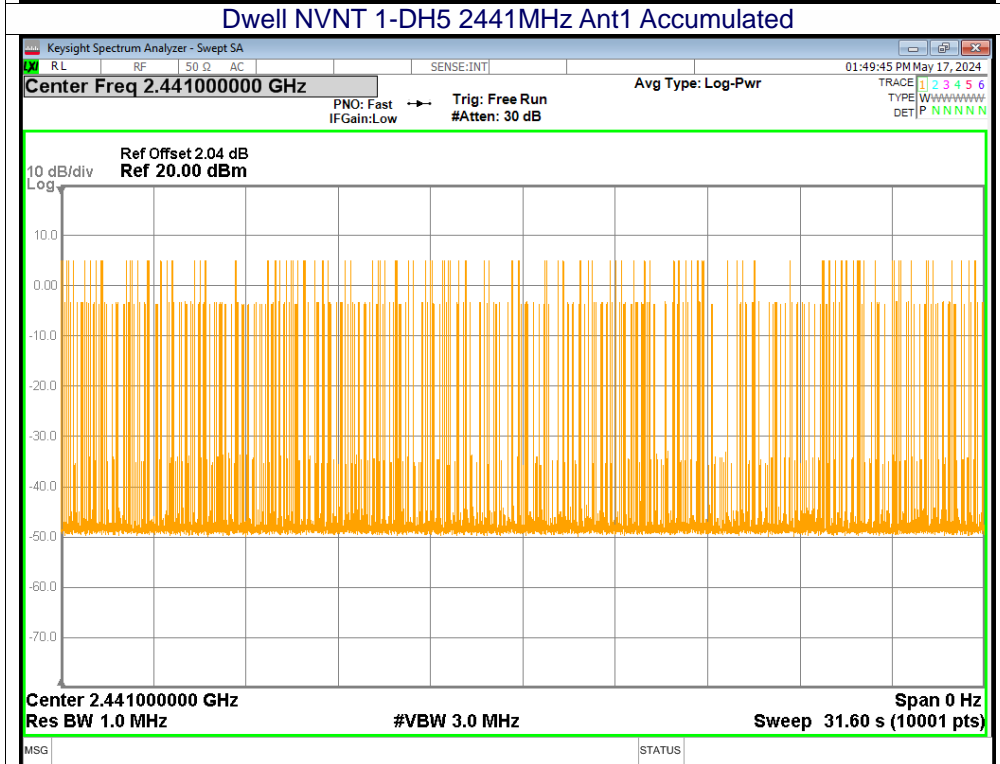
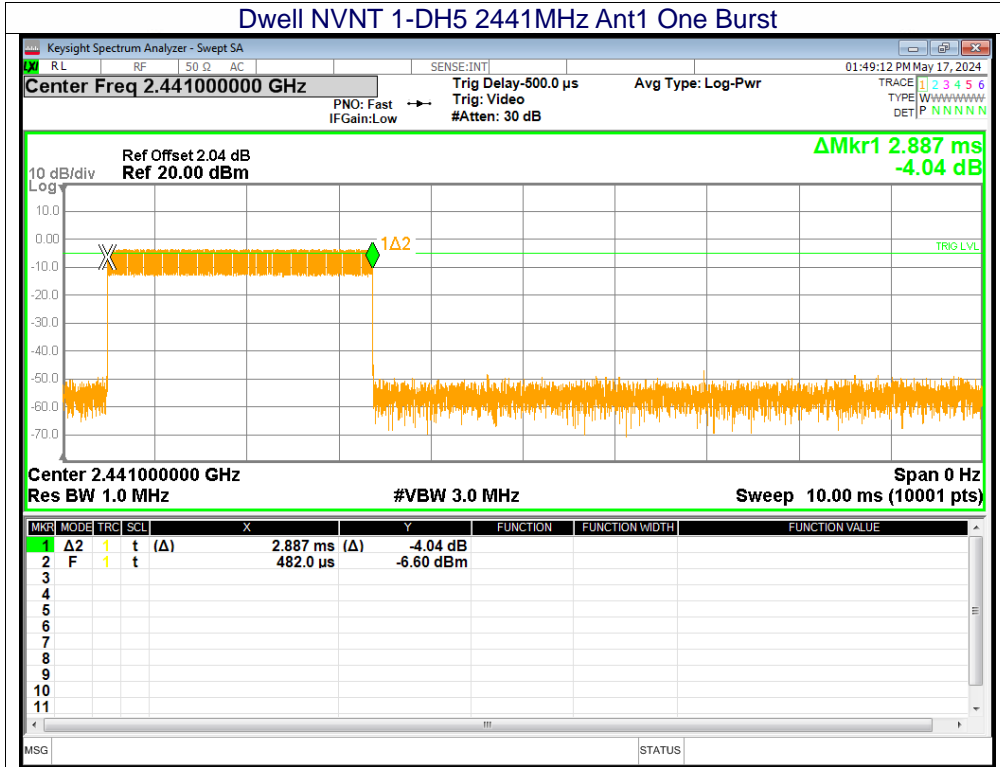

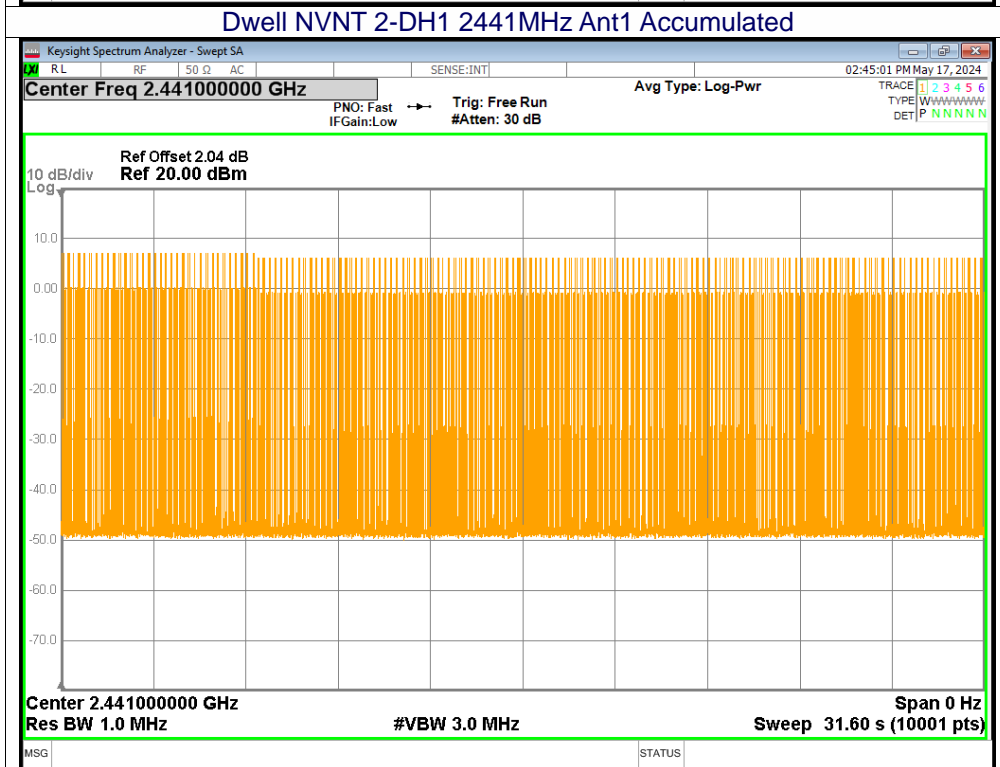
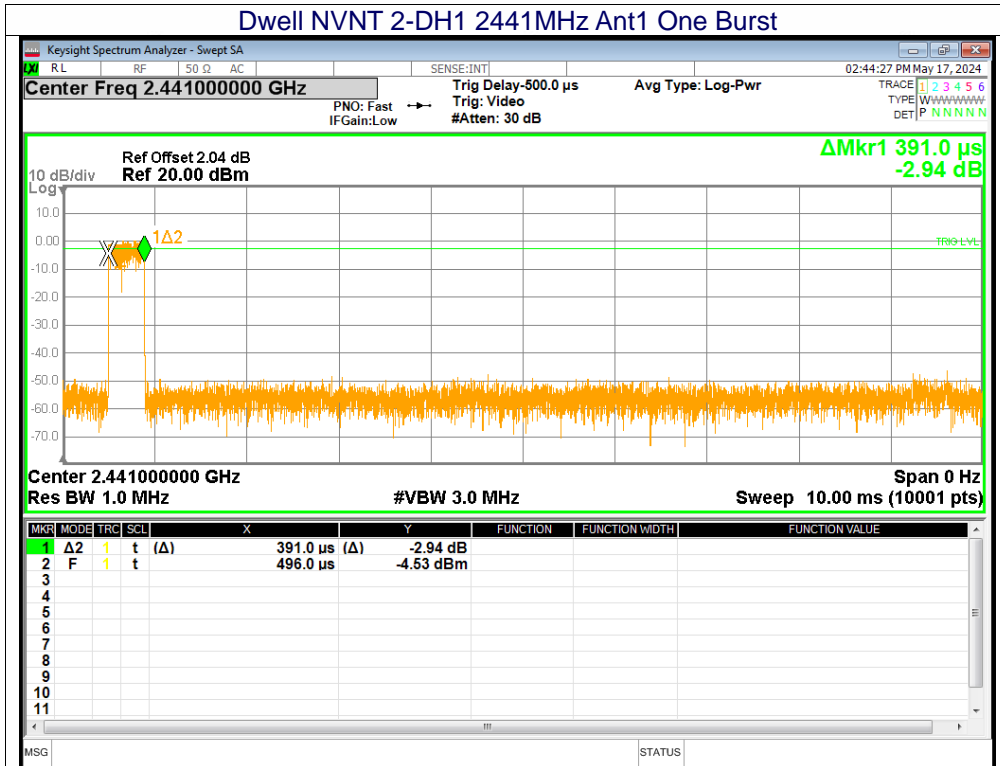

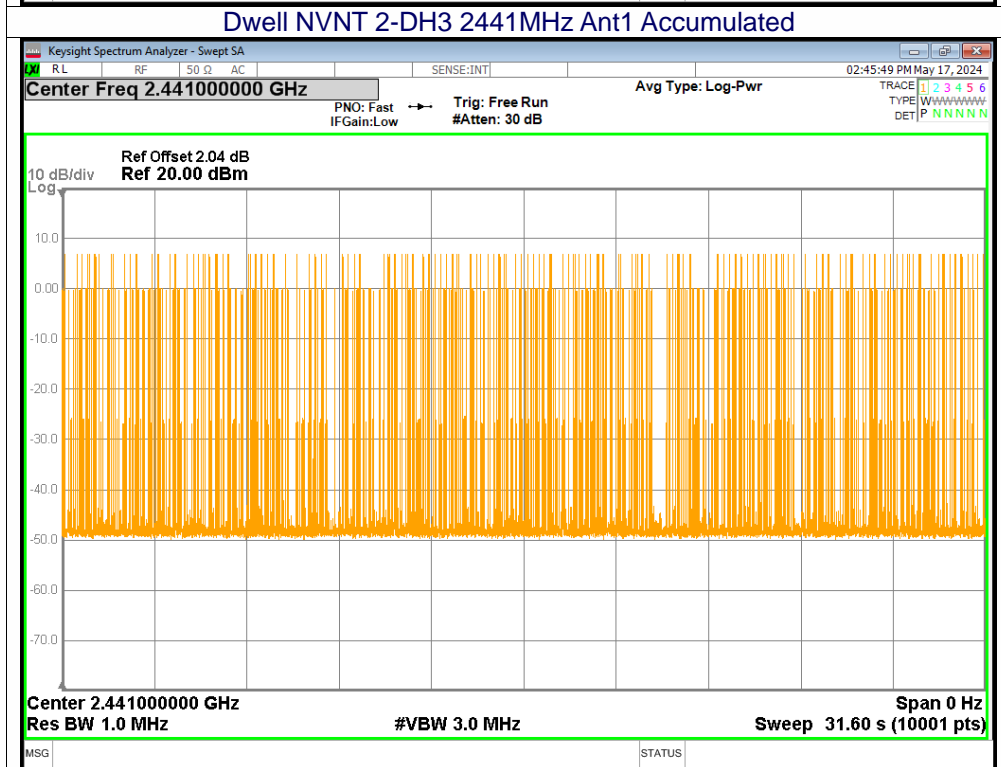
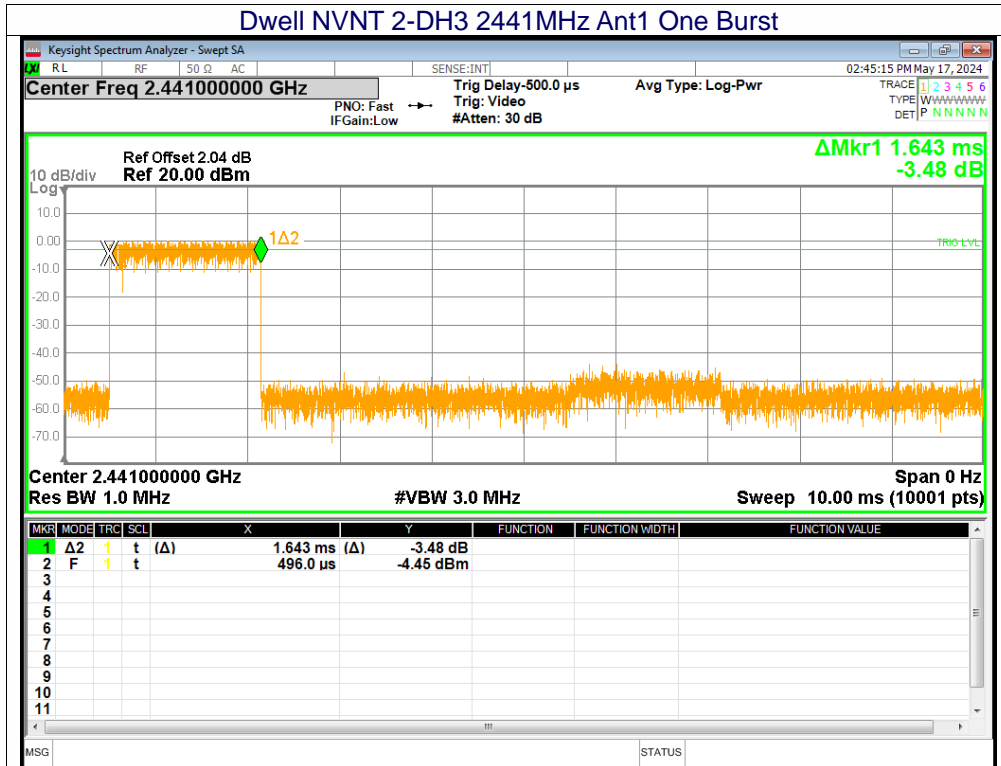

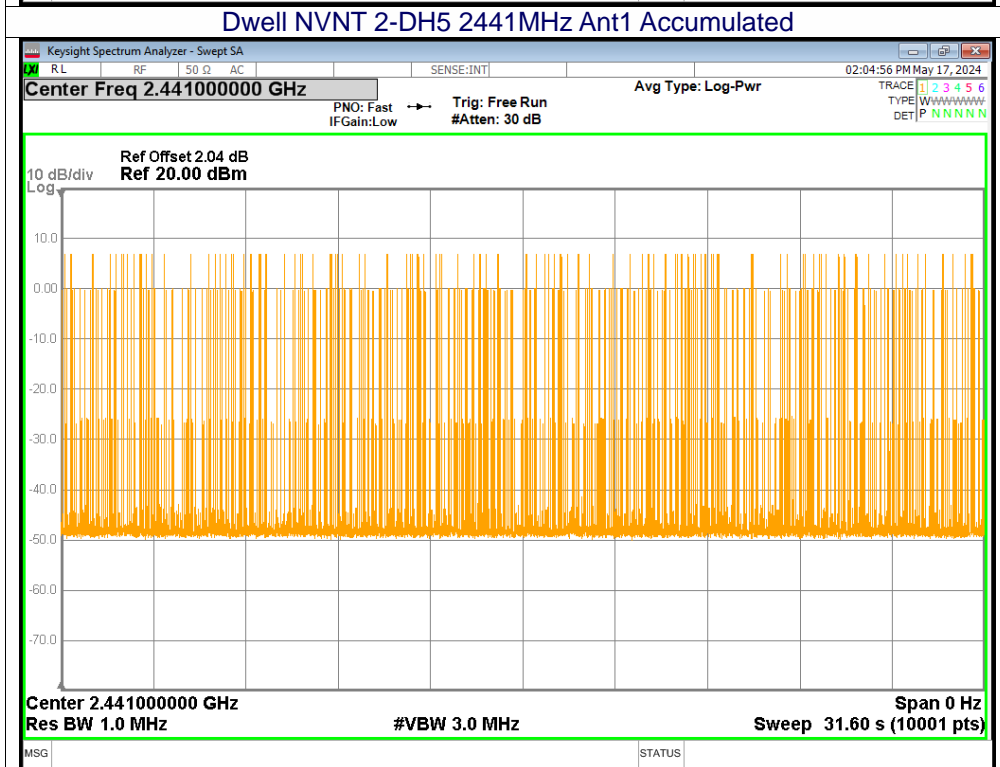
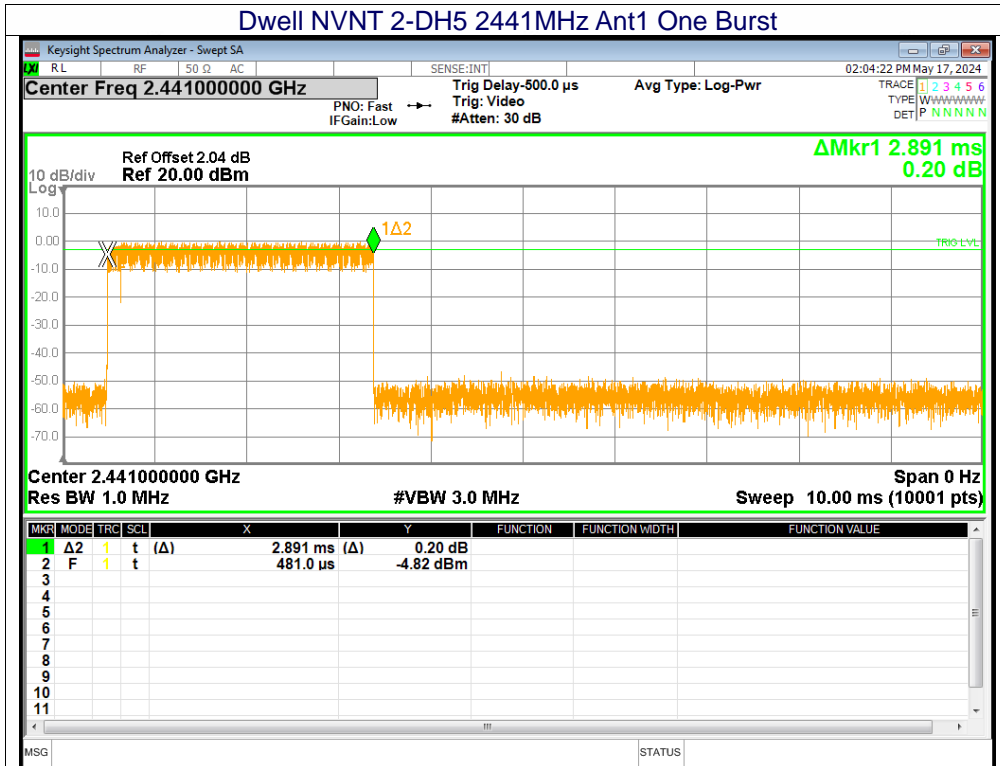

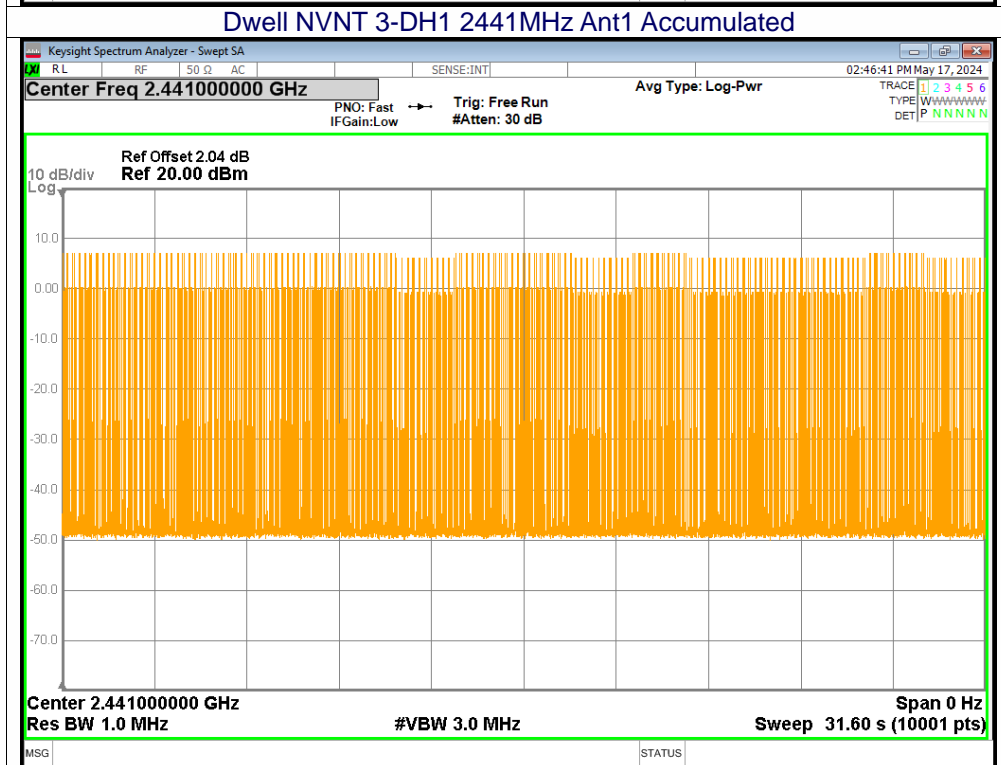
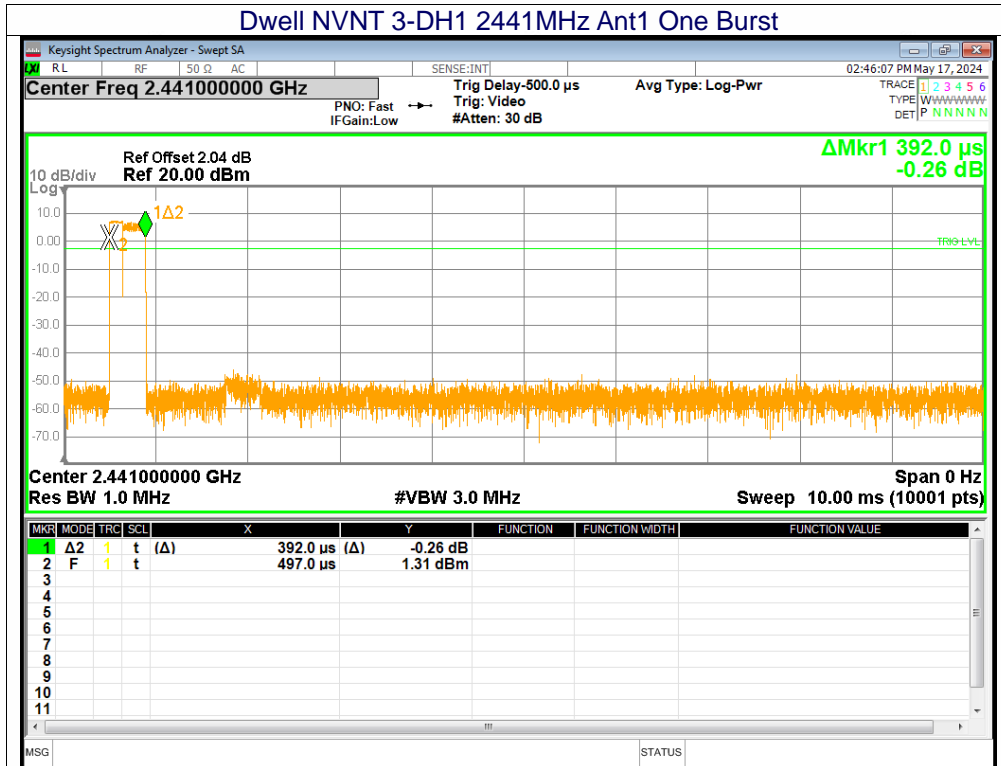

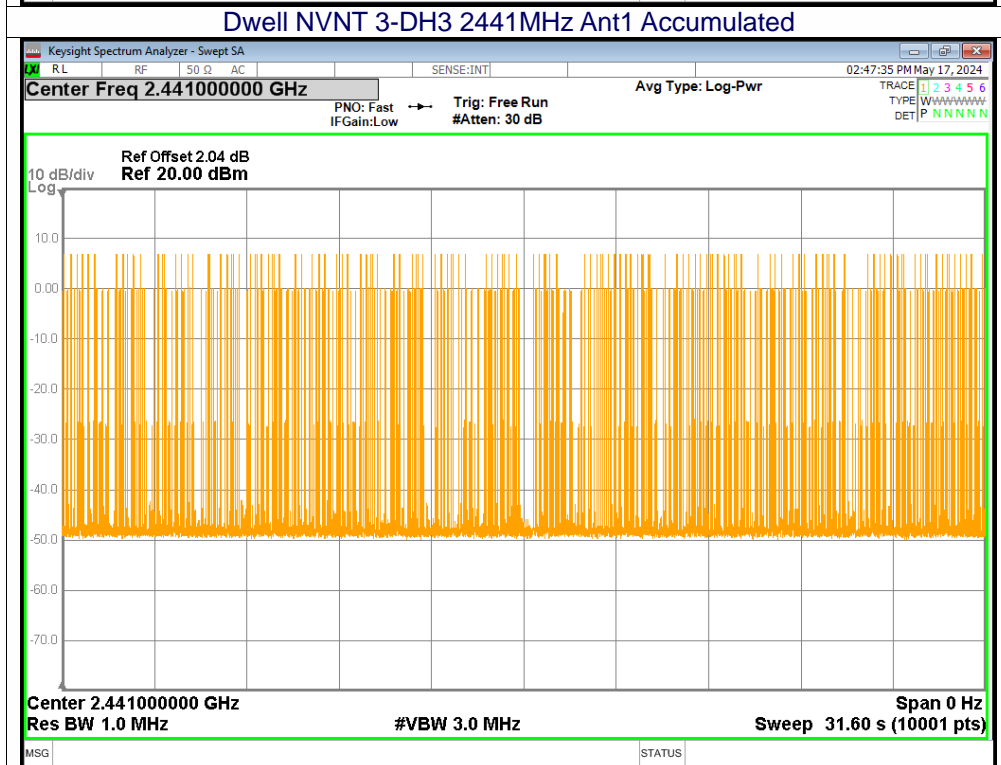
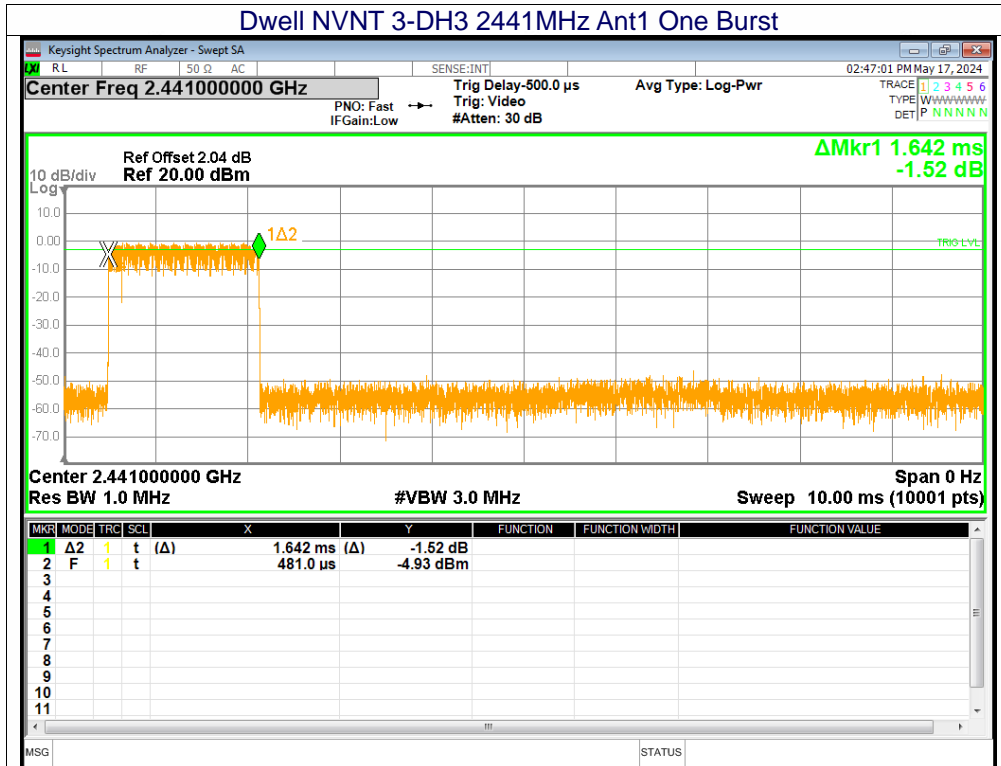

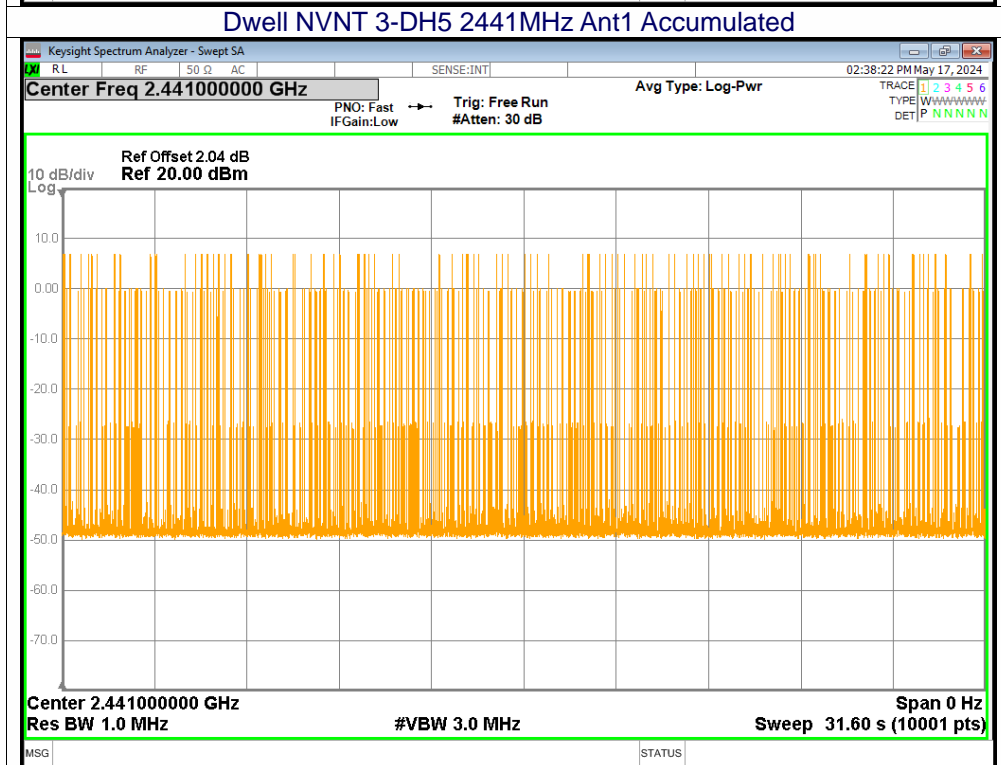
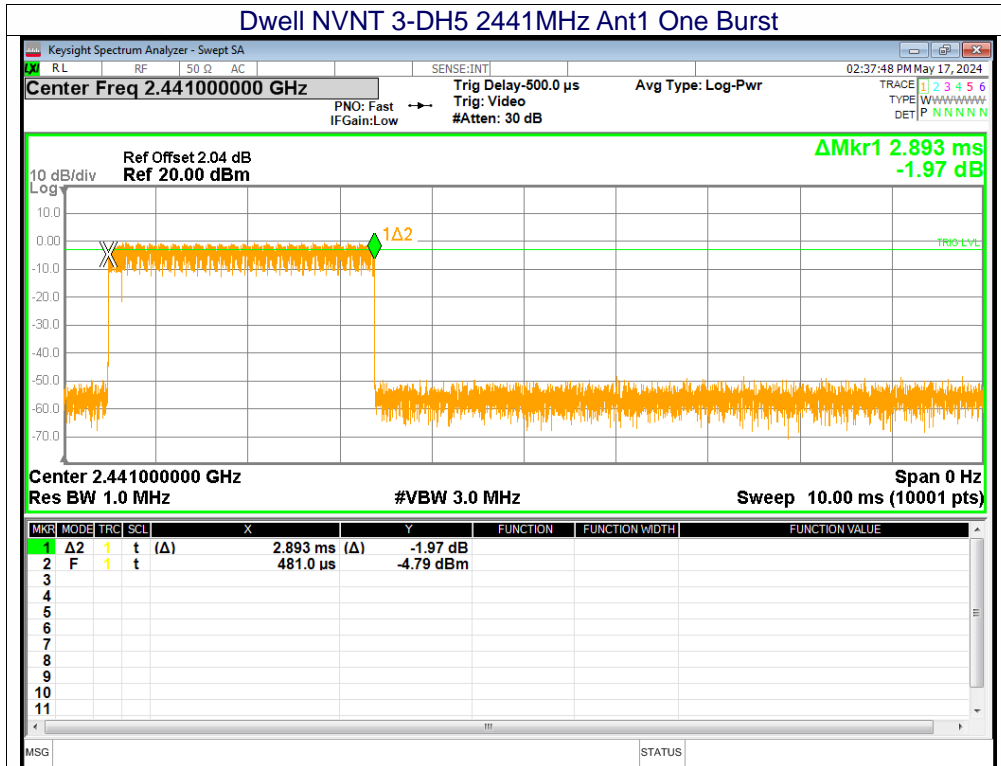



12. Antenna Requirement

Standard requirement:	FCC Part15 C Section 15.203 /247(b)(4), RSS-Gen 6.8
<p>15.203 requirement: An intentional radiator shall be designed to ensure that no antenna other than that furnished by the responsible party shall be used with the device. The use of a permanently attached antenna or of an antenna that uses a unique coupling to the intentional radiator, the manufacturer may design the unit so that a broken antenna can be replaced by the user, but the use of a standard antenna jack or electrical connector is prohibited.</p> <p>15.247(b) (4) requirement: The conducted output power limit specified in paragraph (b) of this section is based on the use of antennas with directional gains that do not exceed 6 dBi. Except as shown in paragraph (c) of this section, if transmitting antennas of directional gain greater than 6 dBi are used, the conducted output power from the intentional radiator shall be reduced below the stated values in paragraphs (b)(1), (b)(2), and (b)(3) of this section, as appropriate, by the amount in dB that the directional gain of the antenna exceeds 6 dBi.</p> <p>The applicant for equipment certification, as per RSP-100, must provide a list of all antenna types that may be used with the licence-exempt transmitter, indicating the maximum permissible antenna gain (in dBi) and the required impedance for each antenna. Licence-exempt transmitters that have received equipment certification may operate with different types of antennas. However, it is not permissible to exceed the maximum equivalent isotropically radiated power (EIRP) limits specified in the applicable standard (RSS) for the licence-exempt apparatus. Testing shall be performed using the highest gain antenna of each combination of licence-exempt transmitter and antenna type, with the transmitter output power set at the maximum level.9 When a measurement at the antenna connector is used to determine RF output power, the effective gain of the device’s antenna shall be stated, based on a measurement or on data from the antenna manufacturer.</p>	
EUT Antenna:	
The antenna is FPC Antenna, the best case gain of the antennas is 5.07dBi, reference to the appendix II for details	



13. Test Setup Photo

Reference to the appendix I for details.

14. EUT Constructional Details

Reference to the appendix II for details.

***** END OF REPORT *****