

FCC TEST REPORT

Report No. : NTC-ER2311068
Applicant's name : ITL intelligence Lighting Technology Co., Ltd
Address : Zhong nan hi-tech6#, Fuan west 1road, Dajiang
Town, Taishan city, jiangmen city, Guangdong, China

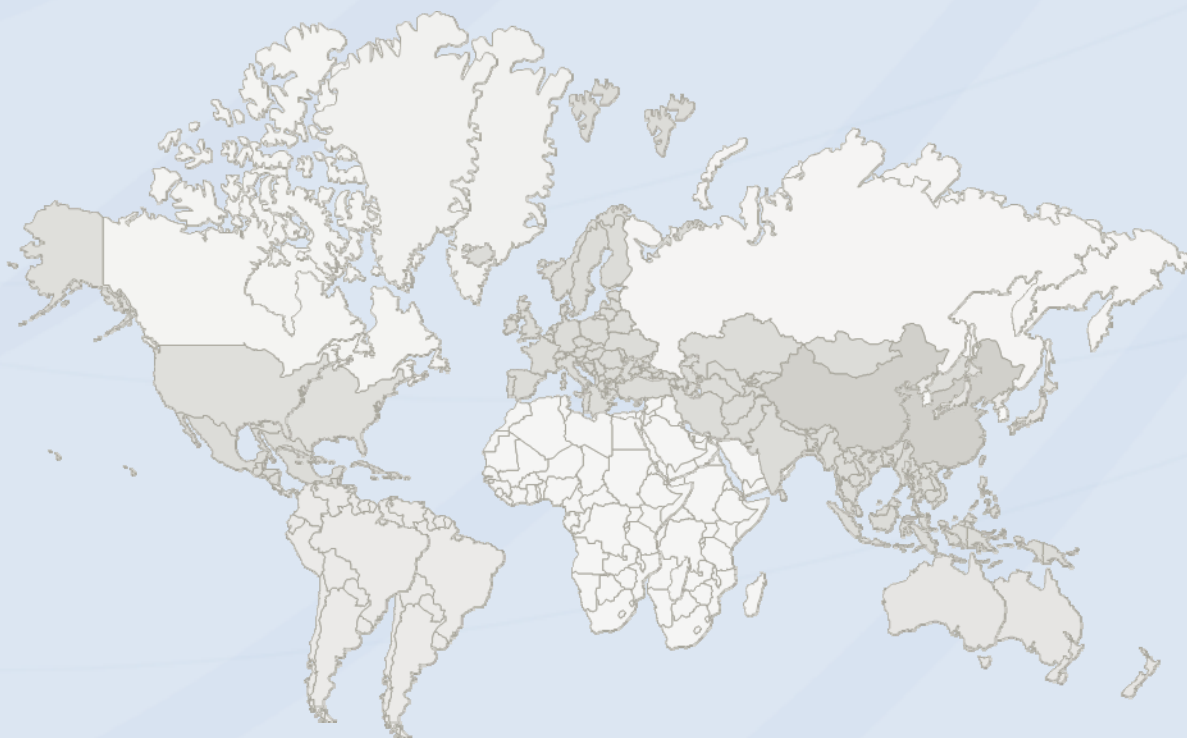

DONGGUAN NEW TESTING CENTRE CO., LTD

Address: 1F & 3F, No. 1 the 1st North Industry Road Songshan Lake Science & Technology Park Dongguan, People's Republic of China 523808

Tel: +86-769-22212079

Web: <http://www.ntc-cert.com>

E-mail: dave@ntc-cert.com

TEST REPORT DECLARE

FCC ID	:	2BB78-ITL-F304C
Applicant	:	ITL intelligence Lighting Technology Co., Ltd
Address	:	Zhong nan hi-tech6#, Fuan west 1road, Dajiang Town, Taishan city, jiangmen city, Guangdong, China
Equipment under Test	:	Remote control
Model/Type reference	:	ITL-F304C
List Model(s)	:	N/A
Trade Mark	:	ITL
Manufacturer	:	ITL intelligence Lighting Technology Co., Ltd
Address	:	Zhong nan hi-tech6#, Fuan west 1road, Dajiang Town, Taishan city, jiangmen city, Guangdong, China
Test Laboratory	:	Dongguan New Testing Centre Co., Ltd
Address	:	1F & 3F, No. 1 the 1st North Industry Road Songshan Lake Science & Technology Park Dongguan, People's Republic of China 523808

Test Standard Used:

FCC Rules and Regulations Part 15 Subpart C 15.231, ANSI C63.10:2020.

We Declare:

The equipment described above is tested by Dongguan New Testing Centre Co., Ltd and in the configuration tested the equipment complied with the standards specified above. The test results are contained in this test report and Dongguan New Testing Centre Co., Ltd is assumed of full responsibility for the accuracy and completeness of these tests.

After test and evaluation, our opinion is that the equipment provided for test compliance with the requirement of the above FCC standards.

Report No.:	NTC-ER2311068		
Date of Test:	Nov. 20, 2023 to Nov. 27, 2023	Date of Report:	Nov. 27, 2023

Prepared By:

Jack Liu

Jack Liu/Engineer



Dave Gao

Dave Gao/LAB Manager

Note: This report applies to above tested sample only. This report shall not be reproduced in parts without written approval of Dongguan New Testing Centre Co., Ltd

Table of Contents

Page

- 1. SUMMARY..... 4**
 - 1.1. TEST STANDARDS.....4
 - 1.2. TEST DESCRIPTION.....4
 - 1.3. TEST FACILITY5
- 2. GENERAL INFORMATION..... 6**
 - 2.1. ENVIRONMENTAL CONDITIONS6
 - 2.2. GENERAL DESCRIPTION OF EUT6
 - 2.3. RELATED SUBMITTAL(S) / GRANT (S)6
 - 2.4. MODIFICATIONS.....6
- 3. TEST CONDITIONS AND RESULTS 8**
 - 3.1. CONDUCTED EMISSION (AC MAIN)8
 - 3.2. RADIATED EMISSION9
 - 3.3. 20dB BANDWIDTH15
 - 3.4. DEACTIVATION TIME16
 - 3.5. ANTENNA REQUIREMENT17
- 4. TEST SETUP PHOTOS OF THE EUT 18**
- 5. EXTERNAL AND INTERNAL PHOTOS OF THE EUT 19**

1. SUMMARY

1.1. Test Standards

The tests were performed according to following standards:

[FCC Rules Part 15.231:](#) Periodic operation in the band 40.66-40.70 MHz and above 70 MHz.

[ANSI C63.10:2020 :](#) American National Standard for Testing Unlicensed Wireless Devices

1.2. Test Description

FCC and IC Requirements		
FCC Part 15.207	Conducted Emission	N/A
FCC Part 15.231(a)(1)	Automatically Deactivate	PASS
FCC Part 15.231(b)	Electric Field Strength of Fundamental Emission	PASS
FCC Part 15.205 & 15.209 & 15.231(b)	Electric Field Strength of Spurious Emission	PASS
FCC Part 15.231(c)	-20dB bandwidth	PASS

Remark: The measurement uncertainty is not included in the test result.

1.3. Test Facility

1.3.1 Statement of the measurement uncertainty

The data and results referenced in this document are true and accurate. The reader is cautioned that there may be errors within the calibration limits of the equipment and facilities. The measurement uncertainty was calculated for all measurements listed in this test report acc. to CISPR 16 - 4 “Specification for radio disturbance and immunity measuring apparatus and methods – Part 4: Uncertainty in EMC Measurements“ and is documented. to DIN EN ISO/IEC 17025. Furthermore, component and process variability of devices similar to that tested may result in additional deviation. The manufacturer has the sole responsibility of continued compliance of the device.

Test Item	Uncertainty
Uncertainty for Conduction emission test	2.44dB
Uncertainty for Radiation Emission test (30MHz – 1GHz)	3.14 dB (Polarize: V)
	3.16 dB (Polarize: H)
Uncertainty for Radiation Emission test (1GHz – 18GHz)	4.27 dB (Polarize: V)
	4.51 dB (Polarize: H)
Uncertainty for conducted RF Power	0.63dB
Stop Transmitting Time Test	±0.5%
Uncertainty for frequency error	5.8 x 10 ⁻⁸

Note: This uncertainty represents an expanded uncertainty expressed at approximately the 95% confidence level using a coverage factor of k=2.

2. GENERAL INFORMATION

2.1. Environmental conditions

During the measurement the environmental conditions were within the listed ranges:

Normal Temperature:	25°C
Relative Humidity:	55 %
Air Pressure:	101 kPa

2.2. General Description of EUT

Product Name:	Remote control
Model/Type reference:	ITL-F304C
Power supply:	DC 12V
Modulation:	ASK
Operation frequency:	304.25MHz
Channel number:	1
Antenna type:	PCB antenna
Antenna gain:	0dBi
Hardware version:	V1.0
Software version:	V1.0

Note: For more details, please refer to the user's manual of the EUT.

2.3. Related Submittal(s) / Grant (s)

This submittal(s) (test report) is intended to comply with Section 15.231 of the FCC Part 15, Subpart C Rules.

2.4. Modifications

No modifications were implemented to meet testing criteria.

2.5. EQUIPMENTS USED DURING THE TEST

Item	Equipment	Manufacturer	Model No.	Serial No.	Last Cal.	Cal. Interval
1	Test Receiver	R&S	ESPI	100146	2023-05-20	1 Year
2	LISN	R&S	ENV216	3650.6550.06	2023-05-19	1 Year
3	LISN	KHC	KH3765	37650053	2023-05-19	1 Year
4	8-WIRE ISN for CAT6	R&S	ENY81-CA6	101862	2023-05-19	1 Year
5	RF Cable	HUBER	SUCOFLEX100	30722/4E	2023-05-19	2 Year
6	EMI Test Receiver	R&S	ESR	7250-304067528	2023-05-20	1 Year
7	Trilog Broadband Antenna	Schwarzbeck	VULB9168	00969	2023-05-22	2 Year
8	Pre-amplifier	R&S	8449B	3008A04721	2023-05-19	1 Year
9	Active Loop antenna	Schwarzbeck	FMZB-1519	1519-038	2023-05-19	1 Year
10	Horn antenna	Schwarzbeck	BBHA9120D	453	2023-05-19	2 Year
11	Double Ridged Horn Antenna	A.H. System	SAS-574	584	2023-05-19	1 Year
12	RF Cable	GORE	OSQ01Q01078.7	SN15458474	2023-05-19	1 Year
13	RF Cable	ESCO	ETS-LINGRE N	RFC-SMS-100-SMS-340-IN	2023-05-19	1 Year
14	Measurement software	Farad	EZ-EMC(VER:1.1.4.2)	N/A	N/A	N/A
15	SIGNAL ANALYZER	KEYSIGHT	N9020A	MY53420939	2023/05/19	1 Year
16	SIGNAL GENERATOR	Agilent	N5182A	MY50141563	2023/05/19	1 Year
17	WIDEBAND RADIO COMMUNICATION TESTER	R&S	CMW500	1201.0002K50	2023/05/19	1 Year
18	POWER SENSOR	Agilent	U2021XA	MY54320040	2023/05/19	1 Year
19	POWER SENSOR	Agilent	U2021XA	MY55060007	2023/05/19	1 Year
20	MEASUREMENT SOFTWARE	MWRFtest	MTS8310	N/A	N/A	N/A

3. TEST CONDITIONS AND RESULTS

3.1. Conducted Emission (AC Main)

LIMIT

FCC CFR Title 47 Part 15 Subpart C Section 15.207

Frequency range (MHz)	Limit (dBuV)	
	Quasi-peak	Average
0.15-0.5	66 to 56*	56 to 46*
0.5-5	56	46
5-30	60	50

* Decreases with the logarithm of the frequency.

TEST PROCEDURE

1. The equipment was set up as per the test configuration to simulate typical actual usage per the user's manual. The EUT is a flood stand system; a wooden table with a height of 0.1 meters is used and is placed on the ground plane as per ANSI C63.10-2020.
2. Support equipment, if needed, was placed as per ANSI C63.10-2020
3. All I/O cables were positioned to simulate typical actual usage as per ANSI C63.10-2020
4. If a EUT received DC power from the USB Port of Notebook PC, the PC's adapter received AC120V/60Hz power through a Line Impedance Stabilization Network (LISN) which supplied power source and was grounded to the ground plane.
5. All support equipments received AC power from a second LISN, if any.
6. The EUT test program was started. Emissions were measured on each current carrying line of the EUT using a spectrum Analyzer / Receiver connected to the LISN powering the EUT. The LISN has two monitoring points: Line 1 (Hot Side) and Line 2 (Neutral Side). Two scans were taken: one with Line 1 connected to Analyzer / Receiver and Line 2 connected to a 50 ohm load; the second scan had Line 1 connected to a 50 ohm load and Line 2 connected to the Analyzer / Receiver.
7. Analyzer / Receiver scanned from 150 KHz to 30MHz for emissions in each of the test modes.
8. During the above scans, the emissions were maximized by cable manipulation.

TEST RESULTS

Not applicable for device which is battery supply.

3.2. Radiated Emission

Limit

For intentional device, according to 15.209(a) the general requirement of field strength of radiated emission from intentional radiators at a distance of 3 meters shall not exceed the following table.

Frequency (MHz)	Distance (Meters)	Radiated (dB μ V/m)	Radiated (μ V/m)
0.009-0.49	3	$20\log(2400/F(\text{KHz}))+40\log(300/3)$	$2400/F(\text{KHz})$
0.49-1.705	3	$20\log(24000/F(\text{KHz}))+40\log(30/3)$	$24000/F(\text{KHz})$
1.705-30	3	$20\log(30)+40\log(30/3)$	30
30-88	3	40.0	100
88-216	3	43.5	150
216-960	3	46.0	200
Above 960	3	54.0	500

In addition to the provisions of 15.231(b) and RSS 210-A1.1.2, the field strength of emissions from intentional radiators operated under this section shall not exceed the following:

Fundamental frequency (MHz)	Field strength of fundamental (microvolts/meter)	Field strength of spurious emissions (microvolts/meter)
40.66-40.70	2,250	225
70-130	1,250	125
130-174	¹ 1,250 to 3,750	¹ 125 to 375
174-260	3,750	375
260-470	¹ 3,750 to 12,500	¹ 375 to 1,250
Above 470	12,500	1,250

¹ Linear interpolations.

[Where F is the frequency in MHz, the formulas for calculating the maximum permitted fundamental field strengths are as follows: for the band 260-470 MHz, μ V/m at 3 meters = $41.6667(F) - 7083.3333$. The maximum permitted unwanted emission level is 20 dB below the maximum permitted fundamental level.]

TEST CONFIGURATION

(A) Radiated Emission Test Set-Up, Frequency Below 30MHz

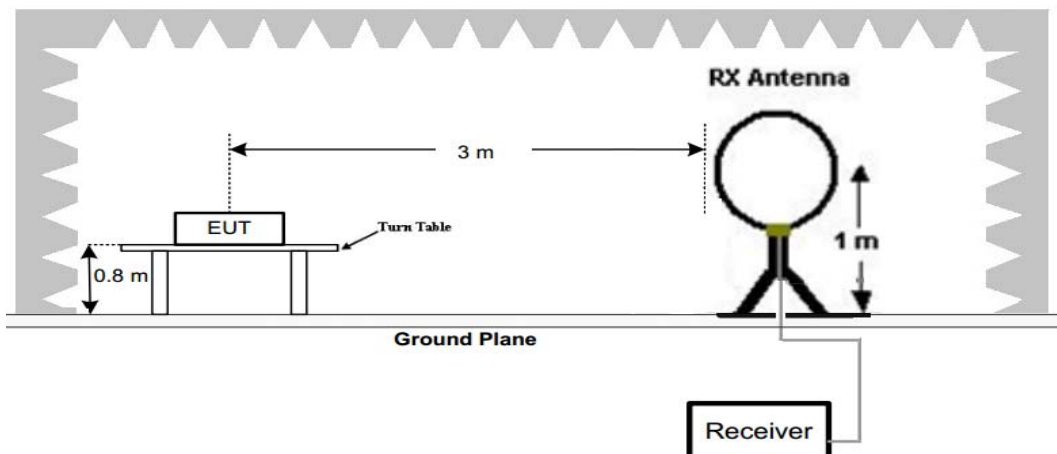

(B) Radiated Emission Test Set-Up, Frequency below 1000MHz

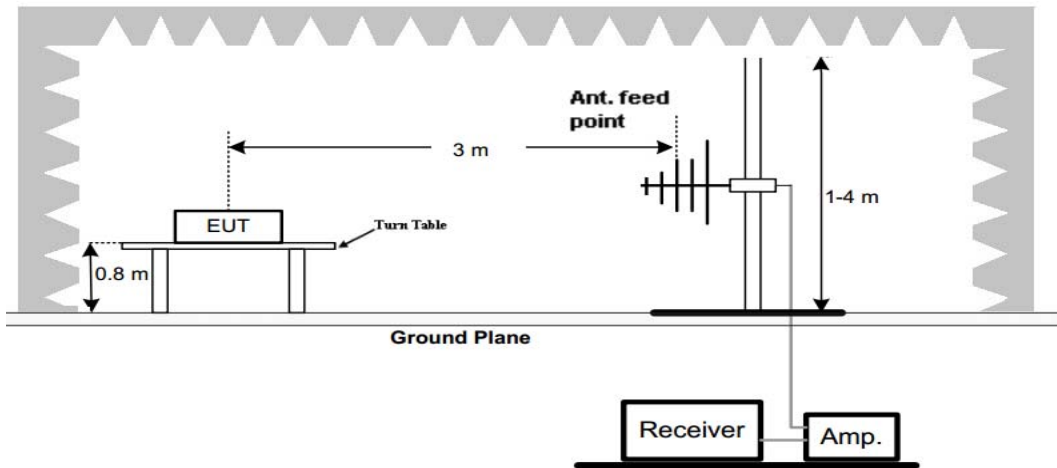

(C) Radiated Emission Test Set-Up, Frequency above 1000MHz

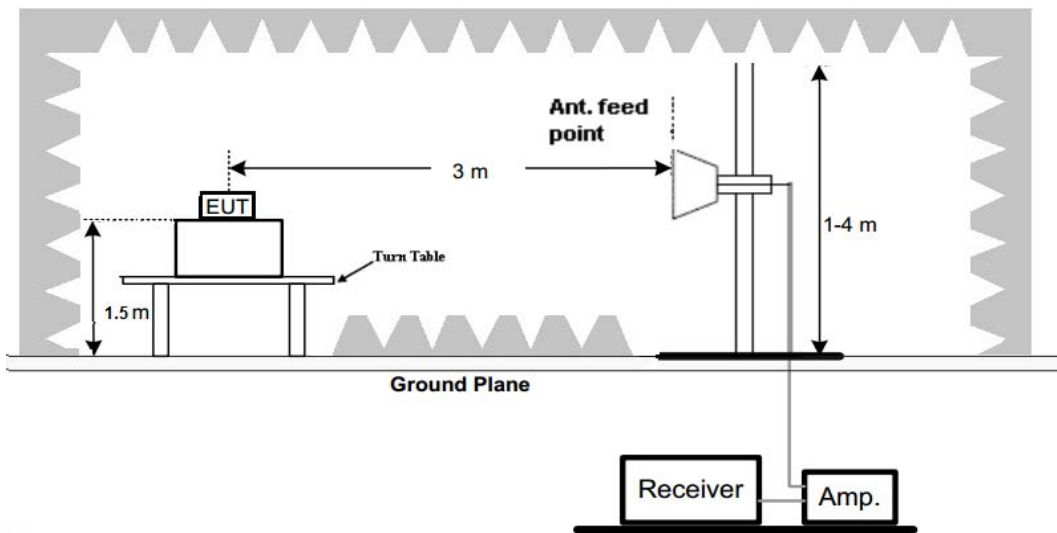

Test Procedure

1. Below 1GHz measurement the EUT is placed on a turntable which is 0.8m above ground plane, and above 1GHz measurement EUT was placed on a low permittivity and low loss tangent turn table which is 1.5m above ground plane.
2. Maximum procedure was performed by raising the receiving antenna from 1m to 4m and rotating the turn table from 0° to 360° to acquire the highest emissions from EUT
3. And also, each emission was to be maximized by changing the polarization of receiving antenna both horizontal and vertical.
4. Repeat above procedures until all frequency measurements have been completed.
5. Radiated emission test frequency band from 9KHz to 5GHz.

TEST RESULTS

The emissions from 30MHz to 5GHz are measured peak and average level, below 1 GHz measured QP level, detailed test data please see below. Besides, we tested 3 directions and recorded the worst data.

Emission Styles	Frequency (MHz)	Reading Level(dBuV)	Correct Factor(dB)	Level (dBuV/m)	Limit (dBuV/m)	Margin (dB)	Detector	Direction (H/V)
Fundamental	304.25	83.07	-9.34	73.73	100.82	-27.09	PK	H
Fundamental	304.25	--	--	65.45	80.82	-15.37	AV	H
Harmonics	608.50	55.53	-2.81	52.72	80.82	-28.10	PK	H
Harmonics	608.50	--	--	44.44	60.82	-16.38	AV	H
Harmonics	912.75	49.51	-11.62	37.89	80.82	-42.93	PK	H
Harmonics	912.75	--	--	29.61	60.82	-31.21	AV	H
--	--	--	--	--	--	--	--	--
Fundamental	304.25	84.96	-9.34	75.62	100.82	-25.20	PK	V
Fundamental	304.25	--	--	67.34	80.82	-13.48	AV	V
Harmonics	608.50	56.02	-2.81	53.21	80.82	-27.61	PK	V
Harmonics	608.50	--	--	44.93	60.82	-15.89	AV	V
Harmonics	912.75	51.17	-11.62	39.55	80.82	-41.27	PK	V
Harmonics	912.75	--	--	31.27	60.82	-29.55	AV	V
--	--	--	--	--	--	--	--	--

Note:

1. All Readings are Peak Value
2. Correct Factor= Antenna Factor +Cable Loss- Amplifier Gain
3. Emission Level= Reading Level+Probe Factor +Cable Loss
4. AV Level (dBuV/m)= PK Level (dBuV/m)+ AV Factor(dB)
5. Margin = TrueValue – limit(if margin is minus means under limit)
6. In a transmit cycle 35.80 ms period found 0.780 ms burst 10 pcs, 0.400 ms burs 15 pcs, the Duty Cycle can calculate as below:

$$\text{Duty Cycle} = (0.780 * 10 + 0.400 * 15) / 35.80 = 0.3854$$

$$\text{AV Factor} = 20 * \log(\text{Duty Cycle}) = 20 * \log(0.3854) = -8.28$$

(The plot of Duty Cycle See the follow page)

7. All the x/y/z orientation has been investigated, and only worst case is presented in this report,

New battery is used during all test.

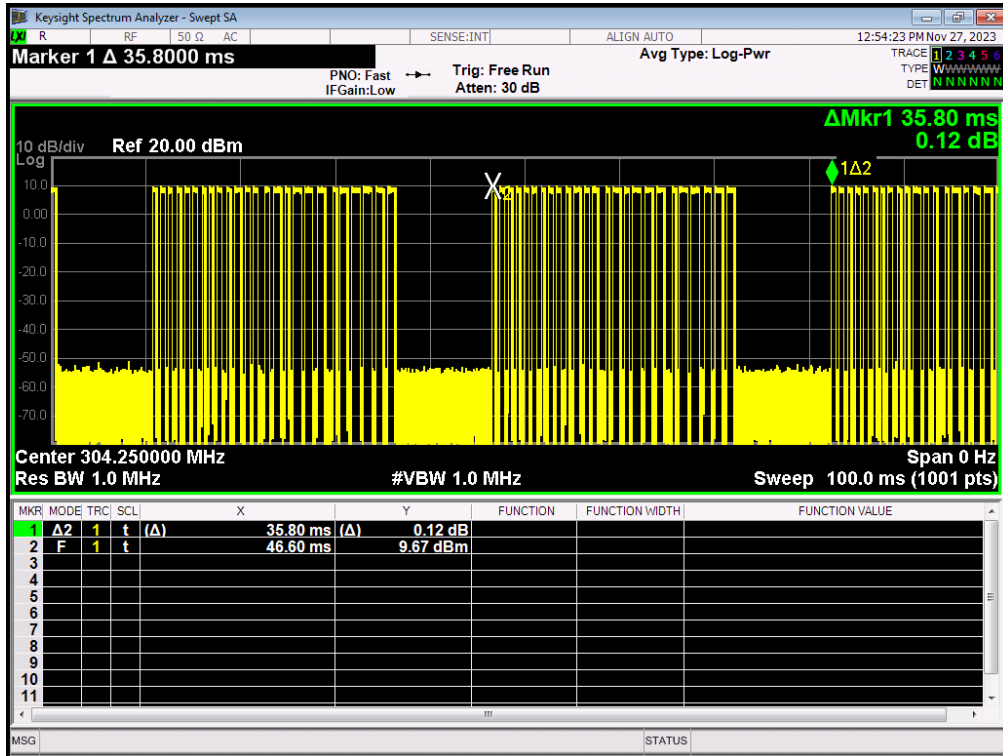

(Transmit cycle 35.8ms)

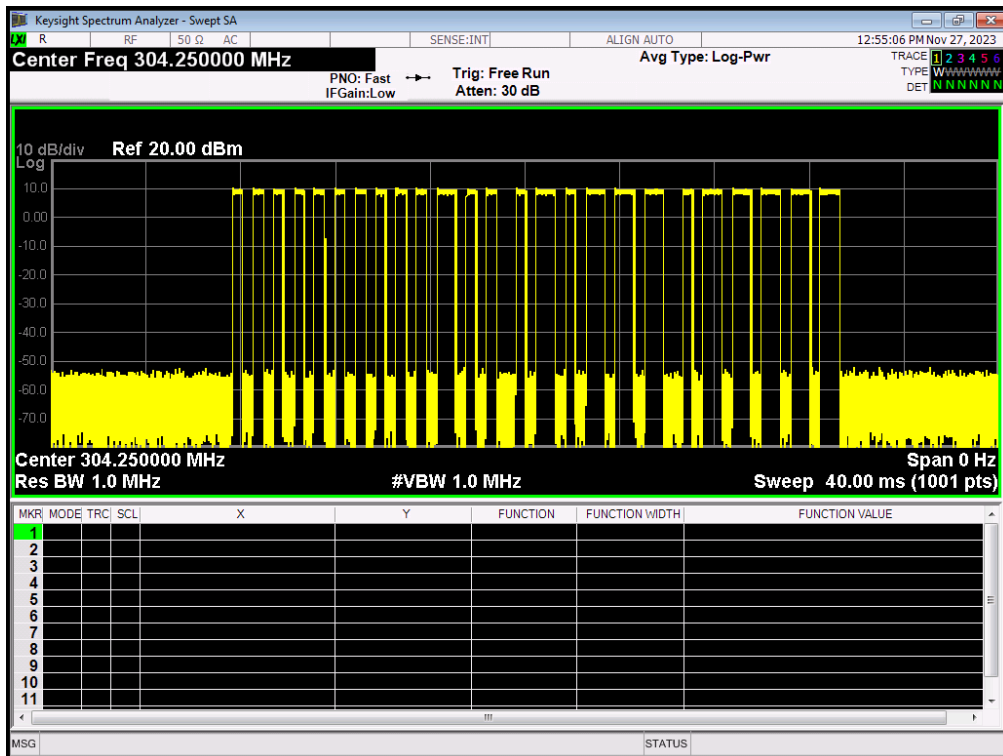

(Total Bursts in a transmit cycle 25 pcs)

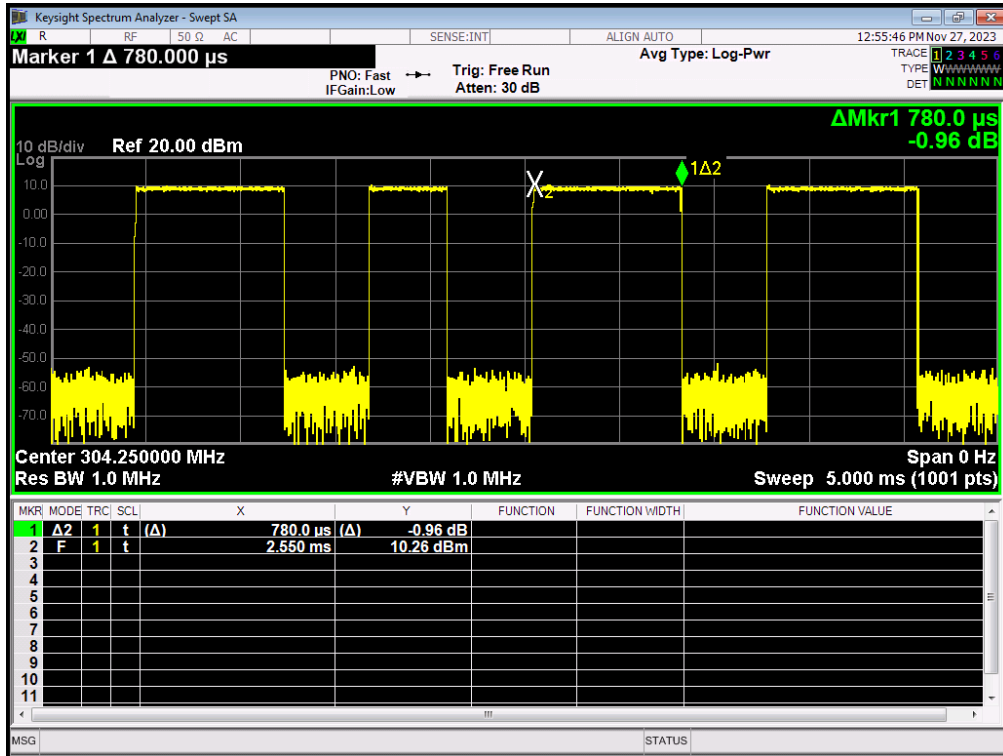

(0.780ms burst 10 pcs)

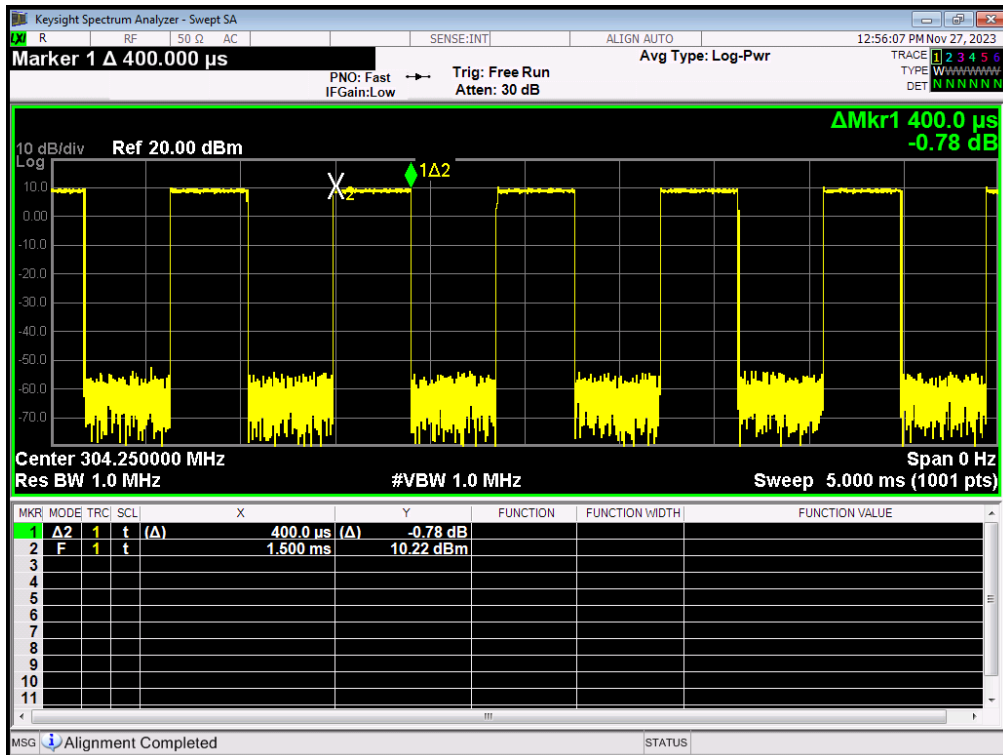

(0.400ms burst 15 pcs)

3.3. 20dB Bandwidth

Limit

According to 47 CFR 15.231(c) The bandwidth of the emission shall be no wider than 0.25% of the centre frequency for devices operating above 70MHz and below 900MHz. Bandwidth is determined at the points 20dB down from the modulated carrier.

Test Configuration

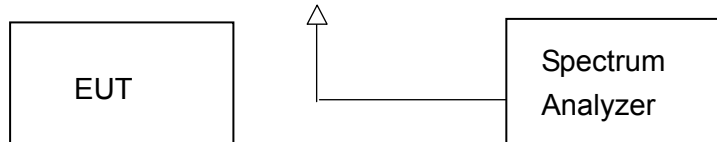

Test Procedure

The 20dB bandwidth and 99% bandwidth is measured with a spectrum analyzer connected via a receive antenna placed near the EUT while the EUT is operating in transmission mode.

The 20dB bandwidth is defined as the total spectrum the power of which is higher than peak power minus 20dB.

The occupied bandwidth (OBW), that is the frequency bandwidth such that, below its lower and above its upper frequency limits, the mean powers radiated are each equal to 0.5 percent of the total mean power radiated by a given emission.

Test Results

Modulation	Channel Frequency (MHz)	99% OBW (KHz)	20dB bandwidth (KHz)	Limit (KHz)	Result
ASK	304.25	403.36	30.73	$0.25\% * 304.25 = 760.625$	Pass

Test plot as follows:

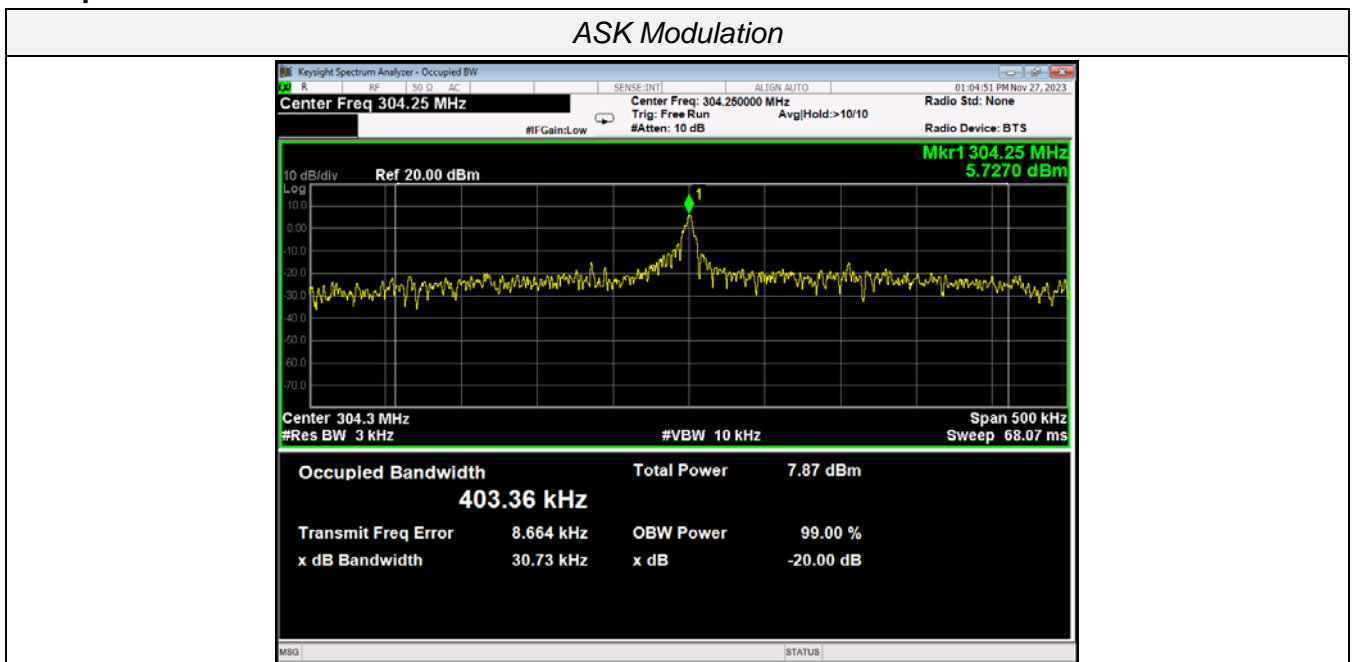

3.4. Deactivation Time

Limit

According to FCC §15.231(a)(1), A manually operated transmitter shall employ a switch that will automatically deactivate the transmitter within not more than 5 seconds of being released.

Test Configuration

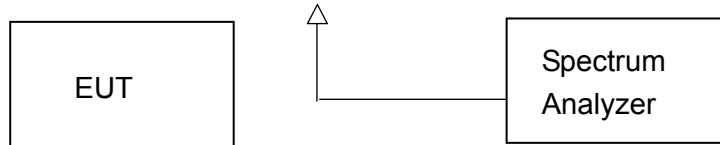

Test Procedure

1. The EUT was placed on a wooded table which is 0.8m height and close to receiver antenna of spectrum analyzer.
2. The spectrum analyzer resolution bandwidth was set to 1 MHz and video bandwidth was set to 1 MHz to encompass all significant spectral components during the test. The spectrum analyzer was operated in linear scale and zero span mode after tuning to the transmitter carrier frequency.

TEST RESULTS

Note: The transmitter was automatically activated, and the carrier frequency 304.25MHz:

Frequency (MHz)	One transmission time (S)	Limit(S)	Result
304.25	0.250	5	Pass

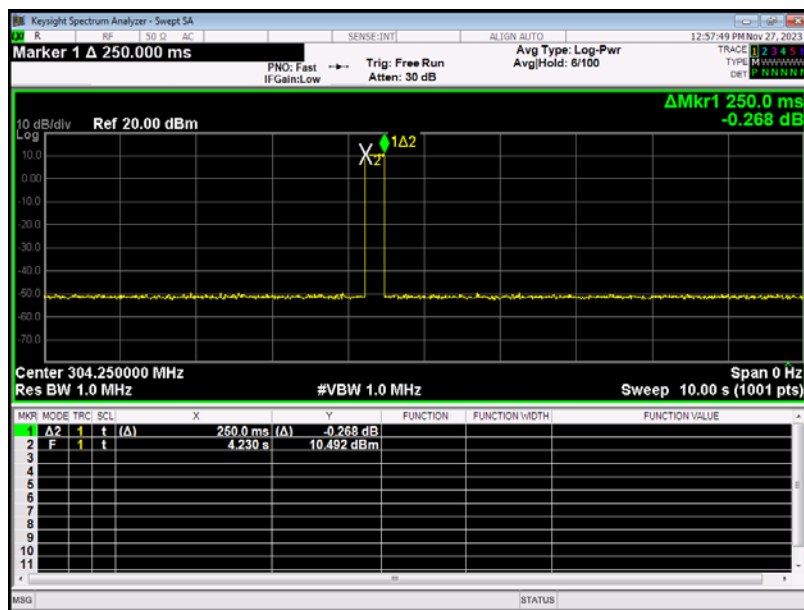

3.5. Antenna Requirement

Standard Applicable

According to FCC Part 15C 15.203

- a) An intentional radiator shall be de-signed to ensure that no antenna other than that furnished by the responsible party shall be used with the device.
- b) The manufacturer may design the unit so that a broken antenna can be replaced by the user, but the use of a standard antenna jack or electrical connector is prohibited.

Refer to statement below for compliance.

The manufacturer may design the unit so that the user can replace a broken antenna, but the use of a standard antenna jack or electrical connector is prohibited. Further, this requirement does not apply to intentional radiators that must be professionally installed.

Antenna Connected Construction

The antenna used in this product is an internal Antenna, The directional gains of antenna used for transmitting is 0 dBi.

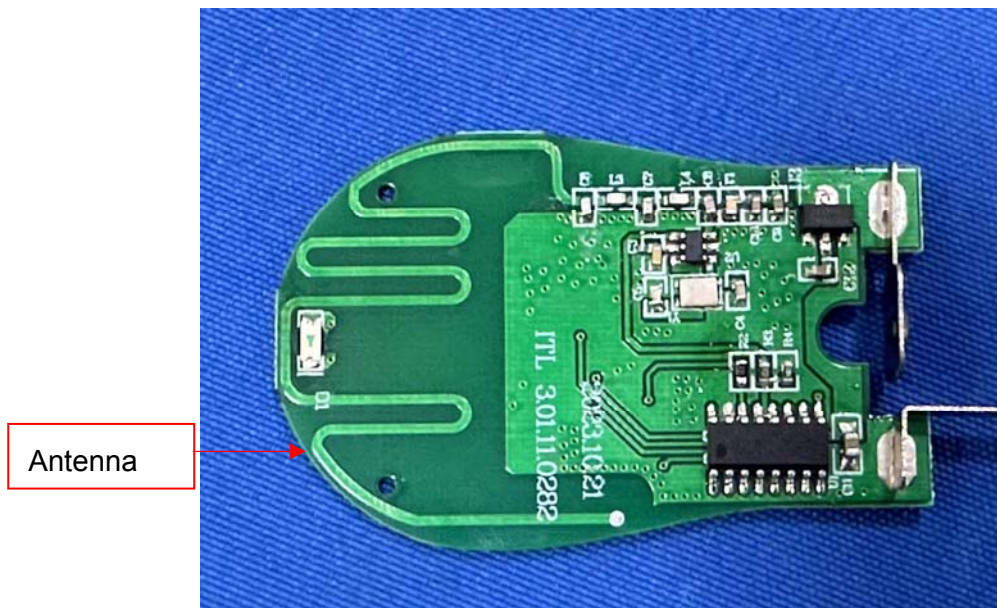

4. Test Setup Photos of the EUT



5. External and Internal Photos of the EUT

External Photos of EUT







Internal Photos of EUT

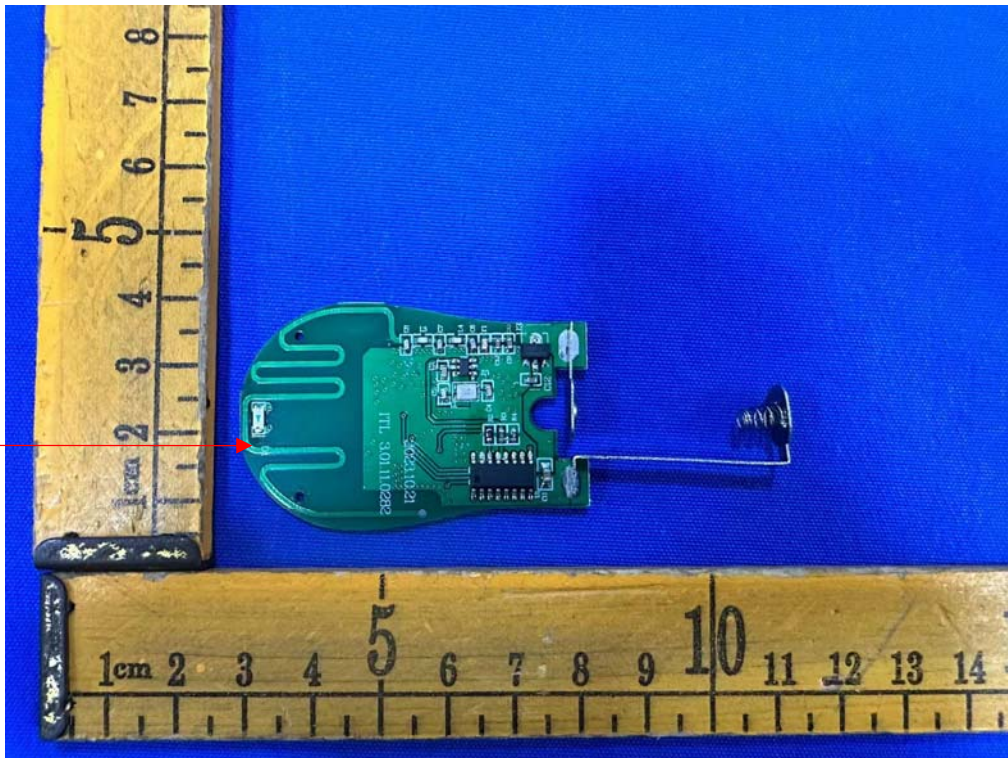
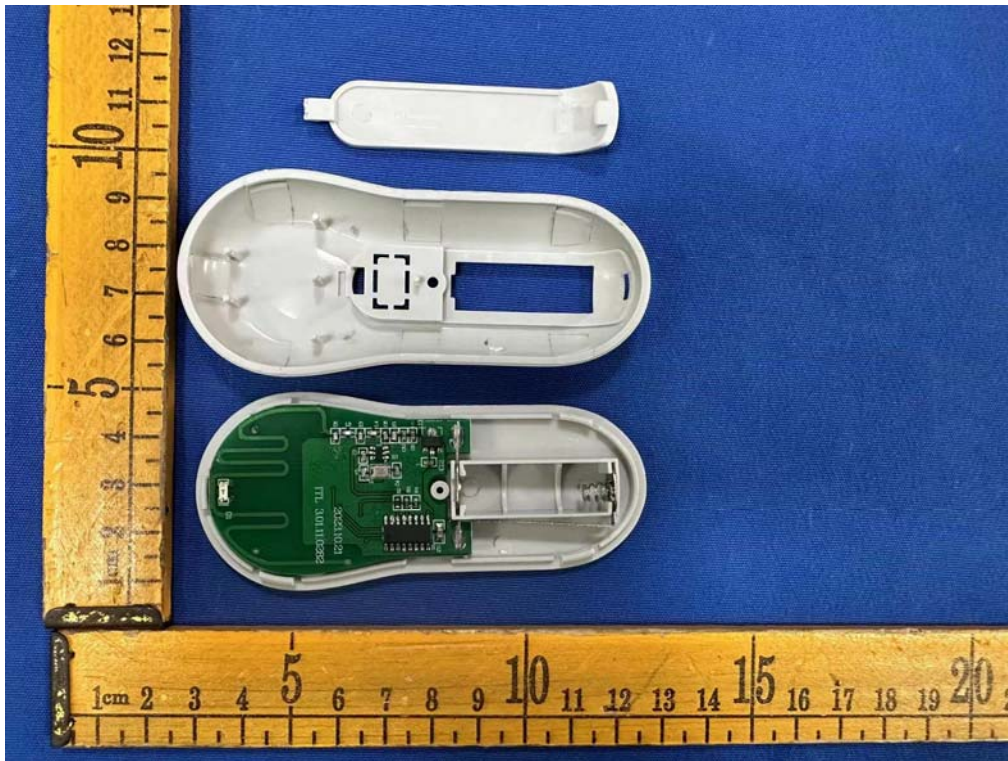

Antenna

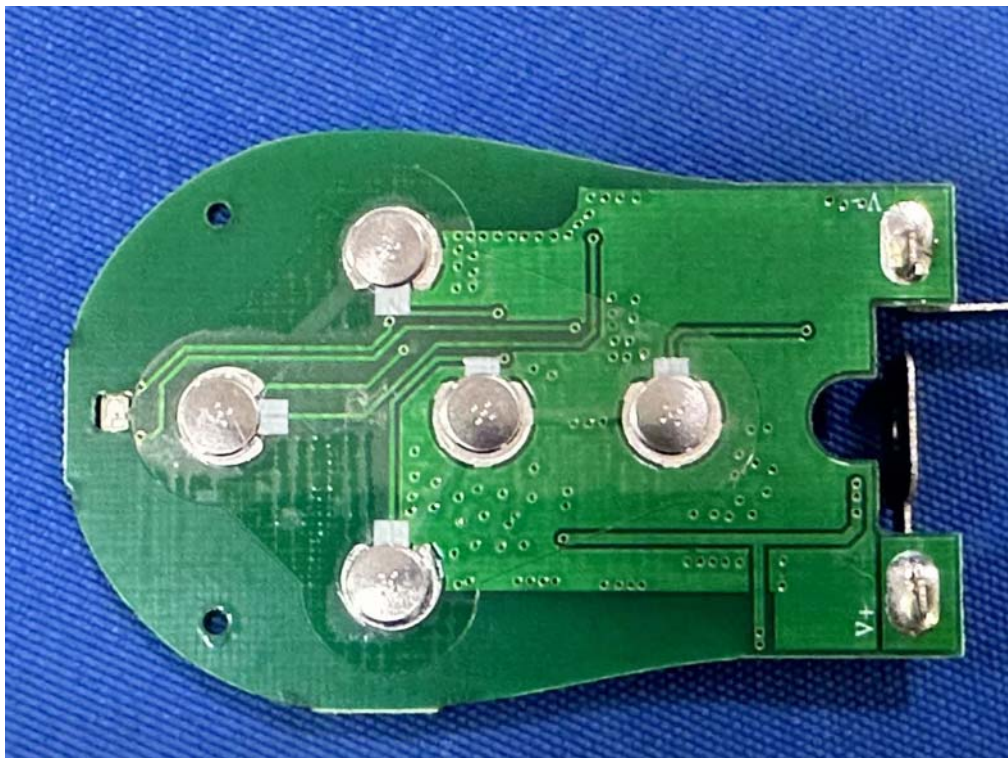
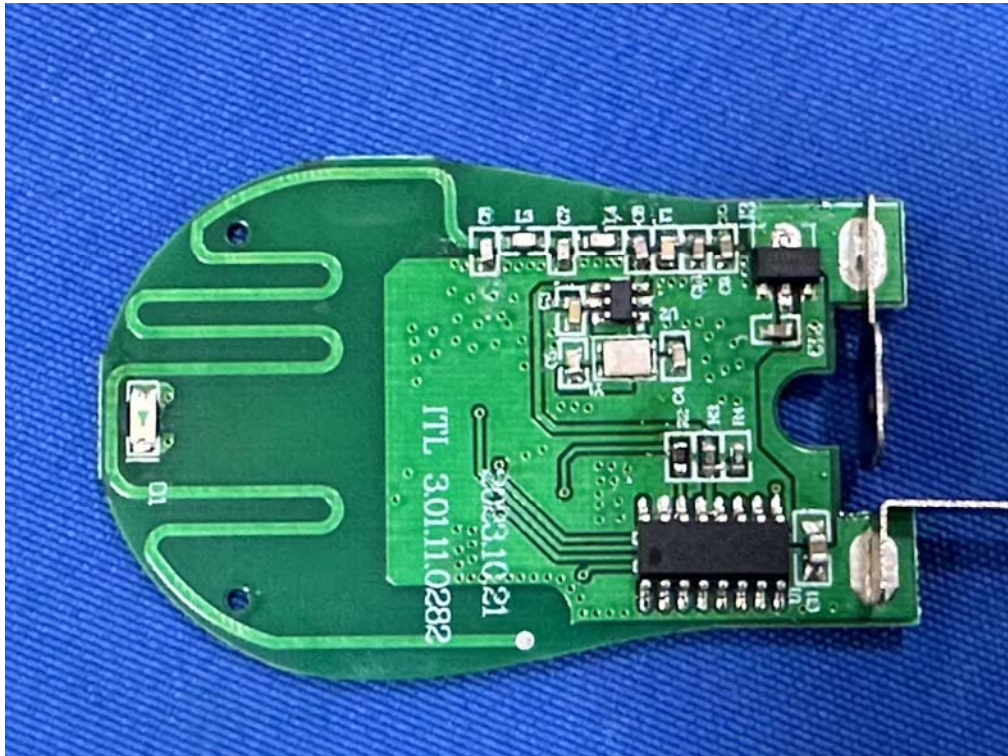

***** End of Report *****