

PBX5016DA02 Specification

Operating Temp. : -40°C~+85°C

1. FEATURES:

- Light weight, compact
- Wide bandwidth, low cost
- Built-in antenna with high gain

2. APPLICATIONS:

- Bluetooth, Wireless LAN, Mobile TV
- Home RF system, etc

3. PRODUCT IDENTIFICATION

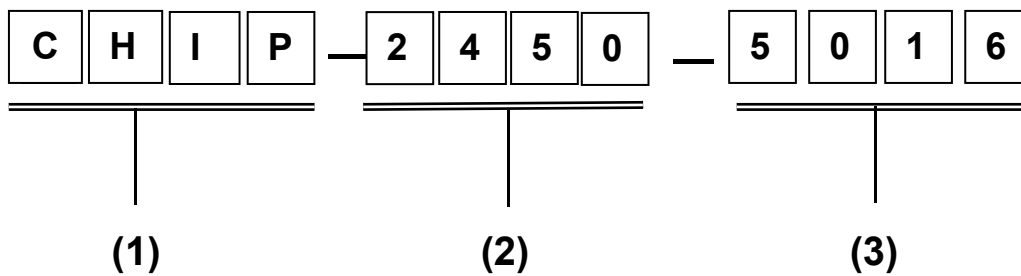

- (1) Product type: Multilayer chip Antenna
 (2) Center Frequency: 2450MHz
 (3) External Dimensions (L×W) (mm): 5.0*1.6

4. SHAPE AND DIMENSIONS:

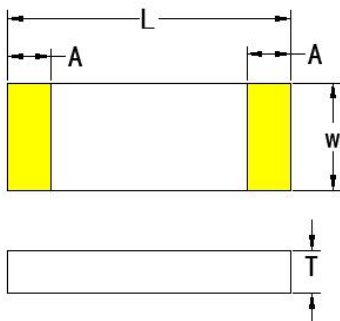

Unit:mm	L	W	A	T
CHIP-5016	5.0±0.1	1.6±0.1	0.45±0.1	0.85±0.1

UNLESS OTHER SPECIFIED TOLERANCES ON:

X=± X.X=± X.XX=±
 ANGLES = ± HOLE DIA = ±



深圳市朋伴兴业科技有限公司

SCALE: N/A

UNIT: mm

DRAWN BY : Sera

CHECKED BY: XD

DESIGNED BY: Sera

APPROVED BY: XD

DOCUMENT NO.

PBX5016DA02

SPEC REV. P1

TITLE: CHIP 2450-5016

测试板参考尺寸:

单位: mm

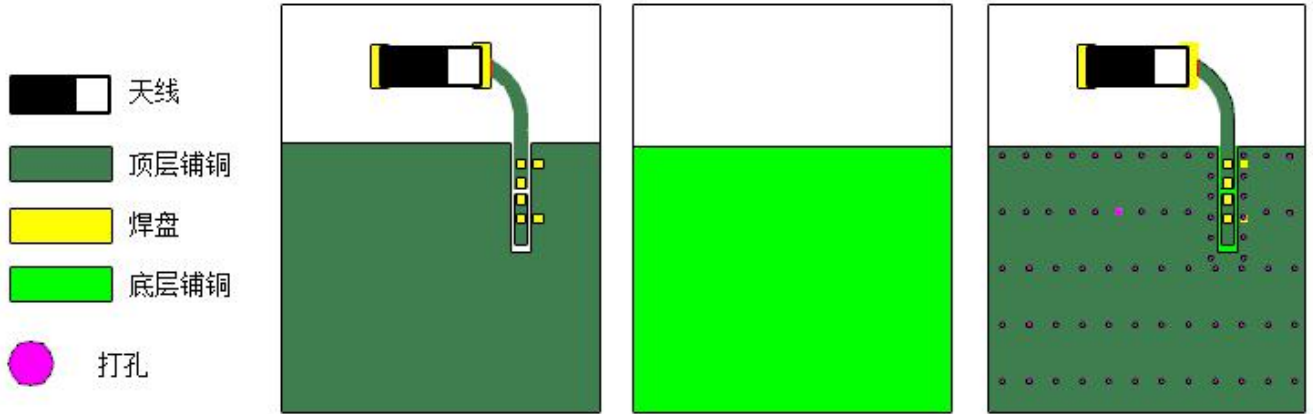

CHIP2450-5016 焊盘尺寸:

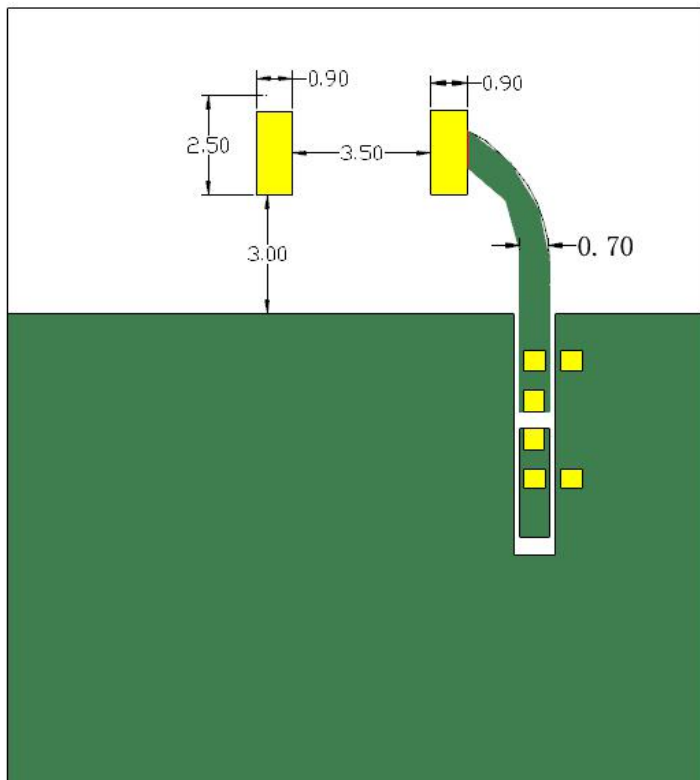

UNLESS OTHER SPECIFIED TOLERANCES ON:

X=± X.X=± X.XX=
 ANGLES = ± HOLE DIA = ±



深圳市朋伴兴业科技有限公司

SCALE: N/A
 DRAWN BY: Sera
 DESIGNED BY: Sera

UNIT: mm
 CHECKED BY: XD
 APPROVED BY: XD

THIS DRAWINGS AND SPECIFICATIONS ARE THE PROPERTY OF HONMAX TECHNOLOGY Limited AND SHALL NOT BE REPRODUCED OR USED AS THE BASIS FOR THE MANUFACTURE OR SALE OF APPARATUS OR DEVICES WITHOUT PERMISSION

TITLE: CHIP 2450-5016

DOCUMENT NO.

PBX5016DA02

SPEC REV. P1

APPLICATION GUIDE

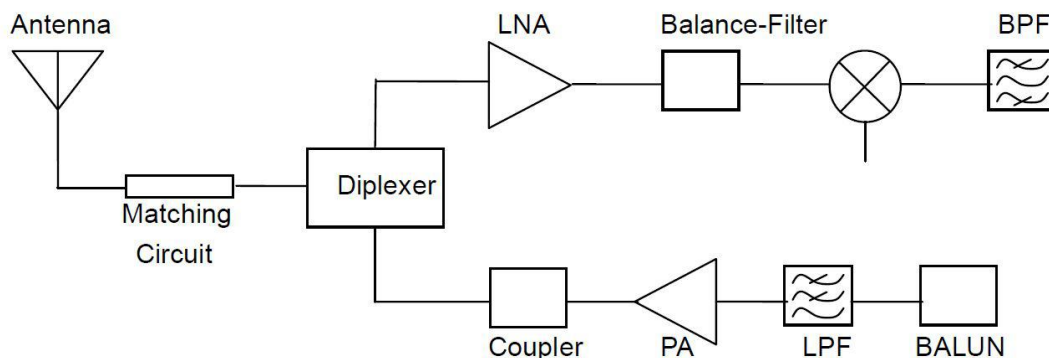

5. SPECIFICATIONS:

测试项目	结果
应用频段	2400-2500MHz
极化方式	线极化
*最大增益	2.73dBi
*效率	67.16%
输入阻抗	50Ω
最大功率	5W

* Test condition: Test board size 86*50 mm
 Matching circuit: Pi matching circuit will be required

6. Electrical Characteristics :

回波损耗

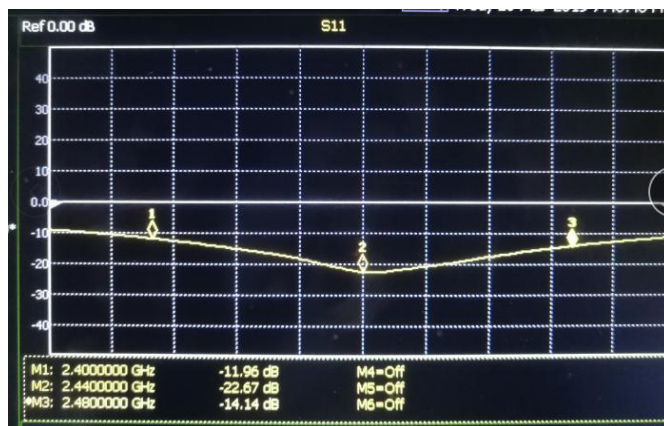

UNLESS OTHER SPECIFIED TOLERANCES ON:
 X=± X.X=± X.XX=
 ANGLES = ± HOLE DIA = ±



深圳市朋伴兴业科技有限公司

SCALE: N/A
 DRAWN BY : Sera
 DESIGNED BY: Sera

UNIT: mm
 CHECKED BY: XD
 APPROVED BY: XD

THIS DRAWINGS AND SPECIFICATIONS ARE THE PROPERTY OF HONMAX TECHNOLOGY Limited AND SHALL NOT BE REPRODUCED OR USED AS THE BASIS FOR THE MANUFACTURE OR SALE OF APPARATUS OR DEVICES WITHOUT PERMISSION

TITLE: CHIP 2450-5016

DOCUMENT NO.

PBX5016DA02

SPEC REV. P1



驻波比

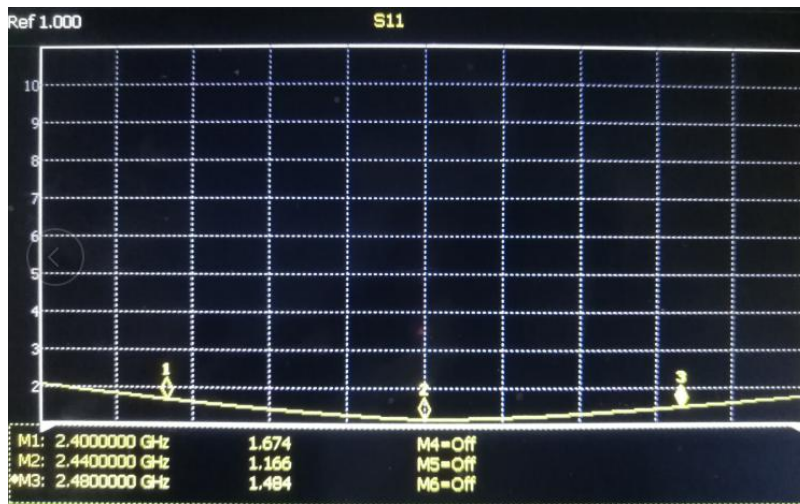

Mark	Frequency	VSWR
1	2400 MHz	1.674
2	2440 MHz	1.166
3	2480 MHz	1.484

UNLESS OTHER SPECIFIED TOLERANCES ON:
 X=± X.X=± X.XX=
 ANGLES = ± HOLE DIA = ±



深圳市朋伴兴业科技有限公司

SCALE: N/A

UNIT: mm

THIS DRAWINGS AND SPECIFICATIONS ARE THE PROPERTY OF HONMAX TECHNOLOGY Limited AND SHALL NOT BE REPRODUCED OR USED AS THE BASIS FOR THE MANUFACTURE OR SALE OF APPARATUS OR DEVICES WITHOUT PERMISSION

DRAWN BY : Sera

CHECKED BY: XD

DESIGNED BY: Sera

APPROVED BY: XD

TITLE: CHIP 2450-5016

DOCUMENT NO.

PBX5016DA02

SPEC REV. P1

Radiation Pattern

The Gain pattern is measured in FAR-field chamber. DUT is placed on the table of rotator, a standard horn antenna and Vector Network Analyzer is used to collect data.

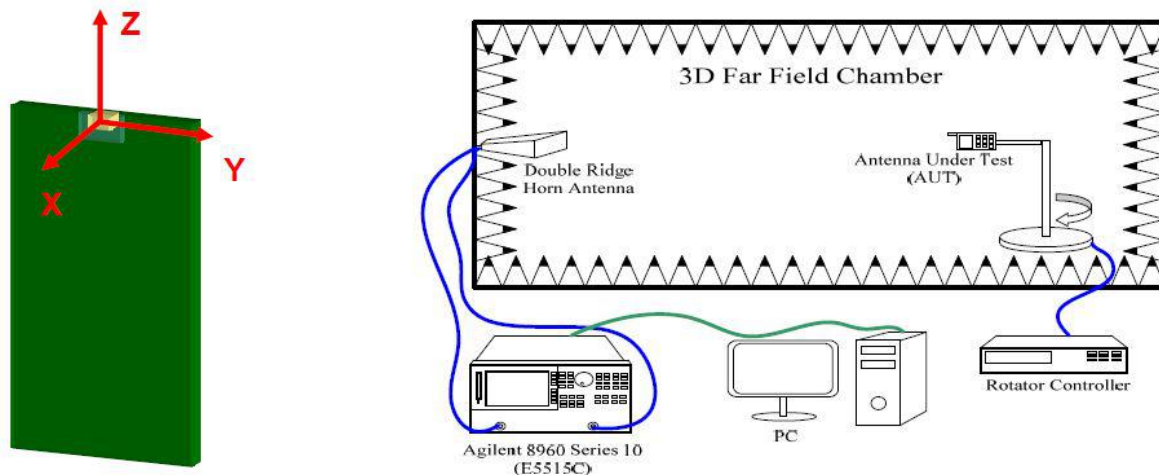

◎ 效率

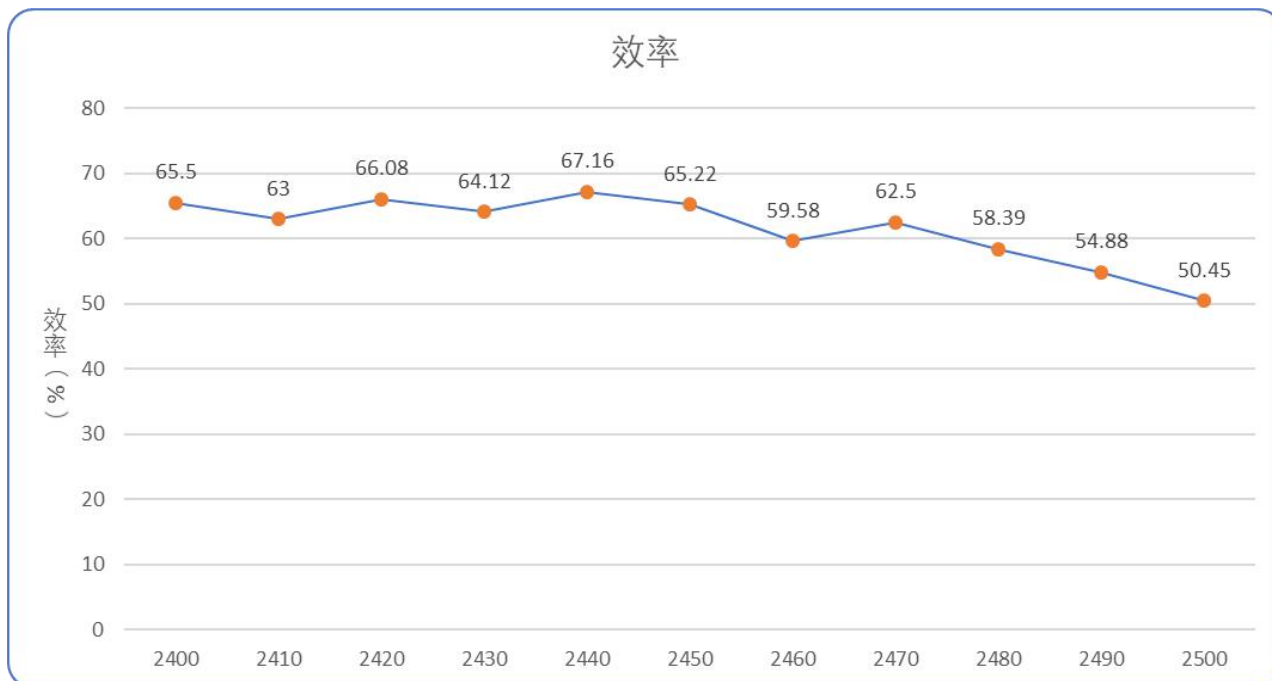

UNLESS OTHER SPECIFIED TOLERANCES ON: X=± X.X=± X.XX= ANGLES = ± HOLE DIA = ±		 深圳市朋伴兴业科技有限公司
SCALE: N/A	UNIT: mm	
DRAWN BY: Sera	CHECKED BY: XD	THIS DRAWINGS AND SPECIFICATIONS ARE THE PROPERTY OF HONMAX TECHNOLOGY Limited AND SHALL NOT BE REPRODUCED OR USED AS THE BASIS FOR THE MANUFACTURE OR SALE OF APPARATUS OR DEVICES WITHOUT PERMISSION
DESIGNED BY: Sera	APPROVED BY: XD	
TITLE: CHIP 2450-5016	DOCUMENT NO.	PBX5016DA02
		SPEC REV. P1

◎ 最大增益

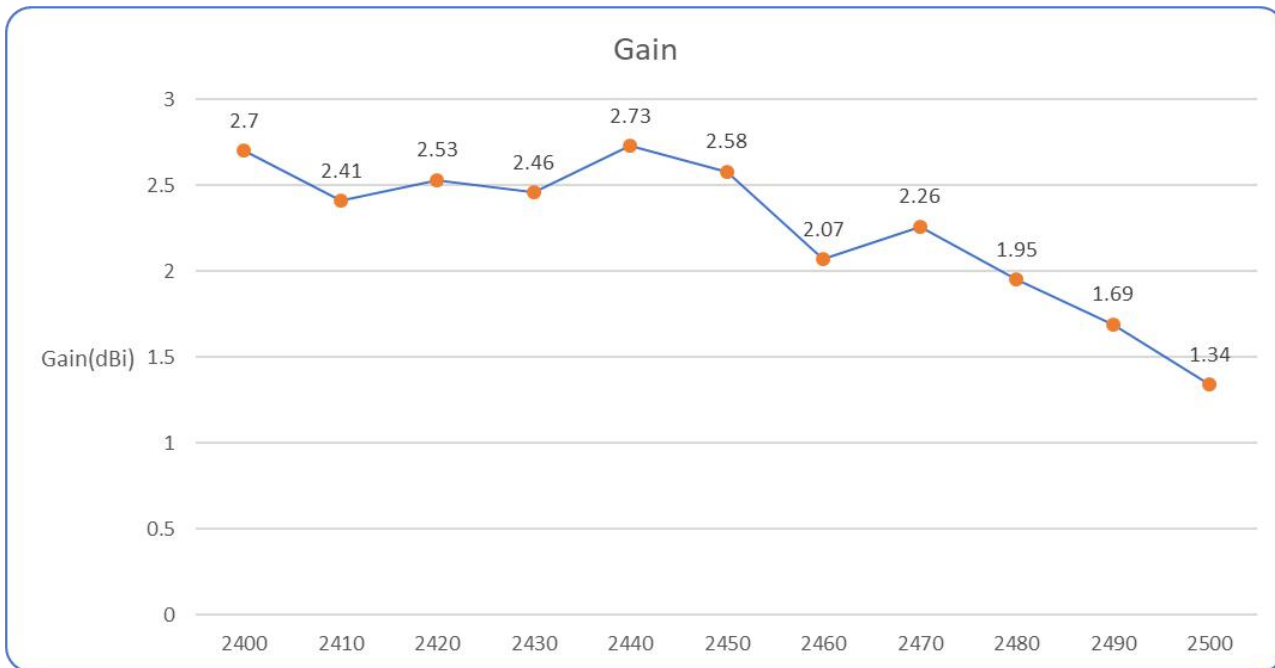

◎ 3D Gain Pattern (2400 MHz)

2400.000MHz

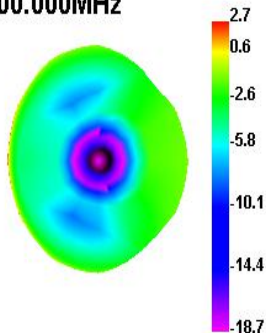

2400.000MHz H

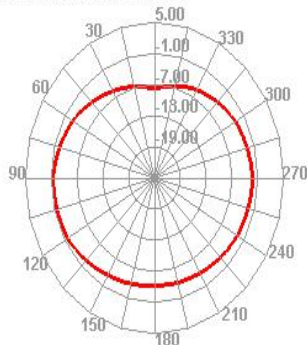

2400.000MHz E1

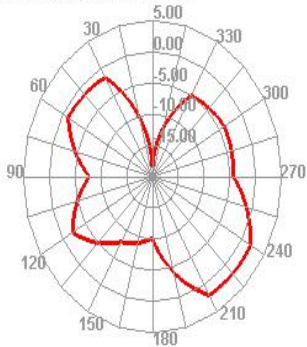

2400.000MHz E2

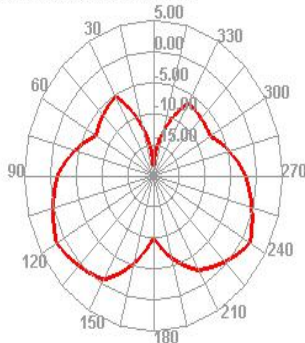

UNLESS OTHER SPECIFIED TOLERANCES ON:

X=± X.X=± X.XX=
 ANGLES = ± HOLE DIA = ±



深圳市朋伴兴业科技有限公司

SCALE: N/A

UNIT: mm

DRAWN BY : Sera

CHECKED BY: XD

DESIGNED BY: Sera

APPROVED BY: XD

THIS DRAWINGS AND SPECIFICATIONS ARE THE PROPERTY OF HONMAX TECHNOLOGY Limited AND SHALL NOT BE REPRODUCED OR USED AS THE BASIS FOR THE MANUFACTURE OR SALE OF APPARATUS OR DEVICES WITHOUT PERMISSION

TITLE: CHIP 2450-5016

DOCUMENT NO.

PBX5016DA02

SPEC REV. P1

◎ 3D Gain Pattern (2450 MHz)

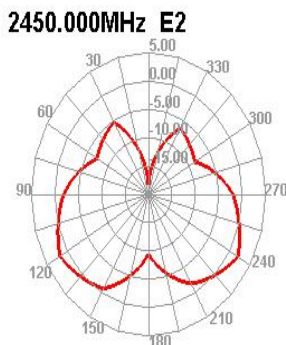
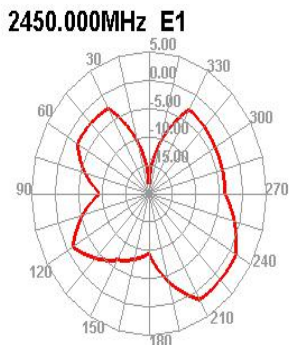
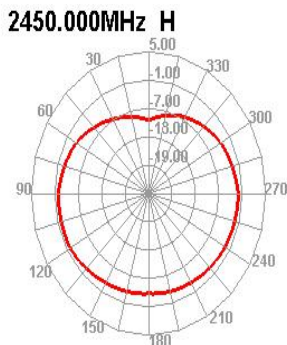
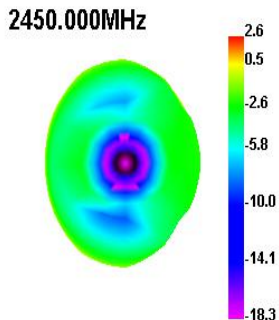

◎ 3D Gain Pattern (2500 MHz)

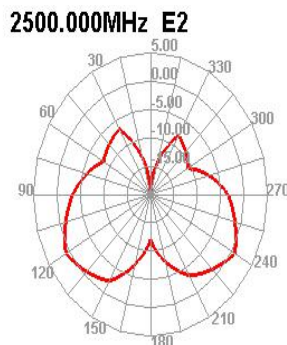
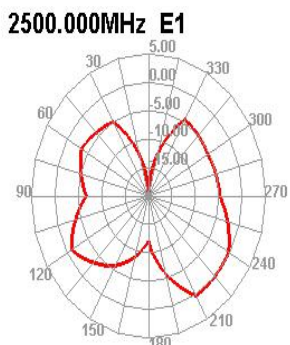
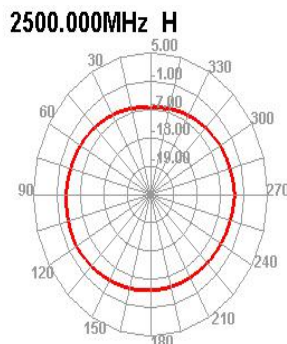
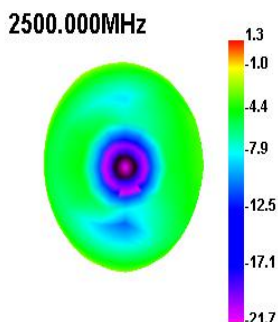

UNLESS OTHER SPECIFIED TOLERANCES ON:
 X=± X.X=± X.XX=
 ANGLES = ± HOLE DIA = ±



深圳市朋伴兴业科技有限公司

SCALE: N/A

UNIT: mm

DRAWN BY : Sera

CHECKED BY: XD

DESIGNED BY: Sera

APPROVED BY: XD

THIS DRAWINGS AND SPECIFICATIONS ARE THE PROPERTY OF HONMAX TECHNOLOGY Limited AND SHALL NOT BE REPRODUCED OR USED AS THE BASIS FOR THE MANUFACTURE OR SALE OF APPARATUS OR DEVICES WITHOUT PERMISSION

TITLE: CHIP 2450-5016

DOCUMENT NO.

PBX5016DA02

SPEC REV. P1

7. Environmental Characteristics

(1) Reliability Test

Item	Condition	Specification
Thermal shock	1. 30±3 minutes at -40° C±5° C, 2. Convert to +105° C (5 minutes) 3. 30±3 minutes at +105° C±5° C, 4. Convert to -40° C (5 minutes) 5. Total 100 continuous cycles	No apparent damage Fulfill the electrical spec. after test.
Humidity resistance	1. Humidity: 85% R.H. 2. Temperature: 85±5° C 3. Time: 1000 hours.	No apparent damage Fulfill the electrical spec. after test.
High temperature resistance	1. Temperature: 150° C±5° C 2. Time: 1000 hours.	No apparent damage Fulfill the electrical spec. after test.
Low temperature resistance	1. Temperature: -40° C±5° C 2. Time: 1000 hours.	No apparent damage Fulfill the electrical spec. after test.
Soldering heat resistance	1. Solder bath temperature : 260±5°C 2. Bathing time: 10±1 seconds	No apparent damage
Solderability	The dipped surface of the terminal shall be at least 95% covered with solder after dipped in solder bath of 245±5°C for 3±1 seconds.	No apparent damage

(2) Storage Condition

(a) At warehouse:

The temperature should be within 0 ~ 30°C and humidity should be less than 60% RH.

The product should be used within 1 year from the time of delivery.

(b) On board:

The temperature should be within -40~85°C and humidity should be less than 85% RH.

(3) Operating Temperature Range

Operating temperature range : -40°C to +105°C.

8. Recommended Reflow Soldering

UNLESS OTHER SPECIFIED TOLERANCES ON: X=± X.X=± X.XX= ANGLES = ± HOLE DIA = ±		 深圳市朋伴兴业科技有限公司		
SCALE: N/A	UNIT: mm	THIS DRAWINGS AND SPECIFICATIONS ARE THE PROPERTY OF HONMAX TECHNOLOGY Limited AND SHALL NOT BE REPRODUCED OR USED AS THE BASIS FOR THE MANUFACTURE OR SALE OF APPARATUS OR DEVICES WITHOUT PERMISSION		
DRAWN BY : Sera	CHECKED BY: XD			
DESIGNED BY: Sera	APPROVED BY: XD			
TITLE: CHIP 2450-5016		DOCUMENT NO.	PBX5016DA02	SPEC REV. P1
		PAGE 9 OF 11		

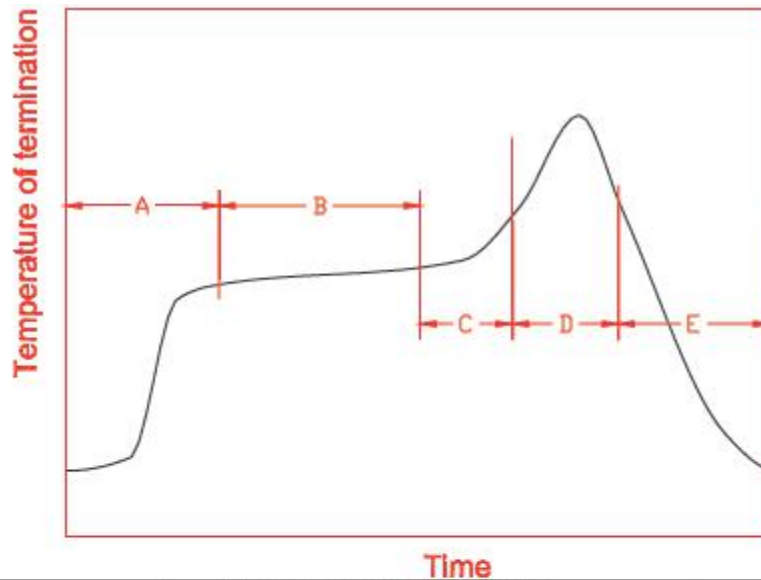

A	1 st rising temperature	The normal to Preheating temperature	30s to 60s
B	Preheating	140°C to 160°C	60s to 120s
C	2 nd rising temperature	Preheating to 200°C	20s to 40s
D	Main heating	if 220°C	50s~60s
		if 230°C	40s~50s
		if 240°C	30s~40s
		if 250°C	20s~40s
E	Regular cooling	200°C to 100°C	1°C/s ~ 4°C/s

*reference: J-STD-020C

(1) Soldering Gun Procedure

Note the follows, in case of using solder gun for replacement.

- (a) The tip temperature must be less than 350°C for the period within 3 seconds by using soldering gun under 30 W.
- (b) The soldering gun tip shall not touch this product directly.

(2) Soldering Volume

Note that excess of soldering volume will easily get crack the body of this product.

9. Taping Package and Label Marking: (unit: mm)

UNLESS OTHER SPECIFIED TOLERANCES ON: X=± X.X=± X.XX=		 深圳市朋伴兴业科技有限公司	
ANGLES = ± HOLE DIA = ±			
SCALE: N/A	UNIT: mm	THIS DRAWINGS AND SPECIFICATIONS ARE THE PROPERTY OF HONMAX TECHNOLOGY Limited AND SHALL NOT BE REPRODUCED OR USED AS THE BASIS FOR THE MANUFACTURE OR SALE OF APPARATUS OR DEVICES WITHOUT PERMISSION	
DRAWN BY : Sera	CHECKED BY: XD		
DESIGNED BY: Sera	APPROVED BY: XD		
TITLE: CHIP 2450-5016		DOCUMENT NO. PBX5016DA02	SPEC REV. P1
		PAGE 10	OF 11

(1) Quantity/Reel: 4000pcs/Reel

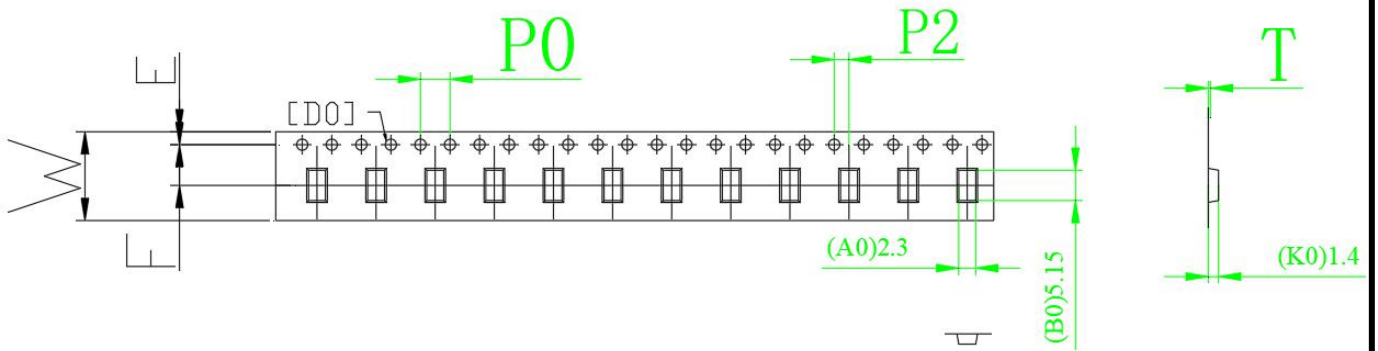

ITEM	W	A0	B0	K0	K1	P	F	E	S0	D0	D1	P0	P2	T
DIM	12.00	2.30	5.15	1.40	0.00	8.00	5.50	1.75	52.40	1.50	0.00	4.00	2.00	0.30

UNLESS OTHER SPECIFIED TOLERANCES ON:
 $X = \pm$ $X.X = \pm$ $X.XX =$
ANGLES = \pm **HOLE DIA = \pm**



深圳市朋伴兴业科技有限公司

SCALE: N/A

UNIT: mm

DRAWN BY: Sera

CHECKED BY: XD

DESIGNED BY: Sera

APPROVED BY: XD

THIS DRAWINGS AND SPECIFICATIONS ARE THE PROPERTY OF HONMAX TECHNOLOGY Limited AND SHALL NOT BE REPRODUCED OR USED AS THE BASIS FOR THE MANUFACTURE OR SALE OF APPARATUS OR DEVICES WITHOUT PERMISSION

TITLE: CHIP 2450-5016

DOCUMENT NO.

PBX5016DA02

SPEC REV. P1