

BT Audio Antenna Report

1. Gain and Efficiency

Frequency	Efficiency	Gain(dBi)
2402MHz	29%	0.937002
2441MHz	27%	-0.40394
2480MHz	25%	-1.27924

ANT Model: IVSP1648

Manufacturer: ZHUHAI JIELI TECHNOLOGY CO.,LTD

Address: No.333 Kexing Road, Nanping Town, Xiangzhou District, Zhuhai City

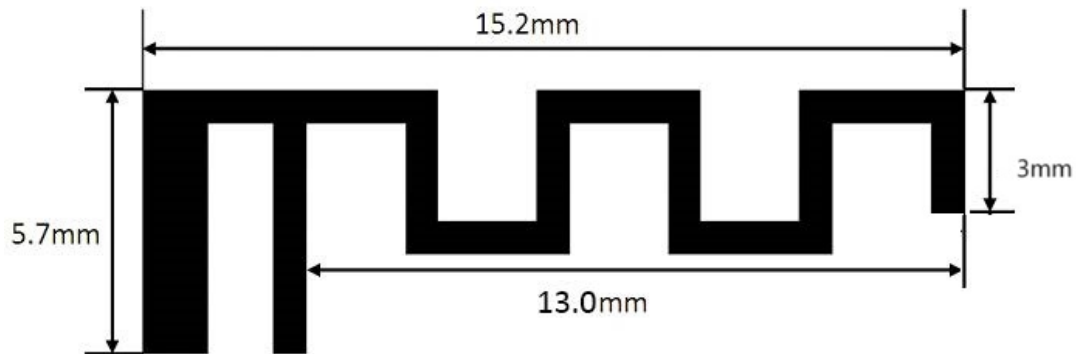

2.VSWR

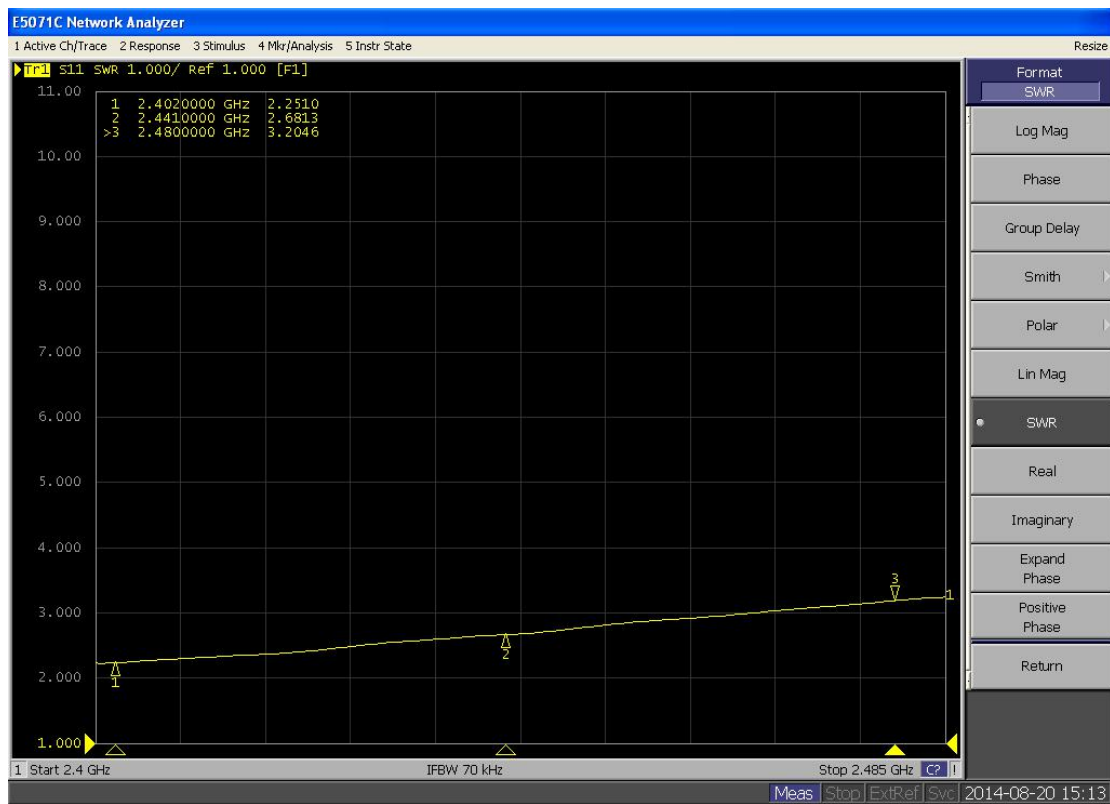

Frequence: VSWR

2.402Ghz 2.2510

2.441Ghz 2.6813

2.480Ghz 3.2046

Input impedance:

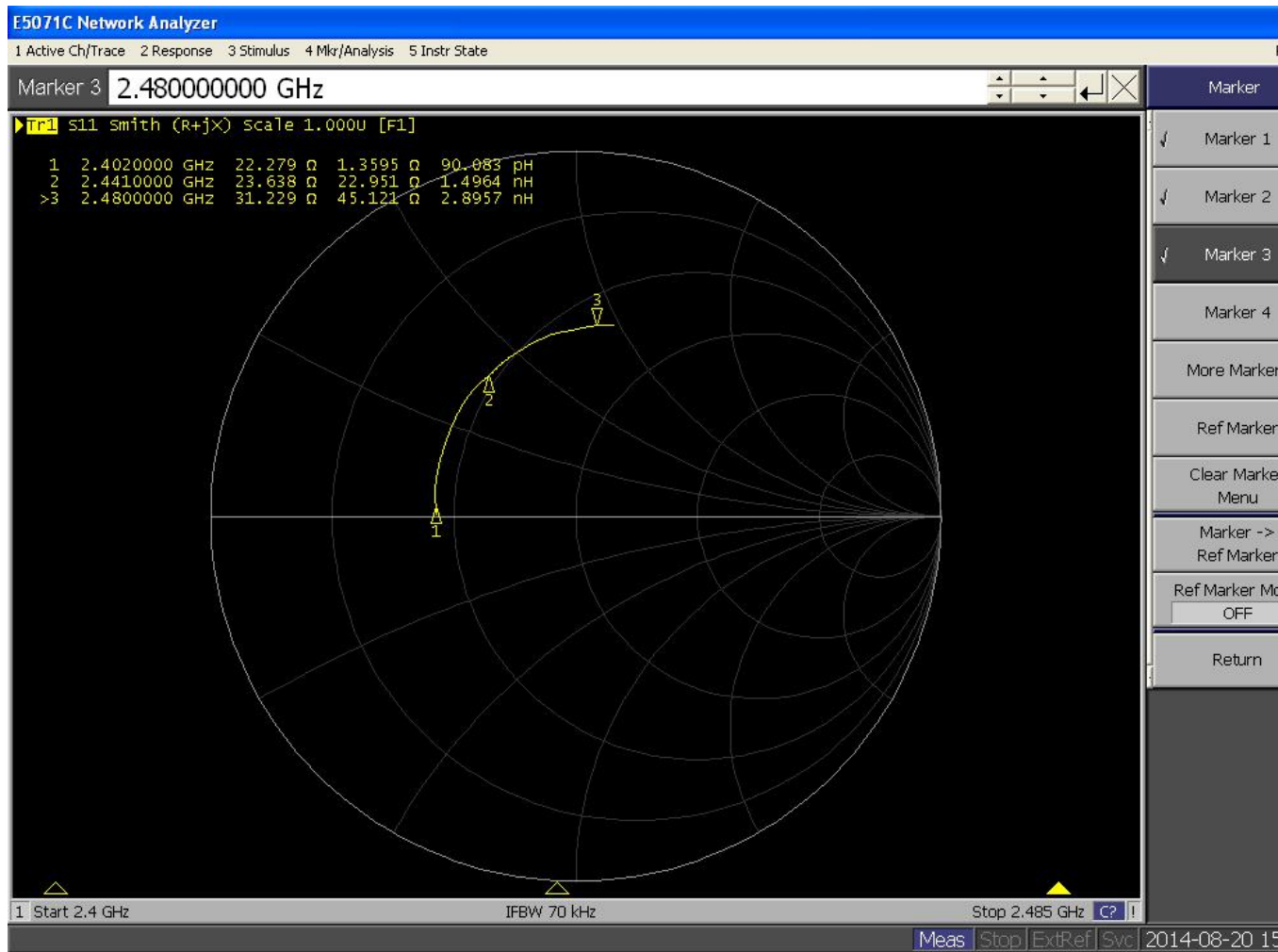

3. Radiation Pattern

2D $\phi = 0$:

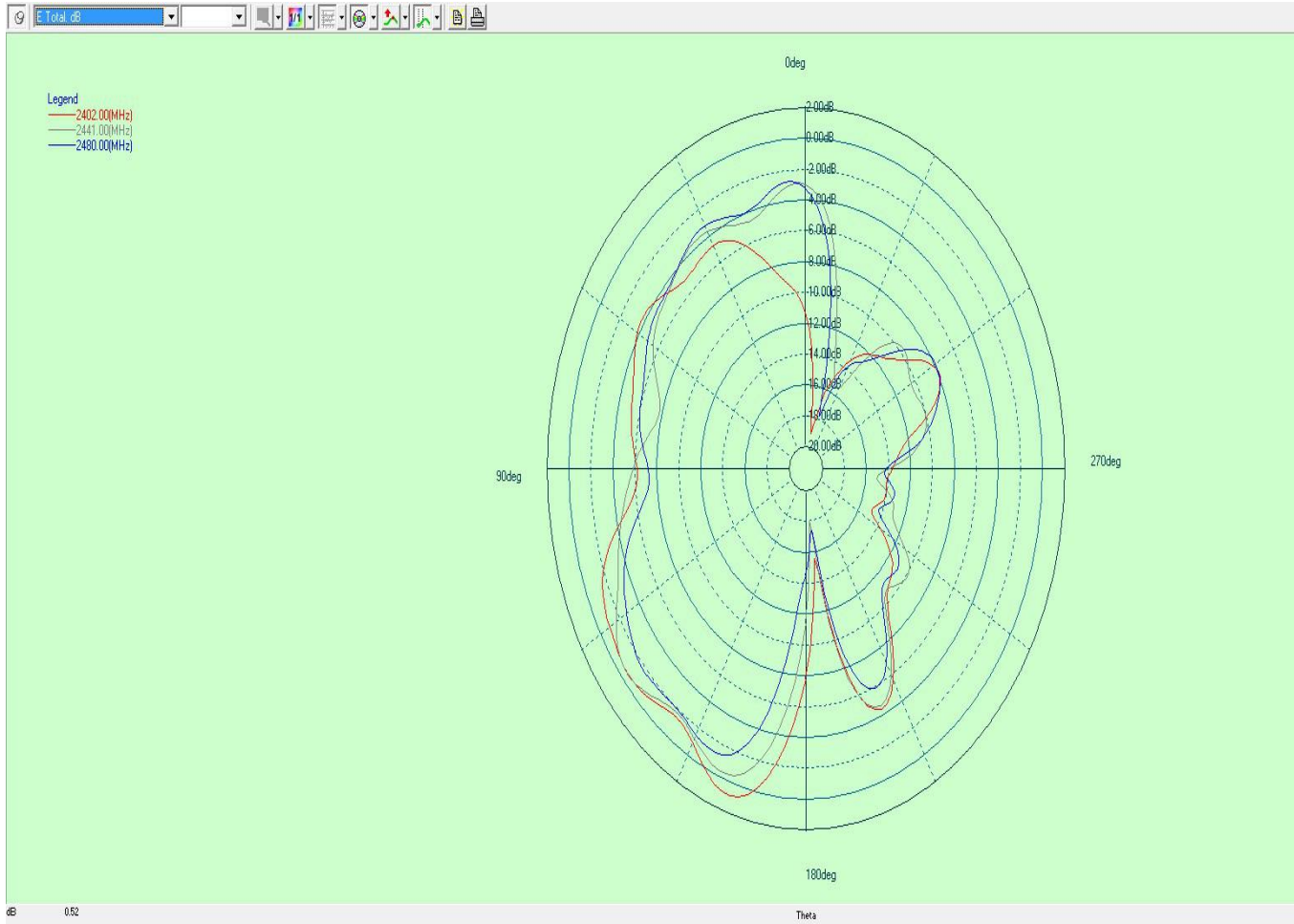

2D $\Phi = 90$:

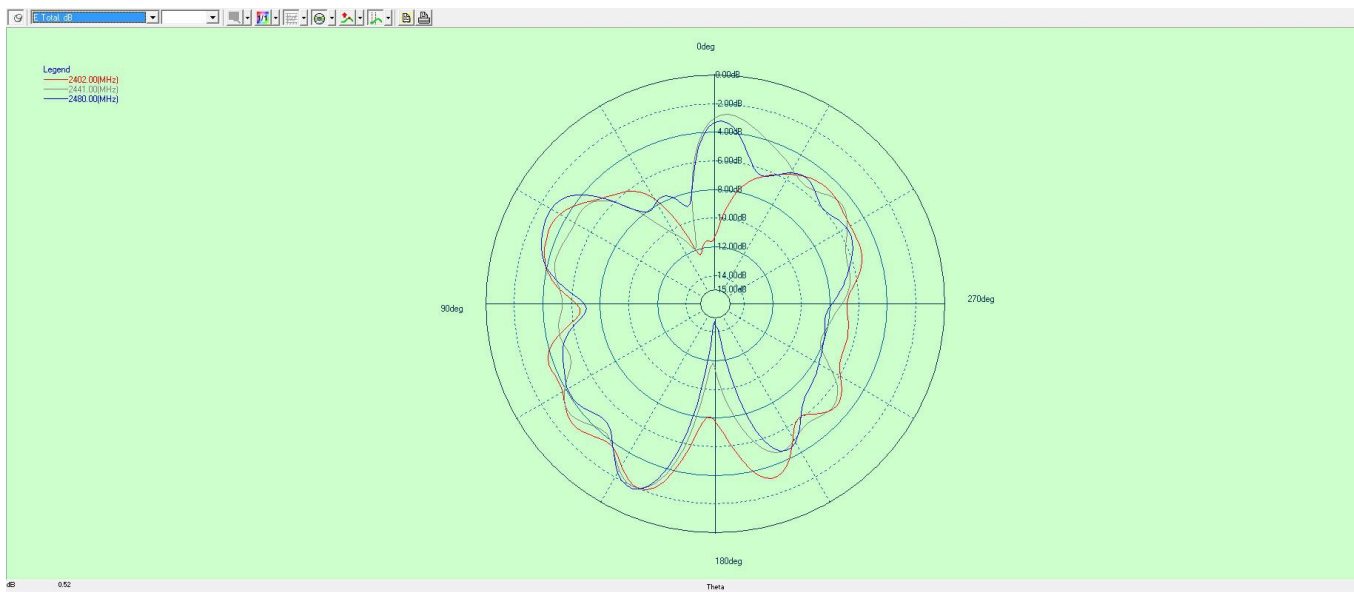

3D:

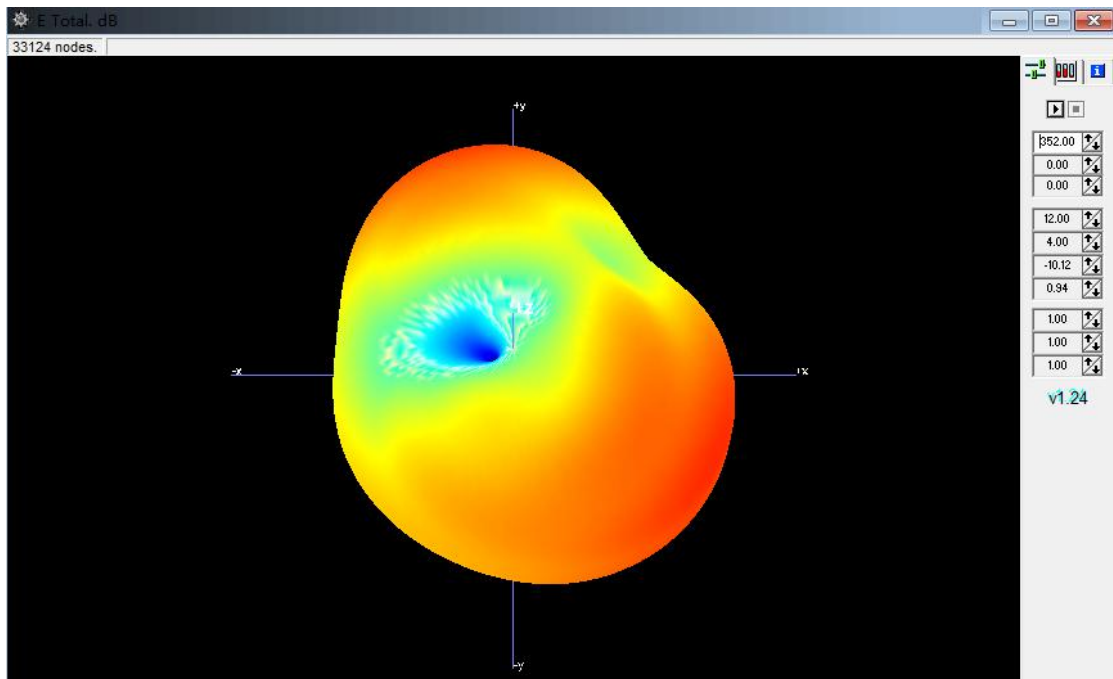

2.402G

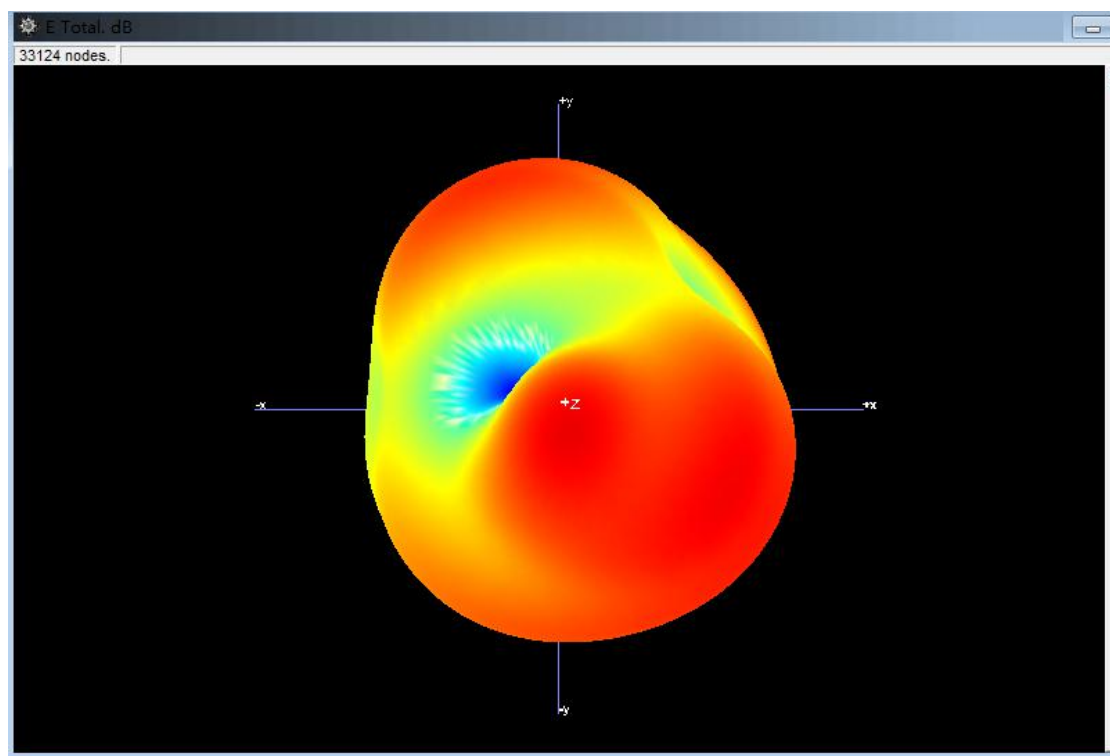

2.441Ghz

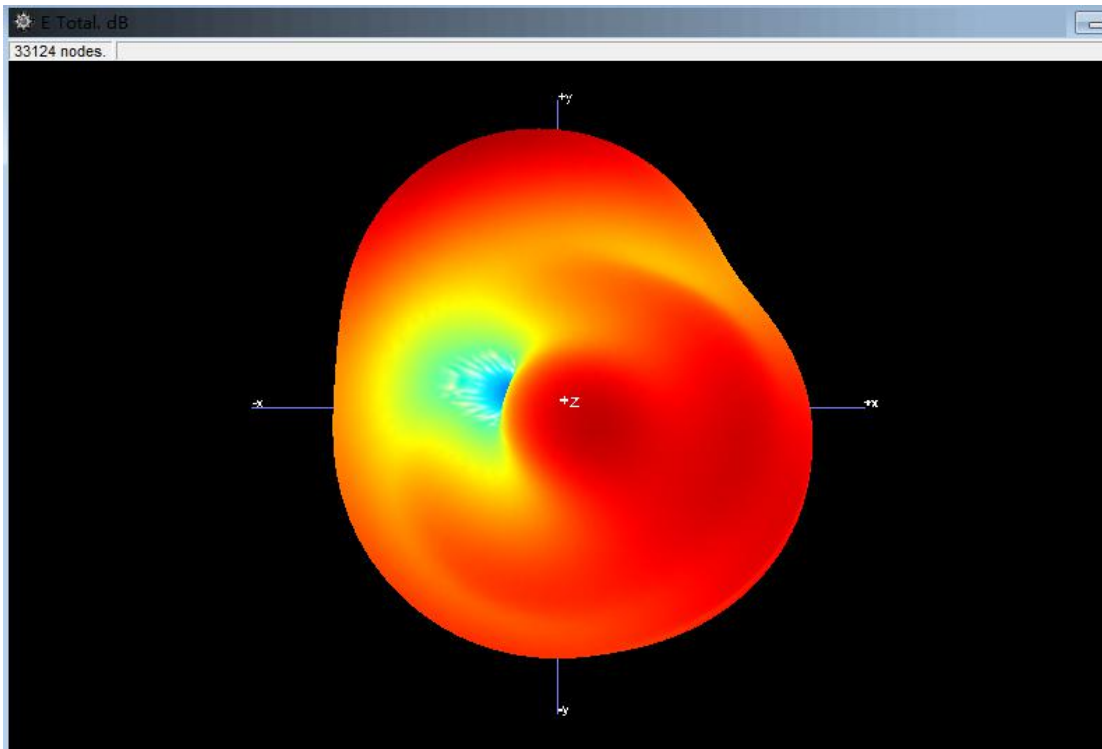

2.480Ghz

3. Return Loss:



4.theta = 90:

