

# Test Report

**Product:** Electric turntable

**Trade Mark:** ComXim

**Model Number:** MT500RUBL200

**FCC ID:** 2BB29-RUBLMAX

**Prepared for**

Shenzhen ComXim Technologies Co.,Ltd.  
Zone A209-A, 2F, Block A and B, Donghaiwang Industrial Zone, No. 369  
Bulong Roa Shenzhen

**Prepared by**

Shenzhen HongBiao Certification& Testing Co., Ltd  
Room 102, 201, Building 2, Yuanwanggu RFID Industrial Park, Tongguan  
Road, Tianliao Community, Yutang Street, Guangming District, Shenzhen,  
China

Tel.: +86-755-2998 9321 Fax.: +86-755-2998 5110

Website: <http://www.sz-hongbiao.com>

## Table of Contents

<b>1 GENERAL DESCRIPTION</b> .....	<b>6</b>
1.1 DESCRIPTION OF EUT.....	6
1.2 TEST MODE.....	7
1.3 OPERATION CHANNEL LIST.....	7
1.4 TEST SETUP.....	7
1.5 ANCILLARY EQUIPMENT.....	7
<b>2 SUMMARY OF TEST RESULT</b> .....	<b>8</b>
<b>3 TEST FACILITIES AND ACCREDITATIONS</b> .....	<b>9</b>
3.1 TEST LABORATORY.....	9
3.2 ENVIRONMENTAL CONDITIONS.....	9
3.3 MEASUREMENT UNCERTAINTY.....	9
3.4 TEST SOFTWARE.....	9
<b>4 LIST OF TEST EQUIPMENT</b> .....	<b>10</b>
<b>5 TEST ITEM AND RESULTS</b> .....	<b>12</b>
5.1 ANTENNA REQUIREMENT.....	12
5.1.1 <i>Standard Requirement</i> .....	12
5.1.2 <i>Test Result</i> .....	12
5.2 CONDUCTED EMISSION.....	13
5.2.1 <i>Limits</i> .....	13
5.2.2 <i>Test Procedures</i> .....	13
5.2.3 <i>Test Setup</i> .....	14
5.2.4 <i>Test Result</i> .....	14
5.3 RADIATED EMISSION.....	17
5.3.1 <i>Limits</i> .....	17
5.3.2 <i>Test Procedures</i> .....	17
5.3.3 <i>Test Setup</i> .....	17
5.3.4 <i>Test Result</i> .....	18
5.3.5 <i>Band Edge - Radiated</i> .....	22
5.3.6 <i>Spurious emission in restricted band 3260MHz-18000MHz</i> .....	23
5.4 PEAK OUTPUT POWER.....	24
5.4.1 <i>Limit</i> .....	24
5.4.2 <i>Test Procedure</i> .....	24
5.4.3 <i>Test Setup</i> .....	24
5.4.4 <i>Test Results</i> .....	24
5.5 POWER SPECTRAL DENSITY.....	25
5.5.1 <i>Limit</i> .....	25
5.5.2 <i>Test Procedure</i> .....	25
5.5.3 <i>Test Setup</i> .....	25
5.5.4 <i>Test Results</i> .....	25
5.6 6DB BANDWIDTH.....	27
5.6.1 <i>Limit</i> .....	27
5.6.2 <i>Test Procedure</i> .....	27
5.6.3 <i>Test Setup</i> .....	27
5.6.4 <i>Test Results</i> .....	27
5.7 DUTY CYCLE.....	29
5.7.1 <i>Limit</i> .....	29
5.7.2 <i>Test Procedure</i> .....	29
5.7.3 <i>Test Setup</i> .....	29
5.7.4 <i>Test Results</i> .....	30
5.8 CONDUCTED BAND EDGE.....	32
5.8.1 <i>Limit</i> .....	32
5.8.2 <i>Test Procedure</i> .....	32
5.8.3 <i>Test Setup</i> .....	32
5.8.4 <i>Test Results</i> .....	32

---

5.9 SPURIOUS RF CONDUCTED EMISSIONS .....	34
5.9.1 <i>Limit</i> .....	34
5.9.2 <i>Measuring Instruments</i> .....	34
5.9.3 <i>Test Procedure</i> .....	34
5.9.4 <i>Test Setup</i> .....	34
5.9.5 <i>Test Results</i> .....	34
<b>6 PHOTOGRAPHS OF THE TEST SETUP .....</b>	<b>37</b>
<b>7 PHOTOGRAPHS OF THE EUT .....</b>	<b>39</b>





# 1 General Description

## 1.1 Description of EUT

Product name:	Electric turntable
Model name:	MT500RUBL200
Series Model:	MT500RUBL200P-A, MT500RUBL200P-B, MT500RUBL200FU-A, MT500RUBL200FU-B, MT500RUBL200P-AB, MT500RUBL200P-BA, NT600RUBL200, NT600RUBL200P-A, NT600RUBL200P-B, NT600RUBL200FU-A, NT600RUBL200FU-B, NT600RUBL200P-AB, NT600RUBL200P-BA, MT600RUBL200, MT600RUBL200P-A, MT600RUBL200P-B, MT600RUBL200FU-A, MT600RUBL200FU-B, MT600RUBL200P-AB, MT600RUBL200P-BA, MT800RUBL300, MT800RUBL300P-A, MT800RUBL300P-B, MT800RUBL300FU-A, MT800RUBL300FU-B, MT800RUBL300P-AB, MT800RUBL300P-BA
Different of series model:	All the models are the same circuit and module, except the Size and Color..
Operation frequency:	2402-2480MHz
Modulation type:	GFSK
Bit Rate of transmitter:	1 Mbps
Antenna type:	Pcb Antenna
Antenna gain:	3.63 dBi
Max. output power:	3.28 dBm
Hardware version:	V2.0
Software version:	HC-08V3.1
Battery:	N/A
Power supply:	Input:100-240V~50/60Hz 1.7A MaxOutput:24V ==3A
Adapter information:	MODEL: J652-2403000IX INPUT: 100-240V~50/60Hz 1.7A OUTPUT: DC 24V ==3A 72W

**1.2 Test Mode**

Test Mode	Channel	Frequency (MHz)
1	00	2402
2	39	2441
3	78	2480

**1.3 Operation Channel list**

Channel No.	Frequency (MHz)	Channel No.	Frequency (MHz)	Channel No.	Frequency (MHz)	Channel No.	Frequency (MHz)
0	2402	10	2422	20	2442	30	2462
1	2404	11	2424	21	2444	31	2464
2	2406	12	2426	22	2446	32	2466
3	2408	13	2428	23	2448	33	2468
4	2410	14	2430	24	2450	34	2470
5	2412	15	2432	25	2452	35	2472
6	2414	16	2434	26	2454	36	2474
7	2416	17	2436	27	2456	37	2476
8	2418	18	2438	28	2458	38	2478
9	2420	19	2440	29	2460	39	2480

**1.4 Test Setup**

See photographs of the test setup in the report for the actual setup and connections between EUT and support equipment.

**1.5 Ancillary Equipment**

Equipment	Model	S/N	Manufacturer
Remote control	/	/	Shenzhen ComXim Technologies Co.,Ltd.

## 2 Summary of Test Result

No.	Standard Section	Test Item	Result	Remark
1	15.203	Antenna Requirement	Pass	
2	15.247 (b)	Peak Output Power	Pass	
3	15.207	Conducted Emission	Pass	
4	15.247 (d) & 15.209	Radiated Spurious Emission	Pass	
5	15.247 (e)	Power Spectral Density	Pass	
6	15.247 (a)(2)	6dB Bandwidth	Pass	
7	558074 D01 15.247 Meas Guidance v05r02 Chapter 6	Duty Cycle	Pass	
8	15.205	Band Edge Emission	Pass	
9	15.247(d)	Spurious RF Conducted Emissions	Pass	



### 3 Test Facilities and Accreditations

#### 3.1 Test Laboratory

Test Site	Shenzhen HongBiao Certification& Testing Co., Ltd
Test Site Location	Room 102, 201, Building 2, Yuanwanggu RFID Industrial Park, Tongguan Road, Tianliao Community, Yutang Street, Guangming District, Shenzhen, China
Telephone:	(86-755) 2998 9321
Fax:	(86-755) 2998 5110
FCC Registration No.:	CN1341
A2LA Certificate No.:	6765.01

#### 3.2 Environmental Conditions

During the measurement the environmental conditions were within the listed ranges:

Temperature:	15°C~35°C
Relative Humidity:	20%~75%
Air Pressure:	98kPa~101kPa

#### 3.3 Measurement Uncertainty

The reported uncertainty of measurement  $y \pm U$ , where expanded uncertainty  $U$  is based on a standard uncertainty multiplied by a coverage factor of  $k=2$ , providing a level of confidence of approximately 95 %.

Measurement Frequency Range	U, (dB)	Note
RF frequency	$2 \times 10^{-5}$	
RF power, conducted	$\pm 0.57$ dB	
Conducted emission(150kHz~30MHz)	$\pm 2.5$ dB	
Radiated emission(30MHz~1GHz)	$\pm 4.2$ dB	
Radiated emission (above 1GHz)	$\pm 4.7$ dB	
Temperature	$\pm 1$ degree	
Humidity	$\pm 5$ %	

#### 3.4 Test Software

Software name	Manufacturer	Model	Version
EMI Measurement	Farad	EZ-EMC	V1.1.4.2
Conducted test system	MWRF-test	MTS 8310	V2.0.0

## 4 List of Test Equipment

Radiation emission							
Item	Equipment No.	Equipment name	Manufacturer	Model	Serial No.	Calibration date	Due date
1	HB-E001	Horn Antenna	Schwarzbeck	BBHA 9120D	02592	2022-04-02	2024-04-01
2	HB-E002	Biconical log-periodic composite antenna	Schwarzbeck	VULB 9168	01340	2022-04-06	2024-04-05
3	HB-E003	SHF-EHF Horn	Schwarzbeck	BBHA 91270	01193	2022-04-02	2024-04-01
4	HB-E004	Preamplifier	Noyetec	LAN-0910	NYCM1420101	2023-05-11	2024-05-10
5	HB-E005	Preamplifier	Noyetec	LAN-0118	NYCM1420102	2023-05-12	2024-05-11
6	HB-E006	Preamplifier	Noyetec	LAN-1840	NYCM1420103	2023-06-11	2024-06-10
7	HB-E007	EMI TEST RECEIVER	R&S	ESR7	102520	2023-05-12	2024-05-11
8	HB-E009	POSITINAL COTROLLER	Noyetec	N/A	N/A	/	/
9	HB-E013	RF switch	Noyetec	NY-RF4	NY0CM1420204	/	/
10	HB-E066	Illuminance Tester	TASI	TA8121	N/A	2023-05-11	2024-05-10
11	HB-E075	Active loop antenna	Schwarzbeck	FMZB 1519B	1519B-245	2022-07-24	2024-07-23
Conduction emission							
Item	Equipment No.	Equipment name	Manufacturer	Model	Serial No.	Calibration date	Due date
1	HB-E014	4 Path V-LISN	Schwarzbeck	NNLK 8121	00770	2023-05-12	2024-05-11
2	HB-E015	Pulse Limiter	Schwarzbeck	VTSD 9561-F	00949	2023-05-12	2024-05-11
3	HB-E016	ZN23201	Noyetec	ZN23201	N/A	2023-05-11	2024-05-10
4	HB-E059	Attenuator	Xianghua	TS2-6-1	220215166	2023-05-12	2024-05-11
5	HB-E069	EMI TEST RECEIVER	R&S	ESCI	N/A	2023-05-12	2024-05-11
RF							
Item	Equipment No.	Equipment name	Manufacturer	Model	Serial No.	Calibration date	Due date
1	HB-E041	MXG Anaio Signal Generator	Agilent	N5181A	MY47070421	2023-05-11	2024-05-10
2	HB-E042	WIDEBAND RADIO COMMUNICA	R&S	CMW500	132108	2023-05-11	2024-05-10

		TION TESTER					
3	HB-E043	MXG Anaioig Signal Generator	Agilent	N5182A	US46240335	2023-05-11	2024-05-10
4	HB-E044	Signal& spectrum Analyzer	R&S	FSV3044	101264	2023-05-11	2024-05-10
5	HB-E045	RF Control Box	Noyetec	NY100-R FCB	N/A	/	/
6	HB-E058	Thermometer Clock Humidity Monitor	N/A	HTC-1	N/A	/	/
7	HB-E077	PXA Signal Analyzer	Agilent	N9030A	/	2023-05-11	2024-05-10

Note: the calibration interval of the above test instruments is 12&24 months and the calibrations are traceable to international system unit (SI).

## **5 Test Item And Results**

### **5.1 Antenna Requirement**

#### **5.1.1 Standard Requirement**

15.203 requirement: For intentional device, according to 15.203: an intentional radiator shall be designed to ensure that no antenna other than that furnished by the responsible party shall be used with the device

#### **5.1.2 Test Result**

The EUT antenna is Pcb Antenna. It comply with the standard requirement. In case of replacement of broken antenna the same antenna type must be used.

## 5.2 Conducted Emission

### 5.2.1 Limits

Limits – Class B		
Frequency (MHz)	Limit (dB $\mu$ V)	
	Quasi-Peak	Average
0.15 to 0.5	66 to 56*	56 to 46*
0.5 to 5	56	46
5 to 30	60	50

Note:

- the tighter limit applies at the band edges.
- the limit of "\*" marked band means the limitation decreases linearly with the logarithm of the frequency in the range.

### 5.2.2 Test Procedures

a) EUT Operating Conditions

The EUT was configured for testing in a typical fashion (as a customer would normally use it). The EUT has been programmed to continuously transmit during test. This operating condition was tested and used to collect the included data.

b) The following table is the setting of the receiver

Receiver Parameters	Setting
Attenuation	10 dB
Start Frequency	0.15 MHz
Stop Frequency	30 MHz
IF Bandwidth	9 kHz

- The EUT was placed 0.8 meters from the horizontal ground plane with EUT being connected to the power mains through a line impedance stabilization network (LISN). All other support equipment powered from additional LISN(s). The LISN provide 50 Ohm/ 50uH of coupling impedance for the measuring instrument.
- Interconnecting cables that hang closer than 40 cm to the ground plane shall be folded back and forth in the center forming a bundle 30 to 40 cm long.
- I/O cables that are not connected to a peripheral shall be bundled in the center. The end of the cable may be terminated, if required, using the correct terminating impedance. The overall length shall not exceed 1 m.
- LISN is at least 80 cm from nearest part of EUT chassis.
- For the actual test configuration, please refer to the related Item – photographs of the test setup.

### 5.2.3 Test Setup

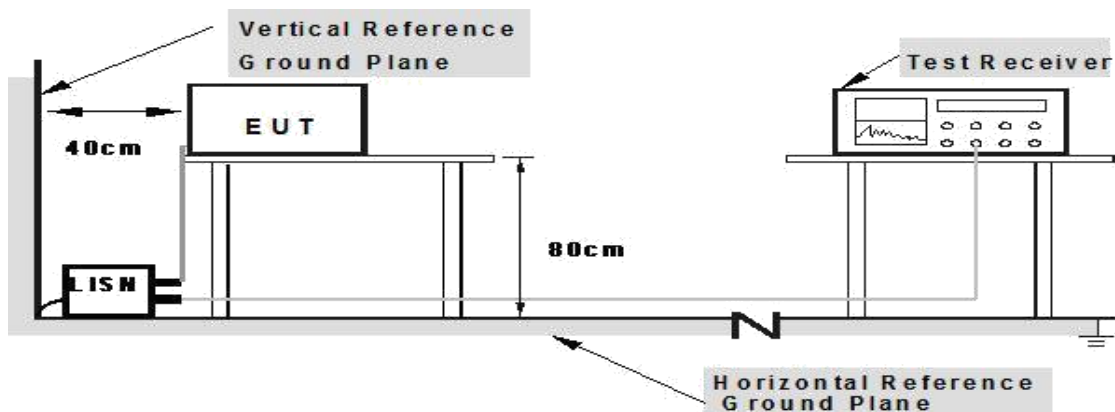

### 5.2.4 Test Result

EUT:	Electric turntable	Model Name:	MT500RUBL200
Test Mode:	On	Phase :	L
Test Voltage:	AC 120V, 60Hz		

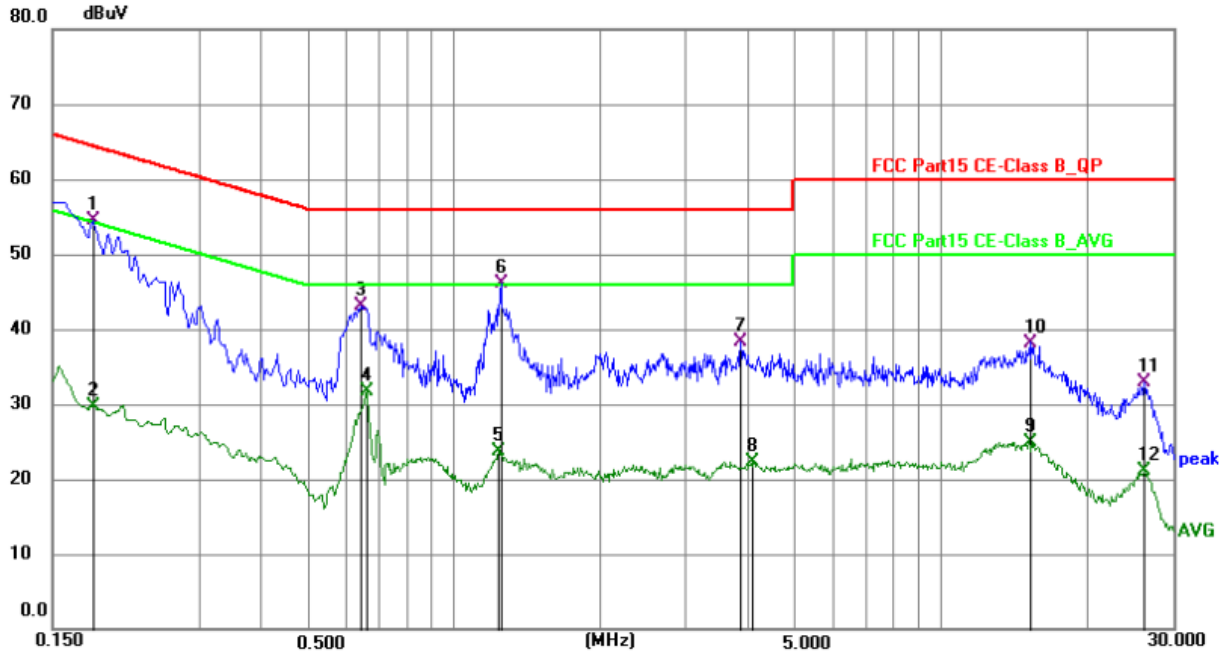

No.	Frequency (MHz)	Reading (dBuV)	Factor (dB)	Level (dBuV)	Limit (dBuV)	Margin (dB)	Detector	P/F
1	0.1814	43.96	10.58	54.54	64.42	-9.88	QP	P
2	0.1814	19.21	10.58	29.79	54.42	-24.63	AVG	P
3	0.6450	32.55	10.64	43.19	56.00	-12.81	QP	P
4	0.6630	21.14	10.64	31.78	46.00	-14.22	AVG	P
5	1.2390	12.97	10.66	23.63	46.00	-22.37	AVG	P
6 *	1.2524	35.48	10.66	46.14	56.00	-9.86	QP	P
7	3.8984	27.62	10.71	38.33	56.00	-17.67	QP	P
8	4.0964	11.69	10.71	22.40	46.00	-23.60	AVG	P
9	15.1884	14.12	10.86	24.98	50.00	-25.02	AVG	P
10	15.2424	27.34	10.86	38.20	60.00	-21.80	QP	P
11	26.1415	21.94	10.94	32.88	60.00	-27.12	QP	P
12	26.1415	10.10	10.94	21.04	50.00	-28.96	AVG	P

EUT:	Electric turntable	Model Name:	MT500RUBL200
Test Mode:	On	Phase :	N
Test Voltage:	AC 120V, 60Hz		

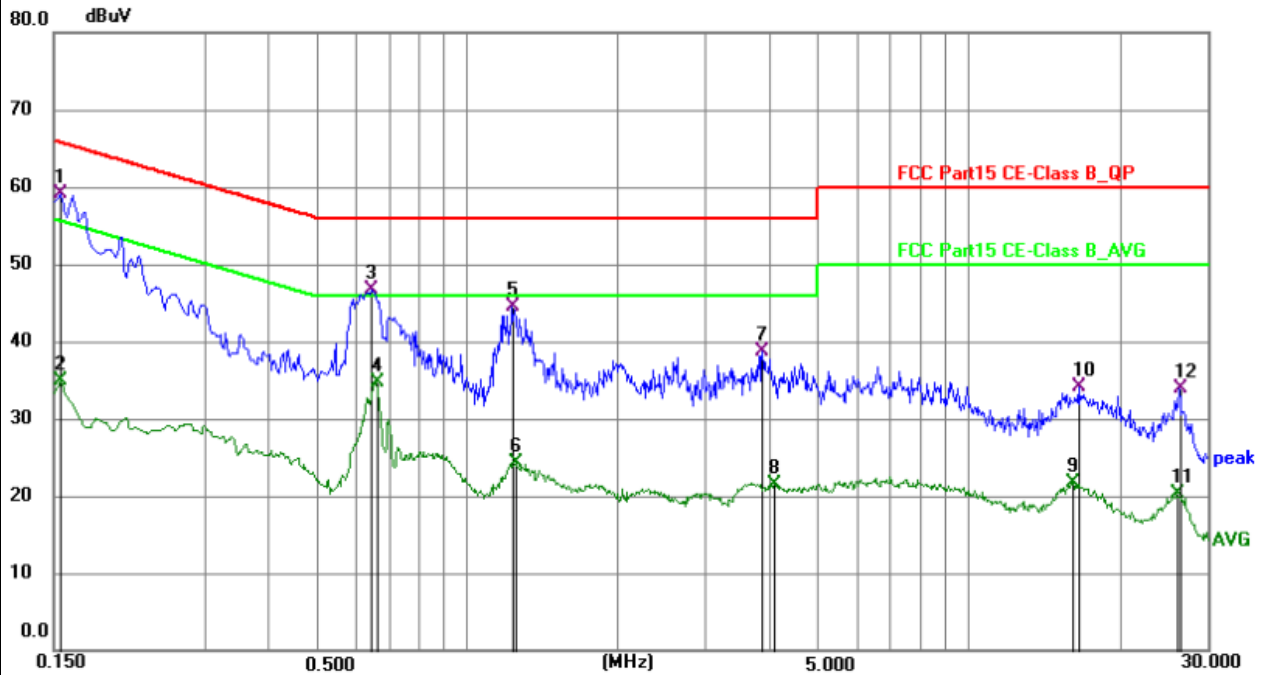

No.	Frequency (MHz)	Reading (dBuV)	Factor (dB)	Level (dBuV)	Limit (dBuV)	Margin (dB)	Detector	P/F
1 *	0.1544	48.51	10.57	59.08	65.76	-6.68	QP	P
2	0.1544	24.38	10.57	34.95	55.76	-20.81	AVG	P
3	0.6450	35.97	10.64	46.61	56.00	-9.39	QP	P
4	0.6584	24.06	10.64	34.70	46.00	-11.30	AVG	P
5	1.2344	33.83	10.66	44.49	56.00	-11.51	QP	P
6	1.2524	13.73	10.66	24.39	46.00	-21.61	AVG	P
7	3.8894	27.92	10.71	38.63	56.00	-17.37	QP	P
8	4.1280	10.84	10.71	21.55	46.00	-24.45	AVG	P
9	16.1875	10.87	10.87	21.74	50.00	-28.26	AVG	P
10	16.5880	23.18	10.88	34.06	60.00	-25.94	QP	P
11	26.0244	9.29	10.94	20.23	50.00	-29.77	AVG	P
12	26.2989	22.97	10.94	33.91	60.00	-26.09	QP	P



## 5.3 Radiated Emission

### 5.3.1 Limits

Frequencies (MHz)	Field Strength (micровolts/meter)	Measurement Distance (meters)
0.009~0.490	2400/F(KHz)	300
0.490~1.705	24000/F(KHz)	30
1.705~30.0	30	30
30~88	100	3
88~216	150	3
216~960	200	3
Above 960	500	3

Receiver Parameter	Setting
Attenuation	Auto
Start ~ Stop Frequency	9kHz~150kHz / RB 200Hz for QP
Start ~ Stop Frequency	150kHz~30MHz / RB 9kHz for QP
Start ~ Stop Frequency	30MHz~1000MHz / RB 120kHz for QP

### 5.3.2 Test Procedures

- The radiated emission tests were performed in the 3 meters.
- The EUT was placed on the top of a rotating table 0.8 meters above the ground. The table was rotated 360 degrees to determine the position of the highest radiation.
- The height of the test antenna shall vary between 1m to 4m. Both horizontal and vertical polarizations of the antenna are set to make the measurement.
- If the peak mode measured value compliance with and lower than quasi peak mode limit, the EUT shall be deemed to meet QP limits and then no additional QP mode measurement performed.
- If the peak mode measured value compliance with and lower than average mode limit, the EUT shall be deemed to meet average limits and then no additional average mode measurement performed.
- For the actual test configuration, please refer to the related item – EUT test photos.

### 5.3.3 Test Setup

Radiated Emission Test-Up Frequency Below 30MHz

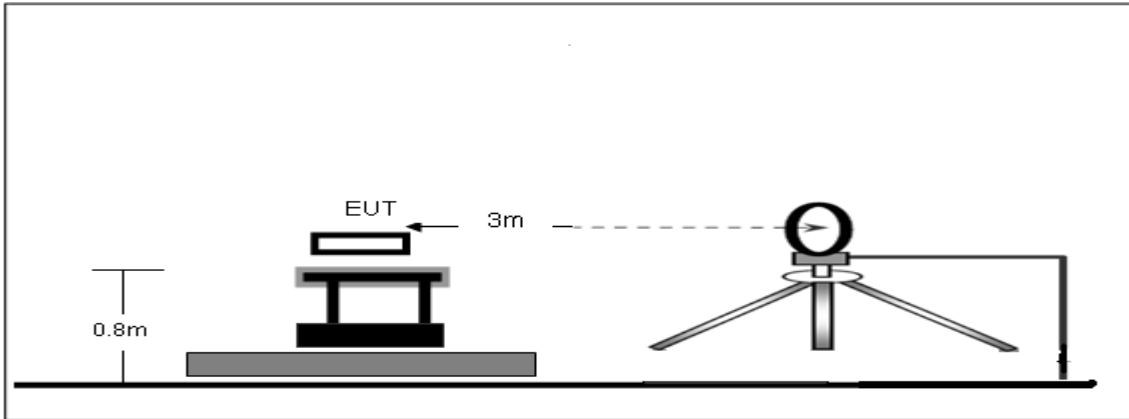

Radiated Emission Test-Up Frequency 30MHz~1GHz

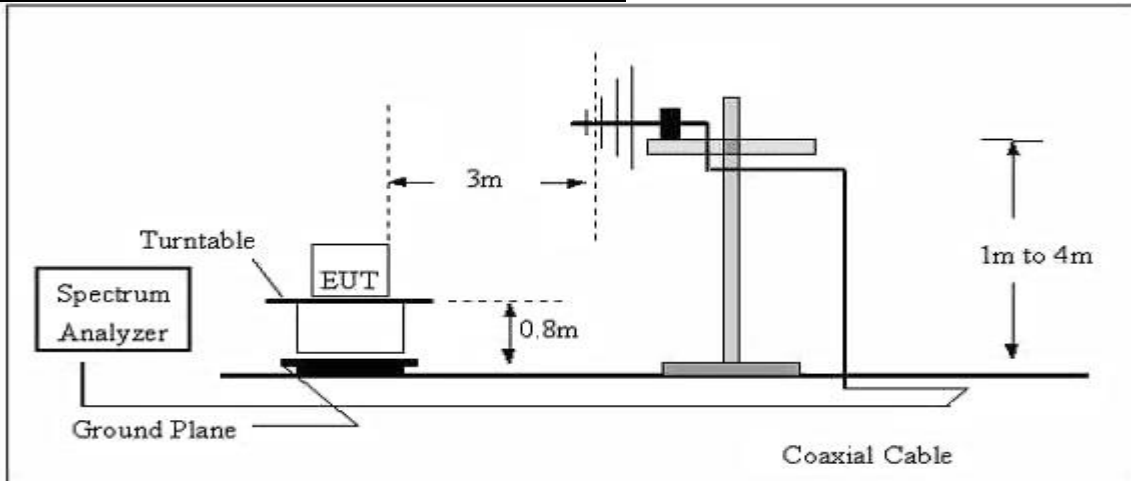

Radiated emission test-up frequency above 1GHz

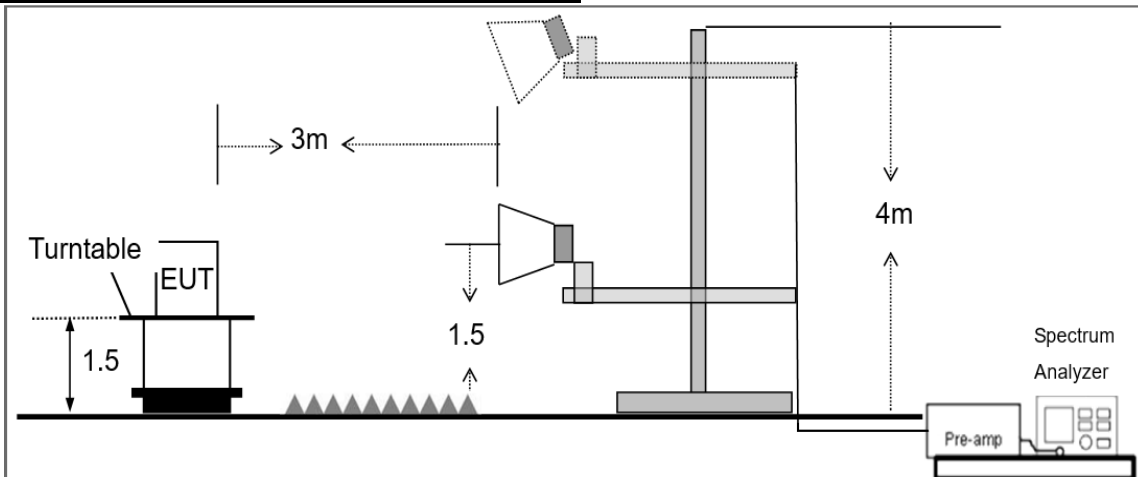

**5.3.4 Test Result**

Below 30MHz

EUT:	--	Model Name:	--
Pressure:	1010 hPa	Test Voltage:	--
Test Mode:	--	Polarization::	--

Freq.	Reading	Limit	Margin	State
(MHz)	(dBuV/m)	(dBuV/m)	(dB)	P/F
--	--	--	--	Pass
--	--	--	--	Pass

Note:

1. For 9kHz-30MHz, the amplitude of spurious emissions which are attenuated by more than 20dB below the permissible value has no need to be reported.
2. Distance extrapolation factor =  $40 \log (\text{specific distance}/\text{test distance})$ (dB);
3. Limit line = specific limits (dBuV) + distance extrapolation factor.

Frequency range (30MHz – 1GHz)

EUT:	Electric turntable	Model Name:	MT500RUBL200
Test Mode:	On	Phase :	Horizontal
Test Voltage:	AC 120V, 60Hz		

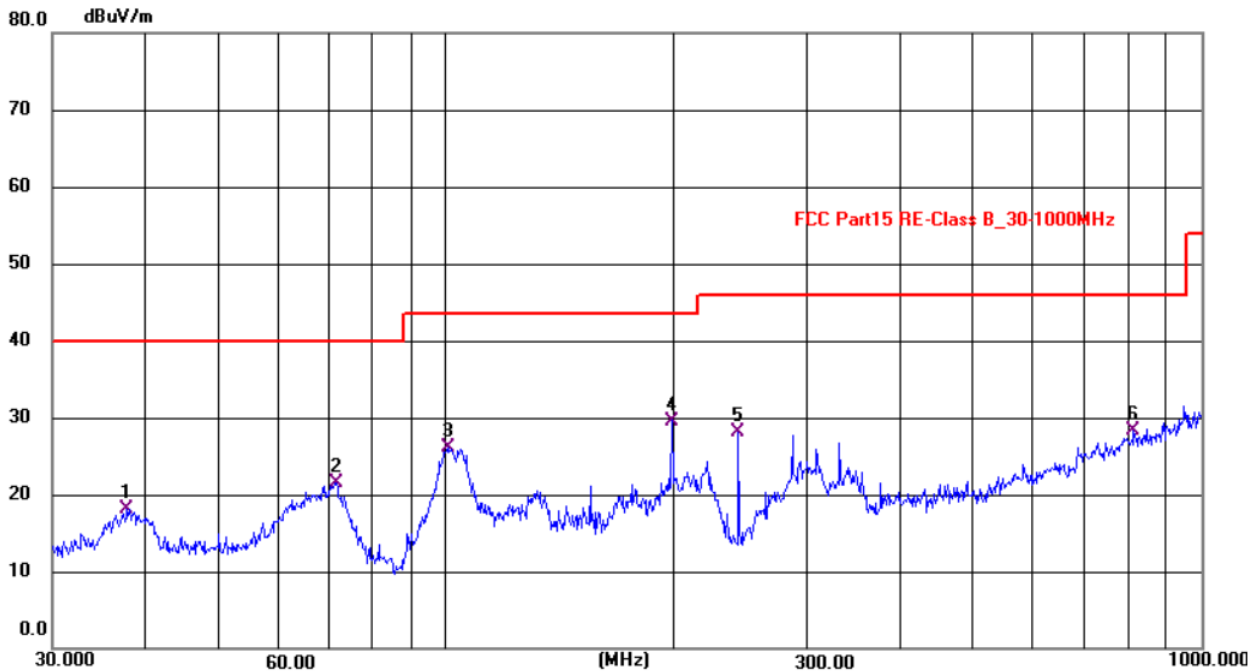

No.	Frequency (MHz)	Reading (dBuV)	Factor (dB/m)	Level (dBuV/m)	Limit (dBuV/m)	Margin (dB)	Detector	Height (cm)	Azimuth (deg.)	P/F
1	37.6798	33.23	-15.03	18.20	40.00	-21.80	QP	100	0	P
2	71.3300	38.92	-17.43	21.49	40.00	-18.51	QP	100	0	P
3	100.4045	45.19	-18.99	26.20	43.50	-17.30	QP	100	0	P
4 *	198.9364	48.31	-18.71	29.60	43.50	-13.90	QP	100	0	P
5	243.3772	45.32	-17.22	28.10	46.00	-17.90	QP	100	0	P
6	813.1115	31.94	-3.62	28.32	46.00	-17.68	QP	100	0	P

EUT:	Electric turntable	Model Name:	MT500RUBL200
Test Mode:	On	Phase :	Horizontal
Test Voltage:	AC 120V, 60Hz		

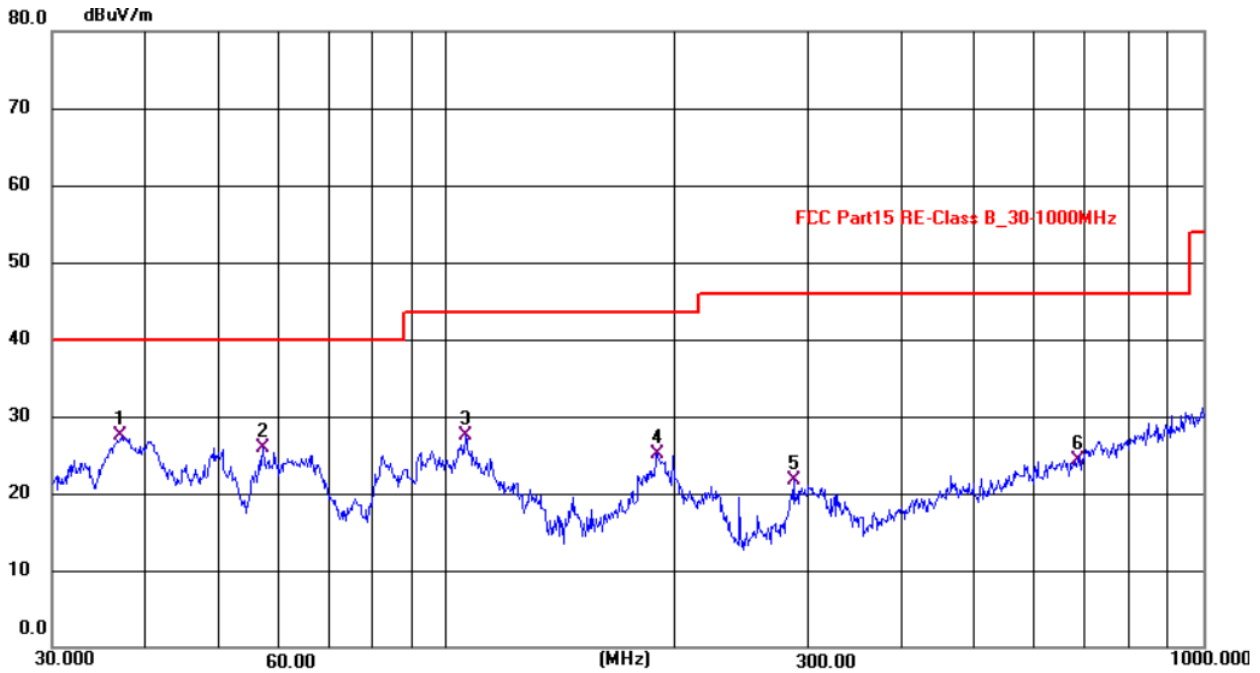

No.	Frequency (MHz)	Reading (dBuV)	Factor (dB/m)	Level (dBuV/m)	Limit (dBuV/m)	Margin (dB)	Detector	Height (cm)	Azimuth (deg.)	P/F
1 *	37.0248	42.58	-15.16	27.42	40.00	-12.58	QP	100	0	P
2	56.9912	40.81	-14.90	25.91	40.00	-14.09	QP	100	0	P
3	105.6415	46.01	-18.50	27.51	43.50	-15.99	QP	100	0	P
4	190.0714	43.04	-17.89	25.15	43.50	-18.35	QP	100	0	P
5	287.4859	37.59	-15.90	21.69	46.00	-24.31	QP	100	0	P
6	682.3484	31.24	-6.92	24.32	46.00	-21.68	QP	100	0	P

**5.3.5 Band Edge - Radiated**

Frequency (MHz)	Meter Reading (dBμV)	Cable Loss (dB)	Antenna Factor dB/m	Preamp Factor (dB)	Emission Level (dBμV/ m)	Limits (dBμV /m)	Margin (dB)	Detect or Type	Comment
<b>GFSK</b>									
2310.00	64.44	2.40	27.70	40.40	54.14	74	64.44	Pk	Horizontal
2310.00	42.18	2.40	27.70	40.40	31.88	54	42.18	AV	Horizontal
2310.00	62.88	2.40	27.70	40.40	52.58	74	62.88	Pk	Vertical
2310.00	42.55	2.40	27.70	40.40	32.25	54	42.55	AV	Vertical
2390.00	60.17	2.44	28.30	40.10	50.81	74	60.17	Pk	Vertical
2390.00	41.33	2.44	28.30	40.10	31.97	54	41.33	AV	Vertical
2390.00	60.22	2.44	28.30	40.10	50.86	74	60.22	Pk	Horizontal
2390.00	43.66	2.44	28.30	40.10	34.30	54	43.66	AV	Horizontal
2483.50	59.98	2.48	28.70	39.80	51.36	74	59.98	Pk	Vertical
2483.50	46.87	2.48	28.70	39.80	38.25	54	46.87	AV	Vertical
2483.50	60.22	2.48	28.70	39.80	51.60	74	60.22	Pk	Horizontal
2483.50	41.22	2.48	28.70	39.80	32.60	54	41.22	AV	Horizontal

**5.3.6 Spurious emission in restricted band 3260MHz-18000MHz**

All the modulation modes have been tested, and the worst result was report as below:

Frequency	Reading Level	Cable Loss	Antenna Factor	Preamp Factor	Emission Level	Limits	Margin	Detector	Comment
(MHz)	(dB $\mu$ V)	(dB)	dB/m	(dB)	(dB $\mu$ V/m)	(dB $\mu$ V/m)	(dB)	Type	
3260	60.11	3.27	30.02	43.80	49.60	74	-24.40	Pk	Vertical
3260	43.21	3.27	30.02	44.80	31.70	54	-22.30	AV	Vertical
3260	63.33	3.27	30.02	45.80	50.82	74	-23.18	Pk	Horizontal
3260	42.17	3.27	30.02	46.80	28.66	54	-25.34	AV	Horizontal
3332	65.44	3.31	30.00	47.80	50.95	74	-23.05	Pk	Vertical
3332	41.25	3.31	30.00	48.80	25.76	54	-28.24	AV	Vertical
3332	63.18	3.31	30.00	49.80	46.69	74	-27.31	Pk	Horizontal
3332	41.12	3.31	30.00	50.80	23.63	54	-30.37	AV	Horizontal
17797	45.69	8.63	44.23	51.80	46.75	74	-27.25	Pk	Vertical
17797	31.11	8.63	44.23	52.80	31.17	54	-22.83	AV	Vertical
17788	40.22	8.63	44.23	53.80	39.28	74	-34.72	Pk	Horizontal
17788	31.98	8.63	44.23	54.80	30.04	54	-23.96	AV	Horizontal

## 5.4 Peak Output Power

### 5.4.1 Limit

FCC Part15 Subpart C			
Section	Test Item	Limit	Frequency Range (MHz)
15.247(b)(3)	Peak output power	1 watt or 30dBm	2400-2483.5

### 5.4.2 Test Procedure

- (1) The EUT was directly connected to the spectrum analyzer and antenna output port as show in the block diagram above.
- (2) Spectrum Setting:  
 RBW=1MHz, VBW=3MHz, Detector=Peak (If 20dB BW ≤1 MHz)  
 RBW=3MHz, VBW=8MHz, Detector=Peak (If 20dB BW > 1 MHz)
- (3) The EUT was set to continuously transmitting in the max power during the test.

### 5.4.3 Test Setup

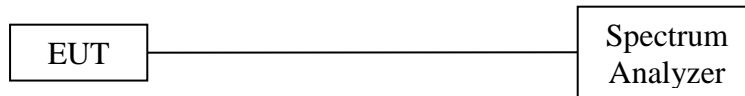

### 5.4.4 Test Results

EUT:	Electric turntable	Model Name:	MT500RUBL200
Test Mode:	All Mode	Test Voltage:	DC 3.3V from Serial port

### GFSK

Channel	Conducted Peak Power[dBm]	Conducted Limit[dBm]	EIRP[dBm]	EIRP Limit[dBm]
CH00	-0.49	≤30	3.14	≤36
CH19	-0.35	≤30	3.28	≤36
CH39	-0.75	≤30	2.88	≤36



## 5.5 Power Spectral Density

### 5.5.1 Limit

FCC Part15 (15.247) , Subpart C			
Section	Test Item	Limit	Frequency Range (MHz)
15.247	Power Spectral Density	8 dBm (in any 3kHz)	2400-2483.5

### 5.5.2 Test Procedure

1. Set analyzer center frequency to DTS channel center frequency.
2. Set the span to 1.5 times the DTS channel bandwidth.
3. Set the RBW  $\geq$  3 kHz.
4. Set the VBW  $\geq$  3 x RBW.
5. Detector = peak.
6. Sweep time = auto couple.
7. Trace mode = max hold.
8. Allow trace to fully stabilize.
9. Use the peak marker function to determine the maximum amplitude level.
10. If measured value exceeds limit, reduce RBW (no less than 3 kHz) and repeat.

### 5.5.3 Test Setup

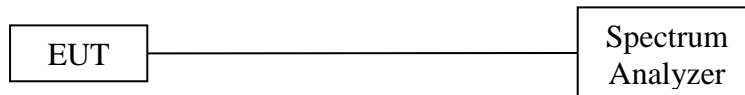

### 5.5.4 Test Results

EUT:	Electric turntable	Model Name:	MT500RUBL200
Pressure:	1015 hPa	Test Voltage:	DC 3.3V from Serial port
Test Mode:	All Mode		

Frequency	Power Density (dBm/3kHz)	Limit (dBm/3kHz)	Result
2402 MHz	-15.40	8	PASS
2440 MHz	-16.46	8	PASS
2480 MHz	-15.73	8	PASS

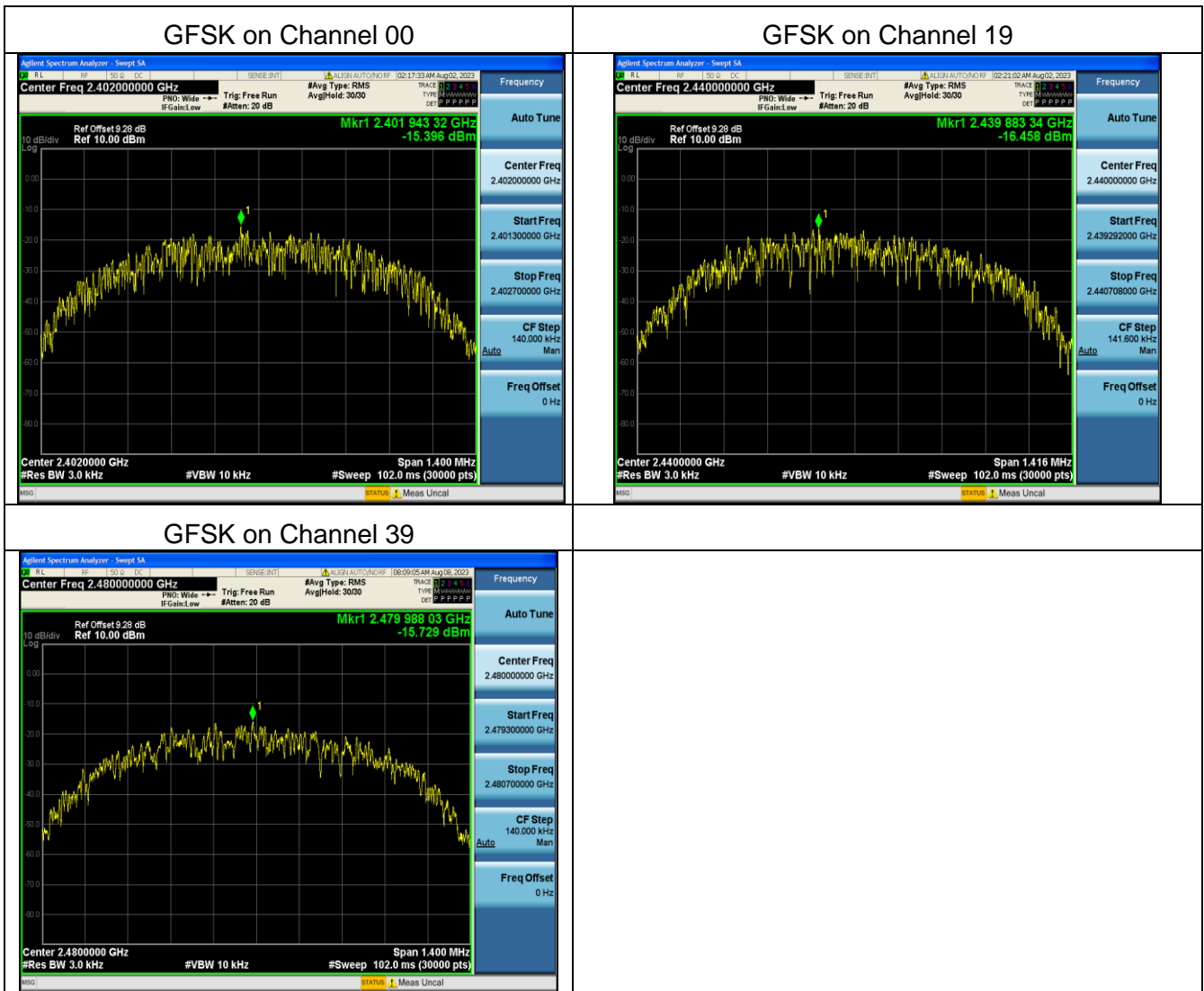

## 5.6 6dB Bandwidth

### 5.6.1 Limit

FCC Part15 (15.247) , Subpart C			
Section	Test Item	Limit	Frequency Range (MHz)
15.247(a)(2)	Bandwidth	$\geq 500\text{kHz}$ (6dB bandwidth)	2400-2483.5

### 5.6.2 Test Procedure

1. Set RBW= 100 kHz.
2. Set the video bandwidth (VBW)  $\geq 3 \times$  RBW.
3. Detector = Peak.
4. Trace mode = max hold.
5. Sweep = auto couple.
6. Allow the trace to stabilize.
7. Measure the maximum width of the emission that is constrained by the frequencies associated with the two outermost amplitude points (upper and lower) that are attenuated by 6 dB relative to the maximum level measured in the fundamental emission.

### 5.6.3 Test Setup

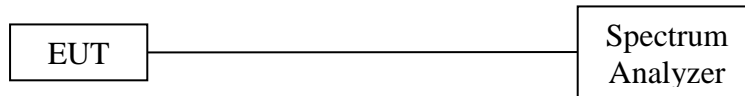

### 5.6.4 Test Results

EUT:	Electric turntable	Model Name:	MT500RUBL200
Pressure:	1012 hPa	Test Voltage:	DC 3.3V from Serial port
Test Mode:	All Mode		

Channel	Frequency (MHz)	6dB bandwidth (kHz)	Limit (kHz)	Result
Low	2402	669.3	500	Pass
Middle	2440	663.0	500	Pass
High	2480	721.2	500	Pass

Test plots

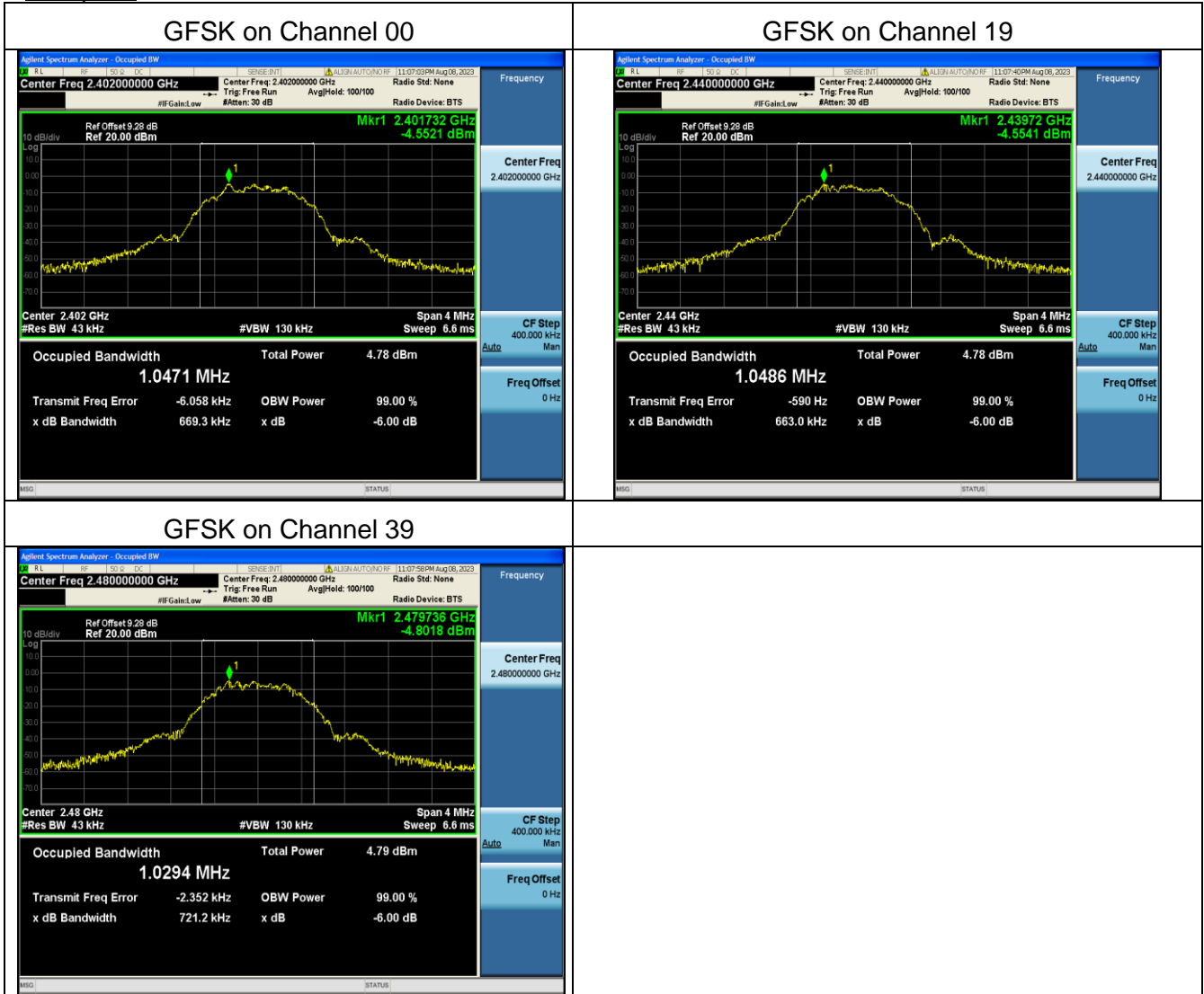

## 5.7 Duty Cycle

### 5.7.1 Limit

No limit requirement.

### 5.7.2 Test Procedure

The zero-span mode on a spectrum analyzer or EMI receiver if the response time and spacing between bins on the sweep are sufficient to permit accurate measurements of the on and off times of the transmitted signal. Set the center frequency of the instrument to the center frequency of the transmission. Set  $RBW \geq OBW$  if possible; otherwise, set RBW to the largest available value. Set  $VBW \geq RBW$ . Set detector = peak or average. The zero-span measurement method shall not be used unless both RBW and VBW are  $> 50/T$  and the number of sweep points across duration T exceeds 100. (For example, if VBW and/or RBW are limited to 3 MHz, then the zero-span method of measuring duty cycle shall not be used if  $T \leq 16.7$  microseconds.)

The transmitter output is connected to the Spectrum Analyzer. We tested according to the zero-span measurement method, 6.0(b) in KDB 558074 D01 DTS Meas Guidance v05r02.

The largest available value of RBW is 8 MHz and VBW is 50 MHz. The zero-span method of measuring duty cycle shall not be used if  $T \leq 6.25$  microseconds. ( $50/6.25 = 8$ )

The zero-span method was used because all measured T data are  $> 6.25$  microseconds and both RBW and VBW are  $> 50/T$ .

The RF output of EUT was connected to the spectrum analyzer by RF cable and attenuator.

The path loss was compensated to the results for each measurement.

Set to the maximum power setting and enable the EUT transmit continuously.

The EUT was operating in controlled its channel.

Use the following spectrum analyzer settings:

Span = Zero Span

RBW = 8MHz (the largest available value)

VBW = 8MHz ( $\geq$  RBW)

Number of points in Sweep  $>100$

Detector function = peak

Trace = Clear write

Measure Total and Ton

Calculate Duty Cycle =  $Ton / Total$

### 5.7.3 Test Setup

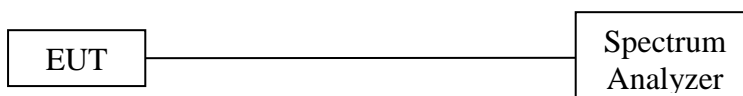

**5.7.4 Test Results**

EUT:	Electric turntable	Model Name:	MT500RUBL200
Pressure:	1012 hPa	Test Voltage:	DC 3.3V from Serial port
Test Mode:	All Mode		

Test plots

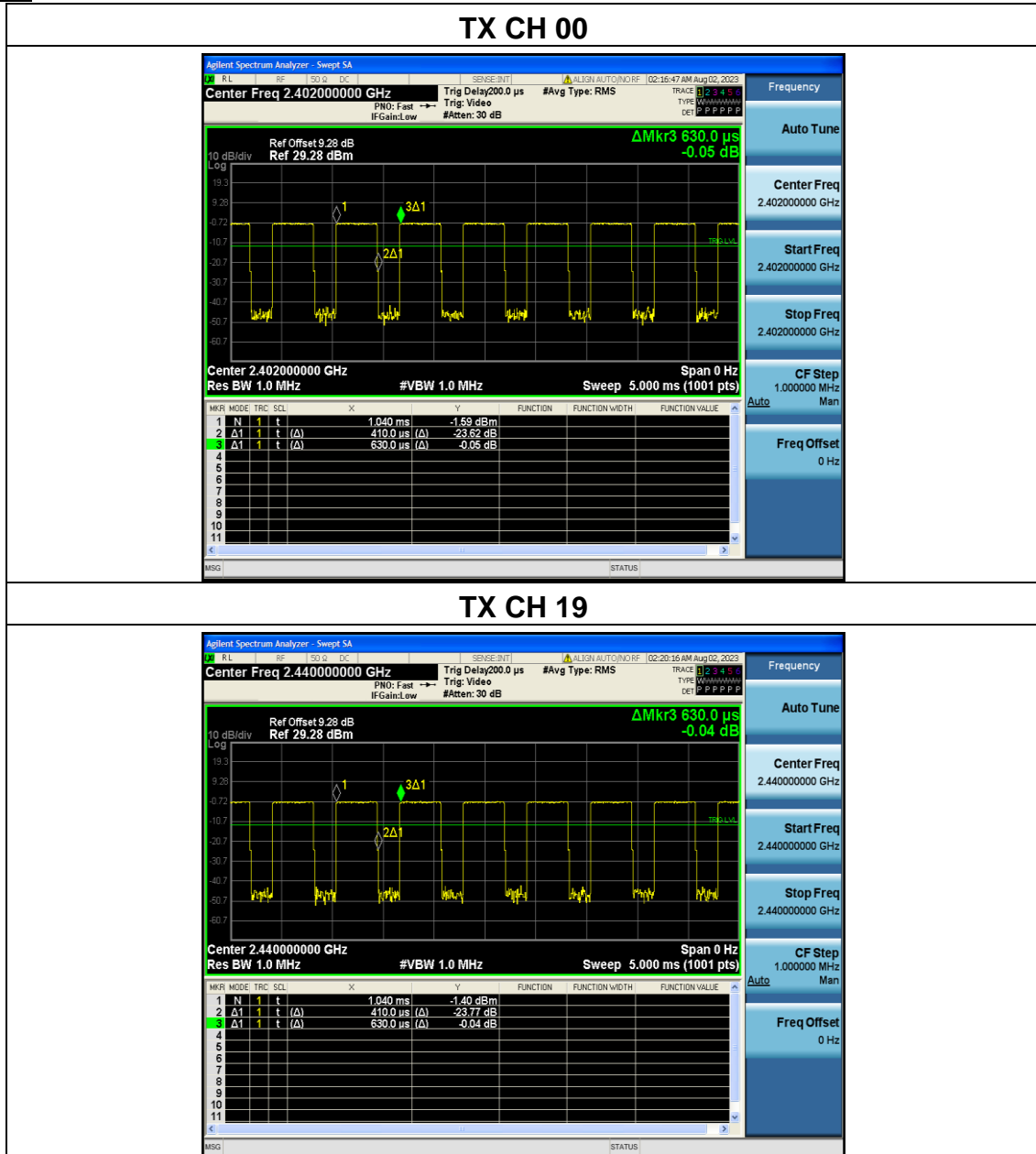

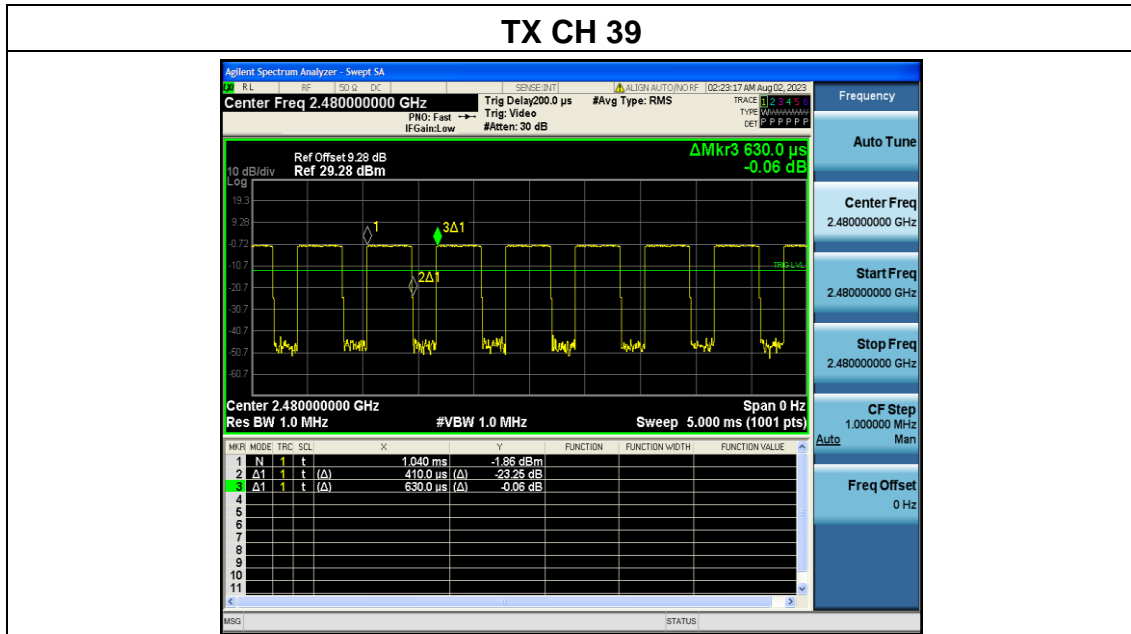

## 5.8 Conducted Band Edge

### 5.8.1 Limit

In any 100 kHz bandwidth outside the frequency band in which the spread spectrum or digitally modulated intentional radiator is operating, the radio frequency power that is produced by the intentional radiator shall be at least 20 dB below that in the 100 kHz bandwidth within the band that contains the highest level of the desired power, based on either an RF conducted or a radiated measurement, provided the transmitter demonstrates compliance with the peak conducted power limits. If the transmitter complies with the conducted power limits based on the use of RMS averaging over a time interval, as permitted under paragraph (b)(3) of this section, the attenuation required under this paragraph shall be 30 dB instead of 20 dB. Attenuation below the general limits specified in §15.209(a) is not required. In addition, radiated emissions which fall in the restricted bands, as defined in §15.205(a), must also comply with the radiated emission limits specified in §15.209(a) (see §15.205(c)).

### 5.8.2 Test Procedure

- a) Check the calibration of the measuring instrument using either an internal calibrator or a known signal from an external generator.
- b) Position the EUT without connection to measurement instrument. Turn on the EUT and connect its antenna terminal to measurement instrument via a low loss cable. Then set it to any one measured frequency within its operating range, and make sure the instrument is operated in its linear range.
- c) Set RBW to 100 kHz and VBW of spectrum analyzer to 300 kHz with a convenient frequency span including 100 kHz bandwidth from band edge.
- d) Measure the highest amplitude appearing on spectral display and set it as a reference level. Plot the graph with marking the highest point and edge frequency.
- e) Repeat above procedures until all measured frequencies were complete.

### 5.8.3 Test Setup

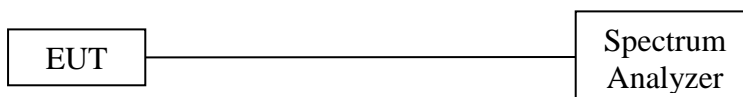

### 5.8.4 Test Results



EUT:	Electric turntable	Model Name:	MT500RUBL200
Pressure:	1012 hPa	Test Voltage:	DC 3.3V from Serial port
Test Mode:	All Mode		

BLE: Band Edge, Left Side

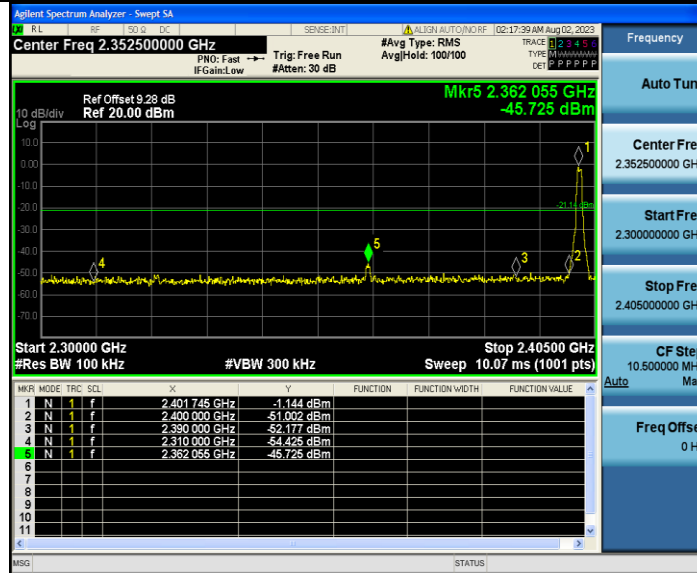

BLE: Band Edge, Right Side

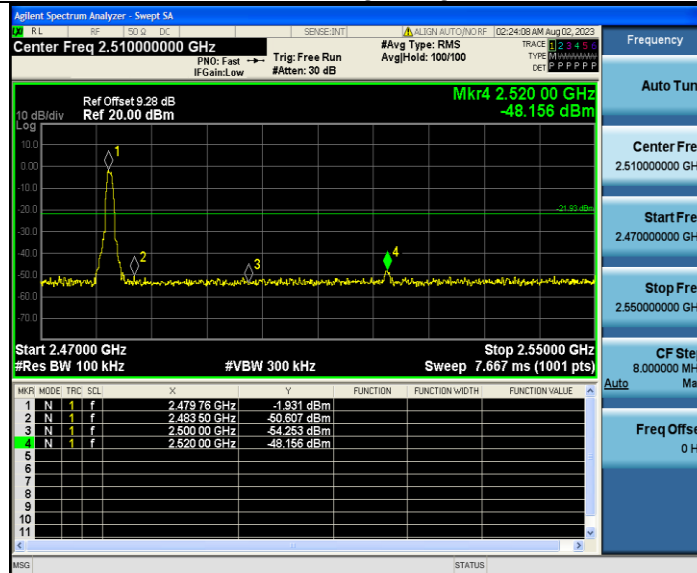

## 5.9 Spurious RF Conducted Emissions

### 5.9.1 Limit

Below -20dB of the highest emission level in operating band.

### 5.9.2 Measuring Instruments

The Measuring equipment is listed in the section 4 of this test report.

### 5.9.3 Test Procedure

The Spurious RF conducted emissions compliance of RF radiated emission should be measured by following the guidance in ANSI C63.10-2013 with respect to maximizing the emission by rotating the EUT, measuring the emission while the EUT is situated in three orthogonal planes (if appropriate), adjusting the measurement antenna height and polarization etc. Set RBW=100kHz and VBW=300kHz to measure the peak field strength, and measure frequency range from 9kHz to 26.5GHz.

### 5.9.4 Test Setup



### 5.9.5 Test Results

Note:

- 1: The measurement frequency range is from 9kHz to the 10th harmonic of the fundamental frequency. The lowest, middle and highest channels are tested to verify the spurious emissions and band edge measurement data.
- 2: The worst mode is GFSK mode, and the report only show the worst mode data.

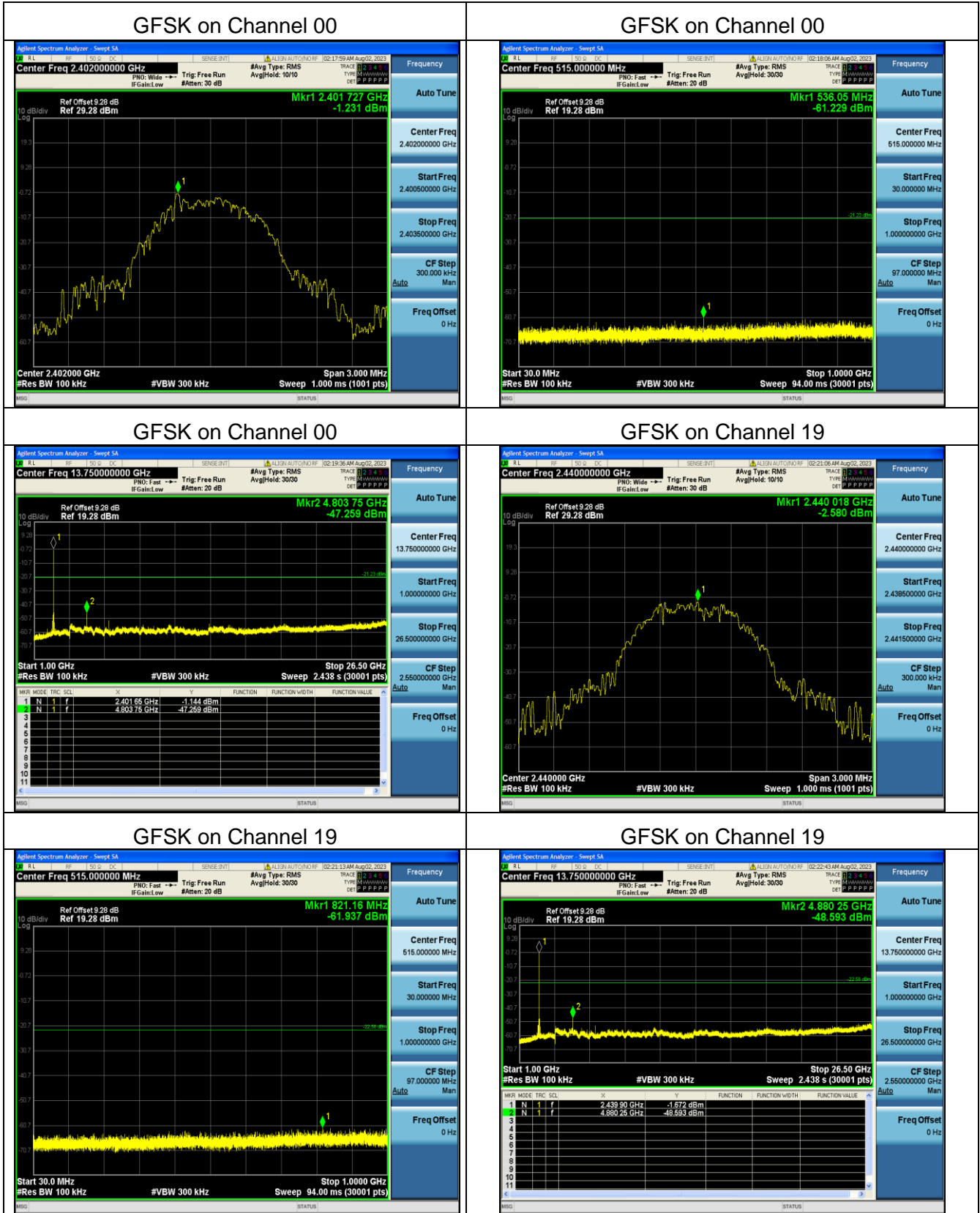

GFSK on Channel 39



GFSK on Channel 39

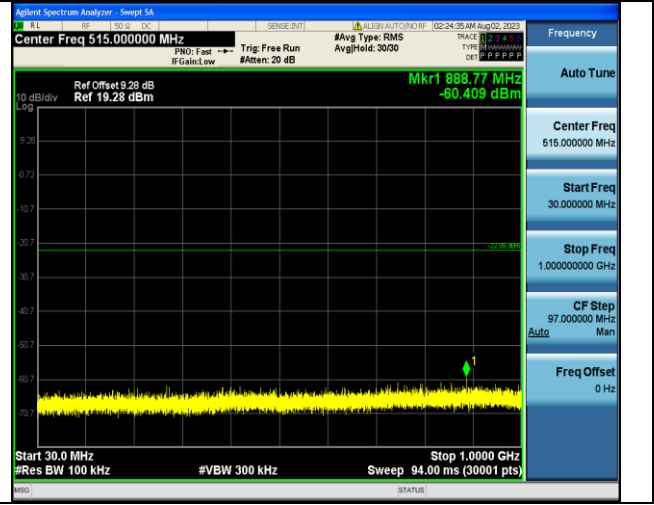

GFSK on Channel 39

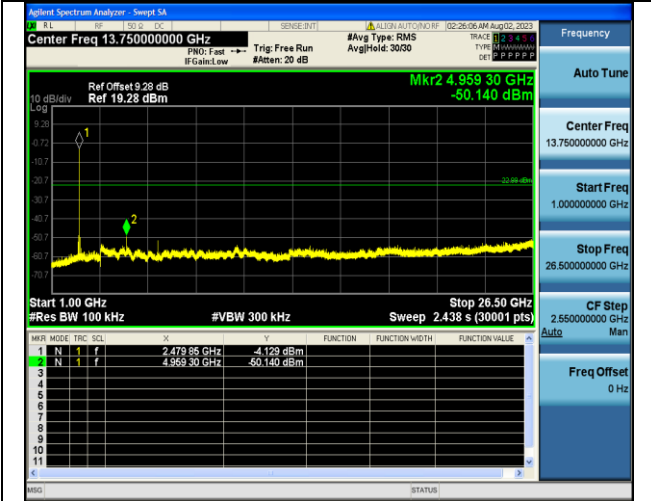

## 6 Photographs of the Test Setup

Radiated Emission Below 1GHz

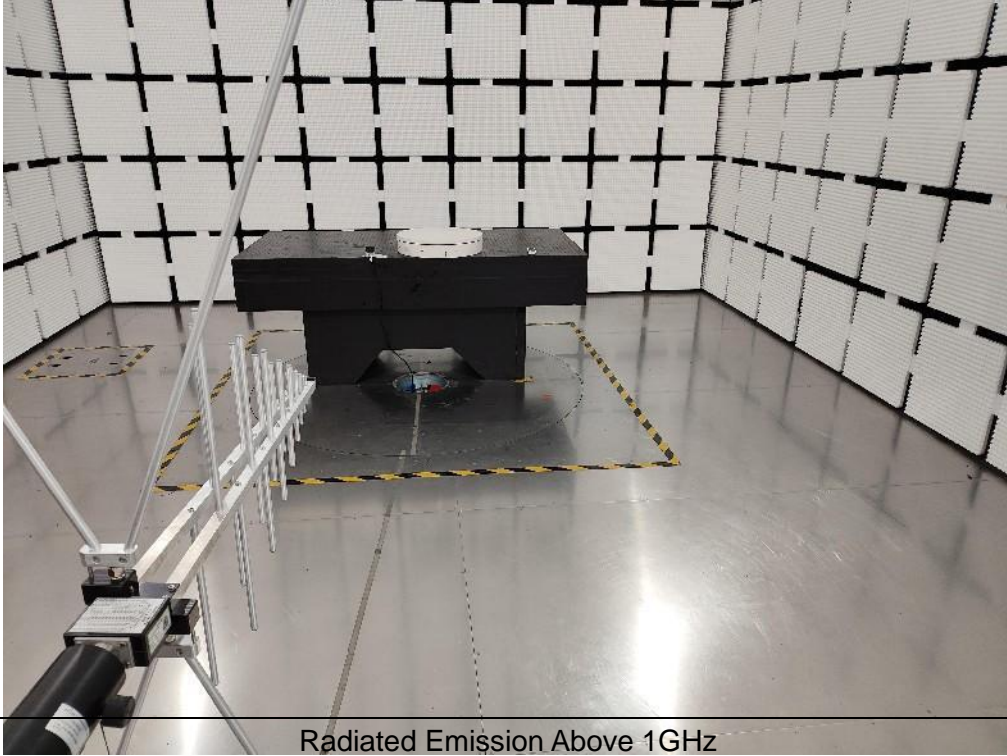

Radiated Emission Above 1GHz

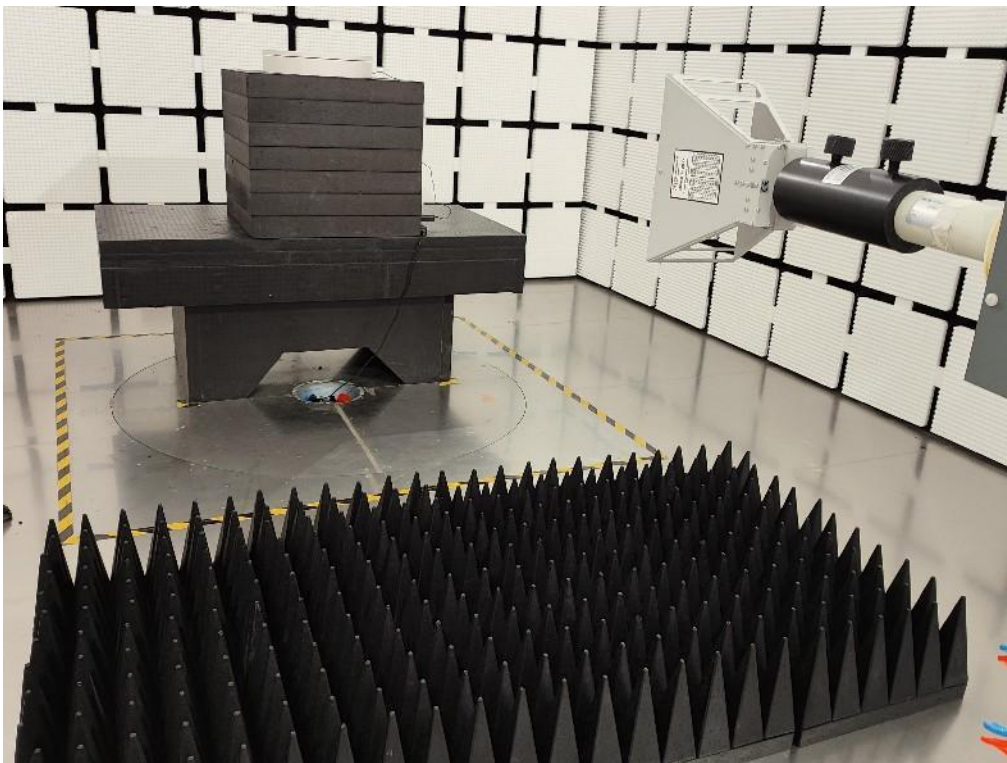

Conducted emission



## 7 Photographs of the EUT

Photo 1



Photo 2

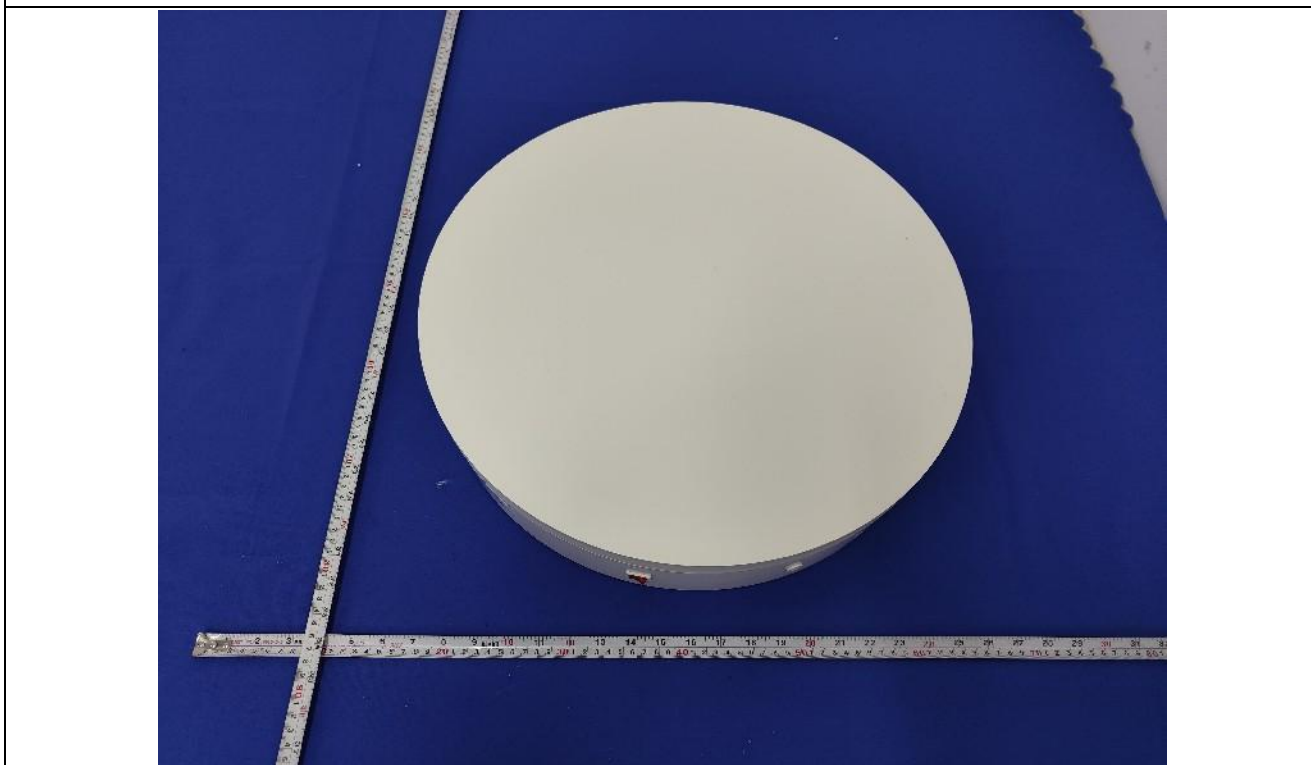

Photo 3

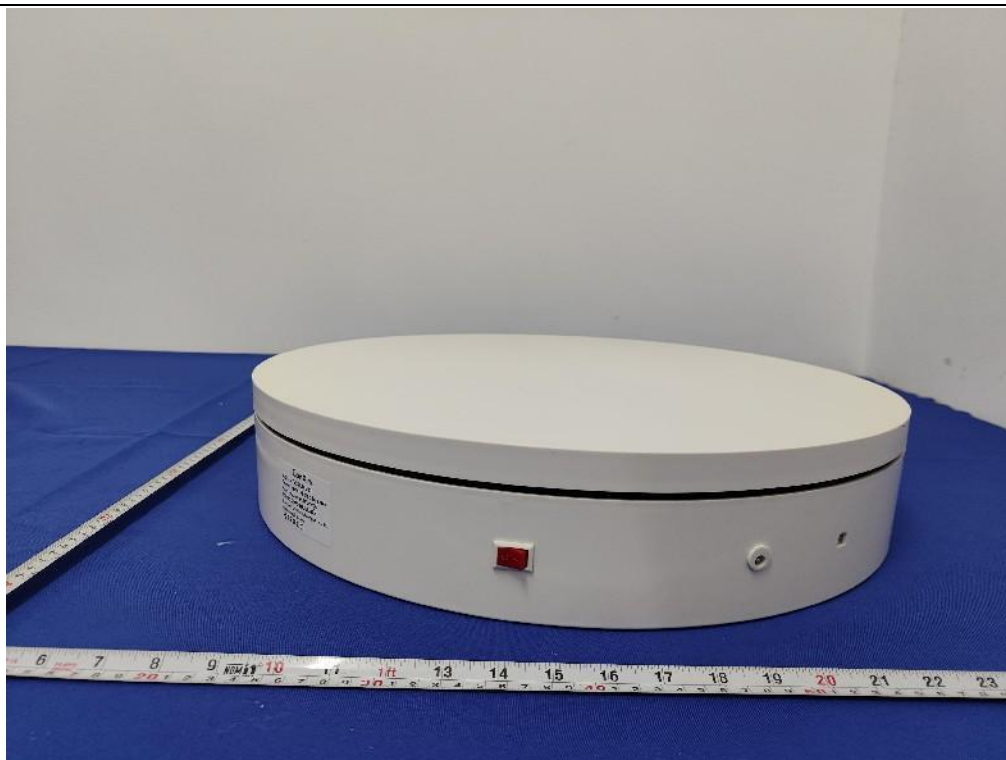

Photo 4





Photo 5

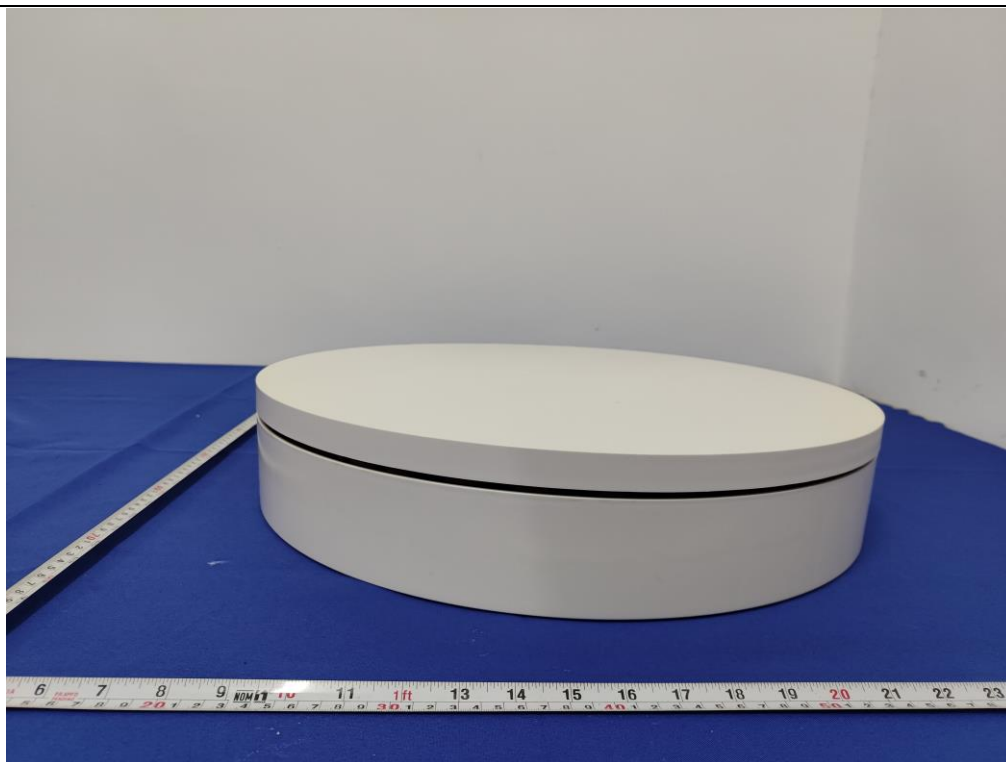

Photo 6

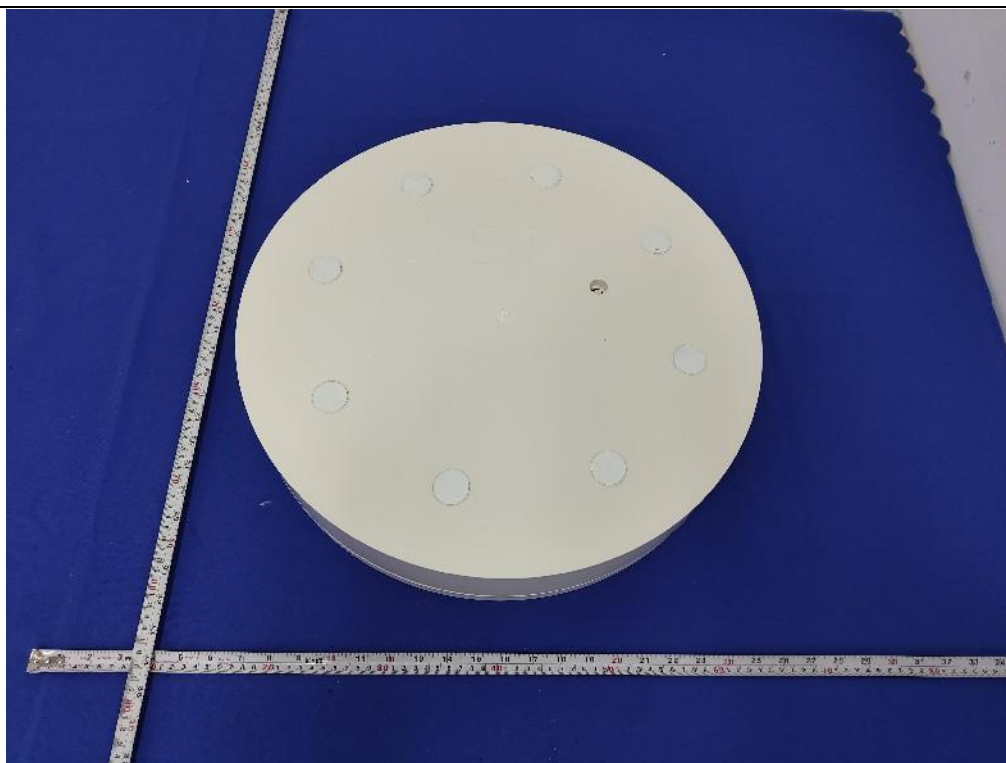

Photo 7

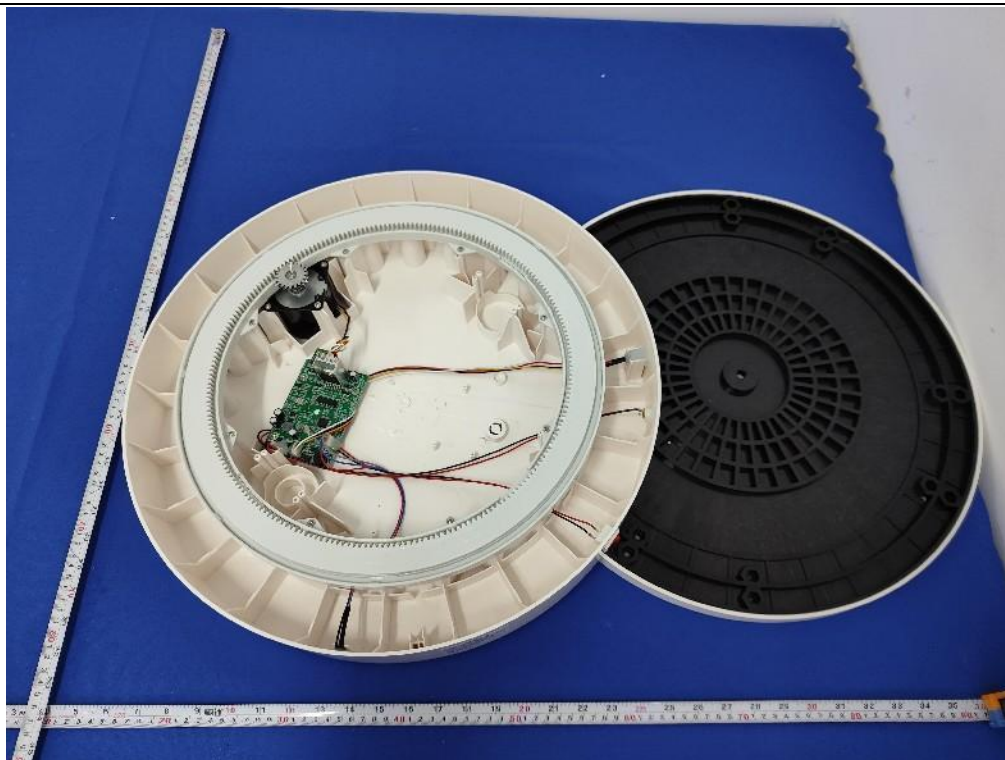

Photo 8

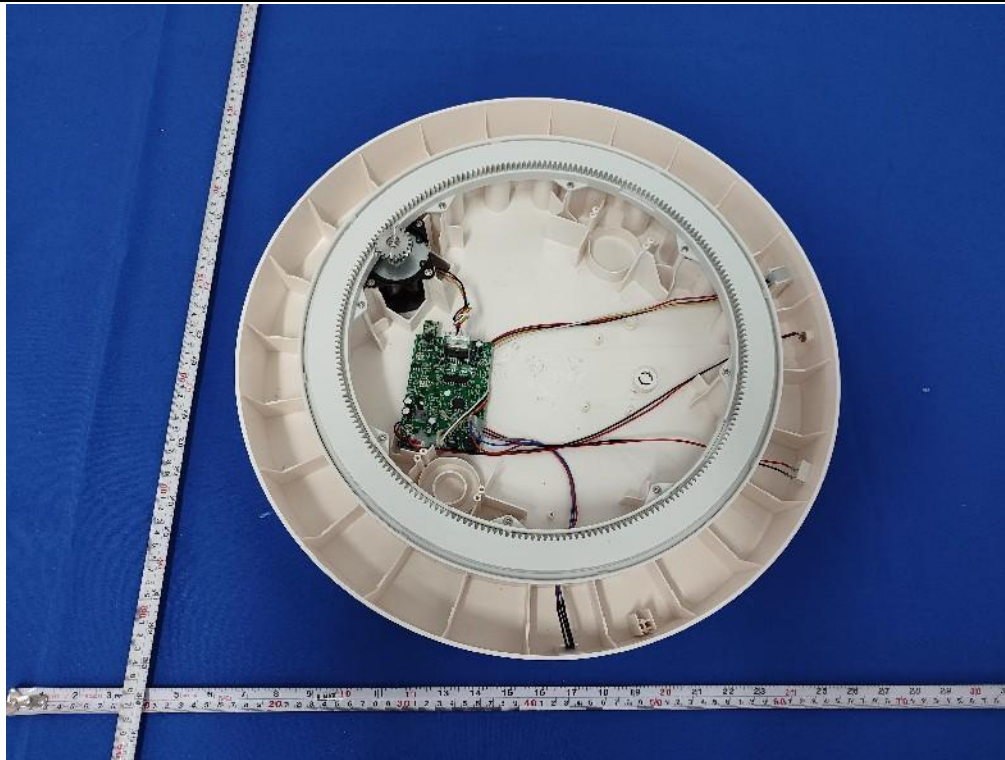

Photo 9

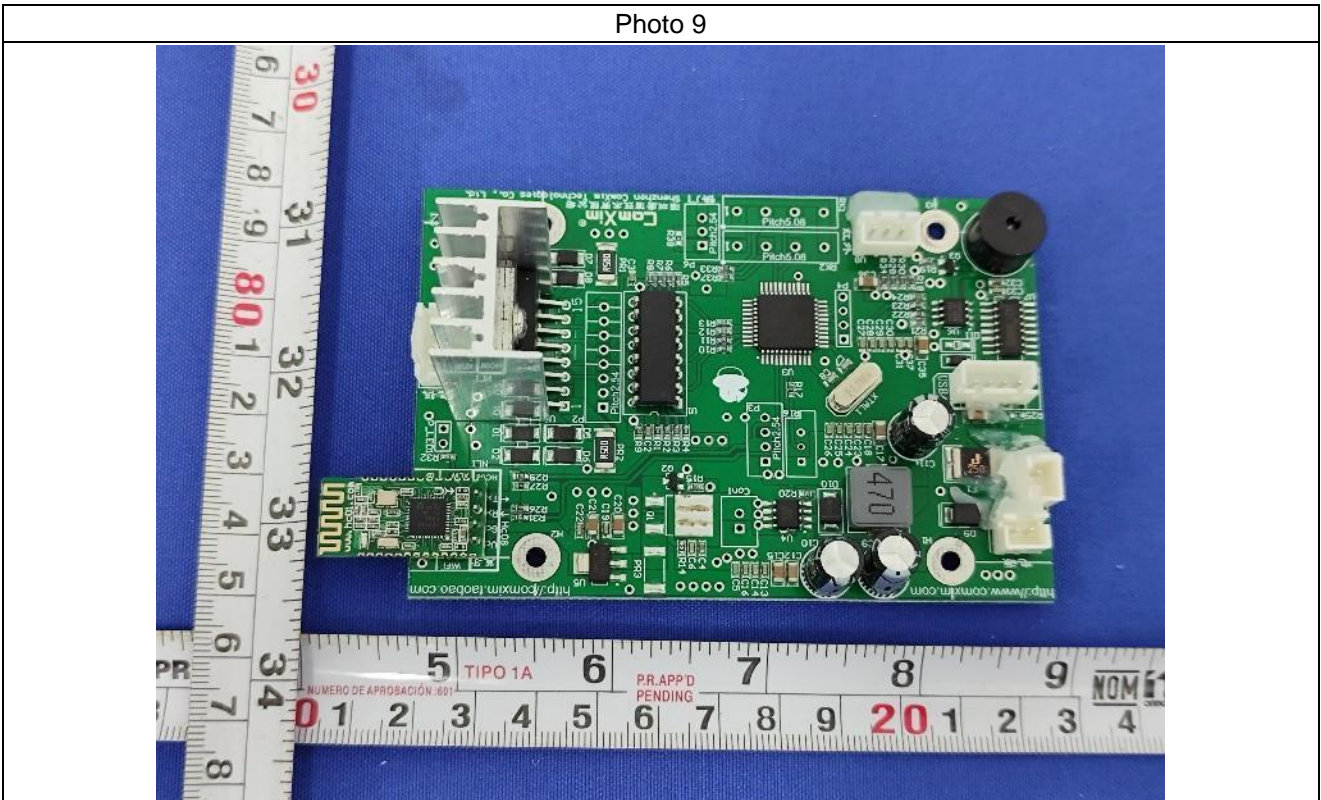

Photo 10

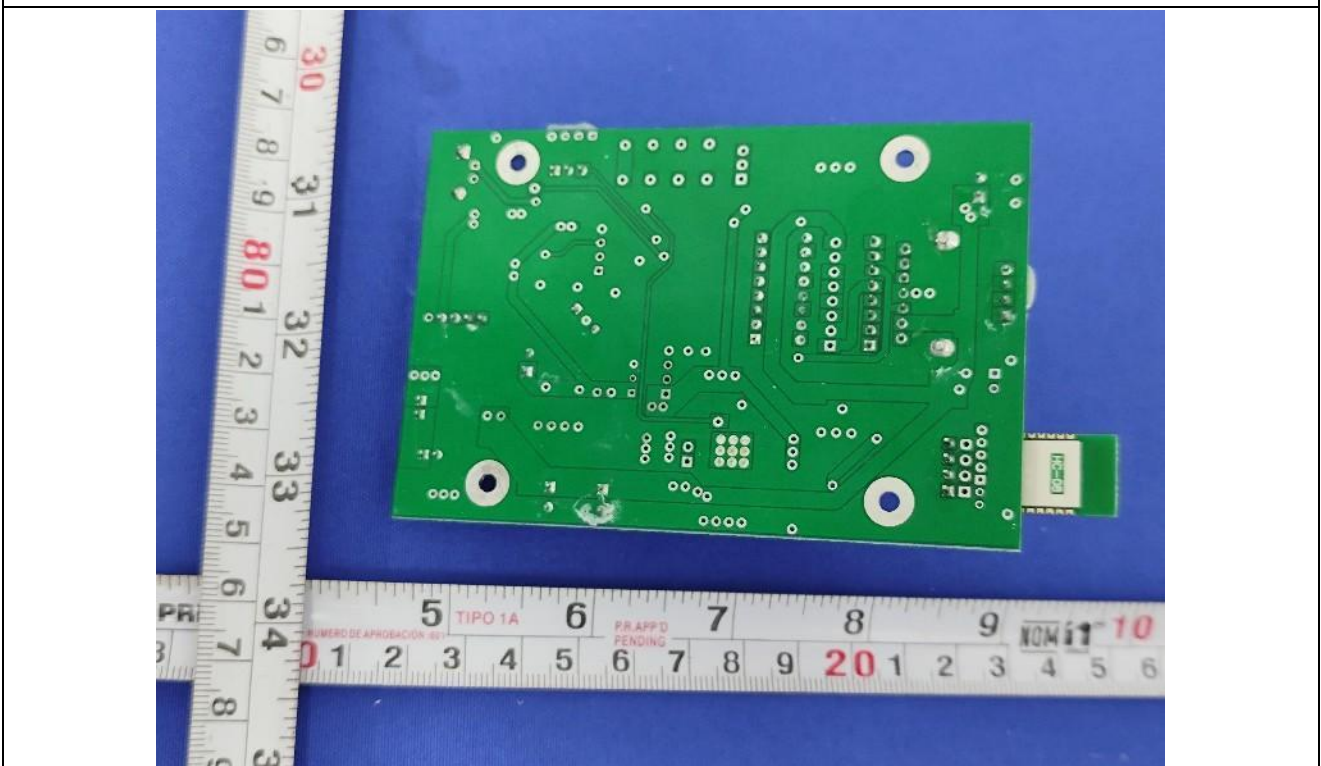

Photo 11

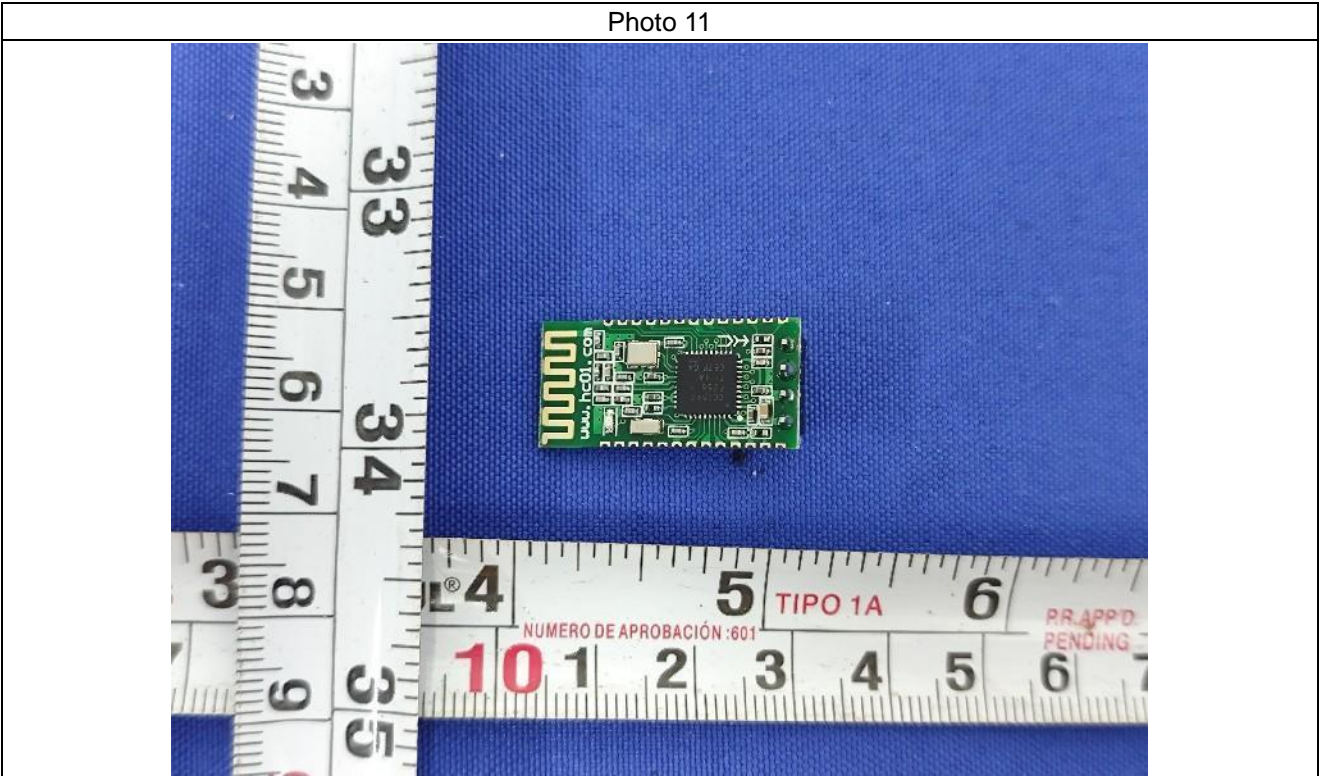

Photo 12

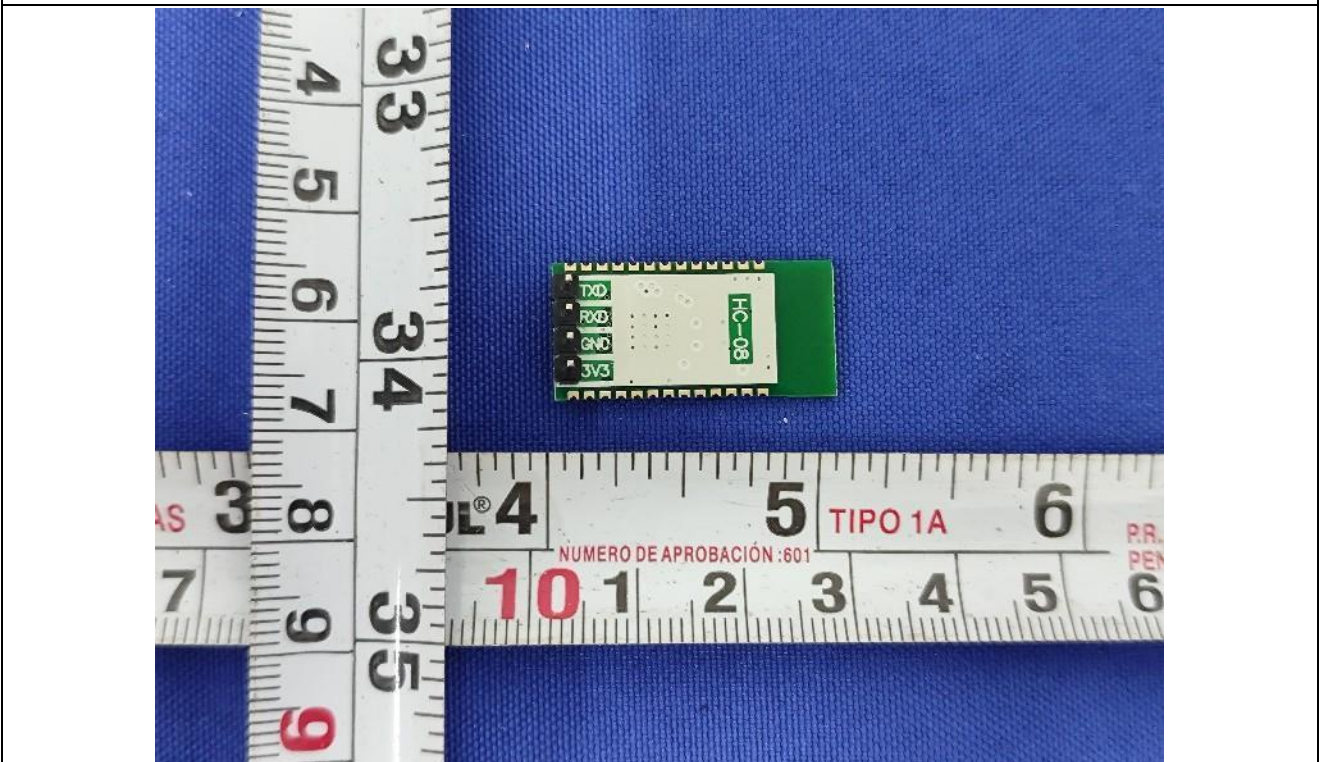

Photo 13



\*\*\*\*\* END OF REPORT \*\*\*\*\*