

# TEST REPORT

Report No.: BCTC2403460975E

---

Applicant: Guangdong Trudian Technology Co., Ltd.

---

Product Name: IP video Intercom-Door Station

---

Test Model: TD-D2

---

Tested Date: 2024-03-04 to 2024-03-21

---

Issued Date: 2024-03-21

---

**Shenzhen BCTC Testing Co., Ltd.**



SHENZHEN

# FCC ID: 2BB22-TD-D2

Product Name: IP video Intercom-Door Station

Trademark: N/A

Model/Type reference: TD-D2  
TD-D3, TD-D80, TD-D232, TD-D4, TD-D90, TD-D801, TD-D5, TD-D31, TD-D901,  
TD-D21C, TD-D32, TD-D404, TD-D51C, TD-D40, TD-D408, TD-D6, TD-D41,  
TD-D410, TD-D9

Prepared For: Guangdong Trudian Technology Co., Ltd.

Address: Farbell Technology Park, Yixian Road, Nanlang, Cuiheng New District,  
Zhongshan City, Guangdong Province, China. Zip Code:528451

Manufacturer: Guangdong Trudian Technology Co., Ltd.

Address: Farbell Technology Park, Yixian Road, Nanlang, Cuiheng New District,  
Zhongshan City, Guangdong Province, China. Zip Code:528451

Prepared By: Shenzhen BCTC Testing Co., Ltd.

Address: 1-2/F., Building B, Pengzhou Industrial Park, No.158, Fuyuan 1st Road, Zhancheng,  
Fuhai Subdistrict, Bao'an District, Shenzhen, Guangdong, China

Sample Received Date: 2024-03-04

Sample tested Date: 2024-03-04 to 2024-03-21

Issue Date: 2024-03-21

Report No.: BCTC2403460975E

Test Standards: FCC Part15.225  
ANSI C63.10-2013

Test Results: PASS

Remark: This is NFC radio test report.

Tested by:

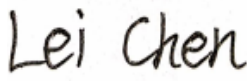

Lei Chen/Project Handler

Approved by:



Zero Zhou/Reviewer

The test report is effective only with both signature and specialized stamp. This result(s) shown in this report refer only to the sample(s) tested. Without written approval of Shenzhen BCTC Testing Co., Ltd, this report can't be reproduced except in full. The tested sample(s) and the sample information are provided by the client.

## Table Of Content

Test Report Declaration	Page
1. Version .....	5
2. Test Summary .....	6
3. Measurement Uncertainty .....	7
4. Product Information And Test Setup .....	8
4.1 Product Information .....	8
4.2 Test Setup Configuration .....	8
4.3 Support Equipment .....	8
4.4 Channel List .....	9
4.5 Test Mode .....	9
5. Test Facility And Test Instrument Used .....	10
5.1 Test Facility .....	10
5.2 Test Instrument Used .....	10
6. Conducted Emissions .....	12
6.1 Block Diagram Of Test Setup .....	12
6.2 Limit .....	12
6.3 Test Procedure .....	12
6.4 EUT operating Conditions .....	12
6.5 Test Result .....	13
7. Radiated Emissions .....	15
7.1 Block Diagram Of Test Setup .....	15
7.2 Limit .....	16
7.3 EUT Operating Conditions .....	17
7.4 Test Result .....	18
8. Radiated Band Emission Measurement .....	21
8.1 Block Diagram Of Test Setup .....	21
8.2 Limit .....	21
8.3 Test Procedure .....	22
8.4 EUT Operating Conditions .....	22
8.5 Test Result .....	23
9. Bandwidth Test .....	24
9.1 Block Diagram Of Test Setup .....	24
9.2 Test Procedure .....	24
9.3 EUT Operation Conditions .....	24
9.4 Test Result .....	25
10. Transmitter Frequency Stability .....	26
10.1 Block Diagram Of Test Setup .....	26
10.2 Limit .....	26
10.3 Test Procedure .....	26
10.4 EUT Operating Conditions .....	26
10.5 Test Result .....	27
11. Antenna Requirement .....	28
11.1 Standard Requirement .....	28

BCTC  
 BCTC  
 PPR  
 Report



11.2 EUT Antenna .....28  
12. EUT Photographs.....29  
13. EUT Test Setup Photographs.....30

(Note: N/A Means Not Applicable)

TEC  
TC  
OVE  
t See

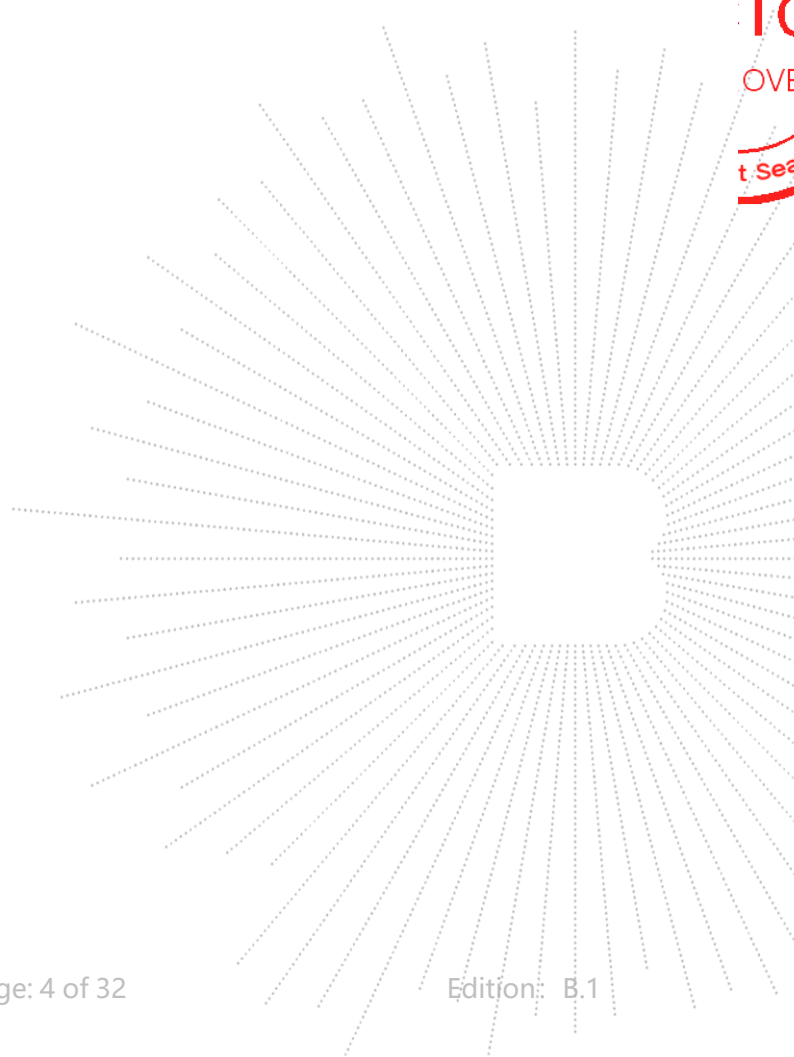

**1. Version**

<b>Report No.</b>	<b>Issue Date</b>	<b>Description</b>	<b>Approved</b>
BCTC2403460975E	2024-03-21	Original	Valid

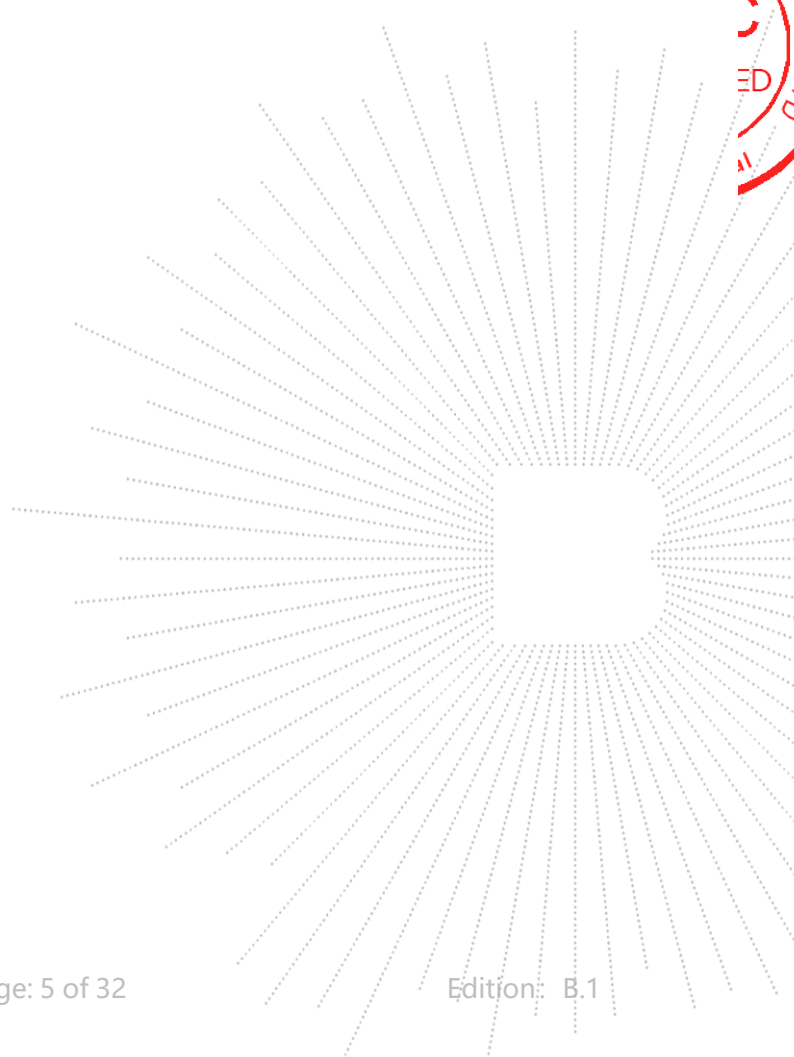

## 2. Test Summary

The Product has been tested according to the following specifications:

No.	Test Parameter	Clause No	Results
1	15.207	Conducted Emission	PASS
2	Part 15.209(a), 15.225(d)	Radiated Spurious Emission	PASS
3	15.215	Bandwidth	PASS
4	Part 15.209(a), 15.225(a)(b)(c)(d)	Band Edge Emission	PASS
5	Part 15.225(e)	Transmitter Frequency Stability (Temperature & Voltage Variation)	PASS
6	15.203	Antenna Requirement	PASS

 CO. LTD

### 3. Measurement Uncertainty

Where relevant, the following measurement uncertainty levels have been estimated for tests performed on the Product as specified in CISPR 16-4-2. This uncertainty represents an expanded uncertainty expressed at approximately the 95% confidence level using a coverage factor of k=2.

No.	Item	Uncertainty
1	3m chamber Radiated spurious emission(30MHz-1GHz)	U=4.3dB
2	3m chamber Radiated spurious emission(9KHz-30MHz)	U=3.7dB
3	3m chamber Radiated spurious emission(1GHz-18GHz)	U=4.5dB
4	3m chamber Radiated spurious emission(18GHz-40GHz)	U=3.34dB
5	Conducted Emission (150kHz-30MHz)	U=3.20dB
6	Conducted Adjacent channel power	U=1.38dB
7	Conducted output power uncertainty Above 1G	U=1.576dB
8	Conducted output power uncertainty below 1G	U=1.28dB
9	humidity uncertainty	U=5.3%
10	Temperature uncertainty	U=0.59°C

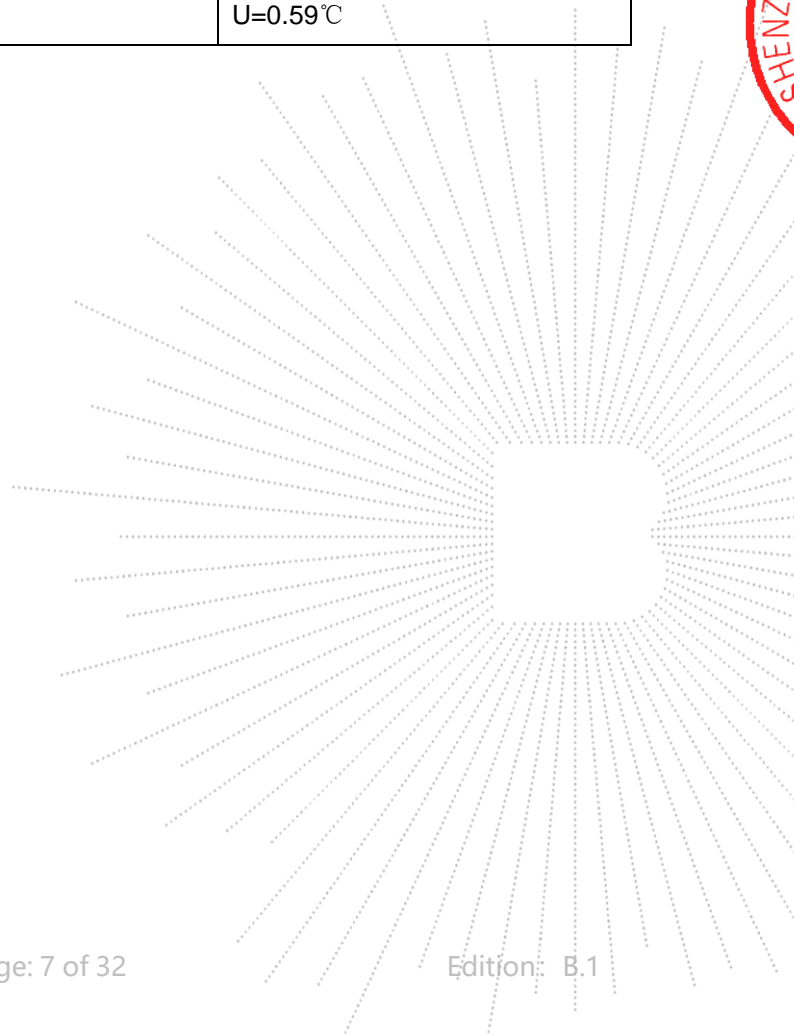
## 4. Product Information And Test Setup

### 4.1 Product Information

Model/Type reference:	TD-D2 TD-D3, TD-D80, TD-D232, TD-D4, TD-D90, TD-D801, TD-D5, TD-D31, TD-D901, TD-D21C, TD-D32, TD-D404, TD-D51C, TD-D40, TD-D408, TD-D6, TD-D41, TD-D410, TD-D9
Model differences:	All the model are the same circuit and RF module, except model names and appearance of the color.
Hardware Version:	N/A
Software Version:	N/A
Operation Frequency:	13.56 MHz
Modulation Type:	ASK
Number Of Channel	1 CH
Antenna installation:	PCB Antenna
Antenna Gain:	3 dBi
	Remark: <input checked="" type="checkbox"/> The antenna gain of the product comes from the antenna report provided by the customer, and the test data is affected by the customer information. <input type="checkbox"/> The antenna gain of the product is provided by the customer, and the test data is affected by the customer information.
Ratings:	DC 12V

### 4.2 Test Setup Configuration

See test photographs attached in *EUT TEST SETUP PHOTOGRAPHS* for the actual connections between Product and support equipment.  
Conducted & Radiated Spurious Emission

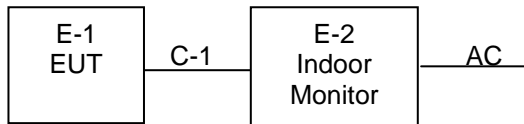

### 4.3 Support Equipment

No.	Device Type	Brand	Model	Series No.	Note
E-1	IP video Intercom-Door Station	N/A	TD-D2	More models Ref. the 4.1	EUT
E-2	IP video Intercom-Indoor Monitor	N/A	TD-R36	N/A	Auxiliary

Item	Shielded Type	Ferrite Core	Length	Note
C-1	NO	NO	0.3M	DC cable unshielded

Notes:

- All the equipment/cables were placed in the worst-case configuration to maximize the emission during the test.
- Grounding was established in accordance with the manufacturer's requirements and conditions for the intended use.



#### 4.4 Channel List

Channel List	
Channel	Frequency(MHz)
01	13.56

#### 4.5 Test Mode

To investigate the maximum EMI emission characteristics generates from EUT, the test system was pre-scanning tested base on the consideration of following EUT operation mode or test configuration mode which possible have effect on EMI emission level. Each of these EUT operation mode(s) or test configuration mode(s) mentioned above was evaluated respectively.

For All Mode	Description
Mode 1	TX Mode

Link mode(conducted emission and Radiated emission)	
Final Test Mode	Description
Mode 1	TX Mode

#### Notes:

- (1) The measurements are performed at the highest, middle, lowest available channels.
- (2) Fully-charged battery is used during the test.

BCTC  
 BCTC  
 PPR  
 Report

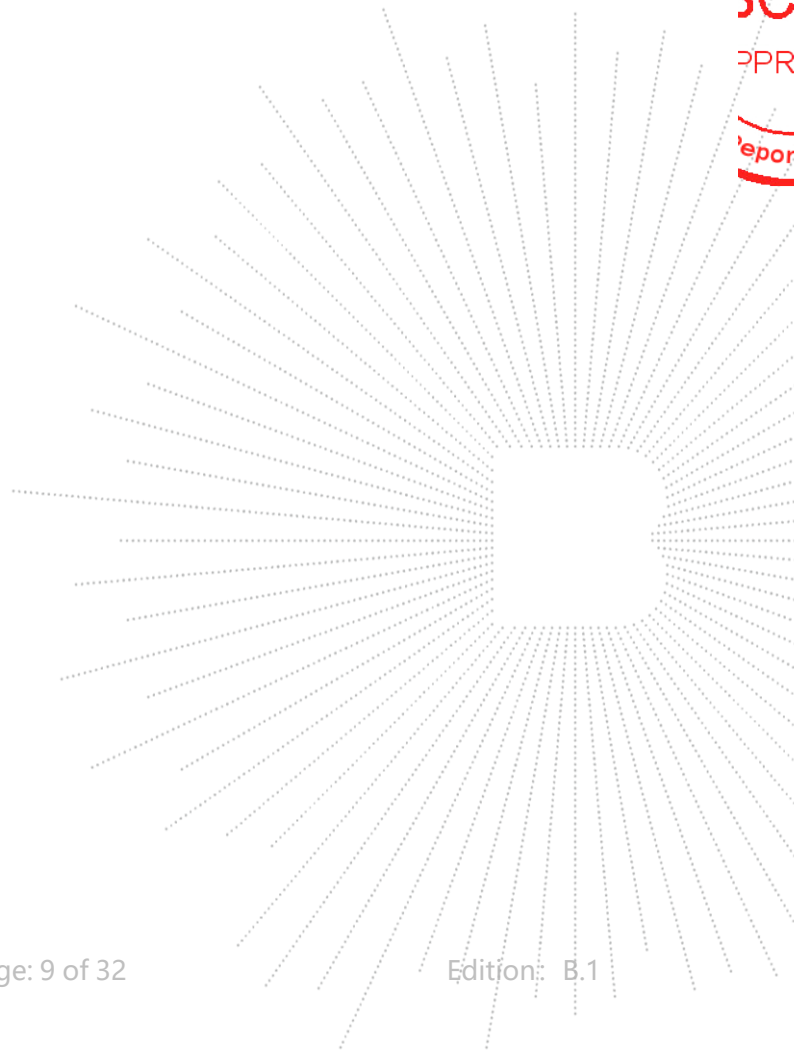

## 5. Test Facility And Test Instrument Used

### 5.1 Test Facility

All measurement facilities used to collect the measurement data are located at Shenzhen BCTC Testing Co., Ltd. Address: 1-2/F., Building B, Pengzhou Industrial Park, No.158, Fuyuan 1st Road, Zhancheng, Fuhai Subdistrict, Bao'an District, Shenzhen, Guangdong, China. The site and apparatus are constructed in conformance with the requirements of ANSI C63.4 and CISPR 16-1-1 other equivalent standards.

FCC Test Firm Registration Number: 712850

A2LA certificate registration number is: CN1212

ISED Registered No.: 23583

ISED CAB identifier: CN0017

### 5.2 Test Instrument Used

Conducted Emissions Test					
Equipment	Manufacturer	Model#	Serial#	Last Cal.	Next Cal.
Receiver	R&S	ESR3	102075	May 15, 2023	May 14, 2024
LISN	R&S	ENV216	101375	May 15, 2023	May 14, 2024
Software	Frad	EZ-EMC	EMC-CON 3A1	\	\
Pulse limiter	Schwarzbeck	VTSD9561-F	01323	Sept. 22, 2023	Sept. 21, 2024

RF Conducted Test					
Equipment	Manufacturer	Model#	Serial#	Last Cal.	Next Cal.
Power meter	Keysight	E4419	\	May 15, 2023	May 14, 2024
Power Sensor (AV)	Keysight	E9300A	\	May 15, 2023	May 14, 2024
Signal Analyzer20kHz-26.5GHz	Keysight	N9020A	MY49100060	May 15, 2023	May 14, 2024
Spectrum Analyzer9kHz-40GHz	R&S	FSP40	100363	May 15, 2023	May 14, 2024

Radiated Emissions Test (966 Chamber01)					
Equipment	Manufacturer	Model#	Serial#	Last Cal.	Next Cal.
966 chamber	ChengYu	966 Room	966	May 15, 2023	May 14, 2026
Receiver	R&S	ESR3	102075	May 15, 2023	May 14, 2024
Receiver	R&S	ESRP	101154	May 15, 2023	May 14, 2024
Amplifier	Schwarzbeck	BBV9744	9744-0037	May 15, 2023	May 14, 2024
TRILOG Broadband Antenna	Schwarzbeck	VULB9163	942	May 29, 2023	May 28, 2024
Loop Antenna(9KHz -30MHz)	Schwarzbeck	FMZB1519B	00014	May 31, 2023	May 30, 2024
Amplifier	SKET	LAPA_01G18 G-45dB	SK2021040901	May 15, 2023	May 14, 2024
Horn Antenna	Schwarzbeck	BBHA9120D	1541	May 31, 2023	May 30, 2024
Amplifier(18G Hz-40GHz)	MITEQ	TTA1840-35-HG	2034381	May 15, 2023	May 14, 2024
Horn Antenna(18G Hz-40GHz)	Schwarzbeck	BBHA9170	00822	May 31, 2023	May 30, 2024
Spectrum Analyzer9kHz-40GHz	R&S	FSP40	100363	May 15, 2023	May 14, 2024
Software	Frad	EZ-EMC	FA-03A2 RE	\	\

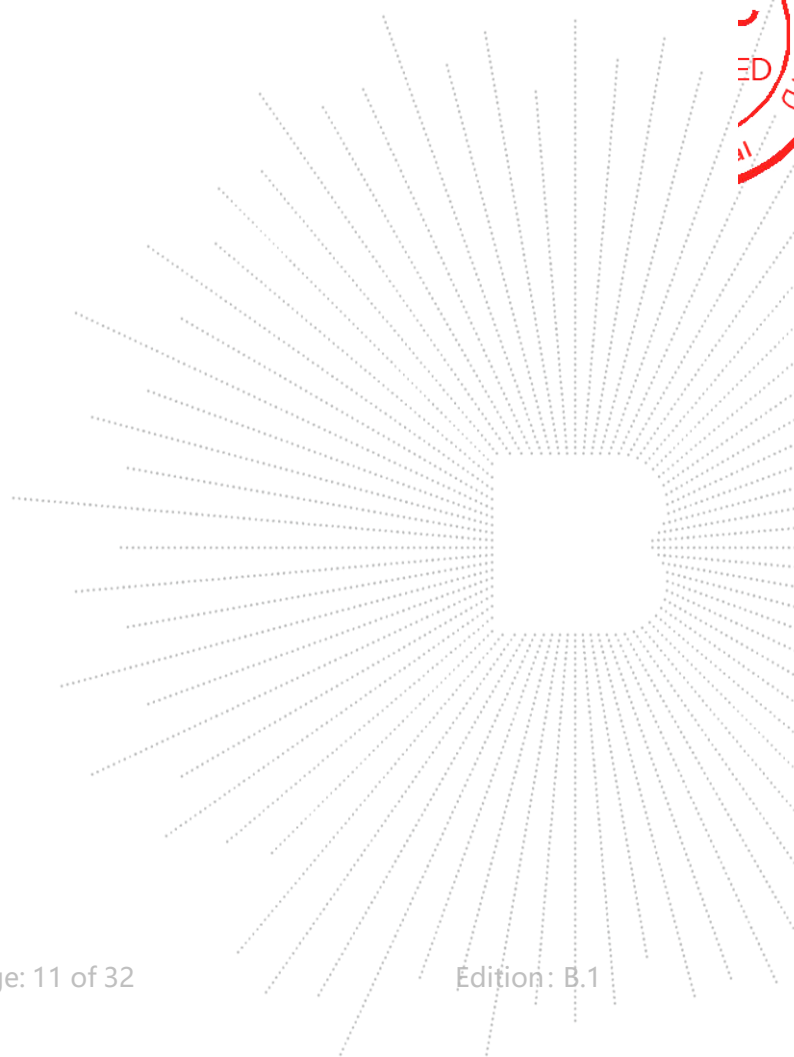

## 6. Conducted Emissions

### 6.1 Block Diagram Of Test Setup

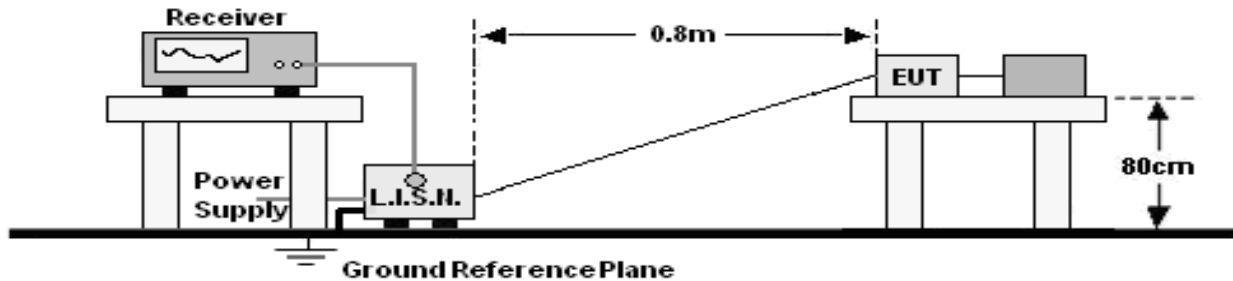

### 6.2 Limit

FREQUENCY (MHz)	Limit (dBuV)	
	Quas-peak	Average
0.15 -0.5	66 - 56 *	56 - 46 *
0.50 -5.0	56.00	46.00
5.0 -30.0	60.00	50.00

Notes:  
 1. \*Decreasing linearly with logarithm of frequency.  
 2. The lower limit shall apply at the transition frequencies.

### 6.3 Test Procedure

Receiver Parameters	Setting
Attenuation	10 dB
Start Frequency	0.15 MHz
Stop Frequency	30 MHz
IF Bandwidth	9 kHz

- The Product was placed on a nonconductive table 0.8 m above the horizontal ground reference plane, and 0.4 m from the vertical ground reference plane, and connected to the main through Line Impedance Stability Network (L.I.S.N).
- The RBW of the receiver was set at 9 kHz in 150 kHz ~ 30MHz with Peak and AVG detector in Max Hold mode. Run the receiver's pre-scan to record the maximum disturbance generated from Product in all power lines in the full band.
- For each frequency whose maximum record was higher or close to limit, measure its QP and AVG values and record.

### 6.4 EUT operating Conditions

The EUT was configured for testing in a typical fashion (as a customer would normally use it). The EUT has been programmed to continuously transmit during test. This operating condition was tested and used to collect the included data.

## 6.5 Test Result

Temperature:	26 °C	Relative Humidity:	54%
Pressure:	101KPa	Phase :	L
Test Mode:	Mode 1	Remark:	N/A

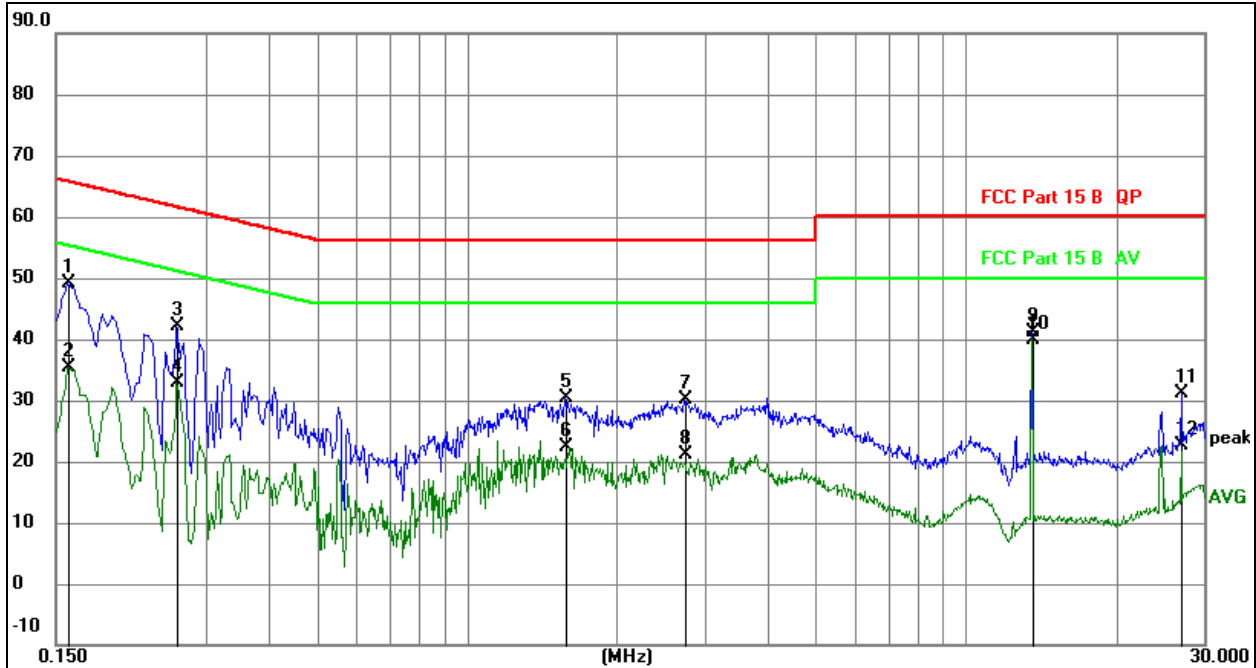

## Remark:

1. All readings are Quasi-Peak and Average values.
2. Factor = Insertion Loss + Cable Loss.
3. Measurement=Reading Level+ Correct Factor
4. Over=Measurement-Limit

No.	Mk.	Freq. MHz	Reading Level	Correct Factor dB	Measure- ment dBuV	Limit dBuV	Over dB	Detector
1		0.1590	29.28	19.75	49.03	65.52	-16.49	QP
2		0.1590	15.60	19.75	35.35	55.52	-20.17	AVG
3		0.2625	22.29	19.83	42.12	61.35	-19.23	QP
4		0.2625	12.96	19.83	32.79	51.35	-18.56	AVG
5		1.5720	10.54	19.95	30.49	56.00	-25.51	QP
6		1.5720	2.40	19.95	22.35	46.00	-23.65	AVG
7		2.7285	9.97	20.21	30.18	56.00	-25.82	QP
8		2.7285	0.80	20.21	21.01	46.00	-24.99	AVG
9		13.5600	21.13	19.88	41.01	60.00	-18.99	QP
10	*	13.5600	20.12	19.88	40.00	50.00	-10.00	AVG
11		27.1185	11.16	19.99	31.15	60.00	-28.85	QP
12		27.1185	2.70	19.99	22.69	50.00	-27.31	AVG

SHENZHEN

Temperature:	26 °C	Relative Humidity:	54%
Pressure:	101KPa	Phase :	N
Test Mode:	Mode 1	Remark:	N/A

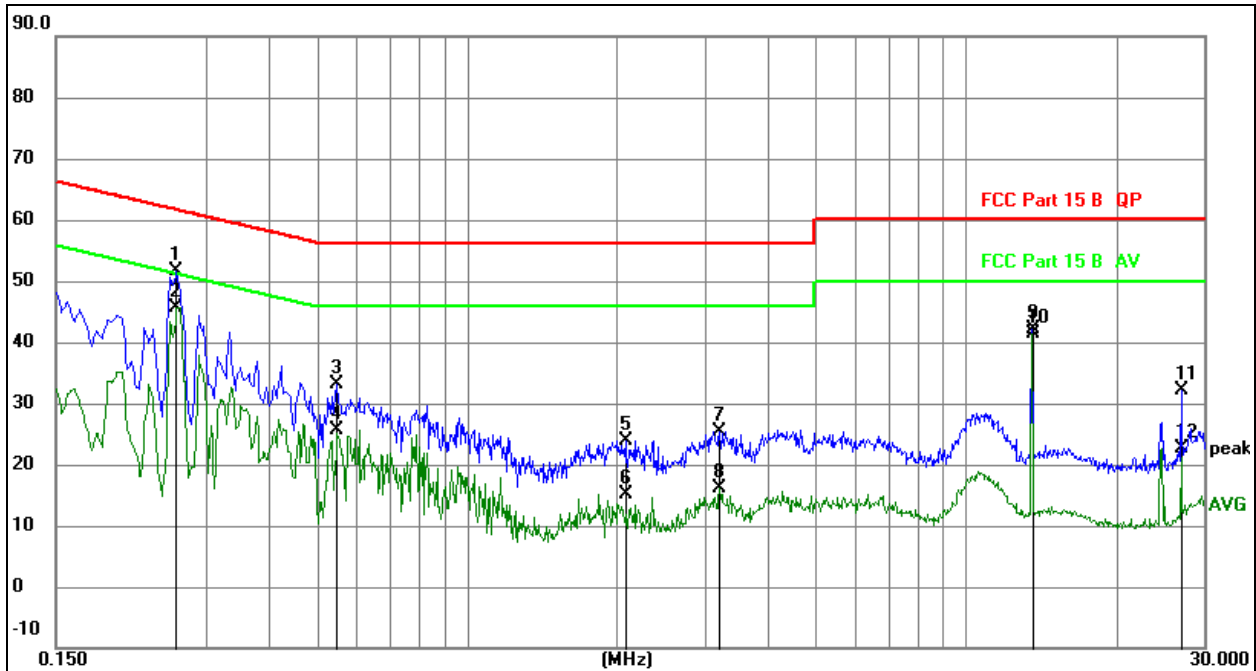
**Remark:**

1. All readings are Quasi-Peak and Average values.
2. Factor = Insertion Loss + Cable Loss.
3. Measurement=Reading Level+ Correct Factor
4. Over=Measurement-Limit

No.	Mk.	Freq. MHz	Reading Level	Correct Factor dB	Measure- ment dBuV	Limit dBuV	Over dB	Detector
1		0.2615	31.72	19.83	51.55	61.38	-9.83	QP
2	*	0.2615	25.87	19.83	45.70	51.38	-5.68	AVG
3		0.5493	13.29	19.84	33.13	56.00	-22.87	QP
4		0.5493	5.73	19.84	25.57	46.00	-20.43	AVG
5		2.0768	3.96	19.98	23.94	56.00	-32.06	QP
6		2.0768	-4.94	19.98	15.04	46.00	-30.96	AVG
7		3.2069	5.07	20.38	25.45	56.00	-30.55	QP
8		3.2069	-4.25	20.38	16.13	46.00	-29.87	AVG
9		13.5509	22.13	19.88	42.01	60.00	-17.99	QP
10		13.5509	21.54	19.88	41.42	50.00	-8.58	AVG
11		26.9836	12.26	19.99	32.25	60.00	-27.75	QP
12		26.9836	2.58	19.99	22.57	50.00	-27.43	AVG

## 7. Radiated Emissions

### 7.1 Block Diagram Of Test Setup

(A) Radiated Emission Test-Up Frequency Below 30MHz

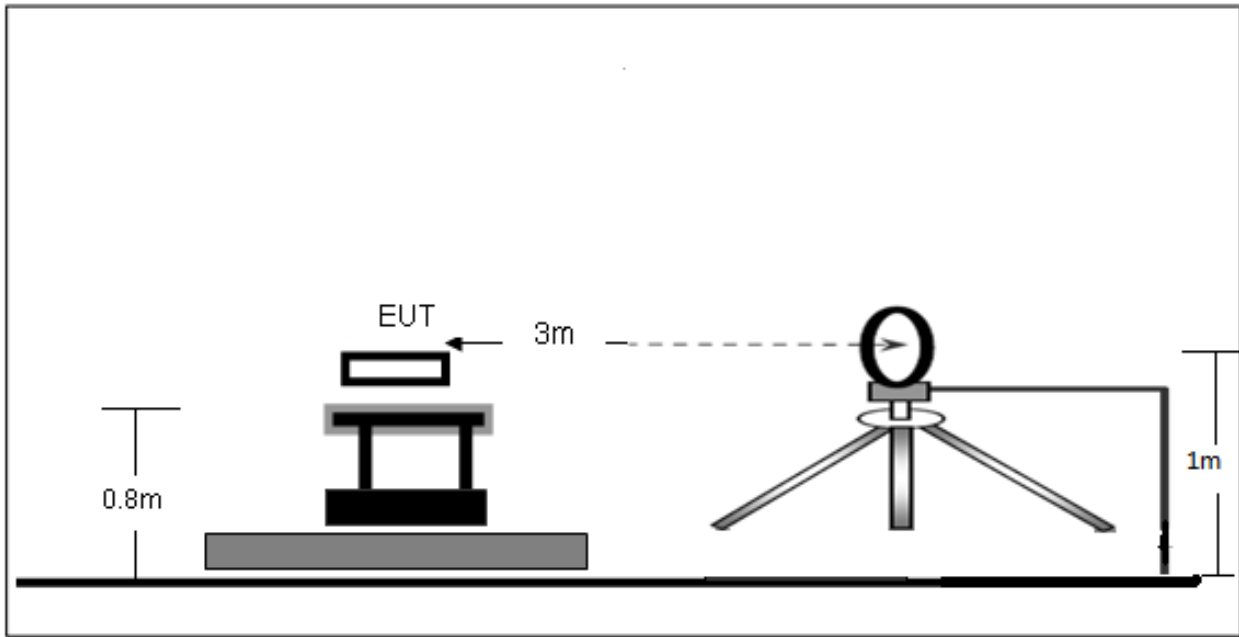

(B) Radiated Emission Test-Up Frequency 30MHz~1GHz

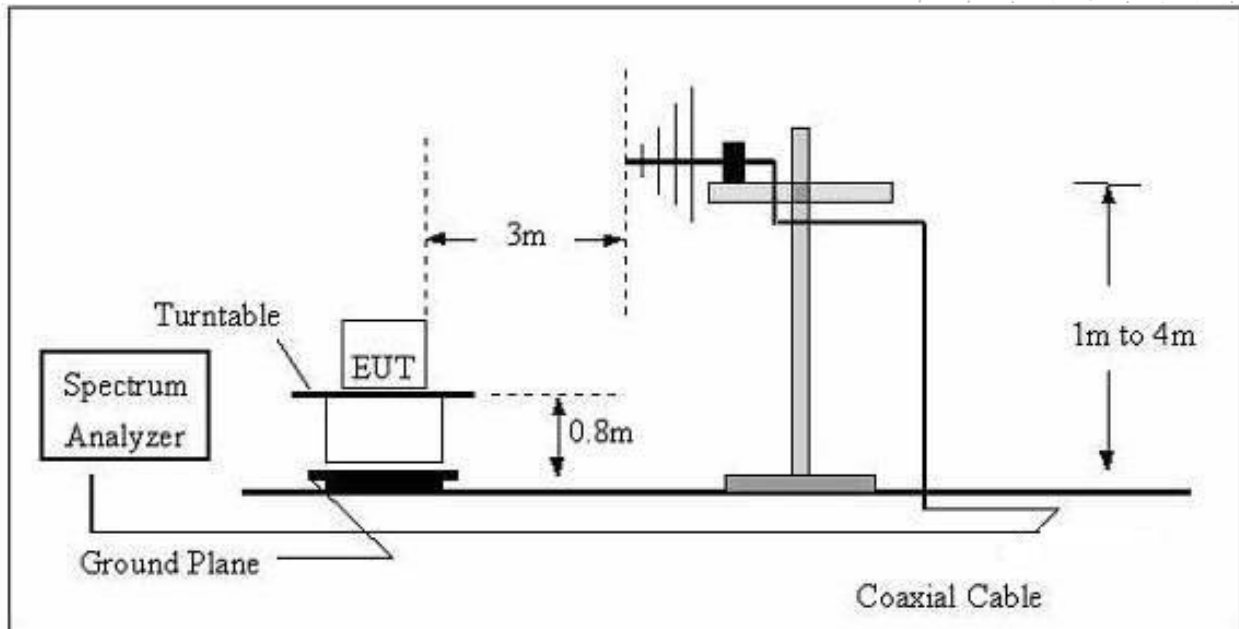

## 7.2 Limit

20dBc in any 100 kHz bandwidth outside the operating frequency band. In case the emission fall within the restricted band specified on 15.205(a), then the 15.209(a) limit in the table below has to be followed.

Frequency (MHz)	Field Strength uV/m	Distance (m)	Field Strength Limit at 3m Distance	
			uV/m	dBuV/m
0.009 ~ 0.490	2400/F(kHz)	300	$10000 * 2400/F(kHz)$	$20\log^{(2400/F(kHz))} + 80$
0.490 ~ 1.705	24000/F(kHz)	30	$100 * 24000/F(kHz)$	$20\log^{(24000/F(kHz))} + 40$
1.705 ~ 30	30	30	$100 * 30$	$20\log^{(30)} + 40$
30 ~ 88	100	3	100	$20\log^{(100)}$
88 ~ 216	150	3	150	$20\log^{(150)}$
216 ~ 960	200	3	200	$20\log^{(200)}$
Above 960	500	3	500	$20\log^{(500)}$

Receiver Parameter	Setting
Attenuation	Auto
Start ~ Stop Frequency	9kHz~150kHz / RB 200Hz for QP
Start ~ Stop Frequency	150kHz~30MHz / RB 9kHz for QP
Start ~ Stop Frequency	30MHz~1000MHz / RB 120kHz for QP

Below 1GHz test procedure as below:

- The EUT was placed on the top of a rotating table 0.8 meters above the ground at a 3 meter semi-anechoic chamber. The table was rotated 360 degrees to determine the position of the highest radiation.
- The EUT was set 3 meters away from the interference-receiving antenna, which was mounted on the top of a variable-height antenna tower.
- The antenna height is varied from one meter to four meters above the ground to determine the maximum value of the field strength. Both horizontal and vertical polarizations of the antenna are set to make the measurement.
- For each suspected emission, the EUT was arranged to its worst case and then the antenna was tuned to heights from 1 meter to 4 meters (for the test frequency of below 30MHz, the antenna was tuned to heights 1 meter) and the rotatable table was turned from 0 degrees to 360 degrees to find the maximum reading.
- The test-receiver system was set to Peak Detect Function and Specified Bandwidth with Maximum Hold Mode.
- If the emission level of the EUT in peak mode was 10dB lower than the limit specified, then testing could be stopped and the peak values of the EUT would be reported. Otherwise the emissions that did not have 10dB margin would be re-tested one by one using peak, quasi-peak or average method as specified and then reported in a data sheet.

Above 1GHz test procedure as below:

- Different between above is the test site, change from Semi- Anechoic Chamber to fully Anechoic Chamber and change form table 0.8 metre to 1.5 metre( Above 18GHz the distance is 1 meter and table is 1.5 metre).
- Test the EUT in the lowest channel ,the middle channel ,the Highest channel.

Note:

Both horizontal and vertical antenna polarities were tested and performed pretest to three orthogonal axis. The worst case emissions were reported.



### 7.3 EUT Operating Conditions

The EUT was configured for testing in a typical fashion (as a customer would normally use it). The EUT has been programmed to continuously transmit during test. This operating condition was tested and used to collect the included data.

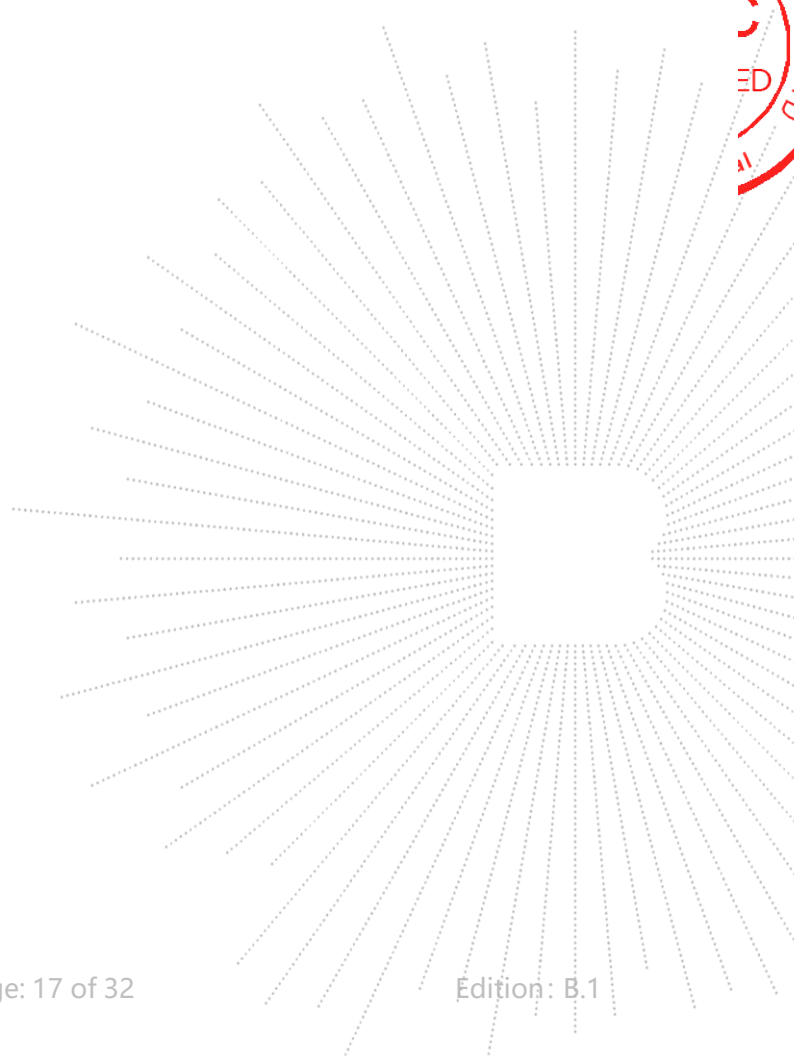

## 7.4 Test Result

Temperature:	26°C	Relative Humidity:	54%
Pressure:	101 kpa	Test Voltage:	DC 12V
Test Mode:	Mode 1	Polarization:	Coaxial (The worst test result)

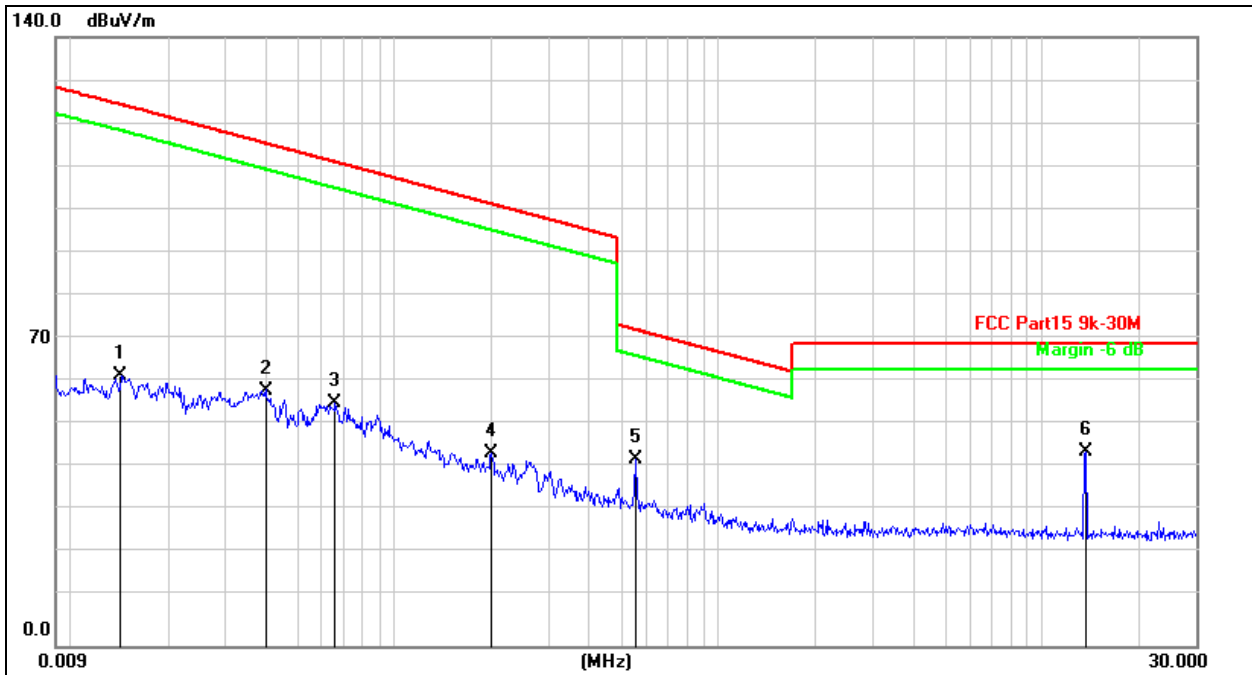

No.	Mk.	Freq. MHz	Reading Level dBuV	Correct Factor dB	Measure- ment dBuV/m	Limit dB/m	Over dB	Detector
1		0.0143	69.67	-7.47	62.20	124.5	-62.30	peak
2		0.0400	66.16	-7.36	58.80	115.5	-56.76	peak
3		0.0656	63.37	-7.60	55.77	111.2	-55.50	peak
4		0.1995	52.18	-7.78	44.40	101.6	-57.21	peak
5		0.5590	50.50	-7.51	42.99	72.66	-29.67	peak
6	*	13.6585	51.82	-7.23	44.59	69.54	-24.95	peak

Note:

Pre-scan in the all of mode, the worst case in of was recorded.

Factor = antenna factor + cable loss – pre-amplifier.

Margin = Emission Level- Limit.

Between 30MHz – 1GHz

Temperature:	26 °C	Relative Humidity:	54%
Pressure:	101KPa	Phase :	Horizontal
Test Mode:	Mode 1	Remark:	N/A

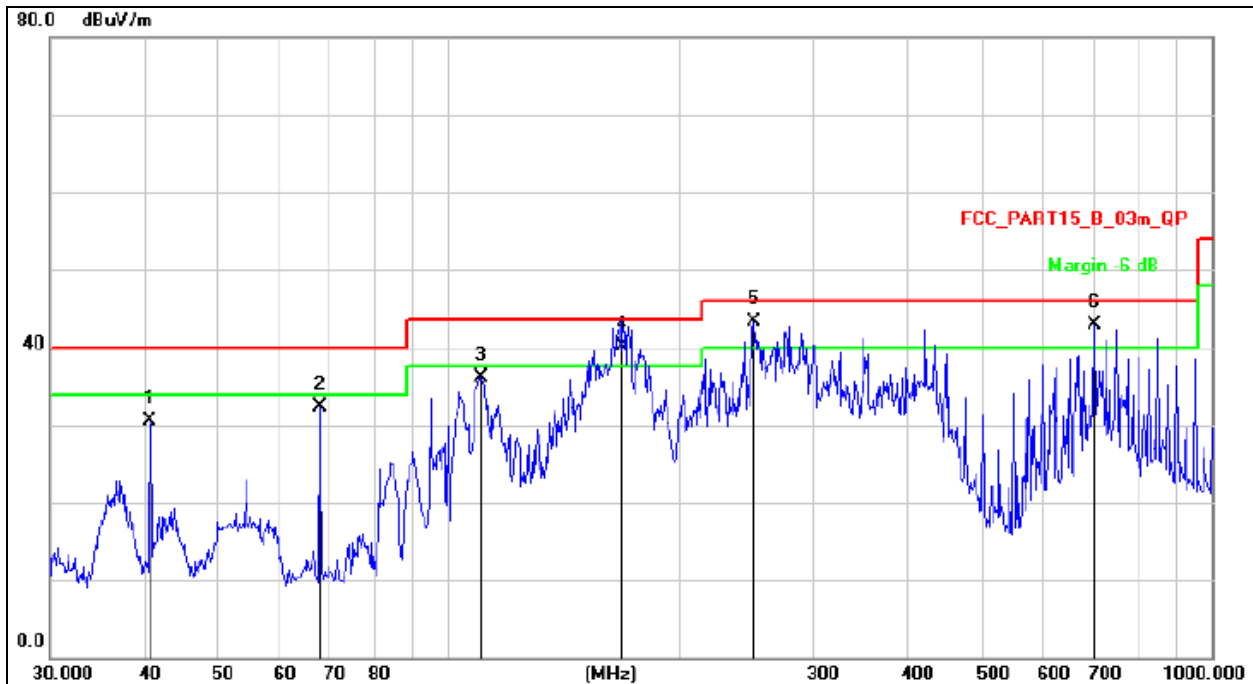

Remark:

1. Factor = Antenna Factor + Cable Loss – Pre-amplifier.
2. Measurement=Reading Level+ Correct Factor
3. Over=Measurement-Limit

No.	Mk.	Freq. MHz	Reading Level dBuV	Correct Factor dB	Measure- ment dBuV/m	Limit dB/m	Over dB	Detector
1		40.5591	45.23	-14.67	30.56	40.00	-9.44	QP
2		67.6751	49.75	-17.36	32.39	40.00	-7.61	QP
3		110.1816	52.79	-16.64	36.15	43.50	-7.35	QP
4	!	169.0454	58.16	-18.02	40.14	43.50	-3.36	QP
5	*	251.1802	57.62	-14.26	43.36	46.00	-2.64	QP
6	!	701.7607	48.62	-5.68	42.94	46.00	-3.06	QP

SHENZHEN

Temperature:	26 °C	Relative Humidity:	54%
Pressure:	101KPa	Phase :	Vertical
Test Mode:	Mode 1	Remark:	N/A

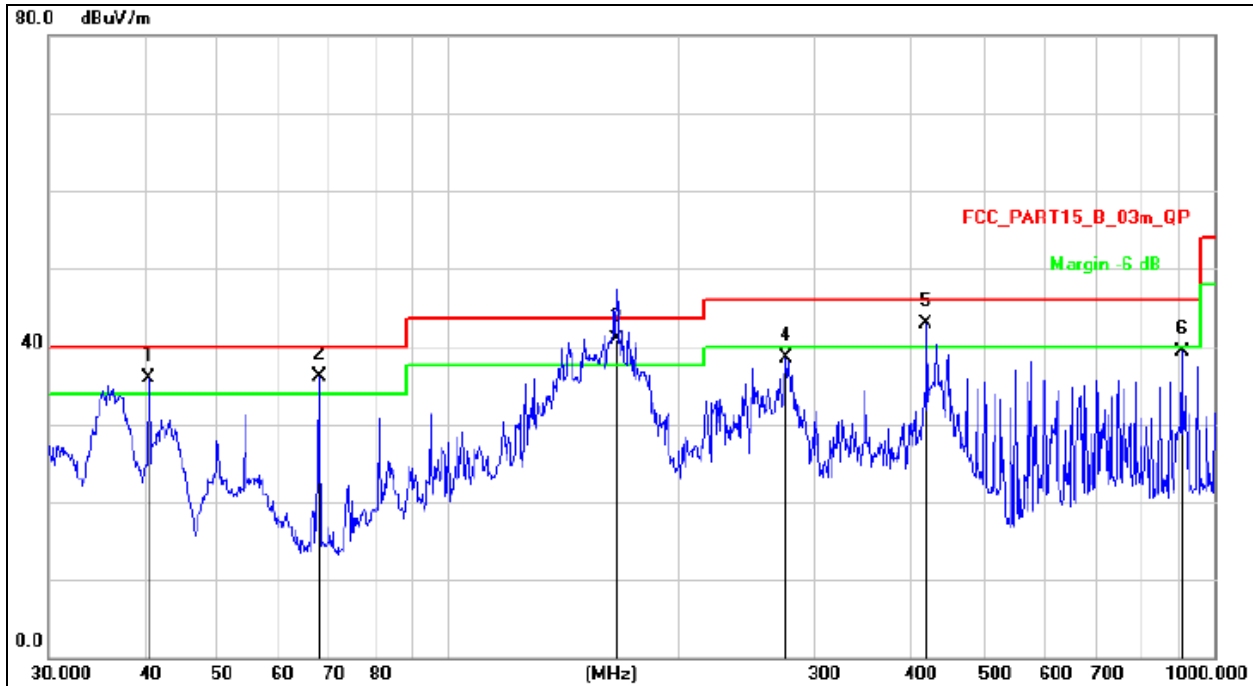

Remark:

1. Factor = Antenna Factor + Cable Loss – Pre-amplifier.
2. Measurement=Reading Level+ Correct Factor
3. Over= Measurement-Limit

No.	Mk.	Freq. MHz	Reading Level dBuV	Correct Factor dB	Measure- ment dBuV/m	Limit dB/m	Over dB	Detector
1	!	40.5591	50.61	-14.67	35.94	40.00	-4.06	QP
2	!	67.6751	53.55	-17.36	36.19	40.00	-3.81	QP
3	*	165.4866	59.18	-18.28	40.90	43.50	-2.60	QP
4		276.1235	52.19	-13.74	38.45	46.00	-7.55	QP
5	!	420.5803	53.35	-10.44	42.91	46.00	-3.09	QP
6		906.4823	42.31	-3.10	39.21	46.00	-6.79	QP

## 8. Radiated Band Emission Measurement

### 8.1 Block Diagram Of Test Setup

Radiated Emission Test-Up Frequency Below 30MHz

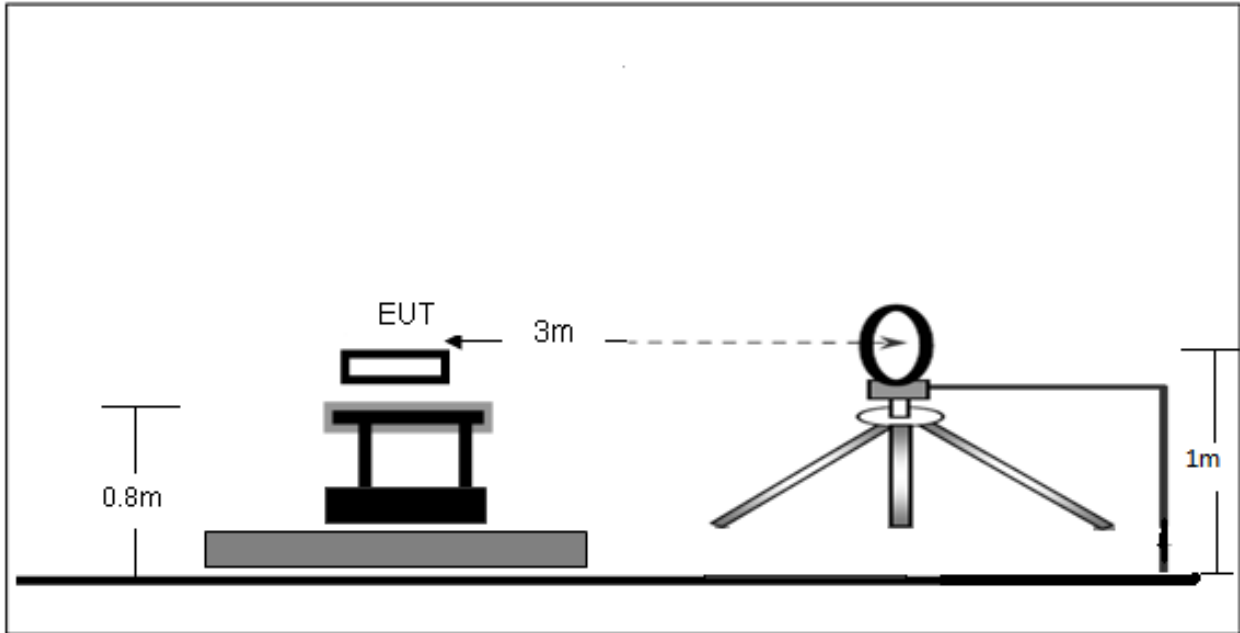

### 8.2 Limit

FCC Part15 C Section 15.209 and 15.225

LIMITS OF RADIATED EMISSION MEASUREMENT (Below 30MHz)

- 15.848 microvolts/m (84 dB $\mu$  V/m) at 30 m, within the band 13.553– 13.567 MHz.
- 334 microvolts/m (50.5 dB $\mu$  V/m) at 30 m, within the bands 13.410– 13.553 MHz and 13.567– 13.710 MHz.
- 106 microvolts/m (40.5 dB $\mu$  V/m) at 30 m, within the bands 13.110– 13.410 MHz and 13.710– 14.010 MHz.
- 30 microvolts/m (29.5 dB $\mu$  V/m) at 30 m, outside the band 13.110– 14.010 MHz.

Notes:

- (1) The limit for radiated test was performed according to FCC PART 15C.
- (2) The tighter limit applies at the band edges.
- (3) Emission level (dBuV/m)=20log Emission level (uV/m).

### 8.3 Test Procedure

- a. The Product is placed on a turntable 0.8 meters above the ground in the chamber, 3 meter away from the antenna (loop antenna). The maximum values of the field strength are recorded by adjusting the polarizations of the test antenna and rotating the turntable.
- b. For each suspected emission, the Product was arranged to its worst case and then turn table was turned from 0 degrees to 360 degrees to find the maximum reading.
- c. The test frequency analyzer system was set to Peak Detect (300Hz RBW in 9kHz to 150kHz and 10kHz RBW in 150kHz to 30MHz) Function and Specified Bandwidth with Maximum Hold Mode.

### 8.4 EUT Operating Conditions

The EUT tested system was configured as the statements of 4.5 Unless otherwise a special operating condition is specified in the follows during the testing.  
The report only show the worst antenna Polarity's data.

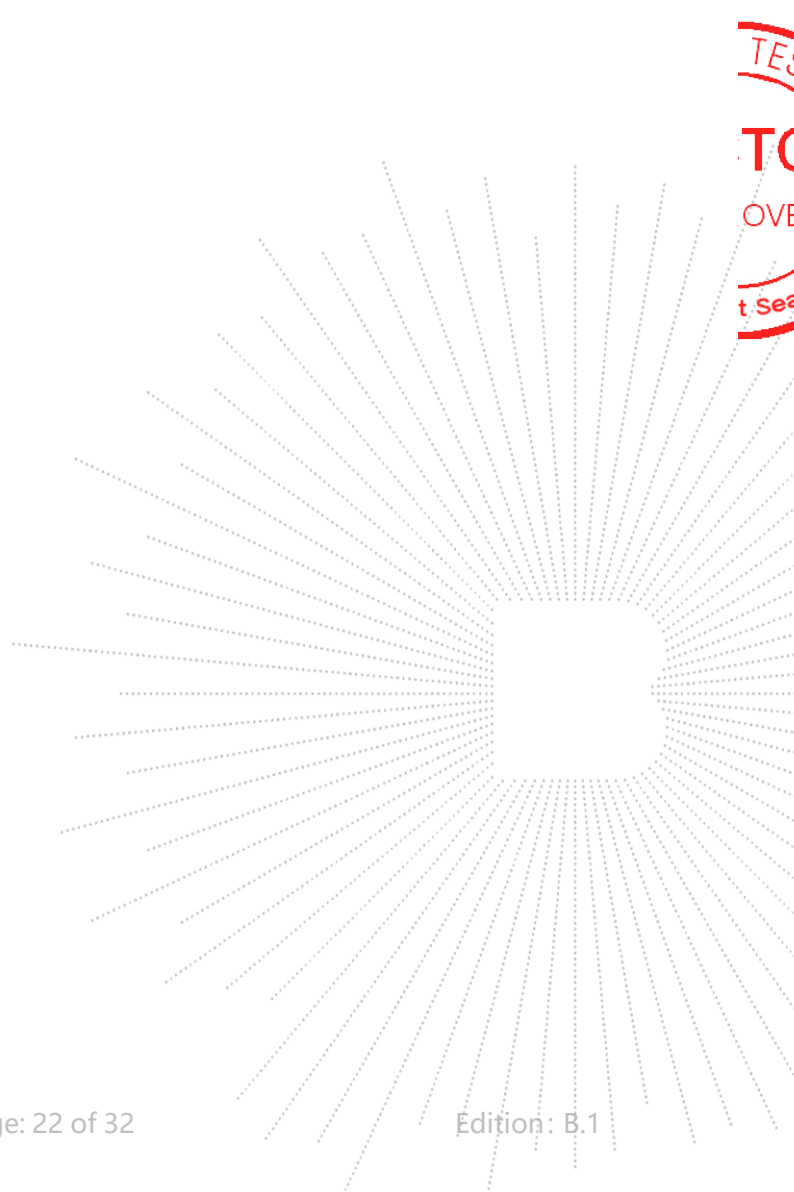

## 8.5 Test Result

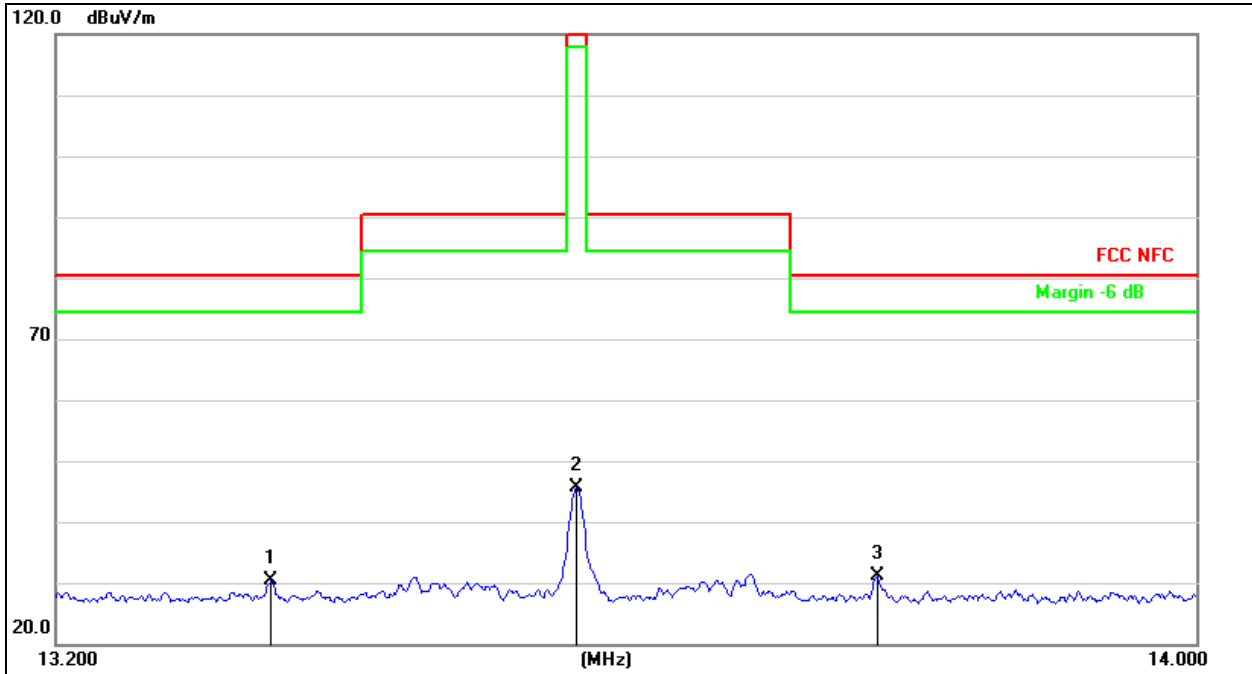

No.	Mk.	Freq. MHz	Reading Level dBuV	Correct Factor dB	Measure- ment dBuV/m	Limit dB/m	Over dB	Detector
1		13.3480	37.50	-7.23	30.27	80.50	-50.23	peak
2		13.5600	52.88	-7.23	45.65	124.0	-78.35	peak
3	*	13.7712	38.28	-7.23	31.05	80.50	-49.45	peak

STING  
 ED  
 IN

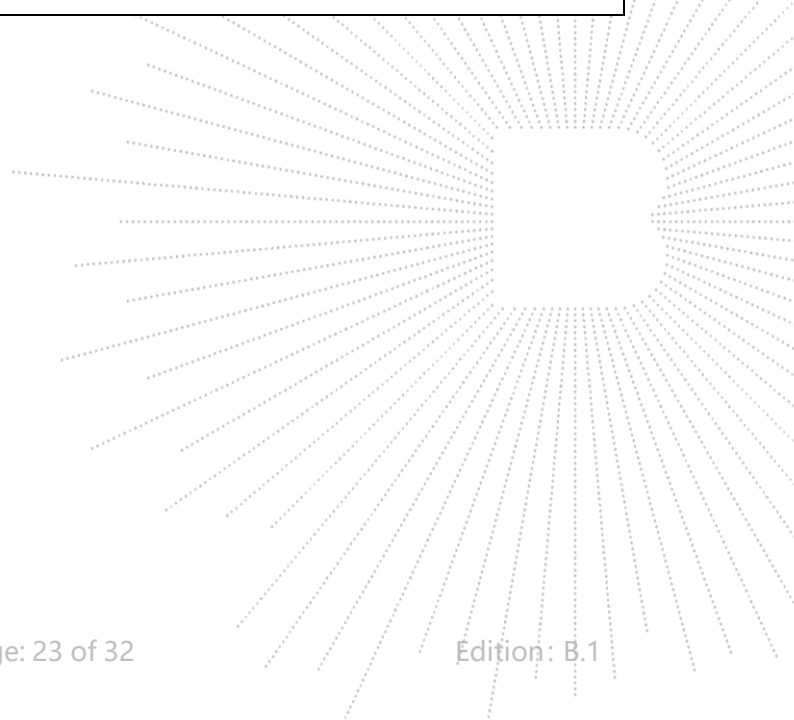

## 9. Bandwidth Test

### 9.1 Block Diagram Of Test Setup



### 9.2 Test Procedure

FCC Part15 (15.215)	
Section	Test Item
15.215	Bandwidth

1. Set RBW = 1% to 5% of the OBW
2. Set the video bandwidth (VBW)  $\geq$ RBW.
3. Detector = Peak.
4. Trace mode = max hold.
5. Sweep = auto couple.
6. Allow the trace to stabilize.
7. Measure the maximum width of the emission that is constrained by the frequencies associated with the two outermost amplitude points (upper and lower frequencies) that are attenuated by 20 dB relative to the maximum level measured in the fundamental emission.

### 9.3 EUT Operation Conditions

The EUT tested system was configured as the statements of 4.2 Unless otherwise a special operating condition is specified in the follows during the testing.



## 9.4 Test Result

Temperature:	26°C	Relative Humidity:	54%
Test Mode:	ASK	Test Voltage:	DC 12V

<b>Frequency (MHz)</b>	<b>20dB bandwidth (Hz)</b>
13.56	234

## TX CH 01

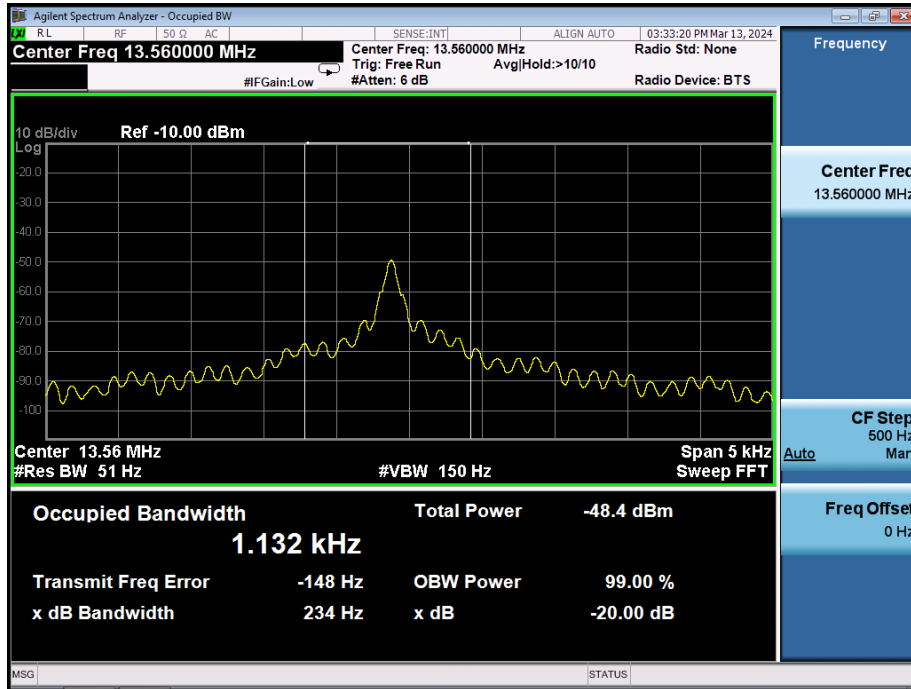

## 10. Transmitter Frequency Stability

### 10.1 Block Diagram Of Test Setup

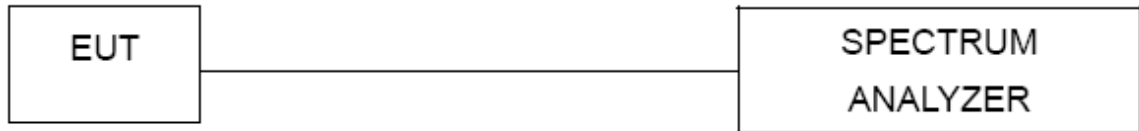

### 10.2 Limit

The frequency tolerance of the carrier signal shall be maintained within  $\pm 0.01\%$  of the operating frequency over a temperature variation of -20 degrees to +50 degrees C at normal supply voltage, and for a variation in the primary supply voltage from 85% to 115% of the rated supply voltage at a temperature of 20 degrees C. For battery operated equipment, the equipment tests shall be performed using a new battery.  
Limit:  $\pm 0.01\%$  of 13.56MHz=1356Hz

### 10.3 Test Procedure

1. Set RBW = 10 kHz.
2. Set the video bandwidth (VBW)  $\geq$  RBW.
3. Detector = Peak.
4. Trace mode = max hold.
5. Sweep = auto couple.
6. Allow the trace to stabilize.
7. The transmitter output (antenna port) was connected to the spectrum analyzer.

### 10.4 EUT Operating Conditions

The EUT tested system was configured as the statements of 4.5 Unless otherwise a special operating condition is specified in the follows during the testing.

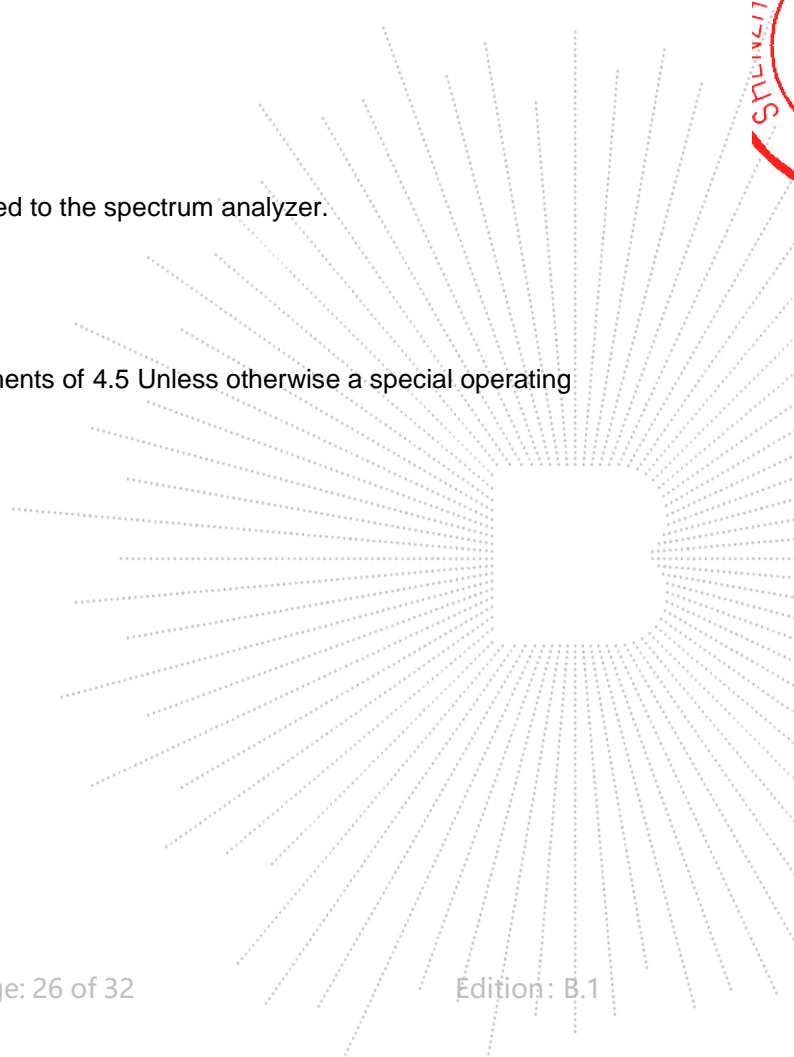

## 10.5 Test Result

Temperature:	26°C	Relative Humidity:	54%
Pressure:	101kPa	Test Voltage:	DC 12V
Test Mode:	TX Mode		

Test Conditions			Frequency Deviation		Limit(Hz)	Result
Frequency (MHz)	Power(Vdc)	Temperature (°C)	Measured Freq.	Frequency Error(Hz)		
13.56	12	-20	13.56007	70	1356	PASS
	12	-10	13.56006	60	1356	
	12	0	13.56002	20	1356	
	12	10	13.56003	30	1356	
	12	20	13.56010	100	1356	
	12	30	13.56008	80	1356	
	12	40	13.56005	50	1356	
	12	50	13.56004	40	1356	
	10.2	20	13.56003	30	1356	
	13.8	20	13.56015	150	1356	

BCTC  
 B  
 AP  
 Re

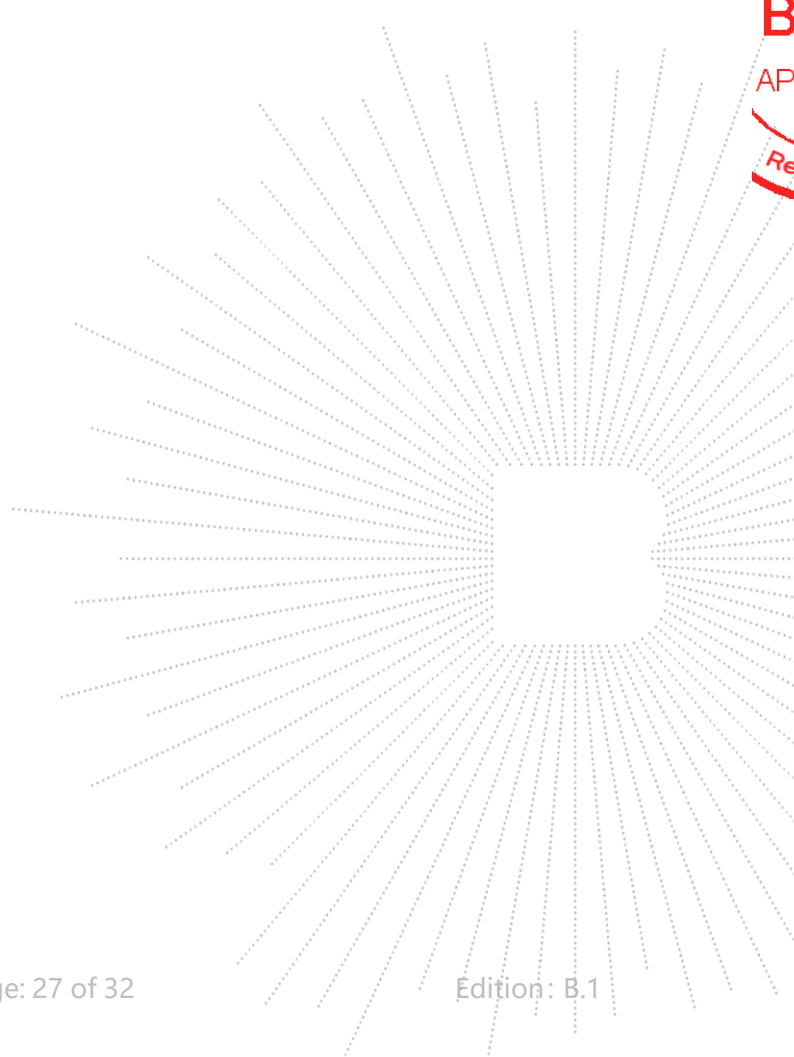

## 11. Antenna Requirement

### 11.1 Standard Requirement

15.203 requirement: For intentional device, according to 15.203: an intentional radiator shall be designed to ensure that no antenna other than that furnished by the responsible party shall be used with the device.

### 11.2 EUT Antenna

The EUT antenna is PCB Antenna, It comply with the standard requirement.

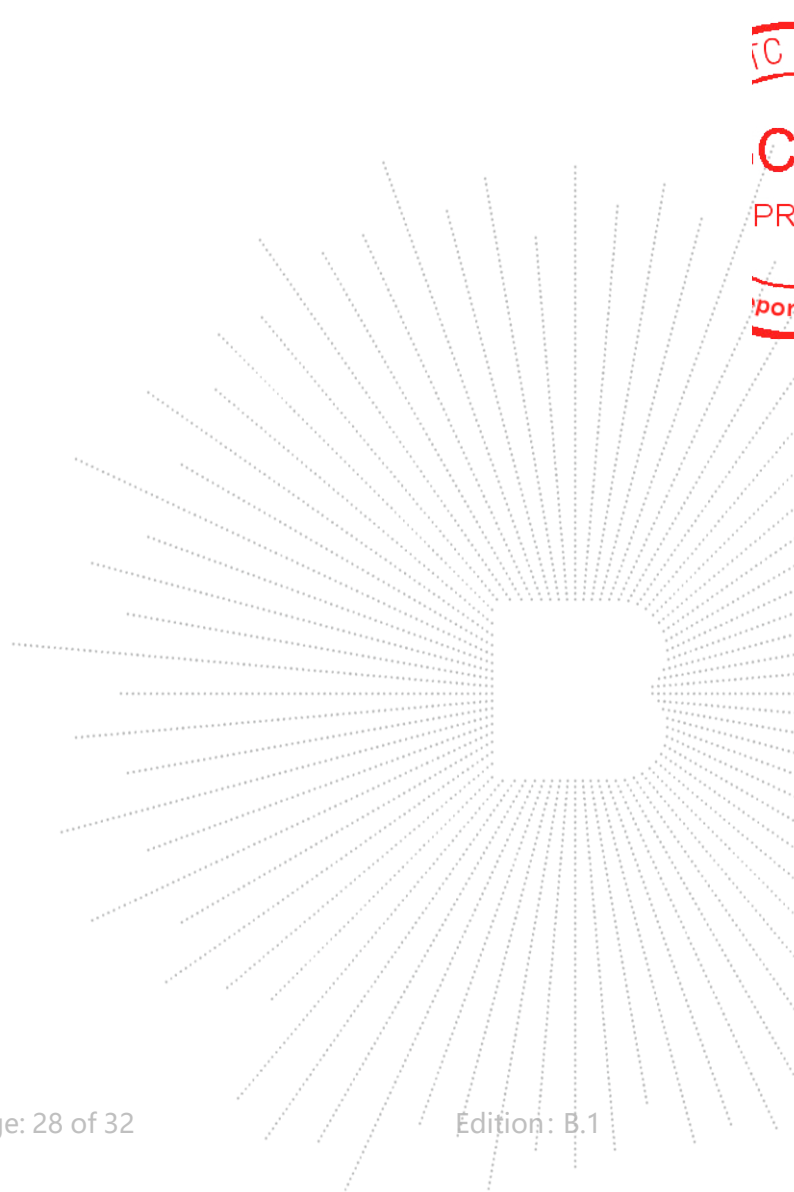

## 12. EUT Photographs

EUT Photo 1



EUT Photo 2

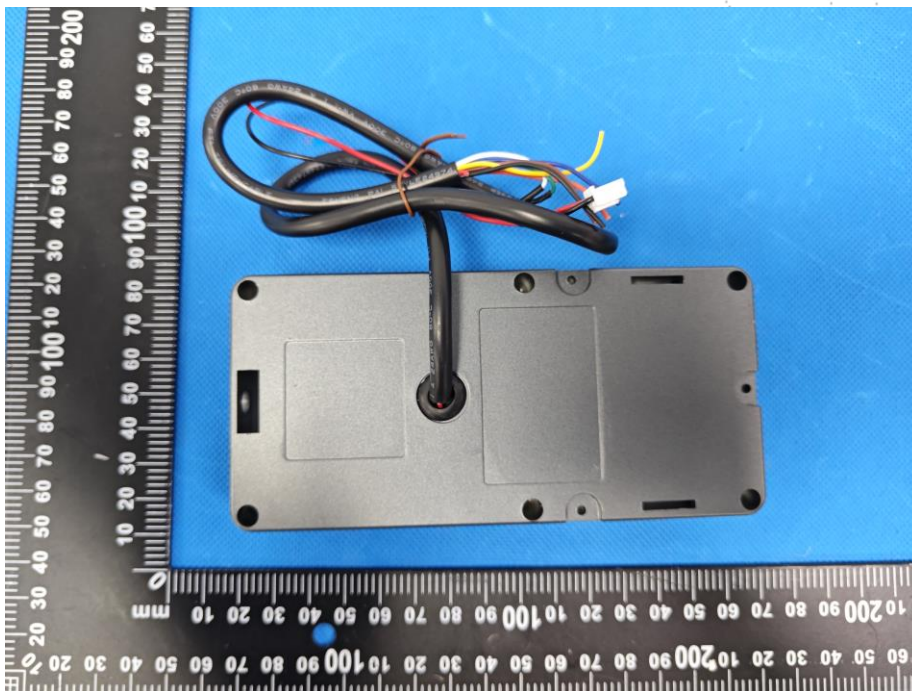

NOTE: Appendix-Photographs Of EUT Constructional Details

### 13. EUT Test Setup Photographs

#### Conducted Measurement Photos



#### Radiated Measurement Photos



EST  
C  
ED  
sal

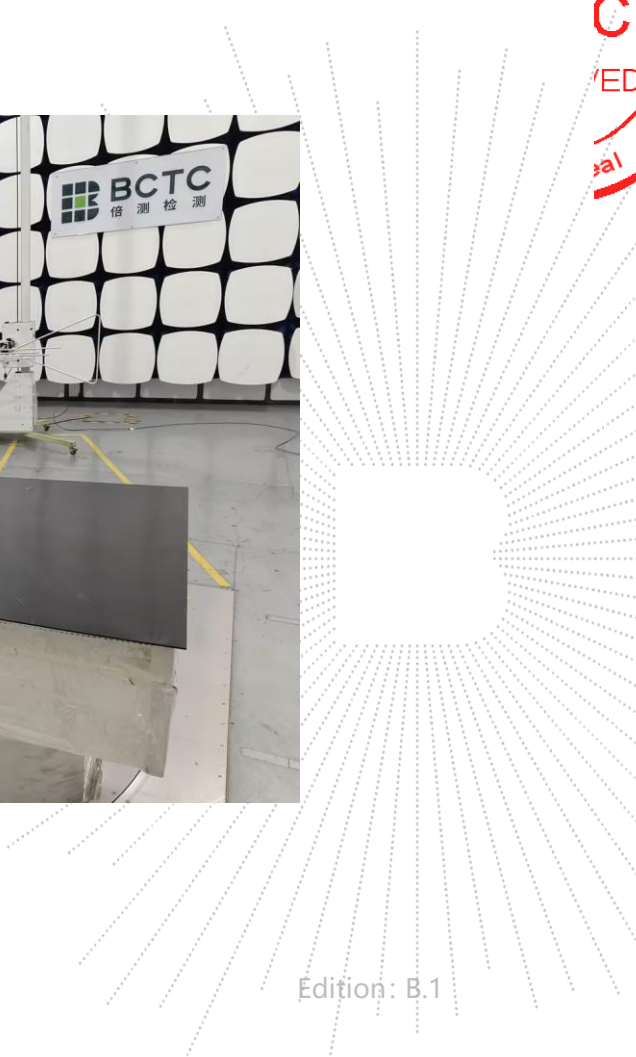

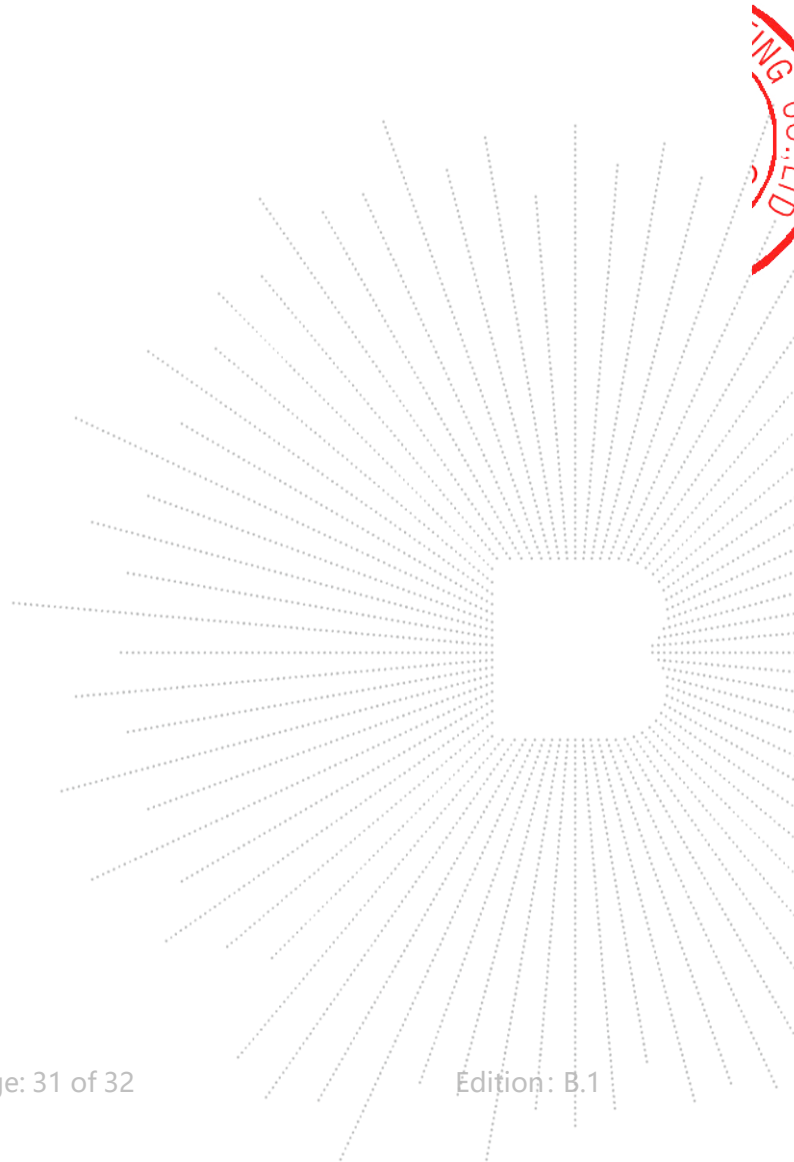

**STATEMENT**

1. The equipment lists are traceable to the national reference standards.
2. The test report can not be partially copied unless prior written approval is issued from our lab.
3. The test report is invalid without the "special seal for inspection and testing".
4. The test report is invalid without the signature of the approver.
5. The test process and test result is only related to the Unit Under Test.
6. Sample information is provided by the client and the laboratory is not responsible for its authenticity.
7. The quality system of our laboratory is in accordance with ISO/IEC17025.
8. If there is any objection to this test report, the client should inform issuing laboratory within 15 days from the date of receiving test report.

## Address:

1-2/F., Building B, Pengzhou Industrial Park, No.158, Fuyuan 1st Road, Zhancheng, Fuhai Subdistrict, Bao'an District, Shenzhen, Guangdong, China

TEL: 400-788-9558

P.C.: 518103

FAX: 0755-33229357

Website: <http://www.chnbctc.com>E-Mail: [bctc@bctc-lab.com.cn](mailto:bctc@bctc-lab.com.cn)

※※※※※ END ※※※※※

2017

