

RF MEASUREMENT REPORT

FCC ID: 2BAXN-MR0002
Applicant: Willand (Beijing) Technology Co., LTD.
Product: Navimow Charging Station
Model No.: H25D2E
Brand Name: Segway
FCC Classification: FCC Part 15 Spread Spectrum Transmitter (DSS)
FCC Rule Part(s): Part15 Subpart C (Section 15.247)
Result: Complies
Received Date: 2023-04-20
Test Date: 2023-05-11 ~ 2023-06-01

Reviewed By:

Vincent Yu

Approved By:

Robin Wu



The test results relate only to the samples tested.

The test results shown in the test report are traceable to the national/international standards through the calibration of the equipment and evaluated measurement uncertainty herein.

The test report shall not be reproduced except in full without the written approval of MRT Technology (Suzhou) Co., Ltd.

Revision History

Report No.	Version	Description	Issue Date	Note
2304RSU043-U5	V01	Initial Report	2023-06-14	Valid

CONTENTS

Description	Page
1. General Information	6
1.1. Applicant	6
1.2. Manufacturer	6
1.3. Testing Facility	6
1.4. Product Information.....	7
1.5. Radio Specification under Test	7
1.6. Working Frequencies	8
2. Test Configuration	9
2.1. Test Mode	9
2.2. Test System Connection Diagram	9
2.3. Test Software	10
2.4. Applied Standards.....	10
2.5. Test Environment Condition	10
3. Antenna Requirement	11
4. Measuring Instrument	12
5. Decision Rules and Measurement Uncertainty	13
5.1. Decision Rules	13
5.2. Measurement Uncertainty.....	13
6. Test Result.....	14
6.1. Summary	14
6.2. 20dB Bandwidth Measurement.....	15
6.2.1. Test Limit	15
6.2.2. Test Procedure.....	15
6.2.3. Test Setting	15
6.2.4. Test Setup	15
6.2.5. Test Result	15
6.3. Output Power Measurement.....	16
6.3.1. Test Limit	16
6.3.2. Test Procedure.....	16
6.3.3. Test Setting	16
6.3.4. Test Setup	16
6.3.5. Test Result	16
6.4. Carrier Frequency Separation Measurement	17
6.4.1. Test Limit	17
6.4.2. Test Procedure.....	17
6.4.3. Test Setting	17

6.4.4.	Test Setup	17
6.4.5.	Test Result	17
6.5.	Number of Hopping Channels Measurement	18
6.5.1.	Test Limit	18
6.5.2.	Test Procedure	18
6.5.3.	Test Settintg	18
6.5.4.	Test Setup	18
6.5.5.	Test Result	18
6.6.	Time of Occupancy Measurement	19
6.6.1.	Test Limit	19
6.6.2.	Test Procedure	19
6.6.3.	Test Settintg	19
6.6.4.	Test Setup	19
6.6.5.	Test Result	19
6.7.	Band-edge Compliance Measurement	20
6.7.1.	Test Limit	20
6.7.2.	Test Procedure	20
6.7.3.	Test Setting	20
6.7.4.	Test Setup	20
6.7.5.	Test Result	20
6.8.	Conducted Spurious Emissions Measurement	21
6.8.1.	Test Limit	21
6.8.2.	Test Procedure	21
6.8.3.	Test Setting	21
6.8.4.	Test Setup	21
6.8.5.	Test Result	22
6.9.	Radiated Spurious Emission Measurement	23
6.9.1.	Test Limit	23
6.9.2.	Test Procedure	23
6.9.3.	Test Setting	23
6.9.4.	Test Setup	25
6.9.5.	Test Result	26
6.10.	Radiated Restricted Band Edge Measurement	27
6.10.1.	Test Limit	27
6.10.2.	Test Procedure	28
6.10.3.	Test Setting	28
6.10.4.	Test Setup	29
6.10.5.	Test Result	29
6.11.	AC Conducted Emissions Measurement	30

6.11.1. Test Limit	30
6.11.2. Test Setup	30
6.11.3. Test Result	30
Appendix A - Test Result.....	31
A.1 Duty Cycle Test Result	31
A.2 20dB Bandwidth Test Result	32
A.3 Output Power Test Result	33
A.4 Carrier Frequency Separation Test Result.....	34
A.5 Number of Hopping Channels Test Result.....	35
A.6 Time of Occupancy Test Result	36
A.7 Band-edge Compliance Test Result.....	37
A.8 Conducted Spurious Emissions Test Result	38
A.9 Radiated Spurious Emission Test Result	39
A.10 Radiated Restricted Band Edge Test Result.....	42
A.11 AC Conducted Emissions Test Result	46
Appendix B - Test Setup Photograph	48
Appendix C - EUT Photograph	49

1. General Information

1.1. Applicant

Willand (Beijing) Technology Co., LTD.

Room 203, A1 Bldg. Zhongguancun Dongsheng Technology Park, Haidian Dist., Beijing, China.

1.2. Manufacturer

Willand (Beijing) Technology Co., LTD.

Room 203, A1 Bldg. Zhongguancun Dongsheng Technology Park, Haidian Dist., Beijing, China.

1.3. Testing Facility

<input checked="" type="checkbox"/>	<p>Test Site – MRT Suzhou Laboratory</p> <hr/> <p>Laboratory Location (Suzhou - Wuzhong) D8 Building, No.2 Tian'edang Rd., Wuzhong Economic Development Zone, Suzhou, China</p> <p>Laboratory Location (Suzhou - SIP) 4b Building, Liando U Valley, No.200 Xingpu Rd., Shengpu Town, Suzhou Industrial Park, China</p> <hr/> <p>Laboratory Accreditations</p> <p>A2LA: 3628.01 CNAS: L10551</p> <p>FCC: CN1166 ISED: CN0001</p> <p>VCCI: <input type="checkbox"/>R-20025 <input type="checkbox"/>G-20034 <input type="checkbox"/>C-20020 <input type="checkbox"/>T-20020</p> <p><input type="checkbox"/>R-20141 <input type="checkbox"/>G-20134 <input type="checkbox"/>C-20103 <input type="checkbox"/>T-20104</p>
<input type="checkbox"/>	<p>Test Site – MRT Shenzhen Laboratory</p> <hr/> <p>Laboratory Location (Shenzhen) 1G, Building A, Junxiangda Building, Zhongshanyuan Road West, Nanshan District, Shenzhen, China</p> <hr/> <p>Laboratory Accreditations</p> <p>A2LA: 3628.02 CNAS: L10551</p> <p>FCC: CN1284 ISED: CN0105</p>
<input type="checkbox"/>	<p>Test Site – MRT Taiwan Laboratory</p> <hr/> <p>Laboratory Location (Taiwan) No. 38, Fuxing 2nd Rd., Guishan Dist., Taoyuan City 333, Taiwan (R.O.C.)</p> <hr/> <p>Laboratory Accreditations</p> <p>TAF: L3261-190725</p> <p>FCC: 291082, TW3261 ISED: TW3261</p>

1.4. Product Information

Product Name	Navimow Charging Station
Model No.	H25D2E
EUT Identification No.	20230530Sample#01, 20230423Sample#11 20230423Sample#12, 20230423Sample#13
SRD Specification	915.05 ~ 917.90 MHz
Input	32VDC, 2.5A MAX
Output	25.2VDC, 2.5A
Antenna Information	Refer to 1.5.
Accessories	
Adapter	Model: NBW32D002D5N-US Input: 100-240V~ 50-60Hz 2.0A MAX Output: 32V=2.5A 80.0W
Note: The information of EUT was provided by the manufacturer, and the accuracy of the information shall be the responsibility of the manufacturer.	

1.5. Radio Specification under Test

Frequency Range	915.05 ~ 917.90 MHz
Channel Number	58
Type of modulation	FHSS
Antenna Type	PCB Antenna
Number of Antenna	1
Antenna Gain	2.46dBi

1.6. Working Frequencies

Channel	Frequency	Channel	Frequency	Channel	Frequency
1	915.05	2	915.10	3	915.15
4	915.20	5	915.25	6	915.30
7	915.35	8	915.40	9	915.45
10	915.50	11	915.55	12	915.60
13	915.65	14	915.70	15	915.75
16	915.80	17	915.85	18	915.90
19	915.95	20	916.00	21	916.05
22	916.10	23	916.15	24	916.20
25	916.25	26	916.30	27	916.35
28	916.40	29	916.45	30	916.50
31	916.55	32	916.60	33	916.65
34	916.70	35	916.75	36	916.80
37	916.85	38	916.90	39	916.95
40	917.00	41	917.05	42	917.10
43	917.15	44	917.20	45	917.25
46	917.30	47	917.35	48	917.40
49	917.45	50	917.50	51	917.55
52	917.60	53	917.65	54	917.70
55	917.75	56	917.80	57	917.85
58	917.90	--	--	--	--

Note: The CH01/CH30/CH58 were selected as Low/Mid/High test channels in this report.

2. Test Configuration

2.1. Test Mode

Mode 1: Transmit at CH01 (915.05MHz)
Mode 2: Transmit at CH30 (916.50MHz)
Mode 3: Transmit at CH58 (917.90MHz)
Mode 4: Transmit at frequency hopping mode

2.2. Test System Connection Diagram

The device was tested per the guidance ANSI C63.10: 2013 was used to reference the appropriate EUT setup for radiated emissions testing and AC line conducted testing.

Connection Diagram – Radiated Emission testing

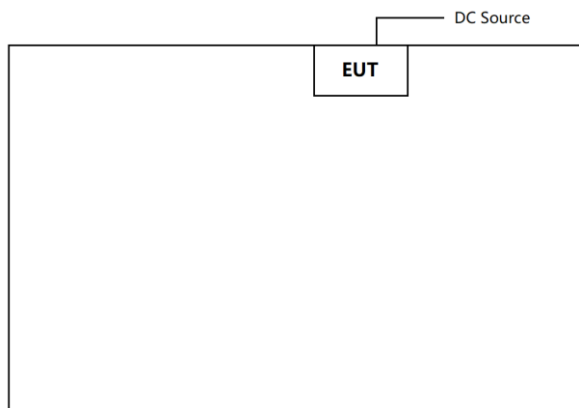

Connection Diagram – Radiated AC line conducted testing

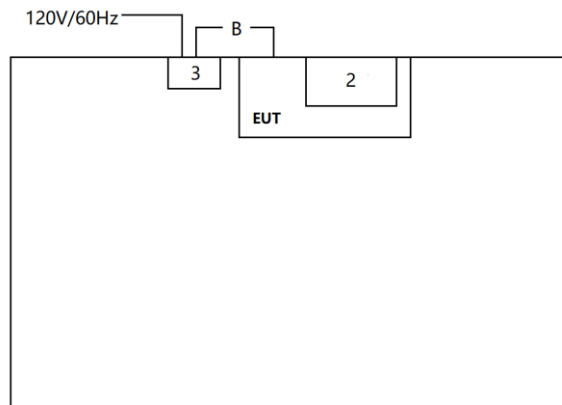

Cable Type	Cable Spec.	Length
B Power Cable	Shielding	0.5m
Product	Manufacturer	Model No.
2 Navimow	Segway	H3000N-VF
3 AC/DC Adapter	Segway	NBW32D002D5N-US

2.3. Test Software

The test samples for each transmission frequency (Low / Mid / High channels and Frequency Hopping) were provided by manufacturer, and can enter TX mode after power-on.

2.4. Applied Standards

According to the specifications of the manufacturer, the EUT must comply with the requirements of the following standards:

- FCC Part 15.247
- KDB 558074 D01v05r02
- ANSI C63.10-2013

2.5. Test Environment Condition

Ambient Temperature	15 ~ 35 °C
Relative Humidity	20 ~ 75 %RH

3. Antenna Requirement

Excerpt from §15.203 of the FCC Rules/Regulations:

“An intentional radiator antenna shall be designed to ensure that no antenna other than that furnished by the responsible party can be used with the device. The use of a permanently attached antenna or of an antenna that uses a unique coupling to the intentional radiator shall be considered sufficient to comply with the provisions of this section.”

Conclusion:

- The antenna of the device is **permanently attached**.
- There are no provisions for connection to an external antenna.

4. Measuring Instrument

Instrument	Manufacturer	Model No.	Asset No.	Cali. Interval	Cali. Due Date	Test Site
EMI Test Receiver	R&S	ESR7	MRTSUE06001	1 year	2023-12-28	WZ-AC1
Horn Antenna	Schwarzbeck	BBHA 9120D	MRTSUE06023	1 year	2023-08-22	WZ-AC1
Loop Antenna	Schwarzbeck	FMZB 1519	MRTSUE06025	1 year	2023-09-29	WZ-AC1
Preamplifier	Agilent	83017A	MRTSUE06076	1 year	2024-05-07	WZ-AC1
TRILOG Antenna	Schwarzbeck	VULB 9168	MRTSUE06172	1 year	2023-06-21	WZ-AC1
Anechoic Chamber	TDK	WZ-AC1	MRTSUE06212	1 year	2024-04-20	WZ-AC1
Thermohygrometer	testo	608-H1	MRTSUE06403	1 year	2023-06-06	WZ-AC1
Signal Analyzer	Keysight	N9010B	MRTSUE06607	1 year	2023-12-28	WZ-AC1
Thermohygrometer	testo	608-H1	MRTSUE11039	1 year	2023-11-01	WZ-AC1
Signal Analyzer	Keysight	N9010B	MRTSUE06457	1 year	2023-06-04	WZ-SR5
Thermohygrometer	testo	608-H1	MRTSUE06402	1 year	2023-06-06	WZ-SR5
Shielding Room	HUAMING	WZ-SR5	MRTSUE06442	N/A	N/A	WZ-SR5
Signal Analyzer	Agilent	N9020A	MRTSUE06106	1 year	2024-02-29	WZ-SR5
Attenuator	MVE	MVE2213	MRTSUE11093	1 year	2023-06-09	WZ-SR5

Software	Version	Function
EMI Software	V3.0.0	EMI Test Software
Controller_MF 7802	2.03C	RE Antenna & Turntable

5. Decision Rules and Measurement Uncertainty

5.1. Decision Rules

The Decision Rule is based on Simple Acceptance in accordance with ISO Guide 98-4: 2012 Clause 8.2. (Measurement uncertainty is not taken into account when stating conformity with a specified requirement.)

5.2. Measurement Uncertainty

Where relevant, the following test uncertainty levels have been estimated for tests performed on the EUT as specified in CISPR 16-4-2. This uncertainty represents an expanded uncertainty expressed at approximately the 95% confidence level using a coverage factor of $k = 2$.

AC Conducted Emission Measurement
The maximum measurement uncertainty is evaluated as: 9kHz~150kHz: 3.58dB 150kHz~30MHz: 3.20dB
Radiated Disturbance
The maximum measurement uncertainty is evaluated as: Coaxial: 9kHz~30MHz: 2.59dB Coplanar: 9kHz~30MHz: 2.60dB Horizontal: 30MHz~200MHz: 3.85dB 200MHz~1GHz: 4.36dB 1GHz~10GHz: 4.98dB Vertical: 30MHz~200MHz: 4.06dB 200MHz~1GHz: 5.28dB 1GHz~10GHz: 4.91dB
Spurious Emissions, Conducted
Measuring Uncertainty for a Level of Confidence of 95% ($U=2Uc(y)$): 2.30dB
Output Power
Measuring Uncertainty for a Level of Confidence of 95% ($U=2Uc(y)$): 2.30dB
Occupied Bandwidth
Measuring Uncertainty for a Level of Confidence of 95% ($U=2Uc(y)$): 3.20%

6. Test Result

6.1. Summary

FCC Section(s)	Test Description	Test Condition	Verdict
15.247(a)(1)	20dB Bandwidth	Conducted	Pass
15.247(b)(1)	Peak Transmitter Output Power		Pass
15.247(a)(1)	Channel Separation		Pass
15.247(a)(1)(iii)	Number of Channels		Pass
15.247(a)(1)(iii)	Time of Occupancy		Pass
15.247(d)	Band Edge / Out- of-Band Emissions		Pass
15.205, 15.209	General Field Strength (Restricted Bands and Radiated Emission)	Radiated	Pass
15.207	AC Conducted Emissions 150kHz - 30MHz	Line Conducted	Pass

Notes:

- The analyzer plots shown in this section were all taken with a correction table loaded into the analyzer. The correction table was used to account for the losses of the cables and attenuators used as part of the system to connect the EUT to the analyzer at all frequencies of interest.
- The test results shown in the following sections represent the worst-case emissions.

6.2. 20dB Bandwidth Measurement

6.2.1. Test Limit

The maximum allowed 20 dB bandwidth of the hopping channel is 500 kHz.

6.2.2. Test Procedure

ANSI C63.10-2013 - Section 6.9.2 (20dB Bandwidth)

6.2.3. Test Setting

1. Set RBW = 1% to 5% of the 20dB bandwidth
2. VBW = approximately three times RBW
3. Span = approximately 2 to 5 times the 20dB bandwidth, centered on a hopping channel
4. Detector = Peak
5. Trace mode = max hold
6. Sweep = auto couple
7. Allow the trace to stabilize
8. Measure the maximum width of the emission that is constrained by the frequencies associated with the two outermost amplitude points (upper and lower frequencies) that are attenuated by 20 dB relative to the maximum level measured in the fundamental emission.

6.2.4. Test Setup

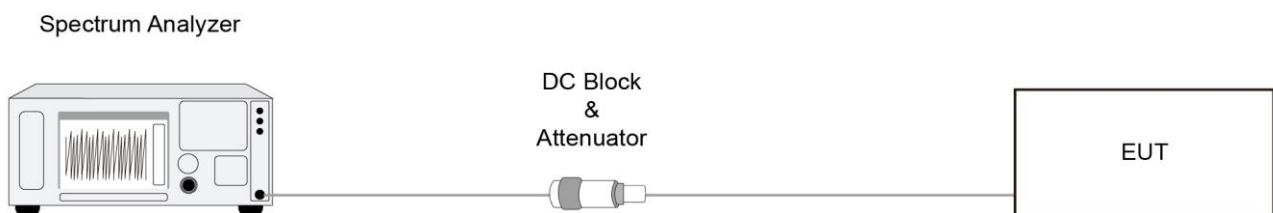

6.2.5. Test Result

Refer to Appendix A.2.

6.3. Output Power Measurement

6.3.1. Test Limit

For frequency hopping systems operating in the 902-928 MHz band: 1 watt for systems employing at least 50 hopping channels; and, 0.25 watts for systems employing less than 50 hopping channels, but at least 25 hopping channels

6.3.2. Test Procedure

ANSI C63.10-2013 - Section 7.8.5

6.3.3. Test Setting

1. Set RBW \geq the 20 dB bandwidth of the emission being measured.
2. VBW \geq RBW
3. Span = approximately five times the 20dB bandwidth, centered on a hopping channel
4. Detector = Peak
5. Trace mode = max hold
6. Sweep = auto couple
7. Allow the trace to stabilize, Use the marker-to-peak function to set the marker to the peak of the emission.
The indicated level is the peak output power (don't forget added the external attenuation and cable loss)

6.3.4. Test Setup

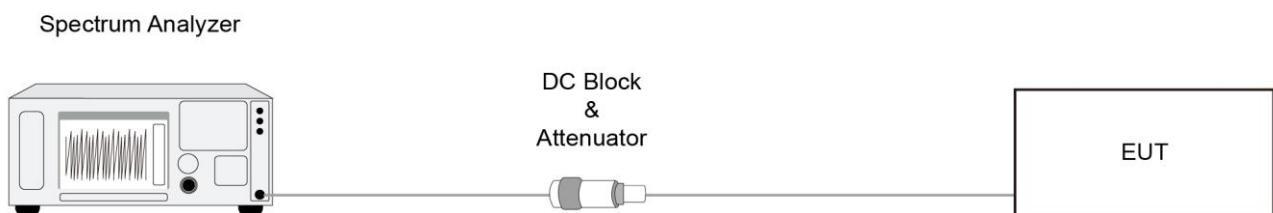

6.3.5. Test Result

Refer to Appendix A.3.

6.4. Carrier Frequency Separation Measurement

6.4.1. Test Limit

Frequency hopping systems shall have hopping channel carrier frequencies separated by a minimum of 25 kHz or the 20 dB bandwidth of the hopping channel, whichever is greater.

6.4.2. Test Procedure

ANSI C63.10-2013 - Section 7.8.2.

6.4.3. Test Setting

1. Span = wide enough to capture the peaks of two adjacent channels.
2. Start with the RBW set to approximately 30% of the channel spacing; adjust as necessary to best identify the center of each individual channel.
3. VBW \geq RBW
4. Sweep time = Auto couple
5. Detector = Peak
6. Trace mode = Max hold
7. Allowed the trace to stabilize
8. Use the marker-delta function to determine the separation between the peaks of the adjacent channels.

6.4.4. Test Setup

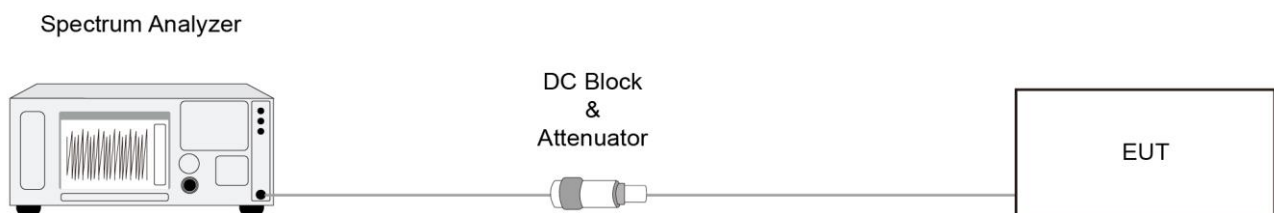

6.4.5. Test Result

Refer to Appendix A.4.

6.5. Number of Hopping Channels Measurement

6.5.1. Test Limit

For frequency hopping systems operating in the 902-928 MHz band: if the 20 dB bandwidth of the hopping channel is less than 250 kHz, the system shall use at least 50 hopping frequencies; if the 20 dB bandwidth of the hopping channel is 250 kHz or greater, the system shall use at least 25 hopping frequencies.

6.5.2. Test Procedure

ANSI C63.10-2013 - Section 7.8.3.

6.5.3. Test Setting

1. Span = the frequency band of operation. Depending on the number of channels the device supports, it may be necessary to divide the frequency range of operation across multiple spans, to allow the individual channels to be clearly seen.
2. To identify clearly the individual channels, set the RBW to less than 30% of the channel spacing or the 20 dB bandwidth, whichever is smaller.
3. VBW \geq RBW
4. Sweep time = Auto couple
5. Detector = Peak
6. Trace mode = Max hold
7. Allow the trace to stabilize

6.5.4. Test Setup

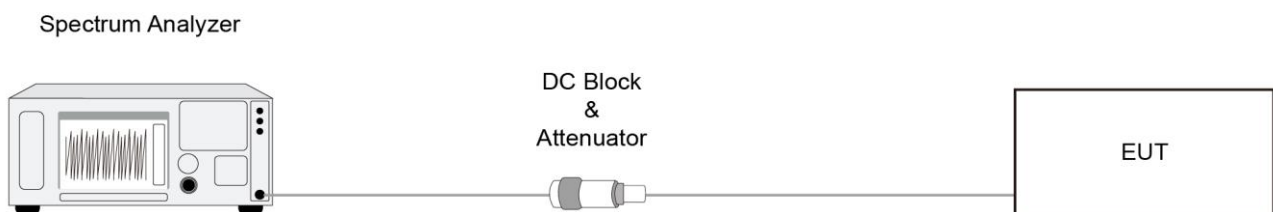

6.5.5. Test Result

Refer to Appendix A.5.

6.6. Time of Occupancy Measurement

6.6.1. Test Limit

For frequency hopping systems operating in the 902-928 MHz band: if the 20 dB bandwidth of the hopping channel is less than 250 kHz, the average time of occupancy on any frequency shall not be greater than 0.4 seconds within a 20 second period; if the 20 dB bandwidth of the hopping channel is 250 kHz or greater, the average time of occupancy on any frequency shall not be greater than 0.4 seconds within a 10 second period.

6.6.2. Test Procedure

ANSI C63.10-2013 - Section 7.8.4.

6.6.3. Test Setting

1. Span = zero span, centered on a hopping channel.
2. RBW shall be \leq channel spacing and where possible RBW should be set $\gg 1 / T$, where T is the expected dwell time per channel.
3. VBW \geq RBW
4. Sweep time = as necessary to capture the entire dwell time per hopping channel
5. Detector = Peak
6. Trace mode = max hold
7. Use the marker-delta function to determine the transmit time per hop. If this value varies with different modes of operation (data rate, modulation format, number of hopping channels, etc.), then repeat this test for each variation in transmit time. An oscilloscope may be used instead of a spectrum analyzer. The EUT shall show compliance with the appropriate regulatory limit for the number of hopping channels. A plot of the data shall be included in the test report.

6.6.4. Test Setup

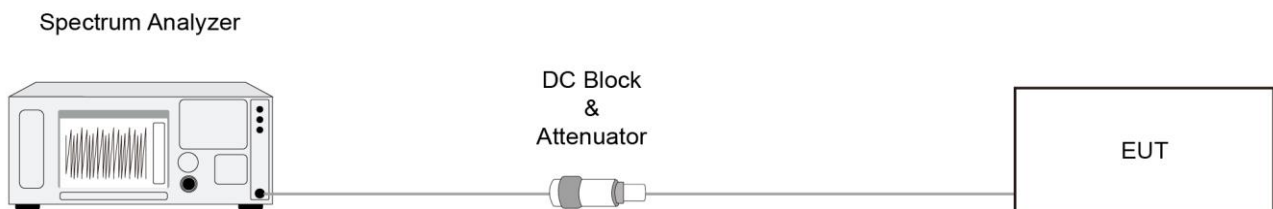

6.6.5. Test Result

Refer to Appendix A.6.

6.7. Band-edge Compliance Measurement

6.7.1. Test Limit

The maximum permissible emission level is 20dBc. Any emissions were lying outside of the emission bandwidth and in authorized band edges to a field strength limit specified in Section 15.209 of the Title 47 CFR.

6.7.2. Test Procedure

ANSI C63.10-2013 - Section 6.10.4.

6.7.3. Test Setting

1. Span = wide enough to capture the peak level of the emission operating on the channel closest to the band edge, as well as any modulation products which fall outside of the authorized band of operation.
2. RBW = 100kHz
3. VBW = 300kHz
4. Detector = peak
5. Sweep time = auto couple
6. Trace mode = max hold
7. Trace was allowed to stabilize
8. Allow the trace to stabilize. Set the marker on the emission at the band edge, or on the highest modulation product outside of the band, if this level is greater than that at the band edge. Enable the marker-delta function, then use the marker-to-peak function to move the marker to the peak of the in-band emission.

6.7.4. Test Setup

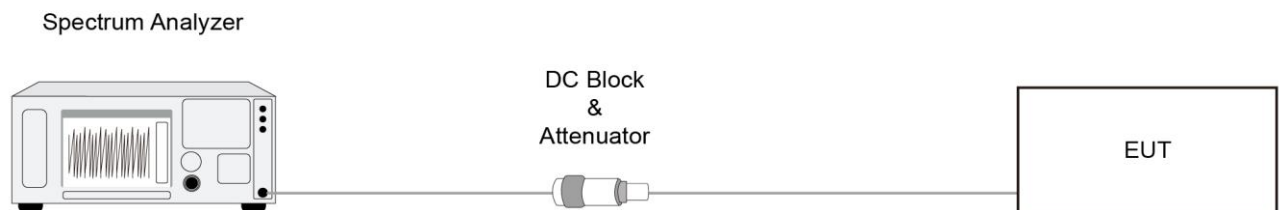

6.7.5. Test Result

Refer to Appendix A.7.

6.8. Conducted Spurious Emissions Measurement

6.8.1. Test Limit

In any 100 kHz bandwidth outside the frequency band in which the spread spectrum or digitally modulated intentional radiator is operating, the radio frequency power that is produced by the intentional radiator shall be at least 20 dB below that in the 100 kHz bandwidth within the band that contains the highest level of the desired power, based on either an RF conducted or a radiated measurement, provided the transmitter demonstrates compliance with the peak conducted or a radiated measurement, provided the transmitter demonstrates compliance with the peak conducted power limits. If the transmitter complies with the conducted power limits based on the use of RMS averaging over a time interval, the attenuation required under this paragraph shall be 30 dB instead of 20 dB.

6.8.2. Test Procedure

ANSI C63.10-2013 - Section 7.8.8.

6.8.3. Test Setting

1. Span = wide enough to capture the peak level of the in-band emission and all spurious emissions (e.g., harmonics) from the lowest frequency generated in the EUT up through the 10th harmonic. Typically, several plots are required to cover this entire span.
2. RBW = 100kHz
3. VBW = 300kHz
4. Detector = peak
5. Sweep time = auto couple
6. Trace mode = max hold
7. Trace was allowed to stabilize
8. Set the marker on the peak of any spurious emission recorded. The level displayed must comply with the limit specified in this section.

6.8.4. Test Setup

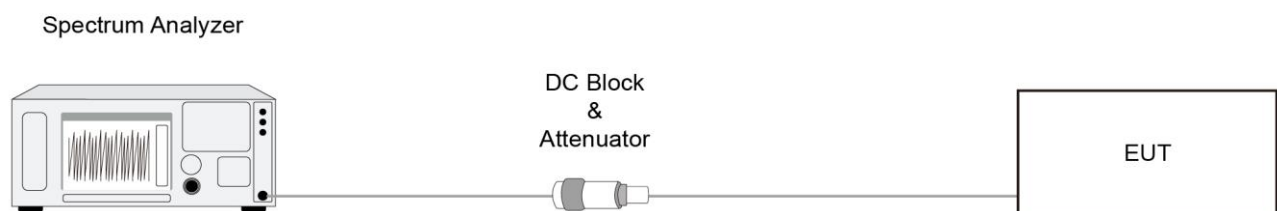

6.8.5. Test Result

Refer to Appendix A.8.

6.9. Radiated Spurious Emission Measurement

6.9.1. Test Limit

All out of band emissions appearing in a restricted band as specified in Section 15.205 of the Title 47 CFR must not exceed the limits shown in Table per Section 15.209.

FCC Part 15 Subpart C Paragraph 15.209		
Frequency [MHz]	Field Strength [uV/m]	Measured Distance [Meters]
0.009 - 0.490	2400/F (kHz)	300
0.490 - 1.705	24000/F (kHz)	30
1.705 - 30	30	30
30 - 88	100	3
88 - 216	150	3
216 - 960	200	3
Above 960	500	3

6.9.2. Test Procedure

ANSI C63.10 Section 6.3 (General Requirements)

ANSI C63.10 Section 6.4 (Standard test method below 30MHz)

ANSI C63.10 Section 6.5 (Standard test method above 30MHz to 1GHz)

ANSI C63.10 Section 6.6 (Standard test method above 1GHz)

6.9.3. Test Setting

Table 1 - RBW as a function of frequency

Frequency	RBW
9 ~ 150 kHz	200 ~ 300 Hz
0.15 ~ 30 MHz	9 ~ 10 kHz
30 ~ 1000 MHz	100 ~ 120 kHz
> 1000 MHz	1 MHz

Quasi-Peak Measurements below 1GHz

1. Analyzer center frequency was set to the frequency of the radiated spurious emission of interest
2. Span was set greater than 1MHz
3. RBW = as specified in Table 1
4. Detector = CISPR quasi-peak
5. Sweep time = auto couple
6. Trace was allowed to stabilize

Peak Measurements above 1GHz

1. Analyzer center frequency was set to the frequency of the radiated spurious emission of interest
2. RBW = 1MHz
3. VBW = 3MHz
4. Detector = peak
5. Sweep time = auto couple
6. Trace mode = max hold
7. Trace was allowed to stabilize

Average Measurements above 1GHz (Method VB)

1. Analyzer center frequency was set to the frequency of the radiated spurious emission of interest
2. RBW = 1MHz
3. VBW; If the EUT is configured to transmit with duty cycle $\geq 98\%$, set VBW = 10 Hz.
If the EUT duty cycle is $< 98\%$, set VBW $\geq 1/T$. T is the minimum transmission duration.
4. Detector = Peak
5. Sweep time = auto
6. Trace mode = max hold
7. Trace was allowed to stabilize

6.9.4. Test Setup

Below 30MHz Test Setup:

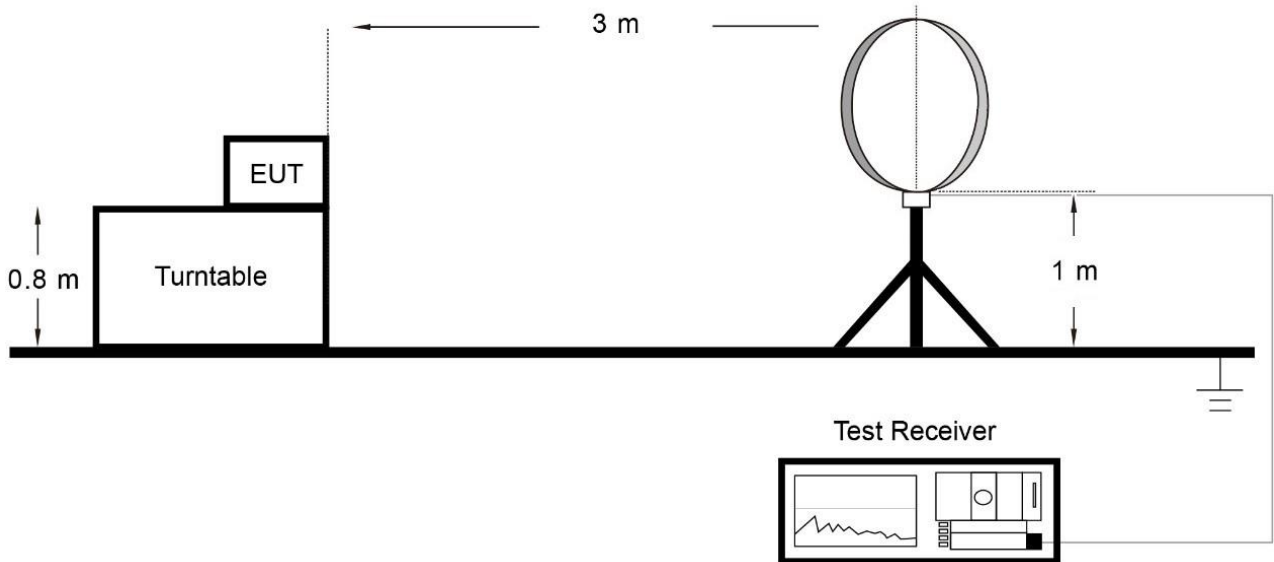

Below 1GHz Test Setup:

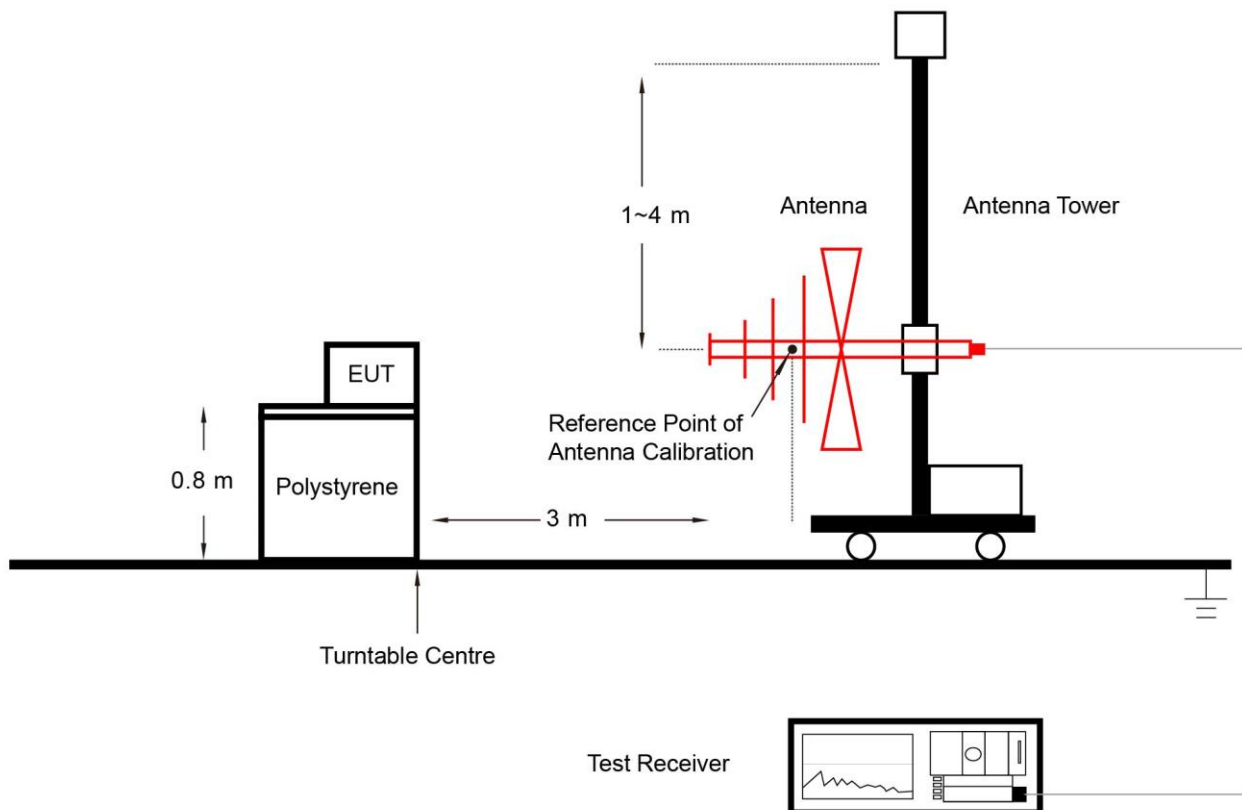

Above 1GHz Test Setup:

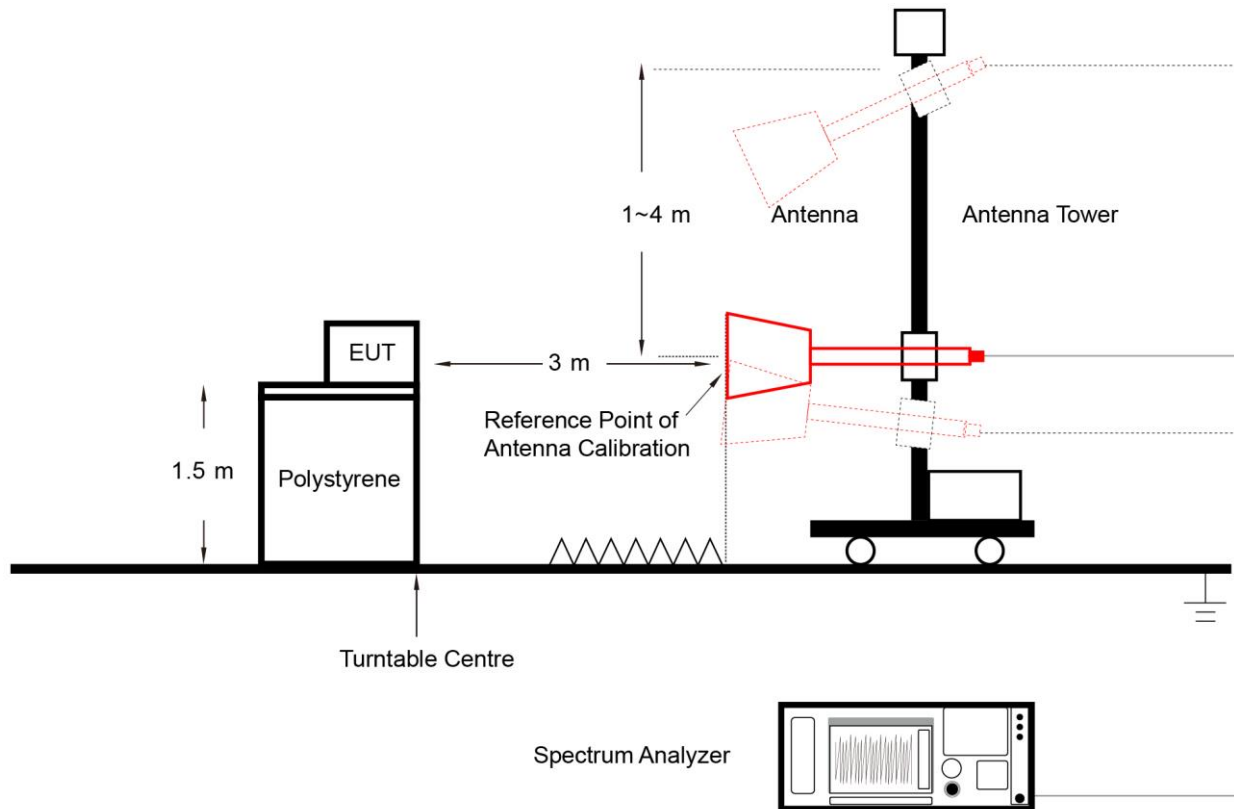

6.9.5. Test Result

Refer to Appendix A.9.

6.10. Radiated Restricted Band Edge Measurement

6.10.1. Test Limit

For 15.205 requirement:

Radiated emissions which fall in the restricted bands, as defined in Section 15.205(a) of FCC part 15, must also comply with the radiated emission limits specified in Section 15.209(a).

Frequency (MHz)	Frequency (MHz)	Frequency (MHz)	Frequency (GHz)
0.090 - 0.110	16.42 - 16.423	399.9 - 410	4.5 - 5.15
¹ 0.495 - 0.505	16.69475 - 16.69525	608 - 614	5.35 - 5.46
2.1735 - 2.1905	16.80425 - 16.80475	960 - 1240	7.25 - 7.75
4.125 - 4.128	25.5 - 25.67	1300 - 1427	8.025 - 8.5
4.17725 - 4.17775	37.5 - 38.25	1435 - 1626.5	9.0 - 9.2
4.20725 - 4.20775	73 - 74.6	1645.5 - 1646.5	9.3 - 9.5
6.215 - 6.218	74.8 - 75.2	1660 - 1710	10.6 - 12.7
6.26775 - 6.26825	108 - 121.94	1718.8 - 1722.2	13.25 - 13.4
6.31175 - 6.31225	123 - 138	2200 - 2300	14.47 - 14.5
8.291 - 8.294	149.9 - 150.05	2310 - 2390	15.35 - 16.2
8.362 - 8.366	156.52475 - 156.52525	2483.5 - 2500	17.7 - 21.4
8.37625 - 8.38675	156.7 - 156.9	2690 - 2900	22.01 - 23.12
8.41425 - 8.41475	162.0125 - 167.17	3260 - 3267	23.6 - 24.0
12.29 - 12.293	167.72 - 173.2	3332 - 3339	31.2 - 31.8
12.51975 - 12.52025	240 - 285	3345.8 - 3358	36.43 - 36.5
12.57675 - 12.57725	322 - 335.4	3600 - 4400	(²)
13.36 - 13.41	--	--	--

All out of band emissions appearing in a restricted band as specified in Section 15.205 of the Title 47CFR must not exceed the limits shown in Table per Section 15.209.

FCC Part 15 Subpart C Paragraph 15.209		
Frequency [MHz]	Field Strength [uV/m]	Measured Distance [Meters]
0.009 - 0.490	2400/F (kHz)	300
0.490 - 1.705	24000/F (kHz)	30
1.705 - 30	30	30
30 - 88	100	3
88 - 216	150	3
216 - 960	200	3
Above 960	500	3

6.10.2. Test Procedure

ANSI C63.10 Section 6.3 (General Requirements)

ANSI C63.10 Section 6.5 (Standard test method above 30MHz to 1GHz)

6.10.3. Test Setting

Quasi-Peak Measurements below 1GHz

1. Analyzer center frequency was set to the frequency of the radiated spurious emission of interest
2. Span was set greater than 1MHz
3. RBW = as specified in Table 1
4. Detector = CISPR quasi-peak
5. Sweep time = auto couple
6. Trace was allowed to stabilize

6.10.4. Test Setup

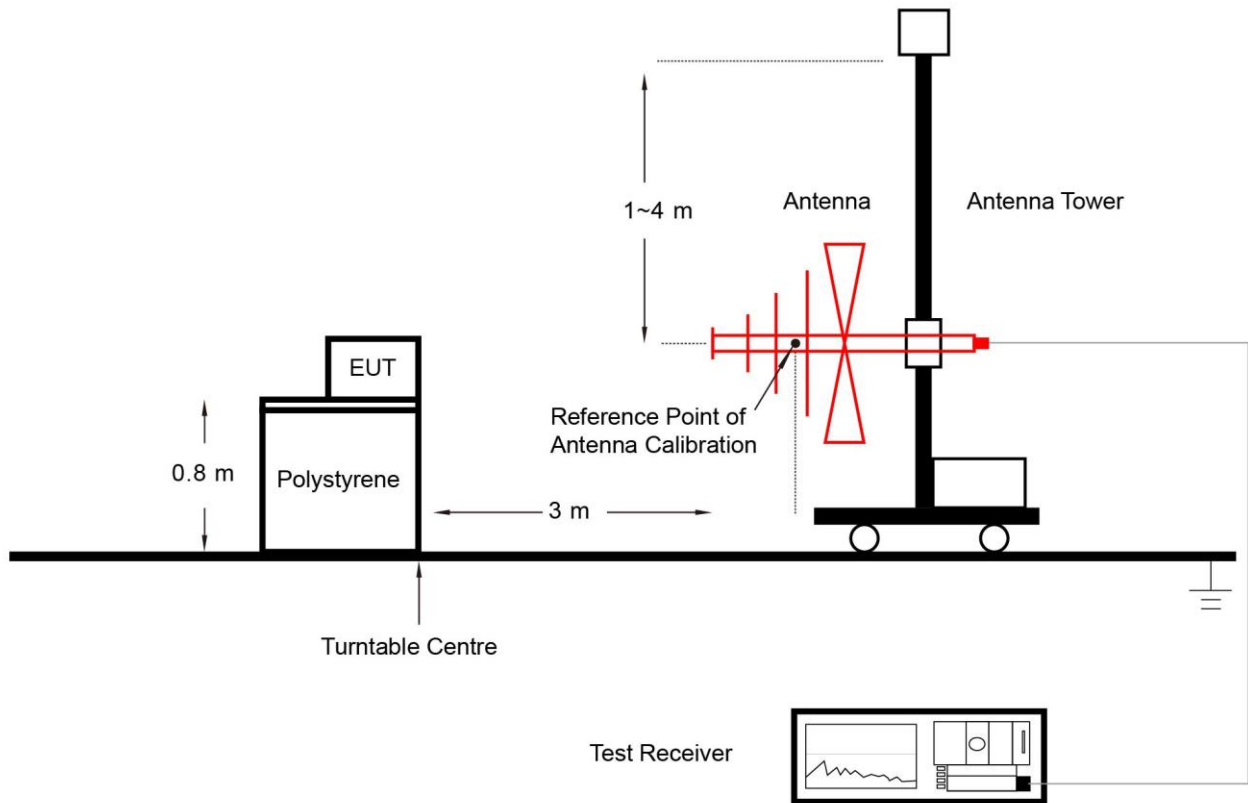

6.10.5. Test Result

Refer to Appendix A.10.

6.11. AC Conducted Emissions Measurement

6.11.1. Test Limit

FCC Part 15 Subpart C Paragraph 15.207 Limits		
Frequency (MHz)	QP (dB μ V)	Average (dB μ V)
0.15 - 0.50	66 - 56	56 - 46
0.50 - 5.0	56	46
5.0 - 30	60	50

Note 1: The lower limit shall apply at the transition frequencies.

Note 2: The limit decreases linearly with the logarithm of the frequency in the range 0.15MHz to 0.5MHz.

6.11.2. Test Setup

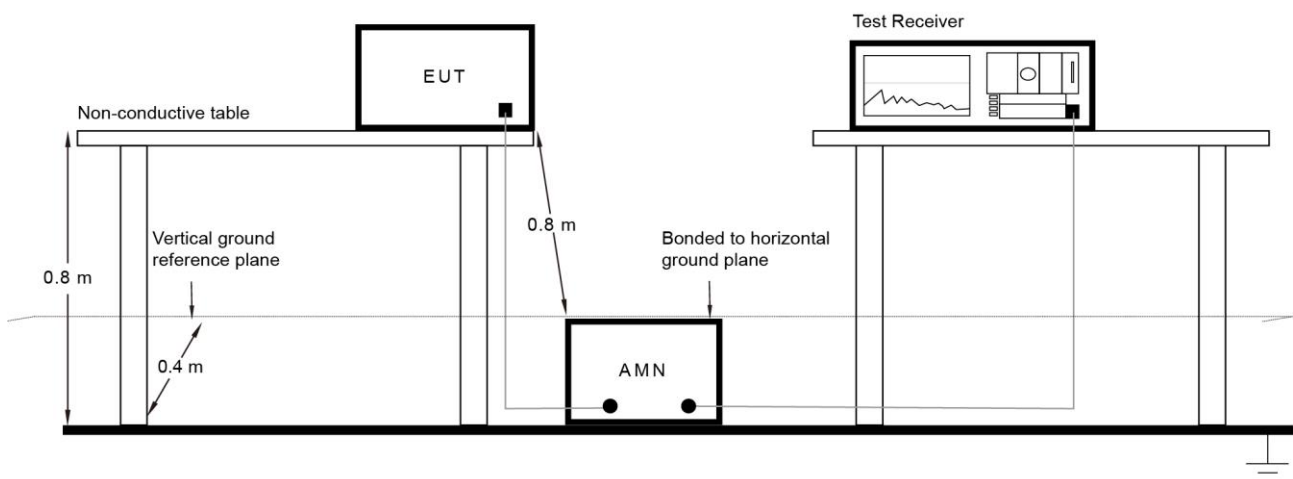

6.11.3. Test Result

Refer to Appendix A.11.

Appendix A - Test Result

A.1 Duty Cycle Test Result

Test Site	WZ-SR5	Test Engineer	Lynn Yang
Test Date	2023-05-16		

Test Frequency	Duty Cycle																																																															
915.05 MHz	27.39%																																																															
Duty Cycle (T = Transmission Duration)																																																																
BLE-1Mbps (T = 51.76ms)																																																																
<p>The screenshot shows a Keysight Spectrum Analyzer interface. The main display is a time-domain plot of a BLE signal at 915.050000 MHz. The signal is a series of pulses. A marker is placed on a pulse, showing a transmission duration of 25.88 ms and a power level of -0.32 dB. The reference power level is 31.00 dBm. The plot also shows a table of markers with columns for marker number, mode, time, and power level.</p> <table border="1"> <thead> <tr> <th>MARKER</th> <th>MODE</th> <th>TRC</th> <th>SCL</th> <th>X</th> <th>Y</th> <th>FUNCTION</th> <th>FUNCTION WIDTH</th> <th>FUNCTION VALUE</th> </tr> </thead> <tbody> <tr> <td>1</td> <td>Δ</td> <td>2</td> <td>L</td> <td>(Δ)</td> <td>189.0 ms</td> <td>(Δ)</td> <td></td> <td>-0.01 dB</td> </tr> <tr> <td>2</td> <td>F</td> <td>1</td> <td>L</td> <td></td> <td>337.1 ms</td> <td></td> <td></td> <td>14.31 dBm</td> </tr> <tr> <td>3</td> <td>Δ</td> <td>1</td> <td>L</td> <td>(Δ)</td> <td>25.88 ms</td> <td>(Δ)</td> <td></td> <td>-0.32 dB</td> </tr> <tr> <td>4</td> <td>F</td> <td>1</td> <td>L</td> <td></td> <td>337.1 ms</td> <td></td> <td></td> <td>14.31 dBm</td> </tr> <tr> <td>5</td> <td>Δ</td> <td>1</td> <td>L</td> <td>(Δ)</td> <td>25.88 ms</td> <td>(Δ)</td> <td></td> <td>-0.32 dB</td> </tr> <tr> <td>6</td> <td>F</td> <td>1</td> <td>L</td> <td></td> <td>400.1 ms</td> <td></td> <td></td> <td>14.28 dBm</td> </tr> </tbody> </table>		MARKER	MODE	TRC	SCL	X	Y	FUNCTION	FUNCTION WIDTH	FUNCTION VALUE	1	Δ	2	L	(Δ)	189.0 ms	(Δ)		-0.01 dB	2	F	1	L		337.1 ms			14.31 dBm	3	Δ	1	L	(Δ)	25.88 ms	(Δ)		-0.32 dB	4	F	1	L		337.1 ms			14.31 dBm	5	Δ	1	L	(Δ)	25.88 ms	(Δ)		-0.32 dB	6	F	1	L		400.1 ms			14.28 dBm
MARKER	MODE	TRC	SCL	X	Y	FUNCTION	FUNCTION WIDTH	FUNCTION VALUE																																																								
1	Δ	2	L	(Δ)	189.0 ms	(Δ)		-0.01 dB																																																								
2	F	1	L		337.1 ms			14.31 dBm																																																								
3	Δ	1	L	(Δ)	25.88 ms	(Δ)		-0.32 dB																																																								
4	F	1	L		337.1 ms			14.31 dBm																																																								
5	Δ	1	L	(Δ)	25.88 ms	(Δ)		-0.32 dB																																																								
6	F	1	L		400.1 ms			14.28 dBm																																																								

A.2 20dB Bandwidth Test Result

Test Site	WZ-SR5	Test Engineer	Lynn Yang
Test Date	2023-05-16		

Channel No.	Frequency (MHz)	20dB Bandwidth (kHz)	Limit (kHz)
01	915.05	47.72	≤ 500
30	916.50	47.59	≤ 500
58	917.90	47.77	≤ 500

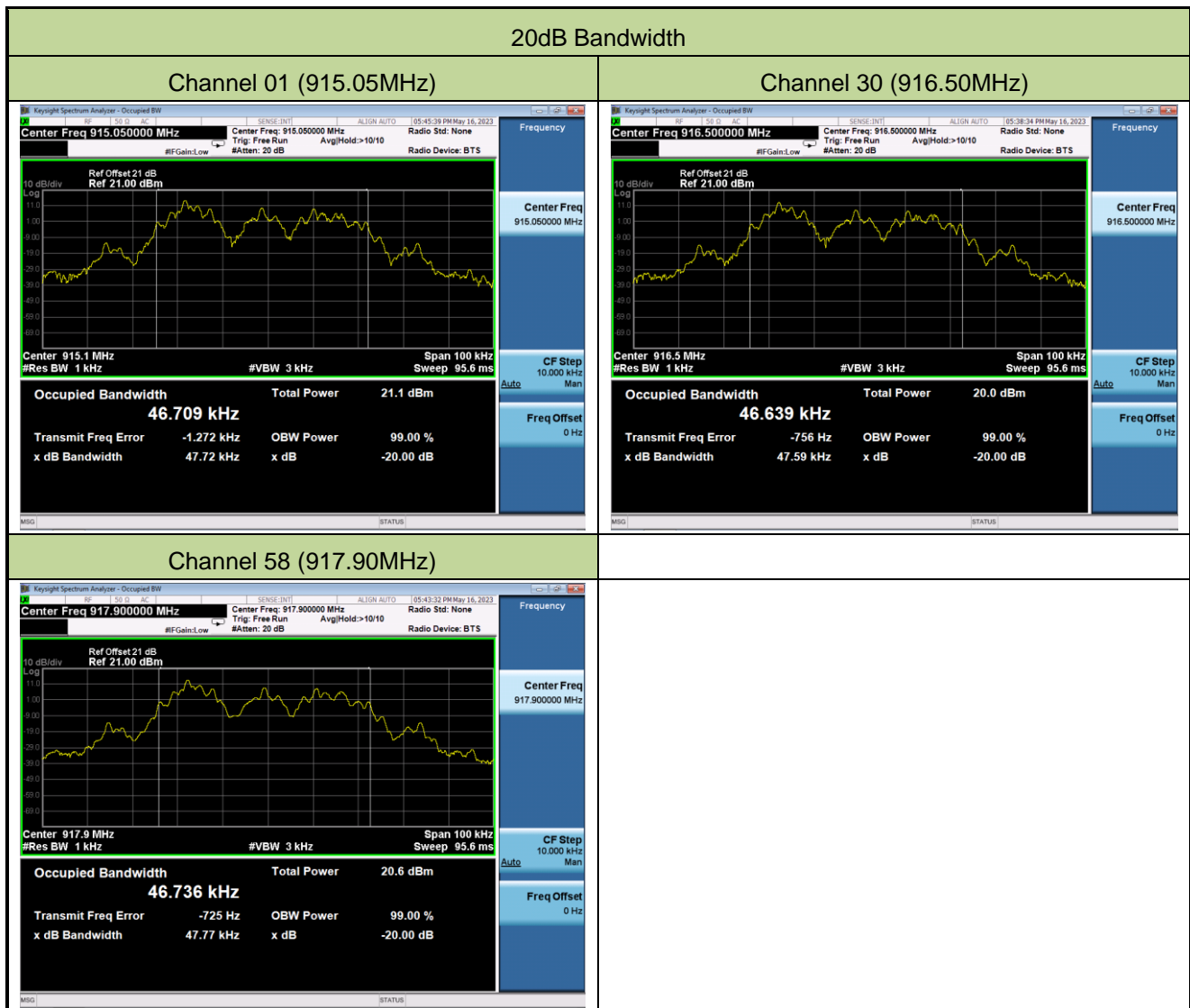

A.3 Output Power Test Result

Test Site	WZ-SR5	Test Engineer	Lynn Yang
Test Date	2023-05-16		

Channel No.	Frequency (MHz)	Output Power (dBm)	Power Limit (dBm)
01	915.05	14.307	≤ 30.00
30	916.50	13.492	≤ 30.00
58	917.90	13.563	≤ 30.00

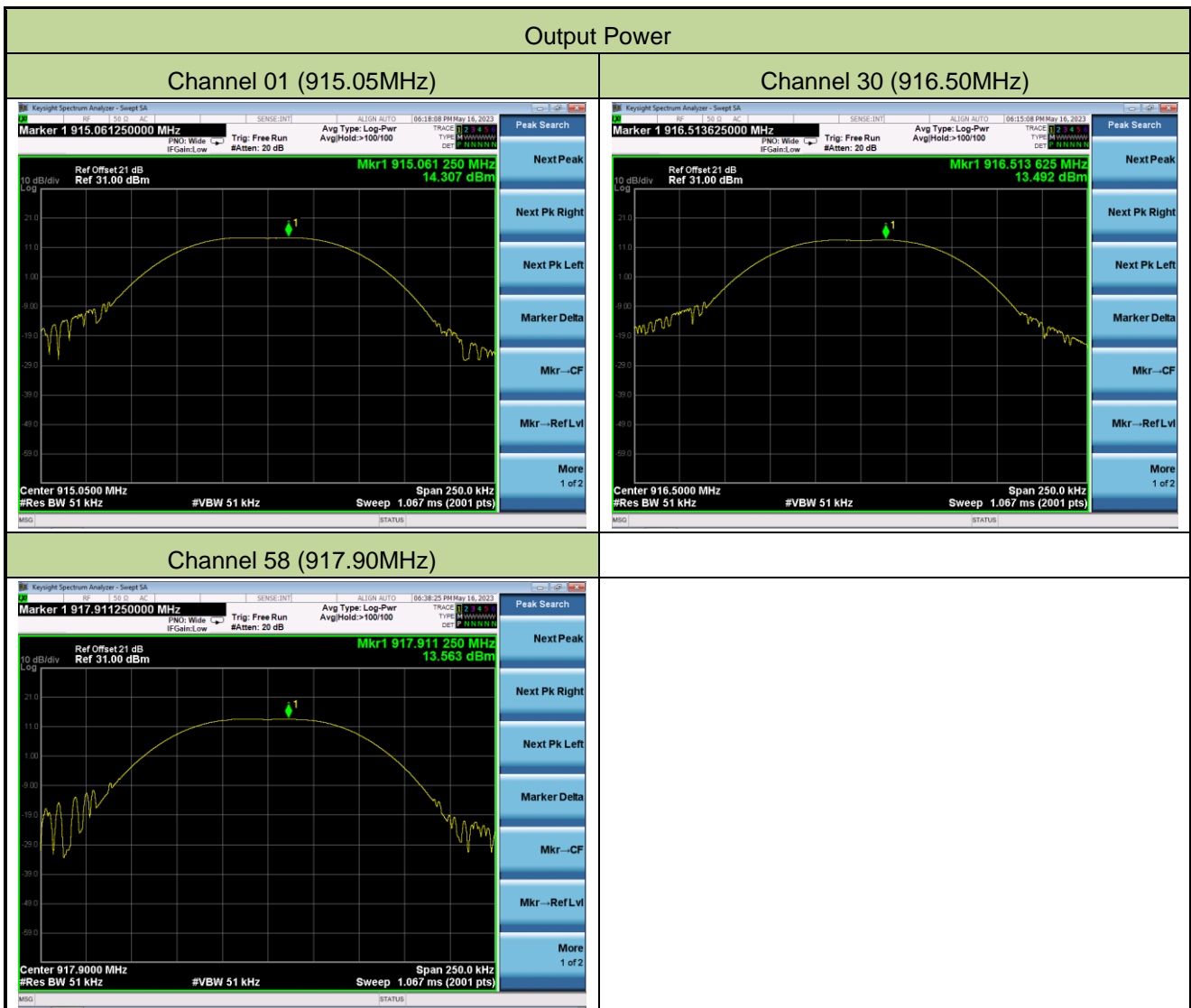

A.4 Carrier Frequency Separation Test Result

Test Site	WZ-SR5	Test Engineer	Lynn Yang
Test Date	2023-05-31		

Channel No.	Frequency (MHz)	Carrier Frequency Separation (kHz)	Limit (kHz)	Result
01	915.05	50	≥ 47.72	Pass
30	916.50	50	≥ 47.59	Pass
58	917.90	50	≥ 47.77	Pass

Note: Since 20dB bandwidth > 25kHz, so the limit is equal to 20dB bandwidth.

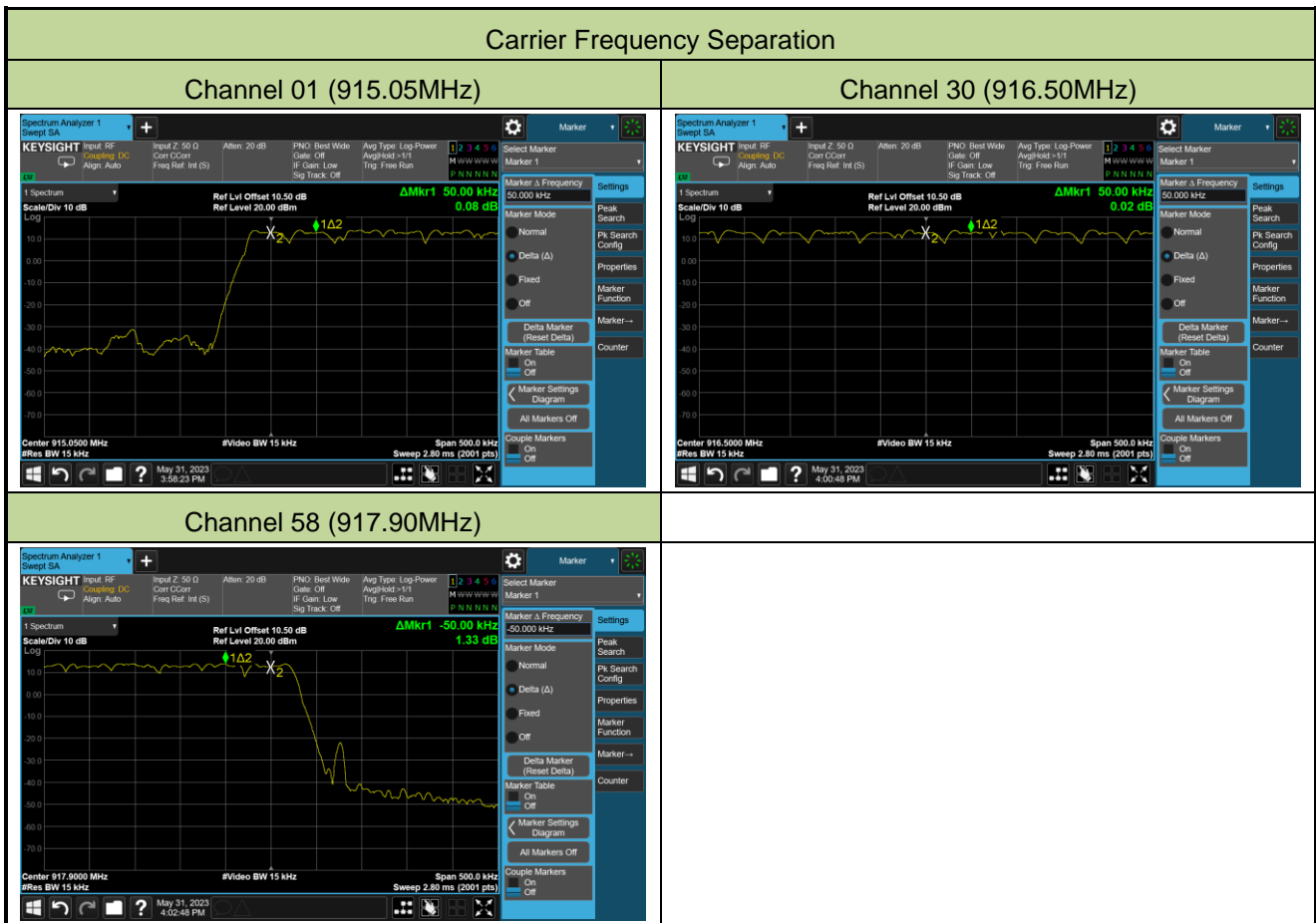

A.5 Number of Hopping Channels Test Result

Test Site	WZ-SR5	Test Engineer	Lynn Yang
Test Date	2023-05-31		

Total Channel Numbers	Frequency (MHz)	Limit (Hopping Channels)	Result
58	915.05 ~ 917.90	≥ 50	Pass



A.6 Time of Occupancy Test Result

Test Site	WZ-SR5	Test Engineer	Lynn Yang
Test Date	2023-05-31		

Channel No.	Frequency (MHz)	Transmit Time Per Hop (ms)	Observation Period (s)	Number of Hops in Observation Period	Time of Occupancy (ms)	Limit (ms)	Result
01 ~ 58	915.05 ~ 917.90	25.50	20	6	153	≤ 400	Pass

Note: Time of Occupancy (ms) = Transmit Time Per Hop (ms) * Number of Hops in Observation Period

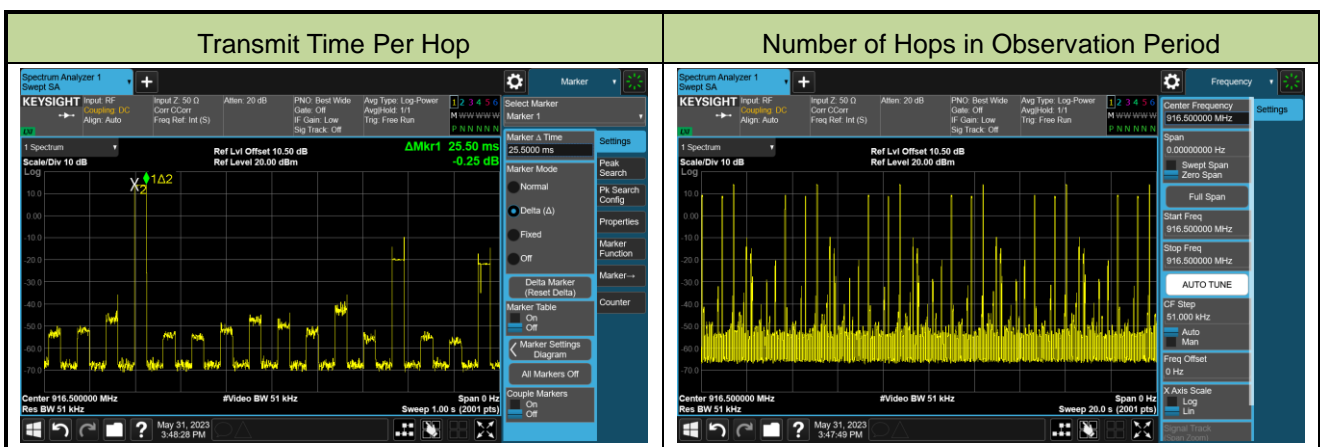

A.7 Band-edge Compliance Test Result

Test Site	WZ-SR5	Test Engineer	Lynn Yang
Test Date	2023-05-29 ~ 2023-05-31		

Channel No.	Frequency (MHz)	Limit	Result
01	915.05	20dBc	Pass
58	917.90	20dBc	Pass

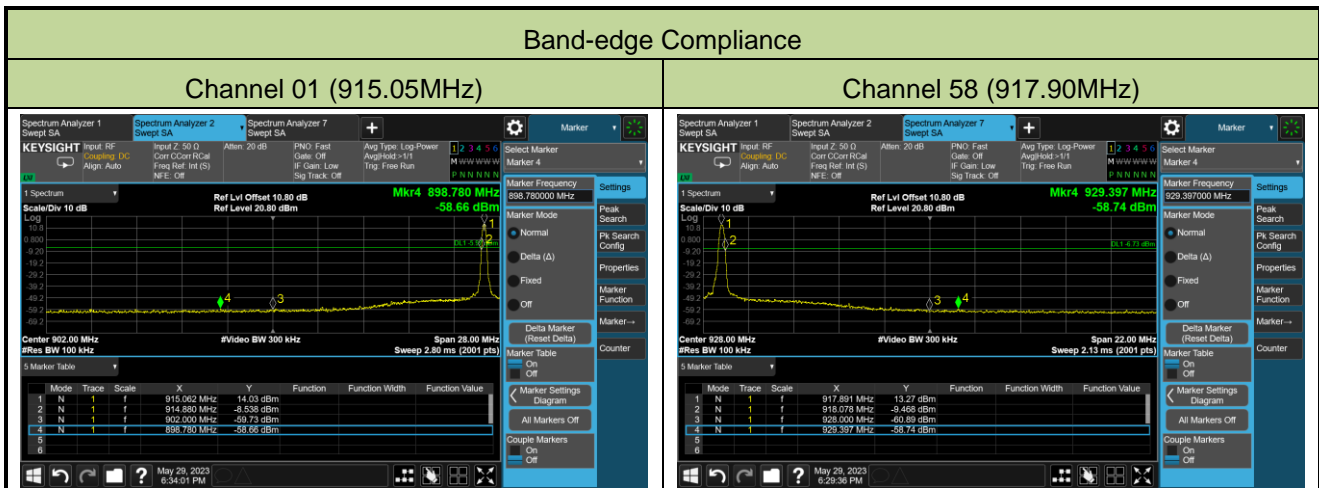

Operation Frequency Range of 20dB Bandwidth within Hopping Mode



A.8 Conducted Spurious Emissions Test Result

Test Site	WZ-SR5	Test Engineer	Lynn Yang
Test Date	2023-05-16		

Channel No.	Frequency (MHz)	Limit (MHz)	Result
01	915.05	20dBc	Pass
30	916.50	20dBc	Pass
58	917.90	20dBc	Pass

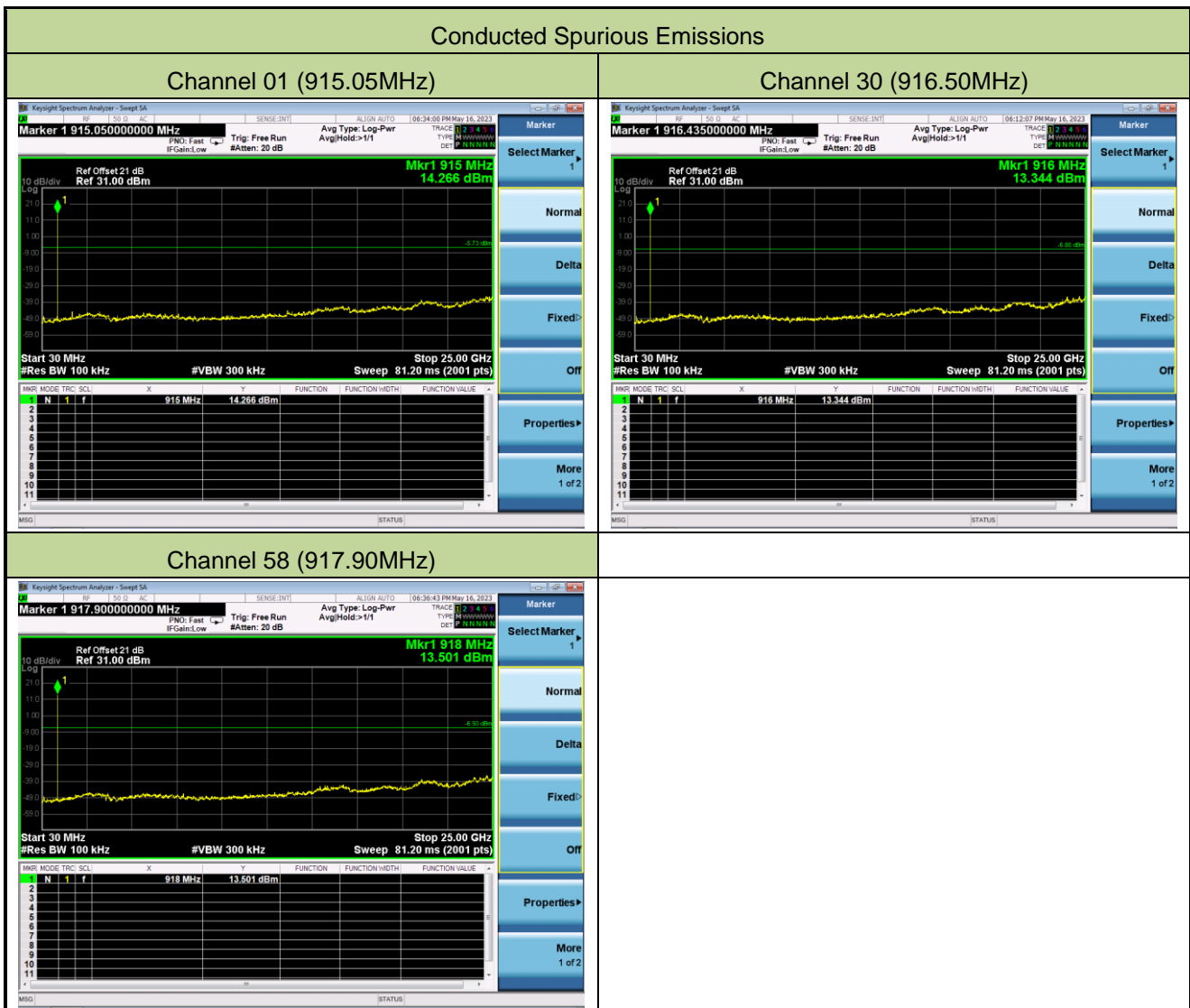

A.9 Radiated Spurious Emission Test Result

Test Site	WZ-AC1	Test Engineer	Charles Zhang
Test Date	2023-05-11		
Remark:	1. Average measurement was not performed if peak level lower than average limit. 2. Other frequency was 20dB below limit line within 1-10GHz, there is not show in the report.		

Test Channel	Frequency (MHz)	Reading Level (dBμV)	Factor (dB/m)	Measure Level (dBμV/m)	Limit (dBμV/m)	Margin (dB)	Detector	Polarization
01	2861.5	40.7	-2.0	38.7	74.0	-35.3	Peak	Horizontal
	4833.5	37.8	2.8	40.6	74.0	-33.4	Peak	Horizontal
	8259.0	37.4	8.6	46.0	74.0	-28.0	Peak	Horizontal
	3822.0	37.5	0.2	37.7	74.0	-36.3	Peak	Vertical
	4850.5	36.8	2.7	39.5	74.0	-34.5	Peak	Vertical
	7536.5	37.0	8.2	45.2	74.0	-28.8	Peak	Vertical
30	3660.5	40.1	-0.4	39.7	74.0	-34.3	Peak	Horizontal
	5139.5	37.2	3.6	40.8	74.0	-33.2	Peak	Horizontal
	7494.0	36.8	8.3	45.1	74.0	-28.9	Peak	Horizontal
	3669.0	38.6	-0.3	38.3	74.0	-35.7	Peak	Vertical
	4850.5	37.2	2.7	39.9	74.0	-34.1	Peak	Vertical
	7409.0	36.8	8.1	44.9	74.0	-29.1	Peak	Vertical
58	4876.0	37.0	2.8	39.8	74.0	-34.2	Peak	Horizontal
	7375.0	36.4	8.3	44.7	74.0	-29.3	Peak	Horizontal
	8250.5	37.6	8.5	46.1	74.0	-27.9	Peak	Horizontal
	4825.0	36.5	2.8	39.3	74.0	-34.7	Peak	Vertical
	7460.0	36.6	8.2	44.8	74.0	-29.2	Peak	Vertical
	8429.0	37.7	8.6	46.3	74.0	-27.7	Peak	Vertical

Note: Measure Level (dBμV/m) = Reading Level (dBμV) + Factor (dB/m)

Factor ((dB/m) = Cable Loss (dB) + Antenna Factor (dB/m) - Pre_Amplifier Gain (dB)

The Result of Radiated Emission below 1GHz:

Site: WZ-AC1	Test Date: 2023-05-12
Limit: FCC_Part15.209_RSE(3m)	Engineer: Charles Zhang
Probe: VULB 9168_25-2000MHz	Polarity: Horizontal
EUT: Navimow Charging Station	Power: DC Source
Test Mode: Transmit at 915.05MHz	

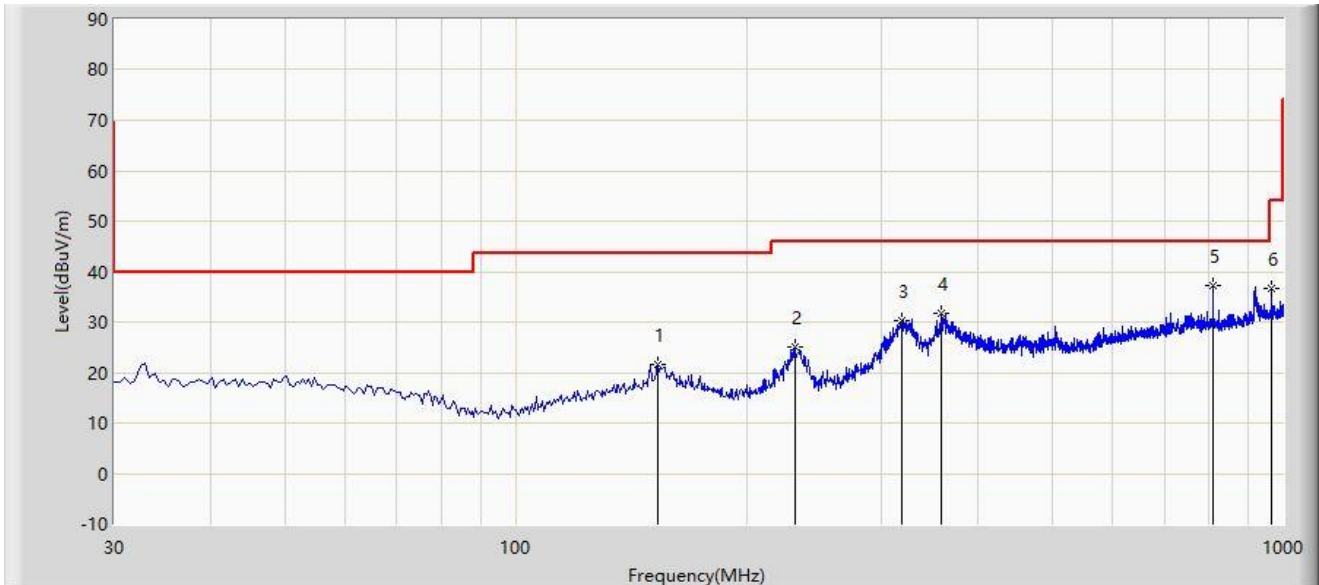

No	Mark	Frequency (MHz)	Measure Level (dB μ V/m)	Reading Level (dB μ V)	Margin (dB)	Limit (dB μ V/m)	Factor (dB/m)	Type
1		153.190	21.563	3.431	-21.937	43.500	18.132	PK
2		231.275	25.192	10.139	-20.808	46.000	15.054	PK
3		318.575	30.362	11.318	-15.638	46.000	19.044	PK
4		357.860	31.827	12.200	-14.173	46.000	19.627	PK
5	*	811.335	37.109	8.834	-8.891	46.000	28.276	PK
6		967.020	36.658	6.753	-17.342	54.000	29.905	PK

Note 1: " * ", means this data is the worst emission level.

Note 2: Measure Level (dB μ V/m) = Reading Level (dB μ V) + Factor (dB/m).

Note 3: Factor (dB/m) = Cable Loss (dB) + Antenna Factor (dB/m).

Note 4: Quasi-Peak measurement was not performed when peak measure level was lower than the quasi-peak limit.

Note 5: The amplitude of radiated emissions (frequency range from 9kHz to 30MHz) is that proximity to ambient noise, which also are attenuated more than 20 dB below the permissible value. Therefore, the data is not presented in the report.

Site: WZ-AC1	Test Date: 2023-05-12
Limit: FCC_Part15.209_RSE(3m)	Engineer: Charles Zhang
Probe: VULB 9168_25-2000MHz	Polarity: Vertical
EUT: Navimow Charging Station	Power: DC Source
Test Mode: Transmit at 915.05MHz	

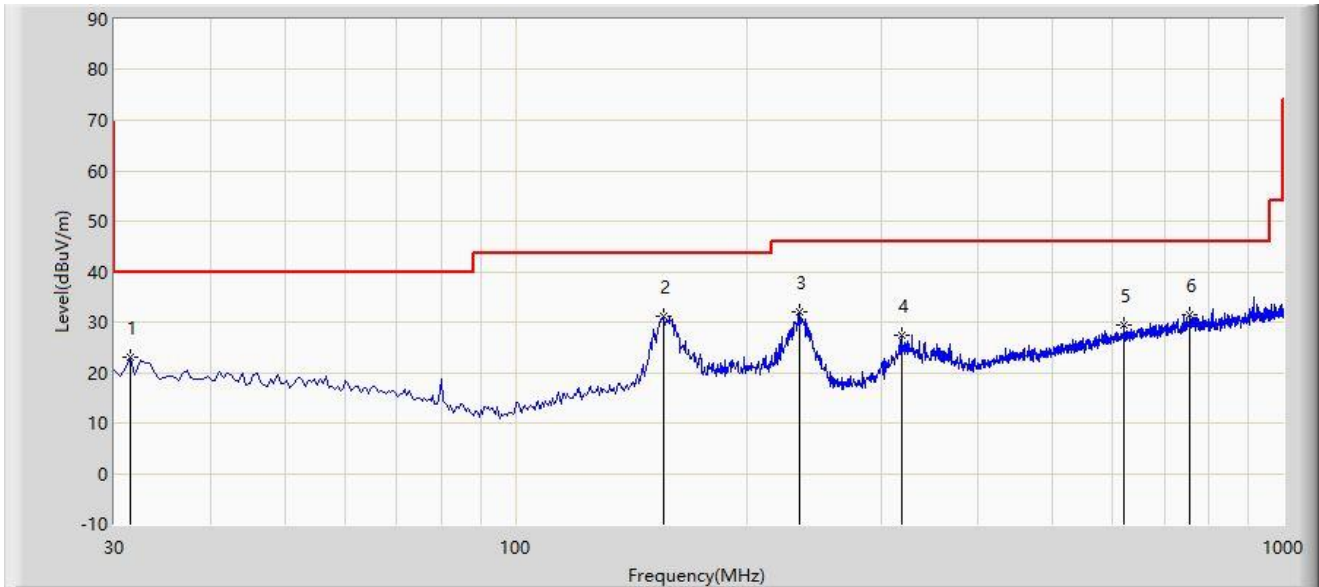

No	Mark	Frequency (MHz)	Measure Level (dBμV/m)	Reading Level (dBμV)	Margin (dB)	Limit (dBμV/m)	Factor (dB/m)	Type
1		31.455	22.980	5.672	-17.020	40.000	17.308	PK
2	*	155.615	31.095	12.947	-12.405	43.500	18.148	PK
3		234.670	32.044	16.514	-13.956	46.000	15.530	PK
4		318.575	27.521	8.477	-18.479	46.000	19.044	PK
5		619.760	29.407	3.565	-16.593	46.000	25.842	PK
6		756.530	31.530	3.272	-14.470	46.000	28.258	PK

Note 1: " * ", means this data is the worst emission level.

Note 2: Measure Level (dBμV/m) = Reading Level (dBμV) + Factor (dB/m).

Note 3: Factor (dB/m) = Cable Loss (dB) + Antenna Factor (dB/m).

Note 4: Quasi-Peak measurement was not performed when peak measure level was lower than the quasi-peak limit.

Note 5: The amplitude of radiated emissions (frequency range from 9kHz to 30MHz) is that proximity to ambient noise, which also are attenuated more than 20 dB below the permissible value. Therefore, the data is not presented in the report.

A.10 Radiated Restricted Band Edge Test Result

Site: WZ-AC1	Test Date: 2023-05-11
Limit: FCC_Part15.209_RSE(3m)	Engineer: Carl Jiang
Probe: VULB 9168_25-2000MHz	Polarity: Horizontal
EUT: Navimow Charging Station	Power: DC Source
Test Mode: Transmit at 915.05MHz	

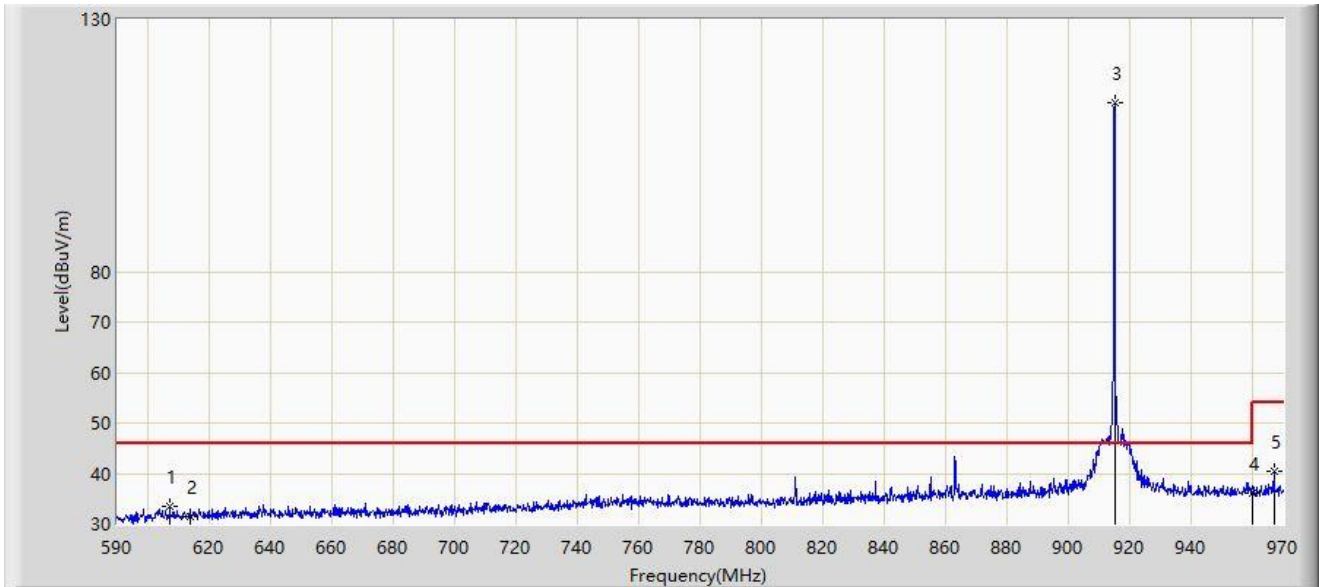

No	Mark	Frequency (MHz)	Measure Level (dBμV/m)	Reading Level (dBμV)	Margin (dB)	Limit (dBμV/m)	Factor (dB/m)	Type
1		607.100	33.593	7.939	-12.407	46.000	25.654	PK
2		614.000	31.592	5.860	-14.408	46.000	25.732	PK
3		915.090	113.601	83.849	N/A	N/A	29.752	PK
4	*	960.000	36.111	6.332	-9.889	46.000	29.779	PK
5		966.960	40.351	10.447	-13.649	54.000	29.904	PK

Note 1: " * ", means this data is the worst emission level.

Note 2: Measure Level (dBμV/m) = Reading Level (dBμV) + Factor (dB/m).

Note 3: Factor (dB/m) = Cable Loss (dB) + Antenna Factor (dB/m).

Site: WZ-AC1	Test Date: 2023-05-11
Limit: FCC_Part15.209_RSE(3m)	Engineer: Carl Jiang
Probe: VULB 9168_25-2000MHz	Polarity: Vertical
EUT: Navimow Charging Station	Power: DC Source
Test Mode: Transmit at 915.05MHz	

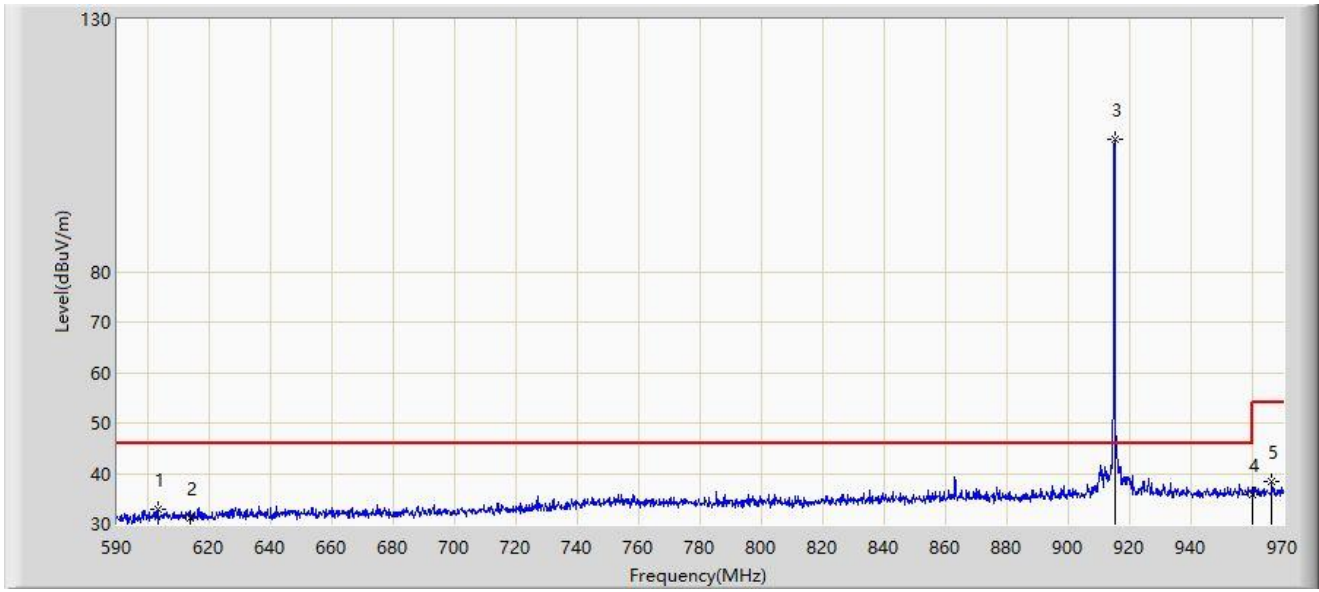

No	Mark	Frequency (MHz)	Measure Level (dB μ V/m)	Reading Level (dB μ V)	Margin (dB)	Limit (dB μ V/m)	Factor (dB/m)	Type
1		603.300	32.791	7.224	-13.209	46.000	25.567	PK
2		614.000	31.224	5.492	-14.776	46.000	25.732	PK
3		915.090	106.189	76.437	N/A	N/A	29.752	PK
4	*	960.000	35.755	5.976	-10.245	46.000	29.779	PK
5		966.390	38.403	8.510	-15.597	54.000	29.893	PK

Note 1: " * ", means this data is the worst emission level.

Note 2: Measure Level (dB μ V/m) = Reading Level (dB μ V) + Factor (dB/m).

Note 3: Factor (dB/m) = Cable Loss (dB) + Antenna Factor (dB/m).

Site: WZ-AC1	Test Date: 2023-05-11
Limit: FCC_Part15.209_RSE(3m)	Engineer: Carl Jiang
Probe: VULB 9168_25-2000MHz	Polarity: Horizontal
EUT: Navimow Charging Station	Power: DC Source
Test Mode: Transmit at 917.90MHz	

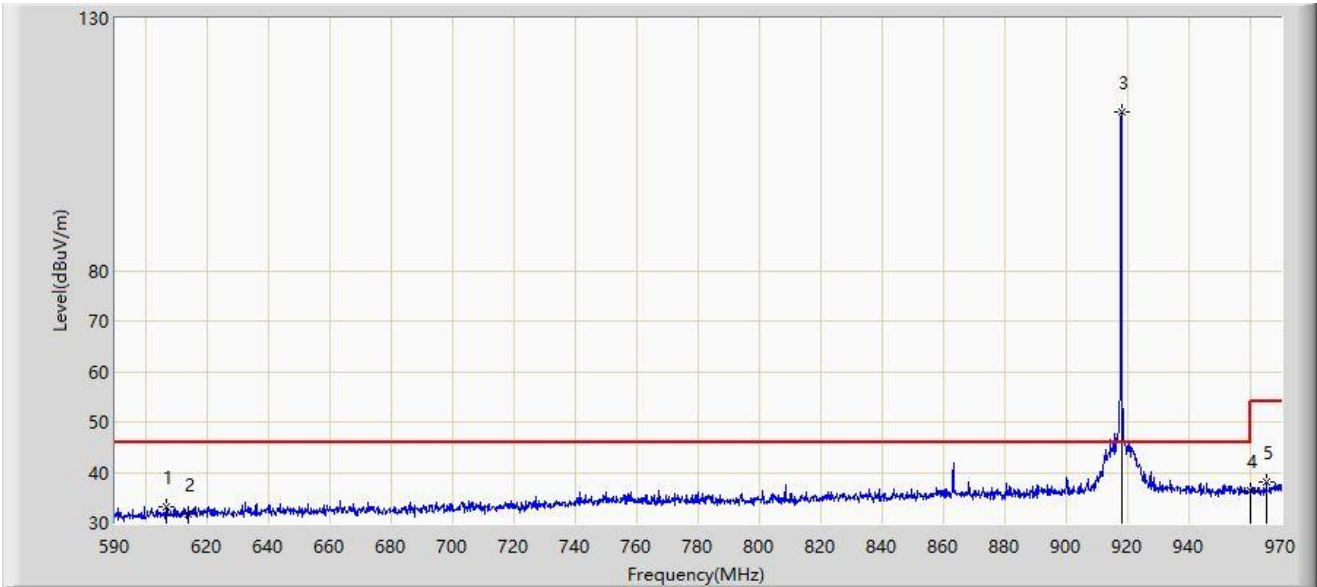

No	Mark	Frequency (MHz)	Measure Level (dBμV/m)	Reading Level (dBμV)	Margin (dB)	Limit (dBμV/m)	Factor (dB/m)	Type
1		606.720	33.083	7.433	-12.917	46.000	25.650	PK
2		614.000	31.682	5.950	-14.318	46.000	25.732	PK
3		917.940	111.482	81.654	N/A	N/A	29.827	PK
4	*	960.000	36.436	6.657	-9.564	46.000	29.779	PK
5		965.250	38.114	8.233	-15.886	54.000	29.880	PK

Note 1: " * ", means this data is the worst emission level.

Note 2: Measure Level (dBμV/m) = Reading Level (dBμV) + Factor (dB/m).

Note 3: Factor (dB/m) = Cable Loss (dB) + Antenna Factor (dB/m).

Site: WZ-AC1	Test Date: 2023-05-11
Limit: FCC_Part15.209_RSE(3m)	Engineer: Carl Jiang
Probe: VULB 9168_25-2000MHz	Polarity: Vertical
EUT: Navimow Charging Station	Power: DC Source
Test Mode: Transmit at 917.90MHz	

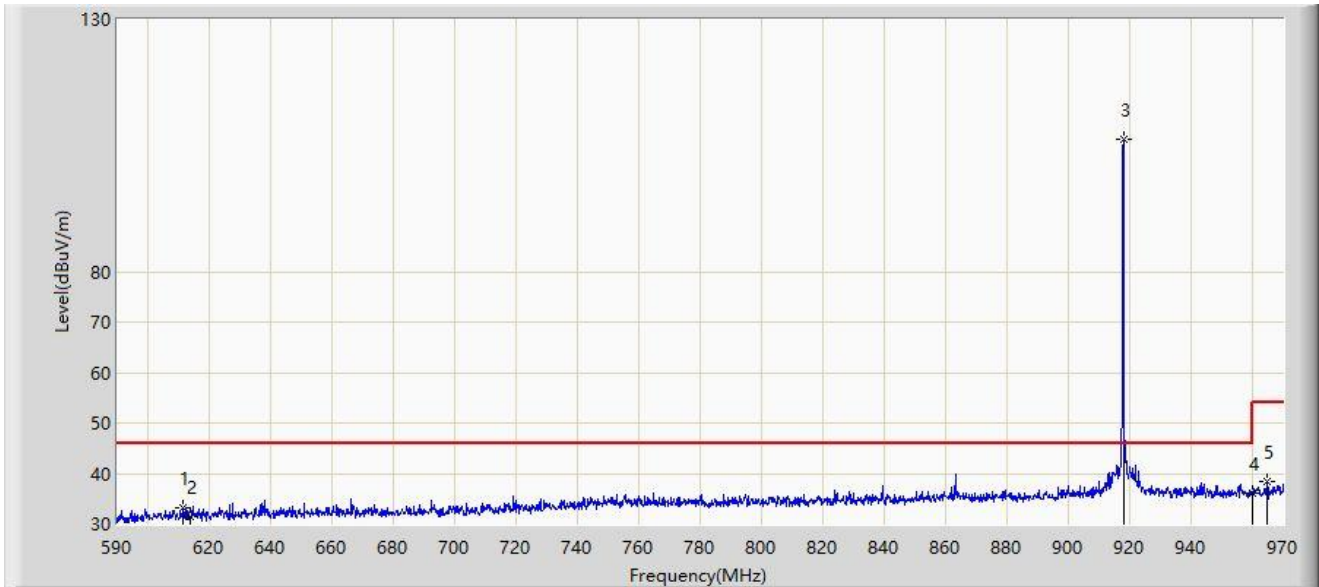

No	Mark	Frequency (MHz)	Measure Level (dB μ V/m)	Reading Level (dB μ V)	Margin (dB)	Limit (dB μ V/m)	Factor (dB/m)	Type
1		611.660	33.226	7.503	-12.774	46.000	25.723	PK
2		614.000	31.394	5.662	-14.606	46.000	25.732	PK
3		917.940	106.250	76.422	N/A	N/A	29.827	PK
4	*	960.000	36.161	6.382	-9.839	46.000	29.779	PK
5		964.680	38.287	8.416	-15.713	54.000	29.871	PK

Note 1: " * ", means this data is the worst emission level.

Note 2: Measure Level (dB μ V/m) = Reading Level (dB μ V) + Factor (dB/m).

Note 3: Factor (dB/m) = Cable Loss (dB) + Antenna Factor (dB/m).

A.11 AC Conducted Emissions Test Result

Site: WZ-SR2	Test Date: 2023-06-01
Temperature: 23.1°C	Humidity: 52.1%
Limit: FCC_Part15.207_CE_AC Power	Engineer: Alin Zhou
Probe: ENV216_101683_Filter Off	Polarity: Line
EUT: Navimow Charging Station	Power: AC 120V/60Hz
Test Mode: Transmit at 915.05MHz	

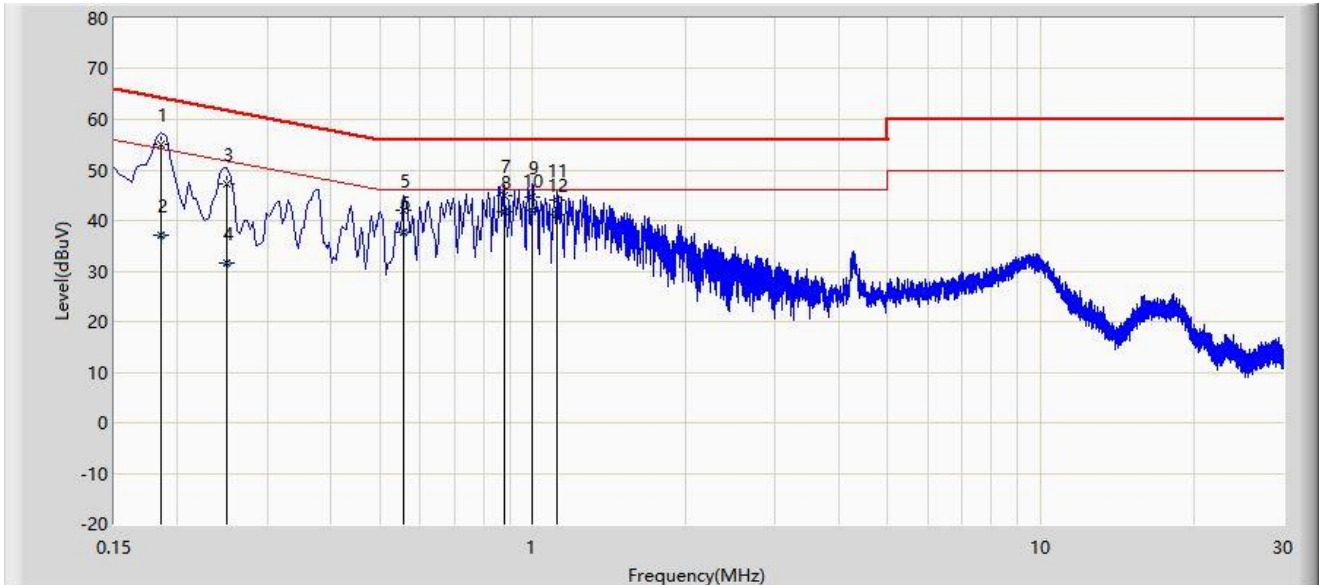

No	Mark	Frequency (MHz)	Measure Level (dBμV)	Reading Level (dBμV)	Margin (dB)	Limit (dBμV)	Factor (dB)	Type
1		0.186	55.064	45.452	-9.149	64.213	9.612	QP
2		0.186	37.134	27.521	-17.080	54.213	9.612	AV
3		0.250	47.104	37.473	-14.653	61.757	9.631	QP
4		0.250	31.474	21.843	-20.283	51.757	9.631	AV
5		0.558	42.036	32.255	-13.964	56.000	9.781	QP
6		0.558	37.663	27.882	-8.337	46.000	9.781	AV
7		0.878	44.921	34.986	-11.079	56.000	9.935	QP
8		0.878	41.665	31.730	-4.335	46.000	9.935	AV
9		0.998	44.736	34.747	-11.264	56.000	9.989	QP
10	*	0.998	42.029	32.041	-3.971	46.000	9.989	AV
11		1.118	43.921	33.930	-12.079	56.000	9.991	QP
12		1.118	41.149	31.158	-4.851	46.000	9.991	AV

Note 1: " * ", means this data is the worst emission level.

Note 2: Measure Level (dBμV) = Reading Level (dBμV) + Factor (dB).

Note 3: Factor (dB) = Cable Loss (dB) + LISN Factor (dB).

Site: WZ-SR2	Test Date: 2023-06-01
Temperature: 23.1°C	Humidity: 52.1%
Limit: FCC_Part15.207_CE_AC Power	Engineer: Alin Zhou
Probe: ENV216_101683_Filter Off	Polarity: Neutral
EUT: Navimow Charging Station	Power: AC 120V/60Hz
Test Mode: Transmit at 915.05MHz	

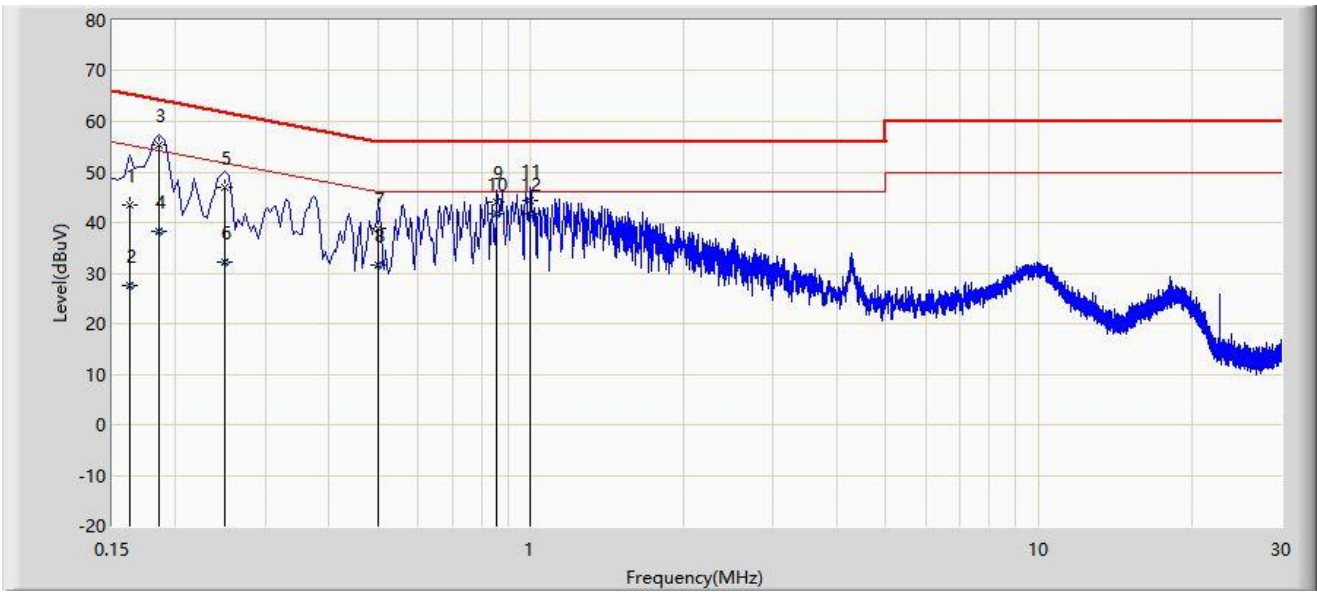

No	Mark	Frequency (MHz)	Measure Level (dBμV)	Reading Level (dBμV)	Margin (dB)	Limit (dBμV)	Factor (dB)	Type
1		0.162	43.343	33.770	-22.017	65.361	9.574	QP
2		0.162	27.568	17.995	-27.793	55.361	9.574	AV
3		0.186	55.373	45.780	-8.840	64.213	9.593	QP
4		0.186	38.201	28.607	-16.013	54.213	9.593	AV
5		0.250	46.951	37.327	-14.807	61.757	9.623	QP
6		0.250	32.291	22.668	-19.466	51.757	9.623	AV
7		0.502	38.815	29.063	-17.185	56.000	9.751	QP
8		0.502	31.472	21.721	-14.528	46.000	9.751	AV
9		0.858	44.023	34.097	-11.977	56.000	9.926	QP
10	*	0.858	41.821	31.895	-4.179	46.000	9.926	AV
11		0.998	44.255	34.256	-11.745	56.000	9.999	QP
12		0.998	41.611	31.612	-4.389	46.000	9.999	AV

Note 1: " * ", means this data is the worst emission level.

Note 2: Measure Level (dBμV) = Reading Level (dBμV) + Factor (dB).

Note 3: Factor (dB) = Cable Loss (dB) + LISN Factor (dB).

Appendix B - Test Setup Photograph

Refer to "Test Setup Photograph" file.

Appendix C - EUT Photograph

Refer to "EUT Photograph" file.

The End