

---

# FCC Test Report

---

Report No.: AGC12060230401FE10

**FCC ID** : 2BAWU-MPC43  
**APPLICATION PURPOSE** : Original Equipment  
**PRODUCT DESIGNATION** : Mini PC  
**BRAND NAME** : N/A  
**MODEL NAME** : MPC43  
**APPLICANT** : Shenzhen MADIGI Electronic Technology Co., Ltd  
**DATE OF ISSUE** : Jun. 27, 2023  
**STANDARD(S)** : FCC Part 15 Subpart E §15.407  
**REPORT VERSION** : V 1.0

Attestation of Global Compliance (Shenzhen) Co., Ltd



Any report having not been signed by authorized approver, or having been altered without authorization, or having not been stamped by the "Dedicated Testing/Inspection Stamp" is deemed to be invalid. Copying or excerpting portion of, or altering the content of the report is not permitted without the written authorization of AGC. The test results presented in the report apply only to the tested sample. Any objections to report issued by AGC should be submitted to AGC within 15days after the issuance of the test report. Further enquiry of validity or verification of the test report should be addressed to AGC by agc01@agccert.com.

Attestation of Global Compliance(Shenzhen)Co., Ltd  
Attestation of Global Compliance(Shenzhen)Std & Tech Co., Ltd  
Tel: +86-755 2523 4088 E-mail: agc@agccert.com Web: <http://www.agccert.com/>



**REPORT REVISE RECORD**

Report Version	Revise Time	Issued Date	Valid Version	Notes
V1.0	/	Jun. 27, 2023	Valid	Initial Release

Any report having not been signed by authorized approver, or having been altered without authorization, or having not been stamped by the "Dedicated Testing/Inspection Stamp" is deemed to be invalid. Copying or excerpting portion of, or altering the content of the report is not permitted without the written authorization of AGC. The test results presented in the report apply only to the tested sample. Any objections to report issued by AGC should be submitted to AGC within 15days after the issuance of the test report. Further enquiry of validity or verification of the test report should be addressed to AGC by [agc01@agccert.com](mailto:agc01@agccert.com).

Attestation of Global Compliance(Shenzhen)Co., Ltd  
Attestation of Global Compliance(Shenzhen)Std & Tech Co., Ltd  
Tel: +86-755 2523 4088 E-mail: [agc@agccert.com](mailto:agc@agccert.com) Web: <http://www.agccert.com/>

## TABLE OF CONTENTS

<b>1. GENERAL INFORMATION</b> .....	<b>5</b>
<b>2. PRODUCT INFORMATION</b> .....	<b>6</b>
2.1 PRODUCT TECHNICAL DESCRIPTION .....	6
2.2 TEST FREQUENCY LIST .....	7
2.3 RELATED SUBMITTAL(S) / GRANT (S).....	9
2.4 TEST METHODOLOGY .....	9
2.5 SPECIAL ACCESSORIES .....	9
2.6 EQUIPMENT MODIFICATIONS .....	9
2.7 ANTENNA REQUIREMENT .....	9
2.8 DESCRIPTION OF AVAILABLE ANTENNAS .....	10
<b>3. TEST ENVIRONMENT</b> .....	<b>11</b>
3.1 ADDRESS OF THE TEST LABORATORY .....	11
3.2 TEST FACILITY .....	11
3.3 ENVIRONMENTAL CONDITIONS .....	12
3.4 MEASUREMENT UNCERTAINTY .....	12
3.5 LIST OF EQUIPMENTS USED .....	13
<b>4.SYSTEM TEST CONFIGURATION</b> .....	<b>14</b>
4.1 EUT CONFIGURATION .....	14
4.2 EUT EXERCISE .....	14
4.3 CONFIGURATION OF SYSTEM UNDER TEST .....	14
4.4 EQUIPMENT USED IN TESTED SYSTEM .....	14
4.5 SUMMARY OF TEST RESULTS .....	15
<b>5. DESCRIPTION OF TEST MODES</b> .....	<b>16</b>
<b>6. POWER LIMITS. MAXIMUM OUTPUT POWER MEASUREMENT</b> .....	<b>18</b>
6.1 MEASUREMENT LIMITS.....	18
6.2 MEASUREMENT PROCEDURE .....	18
6.3 MEASUREMENT SETUP (BLOCK DIAGRAM OF CONFIGURATION) .....	19
6.4 MEASUREMENT RESULT .....	20
<b>7. 26DB&amp; 99% BANDWIDTH MEASUREMENT</b> .....	<b>26</b>
7.1 MEASUREMENT LIMITS.....	26
7.2 MEASUREMENT PROCEDURE .....	26
7.3 MEASUREMENT SETUP (BLOCK DIAGRAM OF CONFIGURATION) .....	26
7.4 MEASUREMENT RESULTS .....	27
<b>8. POWER SPECTRAL DENSITY MEASUREMENT</b> .....	<b>28</b>
8.1 MEASUREMENT LIMITS.....	28
8.2 MEASUREMENT PROCEDURE .....	28

Any copy, false or misleading information, or having been altered without authorization, or having not been stamped by the "Dedicated Testing/Inspection Stamp" is deemed to be invalid. Copying or excerpting portion of, or altering the content of the report is not permitted without the written authorization of AGC. The test results presented in the report apply only to the tested sample. Any objections to report issued by AGC should be submitted to AGC within 15days after the issuance of the test report. Further enquiry of validity or verification of the test report should be addressed to AGC by agc01@agccert.com.

8.3 MEASUREMENT SETUP (BLOCK DIAGRAM OF CONFIGURATION) .....	29
8.4 MEASUREMENT RESULTS .....	30
<b>9. IN-BAND EMISSIONS (CHANNEL MASK) .....</b>	<b>36</b>
9.1 MEASUREMENT LIMIT .....	36
9.2 MEASUREMENT PROCEDURE .....	36
9.3 MEASUREMENT SETUP (BLOCK DIAGRAM OF CONFIGURATION) .....	37
9.4 MEASUREMENT RESULTS .....	38
10.1 MEASUREMENT LIMIT .....	39
10.2 MEASUREMENT PROCEDURE .....	40
10.3 MEASUREMENT SETUP (BLOCK DIAGRAM OF CONFIGURATION) .....	40
10.4 MEASUREMENT RESULTS .....	41
<b>11. UNWANTED EMISSIONS .....</b>	<b>42</b>
11.1 LIMITS OF RADIATED EMISSION TEST .....	42
11.2 MEASUREMENT PROCEDURE .....	42
11.3 MEASUREMENT SETUP (BLOCK DIAGRAM OF CONFIGURATION) .....	45
11.4 MEASUREMENT RESULT .....	46
<b>12. AC POWER LINE CONDUCTED EMISSION TEST .....</b>	<b>65</b>
12.1 LIMITS OF LINE CONDUCTED EMISSION TEST .....	65
12.2 MEASUREMENT SETUP (BLOCK DIAGRAM OF CONFIGURATION) .....	65
12.3 PRELIMINARY PROCEDURE OF LINE CONDUCTED EMISSION TEST .....	66
11.4 FINAL PROCEDURE OF LINE CONDUCTED EMISSION TEST .....	66
11.5 MEASUREMENT RESULTS .....	66
<b>APPENDIX I: PHOTOGRAPHS OF TEST SETUP .....</b>	<b>69</b>
<b>APPENDIX II: PHOTOGRAPHS OF TEST EUT .....</b>	<b>69</b>

Any report having not been signed by authorized approver, or having been altered without authorization, or having not been stamped by the “Dedicated Testing/Inspection Stamp” is deemed to be invalid. Copying or excerpting portion of, or altering the content of the report is not permitted without the written authorization of AGC. The test results presented in the report apply only to the tested sample. Any objections to report issued by AGC should be submitted to AGC within 15days after the issuance of the test report. Further enquiry of validity or verification of the test report should be addressed to AGC by agc01@agccert.com.

## 1. GENERAL INFORMATION

Applicant	Shenzhen MADIGI Electronic Technology Co., Ltd
Address	Room 111, 1A Floor, Kanghesheng Bldg, No.1.Chuangsheng Rd. Nanshan District, Shenzhen, P.R. China
Manufacturer	Shenzhen MADIGI Electronic Technology Co., Ltd
Address	Room 111, 1A Floor, Kanghesheng Bldg, No.1.Chuangsheng Rd. Nanshan District, Shenzhen, P.R. China
Factory	SHENZHEN 3NOD ELECTRONICS CO., LTD
Address	2F, No. 74, Yangchong Road, Tangxiachong Community, Yanluo Street , Bao'an District, Shenzhen, GUANGDONG P.R. CHINA
Product Designation	Mini PC
Brand Name	N/A
Test Model	MPC43
Date of receipt of test item	Apr. 12, 2023
Date of Test	Apr. 12, 2023 to Jun. 27, 2023
Deviation from Standard	No any deviation from the test method
Test Result	<b>Pass</b>
Test Report Form No.	AGCTR-ER-FCC-6GWLANV1.0

Prepared By



Jack Gui  
(Project Engineer)

Jun. 27, 2023

Reviewed By



Calvin Liu  
(Reviewer)

Jun. 27, 2023

Approved By



Max Zhang  
Authorized Officer

Jun. 27, 2023

Any report having not been signed by authorized approver, or having been altered without authorization, or having not been stamped by the "Dedicated Testing/Inspection Stamp" is deemed to be invalid. Copying or excerpting portion of, or altering the content of the report is not permitted without the written authorization of AGC. The test results presented in the report apply only to the tested sample. Any objections to report issued by AGC should be submitted to AGC within 15days after the issuance of the test report. Further enquiry of validity or verification of the test report should be addressed to AGC by agc01@agccert.com.

Attestation of Global Compliance(Shenzhen)Co., Ltd

Attestation of Global Compliance(Shenzhen)Std & Tech Co., Ltd

Tel: +86-755 2523 4088 E-mail: agc@agccert.com Web: http://www.agccert.com/

## 2. PRODUCT INFORMATION

### 2.1 PRODUCT TECHNICAL DESCRIPTION

<b>Equipment Function</b>	<input type="checkbox"/> Indoor Access Point	<input type="checkbox"/> Subordinate
	<input checked="" type="checkbox"/> Indoor Client	<input type="checkbox"/> Standard Power Access Point
	<input type="checkbox"/> Dual Client	<input type="checkbox"/> Standard Client
	<input type="checkbox"/> Fixed Client	
<b>Type of EUT</b>	Stand-alone	
<b>Operation Frequency</b>	<input checked="" type="checkbox"/> U-NII 5:5925MHz~6425MHz <input checked="" type="checkbox"/> U-NII 7:6525MHz~6875MHz	<input checked="" type="checkbox"/> U-NII 6: 6425MHz~6525MHz <input checked="" type="checkbox"/> U-NII 8: 6875MHz~7125MHz
<b>Hardware Version</b>	MPC43_MB_V20	
<b>Software Version</b>	Window 11	
<b>Test Frequency Range</b>	For 802.11ax (HE20): 5955~6415MHz,6435~6515MHz,6535~6855MHz,6875~7115MHz; For 802.11ax (HE40): 5965~6405MHz,6445~6485MHz,6525~6845MHz,6885~7085MHz; For 802.11ax (HE80): 5985~6385MHz,6465~6545MHz,6625~6785MHz,6865~7025MHz; For 802.11ax (HE160): 6025~6345MHz,6505~6505MHz,6665~6665MHz,6985~6985MHz	
<b>Max Average Power</b>	For 802.11ax (HE20): 4.97dBm; For 802.11ax (HE40): 8.02dBm; For 802.11ax (HE80): 10.445dBm; For 802.11ax (HE160): 13.21dBm	
<b>Max MIMO Power</b>	For 802.11ax (HE20): 4.94dBm; For 802.11ax (HE40): 8.03dBm; For 802.11ax (HE80): 10.45dBm; For 802.11ax (HE160): 13.26dBm	
<b>Support Bandwidth</b>	<input checked="" type="checkbox"/> BW20MHz <input checked="" type="checkbox"/> BW40MHz <input checked="" type="checkbox"/> BW80MHz <input checked="" type="checkbox"/> BW160MHz	
<b>Modulation</b>	802.11a: OFDM (BPSK, QPSK, 16QAM, 64QAM) 802.11ax: OFDMA (BPSK, QPSK, 16QAM, 64QAM,256QAM,1024QAM)	
<b>Number of channels</b>	233 channels	
<b>Antenna Designation</b>	Refer to section 2.8 of the report	
<b>Antenna Gain</b>	Refer to section 2.8 of the report	
<b>Power Supply</b>	DC 19V by adapter	

Any report having not been signed by authorized approver, or having been altered without authorization, or having not been stamped by the "Dedicated Testing/Inspection Stamp" is deemed to be invalid. Copying or excerpting portion of, or altering the content of the report is not permitted without the written authorization of AGC. The test results presented in the report apply only to the tested sample. Any objections to report issued by AGC should be submitted to AGC within 15days after the issuance of the test report. Further enquiry of validity or verification of the test report should be addressed to AGC by agc01@agccert.com.

## 2.2 TEST FREQUENCY LIST

For <U-NII-5, 6, 7, 8>

BW 20M	Channel	1	5	9	13	17	21	25	29
	Freq. (MHz)	5955	5975	5995	6015	6035	6055	6075	6095
BW 40M	Channel	3		11		19		27	
	Freq. (MHz)	5965		6005		6045		6085	
BW 80M	Channel	7				23			
	Freq. (MHz)	5985				6065			
BW 160M	Channel	15							
	Freq. (MHz)	6025							

BW 20M	Channel	33	37	41	45	49	53	57	61
	Freq. (MHz)	6115	6135	6155	6175	6195	6215	6235	6255
BW 40M	Channel	35		43		51		59	
	Freq. (MHz)	6125		6165		6205		6245	
BW 80M	Channel	39				55			
	Freq. (MHz)	6145				6225			
BW 160M	Channel	47							
	Freq. (MHz)	6185							

BW 20M	Channel	65	69	73	77	81	85	89	93
	Freq. (MHz)	6275	6295	6315	6335	6355	6375	6395	6415
BW 40M	Channel	67		75		83		91	
	Freq. (MHz)	6285		6325		6365		6405	
BW 80M	Channel	71				87			
	Freq. (MHz)	6305				6385			
BW 160M	Channel	79							
	Freq. (MHz)	6345							

BW 20M	Channel	97	101	105	109	113	117	121	125
	Freq. (MHz)	6435	6455	6475	6495	6515	6535	6555	6575
BW 40M	Channel	99		107		115		123	
	Freq. (MHz)	6445		6485		6525		6565	
BW 80M	Channel	103				119			
	Freq. (MHz)	6465				6545			
BW 160M	Channel	111							
	Freq. (MHz)	6505							

Any report having not been signed by authorized approver, or having been altered without authorization, or having not been stamped by the "Dedicated Testing/Inspection Stamp" is deemed to be invalid. Copying or excerpting portion of, or altering the content of the report is not permitted without the written authorization of AGC. The test results presented in the report apply only to the tested sample. Any objections to report issued by AGC should be submitted to AGC within 15days after the issuance of the test report. Further enquiry of validity or verification of the test report should be addressed to AGC by agc01@agccert.com.



BW 20M	Channel	129	133	137	141	145	149	153	157
	Freq. (MHz)	6595	6615	6635	6655	6675	6695	6715	6735
BW 40M	Channel	131		139		147		155	
	Freq. (MHz)	6605		6645		6685		6725	
BW 80M	Channel	135				151			
	Freq. (MHz)	6625				6705			
BW 160M	Channel	143							
	Freq. (MHz)	6665							

BW 20M	Channel	161	165	169	173	177	181	185	189
	Freq. (MHz)	6755	6775	6795	6815	6835	6855	6875	6895
BW 40M	Channel	163		171		179		187	
	Freq. (MHz)	6765		6805		6845		6885	
BW 80M	Channel	167				183			
	Freq. (MHz)	6785				6865			
BW 160M	Channel	175							
	Freq. (MHz)	6825							

BW 20M	Channel	193	197	201	205	209	213	217	221
	Freq. (MHz)	6915	6935	6955	6975	6995	7015	7035	7055
BW 40M	Channel	195		203		211		219	
	Freq. (MHz)	6925		6965		7005		7045	
BW 80M	Channel	199				215			
	Freq. (MHz)	6945				7025			
BW 160M	Channel	207							
	Freq. (MHz)	6985							

BW 20M	Channel	225			229			233		
	Freq. (MHz)	7075			7095			7115		
BW 40M	Channel	227								
	Freq. (MHz)	7085								

Any report having not been signed by authorized approver, or having been altered without authorization, or having not been stamped by the "Dedicated Testing/Inspection Stamp" is deemed to be invalid. Copying or excerpting portion of, or altering the content of the report is not permitted without the written authorization of AGC. The test results presented in the report apply only to the tested sample. Any objections to report issued by AGC should be submitted to AGC within 15days after the issuance of the test report. Further enquiry of validity or verification of the test report should be addressed to AGC by agc01@agccert.com.



### 2.3 RELATED SUBMITTAL(S) / GRANT (S)

This submittal(s) (test report) is intended for **FCC ID: 2BAWU-MPC43** filing to comply with the FCC Part 15 requirements.

### 2.4 TEST METHODOLOGY

The tests were performed according to following standards:

No.	Identity	Document Title
1	FCC 47 CFR Part 2	Frequency allocations and radio treaty matters; general rules and regulations
2	FCC 47 CFR Part 15	Radio Frequency Devices
3	ANSI C63.10-2013	American National Standard for Testing Unlicensed Wireless Devices
4	KDB 662911	662911 D01 Multiple Transmitter Output v02r01
5	KDB 789033	789033 D02 General U-NII Test Procedures New Rules v02r01
6	KDB 987594	987594 D02 U-NII 6GHz EMC Measurement v01r01

### 2.5 SPECIAL ACCESSORIES

Not available for this EUT intended for grant.

### 2.6 EQUIPMENT MODIFICATIONS

Not available for this EUT intended for grant.

### 2.7 ANTENNA REQUIREMENT

Standard Requirement
<p><b>15.203 requirement:</b> An intentional radiator shall be designed to ensure that no antenna other than that furnished by the responsible party shall be used with the device. The use of a permanently attached antenna or of an antenna that uses a unique coupling to the intentional radiator, the manufacturer may design the unit so that a broken antenna can be replaced by the user, but the use of a standard antenna jack or electrical connector is prohibited.</p>
<p><b>EUT Antenna:</b> The non-detachable antenna inside the device cannot be replaced by the user at will. The gain of the antenna refer to Section 2.8 of the report</p>

Any report having not been signed by authorized approver, or having been altered without authorization, or having not been stamped by the "Dedicated Testing/Inspection Stamp" is deemed to be invalid. Copying or excerpting portion of, or altering the content of the report is not permitted without the written authorization of AGC. The test results presented in the report apply only to the tested sample. Any objections to report issued by AGC should be submitted to AGC within 15 days after the issuance of the test report. Further enquiry of validity or verification of the test report should be addressed to AGC by [agc01@agccert.com](mailto:agc01@agccert.com).

Attestation of Global Compliance(Shenzhen)Co., Ltd  
Attestation of Global Compliance(Shenzhen)Std & Tech Co., Ltd  
Tel: +86-755 2523 4088 E-mail: [agc@agccert.com](mailto:agc@agccert.com) Web: <http://www.agccert.com/>

## 2.8 DESCRIPTION OF AVAILABLE ANTENNAS

Antenna Type	Frequency Band (MHz)	TX Paths	Bandwidth (MHz)	Max Peak Gain (dBi)		Max Directional Gain (dBi)
				Ant 1	Ant 2	
6G WIFI Internal Antenna List (6GHz 2*2 MIMO)						
PIFA Antenna	5925~6425	2	20,40,80,160	2.81	2.93	5.94
	6425~6525	2	20,40,80,160	2.81	2.93	5.94
	6525~6875	2	20,40,80,160	1.69	1.62	4.70
	6875~7125	2	20,40,80,160	1.69	1.62	4.70

Note 1: The EUT supports Cyclic Delay Diversity (CDD) technology for 802.11ax mode.

Note 2: The EUT supports Cyclic Delay Diversity (CDD) mode, and CDD signals are correlated.

If all antennas have the same gain,  $G_{ANT}$ , Directional gain =  $G_{ANT} + \text{Array Gain}$ , where Array Gain is as follows.

- For power spectral density (PSD) measurements on devices:

$$\text{Array Gain} = 10 \log (N_{ANT} / N_{SS}) \text{ dB} = 3.01;$$

- For power measurements on IEEE 802.11 devices:

$$\text{Array Gain} = 0 \text{ dB for } N_{ANT} \leq 4;$$

$$\text{Array Gain} = 0 \text{ dB (i.e., no array gain) for channel widths } \geq 40 \text{ MHz for any } N_{ANT};$$

$$\text{Array Gain} = 5 \log(N_{ANT}/N_{SS}) \text{ dB or } 3 \text{ dB, whichever is less, for } 20 \text{ MHz channel widths with } N_{ANT} \geq 5.$$

If antenna gains are not equal, Directional gain may be calculated by using the formulas applicable to equal gain antennas with  $G_{ANT}$  set equal to the gain of the antenna having the highest gain.

Any report having not been signed by authorized approver, or having been altered without authorization, or having not been stamped by the "Dedicated Testing/Inspection Stamp" is deemed to be invalid. Copying or excerpting portion of, or altering the content of the report is not permitted without the written authorization of AGC. The test results presented in the report apply only to the tested sample. Any objections to report issued by AGC should be submitted to AGC within 15 days after the issuance of the test report. Further enquiry of validity or verification of the test report should be addressed to AGC by [agc01@agccert.com](mailto:agc01@agccert.com).

Attestation of Global Compliance(Shenzhen)Co., Ltd  
Attestation of Global Compliance(Shenzhen)Std & Tech Co., Ltd  
Tel: +86-755 2523 4088 E-mail: [agc@agccert.com](mailto:agc@agccert.com) Web: <http://www.agccert.com/>

### 3. TEST ENVIRONMENT

#### 3.1 ADDRESS OF THE TEST LABORATORY

Laboratory: Attestation of Global Compliance (Shenzhen) Co., Ltd.

Address: 1-2/F, Building 19, Junfeng Industrial Park, Chongqing Road, Heping Community, Fuhai Street, Bao'an District, Shenzhen, Guangdong, China

#### 3.2 TEST FACILITY

The test facility is recognized, certified, or accredited by the following organizations:

##### **CNAS-Lab Code: L5488**

Attestation of Global Compliance (Shenzhen) Co., Ltd. has been assessed and proved to be in compliance with CNAS-CL01 Accreditation Criteria for Testing and Calibration Laboratories (identical to ISO/IEC17025: 2017 General Requirements) for the Competence of Testing and Calibration Laboratories.

##### **A2LA-Lab Cert. No.: 5054.02**

Attestation of Global Compliance (Shenzhen) Co., Ltd. EMC Laboratory has been accredited by A2LA for technical competence in the field of electrical testing, and proved to be in compliance with ISO/IEC 17025: 2017 General Requirements for the Competence of Testing and Calibration Laboratories and any additional program requirements in the identified field of testing.

##### **FCC-Registration No.: 975832**

Attestation of Global Compliance (Shenzhen) Co., Ltd. EMC Laboratory has been registered and fully described in a report filed with the FCC (Federal Communications Commission). The acceptance letter from the FCC is maintained in our files with Registration 975832.

##### **IC-Registration No.: 24842 (CAB identifier: CN0063)**

Attestation of Global Compliance (Shenzhen) Co., Ltd. EMC Laboratory has been registered and fully described in a report filed with the Certification and Engineering Bureau of Industry Canada. The acceptance letter from the IC is maintained in our files with Registration 24842.

Any report having not been signed by authorized approver, or having been altered without authorization, or having not been stamped by the "Dedicated Testing/Inspection Stamp" is deemed to be invalid. Copying or excerpting portion of, or altering the content of the report is not permitted without the written authorization of AGC. The test results presented in the report apply only to the tested sample. Any objections to report issued by AGC should be submitted to AGC within 15days after the issuance of the test report. Further enquiry of validity or verification of the test report should be addressed to AGC by [agc01@agccert.com](mailto:agc01@agccert.com).

Attestation of Global Compliance(Shenzhen)Co., Ltd  
Attestation of Global Compliance(Shenzhen)Std & Tech Co., Ltd  
Tel: +86-755 2523 4088 E-mail: [agc@agccert.com](mailto:agc@agccert.com) Web: <http://www.agccert.com/>

### 3.3 ENVIRONMENTAL CONDITIONS

	NORMAL CONDITIONS	EXTREME CONDITIONS
Temperature range (°C)	15 - 35	-20 - 50
Relative humidity range	20 % - 75 %	20 % - 75 %
Pressure range (kPa)	86 - 106	86 - 106
Power supply	--	--

Note: The Extreme Temperature and Extreme Voltages declared by the manufacturer.

### 3.4 MEASUREMENT UNCERTAINTY

The reported uncertainty of measurement  $y \pm U$ , where expanded uncertainty  $U$  is based on a standard uncertainty multiplied by a coverage factor of  $k=2$ , providing a level of confidence of approximately 95%.

Item	Measurement Uncertainty
Uncertainty of Conducted Emission for AC Port	$U_c = \pm 3.1$ dB
Uncertainty of Radiated Emission below 1GHz	$U_c = \pm 4.0$ dB
Uncertainty of Radiated Emission above 1GHz	$U_c = \pm 4.8$ dB
Uncertainty of total RF power, conducted	$U_c = \pm 0.8$ dB
Uncertainty of RF power density, conducted	$U_c = \pm 2.6$ dB
Uncertainty of spurious emissions, conducted	$U_c = \pm 2$ %
Uncertainty of Occupied Channel Bandwidth	$U_c = \pm 2$ %

Any report having not been signed by authorized approver, or having been altered without authorization, or having not been stamped by the "Dedicated Testing/Inspection Stamp" is deemed to be invalid. Copying or excerpting portion of, or altering the content of the report is not permitted without the written authorization of AGC. The test results presented in the report apply only to the tested sample. Any objections to report issued by AGC should be submitted to AGC within 15days after the issuance of the test report. Further enquiry of validity or verification of the test report should be addressed to AGC by [agc01@agccert.com](mailto:agc01@agccert.com).

### 3.5 LIST OF EQUIPMENTS USED

#### TEST EQUIPMENT OF CONDUCTED EMISSION TEST

Equipment	Manufacturer	Model	S/N	Cal. Date	Cal. Due
TEST RECEIVER	R&S	ESPI	101206	Aug. 04, 2022	Aug. 03, 2023
LISN	R&S	ESH2-Z5	100086	Jun. 08, 2022	Jun. 07, 2023
LISN	R&S	ESH2-Z5	100086	Jun. 03, 2023	Jun. 02, 2024
Test software	R&S	ES-K1	Ver.V1.71	N/A	N/A

#### TEST EQUIPMENT OF RADIATED EMISSION TEST

Equipment	Manufacturer	Model	S/N	Cal. Date	Cal. Due
TEST RECEIVER	R&S	ESCI	10096	Mar. 28, 2022	Mar. 27, 2023
EXA Signal Analyzer	Aglient	N9010A	MY53470504	Aug. 04, 2022	Aug. 03, 2023
Power sensor	Aglient	U2021XA	MY54110007	Mar. 04, 2022	Mar. 02, 2023
6GHz Fliter	Cedakeji	ZHPF6	04238754	N/A	N/A
Attenuator	ZHINAN	E-002	N/A	Sep. 01, 2022	Aug. 31, 2023
Horn antenna	SCHWARZBEC K	BBHA 9170	#768	Oct. 31, 2021	Oct. 30, 2023
Active loop antenna (9K-30MHz)	ZHINAN	ZN30900C	18051	Mar. 12, 2022	Mar. 11, 2024
Double-Ridged Waveguide Horn	ETS LINDGREN	3117	00034609	Apr. 23, 2023	Apr. 22, 2024
Broadband Preamplifier	ETS LINDGREN	3117PA	00225134	Sep. 01, 2022	Aug. 31, 2023
ANTENNA	SCHWARZBEC K	VULB9168	VULB9168-494	Jan. 05, 2023	Jan. 04, 2025
Test software	Tonscend	JS32-RE (Ver.2.5)	N/A	N/A	N/A

Any report having not been signed by authorized approver, or having been altered without authorization, or having not been stamped by the "Dedicated Testing/Inspection Stamp" is deemed to be invalid. Copying or excerpting portion of, or altering the content of the report is not permitted without the written authorization of AGC. The test results presented in the report apply only to the tested sample. Any objections to report issued by AGC should be submitted to AGC within 15days after the issuance of the test report. Further enquiry of validity or verification of the test report should be addressed to AGC by agc01@agccert.com.

## 4.SYSTEM TEST CONFIGURATION

### 4.1 EUT CONFIGURATION

The EUT configuration for testing is installed on RF field strength measurement to meet the Commission’s requirement and operating in a manner which intends to maximize its emission characteristics in a continuous normal application.

### 4.2 EUT EXERCISE

The Transmitter was operated in the normal operating mode. The TX frequency was fixed which was for the purpose of the measurements.

### 4.3 CONFIGURATION OF SYSTEM UNDER TEST

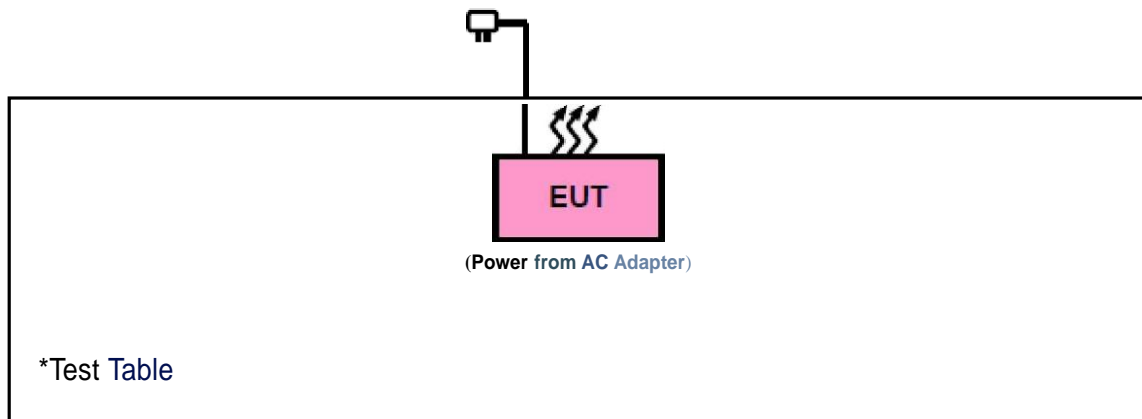

### 4.4 EQUIPMENT USED IN TESTED SYSTEM

The Following Peripheral Devices And Interface Cables Were Connected During The Measurement:

Test Accessories Come From The Laboratory

Item	Equipment	Model No.	Identifier	Note
1	Mouse	EMS-538A	1.7m,unshielded	Accessories
2	Keyboard	KB4021	1.8m,unshielded	Accessories
3	U Disc	DT100G3	N/A	Accessories
4	Monitor	U27N3	1.5m,unshielded	Accessories

Test Accessories Come From The Manufacturer

Item	Equipment	Model No.	Identifier	Note
1	NewCube Mini PC	N104	2BAWU-MPC43	EUT

Any report having not been signed by authorized approver, or having been altered without authorization, or having not been stamped by the “Dedicated Testing/Inspection Stamp” is deemed to be invalid. Copying or excerpting portion of, or altering the content of the report is not permitted without the written authorization of AGC. The test results presented in the report apply only to the tested sample. Any objections to report issued by AGC should be submitted to AGC within 15days after the issuance of the test report. Further enquiry of validity or verification of the test report should be addressed to AGC by agc01@agccert.com.

#### 4.5 SUMMARY OF TEST RESULTS

Item	FCC Rules	Description Of Test	Result
1	§15.203,15.407(a)	Antenna Equipment	Pass
2	§15.403(i), 15.407(a)(10)	26dB Emission Bandwidth	Pass
3	§2.1049	99% Occupied Bandwidth	Pass
4	§15.407(a)(8)	Power Limits. Maximum Output Power	Pass
5	§15.407(a)(8)	Power Spectral Density	Pass
6	§15.407(b)(6)	In-Band Emissions (Channel Mask)	Pass
7	§15.407(d)(6)	Contention Based Protocol	Pass
8	§15.209, 15.407(b)(5)	Unwanted Emissions	Pass
9	§15.207	AC Power Line Conducted Emission	Pass

**Note:**  
This product contains WIFI& Bluetooth module (Model: **AX211D2W**), FCC ID: **PD9AX211D2**. RF component data can be obtained by reference to report number: **201120-01.TR38**. The test report only reevaluates Power Limits. Maximum Output Power, Power Spectral Density, Radiated Spurious Emissions and Conducted Emission.

Any report having not been signed by authorized approver, or having been altered without authorization, or having not been stamped by the "Dedicated Testing/Inspection Stamp" is deemed to be invalid. Copying or excerpting portion of, or altering the content of the report is not permitted without the written authorization of AGC. The test results presented in the report apply only to the tested sample. Any objections to report issued by AGC should be submitted to AGC within 15days after the issuance of the test report. Further enquiry of validity or verification of the test report should be addressed to AGC by agc01@agccert.com.

Attestation of Global Compliance(Shenzhen)Co., Ltd  
Attestation of Global Compliance(Shenzhen)Std & Tech Co., Ltd  
Tel: +86-755 2523 4088 E-mail: agc@agccert.com Web: http://www.agccert.com/



## 5. DESCRIPTION OF TEST MODES

Summary table of Test Cases	
Test Item	Data Rate / Modulation
	6G WLAN – 802.11ax_OFDM/OFDMA
Radiated&Conducted Test Cases	Mode 1: 802.11ax20_TX CH1_5955 MHz_6 Mbps Mode 2: 802.11ax20_TX CH45_6175 MHz_6 Mbps Mode 3: 802.11ax20_TX CH93_6415 MHz_6 Mbps Mode 4: 802.11ax40_TX CH3_5965 MHz_6 Mbps Mode 5: 802.11ax40_TX CH43_6165 MHz_6 Mbps Mode 6: 802.11ax40_TX CH91_6405 MHz_6 Mbps Mode 7: 802.11ax80_TX CH7_5985 MHz_6 Mbps Mode 8: 802.11ax80_TX CH39_6145 MHz_6 Mbps Mode 9: 802.11ax80_TX CH87_6385 MHz_6 Mbps Mode 10: 802.11ax160_TX CH15_6025 MHz_6 Mbps Mode 11: 802.11ax160_TX CH79_6345 MHz_6 Mbps Mode 12: 802.11ax20_TX CH97_6435 MHz_6 Mbps Mode 13: 802.11ax20_TX CH105_6475 MHz_6 Mbps Mode 14: 802.11ax20_TX CH113_6515 MHz_6 Mbps Mode 15: 802.11ax40_TX CH99_6445 MHz_6 Mbps Mode 16: 802.11ax40_TX CH43_6485 MHz_6 Mbps Mode 17: 802.11ax80_TX CH103_6465 MHz_6 Mbps Mode 18: 802.11ax80_TX CH119_6545 MHz_6 Mbps Mode 19: 802.11ax160_TX CH111_6505 MHz_6 Mbps Mode 20: 802.11ax20_TX CH117_6535 MHz_6 Mbps Mode 21: 802.11ax20_TX CH149_6695 MHz_6 Mbps Mode 22: 802.11ax20_TX CH181_6855 MHz_6 Mbps Mode 23: 802.11ax40_TX CH115_6525 MHz_6 Mbps Mode 24: 802.11ax40_TX CH147_6685 MHz_6 Mbps Mode 25: 802.11ax40_TX CH179_6845 MHz_6 Mbps Mode 26: 802.11ax80_TX CH135_6625 MHz_6 Mbps Mode 27: 802.11ax80_TX CH167_6785 MHz_6 Mbps Mode 28: 802.11ax160_TX CH143_6665 MHz_6 Mbps Mode 29: 802.11ax20_TX CH185_6875 MHz_6 Mbps Mode 30: 802.11ax20_TX CH209_6995 MHz_6 Mbps Mode 31: 802.11ax20_TX CH229_7095 MHz_6 Mbps Mode 32: 802.11ax20_TX CH233_7115 MHz_6 Mbps Mode 33: 802.11ax40_TX CH187_6885 MHz_6 Mbps Mode 34: 802.11ax40_TX CH227_7085 MHz_6 Mbps Mode 35: 802.11ax80_TX CH183_6865 MHz_6 Mbps Mode 36: 802.11ax80_TX CH199_6945 MHz_6 Mbps Mode 37: 802.11ax80_TX CH215_7025 MHz_6 Mbps Mode 38: 802.11ax160_TX CH207_6985 MHz_6 Mbps
AC Conducted Emission	Mode 1: 6G WLAN Link + Battery + USB Cable (Charging from AC Adapter)

Any report having not been signed by authorized approver, or having been altered without authorization, or having not been stamped by the “Dedicated Testing/Inspection Stamp” is deemed to be invalid. Copying or excerpting portion of, or altering the content of the report is not permitted without the written authorization of AGC. The test results presented in the report apply only to the tested sample. Any objections to report issued by AGC should be submitted to AGC within 15days after the issuance of the test report. Further enquiry of validity or verification of the test report should be addressed to AGC by agc01@agccert.com.

Note:

1. The EUT has been set to operate continuously on the lowest, middle and highest operation frequency Individually, and the EUT is operating at its maximum duty cycle>or equal 98%
2. For Radiated Emission, 3axis were chosen for testing for each applicable mode.
3. For Conducted Test method, a temporary antenna connector is provided by the manufacture.
4. All radiated spurious emission and conducted interference modes have been pre scanned, and the report only records that antenna 1+antenna 2 work in the worst mode.

Any report having not been signed by authorized approver, or having been altered without authorization, or having not been stamped by the "Dedicated Testing/Inspection Stamp" is deemed to be invalid. Copying or excerpting portion of, or altering the content of the report is not permitted without the written authorization of AGC. The test results presented in the report apply only to the tested sample. Any objections to report issued by AGC should be submitted to AGC within 15days after the issuance of the test report. Further enquiry of validity or verification of the test report should be addressed to AGC by [agc01@agccert.com](mailto:agc01@agccert.com).

## 6. POWER LIMITS. MAXIMUM OUTPUT POWER MEASUREMENT

### 6.1 MEASUREMENT LIMITS

Power Limits. Maximum Output Power Limit	
<b>U-NII Devices</b>	
<input checked="" type="checkbox"/>	For the 5.925 - 6.425 GHz band:
	<ul style="list-style-type: none"> <li>■ For standard power access point and fixed client device : e.i.r.p &lt; 36 dBm , For outdoor devices, the maximum e.i.r.p. at any elevation angle above 30 degrees not exceed 125 mW (21 dBm).</li> <li>■ For indoor access point : e.i.r.p &lt; 30 dBm.</li> <li>■ For subordinate device control of an indoor access point : e.i.r.p &lt; 30 dBm.</li> <li>■ For client device control of a standard power access point : e.i.r.p &lt; 30 dBm.</li> <li>■ For client device control of an indoor access point : e.i.r.p &lt; 24 dBm.</li> </ul>
<input checked="" type="checkbox"/>	For the 6.425 - 6.525 GHz band:
	<ul style="list-style-type: none"> <li>■ For indoor access point : e.i.r.p &lt; 30 dBm.</li> <li>■ For client device control of an indoor access point : e.i.r.p &lt; 24 dBm.</li> </ul>
<input checked="" type="checkbox"/>	For the 6.525 - 6.875 GHz band:
	<ul style="list-style-type: none"> <li>■ For standard power access point and fixed client device : e.i.r.p &lt; 36 dBm , For outdoor devices, the maximum e.i.r.p. at any elevation angle above 30 degrees not exceed 125 mW (21 dBm).</li> <li>■ For indoor access point : e.i.r.p &lt; 30 dBm.</li> <li>■ For subordinate device control of an indoor access point : e.i.r.p &lt; 30 dBm.</li> <li>■ For client device control of a standard power access point : e.i.r.p &lt; 30 dBm.</li> <li>■ For client device control of an indoor access point : e.i.r.p &lt; 24 dBm.</li> </ul>
<input checked="" type="checkbox"/>	For the 6.875 - 7.125 GHz band:
	<ul style="list-style-type: none"> <li>■ For indoor access point : e.i.r.p &lt; 30 dBm.</li> <li>■ For client device control of an indoor access point : e.i.r.p &lt; 24 dBm.</li> </ul>

### 6.2 MEASUREMENT PROCEDURE

Test Method	
<input checked="" type="checkbox"/>	Maximum Output Power Setting
	<ul style="list-style-type: none"> <li>● Duty cycle a 98%</li> <li><input type="checkbox"/> Refer as KDB 789033, clause E Method SA-2 (spectral trace averaging).</li> <li>● Duty cycle &lt; 98%</li> <li><input type="checkbox"/> Refer as KDB 789033, clause E Method SA-2 Alt. (RMS detection with slow sweep speed)</li> <li>● Wideband RF power meter and average over on/off periods with duty factor</li> <li><input checked="" type="checkbox"/> Refer as KDB 789033, clause E Method PM-G (using an RF average power meter).</li> </ul>
<input checked="" type="checkbox"/>	For conducted measurement.
	<ul style="list-style-type: none"> <li>● If the EUT supports multiple transmit chains using options given below: Refer as FCC KDB 662911, In-band power measurements. Using the measure-and-sum approach, measured all transmit ports individually. Sum the power (in linear power units e.g., mW) of all ports for each individual sample and save them.</li> </ul>

Any report having not been signed by authorized approver, or having been altered without authorization, or having not been stamped by the "Dedicated Testing/Inspection Stamp" is deemed to be invalid. Copying or excerpting portion of, or altering the content of the report is not permitted without the written authorization of AGC. The test results presented in the report apply only to the tested sample. Any objections to report issued by AGC should be submitted to AGC within 15days after the issuance of the test report. Further enquiry of validity or verification of the test report should be addressed to AGC by agc01@agccert.com.

	<ul style="list-style-type: none"> <li>If multiple transmit chains, EIRP calculation could be following as methods:  <math>P_{total} = P_1 + P_2 + \dots + P_n</math>                      (calculated in linear unit [mW] and transfer to log unit [dBm])  <math>EIRP_{total} = P_{total} + DG</math> </li> </ul>
<input checked="" type="checkbox"/>	For radiated measurement.
	<ul style="list-style-type: none"> <li>Refer as ANSI C63.10, clause 6.6 for radiated emissions above 1GHz.</li> <li>Refer as KDB 412172, <math>EIRP = P_R + L_P</math>.                      where <math>P_R</math> = adjusted received power level; <math>L_P</math> = basic free space propagation path loss.  <math>P_R = P_{MEAS} - G_R + L_C + L_{ATTEN} - G_{AMP}</math>                      where <math>P_{MEAS}</math> = measured power level; <math>G_R</math> = gain of the receive (measurement) antenna; <math>L_C</math> = signal loss in the measurement cable; <math>L_{ATTEN}</math> = value of external attenuation (if used).</li> </ul>

### 6.3 MEASUREMENT SETUP (BLOCK DIAGRAM OF CONFIGURATION)

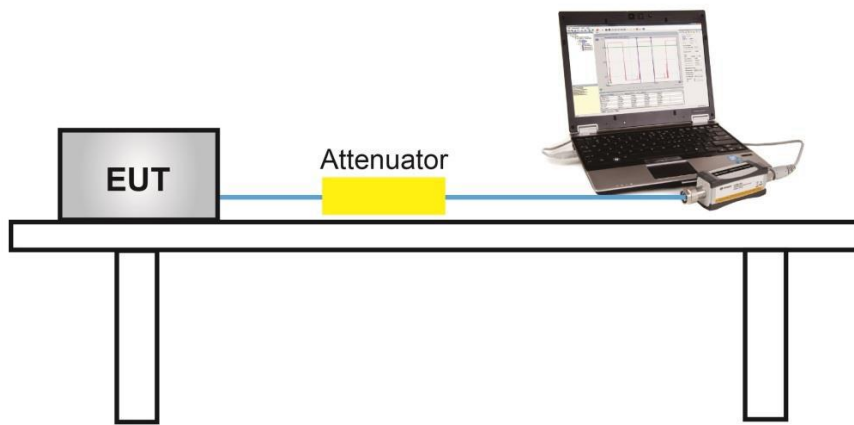

Any report having not been signed by authorized approver, or having been altered without authorization, or having not been stamped by the “Dedicated Testing/Inspection Stamp” is deemed to be invalid. Copying or excerpting portion of, or altering the content of the report is not permitted without the written authorization of AGC. The test results presented in the report apply only to the tested sample. Any objections to report issued by AGC should be submitted to AGC within 15days after the issuance of the test report. Further enquiry of validity or verification of the test report should be addressed to AGC by [agc01@agccert.com](mailto:agc01@agccert.com).

#### 6.4 MEASUREMENT RESULT

Test Data of RF Output Power for U-NII 5 band-ANT 1						
Test Mode	Test Channel (MHz)	Average Power (dBm)	Ant Gain (dBi)	EIRP (dBm)	Limits (dBm)	Pass or Fail
802.11ax20	5955	4.75	2.81	7.56	24	Pass
	6175	4.89	2.81	7.70	24	Pass
	6415	4.54	2.81	7.35	24	Pass
802.11ax40	5965	7.75	2.81	10.56	24	Pass
	6165	7.90	2.81	10.71	24	Pass
	6405	7.31	2.81	10.12	24	Pass
802.11ax80	5985	9.82	2.81	12.63	24	Pass
	6145	9.91	2.81	12.72	24	Pass
	6385	9.80	2.81	12.61	24	Pass
802.11ax160	6025	12.99	2.81	15.80	24	Pass
	6345	12.94	2.81	15.75	24	Pass

Test Data of RF Output Power for U-NII 5 band-ANT 2						
Test Mode	Test Channel (MHz)	Average Power (dBm)	Ant Gain (dBi)	EIRP (dBm)	Limits (dBm)	Pass or Fail
802.11ax20	5955	4.50	2.93	7.43	24	Pass
	6175	4.67	2.93	7.60	24	Pass
	6415	4.73	2.93	7.66	24	Pass
802.11ax40	5965	7.75	2.93	10.68	24	Pass
	6165	7.61	2.93	10.54	24	Pass
	6405	7.46	2.93	10.39	24	Pass
802.11ax80	5985	9.64	2.93	12.57	24	Pass
	6145	9.98	2.93	12.91	24	Pass
	6385	10.03	2.93	12.96	24	Pass
802.11ax160	6025	12.73	2.93	15.66	24	Pass
	6345	13.09	2.93	16.02	24	Pass

Any report having not been signed by authorized approver, or having been altered without authorization, or having not been stamped by the "Dedicated Testing/Inspection Stamp" is deemed to be invalid. Copying or excerpting portion of, or altering the content of the report is not permitted without the written authorization of AGC. The test results presented in the report apply only to the tested sample. Any objections to report issued by AGC should be submitted to AGC within 15days after the issuance of the test report. Further enquiry of validity or verification of the test report should be addressed to AGC by agc01@agccert.com.

**Test Data of RF Output Power for U-NII 5 band-MIMO**

Test Mode	Test Channel (MHz)	Average Power (dBm)	Ant Gain (dBi)	EIRP (dBm)	Limits (dBm)	Pass or Fail
802.11ax20	5955	4.72	2.93	7.65	24	Pass
	6175	4.65	2.93	7.58	24	Pass
	6415	4.81	2.93	7.74	24	Pass
802.11ax40	5965	7.57	2.93	10.50	24	Pass
	6165	7.49	2.93	10.42	24	Pass
	6405	7.49	2.93	10.42	24	Pass
802.11ax80	5985	10.15	2.93	13.08	24	Pass
	6145	10.03	2.93	12.96	24	Pass
	6385	10.18	2.93	13.11	24	Pass
802.11ax160	6025	12.90	2.93	15.83	24	Pass
	6345	13.12	2.93	16.05	24	Pass

**Test Data of RF Output Power for U-NII 6 band-ANT 1**

Test Mode	Test Channel (MHz)	Average Power (dBm)	Ant Gain (dBi)	EIRP (dBm)	Limits (dBm)	Pass or Fail
802.11ax20	6435	4.67	2.81	7.48	24	Pass
	6475	4.64	2.81	7.45	24	Pass
	6515	4.62	2.81	7.43	24	Pass
802.11ax40	6445	7.90	2.81	10.71	24	Pass
	6485	7.78	2.81	10.59	24	Pass
802.11ax80	6465	10.30	2.81	13.11	24	Pass
	6545	10.28	2.81	13.09	24	Pass
802.11ax160	6505	13.18	2.81	15.99	24	Pass

Any report having not been signed by authorized approver, or having been altered without authorization, or having not been stamped by the "Dedicated Testing/Inspection Stamp" is deemed to be invalid. Copying or excerpting portion of, or altering the content of the report is not permitted without the written authorization of AGC. The test results presented in the report apply only to the tested sample. Any objections to report issued by AGC should be submitted to AGC within 15days after the issuance of the test report. Further enquiry of validity or verification of the test report should be addressed to AGC by agc01@agccert.com.

**Test Data of RF Output Power for U-NII 6 band-ANT 2**

Test Mode	Test Channel (MHz)	Average Power (dBm)	Ant Gain (dBi)	EIRP (dBm)	Limits (dBm)	Pass or Fail
802.11ax20	6435	4.84	2.93	7.77	24	Pass
	6475	4.88	2.93	7.81	24	Pass
	6515	4.92	2.93	7.85	24	Pass
802.11ax40	6445	7.82	2.93	10.75	24	Pass
	6485	7.79	2.93	10.72	24	Pass
802.11ax80	6465	10.32	2.93	13.25	24	Pass
	6545	10.44	2.93	13.37	24	Pass
802.11ax160	6505	13.21	2.93	16.14	24	Pass

**Test Data of RF Output Power for U-NII 6 band-MIMO**

Test Mode	Test Channel (MHz)	Average Power (dBm)	Ant Gain (dBi)	EIRP (dBm)	Limits (dBm)	Pass or Fail
802.11ax20	6435	4.81	2.93	7.74	24	Pass
	6475	4.72	2.93	7.65	24	Pass
	6515	4.81	2.93	7.74	24	Pass
802.11ax40	6445	7.87	2.93	10.8	24	Pass
	6485	7.99	2.93	10.92	24	Pass
802.11ax80	6465	10.45	2.93	13.38	24	Pass
	6545	10.40	2.93	13.33	24	Pass
802.11ax160	6505	13.26	2.93	16.19	24	Pass

Any report having not been signed by authorized approver, or having been altered without authorization, or having not been stamped by the "Dedicated Testing/Inspection Stamp" is deemed to be invalid. Copying or excerpting portion of, or altering the content of the report is not permitted without the written authorization of AGC. The test results presented in the report apply only to the tested sample. Any objections to report issued by AGC should be submitted to AGC within 15days after the issuance of the test report. Further enquiry of validity or verification of the test report should be addressed to AGC by agc01@agccert.com.



**Test Data of RF Output Power for U-NII 7 band-ANT 1**

Test Mode	Test Channel (MHz)	Average Power (dBm)	Ant Gain (dBi)	EIRP (dBm)	Limits (dBm)	Pass or Fail
802.11ax20	6534	4.72	1.69	6.41	24	Pass
	6695	4.53	1.69	6.22	24	Pass
	6855	4.71	1.69	6.40	24	Pass
802.11ax40	6525	7.84	1.69	9.53	24	Pass
	6685	7.86	1.69	9.55	24	Pass
	6845	7.76	1.69	9.45	24	Pass
802.11ax80	6625	10.22	1.69	11.91	24	Pass
	6785	10.17	1.69	11.86	24	Pass
802.11ax160	6665	12.57	1.69	14.26	24	Pass

**Test Data of RF Output Power for U-NII 7 band-ANT 2**

Test Mode	Test Channel (MHz)	Average Power (dBm)	Ant Gain (dBi)	EIRP (dBm)	Limits (dBm)	Pass or Fail
802.11ax20	6534	4.53	1.62	6.15	24	Pass
	6695	4.78	1.62	6.40	24	Pass
	6855	4.70	1.62	6.32	24	Pass
802.11ax40	6525	7.77	1.62	9.39	24	Pass
	6685	7.99	1.62	9.61	24	Pass
	6845	7.75	1.62	9.37	24	Pass
802.11ax80	6625	10.09	1.62	11.71	24	Pass
	6785	10.19	1.62	11.81	24	Pass
802.11ax160	6665	12.72	1.62	14.34	24	Pass

Any report having not been signed by authorized approver, or having been altered without authorization, or having not been stamped by the "Dedicated Testing/Inspection Stamp" is deemed to be invalid. Copying or excerpting portion of, or altering the content of the report is not permitted without the written authorization of AGC. The test results presented in the report apply only to the tested sample. Any objections to report issued by AGC should be submitted to AGC within 15days after the issuance of the test report. Further enquiry of validity or verification of the test report should be addressed to AGC by agc01@agccert.com.

**Test Data of RF Output Power for U-NII 7 band-MIMO**

Test Mode	Test Channel (MHz)	Average Power (dBm)	Ant Gain (dBi)	EIRP (dBm)	Limits (dBm)	Pass or Fail
802.11ax20	6534	4.52	1.69	6.21	24	Pass
	6695	4.87	1.69	6.56	24	Pass
	6855	4.64	1.69	6.33	24	Pass
802.11ax40	6525	8.03	1.69	9.72	24	Pass
	6685	7.81	1.69	9.50	24	Pass
	6845	7.63	1.69	9.32	24	Pass
802.11ax80	6625	10.25	1.69	11.94	24	Pass
	6785	10.30	1.69	11.99	24	Pass
802.11ax160	6665	13.19	1.69	14.88	24	Pass

**Test Data of RF Output Power for U-NII 8 band-ANT 1**

Test Mode	Test Channel (MHz)	Average Power (dBm)	Ant Gain (dBi)	EIRP (dBm)	Limits (dBm)	Pass or Fail
802.11ax20	6875	4.57	1.69	6.26	24	Pass
	6995	4.86	1.69	6.55	24	Pass
	7095	4.73	1.69	6.42	24	Pass
	7115	0.78	1.69	2.47	24	Pass
802.11ax40	6885	7.80	1.69	9.49	24	Pass
	7085	8.02	1.69	9.71	24	Pass
802.11ax80	6865	9.95	1.69	11.64	24	Pass
	6945	10.32	1.69	12.01	24	Pass
	7025	10.30	1.69	11.99	24	Pass
802.11ax160	6985	13.06	1.69	14.75	24	Pass

Any report having not been signed by authorized approver, or having been altered without authorization, or having not been stamped by the "Dedicated Testing/Inspection Stamp" is deemed to be invalid. Copying or excerpting portion of, or altering the content of the report is not permitted without the written authorization of AGC. The test results presented in the report apply only to the tested sample. Any objections to report issued by AGC should be submitted to AGC within 15days after the issuance of the test report. Further enquiry of validity or verification of the test report should be addressed to AGC by agc01@agccert.com.

**Test Data of RF Output Power for U-NII 8 band-ANT 2**

Test Mode	Test Channel (MHz)	Average Power (dBm)	Ant Gain (dBi)	EIRP (dBm)	Limits (dBm)	Pass or Fail
802.11ax20	6875	4.71	1.62	6.33	24	Pass
	6995	4.78	1.62	6.40	24	Pass
	7095	4.97	1.62	6.59	24	Pass
	7115	0.48	1.62	2.10	24	Pass
802.11ax40	6885	7.89	1.62	9.51	24	Pass
	7085	7.95	1.62	9.57	24	Pass
802.11ax80	6865	10.00	1.62	11.62	24	Pass
	6945	10.08	1.62	11.70	24	Pass
	7025	10.33	1.62	11.95	24	Pass
802.11ax160	6985	13.07	1.62	14.69	24	Pass

**Test Data of RF Output Power for U-NII 8 band-MIMO**

Test Mode	Test Channel (MHz)	Average Power (dBm)	Ant Gain (dBi)	EIRP (dBm)	Limits (dBm)	Pass or Fail
802.11ax20	6875	4.56	1.69	6.25	24	Pass
	6995	4.93	1.69	6.62	24	Pass
	7095	4.94	1.69	6.63	24	Pass
	7115	1.17	1.69	2.86	24	Pass
802.11ax40	6885	7.72	1.69	9.41	24	Pass
	7085	7.92	1.69	9.61	24	Pass
802.11ax80	6865	10.17	1.69	11.86	24	Pass
	6945	10.35	1.69	12.04	24	Pass
	7025	10.43	1.69	12.12	24	Pass
802.11ax160	6985	13.08	1.69	14.77	24	Pass

Any report having not been signed by authorized approver, or having been altered without authorization, or having not been stamped by the "Dedicated Testing/Inspection Stamp" is deemed to be invalid. Copying or excerpting portion of, or altering the content of the report is not permitted without the written authorization of AGC. The test results presented in the report apply only to the tested sample. Any objections to report issued by AGC should be submitted to AGC within 15days after the issuance of the test report. Further enquiry of validity or verification of the test report should be addressed to AGC by agc01@agccert.com.

## 7. 26dB& 99% BANDWIDTH MEASUREMENT

### 7.1 MEASUREMENT LIMITS

The maximum transmitter channel bandwidth for U-NII devices in the 5.925-7.125 GHz band is 320 megahertz.

### 7.2 MEASUREMENT PROCEDURE

The testing follows FCC KDB 789033 D02 General UNII Test Procedures New Rules v02r01. Section C) Emission bandwidth

1. Set RBW = approximately 1% of the emission bandwidth.
2. Set the VBW > RBW.
3. Detector = Peak.
4. Trace mode = max hold
5. Measure the maximum width of the emission that is 26 dB down from the peak of the emission. Compare this with the RBW setting of the analyzer. Readjust RBW and repeat measurement as needed until the RBW/EBW ratio is approximately 1%.
6. For 99% Bandwidth Measurement, the spectrum analyzer's resolution bandwidth (RBW) is set 1-5% of the emission bandwidth and set the Video bandwidth (VBW)  $\geq 3 * RBW$ .
7. Measure and record the results in the test report.

### 7.3 MEASUREMENT SETUP (BLOCK DIAGRAM OF CONFIGURATION)

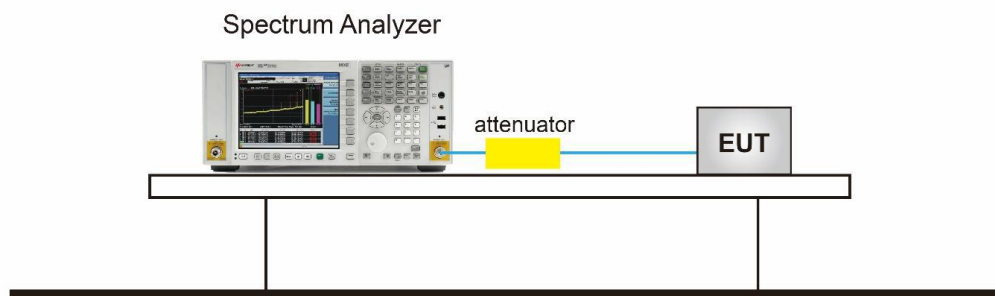

Any report having not been signed by authorized approver, or having been altered without authorization, or having not been stamped by the "Dedicated Testing/Inspection Stamp" is deemed to be invalid. Copying or excerpting portion of, or altering the content of the report is not permitted without the written authorization of AGC. The test results presented in the report apply only to the tested sample. Any objections to report issued by AGC should be submitted to AGC within 15days after the issuance of the test report. Further enquiry of validity or verification of the test report should be addressed to AGC by [agc01@agccert.com](mailto:agc01@agccert.com).

Attestation of Global Compliance(Shenzhen)Co., Ltd  
Attestation of Global Compliance(Shenzhen)Std & Tech Co., Ltd  
Tel: +86-755 2523 4088 E-mail: [agc@agccert.com](mailto:agc@agccert.com) Web: <http://www.agccert.com/>

## 7.4 MEASUREMENT RESULTS

Note: Please refer to the module RF report No.: **(201120-01.TR38)**.

Any report having not been signed by authorized approver, or having been altered without authorization, or having not been stamped by the "Dedicated Testing/Inspection Stamp" is deemed to be invalid. Copying or excerpting portion of, or altering the content of the report is not permitted without the written authorization of AGC. The test results presented in the report apply only to the tested sample. Any objections to report issued by AGC should be submitted to AGC within 15days after the issuance of the test report. Further enquiry of validity or verification of the test report should be addressed to AGC by [agc01@agccert.com](mailto:agc01@agccert.com).

Attestation of Global Compliance(Shenzhen)Co., Ltd  
Attestation of Global Compliance(Shenzhen)Std & Tech Co., Ltd  
Tel: +86-755 2523 4088 E-mail: [agc@agccert.com](mailto:agc@agccert.com) Web: <http://www.agccert.com/>

## 8. POWER SPECTRAL DENSITY MEASUREMENT

### 8.1 MEASUREMENT LIMITS

Power Spectral Density Limit	
U-NII Devices	
<input checked="" type="checkbox"/> For the 5.925 - 6.425 GHz band:	
	<ul style="list-style-type: none"> <li>■ For standard power access point and fixed client device : e.i.r.p PSD &lt; 23 dBm/MHz.</li> <li>■ For indoor access point : e.i.r.p PSD &lt; 5 dBm/MHz.</li> <li>■ For subordinate device control of an indoor access point : e.i.r.p PSD &lt; 5 dBm/MHz.</li> <li>■ For client device control of a standard power access point : e.i.r.p PSD &lt; 17 dBm/MHz.</li> <li>■ For client device control of an indoor access point : e.i.r.p PSD &lt; -1 dBm/MHz.</li> </ul>
<input checked="" type="checkbox"/> For the 6.425 - 6.525 GHz band:	
	<ul style="list-style-type: none"> <li>■ For indoor access point : e.i.r.p PSD &lt; 5 dBm/MHz.</li> <li>■ For client device control of an indoor access point : e.i.r.p PSD &lt; -1 dBm/MHz.</li> </ul>
<input checked="" type="checkbox"/> For the 6.525 - 6.875 GHz band:	
	<ul style="list-style-type: none"> <li>■ For standard power access point and fixed client device : e.i.r.p PSD &lt; 23 dBm/MHz.</li> <li>■ For indoor access point : e.i.r.p PSD &lt; 5 dBm/MHz.</li> <li>■ For subordinate device control of an indoor access point : e.i.r.p PSD &lt; 5 dBm/MHz.</li> <li>■ For client device control of a standard power access point : e.i.r.p PSD &lt; 17 dBm/MHz.</li> <li>■ For client device control of an indoor access point : e.i.r.p PSD &lt; -1 dBm/MHz.</li> </ul>
<input checked="" type="checkbox"/> For the 6.875 - 7.125 GHz band:	
	<ul style="list-style-type: none"> <li>■ For indoor access point : e.i.r.p PSD &lt; 5 dBm/MHz.</li> <li>■ For client device control of an indoor access point : e.i.r.p PSD &lt; -1 dBm/MHz.</li> </ul>

### 8.2 MEASUREMENT PROCEDURE

Test Method	
<ul style="list-style-type: none"> <li>■ Peak power spectral density procedures that the same method as used to determine the conducted output power shall be used to determine the peak power spectral density and use the peak search function on the spectrum analyzer to find the peak of the spectrum. For the peak power spectral density shall be measured using below options:</li> </ul>	
	<input type="checkbox"/> Refer as KDB 789033, F)5) power spectral density can be measured using resolution bandwidths < 1 MHz provided that the results are integrated over 1 MHz bandwidth
	<input checked="" type="checkbox"/> Refer as KDB 789033, clause E Method SA-2. (spectral trace averaging)
	<input type="checkbox"/> Refer as KDB 789033, clause E Method SA-2 Alt. (RMS detection with slow sweep speed)
<input checked="" type="checkbox"/> For conducted measurement.	
	<ul style="list-style-type: none"> <li>■ If the EUT supports multiple transmit chains using options given below:</li> </ul>

Any report having not been signed by authorized approver, or having been altered without authorization, or having not been stamped by the "Dedicated Testing/Inspection Stamp" is deemed to be invalid. Copying or excerpting portion of, or altering the content of the report is not permitted without the written authorization of AGC. The test results presented in the report apply only to the tested sample. Any objections to report issued by AGC should be submitted to AGC within 15days after the issuance of the test report. Further enquiry of validity or verification of the test report should be addressed to AGC by agc01@agccert.com.

	<p><input checked="" type="checkbox"/> Option 1: Measure and sum the spectra across the outputs. Refer as FCC KDB 662911, In-band power spectral density (PSD). Sample all transmit ports simultaneously using a spectrum analyzer for each transmit port. Where the trace bin-by-bin of each transmit port summing can be performed. (i.e., in the first spectral bin of output 1 is summed with that in the first spectral bin of output 2 and that from the first spectral bin of output 3, and so on up to the NTX output to obtain the value for the first frequency bin of the summed spectrum.). Add up the amplitude (power) values for the different transmit chains and use this as the new data trace.</p> <p><input checked="" type="checkbox"/> Option 2: Measure and sum spectral maxima across the outputs. With this technique, spectra are measured at each output of the device at the required resolution bandwidth. The maximum value (peak) of each spectrum is determined. These maximum values are then summed mathematically in linear power units across the outputs. These operations shall be performed separately over frequency spans that have different out-of-band or spurious emission limits,</p> <p><input checked="" type="checkbox"/> Option 3: Measure and add 10 log(N) dB, where N is the number of transmit chains. Refer as FCC KDB 662911, In-band power spectral density (PSD). Performed at each transmit chains and each transmit chains shall be compared with the limit have been reduced with 10 log(N). Or each transmit chains shall be add 10 log(N) to compared with the limit.</p> <p>■ If multiple transmit chains, EIRP PPSD calculation could be following as methods:  <math>PPSD_{total} = PPSD_1 + PPSD_2 + \dots + PPSD_n</math>          (calculated in linear unit [mW] and transfer to log unit [dBm])  <math>EIRP_{total} = PPSD_{total} + DG</math></p>
<input type="checkbox"/> For radiated measurement.	
	Refer as ANSI C63.10, clause 6.6 for radiated emissions above 1GHz.
	Refer as KDB 412172, EIRP - PR + Lp. where PR = adjusted received power level; Lp = basic free space propagation path loss. $PR = PMEAS - GR + Lc + LATTEN - GAMP$ where PMEAs = measured power level; GR = gain of the receive (measurement) antenna; Lc = signal loss in the measurement cable; LATTEN = value of external attenuation (if used).

### 8.3 MEASUREMENT SETUP (BLOCK DIAGRAM OF CONFIGURATION)

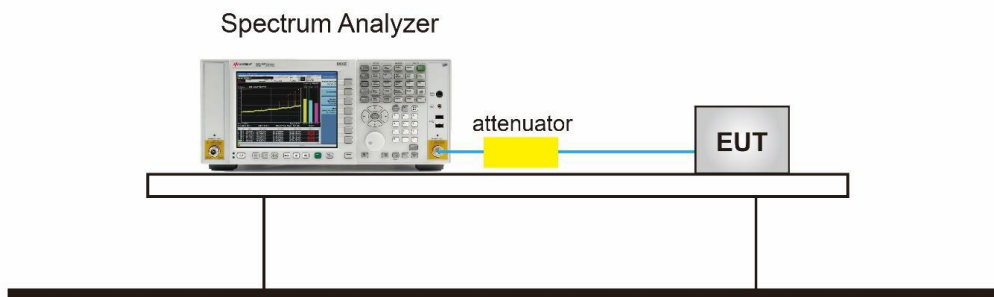

Any report having not been signed by authorized approver, or having been altered without authorization, or having not been stamped by the "Dedicated Testing/Inspection Stamp" is deemed to be invalid. Copying or excerpting portion of, or altering the content of the report is not permitted without the written authorization of AGC. The test results presented in the report apply only to the tested sample. Any objections to report issued by AGC should be submitted to AGC within 15days after the issuance of the test report. Further enquiry of validity or verification of the test report should be addressed to AGC by agc01@agccert.com.



### 8.4 MEASUREMENT RESULTS

Note: Please refer to the Bluetooth module RF report No.: (201120-01.TR38).

Test Data of Conducted Output Power Density for U-NII 5 band -ANT 1						
Test Mode	Test Channel (MHz)	Power Density (dBm/MHz)	Ant Gain (dBi)	EIRP Power Density (dBm/MHz)	Limits (dBm/MHz)	Pass or Fail
802.11ax20	5955	-6.95	2.81	-4.14	<-1	Pass
	6175	-6.91	2.81	-4.10	<-1	Pass
	6415	-7.31	2.81	-4.50	<-1	Pass
802.11ax40	5965	-7.04	2.81	-4.23	<-1	Pass
	6165	-6.98	2.81	-4.17	<-1	Pass
	6405	-7.46	2.81	-4.65	<-1	Pass
802.11ax80	5985	-7.26	2.81	-4.45	<-1	Pass
	6145	-7.16	2.81	-4.35	<-1	Pass
	6385	-7.38	2.81	-4.57	<-1	Pass
802.11ax160	6025	-7.09	2.81	-4.28	<-1	Pass
	6345	-6.98	2.81	-4.17	<-1	Pass

Test Data of Conducted Output Power Density for U-NII 5 band -ANT 2						
Test Mode	Test Channel (MHz)	Power Density (dBm/MHz)	Ant Gain (dBi)	EIRP Power Density (dBm/MHz)	Limits (dBm/MHz)	Pass or Fail
802.11ax20	5955	-7.16	2.93	-4.23	<-1	Pass
	6175	-7.11	2.93	-4.18	<-1	Pass
	6415	-7.07	2.93	-4.14	<-1	Pass
802.11ax40	5965	-6.92	2.93	-3.99	<-1	Pass
	6165	-7.27	2.93	-4.34	<-1	Pass
	6405	-7.36	2.93	-4.43	<-1	Pass
802.11ax80	5985	-7.44	2.93	-4.51	<-1	Pass
	6145	-7.00	2.93	-4.07	<-1	Pass
	6385	-7.19	2.93	-4.26	<-1	Pass
802.11ax160	6025	-7.01	2.93	-4.08	<-1	Pass
	6345	-6.82	2.93	-3.89	<-1	Pass

Any report having not been signed by authorized approver, or having been altered without authorization, or having not been stamped by the "Dedicated Testing/Inspection Stamp" is deemed to be invalid. Copying or excerpting portion of, or altering the content of the report is not permitted without the written authorization of AGC. The test results presented in the report apply only to the tested sample. Any objections to report issued by AGC should be submitted to AGC within 15days after the issuance of the test report. Further enquiry of validity or verification of the test report should be addressed to AGC by agc01@agccert.com.

**Test Data of Conducted Output Power Density for U-NII 5 band -MIMO**

Test Mode	Test Channel (MHz)	Power Density (dBm/MHz)	Ant Gain (dBi)	EIRP Power Density (dBm/MHz)	Limits (dBm/MHz)	Pass or Fail
802.11ax20	5955	-7.10	2.93	-4.17	<-1	Pass
	6175	-7.11	2.93	-4.18	<-1	Pass
	6415	-7.02	2.93	-4.09	<-1	Pass
802.11ax40	5965	-7.31	2.93	-4.38	<-1	Pass
	6165	-7.38	2.93	-4.45	<-1	Pass
	6405	-7.32	2.93	-4.39	<-1	Pass
802.11ax80	5985	-6.94	2.93	-4.01	<-1	Pass
	6145	-7.13	2.93	-4.20	<-1	Pass
	6385	-6.89	2.93	-3.96	<-1	Pass
802.11ax160	6025	-7.05	2.93	-4.12	<-1	Pass
	6345	-6.83	2.93	-3.90	<-1	Pass

**Test Data of Conducted Output Power Density for U-NII 6 band -ANT 1**

Test Mode	Test Channel (MHz)	Power Density (dBm/MHz)	Ant Gain (dBi)	EIRP Power Density (dBm/MHz)	Limits (dBm/MHz)	Pass or Fail
802.11ax20	6435	-7.10	2.81	-4.29	<-1	Pass
	6475	-7.24	2.81	-4.43	<-1	Pass
	6515	-7.28	2.81	-4.47	<-1	Pass
802.11ax40	6445	-6.92	2.81	-4.11	<-1	Pass
	6485	-7.02	2.81	-4.21	<-1	Pass
802.11ax80	6465	-6.74	2.81	-3.93	<-1	Pass
	6545	-6.86	2.81	-4.05	<-1	Pass
802.11ax160	6505	-6.86	2.81	-4.05	<-1	Pass

Any report having not been signed by authorized approver, or having been altered without authorization, or having not been stamped by the "Dedicated Testing/Inspection Stamp" is deemed to be invalid. Copying or excerpting portion of, or altering the content of the report is not permitted without the written authorization of AGC. The test results presented in the report apply only to the tested sample. Any objections to report issued by AGC should be submitted to AGC within 15days after the issuance of the test report. Further enquiry of validity or verification of the test report should be addressed to AGC by agc01@agccert.com.

**Test Data of Conducted Output Power Density for U-NII 6 band -ANT 2**

Test Mode	Test Channel (MHz)	Power Density (dBm/MHz)	Ant Gain (dBi)	EIRP Power Density (dBm/MHz)	Limits (dBm/MHz)	Pass or Fail
802.11ax20	6435	-6.96	2.93	-4.03	<-1	Pass
	6475	-6.89	2.93	-3.96	<-1	Pass
	6515	-6.93	2.93	-4.00	<-1	Pass
802.11ax40	6445	-7.01	2.93	-4.08	<-1	Pass
	6485	-6.97	2.93	-4.04	<-1	Pass
802.11ax80	6465	-6.92	2.93	-3.99	<-1	Pass
	6545	-6.81	2.93	-3.88	<-1	Pass
802.11ax160	6505	-6.80	2.93	-3.87	<-1	Pass

**Test Data of Conducted Output Power Density for U-NII 6 band -MIMO**

Test Mode	Test Channel (MHz)	Power Density (dBm/MHz)	Ant Gain (dBi)	EIRP Power Density (dBm/MHz)	Limits (dBm/MHz)	Pass or Fail
802.11ax20	6435	-7.05	2.93	-4.12	<-1	Pass
	6475	-7.08	2.93	-4.15	<-1	Pass
	6515	-6.90	2.93	-3.97	<-1	Pass
802.11ax40	6445	-6.95	2.93	-4.02	<-1	Pass
	6485	-6.83	2.93	-3.90	<-1	Pass
802.11ax80	6465	-6.83	2.93	-3.90	<-1	Pass
	6545	-6.81	2.93	-3.88	<-1	Pass
802.11ax160	6505	-6.89	2.93	-3.96	<-1	Pass

Any report having not been signed by authorized approver, or having been altered without authorization, or having not been stamped by the "Dedicated Testing/Inspection Stamp" is deemed to be invalid. Copying or excerpting portion of, or altering the content of the report is not permitted without the written authorization of AGC. The test results presented in the report apply only to the tested sample. Any objections to report issued by AGC should be submitted to AGC within 15days after the issuance of the test report. Further enquiry of validity or verification of the test report should be addressed to AGC by agc01@agccert.com.

**Test Data of Conducted Output Power Density for U-NII 7 band -ANT 1**

Test Mode	Test Channel (MHz)	Power Density (dBm/MHz)	Ant Gain (dBi)	EIRP Power Density (dBm/MHz)	Limits (dBm/MHz)	Pass or Fail
802.11ax20	6534	-7.13	1.69	-5.44	<-1	Pass
	6695	-7.40	1.69	-5.71	<-1	Pass
	6855	-7.10	1.69	-5.41	<-1	Pass
802.11ax40	6525	-6.97	1.69	-5.28	<-1	Pass
	6685	-6.91	1.69	-5.22	<-1	Pass
	6845	-6.98	1.69	-5.29	<-1	Pass
802.11ax80	6625	-6.99	1.69	-5.30	<-1	Pass
	6785	-6.90	1.69	-5.21	<-1	Pass
802.11ax160	6665	-6.98	1.69	-5.29	<-1	Pass

**Test Data of Conducted Output Power Density for U-NII 7 band -ANT 2**

Test Mode	Test Channel (MHz)	Power Density (dBm/MHz)	Ant Gain (dBi)	EIRP Power Density (dBm/MHz)	Limits (dBm/MHz)	Pass or Fail
802.11ax20	6534	-7.33	1.62	-5.71	<-1	Pass
	6695	-7.08	1.62	-5.46	<-1	Pass
	6855	-7.07	1.62	-5.45	<-1	Pass
802.11ax40	6525	-6.99	1.62	-5.37	<-1	Pass
	6685	-6.82	1.62	-5.20	<-1	Pass
	6845	-7.09	1.62	-5.47	<-1	Pass
802.11ax80	6625	-7.02	1.62	-5.40	<-1	Pass
	6785	-6.95	1.62	-5.33	<-1	Pass
802.11ax160	6665	-7.19	1.62	-5.57	<-1	Pass

Any report having not been signed by authorized approver, or having been altered without authorization, or having not been stamped by the "Dedicated Testing/Inspection Stamp" is deemed to be invalid. Copying or excerpting portion of, or altering the content of the report is not permitted without the written authorization of AGC. The test results presented in the report apply only to the tested sample. Any objections to report issued by AGC should be submitted to AGC within 15days after the issuance of the test report. Further enquiry of validity or verification of the test report should be addressed to AGC by agc01@agccert.com.

**Test Data of Conducted Output Power Density for U-NII 7 band -MIMO**

Test Mode	Test Channel (MHz)	Power Density (dBm/MHz)	Ant Gain (dBi)	EIRP Power Density (dBm/MHz)	Limits (dBm/MHz)	Pass or Fail
802.11ax20	6534	-7.13	1.69	-5.44	<-1	Pass
	6695	-7.00	1.69	-5.31	<-1	Pass
	6855	-7.10	1.69	-5.41	<-1	Pass
802.11ax40	6525	-6.84	1.69	-5.15	<-1	Pass
	6685	-6.90	1.69	-5.21	<-1	Pass
	6845	-7.15	1.69	-5.46	<-1	Pass
802.11ax80	6625	-6.91	1.69	-5.22	<-1	Pass
	6785	-6.82	1.69	-5.13	<-1	Pass
802.11ax160	6665	-6.72	1.69	-5.03	<-1	Pass

**Test Data of Conducted Output Power Density for U-NII 8 band -ANT 1**

Test Mode	Test Channel (MHz)	Power Density (dBm/MHz)	Ant Gain (dBi)	EIRP Power Density (dBm/MHz)	Limits (dBm/MHz)	Pass or Fail
802.11ax20	6875	-7.21	1.69	-5.52	<-1	Pass
	6995	-7.20	1.69	-5.51	<-1	Pass
	7095	-7.26	1.69	-5.57	<-1	Pass
	7115	-11.26	1.69	-9.57	<-1	Pass
802.11ax40	6885	-7.08	1.69	-5.39	<-1	Pass
	7085	-7.05	1.69	-5.36	<-1	Pass
802.11ax80	6865	-7.02	1.69	-5.33	<-1	Pass
	6945	-6.99	1.69	-5.30	<-1	Pass
	7025	-7.10	1.69	-5.41	<-1	Pass
802.11ax160	6985	-7.18	1.69	-5.49	<-1	Pass

Any report having not been signed by authorized approver, or having been altered without authorization, or having not been stamped by the "Dedicated Testing/Inspection Stamp" is deemed to be invalid. Copying or excerpting portion of, or altering the content of the report is not permitted without the written authorization of AGC. The test results presented in the report apply only to the tested sample. Any objections to report issued by AGC should be submitted to AGC within 15days after the issuance of the test report. Further enquiry of validity or verification of the test report should be addressed to AGC by agc01@agccert.com.

**Test Data of Conducted Output Power Density for U-NII 8 band -ANT 2**

Test Mode	Test Channel (MHz)	Power Density (dBm/MHz)	Ant Gain (dBi)	EIRP Power Density (dBm/MHz)	Limits (dBm/MHz)	Pass or Fail
802.11ax20	6875	-7.11	1.62	-5.49	<-1	Pass
	6995	-7.24	1.62	-5.62	<-1	Pass
	7095	-6.95	1.62	-5.33	<-1	Pass
	7115	-11.53	1.62	-9.91	<-1	Pass
802.11ax40	6885	-6.96	1.62	-5.34	<-1	Pass
	7085	-7.07	1.62	-5.45	<-1	Pass
802.11ax80	6865	-7.09	1.62	-5.47	<-1	Pass
	6945	-7.27	1.62	-5.65	<-1	Pass
	7025	-6.98	1.62	-5.36	<-1	Pass
802.11ax160	6985	-7.06	1.62	-5.44	<-1	Pass

**Test Data of Conducted Output Power Density for U-NII 8 band -MIMO**

Test Mode	Test Channel (MHz)	Power Density (dBm/MHz)	Ant Gain (dBi)	EIRP Power Density (dBm/MHz)	Limits (dBm/MHz)	Pass or Fail
802.11ax20	6875	-7.25	1.69	-5.56	<-1	Pass
	6995	-7.08	1.69	-5.39	<-1	Pass
	7095	-7.10	1.69	-5.41	<-1	Pass
	7115	-10.90	1.69	-9.21	<-1	Pass
802.11ax40	6885	-7.14	1.69	-5.45	<-1	Pass
	7085	-7.07	1.69	-5.38	<-1	Pass
802.11ax80	6865	-7.09	1.69	-5.4	<-1	Pass
	6945	-7.14	1.69	-5.45	<-1	Pass
	7025	-7.05	1.69	-5.36	<-1	Pass
802.11ax160	6985	-7.27	1.69	-5.58	<-1	Pass

Any report having not been signed by authorized approver, or having been altered without authorization, or having not been stamped by the "Dedicated Testing/Inspection Stamp" is deemed to be invalid. Copying or excerpting portion of, or altering the content of the report is not permitted without the written authorization of AGC. The test results presented in the report apply only to the tested sample. Any objections to report issued by AGC should be submitted to AGC within 15days after the issuance of the test report. Further enquiry of validity or verification of the test report should be addressed to AGC by agc01@agccert.com.

## 9. IN-BAND EMISSIONS (CHANNEL MASK)

### 9.1 MEASUREMENT LIMIT

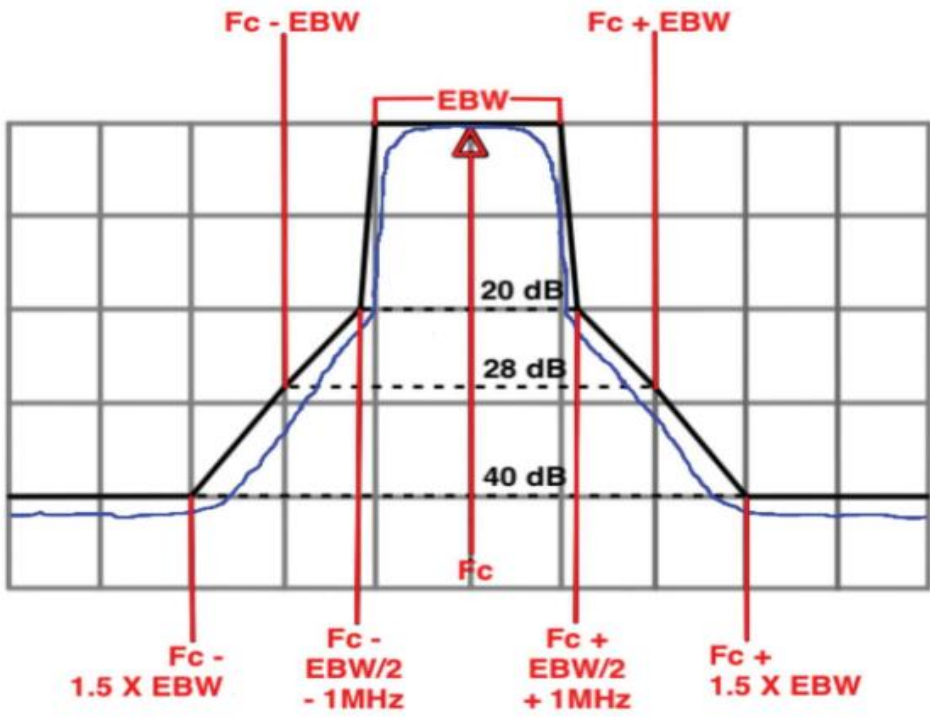
Frequency	Emission MASK Limit
5.945 — 7.125 GHz	<p>Power spectral density must be suppressed by 20 dB at 1 MHz outside of channel edge, by 28 dB at one channel bandwidth from the channel center, and by 40 dB at one- and one-half times the channel bandwidth away from channel center. At frequencies between one megahertz outside an unlicensed device's channel edge and one channel bandwidth from the center of the channel, the limits must be linearly interpolated between 20 dB and 28 dB suppression, and at frequencies between one and one- and one-half times an unlicensed device's channel bandwidth, the limits must be linearly interpolated between 28 dB and 40 dB suppression. Emissions removed from the channel center by more than one- and one-half times the channel bandwidth must be suppressed by at least 40 dB</p> 

### 9.2 MEASUREMENT PROCEDURE

The testing follows FCC KDB 987594 D02 U-NII 6GHz EMC Measurement v01r01. Section J) In-Band Emissions. Take nominal bandwidth as reference channel bandwidth provided that 26 dB emission bandwidth is always larger than nominal bandwidth

1. Measure the power spectral density (which will be used for emissions mask reference) using the following procedure:
  - a) Set the span to encompass the entire 26 dB EBW of the signal.
  - b) Set RBW = same RBW used for 26 dB EBW measurement.
  - c) Set VBW  $\geq 3 \times$  RBW
  - d) Number of points in sweep  $\geq [2 \times \text{span} / \text{RBW}]$ .

Any report having not been signed by authorized approver, or having been altered without authorization, or having not been stamped by the "Dedicated Testing/Inspection Stamp" is deemed to be invalid. Copying or excerpting portion of, or altering the content of the report is not permitted without the written authorization of AGC. The test results presented in the report apply only to the tested sample. Any objections to report issued by AGC should be submitted to AGC within 15days after the issuance of the test report. Further enquiry of validity or verification of the test report should be addressed to AGC by agc01@agccert.com.



- e) Sweep time = auto.
- f) Detector = RMS (i.e., power averaging)
- g) Trace average at least 100 traces in power averaging (rms) mode.
- h) Use the peak search function on the instrument to find the peak of the spectrum.
2. Using the measuring equipment limit line function, develop the emissions mask based on the following requirements. The emissions power spectral density must be reduced below the peak power spectral density (in dB) as follows:
  - a) Suppressed by 20 dB at 1 MHz outside of the channel edge.
  - b) Suppressed by 28 dB at one channel bandwidth from the channel center.
  - c) Suppressed by 40 dB at one- and one-half times the channel bandwidth from the channel center.
3. Adjust the span to encompass the entire mask as necessary.
4. Clear trace.
5. Trace average at least 100 traces in power averaging (rms) mode.
6. Adjust the reference level as necessary so that the crest of the channel touches the top of the emission mask.

### 9.3 MEASUREMENT SETUP (BLOCK DIAGRAM OF CONFIGURATION)

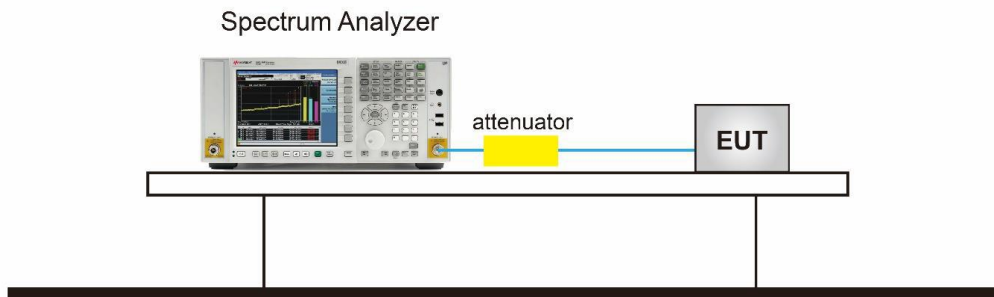

Any report having not been signed by authorized approver, or having been altered without authorization, or having not been stamped by the "Dedicated Testing/Inspection Stamp" is deemed to be invalid. Copying or excerpting portion of, or altering the content of the report is not permitted without the written authorization of AGC. The test results presented in the report apply only to the tested sample. Any objections to report issued by AGC should be submitted to AGC within 15days after the issuance of the test report. Further enquiry of validity or verification of the test report should be addressed to AGC by agc01@agccert.com.

#### 9.4 MEASUREMENT RESULTS

Note: Please refer to the module RF report No.: **(201120-01.TR38)**.

Any report having not been signed by authorized approver, or having been altered without authorization, or having not been stamped by the "Dedicated Testing/Inspection Stamp" is deemed to be invalid. Copying or excerpting portion of, or altering the content of the report is not permitted without the written authorization of AGC. The test results presented in the report apply only to the tested sample. Any objections to report issued by AGC should be submitted to AGC within 15days after the issuance of the test report. Further enquiry of validity or verification of the test report should be addressed to AGC by [agc01@agccert.com](mailto:agc01@agccert.com).

Attestation of Global Compliance(Shenzhen)Co., Ltd  
Attestation of Global Compliance(Shenzhen)Std & Tech Co., Ltd  
Tel: +86-755 2523 4088 E-mail: [agc@agccert.com](mailto:agc@agccert.com) Web: <http://www.agccert.com/>

## 10. CONTENTION BASED PROTOCOL

### 10.1 MEASUREMENT LIMIT

Indoor access points, subordinate devices and client devices operating in the 5.925–7.125 GHz band must employ a contention-based protocol.

FCC KDB 987594 D02 U-NII 6GHz EMC Measurement v01r01

Unlicensed low-power indoor devices must detect co-channel radio frequency power that is at least -62 dBm or lower. Upon detection of energy in the band, unlicensed low power indoor devices must vacate the channel and stay off the channel as long as detected radio frequency power is equal to or greater than the threshold (-62 dBm). The -62 dBm (or lower) threshold is referenced to a 0 dBi antenna gain. To ensure incumbent operations are reliably detected in the band, low power indoor devices must detect RF energy throughout their intended operating channel. For example, an 802.11 device that plans to transmit a 40 MHz- wide signal (on a primary 20 MHz channel and a secondary 20 MHz channel) must detect energy throughout the entire 40 MHz channel. Additionally, low-power indoor devices must detect co-channel energy with 90% or greater certainty.

<b>If</b>	<b>Number of Tests</b>	<b>Placement of Incumbent Transmission</b>
$BW_{EUT} \leq BW_{Inc}$	Once	Tune incumbent and EUT transmissions ( $f_{c1} = f_{c2}$ )
$BW_{Inc} < BW_{EUT} \leq 2BW_{Inc}$	Once	Incumbent transmission is contained within $BW_{EUT}$
$2BW_{Inc} < BW_{EUT} \leq 4BW_{Inc}$	Twice. Incumbent transmission is contained within $BW_{EUT}$	Incumbent transmission is located as closely as possible to the lower edge and upper edge, respectively, of the EUT channel
$BW_{EUT} > 4BW_{Inc}$	Three times	Incumbent transmission is located as closely as possible to the lower edge of the EUT channel, in the middle of EUT channel, and as closely as possible to the upper edge of the EUT channel

Where:

$BW_{EUT}$ : Transmission bandwidth of EUT signal

$BW_{Inc}$ : Transmission bandwidth of the simulated incumbent signal (10 MHz wide AWGN signal)

$f_{c1}$ : Center frequency of EUT transmission

$f_{c2}$ : Center frequency of simulated incumbent signal

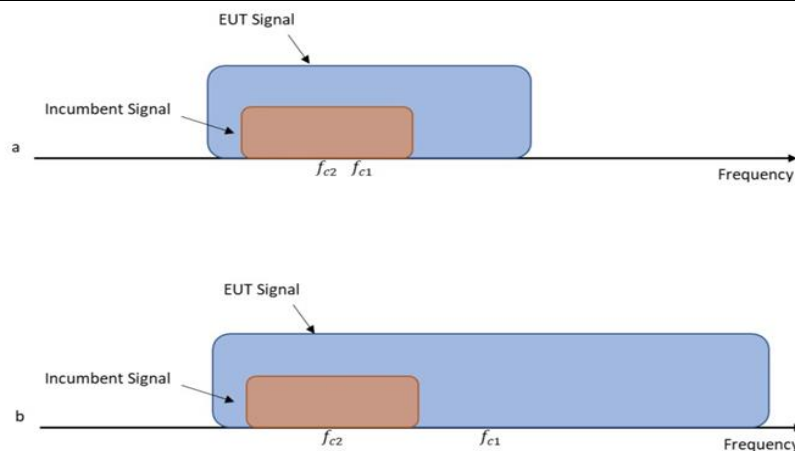

**Figure 1. Two possible scenarios where a) center frequency of EUT transmission falls within incumbent's bandwidth, or b) outside of it**

Any report having no Stamp is deemed invalid. The test results presented in the report apply only to the tested sample. Any objections to report issued by AGC should be submitted to AGC within 15 days after the issuance of the test report. Further enquiry of validity or verification of the test report should be addressed to AGC by agc01@agccert.com.

## 10.2 MEASUREMENT PROCEDURE

Refer to KDB 987594 D02 v01r01.

1. To ensure EUT reliably detects an incumbent signal in both scenarios shown in Figure 1, the detection threshold test may be repeated more than once with the incumbent signal (having center frequency  $f_{c2}$ ) tuned to different center frequencies within the UT transmission bandwidth. The criteria specified in Table 1 determines how many times the detection threshold test must be performed
2. Using an AWGN signal source, generate (but do not transmit, i.e., RF OFF) a 10 MHz-wide AWGN signal. Use Table 1 to determine the center frequency of the 10 MHz AWGN signal relative to the EUT's channel bandwidth and center frequency.
3. Monitor the signal analyzer to verify if the AWGN signal has been detected and the EUT has ceased transmission. If the EUT continues to transmit, then incrementally increase the AWGN signal power level until the EUT stops transmitting.
4. (Including all losses in the RF paths) Determine and record the AWGN signal power level (at the EUT's antenna port) at which the EUT ceased transmission. Repeat the procedure at least 10 times to verify the EUT can detect an AWGN signal with 90% (or better) level of certainty.
5. Refer to Table 1 to determine number of times the detection threshold testing needs to be repeated. If testing is required more than once, then go back to step 2, choose a different center frequency for the AWGN signal and repeat the process.
6. EUT was driven in MIMO mode, the interferer signal was injected to both chains to monitor the performance, while the interferer level is determined according to the lowest antenna gain among both antennas.

## 10.3 MEASUREMENT SETUP (BLOCK DIAGRAM OF CONFIGURATION)

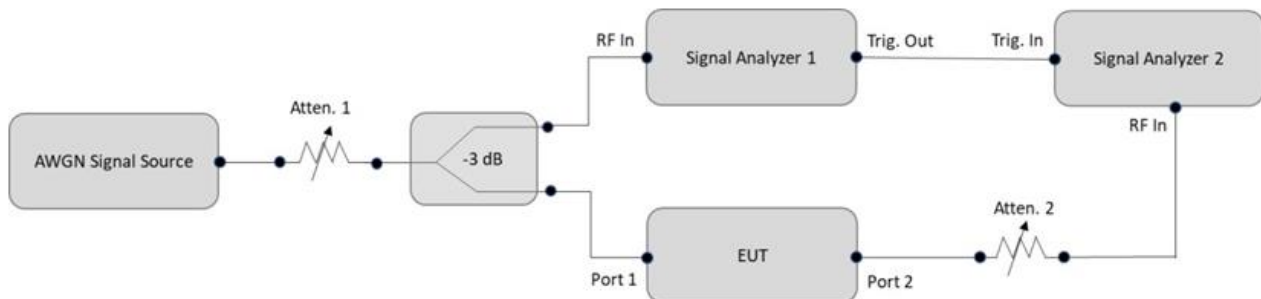

**Figure 2. Contention-based protocol test setup, conducted method Step-by-Step Procedure, Conducted Setup**

Any report having not been signed by authorized approver, or having been altered without authorization, or having not been stamped by the "Dedicated Testing/Inspection Stamp" is deemed to be invalid. Copying or excerpting portion of, or altering the content of the report is not permitted without the written authorization of AGC. The test results presented in the report apply only to the tested sample. Any objections to report issued by AGC should be submitted to AGC within 15days after the issuance of the test report. Further enquiry of validity or verification of the test report should be addressed to AGC by agc01@agccert.com.

#### 10.4 MEASUREMENT RESULTS

Note: Please refer to the module RF report No.: **(201120-01.TR38)**.

Any report having not been signed by authorized approver, or having been altered without authorization, or having not been stamped by the "Dedicated Testing/Inspection Stamp" is deemed to be invalid. Copying or excerpting portion of, or altering the content of the report is not permitted without the written authorization of AGC. The test results presented in the report apply only to the tested sample. Any objections to report issued by AGC should be submitted to AGC within 15days after the issuance of the test report. Further enquiry of validity or verification of the test report should be addressed to AGC by [agc01@agccert.com](mailto:agc01@agccert.com).

Attestation of Global Compliance(Shenzhen)Co., Ltd  
Attestation of Global Compliance(Shenzhen)Std & Tech Co., Ltd  
Tel: +86-755 2523 4088 E-mail: [agc@agccert.com](mailto:agc@agccert.com) Web: <http://www.agccert.com/>

## 11. UNWANTED EMISSIONS

### 11.1 LIMITS OF RADIATED EMISSION TEST

- (1) For transmitters operating within the 5.925-7.125 GHz band: Any emissions outside of the 5.925-7.125 GHz band must not exceed an e.i.r.p. of -27 dBm/MHz.

EIRP (dBm)	Field Strength at 3m (dBμV/m)
- 27 (RMS)	68.2
- 7 (Peak)	88.2

- (2) Unwanted spurious emissions fallen in restricted bands shall comply with the general field strength limits as below table:

Frequency (MHz)	Field Strength (microvolts/meter)	Measurement Distance (meters)
0.009 – 0.490	2400/F(kHz)	300
0.490 – 1.705	24000/F(kHz)	30
1.705 – 30.0	30	30
30 – 88	100	3
88 – 216	150	3
216 - 960	200	3
Above 960	500	3

Note: The following formula is used to convert the EIRP to field strength.

$$E = \frac{1000000 \sqrt{30P}}{3} \mu\text{V/m, where P is the eirp (Watts)}$$

### 11.2 MEASUREMENT PROCEDURE

- The EUT was placed on the top of the turntable 0.8 or 1.5 meter above ground. The phase center of the receiving antenna mounted on the top of a height-variable antenna tower was placed 3 meters far away from the turntable.
- Power on the EUT and all the supporting units. The turntable was rotated by 360 degrees to determine the position of the highest radiation.
- The height of the broadband receiving antenna was varied between one meter and four meters above ground to find the maximum emissions field strength of both horizontal and vertical polarization.
- For each suspected emission, the antenna tower was scan (from 1 M to 4 M) and then the turntable was rotated (from 0 degree to 360 degrees) to find the maximum reading.
- Set the test-receiver system to Peak or CISPR quasi-peak Detect Function with specified bandwidth under Maximum Hold Mode.
- For emissions above 1GHz, use 1MHz RBW and 3MHz VBW for peak reading. Place the measurement antenna away from each area of the EUT determined to be a source of emissions at the specified measurement distance, while keeping the measurement antenna aimed at the source of emissions at each frequency of significant emissions, with polarization oriented for maximum response. The measurement

Any report having not been signed by authorized approver, or having been altered without authorization, or having not been stamped by the "Dedicated Testing/Inspection Stamp" is deemed to be invalid. Copying or excerpting portion of, or altering the content of the report is not permitted without the written authorization of AGC. The test results presented in the report apply only to the tested sample. Any objections to report issued by AGC should be submitted to AGC within 15days after the issuance of the test report. Further enquiry of validity or verification of the test report should be addressed to AGC by agc01@agccert.com.

antenna may have to be higher or lower than the EUT, depending on the radiation pattern of the emission and staying aimed at the emission source for receiving the maximum signal. The final measurement antenna elevation shall be that which maximizes the emissions. The measurement antenna elevation for maximum emissions shall be restricted to a range of heights of from 1 m to 4 m above the ground or reference ground plane.

7. When the radiated emissions limits are expressed in terms of the average value of the emissions, and pulsed operation is employed, the measurement field strength shall be determined by averaging over one complete pulse train, including blanking intervals, as long as the pulse train does not exceed 0.1 seconds. As an alternative (provided the transmitter operates for longer than 0.1 seconds) or in cases where the pulse train exceeds 0.1 seconds, the measured field strength shall be determined from the average absolute voltage during a 0.1 second interval during which the field strength is at its maximum values.
8. If the emissions level of the EUT in peak mode was 3 dB lower than the average limit specified, then testing will be stopped and peak values of EUT will be reported, otherwise, the emissions which do not have 3 dB margin will be repeated one by one using the quasi-peak method for below 1GHz.
9. For testing above 1GHz, the emissions level of the EUT in peak mode was lower than average limit (that means the emissions level in peak mode also complies with the limit in average mode), then testing will be stopped and peak values of EUT will be reported, otherwise, the emissions will be measured in average mode again and reported.
10. In case the emission is lower than 30MHz, loop antenna has to be used for measurement and the recorded data should be QP measured by receiver. High - Low scan is not required in this case.

Any report having not been signed by authorized approver, or having been altered without authorization, or having not been stamped by the "Dedicated Testing/Inspection Stamp" is deemed to be invalid. Copying or excerpting portion of, or altering the content of the report is not permitted without the written authorization of AGC. The test results presented in the report apply only to the tested sample. Any objections to report issued by AGC should be submitted to AGC within 15days after the issuance of the test report. Further enquiry of validity or verification of the test report should be addressed to AGC by [agc01@agccert.com](mailto:agc01@agccert.com).



The following table is the setting of spectrum analyzer and receiver.

Receiver Parameter	Setting
Start ~Stop Frequency	9KHz~150KHz/RB 200Hz for QP
Start ~Stop Frequency	150KHz~30MHz/RB 9KHz for QP
Start ~Stop Frequency	30MHz~1000MHz/RB 120KHz for QP

The testing follows FCC KDB 789033 D02 General UNII Test Procedures New Rules v01r04.Section G) Unwanted emissions measurement.

**(1) Procedure for Unwanted Emissions Measurements Below 1000MHz:**

- RBW = 120 kHz
- VBW = 300 kHz
- Detector = Peak
- Trace mode = max hold

**(2) Procedure for Peak Unwanted Emissions Measurements Above 1000 MHz:**

- RBW = 1 MHz
- VBW ≥ 3 MHz
- Detector = Peak
- Sweep time = auto
- Trace mode = max hold

**(3) Procedures for Average Unwanted Emissions Measurements Above 1000MHz:**

- RBW = 1 MHz
- VBW = 10 Hz, when duty cycle is no less than 98 percent.
- VBW ≥ 1/T, when duty cycle is less than 98 percent where T is the minimum transmission duration over which the transmitter is on and is transmitting at its maximum power control level for the tested mode of operation.

**(4) Procedures for Average Unwanted Emissions Measurements Above 1000MHz:**

- RBW = 1 MHz
- VBW = 3 MHz • Detector = power averaging (rms), set span/(# of points in sweep) ≥ RBW/2.
- Averaging type = power averaging (RMS)
- The correction factor shall be offset is 10 log (1/x), where x is the duty cycle.

Any report having not been signed by authorized approver, or having been altered without authorization, or having not been stamped by the “Dedicated Testing/Inspection Stamp” is deemed to be invalid. Copying or excerpting portion of, or altering the content of the report is not permitted without the written authorization of AGC. The test results presented in the report apply only to the tested sample. Any objections to report issued by AGC should be submitted to AGC within 15days after the issuance of the test report. Further enquiry of validity or verification of the test report should be addressed to AGC by agc01@agccert.com.

### 11.3 MEASUREMENT SETUP (BLOCK DIAGRAM OF CONFIGURATION)

**RADIATED EMISSION TEST SETUP 9KHz-30MHz**

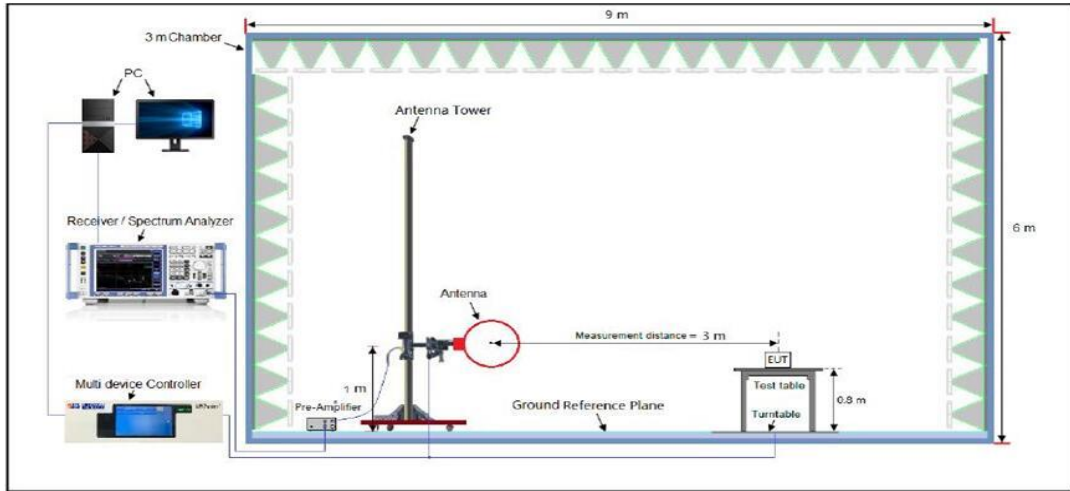

**RADIATED EMISSION TEST SETUP 30MHz-1000MHz**

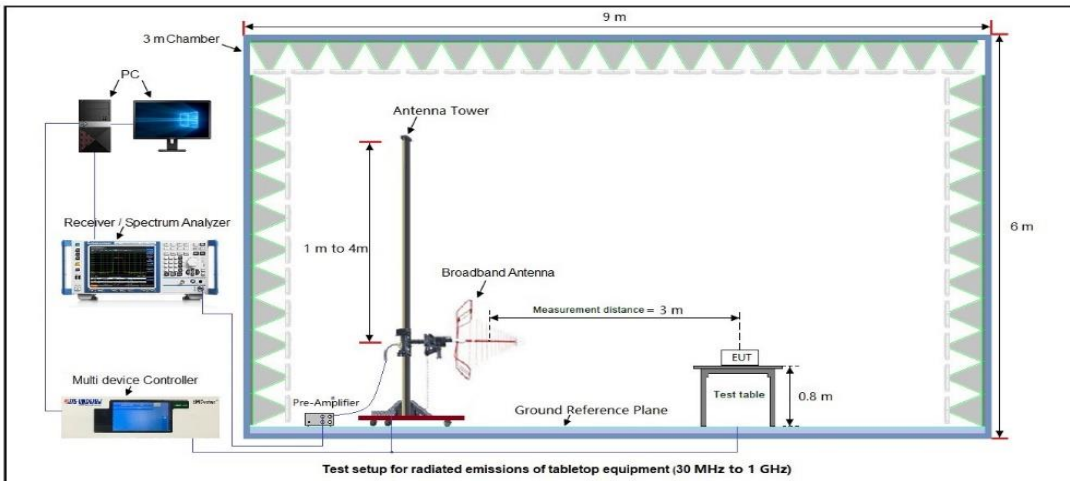

**RADIATED EMISSION TEST SETUP ABOVE 1000MHz**

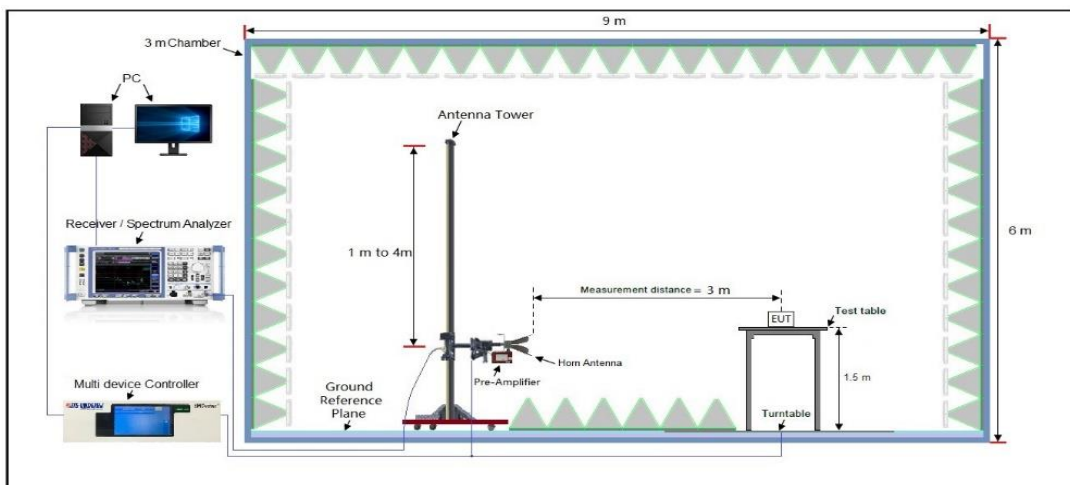

Any report having not been signed by authorized approver, or having been altered without authorization, or having not been stamped by the "Dedicated Testing/Inspection Stamp" is deemed to be invalid. Copying or excerpting portion of, or altering the content of the report is not permitted without the written authorization of AGC. The test results presented in the report apply only to the tested sample. Any objections to report issued by AGC should be submitted to AGC within 15days after the issuance of the test report. Further enquiry of validity or verification of the test report should be addressed to AGC by agc01@agccert.com.

### 11.4 MEASUREMENT RESULT

#### Radiated Emission Below 30MHz

The amplitude of spurious emissions from 9kHz to 30MHz which are attenuated more than 20 dB below the permissible value need not be reported.

#### Radiated Emission from 30MHz to 1000MHz

<b>EUT</b>	Mini PC	<b>Model Name</b>	MPC43
<b>Temperature</b>	25° C	<b>Relative Humidity</b>	55.4%
<b>Pressure</b>	960hPa	<b>Test Voltage</b>	Normal Voltage
<b>Test Mode</b>	Mode 1	<b>Antenna</b>	Horizontal

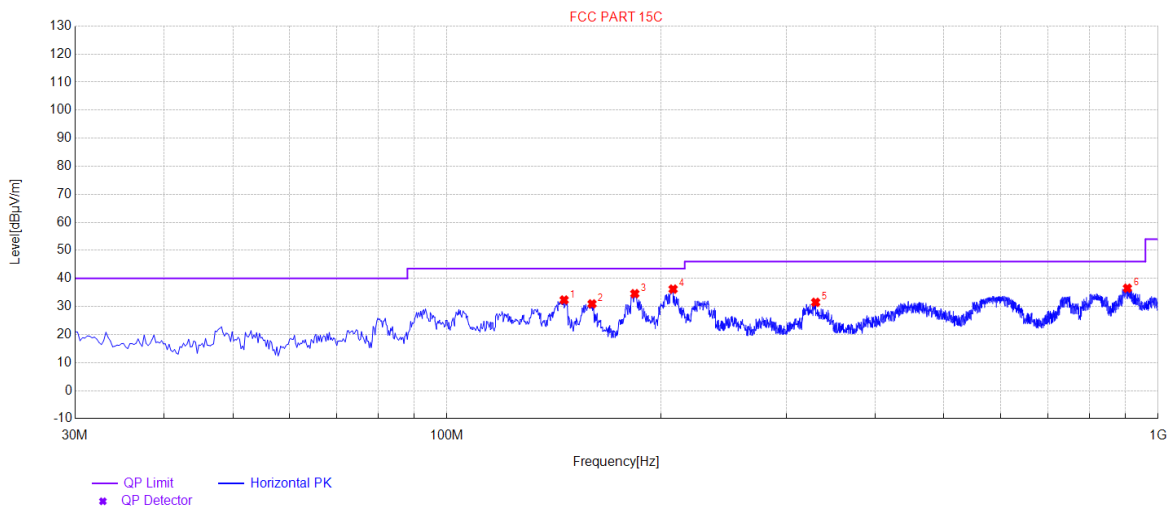

NO.	Freq. [MHz]	Level [dBµV/m]	Factor [dB]	Limit [dBµV/m]	Margin [dB]	Height [cm]	Angle [°]	Polarity
1	146.1575	32.31	14.58	43.50	11.19	100	356	Horizontal
2	159.98	30.93	13.94	43.50	12.57	100	325	Horizontal
3	183.745	34.56	13.00	43.50	8.94	100	354	Horizontal
4	207.995	36.18	13.51	43.50	7.32	100	360	Horizontal
5	329.9725	31.48	21.08	46.00	14.52	100	11	Horizontal
6	905.425	36.51	31.40	46.00	9.49	100	338	Horizontal

**RESULT: PASS**

Any report having not been signed by authorized approver, or having been altered without authorization, or having not been stamped by the “Dedicated Testing/Inspection Stamp” is deemed to be invalid. Copying or excerpting portion of, or altering the content of the report is not permitted without the written authorization of AGC. The test results presented in the report apply only to the tested sample. Any objections to report issued by AGC should be submitted to AGC within 15days after the issuance of the test report. Further enquiry of validity or verification of the test report should be addressed to AGC by agc01@agccert.com.

<b>EUT</b>	Mini PC	<b>Model Name</b>	MPC43
<b>Temperature</b>	25° C	<b>Relative Humidity</b>	55.4%
<b>Pressure</b>	960hPa	<b>Test Voltage</b>	Normal Voltage
<b>Test Mode</b>	Mode 1	<b>Antenna</b>	Vertical

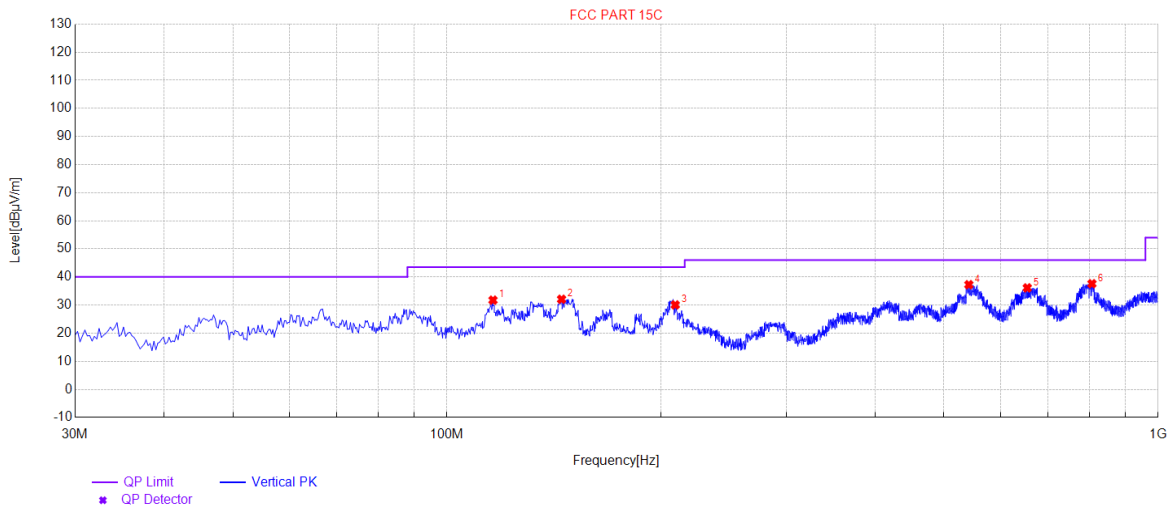

NO.	Freq. [MHz]	Level [dBµV/m]	Factor [dB]	Limit [dBµV/m]	Margin [dB]	Height [cm]	Angle [°]	Polarity
1	116.0875	31.75	16.58	43.50	11.75	100	322	Vertical
2	144.945	32.07	20.38	43.50	11.43	100	347	Vertical
3	209.45	30.06	15.16	43.50	13.44	100	1	Vertical
4	541.9175	37.25	24.39	46.00	8.75	100	330	Vertical
5	654.68	36.12	25.42	46.00	9.88	100	79	Vertical
6	807.2125	37.60	30.22	46.00	8.40	100	326	Vertical

**RESULT: PASS**

**Note:**

1. Factor=Antenna Factor + Cable loss, Margin=Limit-Level.
2. All test modes had been pre-tested. The mode 1 is the worst case and recorded in the report.

Any report having not been signed by authorized approver, or having been altered without authorization, or having not been stamped by the “Dedicated Testing/Inspection Stamp” is deemed to be invalid. Copying or excerpting portion of, or altering the content of the report is not permitted without the written authorization of AGC. The test results presented in the report apply only to the tested sample. Any objections to report issued by AGC should be submitted to AGC within 15days after the issuance of the test report. Further enquiry of validity or verification of the test report should be addressed to AGC by agc01@agccert.com.

**Radiated Emission Above 1GHz**

<b>EUT</b>	Mini PC	<b>Model Name</b>	MPC43
<b>Temperature</b>	25° C	<b>Relative Humidity</b>	55.4%
<b>Pressure</b>	960hPa	<b>Test Voltage</b>	Normal Voltage
<b>Test Mode</b>	Mode 1	<b>Antenna</b>	Horizontal

Frequency (MHz)	Meter Reading (dBµV)	Factor (dB)	Emission Level (dBµV/m)	Limits (dBµV/m)	Margin (dB)	Value Type
11910.000	47.12	9.30	56.42	74.00	-17.58	peak
11910.000	37.48	9.30	46.78	54.00	-7.22	AVG
17865.000	41.02	10.43	51.45	74.00	-22.55	peak
17865.000	32.49	10.43	42.92	54.00	-11.08	AVG
Remark:						
Factor = Antenna Factor + Cable Loss – Pre-amplifier.						

<b>EUT</b>	Mini PC	<b>Model Name</b>	MPC43
<b>Temperature</b>	25° C	<b>Relative Humidity</b>	55.4%
<b>Pressure</b>	960hPa	<b>Test Voltage</b>	Normal Voltage
<b>Test Mode</b>	Mode 1	<b>Antenna</b>	Vertical

Frequency (MHz)	Meter Reading (dBµV)	Factor (dB)	Emission Level (dBµV/m)	Limits (dBµV/m)	Margin (dB)	Value Type
11910.000	48.56	9.30	57.86	74.00	-16.14	peak
11490.042	37.49	9.30	46.79	54.00	-7.21	AVG
17865.000	42.57	10.43	53.00	74.00	-21.00	peak
17865.000	33.67	10.43	44.10	54.00	-9.90	AVG
Remark:						
Factor = Antenna Factor + Cable Loss – Pre-amplifier.						

**RESULT: PASS**

Any report having not been signed by authorized approver, or having been altered without authorization, or having not been stamped by the “Dedicated Testing/Inspection Stamp” is deemed to be invalid. Copying or excerpting portion of, or altering the content of the report is not permitted without the written authorization of AGC. The test results presented in the report apply only to the tested sample. Any objections to report issued by AGC should be submitted to AGC within 15days after the issuance of the test report. Further enquiry of validity or verification of the test report should be addressed to AGC by agc01@agccert.com.

<b>EUT</b>	Mini PC	<b>Model Name</b>	MPC43
<b>Temperature</b>	25° C	<b>Relative Humidity</b>	55.4%
<b>Pressure</b>	960hPa	<b>Test Voltage</b>	Normal Voltage
<b>Test Mode</b>	Mode 4	<b>Antenna</b>	Horizontal

Frequency	Meter Reading	Factor	Emission Level	Limits	Margin	Value Type
(MHz)	(dBμV)	(dB)	(dBμV/m)	(dBμV/m)	(dB)	
11930.000	47.56	9.42	56.98	74.00	-17.02	peak
11930.000	39.12	9.42	48.54	54.00	-5.46	AVG
17895.000	42.15	10.51	52.66	74.00	-21.34	peak
17895.000	33.08	10.51	43.59	54.00	-10.41	AVG
Remark:						
Factor = Antenna Factor + Cable Loss – Pre-amplifier.						

<b>EUT</b>	Mini PC	<b>Model Name</b>	MPC43
<b>Temperature</b>	25° C	<b>Relative Humidity</b>	55.4%
<b>Pressure</b>	960hPa	<b>Test Voltage</b>	Normal Voltage
<b>Test Mode</b>	Mode 4	<b>Antenna</b>	Vertical

Frequency	Meter Reading	Factor	Emission Level	Limits	Margin	Value Type
(MHz)	(dBμV)	(dB)	(dBμV/m)	(dBμV/m)	(dB)	
11930.000	47.64	9.42	57.06	74.00	-16.94	peak
11930.000	36.25	9.42	45.67	54.00	-8.33	AVG
17895.000	41.02	10.51	51.53	74.00	-22.47	peak
17895.000	32.49	10.51	43.00	54.00	-11.00	AVG
Remark:						
Factor = Antenna Factor + Cable Loss – Pre-amplifier.						

**RESULT: PASS**

Any report having not been signed by authorized approver, or having been altered without authorization, or having not been stamped by the “Dedicated Testing/Inspection Stamp” is deemed to be invalid. Copying or excerpting portion of, or altering the content of the report is not permitted without the written authorization of AGC. The test results presented in the report apply only to the tested sample. Any objections to report issued by AGC should be submitted to AGC within 15days after the issuance of the test report. Further enquiry of validity or verification of the test report should be addressed to AGC by agc01@agccert.com.



<b>EUT</b>	Mini PC	<b>Model Name</b>	MPC43
<b>Temperature</b>	25° C	<b>Relative Humidity</b>	55.4%
<b>Pressure</b>	960hPa	<b>Test Voltage</b>	Normal Voltage
<b>Test Mode</b>	Mode 7	<b>Antenna</b>	Horizontal

Frequency (MHz)	Meter Reading (dBµV)	Factor (dB)	Emission Level (dBµV/m)	Limits (dBµV/m)	Margin (dB)	Value Type
11970.000	46.35	9.62	55.97	74.00	-18.03	peak
11970.000	37.12	9.62	46.74	54.00	-7.26	AVG
17955.000	40.25	10.75	51.00	74.00	-23.00	peak
17955.000	31.58	10.75	42.33	54.00	-11.67	AVG

Remark:

Factor = Antenna Factor + Cable Loss – Pre-amplifier.

<b>EUT</b>	Mini PC	<b>Model Name</b>	MPC43
<b>Temperature</b>	25° C	<b>Relative Humidity</b>	55.4%
<b>Pressure</b>	960hPa	<b>Test Voltage</b>	Normal Voltage
<b>Test Mode</b>	Mode 7	<b>Antenna</b>	Vertical

Frequency (MHz)	Meter Reading (dBµV)	Factor (dB)	Emission Level (dBµV/m)	Limits (dBµV/m)	Margin (dB)	Value Type
11970.000	45.23	9.62	54.85	74.00	-19.15	peak
11970.000	34.18	9.62	43.80	54.00	-10.20	AVG
17955.000	40.15	10.75	50.90	74.00	-23.10	peak
17955.000	30.59	10.75	41.34	54.00	-12.66	AVG

Remark:

Factor = Antenna Factor + Cable Loss – Pre-amplifier.

**RESULT: PASS**

Any report having not been signed by authorized approver, or having been altered without authorization, or having not been stamped by the “Dedicated Testing/Inspection Stamp” is deemed to be invalid. Copying or excerpting portion of, or altering the content of the report is not permitted without the written authorization of AGC. The test results presented in the report apply only to the tested sample. Any objections to report issued by AGC should be submitted to AGC within 15days after the issuance of the test report. Further enquiry of validity or verification of the test report should be addressed to AGC by agc01@agccert.com.



<b>EUT</b>	Mini PC	<b>Model Name</b>	MPC43
<b>Temperature</b>	25° C	<b>Relative Humidity</b>	55.4%
<b>Pressure</b>	960hPa	<b>Test Voltage</b>	Normal Voltage
<b>Test Mode</b>	Mode 10	<b>Antenna</b>	Horizontal

Frequency (MHz)	Meter Reading (dBµV)	Factor (dB)	Emission Level (dBµV/m)	Limits (dBµV/m)	Margin (dB)	Value Type
12050.000	46.35	9.30	55.65	74.00	-18.35	peak
12050.000	35.91	9.30	45.21	54.00	-8.79	AVG
18075.000	41.02	10.43	51.45	74.00	-22.55	peak
18075.000	30.56	10.43	40.99	54.00	-13.01	AVG
Remark:						
Factor = Antenna Factor + Cable Loss – Pre-amplifier.						

<b>EUT</b>	Mini PC	<b>Model Name</b>	MPC43
<b>Temperature</b>	25° C	<b>Relative Humidity</b>	55.4%
<b>Pressure</b>	960hPa	<b>Test Voltage</b>	Normal Voltage
<b>Test Mode</b>	Mode 10	<b>Antenna</b>	Vertical

Frequency (MHz)	Meter Reading (dBµV)	Factor (dB)	Emission Level (dBµV/m)	Limits (dBµV/m)	Margin (dB)	Value Type
12050.000	45.25	9.30	54.55	74.00	-19.45	peak
12050.000	35.14	9.30	44.44	54.00	-9.56	AVG
18075.000	42.36	10.43	52.79	74.00	-21.21	peak
18075.000	30.25	10.43	40.68	54.00	-13.32	AVG
Remark:						
Factor = Antenna Factor + Cable Loss – Pre-amplifier.						

**RESULT: PASS**

Any report having not been signed by authorized approver, or having been altered without authorization, or having not been stamped by the “Dedicated Testing/Inspection Stamp” is deemed to be invalid. Copying or excerpting portion of, or altering the content of the report is not permitted without the written authorization of AGC. The test results presented in the report apply only to the tested sample. Any objections to report issued by AGC should be submitted to AGC within 15days after the issuance of the test report. Further enquiry of validity or verification of the test report should be addressed to AGC by agc01@agccert.com.

<b>EUT</b>	Mini PC	<b>Model Name</b>	MPC43
<b>Temperature</b>	25° C	<b>Relative Humidity</b>	55.4%
<b>Pressure</b>	960hPa	<b>Test Voltage</b>	Normal Voltage
<b>Test Mode</b>	Mode 12	<b>Antenna</b>	Horizontal

Frequency	Meter Reading	Factor	Emission Level	Limits	Margin	Value Type
(MHz)	(dBμV)	(dB)	(dBμV/m)	(dBμV/m)	(dB)	
12870.000	46.35	9.42	55.77	68.20	-12.43	peak
19305.000	40.23	10.51	50.74	74.00	-23.26	AVG
19305.000	30.59	10.51	41.10	54.00	-12.90	peak
<b>Remark:</b>						
Factor = Antenna Factor + Cable Loss – Pre-amplifier.						

<b>EUT</b>	Mini PC	<b>Model Name</b>	MPC43
<b>Temperature</b>	25° C	<b>Relative Humidity</b>	55.4%
<b>Pressure</b>	960hPa	<b>Test Voltage</b>	Normal Voltage
<b>Test Mode</b>	Mode 12	<b>Antenna</b>	Vertical

Frequency	Meter Reading	Factor	Emission Level	Limits	Margin	Value Type
(MHz)	(dBμV)	(dB)	(dBμV/m)	(dBμV/m)	(dB)	
12870.000	46.38	9.42	55.80	68.20	-12.40	peak
19305.000	41.02	10.51	51.53	74.00	-22.47	peak
19305.000	32.49	10.51	43.00	54.00	-11.00	AVG
<b>Remark:</b>						
Factor = Antenna Factor + Cable Loss – Pre-amplifier.						

**RESULT: PASS**

Any report having not been signed by authorized approver, or having been altered without authorization, or having not been stamped by the “Dedicated Testing/Inspection Stamp” is deemed to be invalid. Copying or excerpting portion of, or altering the content of the report is not permitted without the written authorization of AGC. The test results presented in the report apply only to the tested sample. Any objections to report issued by AGC should be submitted to AGC within 15days after the issuance of the test report. Further enquiry of validity or verification of the test report should be addressed to AGC by agc01@agccert.com.

<b>EUT</b>	Mini PC	<b>Model Name</b>	MPC43
<b>Temperature</b>	25° C	<b>Relative Humidity</b>	55.4%
<b>Pressure</b>	960hPa	<b>Test Voltage</b>	Normal Voltage
<b>Test Mode</b>	Mode 15	<b>Antenna</b>	Horizontal

Frequency (MHz)	Meter Reading (dBµV)	Factor (dB)	Emission Level (dBµV/m)	Limits (dBµV/m)	Margin (dB)	Value Type
12890.000	46.38	9.62	56.00	68.20	-12.20	peak
19335.000	41.26	10.75	52.01	74.00	-21.99	peak
19335.000	30.59	10.75	41.34	54.00	-12.66	AVG

Remark:

Factor = Antenna Factor + Cable Loss – Pre-amplifier.

<b>EUT</b>	Mini PC	<b>Model Name</b>	MPC43
<b>Temperature</b>	25° C	<b>Relative Humidity</b>	55.4%
<b>Pressure</b>	960hPa	<b>Test Voltage</b>	Normal Voltage
<b>Test Mode</b>	Mode 15	<b>Antenna</b>	Vertical

Frequency (MHz)	Meter Reading (dBµV)	Factor (dB)	Emission Level (dBµV/m)	Limits (dBµV/m)	Margin (dB)	Value Type
12890.000	46.28	9.62	55.90	68.20	-12.30	peak
19335.000	40.15	10.75	50.90	74.00	-23.10	peak
19335.000	31.59	10.75	42.34	54.00	-11.66	AVG

Remark:

Factor = Antenna Factor + Cable Loss – Pre-amplifier.

Any report having not been signed by authorized approver, or having been altered without authorization, or having not been stamped by the “Dedicated Testing/Inspection Stamp” is deemed to be invalid. Copying or excerpting portion of, or altering the content of the report is not permitted without the written authorization of AGC. The test results presented in the report apply only to the tested sample. Any objections to report issued by AGC should be submitted to AGC within 15days after the issuance of the test report. Further enquiry of validity or verification of the test report should be addressed to AGC by agc01@agccert.com.

<b>EUT</b>	Mini PC	<b>Model Name</b>	MPC43
<b>Temperature</b>	25° C	<b>Relative Humidity</b>	55.4%
<b>Pressure</b>	960hPa	<b>Test Voltage</b>	Normal Voltage
<b>Test Mode</b>	Mode 17	<b>Antenna</b>	Horizontal

Frequency (MHz)	Meter Reading (dBµV)	Factor (dB)	Emission Level (dBµV/m)	Limits (dBµV/m)	Margin (dB)	Value Type
12930.000	45.23	9.62	54.85	68.20	-13.35	peak
19395.000	40.28	10.75	51.03	74.00	-22.97	peak
19395.000	31.49	10.75	42.24	54.00	-11.76	AVG

Remark:

Factor = Antenna Factor + Cable Loss – Pre-amplifier.

<b>EUT</b>	Mini PC	<b>Model Name</b>	MPC43
<b>Temperature</b>	25° C	<b>Relative Humidity</b>	55.4%
<b>Pressure</b>	960hPa	<b>Test Voltage</b>	Normal Voltage
<b>Test Mode</b>	Mode 17	<b>Antenna</b>	Vertical

Frequency (MHz)	Meter Reading (dBµV)	Factor (dB)	Emission Level (dBµV/m)	Limits (dBµV/m)	Margin (dB)	Value Type
12930.000	46.28	9.62	55.90	68.20	-12.30	peak
19395.000	41.02	10.75	51.77	74.00	-22.23	peak
19395.000	32.59	10.75	43.34	54.00	-10.66	AVG

Remark:

Factor = Antenna Factor + Cable Loss – Pre-amplifier.

Any report having not been signed by authorized approver, or having been altered without authorization, or having not been stamped by the “Dedicated Testing/Inspection Stamp” is deemed to be invalid. Copying or excerpting portion of, or altering the content of the report is not permitted without the written authorization of AGC. The test results presented in the report apply only to the tested sample. Any objections to report issued by AGC should be submitted to AGC within 15days after the issuance of the test report. Further enquiry of validity or verification of the test report should be addressed to AGC by agc01@agccert.com.

<b>EUT</b>	Mini PC	<b>Model Name</b>	MPC43
<b>Temperature</b>	25° C	<b>Relative Humidity</b>	55.4%
<b>Pressure</b>	960hPa	<b>Test Voltage</b>	Normal Voltage
<b>Test Mode</b>	Mode 19	<b>Antenna</b>	Horizontal

Frequency (MHz)	Meter Reading (dBµV)	Factor (dB)	Emission Level (dBµV/m)	Limits (dBµV/m)	Margin (dB)	Value Type
13010.000	47.15	9.62	56.77	68.20	-11.43	peak
19515.000	42.19	10.75	52.94	74.00	-21.06	peak
19515.000	31.56	10.75	42.31	54.00	-11.69	AVG

Remark:

Factor = Antenna Factor + Cable Loss – Pre-amplifier.

<b>EUT</b>	Mini PC	<b>Model Name</b>	MPC43
<b>Temperature</b>	25° C	<b>Relative Humidity</b>	55.4%
<b>Pressure</b>	960hPa	<b>Test Voltage</b>	Normal Voltage
<b>Test Mode</b>	Mode 19	<b>Antenna</b>	Vertical

Frequency (MHz)	Meter Reading (dBµV)	Factor (dB)	Emission Level (dBµV/m)	Limits (dBµV/m)	Margin (dB)	Value Type
13010.000	46.99	9.62	56.61	68.20	-11.59	peak
19515.000	40.13	10.75	50.88	74.00	-23.12	peak
19515.000	32.57	10.75	43.32	54.00	-10.68	AVG

Remark:

Factor = Antenna Factor + Cable Loss – Pre-amplifier.

Any report having not been signed by authorized approver, or having been altered without authorization, or having not been stamped by the “Dedicated Testing/Inspection Stamp” is deemed to be invalid. Copying or excerpting portion of, or altering the content of the report is not permitted without the written authorization of AGC. The test results presented in the report apply only to the tested sample. Any objections to report issued by AGC should be submitted to AGC within 15days after the issuance of the test report. Further enquiry of validity or verification of the test report should be addressed to AGC by agc01@agccert.com.

<b>EUT</b>	Mini PC	<b>Model Name</b>	MPC43
<b>Temperature</b>	25° C	<b>Relative Humidity</b>	55.4%
<b>Pressure</b>	960hPa	<b>Test Voltage</b>	Normal Voltage
<b>Test Mode</b>	Mode 20	<b>Antenna</b>	Horizontal

Frequency (MHz)	Meter Reading (dBμV)	Factor (dB)	Emission Level (dBμV/m)	Limits (dBμV/m)	Margin (dB)	Value Type
13070.000	47.12	9.62	56.74	68.20	-11.46	peak
19605.000	42.35	10.75	53.10	74.00	-20.90	peak
19605.000	31.59	10.75	42.34	54.00	-11.66	AVG

Remark:

Factor = Antenna Factor + Cable Loss – Pre-amplifier.

<b>EUT</b>	Mini PC	<b>Model Name</b>	MPC43
<b>Temperature</b>	25° C	<b>Relative Humidity</b>	55.4%
<b>Pressure</b>	960hPa	<b>Test Voltage</b>	Normal Voltage
<b>Test Mode</b>	Mode 20	<b>Antenna</b>	Vertical

Frequency (MHz)	Meter Reading (dBμV)	Factor (dB)	Emission Level (dBμV/m)	Limits (dBμV/m)	Margin (dB)	Value Type
13070.000	46.58	9.62	56.20	68.20	-12.00	peak
19605.000	41.02	10.75	51.77	74.00	-22.23	peak
19605.000	30.59	10.75	41.34	54.00	-12.66	AVG

Remark:

Factor = Antenna Factor + Cable Loss – Pre-amplifier.

Any report having not been signed by authorized approver, or having been altered without authorization, or having not been stamped by the “Dedicated Testing/Inspection Stamp” is deemed to be invalid. Copying or excerpting portion of, or altering the content of the report is not permitted without the written authorization of AGC. The test results presented in the report apply only to the tested sample. Any objections to report issued by AGC should be submitted to AGC within 15days after the issuance of the test report. Further enquiry of validity or verification of the test report should be addressed to AGC by agc01@agccert.com.

<b>EUT</b>	Mini PC	<b>Model Name</b>	MPC43
<b>Temperature</b>	25° C	<b>Relative Humidity</b>	55.4%
<b>Pressure</b>	960hPa	<b>Test Voltage</b>	Normal Voltage
<b>Test Mode</b>	Mode 23	<b>Antenna</b>	Horizontal

Frequency (MHz)	Meter Reading (dBµV)	Factor (dB)	Emission Level (dBµV/m)	Limits (dBµV/m)	Margin (dB)	Value Type
13050.000	47.55	9.62	57.17	68.20	-11.03	peak
19575.000	41.92	10.75	52.67	74.00	-21.33	peak
19575.000	30.74	10.75	41.49	54.00	-12.51	AVG

Remark:

Factor = Antenna Factor + Cable Loss – Pre-amplifier.

<b>EUT</b>	Mini PC	<b>Model Name</b>	MPC43
<b>Temperature</b>	25° C	<b>Relative Humidity</b>	55.4%
<b>Pressure</b>	960hPa	<b>Test Voltage</b>	Normal Voltage
<b>Test Mode</b>	Mode 23	<b>Antenna</b>	Vertical

Frequency (MHz)	Meter Reading (dBµV)	Factor (dB)	Emission Level (dBµV/m)	Limits (dBµV/m)	Margin (dB)	Value Type
13050.000	46.12	9.62	55.74	68.20	-12.46	peak
19575.000	40.65	10.75	51.40	74.00	-22.60	peak
19575.000	31.59	10.75	42.34	54.00	-11.66	AVG

Remark:

Factor = Antenna Factor + Cable Loss – Pre-amplifier.

Any report having not been signed by authorized approver, or having been altered without authorization, or having not been stamped by the “Dedicated Testing/Inspection Stamp” is deemed to be invalid. Copying or excerpting portion of, or altering the content of the report is not permitted without the written authorization of AGC. The test results presented in the report apply only to the tested sample. Any objections to report issued by AGC should be submitted to AGC within 15days after the issuance of the test report. Further enquiry of validity or verification of the test report should be addressed to AGC by agc01@agccert.com.



<b>EUT</b>	Mini PC	<b>Model Name</b>	MPC43
<b>Temperature</b>	25° C	<b>Relative Humidity</b>	55.4%
<b>Pressure</b>	960hPa	<b>Test Voltage</b>	Normal Voltage
<b>Test Mode</b>	Mode 26	<b>Antenna</b>	Horizontal

Frequency (MHz)	Meter Reading (dBµV)	Factor (dB)	Emission Level (dBµV/m)	Limits (dBµV/m)	Margin (dB)	Value Type
13250.000	46.32	9.62	55.94	74.00	-18.06	peak
13250.000	35.23	9.62	44.85	54.00	-9.15	AVG
19875.000	40.25	10.75	51.00	74.00	-23.00	peak
19875.000	30.59	10.75	41.34	54.00	-12.66	AVG

Remark:

Factor = Antenna Factor + Cable Loss – Pre-amplifier.

<b>EUT</b>	Mini PC	<b>Model Name</b>	MPC43
<b>Temperature</b>	25° C	<b>Relative Humidity</b>	55.4%
<b>Pressure</b>	960hPa	<b>Test Voltage</b>	Normal Voltage
<b>Test Mode</b>	Mode 26	<b>Antenna</b>	Vertical

Frequency (MHz)	Meter Reading (dBµV)	Factor (dB)	Emission Level (dBµV/m)	Limits (dBµV/m)	Margin (dB)	Value Type
13250.000	47.61	9.62	57.23	74.00	-16.77	peak
13250.000	35.94	9.62	45.56	54.00	-8.44	AVG
19875.000	41.22	10.75	51.97	74.00	-22.03	peak
19875.000	29.67	10.75	40.42	54.00	-13.58	AVG

Remark:

Factor = Antenna Factor + Cable Loss – Pre-amplifier.

Any report having not been signed by authorized approver, or having been altered without authorization, or having not been stamped by the “Dedicated Testing/Inspection Stamp” is deemed to be invalid. Copying or excerpting portion of, or altering the content of the report is not permitted without the written authorization of AGC. The test results presented in the report apply only to the tested sample. Any objections to report issued by AGC should be submitted to AGC within 15days after the issuance of the test report. Further enquiry of validity or verification of the test report should be addressed to AGC by agc01@agccert.com.

<b>EUT</b>	Mini PC	<b>Model Name</b>	MPC43
<b>Temperature</b>	25° C	<b>Relative Humidity</b>	55.4%
<b>Pressure</b>	960hPa	<b>Test Voltage</b>	Normal Voltage
<b>Test Mode</b>	Mode 28	<b>Antenna</b>	Horizontal

Frequency (MHz)	Meter Reading (dBμV)	Factor (dB)	Emission Level (dBμV/m)	Limits (dBμV/m)	Margin (dB)	Value Type
13330.000	45.23	9.62	54.85	74.00	-19.15	peak
13330.000	34.59	9.62	44.21	54.00	-9.79	AVG
19995.000	40.94	10.75	51.69	74.00	-22.31	peak
19995.000	29.96	10.75	40.71	54.00	-13.29	AVG

Remark:

Factor = Antenna Factor + Cable Loss – Pre-amplifier.

<b>EUT</b>	Mini PC	<b>Model Name</b>	MPC43
<b>Temperature</b>	25° C	<b>Relative Humidity</b>	55.4%
<b>Pressure</b>	960hPa	<b>Test Voltage</b>	Normal Voltage
<b>Test Mode</b>	Mode 28	<b>Antenna</b>	Vertical

Frequency (MHz)	Meter Reading (dBμV)	Factor (dB)	Emission Level (dBμV/m)	Limits (dBμV/m)	Margin (dB)	Value Type
13330.000	46.58	9.62	56.20	74.00	-17.80	peak
13330.000	36.13	9.62	45.75	54.00	-8.25	AVG
19995.000	41.74	10.75	52.49	74.00	-21.51	peak
19995.000	32.49	10.75	43.24	54.00	-10.76	AVG

Remark:

Factor = Antenna Factor + Cable Loss – Pre-amplifier.

Any report having not been signed by authorized approver, or having been altered without authorization, or having not been stamped by the “Dedicated Testing/Inspection Stamp” is deemed to be invalid. Copying or excerpting portion of, or altering the content of the report is not permitted without the written authorization of AGC. The test results presented in the report apply only to the tested sample. Any objections to report issued by AGC should be submitted to AGC within 15days after the issuance of the test report. Further enquiry of validity or verification of the test report should be addressed to AGC by agc01@agccert.com.

<b>EUT</b>	Mini PC	<b>Model Name</b>	MPC43
<b>Temperature</b>	25° C	<b>Relative Humidity</b>	55.4%
<b>Pressure</b>	960hPa	<b>Test Voltage</b>	Normal Voltage
<b>Test Mode</b>	Mode 29	<b>Antenna</b>	Horizontal

Frequency (MHz)	Meter Reading (dBμV)	Factor (dB)	Emission Level (dBμV/m)	Limits (dBμV/m)	Margin (dB)	Value Type
13750.000	45.26	9.62	54.88	68.20	-13.32	peak
20625.000	41.58	10.75	52.33	74.00	-21.67	peak
20625.000	30.59	10.75	41.34	54.00	-12.66	AVG

Remark:

Factor = Antenna Factor + Cable Loss – Pre-amplifier.

<b>EUT</b>	Mini PC	<b>Model Name</b>	MPC43
<b>Temperature</b>	25° C	<b>Relative Humidity</b>	55.4%
<b>Pressure</b>	960hPa	<b>Test Voltage</b>	Normal Voltage
<b>Test Mode</b>	Mode 29	<b>Antenna</b>	Vertical

Frequency (MHz)	Meter Reading (dBμV)	Factor (dB)	Emission Level (dBμV/m)	Limits (dBμV/m)	Margin (dB)	Value Type
13750.000	46.33	9.62	55.95	68.20	-12.25	peak
20625.000	41.53	10.75	52.28	74.00	-21.72	peak
20625.000	30.74	10.75	41.49	54.00	-12.51	AVG

Remark:

Factor = Antenna Factor + Cable Loss – Pre-amplifier.

Any report having not been signed by authorized approver, or having been altered without authorization, or having not been stamped by the “Dedicated Testing/Inspection Stamp” is deemed to be invalid. Copying or excerpting portion of, or altering the content of the report is not permitted without the written authorization of AGC. The test results presented in the report apply only to the tested sample. Any objections to report issued by AGC should be submitted to AGC within 15days after the issuance of the test report. Further enquiry of validity or verification of the test report should be addressed to AGC by agc01@agccert.com.

<b>EUT</b>	Mini PC	<b>Model Name</b>	MPC43
<b>Temperature</b>	25° C	<b>Relative Humidity</b>	55.4%
<b>Pressure</b>	960hPa	<b>Test Voltage</b>	Normal Voltage
<b>Test Mode</b>	Mode 33	<b>Antenna</b>	Horizontal

Frequency (MHz)	Meter Reading (dBµV)	Factor (dB)	Emission Level (dBµV/m)	Limits (dBµV/m)	Margin (dB)	Value Type
13770.000	45.21	9.62	54.83	68.20	-13.37	peak
20655.000	40.15	10.75	50.90	74.00	-23.10	peak
20655.000	29.76	10.75	40.51	54.00	-13.49	AVG

Remark:

Factor = Antenna Factor + Cable Loss – Pre-amplifier.

<b>EUT</b>	Mini PC	<b>Model Name</b>	MPC43
<b>Temperature</b>	25° C	<b>Relative Humidity</b>	55.4%
<b>Pressure</b>	960hPa	<b>Test Voltage</b>	Normal Voltage
<b>Test Mode</b>	Mode 33	<b>Antenna</b>	Vertical

Frequency (MHz)	Meter Reading (dBµV)	Factor (dB)	Emission Level (dBµV/m)	Limits (dBµV/m)	Margin (dB)	Value Type
13770.000	46.24	9.62	55.86	68.20	-12.34	peak
20655.000	40.95	10.75	51.70	74.00	-22.30	peak
20655.000	31.67	10.75	42.42	54.00	-11.58	AVG

Remark:

Factor = Antenna Factor + Cable Loss – Pre-amplifier.

Any report having not been signed by authorized approver, or having been altered without authorization, or having not been stamped by the “Dedicated Testing/Inspection Stamp” is deemed to be invalid. Copying or excerpting portion of, or altering the content of the report is not permitted without the written authorization of AGC. The test results presented in the report apply only to the tested sample. Any objections to report issued by AGC should be submitted to AGC within 15days after the issuance of the test report. Further enquiry of validity or verification of the test report should be addressed to AGC by agc01@agccert.com.

<b>EUT</b>	Mini PC	<b>Model Name</b>	MPC43
<b>Temperature</b>	25° C	<b>Relative Humidity</b>	55.4%
<b>Pressure</b>	960hPa	<b>Test Voltage</b>	Normal Voltage
<b>Test Mode</b>	Mode 35	<b>Antenna</b>	Horizontal

Frequency (MHz)	Meter Reading (dBµV)	Factor (dB)	Emission Level (dBµV/m)	Limits (dBµV/m)	Margin (dB)	Value Type
13730.000	43.25	9.62	52.87	68.20	-15.33	peak
20595.000	39.64	10.75	50.39	74.00	-23.61	peak
20595.000	28.45	10.75	39.20	54.00	-14.80	AVG

Remark:

Factor = Antenna Factor + Cable Loss – Pre-amplifier.

<b>EUT</b>	Mini PC	<b>Model Name</b>	MPC43
<b>Temperature</b>	25° C	<b>Relative Humidity</b>	55.4%
<b>Pressure</b>	960hPa	<b>Test Voltage</b>	Normal Voltage
<b>Test Mode</b>	Mode 35	<b>Antenna</b>	Vertical

Frequency (MHz)	Meter Reading (dBµV)	Factor (dB)	Emission Level (dBµV/m)	Limits (dBµV/m)	Margin (dB)	Value Type
13730.000	45.23	9.62	54.85	68.20	-13.35	peak
20595.000	41.55	10.75	52.30	74.00	-21.70	peak
20595.000	31.54	10.75	42.29	54.00	-11.71	AVG

Remark:

Factor = Antenna Factor + Cable Loss – Pre-amplifier.

Any report having not been signed by authorized approver, or having been altered without authorization, or having not been stamped by the “Dedicated Testing/Inspection Stamp” is deemed to be invalid. Copying or excerpting portion of, or altering the content of the report is not permitted without the written authorization of AGC. The test results presented in the report apply only to the tested sample. Any objections to report issued by AGC should be submitted to AGC within 15days after the issuance of the test report. Further enquiry of validity or verification of the test report should be addressed to AGC by agc01@agccert.com.

<b>EUT</b>	Mini PC	<b>Model Name</b>	MPC43
<b>Temperature</b>	25° C	<b>Relative Humidity</b>	55.4%
<b>Pressure</b>	960hPa	<b>Test Voltage</b>	Normal Voltage
<b>Test Mode</b>	Mode 38	<b>Antenna</b>	Horizontal

Frequency (MHz)	Meter Reading (dBμV)	Factor (dB)	Emission Level (dBμV/m)	Limits (dBμV/m)	Margin (dB)	Value Type
13970.000	44.86	9.62	54.48	68.20	-13.72	peak
20955.000	39.48	10.75	50.23	74.00	-23.77	peak
20955.000	29.14	10.75	39.89	54.00	-14.11	AVG

Remark:  
Factor = Antenna Factor + Cable Loss – Pre-amplifier.

<b>EUT</b>	Mini PC	<b>Model Name</b>	MPC43
<b>Temperature</b>	25° C	<b>Relative Humidity</b>	55.4%
<b>Pressure</b>	960hPa	<b>Test Voltage</b>	Normal Voltage
<b>Test Mode</b>	Mode 38	<b>Antenna</b>	Vertical

Frequency (MHz)	Meter Reading (dBμV)	Factor (dB)	Emission Level (dBμV/m)	Limits (dBμV/m)	Margin (dB)	Value Type
13970.000	45.22	9.62	54.84	68.20	-13.36	peak
20955.000	41.05	10.75	51.80	74.00	-22.20	peak
20955.000	30.57	10.75	41.32	54.00	-12.68	AVG

Remark:  
Factor = Antenna Factor + Cable Loss – Pre-amplifier.

**RESULT: PASS**

**Note:**

1. The amplitude of other spurious emissions from 1G to 25 GHz which are attenuated more than 20 dB below the permissible value need not be reported.
2. Factor = Antenna Factor + Cable loss - Amplifier gain, Margin=Measure Result-Limit.
3. The “Factor” value can be calculated automatically by software of measurement system.
4. All test modes had been pre-tested. The mode 1/4/7/10/12/15/17/19/20/23/26/28/29/33/35/38 is the worst case and recorded in the report.

Any report having not been signed by authorized approver, or having been altered without authorization, or having not been stamped by the “Dedicated Testing/Inspection Stamp” is deemed to be invalid. Copying or excerpting portion of, or altering the content of the report is not permitted without the written authorization of AGC. The test results presented in the report apply only to the tested sample. Any objections to report issued by AGC should be submitted to AGC within 15days after the issuance of the test report. Further enquiry of validity or verification of the test report should be addressed to AGC by agc01@agccert.com.

**Test result for band edge emission at restricted bands**

Note: Please refer to the module RF report No.: (201120-01.TR38).

Any report having not been signed by authorized approver, or having been altered without authorization, or having not been stamped by the “Dedicated Testing/Inspection Stamp” is deemed to be invalid. Copying or excerpting portion of, or altering the content of the report is not permitted without the written authorization of AGC. The test results presented in the report apply only to the tested sample. Any objections to report issued by AGC should be submitted to AGC within 15days after the issuance of the test report. Further enquiry of validity or verification of the test report should be addressed to AGC by [agc01@agccert.com](mailto:agc01@agccert.com).

Attestation of Global Compliance(Shenzhen)Co., Ltd  
Attestation of Global Compliance(Shenzhen)Std & Tech Co., Ltd  
Tel: +86-755 2523 4088 E-mail: [agc@agccert.com](mailto:agc@agccert.com) Web: <http://www.agccert.com/>



## 12. AC POWER LINE CONDUCTED EMISSION TEST

### 12.1 LIMITS OF LINE CONDUCTED EMISSION TEST

Frequency	Maximum RF Line Voltage	
	Q.P. (dB $\mu$ V)	Average (dB $\mu$ V)
150kHz~500kHz	66-56	56-46
500kHz~5MHz	56	46
5MHz~30MHz	60	50

Note:

1. The lower limit shall apply at the transition frequency.
2. The limit decreases linearly with the logarithm of the frequency in the range 0.15 MHz to 0.50 MHz.

### 12.2 MEASUREMENT SETUP (BLOCK DIAGRAM OF CONFIGURATION)

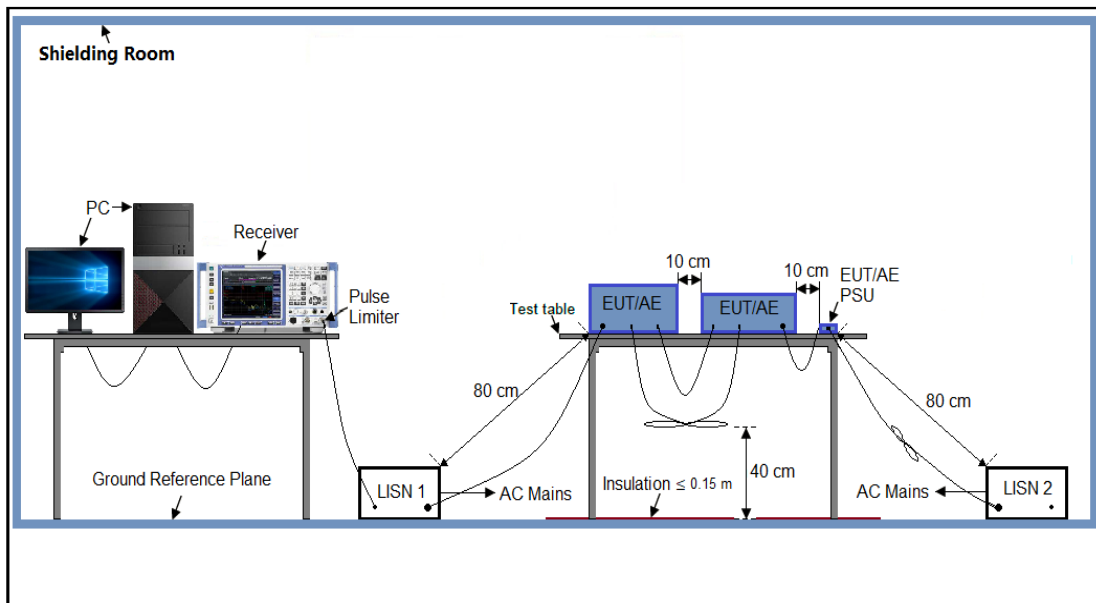

Any report having not been signed by authorized approver, or having been altered without authorization, or having not been stamped by the "Dedicated Testing/Inspection Stamp" is deemed to be invalid. Copying or excerpting portion of, or altering the content of the report is not permitted without the written authorization of AGC. The test results presented in the report apply only to the tested sample. Any objections to report issued by AGC should be submitted to AGC within 15days after the issuance of the test report. Further enquiry of validity or verification of the test report should be addressed to AGC by agc01@agccert.com.

### 12.3 PRELIMINARY PROCEDURE OF LINE CONDUCTED EMISSION TEST

1. The equipment was set up as per the test configuration to simulate typical actual usage per the user's manual. When the EUT is a tabletop system, a wooden table with a height of 0.8 meters is used and is placed on the ground plane as per ANSI C63.10 (see Test Facility for the dimensions of the ground plane used). When the EUT is a floor-standing equipment, it is placed on the ground plane which has a 3-12 mm non-conductive covering to insulate the EUT from the ground plane.
2. Support equipment, if needed, was placed as per ANSI C63.10.
3. All I/O cables were positioned to simulate typical actual usage as per ANSI C63.10.
4. All support equipment received AC120V/60Hz power from a LISN, if any.
5. The EUT received DC 5V power from adapter which received AC120V/60Hz power from a LISN.
6. The test program was started. Emissions were measured on each current carrying line of the EUT using a spectrum Analyzer / Receiver connected to the LISN powering the EUT. The LISN has two monitoring points: Line 1 (Hot Side) and Line 2 (Neutral Side). Two scans were taken: one with Line 1 connected to Analyzer / Receiver and Line 2 connected to a 50 ohm load; the second scan had Line 1 connected to a 50 ohm load and Line 2 connected to the Analyzer / Receiver.
7. Analyzer / Receiver scanned from 150 kHz to 30MHz for emissions in each of the test modes.
8. During the above scans, the emissions were maximized by cable manipulation.
9. The test mode(s) were scanned during the preliminary test.

Then, the EUT configuration and cable configuration of the above highest emission level were recorded for reference of final testing.

### 11.4 FINAL PROCEDURE OF LINE CONDUCTED EMISSION TEST

1. EUT and support equipment was set up on the test bench as per step 2 of the preliminary test.
2. A scan was taken on both power lines, Line 1 and Line 2, recording at least the six highest emissions. Emission frequency and amplitude were recorded into a computer in which correction factors were used to calculate the emission level and compare reading to the applicable limit. If EUT emission level was less -2dB to the A.V. limit in Peak mode, then the emission signal was re-checked using Q.P and Average detector.
3. The test data of the worst case condition(s) was reported on the Summary Data page.

### 11.5 MEASUREMENT RESULTS

Any report having not been signed by authorized approver, or having been altered without authorization, or having not been stamped by the "Dedicated Testing/Inspection Stamp" is deemed to be invalid. Copying or excerpting portion of, or altering the content of the report is not permitted without the written authorization of AGC. The test results presented in the report apply only to the tested sample. Any objections to report issued by AGC should be submitted to AGC within 15days after the issuance of the test report. Further enquiry of validity or verification of the test report should be addressed to AGC by [agc01@agccert.com](mailto:agc01@agccert.com).

**AC POWER LINE CONDUCTED EMISSION TEST**

Test Mode	Mode 1	LISN line	Hot Side
-----------	--------	-----------	----------

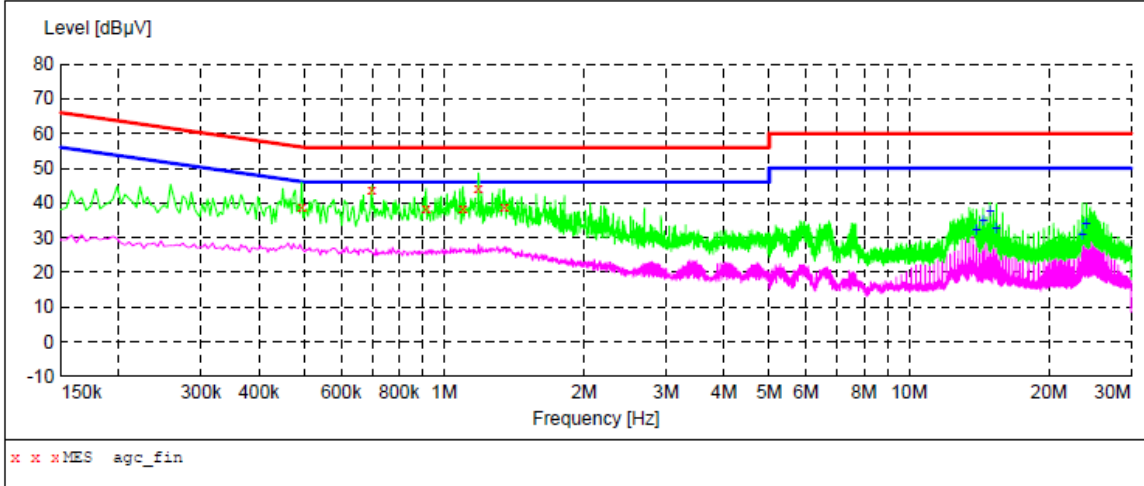

**MEASUREMENT RESULT: "agc\_fin"**

2023/6/26 9:55

Frequency MHz	Level dBµV	Transd dB	Limit dBµV	Margin dB	Detector	Line
0.494000	38.60	6.1	56	17.5	QP	L1
0.698000	43.50	6.2	56	12.5	QP	L1
0.914000	38.10	6.2	56	17.9	QP	L1
1.098000	38.30	6.2	56	17.7	QP	L1
1.186000	44.20	6.2	56	11.8	QP	L1
1.346000	38.70	6.2	56	17.3	QP	L1

**MEASUREMENT RESULT: "agc\_fin2"**

2023/6/26 9:54

Frequency MHz	Level dBµV	Transd dB	Limit dBµV	Margin dB	Detector	Line
13.950000	31.90	6.9	50	18.1	AV	L1
14.430000	34.70	6.9	50	15.3	AV	L1
14.910000	37.20	6.9	50	12.8	AV	L1
15.394000	32.30	6.9	50	17.7	AV	L1
23.570000	30.90	8.2	50	19.1	AV	L1
24.050000	33.70	8.3	50	16.3	AV	L1

**RESULT: PASS**

Any report having not been signed by authorized approver, or having been altered without authorization, or having not been stamped by the "Dedicated Testing/Inspection Stamp" is deemed to be invalid. Copying or excerpting portion of, or altering the content of the report is not permitted without the written authorization of AGC. The test results presented in the report apply only to the tested sample. Any objections to report issued by AGC should be submitted to AGC within 15days after the issuance of the test report. Further enquiry of validity or verification of the test report should be addressed to AGC by agc01@agccert.com.

**AC POWER LINE CONDUCTED EMISSION TEST**

Test Mode	Mode 1	LISN line	Neutral Side
-----------	--------	-----------	--------------

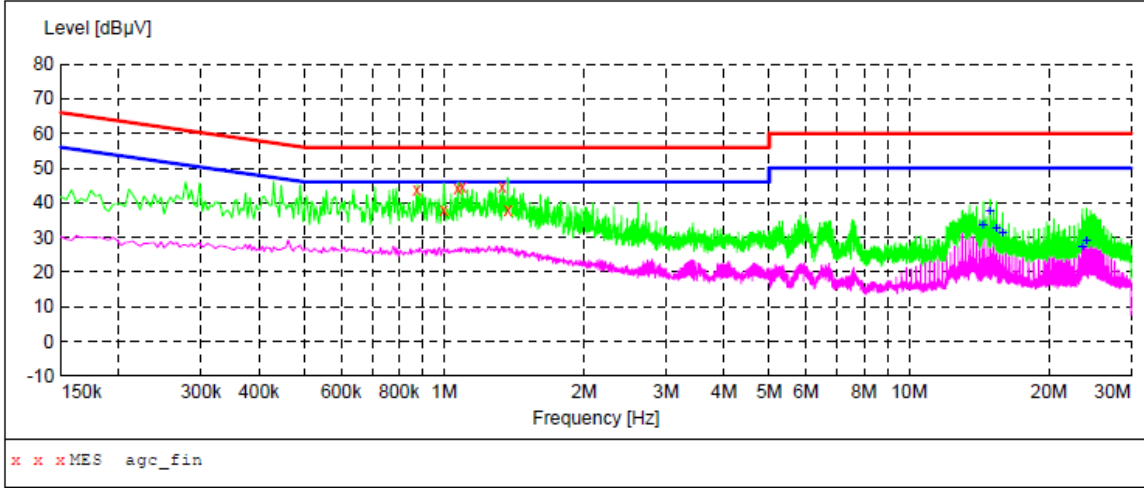

**MEASUREMENT RESULT: "agc\_fin"**

2023/6/26 9:50

Frequency MHz	Level dBµV	Transd dB	Limit dBµV	Margin dB	Detector	Line
0.874000	43.90	6.2	56	12.1	QP	N
0.998000	38.10	6.2	56	17.9	QP	N
1.070000	44.40	6.2	56	11.6	QP	N
1.094000	44.80	6.2	56	11.2	QP	N
1.334000	44.70	6.2	56	11.3	QP	N
1.370000	38.10	6.2	56	17.9	QP	N

**MEASUREMENT RESULT: "agc\_fin2"**

2023/6/26 9:49

Frequency MHz	Level dBµV	Transd dB	Limit dBµV	Margin dB	Detector	Line
14.438000	33.60	6.9	50	16.4	AV	N
14.918000	37.40	6.9	50	12.6	AV	N
15.402000	32.50	6.9	50	17.5	AV	N
15.882000	31.00	7.0	50	19.0	AV	N
23.582000	27.30	8.2	50	22.7	AV	N
24.062000	28.80	8.3	50	21.2	AV	N

**RESULT: PASS**

Any report having not been signed by authorized approver, or having been altered without authorization, or having not been stamped by the "Dedicated Testing/Inspection Stamp" is deemed to be invalid. Copying or excerpting portion of, or altering the content of the report is not permitted without the written authorization of AGC. The test results presented in the report apply only to the tested sample. Any objections to report issued by AGC should be submitted to AGC within 15days after the issuance of the test report. Further enquiry of validity or verification of the test report should be addressed to AGC by agc01@agccert.com.

**APPENDIX I: PHOTOGRAPHS OF TEST SETUP**

Refer to the Report No.: AGC12060230401AP02

**APPENDIX II: PHOTOGRAPHS OF TEST EUT**

Refer to the Report No.: AGC12060230401AP03

**-----END OF REPORT-----**

Any report having not been signed by authorized approver, or having been altered without authorization, or having not been stamped by the "Dedicated Testing/Inspection Stamp" is deemed to be invalid. Copying or excerpting portion of, or altering the content of the report is not permitted without the written authorization of AGC. The test results presented in the report apply only to the tested sample. Any objections to report issued by AGC should be submitted to AGC within 15days after the issuance of the test report. Further enquiry of validity or verification of the test report should be addressed to AGC by [agc01@agccert.com](mailto:agc01@agccert.com).

Attestation of Global Compliance(Shenzhen)Co., Ltd  
Attestation of Global Compliance(Shenzhen)Std & Tech Co., Ltd  
Tel: +86-755 2523 4088 E-mail: [agc@agccert.com](mailto:agc@agccert.com) Web: <http://www.agccert.com/>



## Conditions of Issuance of Test Reports

1. All samples and goods are accepted by the Attestation of Global Compliance (Shenzhen) Co., Ltd (the “Company”) solely for testing and reporting in accordance with the following terms and conditions. The company provides its services on the basis that such terms and conditions constitute express agreement between the company and any person, firm or company requesting its services (the “Clients”).
2. Any report issued by Company as a result of this application for testing services (the “Report”) shall be issued in confidence to the Clients and the Report will be strictly treated as such by the Company. It may not be reproduced either in its entirety or in part and it may not be used for advertising or other unauthorized purposes without the written consent of the Company. The Clients to whom the Report is issued may, however, show or send it, or a certified copy thereof prepared by the Company to its customer, supplier or other persons directly concerned. The Company will not, without the consent of the Clients, enter into any discussion or correspondence with any third party concerning the contents of the Report, unless required by the relevant governmental authorities, laws or court orders.
3. The Company shall not be called or be liable to be called to give evidence or testimony on the Report in a court of law without its prior written consent, unless required by the relevant governmental authorities, laws or court orders.
4. In the event of the improper use of the report as determined by the Company, the Company reserves the right to withdraw it, and to adopt any other additional remedies which may be appropriate.
5. Samples submitted for testing are accepted on the understanding that the Report issued cannot form the basis of, or be the instrument for, any legal action against the Company.
6. The Company will not be liable for or accept responsibility for any loss or damage however arising from the use of information contained in any of its Reports or in any communication whatsoever about its said tests or investigations.
7. Clients wishing to use the Report in court proceedings or arbitration shall inform the Company to that effect prior to submitting the sample for testing.
8. The Company is not responsible for recalling the electronic version of the original report when any revision is made to them. The Client assumes the responsibility to providing the revised version to any interested party who uses them.
9. Subject to the variable length of retention time for test data and report stored hereinto as otherwise specifically required by individual accreditation authorities, the Company will only keep the supporting test data and information of the test report for a period of six years. The data and information will be disposed of after the aforementioned retention period has elapsed. Under no circumstances shall we provide any data and information which has been disposed of after retention period. Under no circumstances shall we be liable for damage of any kind, including (but not limited to) compensatory damages, lost profits, lost data, or any form of special, incidental, indirect, consequential or punitive damages of any kind, whether based on breach of contract of warranty, tort (including negligence), product liability or otherwise, even if we are informed in advance of the possibility of such damages.

Any report having not been signed by authorized approver, or having been altered without authorization, or having not been stamped by the “Dedicated Testing/Inspection Stamp” is deemed to be invalid. Copying or excerpting portion of, or altering the content of the report is not permitted without the written authorization of AGC. The test results presented in the report apply only to the tested sample. Any objections to report issued by AGC should be submitted to AGC within 15days after the issuance of the test report. Further enquiry of validity or verification of the test report should be addressed to AGC by [agc01@agccert.com](mailto:agc01@agccert.com).