

# TEST REPORT

Report No.: BCTC2303402211-1E

---

Applicant: Shenzhen CWC Technology Co.,Ltd

---

Product Name: PVC wireless charging

---

Model/Type Ref.: PVC-W001

---

Tested Date: 2023-03-29 to 2023-04-07

---

Issued Date: 2023-04-07

---

**Shenzhen BCTC Testing Co., Ltd.**



SHENZHEN

# FCC ID: 2BAWN-PVC-W001

Product Name: PVC wireless charging  
Trademark: N/A  
Model/Type Ref.: PVC-W001  
PVC-W002, PVC-W003, PVC-W004, PVC-W005, PVC-W006, PVC-W007, PVC-W008, PVC-W009, PVC-W0010, PVC-W0011  
Prepared For: Shenzhen CWC Technology Co.,Ltd  
Address: Room 602, Building A, Zhihuigu innovation park, No.8 Fada Road, Bantian, Longgang, Shenzhen 518129, China  
Manufacturer: ShenZhen CWC Industrial Co.,Ltd  
Address: zone B, 5 building, mei'jia'mei industrial park, guiyue road, guanlan street, longhua, shenzhen, China  
Prepared By: Shenzhen BCTC Testing Co., Ltd.  
Address: 1-2/F., Building B, Pengzhou Industrial Park, No.158, Fuyuan 1st Road, Zhancheng, Fuhai Subdistrict, Bao'an District, Shenzhen, Guangdong, China  
Sample Received Date: 2023-03-29  
Sample tested Date: 2023-03-29 to 2023-04-07  
Issue Date: 2023-04-07  
Report No.: BCTC2303402211-1E  
Test Standards: FCC Part15.209  
ANSI C63.10-2013  
Test Results: PASS

Tested by:



Lei Chen/Project Handler

Approved by:



Zero Zhou/Reviewer

The test report is effective only with both signature and specialized stamp. This result(s) shown in this report refer only to the sample(s) tested. Without written approval of Shenzhen BCTC Testing Co., Ltd, this report can't be reproduced except in full. The tested sample(s) and the sample information are provided by the client.

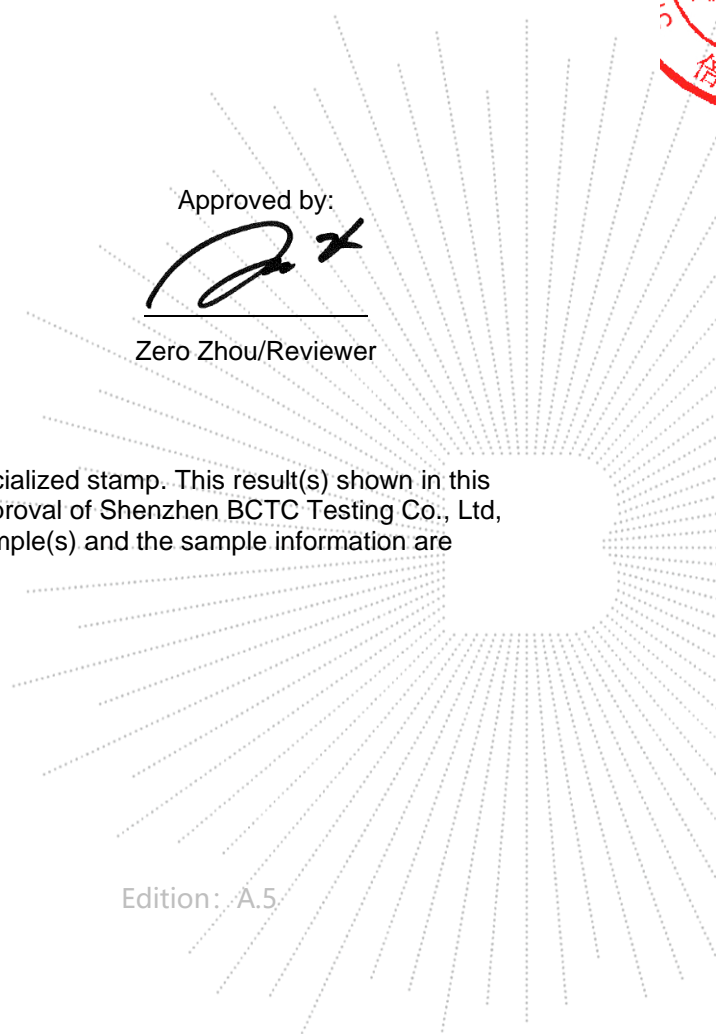

## Table Of Content

Test Report Declaration	Page
1. Version .....	4
2. Test Summary .....	5
3. Measurement Uncertainty .....	6
4. Product Information And Test Setup .....	7
4.1 Product Information .....	7
4.2 Support Equipment .....	7
4.3 Test Setup Configuration .....	8
4.4 Test Mode .....	8
5. Test Facility And Test Instrument Used .....	9
5.1 Test Facility .....	9
5.2 Test Instrument Used .....	9
6. Conducted Emissions .....	11
6.1 Block Diagram Of Test Setup .....	11
6.2 Limit .....	11
6.3 Test Procedure .....	11
6.4 EUT Operating Conditions .....	11
6.5 Test Result .....	12
7. Radiated Emissions .....	14
7.1 Block Diagram Of Test Setup .....	14
7.2 Limit .....	15
7.3 Test Procedure .....	15
7.4 Test Result .....	16
8. Bandwidth Test .....	20
9. Antenna Requirements .....	22
10. EUT Photographs .....	23
11. EUT Test Setup Photographs .....	24

(Note: N/A Means Not Applicable)

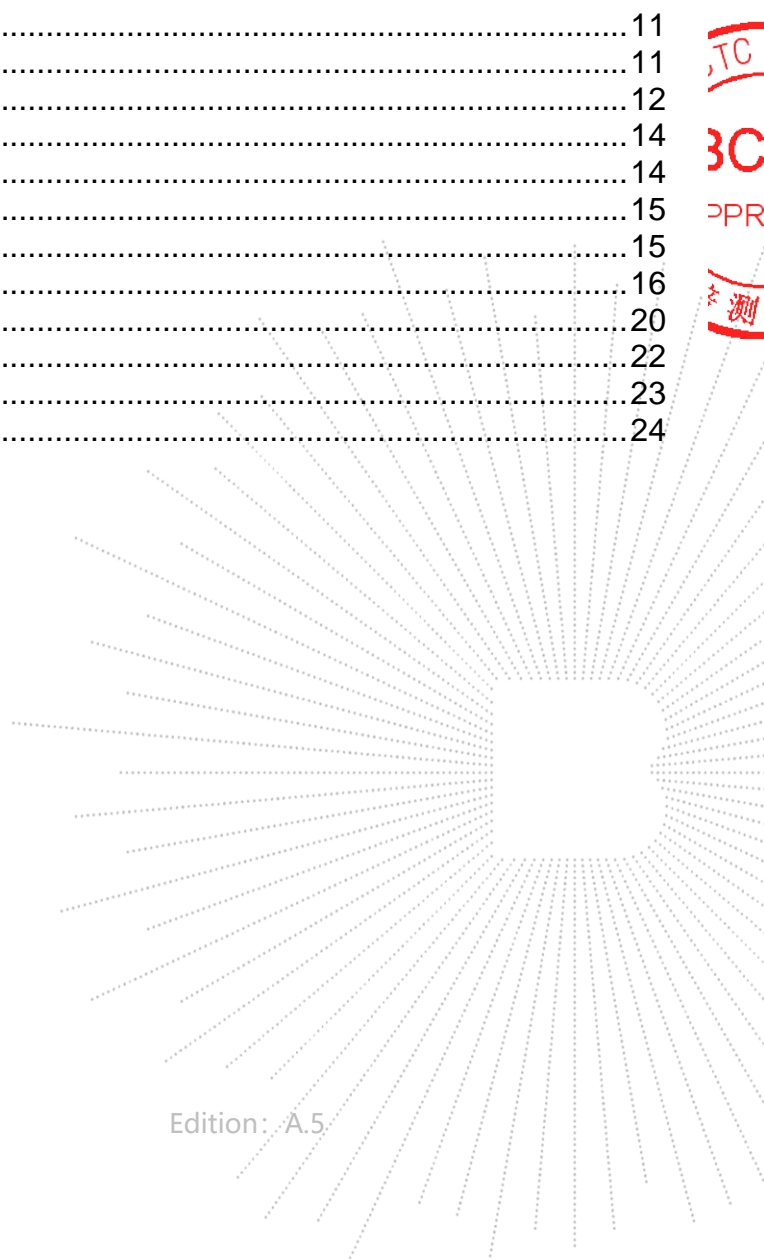

TC  
3C  
PPR  
测

**1. Version**

Report No.	Issue Date	Description	Approved
BCTC2303402211-1E	2023-04-07	Original	Valid

TEC  
TC  
OVER  
检

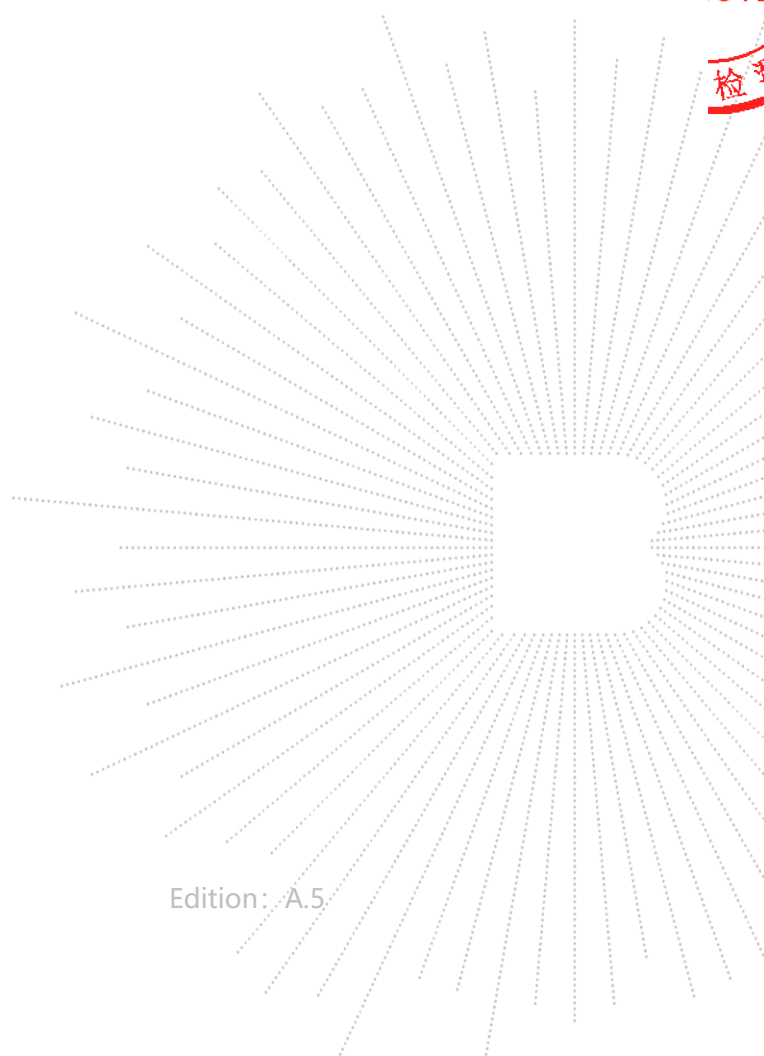

## 2. Test Summary

The Product has been tested according to the following specifications:

No.	Test Parameter	Clause No	Results
1	Conducted Emission	15.207	PASS
2	Radiated Emission	15.209	PASS
3	20dB Bandwidth	15.215	PASS
4	Antenna Requirement	15.203	PASS

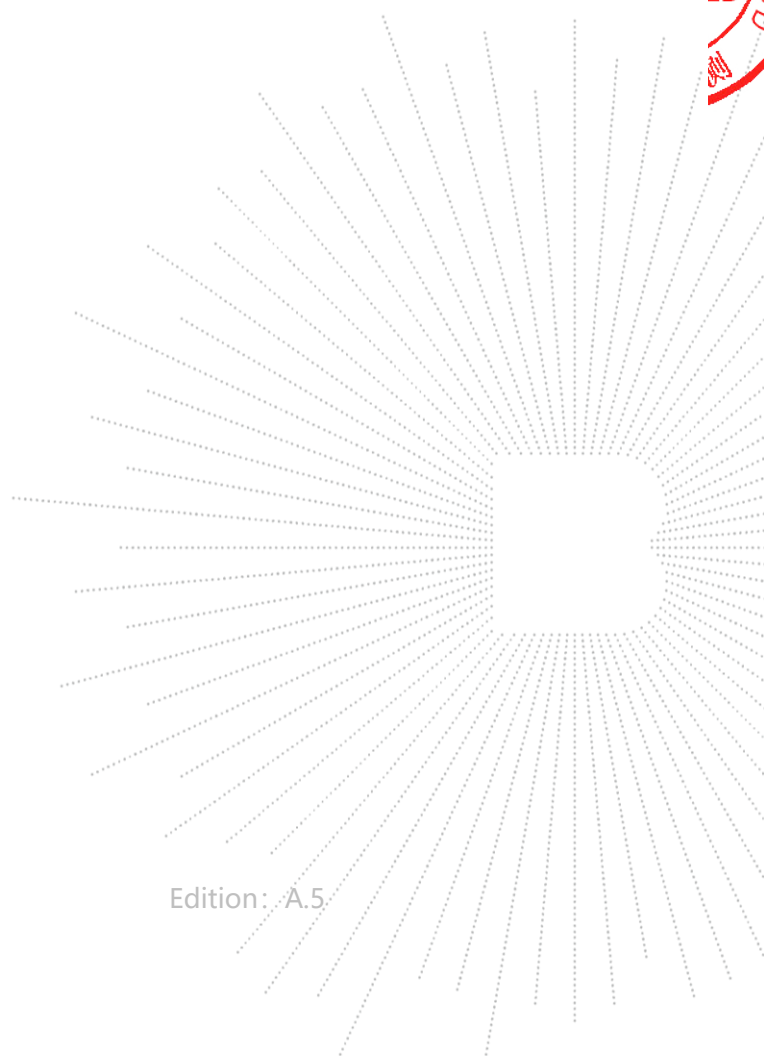

### 3. Measurement Uncertainty

Where relevant, the following measurement uncertainty levels have been estimated for tests performed on the Product as specified in CISPR 16-4-2. This uncertainty represents an expanded uncertainty expressed at approximately the 95% confidence level using a coverage factor of  $k=2$ .

No.	Item	Uncertainty
1	3m chamber Radiated spurious emission(9kHz-30MHz)	U=3.7dB
2	3m chamber Radiated spurious emission(30MHz-1GHz)	U=4.3dB
3	3m chamber Radiated spurious emission(1GHz-18GHz)	U=4.5dB
4	3m chamber Radiated spurious emission(18GHz-40GHz)	U=3.34dB
5	Conducted Emission(150kHz-30MHz)	U=3.20dB
6	Conducted Adjacent channel power	U=1.38dB
7	Conducted output power uncertainty Above 1G	U=1.576dB
8	Conducted output power uncertainty below 1G	U=1.28dB
9	humidity uncertainty	U=5.3%
10	Temperature uncertainty	U=0.59°C

CO.LTD

## 4. Product Information And Test Setup

### 4.1 Product Information

Model/Type Ref.:	PVC-W001 PVC-W002, PVC-W003, PVC-W004, PVC-W005, PVC-W006, PVC-W007, PVC-W008, PVC-W009, PVC-W0010, PVC-W0011
Model differences:	All the model are the same circuit and RF module, except model names and appearance.
Product Description:	PVC wireless charging
Operation Frequency:	115kHz-205kHz
Antenna installation:	loop coil antenna
Ratings:	Type-C Input: DC 5V/2A, 9V/2A, 12V/2A Wireless Charger Output: 5W, 7.5W, 10W, 15W

Cable of Product

No.	Cable Type	Quantity	Provider	Length (m)	Shielded	Note
1	--	--	Applicant	---	Yes/No	With a ferrite ring in mid Detachable
2	--	--	BCTC	--	Yes/No	--

### 4.2 Support Equipment

No.	Device Type	Brand	Model	Series No.	Note
E-1	PVC wireless charging	N/A	PVC-W001	More models Ref. the 4.1	EUT
E-2	Adapter	N/A	BCTC001	N/A	Auxiliary

Item	Shielded Type	Ferrite Core	Length	Note
C-1	NO	NO	0.5M	DC cable unshielded

#### Notes:

- All the equipment/cables were placed in the worst-case configuration to maximize the emission during the test.
- Grounding was established in accordance with the manufacturer's requirements and conditions for the intended use.

SHENZHEN

### 4.3 Test Setup Configuration

See test photographs attached in *EUT TEST SETUP PHOTOGRAPHS* for the actual connections between Product and support equipment.

Conducted Emission:

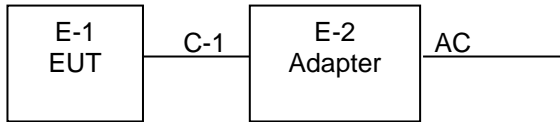

Radiated Spurious Emission

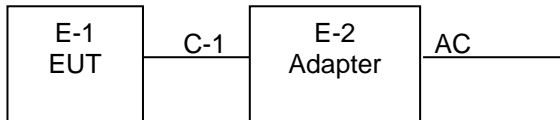

### 4.4 Test Mode

To investigate the maximum EMI emission characteristics generated from EUT, the test system was pre-scanning tested based on the consideration of following EUT operation mode or test configuration mode which possibly have effect on EMI emission level. Each of these EUT operation mode(s) or test configuration mode(s) mentioned above was evaluated respectively.

Test Mode 1	Wireless charger 5W
Test Mode 2	Wireless charger 7.5W
Test Mode 3	Wireless charger 10W
Test Mode 4	Wireless charger 15W

Note:

All test mode were tested and passed, only Conducted Emissions, Radiated Emissions shows (\*) is the worst case mode which were recorded in this report.

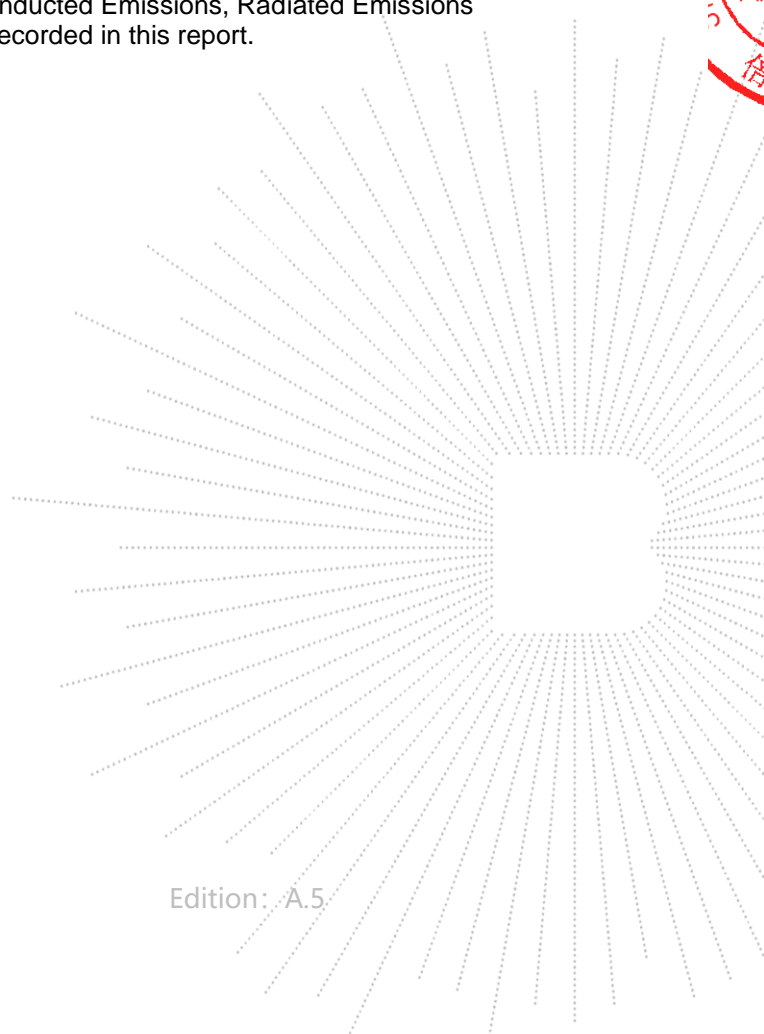



## 5. Test Facility And Test Instrument Used

### 5.1 Test Facility

All measurement facilities used to collect the measurement data are located at Shenzhen BCTC Testing Co., Ltd. Address: 1-2/F., Building B, Pengzhou Industrial Park, No.158, Fuyuan 1st Road, Zhancheng, Fuhai Subdistrict, Bao'an District, Shenzhen, Guangdong, China. The site and apparatus are constructed in conformance with the requirements of ANSI C63.4 and CISPR 16-1-1 other equivalent standards.

FCC Test Firm Registration Number: 712850

A2LA certificate registration number is: CN1212

ISED Registered No.: 23583

ISED CAB identifier: CN0017

### 5.2 Test Instrument Used

Conducted emissions Test					
Equipment	Manufacturer	Model#	Serial#	Last Cal.	Next Cal.
Receiver	R&S	ESR3	102075	May 24, 2022	May 23, 2023
LISN	R&S	ENV216	101375	May 24, 2022	May 23, 2023
Software	Frad	EZ-EMC	EMC-CON 3A1	\	\
Attenuator	\	10dB DC- 6GHz	1650	May 24, 2022	May 23, 2023

RF Conducted Test					
Equipment	Manufacturer	Model#	Serial#	Last Cal.	Next Cal.
Power Metter	Keysight	E4419	\	May 24, 2022	May 23, 2023
Power Sensor (AV)	Keysight	E9300A	\	May 24, 2022	May 23, 2023
Signal Analyzer20kHz- 26.5GHz	Keysight	N9020A	MY49100060	May 24, 2022	May 23, 2023
Spectrum Analyzer9kHz- 40GHz	R&S	FSP40	100363	May 24, 2022	May 23, 2023

TC  
3C  
PPR  
测

Radiated Emissions Test (966 Chamber01)					
Equipment	Manufacturer	Model#	Serial#	Last Cal.	Next Cal.
966 chamber	ChengYu	966 Room	966	Jun. 06. 2020	Jun. 05, 2023
Receiver	R&S	ESR3	102075	May 24, 2022	May 23, 2023
Receiver	R&S	ESRP	101154	May 24, 2022	May 23, 2023
Amplifier	Schwarzbeck	BBV9744	9744-0037	May 24, 2022	May 23, 2023
TRILOG Broadband Antenna	Schwarzbeck	VULB9163	942	May 26, 2022	May 25, 2023
Loop Antenna(9KHz -30MHz)	Schwarzbeck	FMZB1519B	00014	May 26, 2022	May 25, 2023
Amplifier	SKET	LAPA_01G18 G-45dB	\	May 24, 2022	May 23, 2023
Horn Antenna	Schwarzbeck	BBHA9120D	1541	Jun. 06, 2022	Jun. 05, 2023
Amplifier(18G Hz-40GHz)	MITEQ	TTA1840-35- HG	2034381	May 26, 2022	May 25, 2023
Horn Antenna(18G Hz-40GHz)	Schwarzbeck	BBHA9170	00822	Jun. 06, 2022	Jun. 05, 2023
Spectrum Analyzer9kHz- 40GHz	R&S	FSP40	100363	May 24, 2022	May 23, 2023
Software	Frad	EZ-EMC	FA-03A2 RE	\	\

TE  
TC  
OV  
检

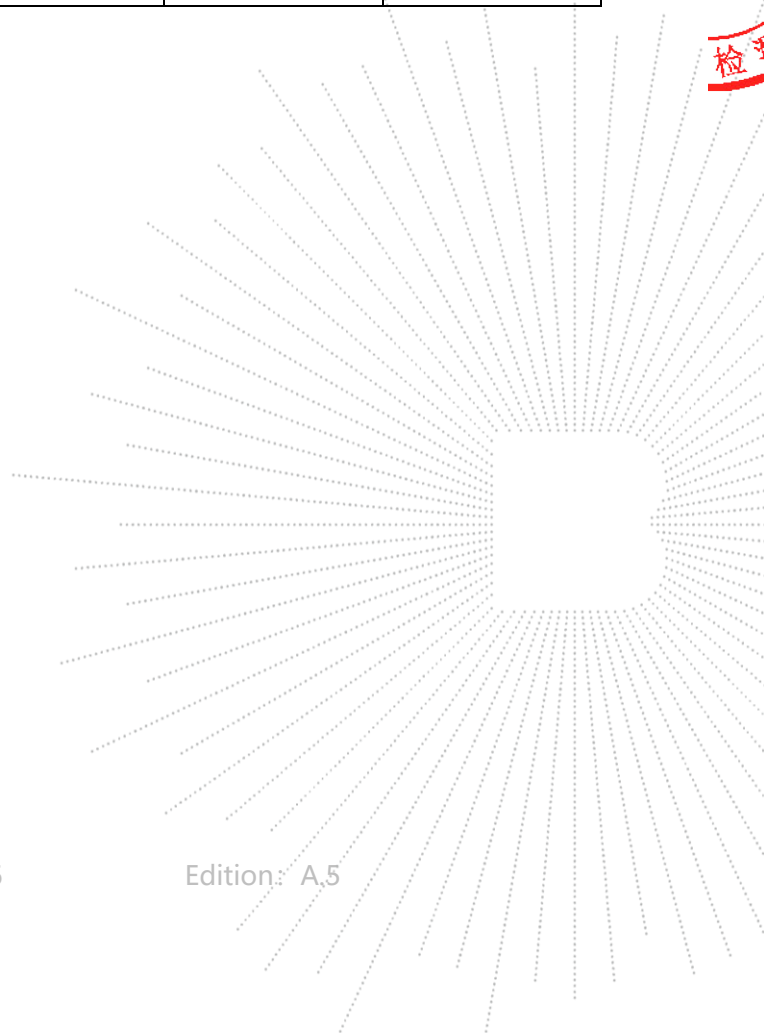

## 6. Conducted Emissions

### 6.1 Block Diagram Of Test Setup



### 6.2 Limit

FREQUENCY (MHz)	Limit (dBuV)	
	Quas-peak	Average
0.15 -0.5	66 - 56 *	56 - 46 *
0.50 -5.0	56.00	46.00
5.0 -30.0	60.00	50.00

Notes:  
 1. \*Decreasing linearly with logarithm of frequency.  
 2. The lower limit shall apply at the transition frequencies.

### 6.3 Test Procedure

Receiver Parameters	Setting
Attenuation	10 dB
Start Frequency	0.15 MHz
Stop Frequency	30 MHz
IF Bandwidth	9 kHz

- The Product was placed on a nonconductive table 0.8 m above the horizontal ground reference plane, and 0.4 m from the vertical ground reference plane, and connected to the main through Line Impedance Stability Network (L.I.S.N).
- The RBW of the receiver was set at 9 kHz in 150 kHz ~ 30MHz with Peak and AVG detector in Max Hold mode. Run the receiver's pre-scan to record the maximum disturbance generated from Product in all power lines in the full band.
- For each frequency whose maximum record was higher or close to limit, measure its QP and AVG values and record.

### 6.4 EUT Operating Conditions

The EUT was configured for testing in a typical fashion (as a customer would normally use it). The EUT has been programmed to continuously transmit during test. This operating condition was tested and used to collect the included data.

## 6.5 Test Result

Temperature:	26 °C	Relative Humidity:	54%
Pressure:	101kPa	Phase :	L
Test Voltage :	AC 120V/60Hz	Test Mode:	Mode 3 (the worst mode)

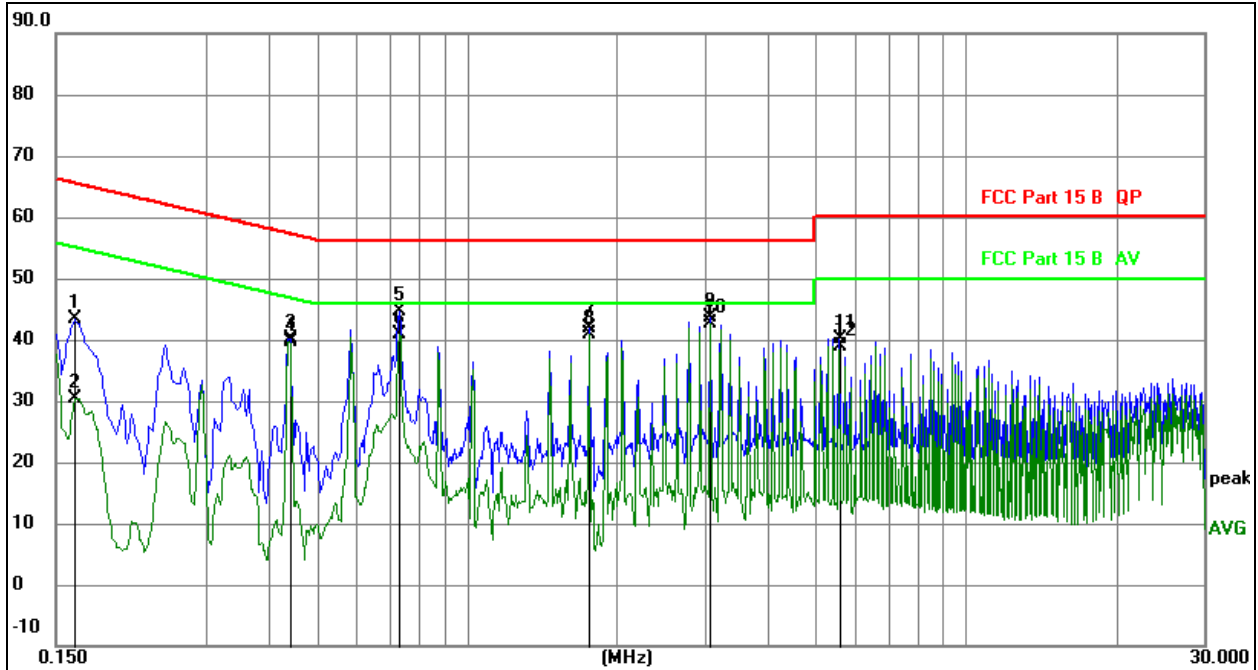

## Remark:

1. All readings are Quasi-Peak and Average values.
2. Factor = Insertion Loss + Cable Loss.
3. Measurement=Reading Level+ Correct Factor
4. Over=Measurement-Limit

No.	Mk.	Freq. MHz	Reading Level	Correct Factor dB	Measure- ment dBuV	Limit dBuV	Over dB	Detector
1		0.1633	23.56	19.70	43.26	65.29	-22.03	QP
2		0.1633	10.72	19.70	30.42	55.29	-24.87	AVG
3		0.4421	20.46	19.74	40.20	57.02	-16.82	QP
4		0.4421	19.78	19.74	39.52	47.02	-7.50	AVG
5		0.7313	24.86	19.74	44.60	56.00	-11.40	QP
6		0.7313	21.20	19.74	40.94	46.00	-5.06	AVG
7		1.7529	22.05	19.85	41.90	56.00	-14.10	QP
8		1.7529	21.11	19.85	40.96	46.00	-5.04	AVG
9		3.0738	23.52	20.00	43.52	56.00	-12.48	QP
10	*	3.0738	22.52	20.00	42.52	46.00	-3.48	AVG
11		5.5641	19.97	20.14	40.11	60.00	-19.89	QP
12		5.5641	18.76	20.14	38.90	50.00	-11.10	AVG

CO., LTD

Temperature:	26 °C	Relative Humidity:	54%
Pressure:	101kPa	Phase :	N
Test Voltage :	AC 120V/60Hz	Test Mode:	Mode 3 (the worst mode)

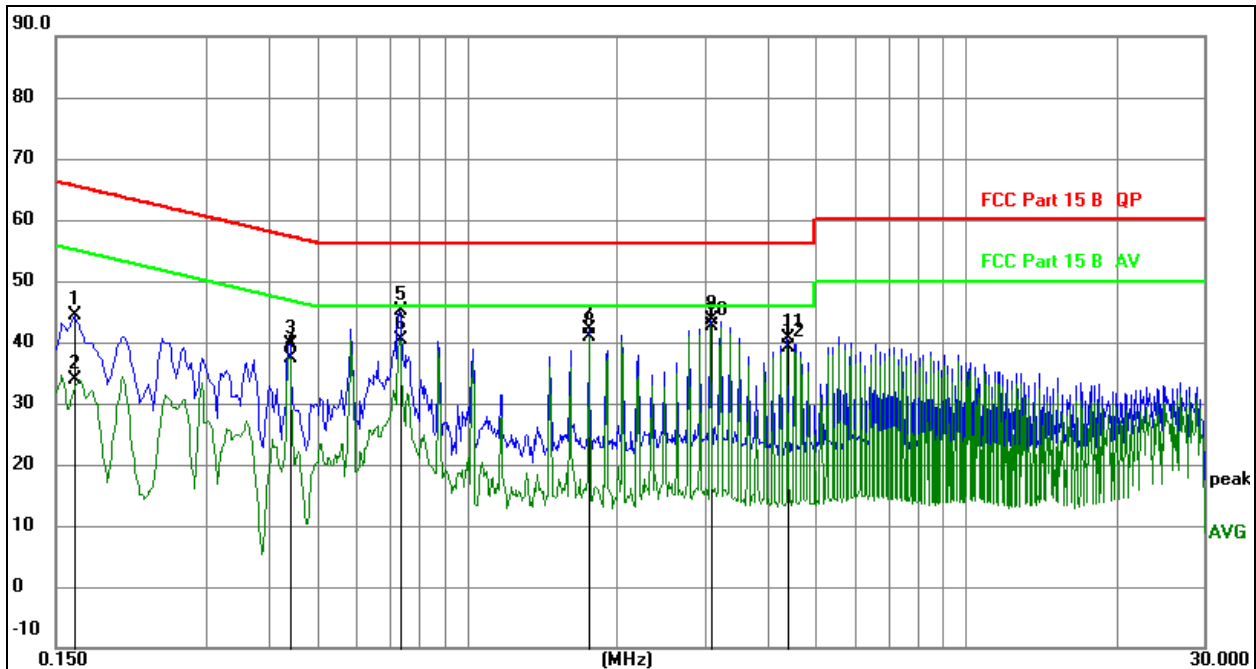
**Remark:**

1. All readings are Quasi-Peak and Average values.
2. Factor = Insertion Loss + Cable Loss.
3. Measurement=Reading Level+ Correct Factor
4. Over=Measurement-Limit

No.	Mk.	Freq. MHz	Reading Level	Correct Factor	Measure- ment	Limit	Over	Detector
				dB	dBuV	dBuV	dB	
1		0.1635	24.60	19.71	44.31	65.28	-20.97	QP
2		0.1635	14.23	19.71	33.94	55.28	-21.34	AVG
3		0.4425	19.97	19.74	39.71	57.01	-17.30	QP
4		0.4425	17.67	19.74	37.41	47.01	-9.60	AVG
5		0.7349	25.34	19.74	45.08	56.00	-10.92	QP
6		0.7349	20.74	19.74	40.48	46.00	-5.52	AVG
7		1.7609	22.22	19.85	42.07	56.00	-13.93	QP
8		1.7609	20.97	19.85	40.82	46.00	-5.18	AVG
9		3.0840	23.64	20.00	43.64	56.00	-12.36	QP
10	*	3.0840	22.70	20.00	42.70	46.00	-3.30	AVG
11		4.4025	20.57	20.11	40.68	56.00	-15.32	QP
12		4.4025	19.12	20.11	39.23	46.00	-6.77	AVG

## 7. Radiated Emissions

### 7.1 Block Diagram Of Test Setup

(A) Radiated Emission Test-Up Frequency Below 30MHz

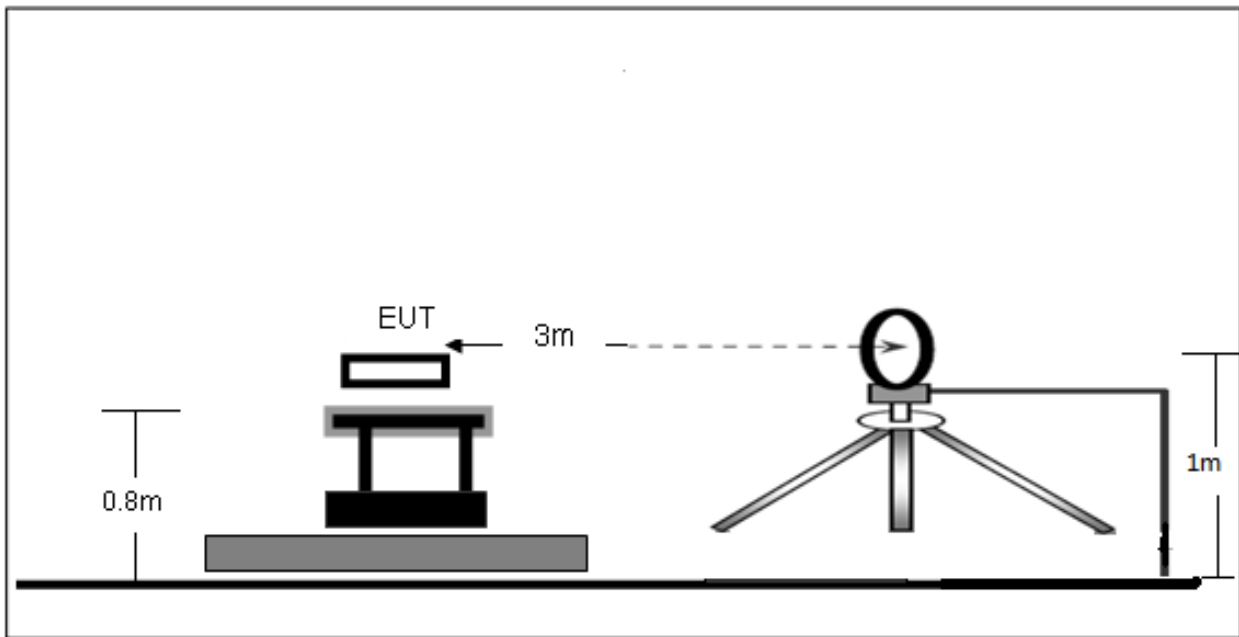

(B) Radiated Emission Test-Up Frequency 30MHz~1GHz

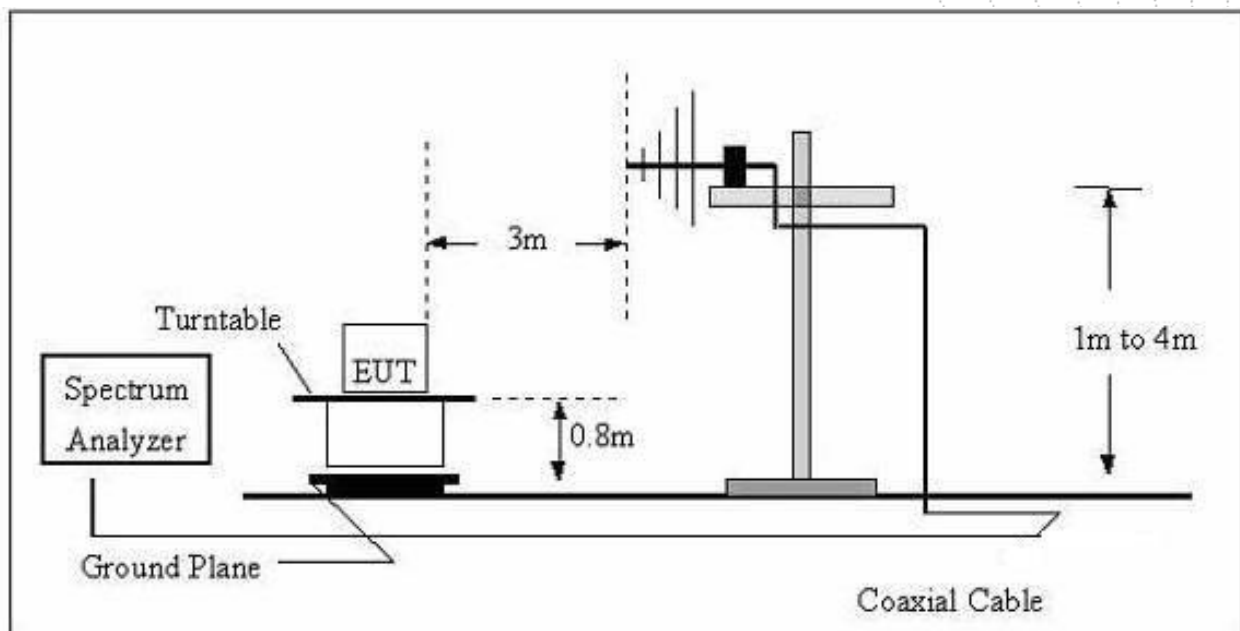

## 7.2 Limit

FCC §15.209; §15.205.

Test Standard	FCC Part15 C Section 15.209 and 15.205				
Test Limit	Frequency (MHz)	Field strength (microvolt/meter)	Limit (dBuV/m)	Remark	Measurement distance (m)
	0.009MHz~0.490MHz	2400/F(kHz)	-	-	300
	0.490MHz-1.705MHz	24000/F(kHz)	-	-	30
	1.705MHz-30MHz	30	-	-	30
	30MHz~88MHz	100	40.0	Quasi-peak	3
	88MHz~216MHz	150	43.5	Quasi-peak	3
	216MHz~960MHz	200	46.0	Quasi-peak	3
	960MHz~1000MHz	500	54.0	Quasi-peak	3
	Above 1000MHz	500	54.0	Average	3
-		74.0	Peak	3	

## 7.3 Test Procedure

Receiver Parameter	Setting
Attenuation	Auto
9kHz~150kHz	RBW 200Hz for QP
150kHz~30MHz	RBW 9kHz for QP
30MHz~1000MHz	RBW 120kHz for QP

Below 1GHz test procedure as below:

- The EUT was placed on the top of a rotating table 0.8 meters above the ground at a 3 meter semi-anechoic chamber. The table was rotated 360 degrees to determine the position of the highest radiation.
- The EUT was set 3 meters away from the interference-receiving antenna, which was mounted on the top of a variable-height antenna tower.
- The antenna height is varied from one meter to four meters above the ground to determine the maximum value of the field strength. Both horizontal and vertical polarizations of the antenna are set to make the measurement.
- For each suspected emission, the EUT was arranged to its worst case and then the antenna was tuned to heights from 1 meter to 4 meters (for the test frequency of below 30MHz, the antenna was tuned to heights 1 meter) and the rotatable table was turned from 0 degrees to 360 degrees to find the maximum reading.
- The test-receiver system was set to Peak Detect Function and Specified Bandwidth with Maximum Hold Mode.

BCTC  
 3C  
 PPR  
 检测

f. If the emission level of the EUT in peak mode was 10dB lower than the limit specified, then testing could be stopped and the peak values of the EUT would be reported. Otherwise the emissions that did not have 10dB margin would be re-tested one by one using peak, quasi-peak or average method as specified and then reported in a data sheet.

Above 1GHz test procedure as below:

g. Different between above is the test site, change from Semi- Anechoic Chamber to fully Anechoic Chamber and change form table 0.8 metre to 1.5 metre( Above 18GHz the distance is 1 meter and table is 1.5 metre).

h. Test the EUT in the lowest channel ,the middle channel ,the Highest channel.

Note:

Both horizontal and vertical antenna polarities were tested and performed pretest to three orthogonal axis. The worst case emissions were reported.

## 7.4 Test Result

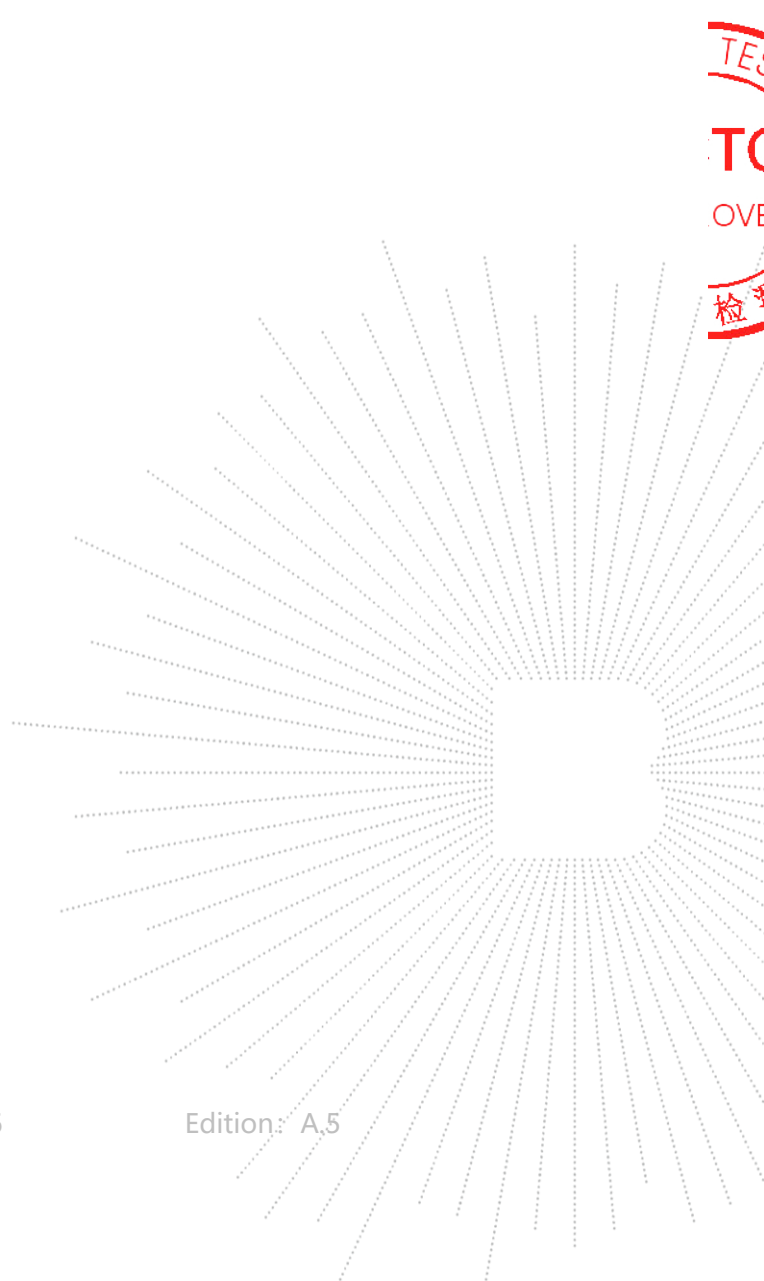



9kHz-30MHz

Temperature:	26°C	Relative Humidity:	54%
Pressure:	101 kPa	Test Voltage :	AC 120V/60Hz
Test Mode :	Mode 4 (the worst mode)	Polarization :	---

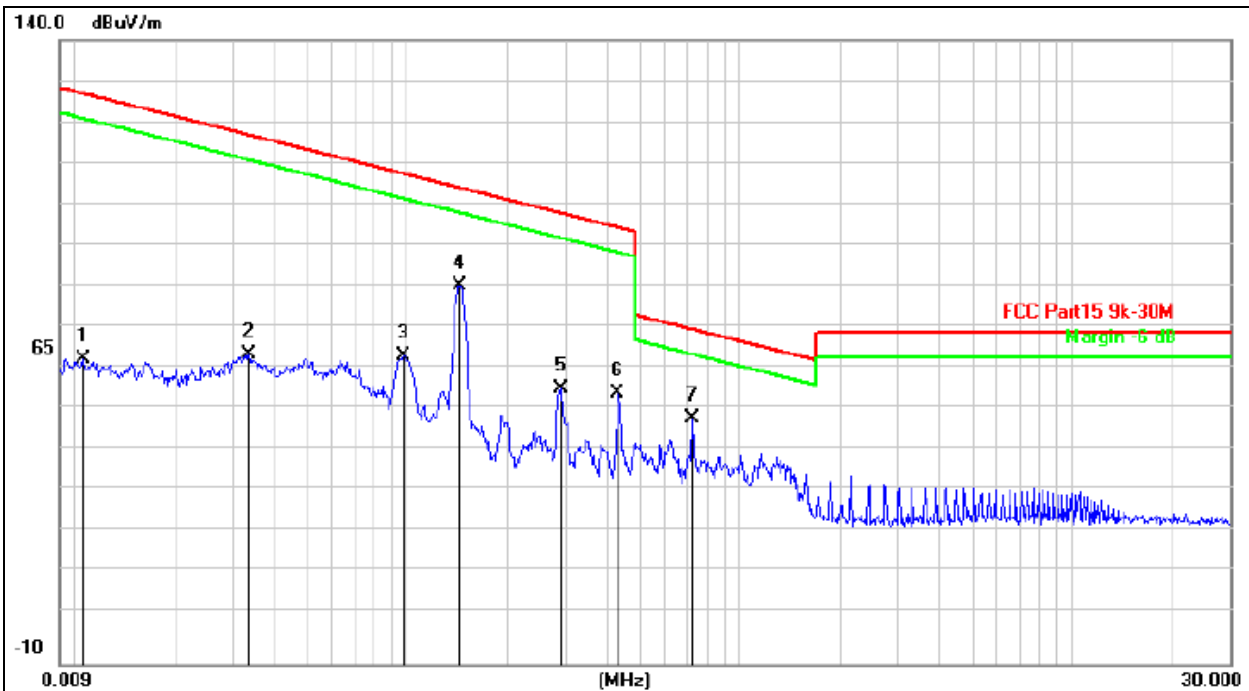

Remark:

1. Factor = Antenna Factor + Cable Loss – Pre-amplifier.
2. Measurement=Reading Level+ Correct Factor
3. Over=Measurement-Limit

No. Mk.	Freq. MHz	Reading Level dBuV	Correct Factor dB	Measure- ment dBuV/m	Limit dB/m	Over dB	Detector
1	0.0106	73.59	-10.37	63.22	127.10	-63.88	peak
2	0.0335	75.27	-10.71	64.56	117.10	-52.54	peak
3	0.0977	74.29	-10.26	64.03	107.81	-43.78	peak
4	0.1442	91.03	-10.04	80.99	104.42	-23.43	peak
5	0.2898	66.48	-10.28	56.20	98.36	-42.16	peak
6	0.4312	65.20	-10.27	54.93	94.91	-39.98	peak
7 *	0.7246	59.20	-10.25	48.95	70.41	-21.46	peak

Between 30MHz – 1GHz

Temperature:	26°C	Relative Humidity:	54%
Pressure:	101 kPa	Test Voltage :	AC 120V/60Hz
Test Mode :	Mode 4 (the worst mode)	Polarization :	Horizontal

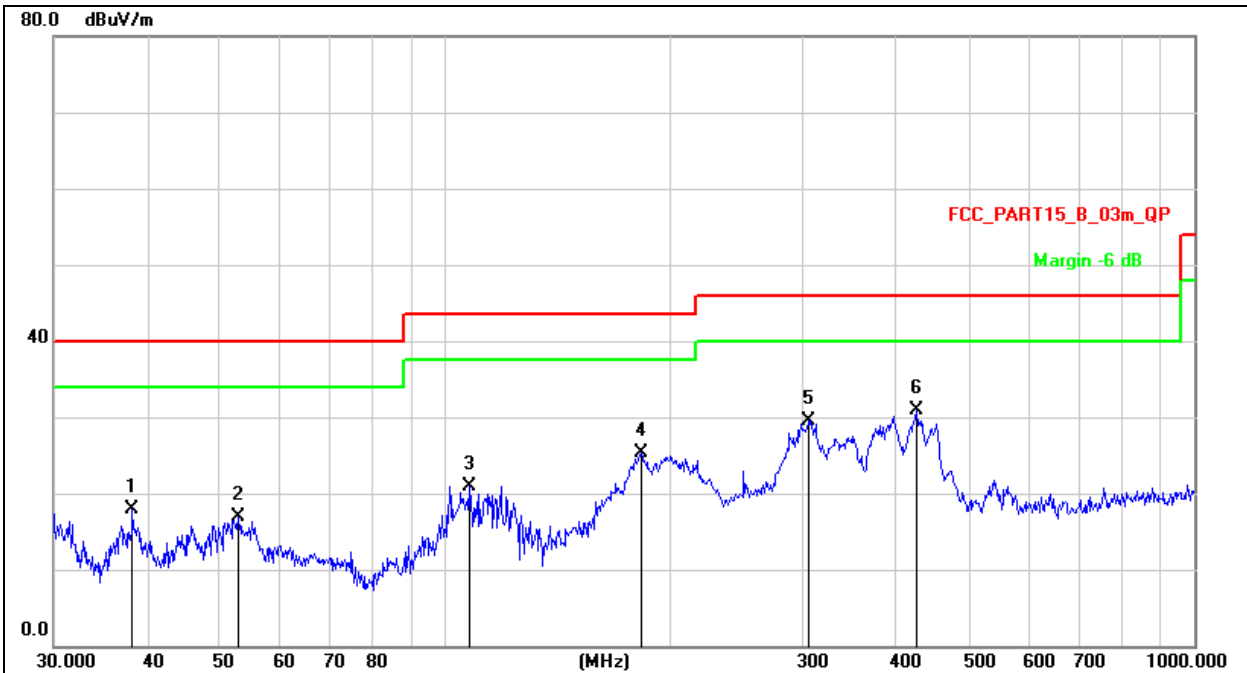

Remark:

1. Factor = Antenna Factor + Cable Loss – Pre-amplifier.
2. Measurement=Reading Level+ Correct Factor
3. Over=Measurement-Limit

No.	Mk.	Freq. MHz	Reading Level dBuV	Correct Factor dB	Measure- ment dBuV/m	Limit dB/m	Over dB	Detector
1		38.2120	34.85	-17.02	17.83	40.00	-22.17	QP
2		52.9453	32.99	-16.03	16.96	40.00	-23.04	QP
3		107.5101	39.25	-18.25	21.00	43.50	-22.50	QP
4		182.5592	43.86	-18.65	25.21	43.50	-18.29	QP
5		305.6800	43.96	-14.38	29.58	46.00	-16.42	QP
6	*	425.0280	42.84	-11.85	30.99	46.00	-15.01	QP

Temperature:	26°C	Relative Humidity:	54%
Pressure:	101 kpa	Test Voltage :	AC 120V/60Hz
Test Mode :	Mode 4 (the worst mode)	Polarization :	Vertical

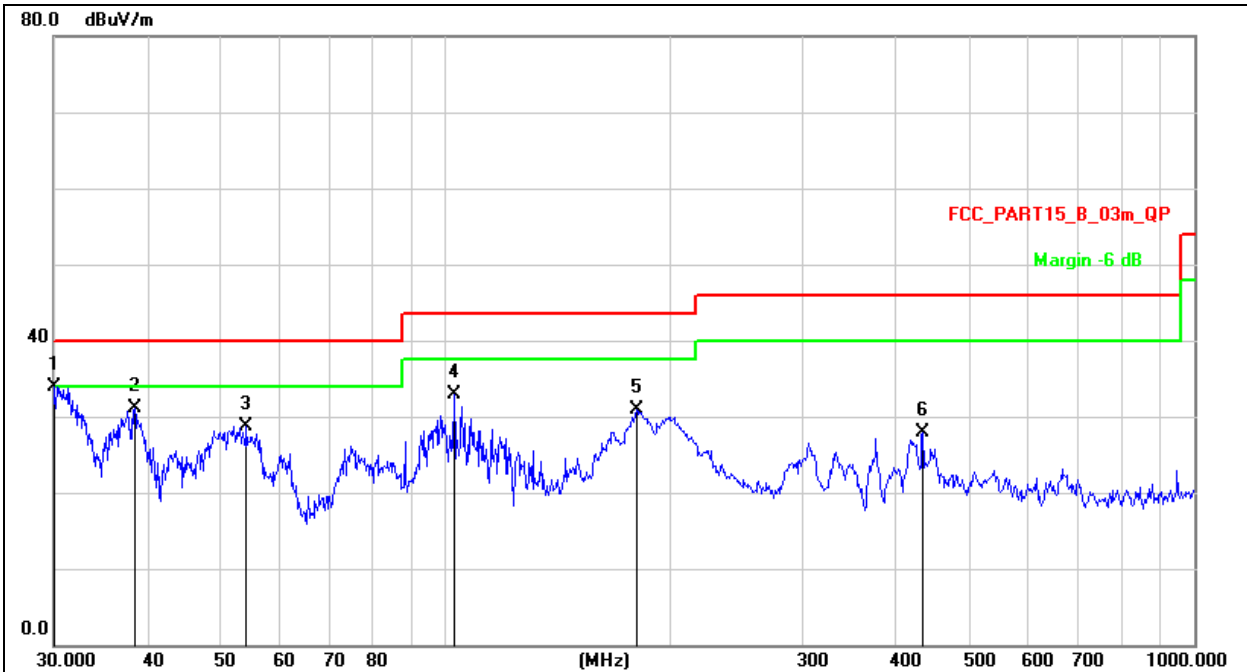
**Remark:**

- Factor = Antenna Factor + Cable Loss – Pre-amplifier.
- Measurement=Reading Level+ Correct Factor
- Over=Measurement-Limit

No.	Mk.	Freq. MHz	Reading Level dBuV	Correct Factor dB	Measure- ment dBuV/m	Limit dB/m	Over dB	Detector
1	*	30.0000	52.24	-18.38	33.86	40.00	-6.14	QP
2		38.4809	48.11	-16.97	31.14	40.00	-8.86	QP
3		54.2610	44.86	-16.23	28.63	40.00	-11.37	QP
4		102.7192	50.75	-17.94	32.81	43.50	-10.69	QP
5		180.0165	49.70	-18.84	30.86	43.50	-12.64	QP
6		434.0651	39.67	-11.72	27.95	46.00	-18.05	QP

## 8. Bandwidth Test

1. Set RBW = 1%~5% OBW.
2. Set the video bandwidth (VBW)  $\geq 3 \times$  RBW.
3. Detector = Peak.
4. Trace mode = max hold.
5. Sweep = auto couple.
6. Allow the trace to stabilize.
7. Measure the maximum width of the emission that is constrained by the frequencies associated with the two outermost amplitude points (upper and lower frequencies) that are attenuated by 20 dB relative to the maximum level measured in the fundamental emission.

### TEST SETUP



Temperature :	26 °C	Relative Humidity :	54%
Pressure :	101kPa		

Frequency (KHz)	20dB bandwidth (Hz)	Result
142.1	43	Pass

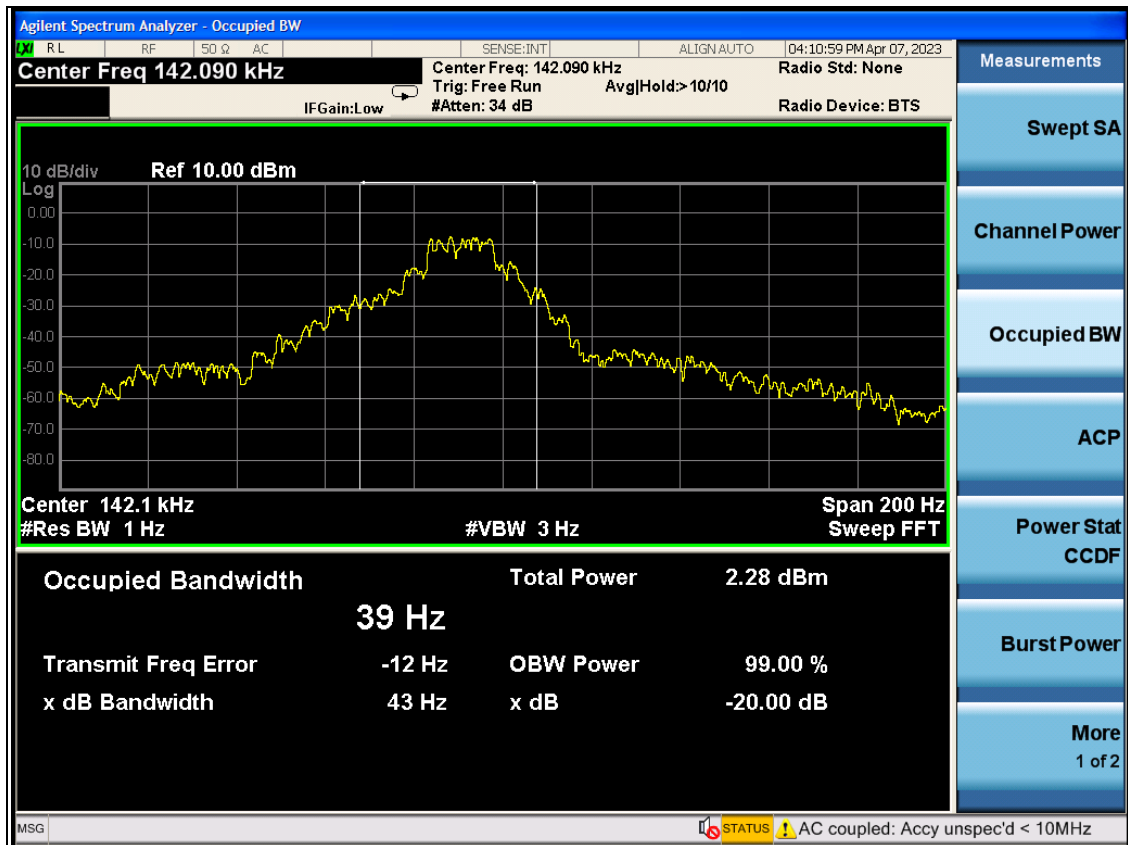

## 9. Antenna Requirements

For intentional device, according to FCC 47 CFR Section 15.203, An intentional radiator shall be designed to ensure that no antenna other than that furnished by the responsible party shall be used with the device. The use of a permanently attached antenna or of an antenna that uses a unique coupling to the intentional radiator shall be considered sufficient to comply with the provisions of this section. The manufacturer may design the unit so that a broken antenna can be replaced by the user, but the use of a standard antenna jack or electrical connector is prohibited. The antenna used for this product is Inductive loop coil antenna.

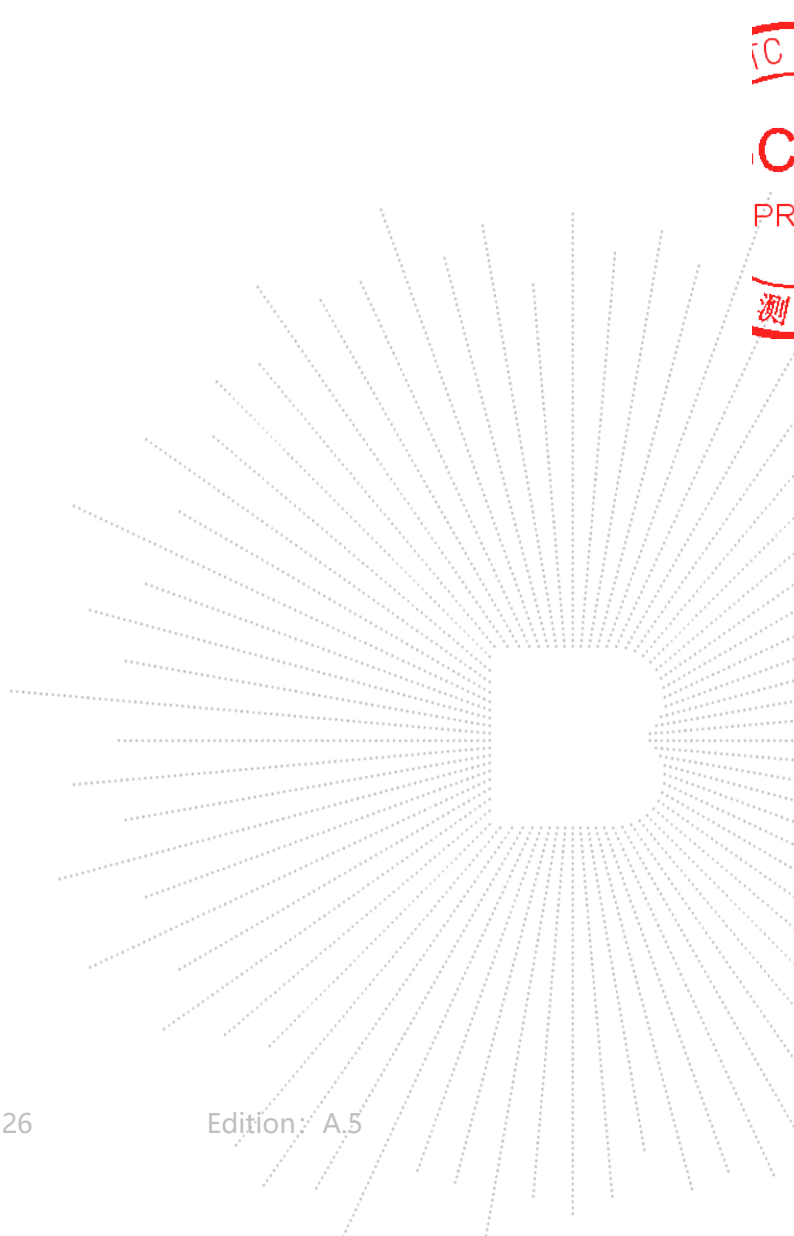

### 10. EUT Photographs

EUT Photo

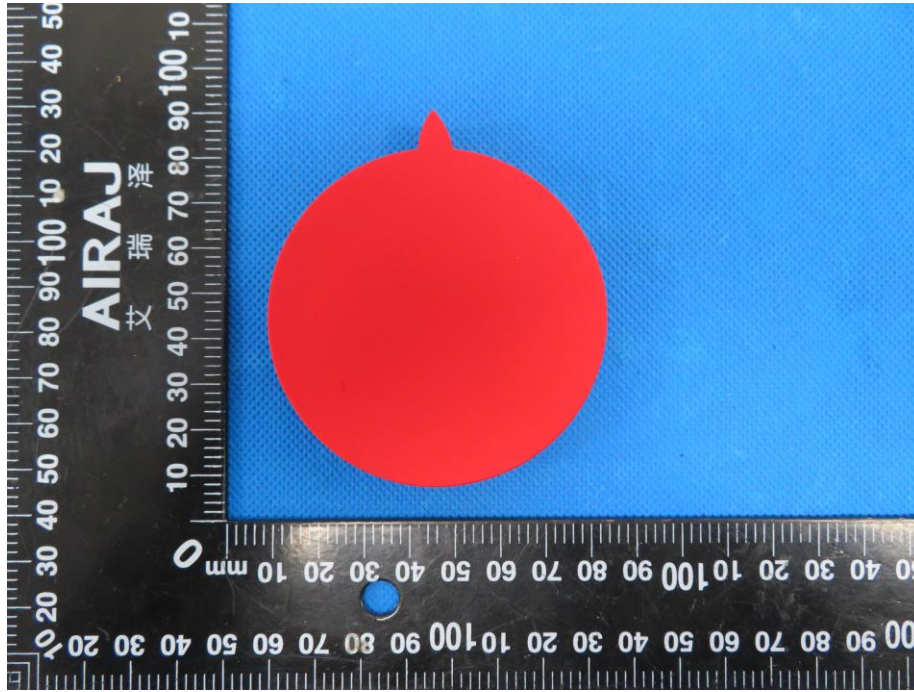

NOTE: Appendix-Photographs Of EUT Constructional Details

TE  
T  
OV  
檢

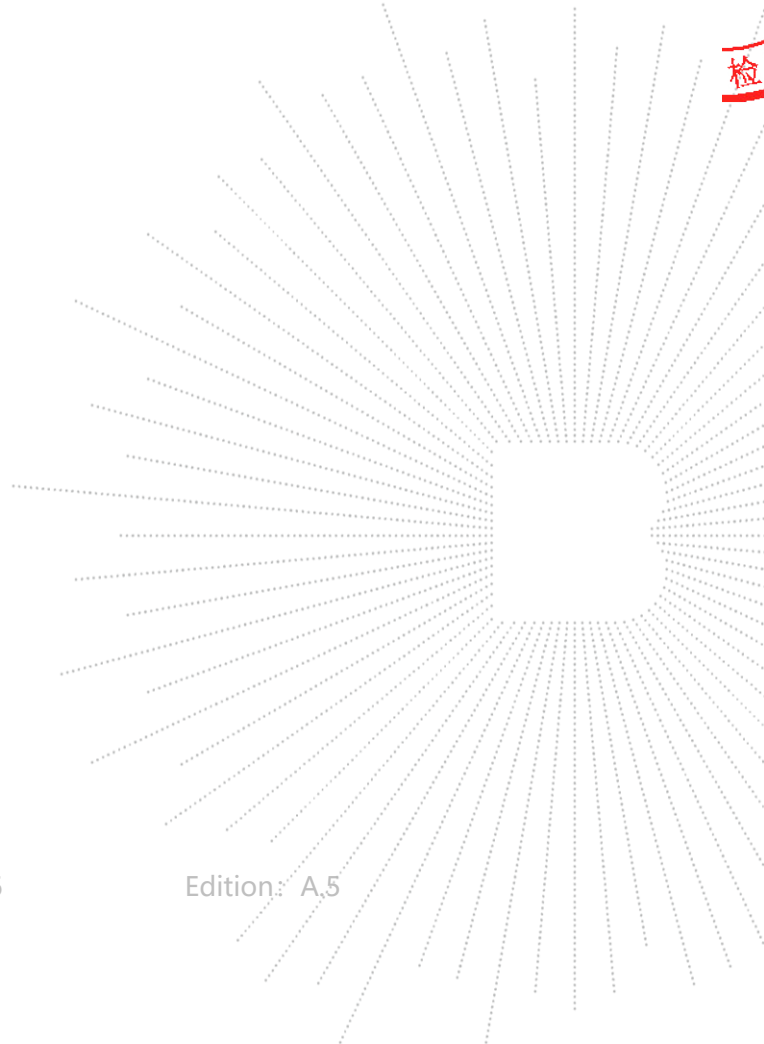

### 11. EUT Test Setup Photographs

#### Conducted Emissions Photo



#### Radiated Measurement Photos

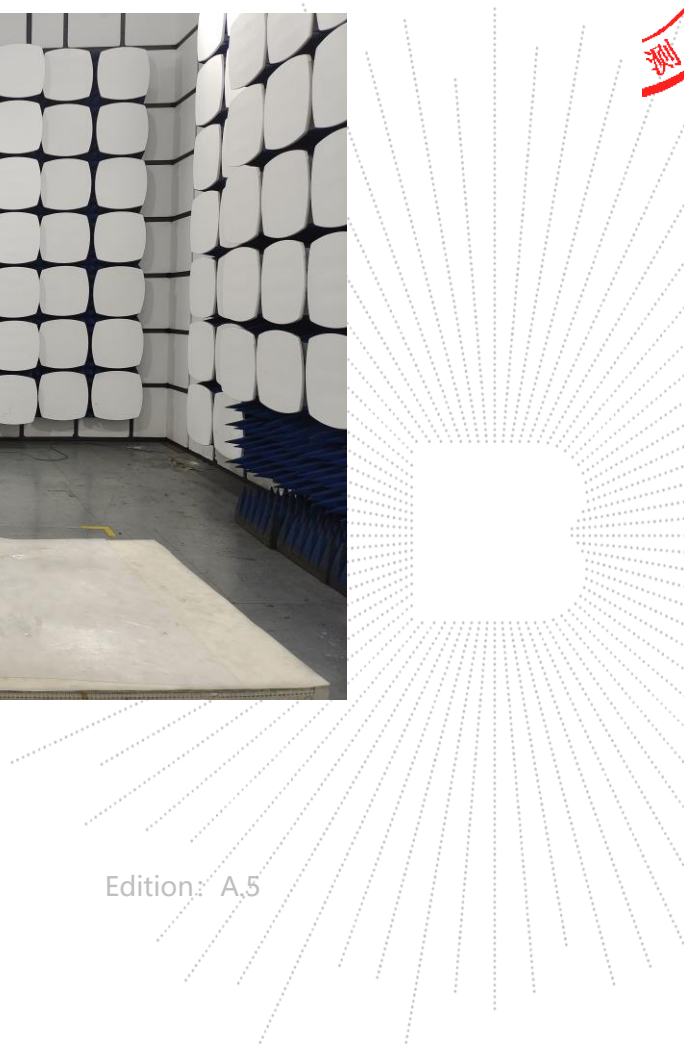
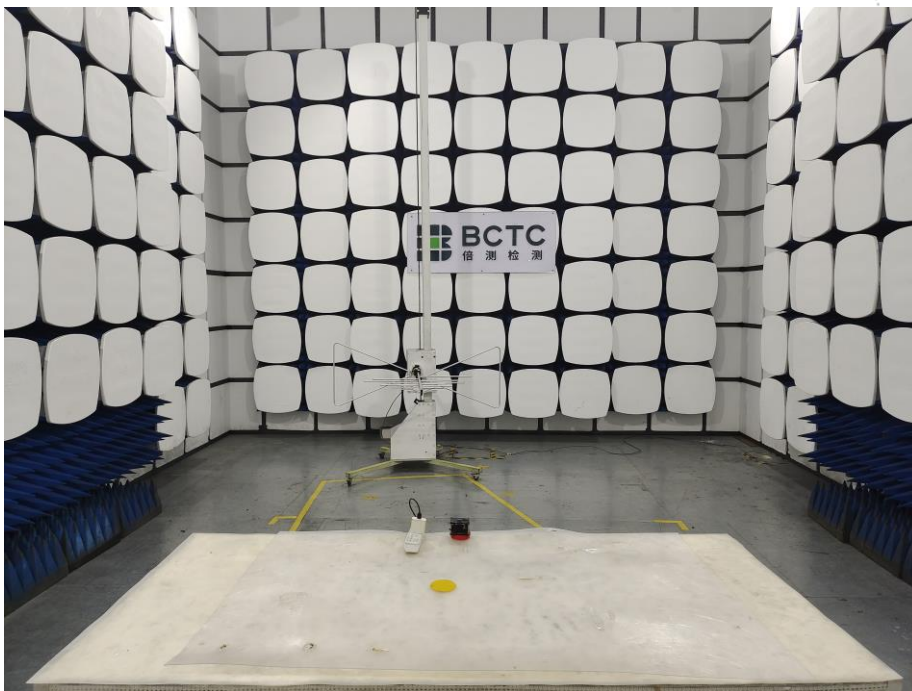



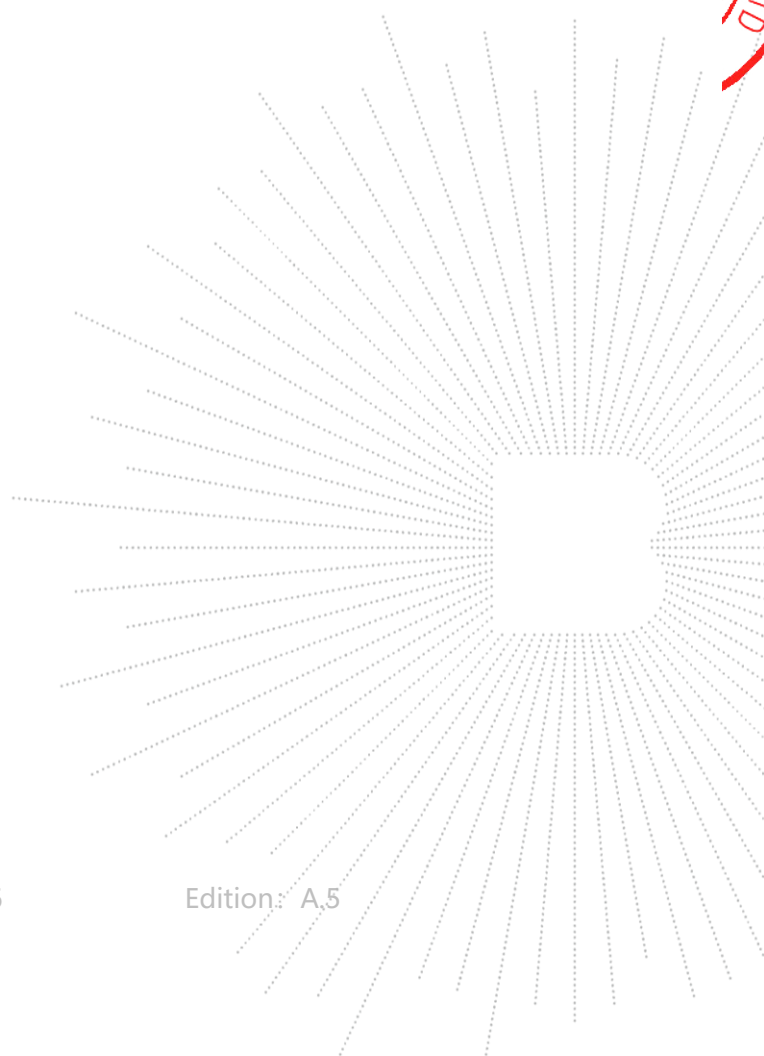
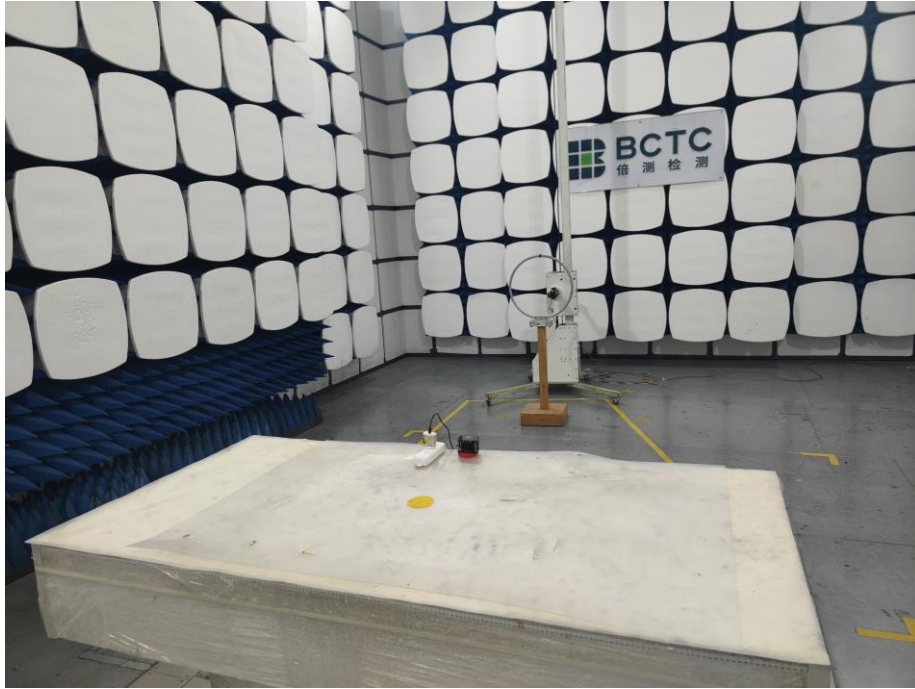

**STATEMENT**

1. The equipment lists are traceable to the national reference standards.
2. The test report can not be partially copied unless prior written approval is issued from our lab.
3. The test report is invalid without the "special seal for inspection and testing".
4. The test report is invalid without the signature of the approver.
5. The test process and test result is only related to the Unit Under Test.
6. Sample information is provided by the client and the laboratory is not responsible for its authenticity.
7. The test report without CMA mark is only used for scientific research, teaching, enterprise product development and internal quality control purposes.
8. The quality system of our laboratory is in accordance with ISO/IEC17025.
9. If there is any objection to this test report, the client should inform issuing laboratory within 15 days from the date of receiving test report.

**Address:**

1-2/F., Building B, Pengzhou Industrial Park, No.158, Fuyuan 1st Road, Zhancheng, Fuhai Subdistrict, Bao'an District, Shenzhen, Guangdong, China

TEL: 400-788-9558

P.C.: 518103

FAX: 0755-33229357

Website: <http://www.chnbctc.com>

E-Mail: [bctc@bctc-lab.com.cn](mailto:bctc@bctc-lab.com.cn)

**\*\*\*\*\* END \*\*\*\*\***

2017

