

## RF TEST REPORT

### FCC ID: 2BAWK-B92

**Product Name** : Sixfab 5G Modem Kit for Raspberry Pi 5  
**Brand Name** : Sixfab  
**Test Model/HVIN** : Sixfab 5G Modem Kit for Raspberry Pi 5  
**Series Model** : Jumpstart  
**Applicant** : Sixfab, Inc  
**Address** : 1185 Campbell Ave, Unit K12, San Jose, CA 95126, United States  
**Manufacturer** : Sixfab, Inc  
**Address** : 1185 Campbell Ave, Unit K12, San Jose, CA 95126, United States  
**Date of Receipt** : 2023.02.05  
**Date of Test** : 2023.02.06-2024.01.18  
**Issued Date** : 2024.01.18  
**Report Version** : v1  
**Test Sample** : Engineering Sample No.: AIT23121308-1  
**Standard(s)** : 47 CFR FCC Part 2;47 CFR FCC Part 27 Rules;  
ANSI C63.26:2015;

Lab:Dongguan Yaxu (AiT) Technology Limited  
Add:No.22,Jinqianling 3rd Street,Jitigang,Huangjiang,Dongguan,  
Guangdong,China  
Tel.: +86-769-8202 0499 Fax.: +86-769-8202 0495

This device described above has been tested by Dongguan Yaxu (AiT) Technology Limited and the test results show that the equipment under test (EUT) is in compliance with the FCC requirements. And it is applicable only to the tested sample identified in the report.

Note: This report shall not be reproduced except in full, without the written approval of Dongguan Yaxu (AiT) Technology Limited, this document may be altered or revised by Dongguan Yaxu (AiT) Technology Limited, personal only, and shall be noted in the revision of the document. This test report must not be used by the client to claim product endorsement.

Reviewed by: \_\_\_\_\_

*Simba Huang*

Simba huang

Approved by: \_\_\_\_\_

*Seal-Chen*

Seal Chen



# Table of Contents

<b>1. General Information .....</b>	<b>5</b>
1.1 Applicant.....	5
1.2 Manufacturer.....	5
Basic Description of Equipment Under Test .....	5
1.3 Technical Specification.....	6
<b>2. Summary of Test Results .....</b>	<b>8</b>
2.1 Application of Standard.....	8
NR Band n41 .....	8
NR Band n77 / NR Band n78 (ENDC DC_41A-n78A).....	9
<b>3. General Test Frequency and Configuration.....</b>	<b>11</b>
3.1 Test Frequency .....	11
Reference test frequencies for NR operating band n41 .....	11
Test frequencies for NR operating band n41 and SCS 30 kHz .....	11
Reference test frequencies for NR operating band n77 .....	12
Test frequencies for NR operating band n77 and SCS 30 kHz .....	12
3700-3980:.....	12
Reference test frequencies for NR operating band n78 .....	14
3.2 Test Environment .....	16
3.3 Test Instruments .....	17
3.4 Measurement Uncertainty.....	18
3.5 Test Location.....	18
3.6 Deviation from Standards .....	18
3.7 Abnormalities from Standard Conditions.....	18
<b>4. Test Setup and Conditions .....</b>	<b>19</b>
4.1 Test Setup 1 .....	19
4.2 Test Setup 2.....	19
4.3 Test Setup 3.....	20
<b>5. Description of Tests .....</b>	<b>21</b>
5.1 Effective (Isotropic) Radiated Power.....	21



5.2	Peak-Average Ratio.....	22
5.3	Occupied Bandwidth.....	23
5.4	Band Edge Compliance .....	24
5.5	Spurious and Harmonic Emissions at Antenna Terminal.....	25
5.6	Field Strength of Spurious Radiation .....	26
5.7	Frequency Stability / Temperature Variation.....	31

**Revision History**

Revision	Issue Date	Revisions	REMARK
v1	2023.06.14	Initial Issue	Report No.: AIT23020302FW1
V2	2024.01.18	Update product name, model name, FCC ID, and Low frequency radiation spurious.	Report No.: AIT23121308FW1

# 1. General Information

## 1.1 Applicant

Sixfab, Inc

1185 Campbell Ave, Unit K12, San Jose, CA 95126, United States

## 1.2 Manufacturer

Sixfab, Inc

1185 Campbell Ave, Unit K12, San Jose, CA 95126, United States

### Basic Description of Equipment Under Test

Items	Description
Applicant	Sixfab, Inc
Address	1185 Campbell Ave, Unit K12, San Jose, CA 95126, United States
Manufacturer	Sixfab, Inc
Address	1185 Campbell Ave, Unit K12, San Jose, CA 95126, United States
Product Name	Sixfab 5G Modem Kit for Raspberry Pi 5
Band Name	Sixfab
Test Model Number	Sixfab 5G Modem Kit for Raspberry Pi 5
Series Model	Jumpstart
Difference Description	PCB board, structure and internal of these model(s) are the same, So no additional models were tested.
Power Supply	Input:100~240V 50/60Hz 0.4A
	Output: 5.1V 3A
Antenna Type:	Microstrip Antenna
Operating Temperature	-10~50°C
Hardware Version	v1
Software Version	v1
EUT Stage	<input checked="" type="radio"/> Product Unit <input type="radio"/> Final-Sample
Radio System Type	5G NR
Operating Band	N41, N77, N78

**Note:**

- For more details, please refer to the User's manual of the EUT.

### 1.3 Technical Specification

Characteristics	Description		
Supported type	<input checked="" type="checkbox"/> SA <input checked="" type="checkbox"/> NSA		
Supported Frequency Range	Band	Uplink	Downlink
	TDD N41	2496 to 2690 MHz	2496 to 2690 MHz
	TDD N77	3700 to 3980 MHz	3700 to 3980 MHz
		3450 to 3550 MHz	3450 to 3550 MHz
	TDD N78	3700 to 3800 MHz	3700 to 3800 MHz
3450 to 3550 MHz		3450 to 3550 MHz	
TX and RX Antenna Ports	TX & RX port:	1	
	TX-only port:	0	
	RX-only port:	3	
Antenna Gain	N41:3.2dBi; N77/N78 3.5G band:1.99dBi; N77/N78 3.7G band:2.75dBi		
Supported Channel Bandwidth	SCS 30kHz:		
	NR Band n41	<input checked="" type="checkbox"/> 20MHz <input checked="" type="checkbox"/> 30MHz <input checked="" type="checkbox"/> 40MHz <input checked="" type="checkbox"/> 50MHz <input checked="" type="checkbox"/> 60MHz <input checked="" type="checkbox"/> 70MHz <input checked="" type="checkbox"/> 80MHz <input checked="" type="checkbox"/> 90MHz <input checked="" type="checkbox"/> 100MHz	
	NR Band n77	<input checked="" type="checkbox"/> 20MHz <input checked="" type="checkbox"/> 30MHz <input checked="" type="checkbox"/> 40MHz <input checked="" type="checkbox"/> 50MHz <input checked="" type="checkbox"/> 60MHz <input checked="" type="checkbox"/> 70MHz <input checked="" type="checkbox"/> 80MHz <input checked="" type="checkbox"/> 90MHz <input checked="" type="checkbox"/> 100MHz	
	NR Band n78	<input checked="" type="checkbox"/> 20MHz <input checked="" type="checkbox"/> 30MHz <input checked="" type="checkbox"/> 40MHz <input checked="" type="checkbox"/> 50MHz <input checked="" type="checkbox"/> 60MHz <input checked="" type="checkbox"/> 70MHz <input checked="" type="checkbox"/> 80MHz <input checked="" type="checkbox"/> 90MHz <input checked="" type="checkbox"/> 100MHz	
Emissions  (Remark: the necessary bandwidth of which is the worst value from the measured occupied bandwidths for each type of channel bandwidth configuration.)	NR Band n41	17M8G7D	18M2W7D
		26M9G7D	27M9W7D
		35M7G7D	37M8W7D
		45M7G7D	47M5W7D
		57M9G7D	57M7W7D
		64M2G7D	67M4W7D
		77M2G7D	77M5W7D
		85M6G7D	87M4W7D
	NR Band n77	17M8G7D	18M3W7D
		26M8G7D	28M0W7D
		35M9G7D	37M9W7D
		45M7G7D	47M4W7D
		57M9G7D	57M9W7D
		64M4G7D	67M4W7D
		77M1G7D	77M6W7D
		85M7G7D	87M5W7D

	NR Band n77	96M3G7D	97M4W7D
	NR Band n78	17M8G7D	18M3W7D
		26M8G7D	27M9W7D
		35M8G7D	37M9W7D
		45M8G7D	47M5W7D
		57M9G7D	57M8W7D
		64M4G7D	67M3W7D
		77M4G7D	77M6W7D
		85M7G7D	87M4W7D
		96M3G7D	97M4W7D

**Note:**

Both N77 and N78 use frequency bands of 3450-3550MHz, the working circuit principle of the frequency band is the same, So only EIRP for N77(3.5G Band) is verified and recorded in the report.

## 2. Summary of Test Results

### 2.1 Application of Standard

47 CFR FCC Part 2

47 CFR FCC Part 27

KDB 971168 D01 Power Meas License Digital Systems v03r01

ANSI C63.26:2015

#### NR Band n41

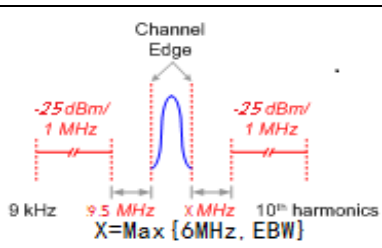
Test Item	FCC Rule No.	Requirements	Verdict
Effective (Isotropic) Radiated Power Output Data	§2.1046, §27.50(h)(2)	EIRP ≤ 2W	Pass
Peak-Average Ratio	---	≤13 dB	Pass
Modulation Characteristics	§2.1047	Digital modulation	Pass
Bandwidth	§2.1049	OBW: No limit. EBW: No limit.	Pass
Band Edges Compliance	§2.1051, §27.53(m4)	For mobile digital stations, the attenuation factor shall be not less than 40 + 10 log (P) dB on all frequencies between the channel edge and 5 megahertz from the channel edge, 43 + 10 log (P) dB on all frequencies between 5 megahertz and X megahertz from the channel edge, and 55 + 10 log (P) dB on all frequencies more than X megahertz from the channel edge, where X is the greater of 6 megahertz or the actual emission bandwidth as defined in paragraph (m)(6) of this section. In addition, the attenuation factor shall not be less that 43 + 10 log (P) dB on all frequencies between 2490.5 MHz and 2496 MHz and 55 + 10 log (P) dB at or below 2490.5 MHz.	Pass
Spurious Emission at Antenna Terminals	§2.1051, §27.53(m)	 <p style="text-align: center;">Channel Edge</p> <p style="text-align: center;">-25 dBm/1 MHz      -25 dBm/1 MHz</p> <p style="text-align: center;">9 kHz    9.5 MHz    X MHz    10<sup>th</sup> harmonics</p> <p style="text-align: center;">X = Max {6MHz, EBW}</p>	Pass

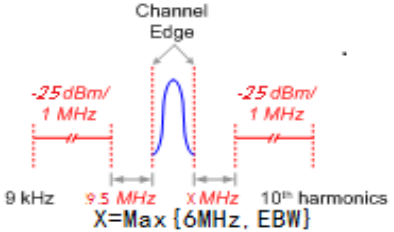

Test Item	FCC Rule No.	Requirements	Verdict
Field Strength of Spurious Radiation	§2.1053, §27.53(m)		Pass
Frequency Stability	§2.1055(a)(1)(b), §2.1055(d)(2), §27.54	Within authorized bands of operation/frequency block.	Pass

**NR Band n77 / NR Band n78 (ENDC DC\_41A-n78A)**

**3700-3980MHz:**

Test Item	FCC Rule No.	Requirements	Verdict
Effective (Isotropic) Radiated Power Output Data	§2.1046, §27.50(j)(3)	EIRP ≤ 1W	Pass
Peak-Average Ratio	---	≤13 dB	Pass
Modulation Characteristics	§2.1047	Digital modulation	Pass
Bandwidth	§2.1049	OBW: No limit. EBW: No limit.	Pass
Band Edges Compliance	§2.1051, §27.53(l)(2)	(2) For mobile operations in the 3700-3980 MHz band, the conducted power of any emission outside the licensee's authorized bandwidth shall not exceed -13 dBm/MHz. Compliance with this paragraph (l)(2) is based on the use of measurement instrumentation employing a resolution bandwidth of 1 megahertz or greater. However, in the 1 megahertz bands immediately outside and adjacent to the licensee's frequency block, the minimum resolution bandwidth for the measurement shall be either one percent of the emission bandwidth of the fundamental emission of the transmitter or 350 kHz. In the bands between 1 and 5 MHz removed from the licensee's frequency block, the minimum resolution bandwidth for the measurement shall be 500 kHz.	Pass
Spurious Emission at Antenna Terminals	§2.1051, §27.53(l)(2)	not exceed -13 dBm/MHz.	Pass
Field Strength of Spurious Radiation	§2.1053, §27.53(l)(2)	not exceed -13 dBm/MHz	Pass
Frequency Stability	§2.1055(a)(1)(b), §2.1055(d)(2), §27.54	Within authorized bands of operation/frequency block.	Pass

**3450-3550MHz:**

Test Item	FCC Rule No.	Requirements	Verdict
Effective (Isotropic) Radiated Power Output Data	§2.1046, §27.50(k)(3)	EIRP ≤ 30dBm	Pass
Peak-Average Ratio	§27.50(k)(4)	FCC: Limit≤13 dB	Pass
Bandwidth	§2.1049	OBW: No limit. EBW: No limit.	Pass
Band Edges Compliance	§2.1051, §27.50(n)(2)	For mobile operations in the 3450-3550 MHz band, the conducted power of any emission outside the licensee's authorized bandwidth shall not exceed -13 dBm/MHz.	Pass
Spurious Emission at Antenna Terminals	§2.1051, §27.50(n)(2)	For mobile operations in the 3450-3550 MHz band, the conducted power of any emission outside the licensee's authorized bandwidth shall not exceed -13 dBm/MHz.	Pass
Field Strength of Spurious Radiation	§2.1053, §27.50(n)(2)	For mobile operations in the 3450-3550 MHz band, the conducted power of any emission outside the licensee's authorized bandwidth shall not exceed -13 dBm/MHz.	Pass
Frequency Stability	§2.1055(a)(1)(b) §2.1055(d)(2) §27.54	Within authorized bands of operation/ frequency block.	Pass

### 3. General Test Frequency and Configuration

#### 3.1 Test Frequency

Reference test frequencies for NR operating band n41

Test frequencies for NR operating band n41 and SCS 30 kHz

CBW [MHz]	Range		Carrier centre [MHz]	Carrier centre [ARFCN]	SS block SCS [kHz]
20	Downlink & Uplink	Low	2506.02	501204	30
		Mid	2592.99	518598	
		High	2670	534000	
30	Downlink & Uplink	Low	2511	502200	30
		Mid	2592.99	518598	
		High	2675	535000	
40	Downlink & Uplink	Low	2516.01	503202	30
		Mid	2592.99	518598	
		High	2670	534000	
50	Downlink & Uplink	Low	2521.02	504204	30
		Mid	2592.99	518598	
		High	2664.99	532998	
60	Downlink & Uplink	Low	2526	505200	30
		Mid	2592.99	518598	
		High	2659.98	531996	
70	Downlink & Uplink	Low	2536.02	507204	30
		Mid	2592.99	518598	
		High	2649.99	529998	
80	Downlink & Uplink	Low	2536.02	507204	30
		Mid	2592.99	518598	
		High	2649.99	529998	
90	Downlink & Uplink	Low	2541	508200	30
		Mid	2592.99	518598	
		High	2644.98	528996	
100	Downlink & Uplink	Low	2546.01	509202	30

Reference test frequencies for NR operating band n77

Test frequencies for NR operating band n77 and SCS 30 kHz

3700-3980:

CBW [MHz]	Range		Carrier centre [MHz]	Carrier centre [ARFCN]	SS block SCS [kHz]
20	Downlink & Uplink	Low	3710.01	647334	30
		Mid	3840	656000	
		High	3969.99	664666	
30	Downlink & Uplink	Low	3714.99	647666	30
		Mid	3840	656000	
		High	3965.01	664334	
40	Downlink & Uplink	Low	3720	648000	30
		Mid	3840	656000	
		High	3960	664000	
50	Downlink & Uplink	Low	3725.01	648334	30
		Mid	3840	656000	
		High	3954.99	663666	
60	Downlink & Uplink	Low	3730.02	648668	30
		Mid	3840	656000	
		High	3949.98	663332	
70	Downlink & Uplink	Low	3735	649000	30
		Mid	3840	656000	
		High	3945	663000	
80	Downlink & Uplink	Low	3740.01	649334	30
		Mid	3840	656000	
		High	3939.99	662666	
90	Downlink & Uplink	Low	3745.02	649668	30
		Mid	3840	656000	
		High	3934.98	662332	
100	Downlink & Uplink	Low	3750	650000	30
		Mid	3840	656000	
		High	3930	662000	

**3450-3550:**

CBW [MHz]	Range		Carrier centre [MHz]	Carrier centre [ARFCN]	SS block SCS [kHz]
20	Downlink & Uplink	Low	3460.02	630668	30
		Mid	3500.01	633334	
		High	3540	636000	
30	Downlink & Uplink	Low	3465	631000	30
		Mid	3500.01	633334	
		High	3534.99	635666	
40	Downlink & Uplink	Low	3470.01	631334	30
		Mid	3500.01	633334	
		High	3530.01	635334	
50	Downlink & Uplink	Low	3475.02	631668	30
		Mid	3500.01	633334	
		High	3525	635000	
60	Downlink & Uplink	Low	3480	632000	30
		Mid	3500.01	633334	
		High	3519.99	634666	
70	Downlink & Uplink	Low	3485.01	632334	30
		Mid	3500.01	633334	
		High	3515.01	634334	
80	Downlink & Uplink	Low	3490.02	632668	30
		Mid	3500.01	633334	
		High	3510	634000	
90	Downlink & Uplink	Low	3495	633000	30
		Mid	3500.01	633334	
		High	3504.99	633666	
100	Downlink & Uplink	Low	¥	¥	30
		Mid	3500.01	633334	
		High	¥	¥	

Reference test frequencies for NR operating band n78

Test frequencies for NR operating band n78 and SCS 30 kHz

3700-3800:

CBW [MHz]	Range		Carrier centre [MHz]	Carrier centre [ARFCN]	SS block SCS [kHz]
20	Downlink & Uplink	Low	3710.01	647334	30
		Mid	3750	650000	
		High	3789.99	652666	
30	Downlink & Uplink	Low	3715.02	647668	30
		Mid	3750	650000	
		High	3785.01	652334	
40	Downlink & Uplink	Low	3720	648000	30
		Mid	3750	650000	
		High	3780	652000	
50	Downlink & Uplink	Low	3725.01	648334	30
		Mid	3750	650000	
		High	3774.99	651666	
60	Downlink & Uplink	Low	3730.02	648668	30
		Mid	3750	650000	
		High	3769.98	651332	
70	Downlink & Uplink	Low	3735	649000	30
		Mid	3750	650000	
		High	3765	651000	
80	Downlink & Uplink	Low	3740.01	649334	30
		Mid	3750	650000	
		High	3759.99	650666	
90	Downlink & Uplink	Low	3745.02	649668	30
		Mid	3750	650000	
		High	3754.98	650332	
100	Downlink & Uplink	Low	/	/	30
		Mid	3750	650000	
		High	/	/	

**3450-3550:**

CBW [MHz]	Range		Carrier centre [MHz]	Carrier centre [ARFCN]	SS block SCS [kHz]
20	Downlink & Uplink	Low	3460.02	630668	30
		Mid	3500.01	633334	
		High	3540	636000	
30	Downlink & Uplink	Low	3465	631000	30
		Mid	3500.01	633334	
		High	3534.99	635666	
40	Downlink & Uplink	Low	3470.01	631334	30
		Mid	3500.01	633334	
		High	3530.01	635334	
50	Downlink & Uplink	Low	3475.02	631668	30
		Mid	3500.01	633334	
		High	3525	635000	
60	Downlink & Uplink	Low	3480	632000	30
		Mid	3500.01	633334	
		High	3519.99	634666	
70	Downlink & Uplink	Low	3485.01	632334	30
		Mid	3500.01	633334	
		High	3515.01	634334	
80	Downlink & Uplink	Low	3490.02	632668	30
		Mid	3500.01	633334	
		High	3510	634000	
90	Downlink & Uplink	Low	3495	633000	30
		Mid	3500.01	633334	
		High	3504.99	633666	
100	Downlink & Uplink	Low	¥	¥	30
		Mid	3500.01	633334	
		High	¥	¥	

### 3.2 Test Environment

Applicable to	Environmental conditions	Input Power	Tested by
Transmitter Conducted Power Output	24.5°C, 52 % RH	120Vac, 60Hz	Simba Huang
Peak-Average Ratio	24.5°C, 52 % RH	120Vac, 60Hz	Simba Huang
Modulation Characteristics	24.5°C, 52 % RH	120Vac, 60Hz	Simba Huang
Bandwidth	24.5°C, 52 % RH	120Vac, 60Hz	Simba Huang
Emission Mask	24.5°C, 52 % RH	120Vac, 60Hz	Simba Huang
Spurious Emission at Antenna Terminals	24.5°C, 53 % RH	120Vac, 60Hz	Simba Huang
Field Strength of Spurious Radiation	24.4°C, 53 % RH	120Vac, 60Hz	Simba Huang
Frequency Stability	24.5°C, 52 % RH	120Vac, 60Hz	Simba Huang

The applicant declare the operating environment of EUT as below:

Normal conditions: 5.1V DC, 15°C ~35°C

Extreme conditions: 4.59V DC~5.61V DC, -10°C ~50°C

VL= lower extreme test voltage, VN= nominal voltage, VH= upper extreme test voltage

TL= lower extreme test temperature, TN= normal temperature, TH= upper extreme test temperature



### 3.3 Test Instruments

No	Test Equipment	Manufacturer	Model No	Serial No	Cal. Date	Cal. Due Date
1	Spectrum Analyzer	R&S	FSV40	101470	2022.09.02	2023.09.01
2	EMI Measuring Receiver	R&S	ESR	101660	2022.09.02	2023.09.01
3	Low Noise Pre Amplifier	HP	HP8447E	1937A01855	2022.09.02	2023.09.01
4	Low Noise Pre Amplifier	Tsj	MLA-0120-A02-34	2648A04738	2022.09.02	2023.09.01
5	Passive Loop	ETS	6512	00165355	2020.09.05	2022.09.04
6	TRILOG Super Broadband test Antenna	SCHWARZBECK	VULB9160	9160-3206	2021.08.29	2024.08.28
7	Broadband Horn Antenna	SCHWARZBECK	BBHA9120D	452	2021.08.29	2024.08.28
8	SHF-EHF Horn Antenna 15-40GHz	SCHWARZBECK	BBHA9170	BBHA9170367d	2020.11.24	2023.11.23
9	EMI Test Receiver	R&S	ESCI	100124	2022.09.02	2023.09.01
10	LISN	Kyoritsu	KNW-242	8-837-4	2022.09.02	2023.09.01
11	LISN	R&S	ESH3-Z2	0357.8810.54-101161-S2	2022.09.02	2023.09.01
12	Pro.Temp&Humi.chamber	MENTEK	MHP-150-1C	MAA08112501	2022.09.02	2023.09.01
13	RF Automatic Test system	MW	MW100-RFCB	21033016	2022.09.02	2023.09.01
14	Signal Generator	Agilent	N5182A	MY50143009	2022.09.02	2023.09.01
15	Radio Communication Tester	Anritsu	MT8000A	1201.0002K66	2022.09.02	2023.09.01
16	RF Automatic Test system	MW	MW100-RFCB	21033016	2022.09.02	2023.09.01
17	DC power supply	ZHAOXIN	RXN-305D-2	28070002559	N/A	N/A
18	RE Software	EZ	EZ-EMC_RE	Ver.AIT-03A	N/A	N/A
19	CE Software	EZ	EZ-EMC_CE	Ver.AIT-03A	N/A	N/A
20	RF Software	MW	MTS 8310	2.0.0.0	N/A	N/A
21	temporary antenna connector(Note)	NTS	R001	N/A	N/A	N/A
22	Spectrum Analyzer	Agilent	N9020A	MT21033052	2022.09.02	2023.09.01

Note: The temporary antenna connector is soldered on the PCB board in order to perform conducted tests and this temporary antenna connector is listed in the equipment list.

### 3.4 Measurement Uncertainty

Where relevant, the following measurement uncertainty levels have been estimated for tests performed on the EUT.

This uncertainty represents an expanded uncertainty expressed at approximately the 95% confidence level using a coverage factor of k=2.

Uncertainty	
Parameter	Uncertainty
Occupied Channel Bandwidth	±142.08KHz
RF power conducted	±0.74dB
Band Edge Compliance	±1.24dB
Frequency stability	±0.12 ppm
Spurious emissions, radiated (0.009MHz~30MHz)	3.10dB
Spurious emissions, radiated (30MHz~1GHz)	3.75dB
Spurious emissions, radiated (1GHz~18GHz)	3.88dB
Spurious emissions, radiated (18GHz ~ 40GHz)	3.88dB
Humidity	±4.0%
Temperature	±0.5°C
Time	±1.20%

### 3.5 Test Location

Company:	Dongguan Yaxu (AiT) Technology Limited
Address:	No.22, Jinqianling 3rd Street, Jitigang, Huangjiang,Dongguan, Guangdong, China
CNAS Registration Number:	CNAS L14158
A2LA Registration Number:	6317.01
FCC Accredited Lab. Designation Number:	CN1313
FCC Test Firm Registration Number:	703111

### 3.6 Deviation from Standards

None

### 3.7 Abnormalities from Standard Conditions

None

## 4. Test Setup and Conditions

### 4.1 Test Setup 1

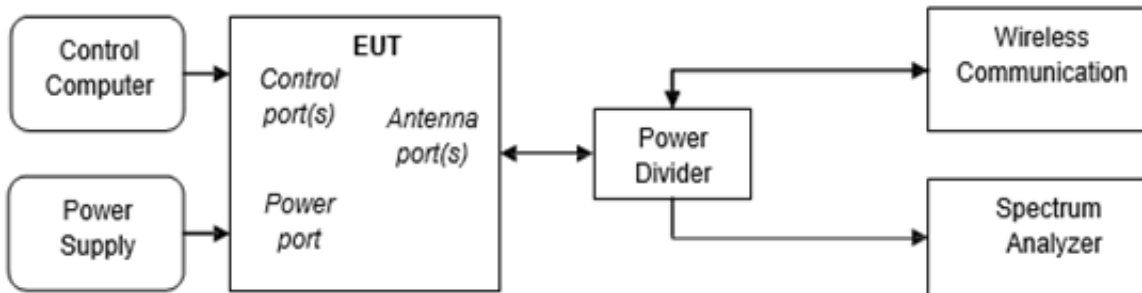

### 4.2 Test Setup 2

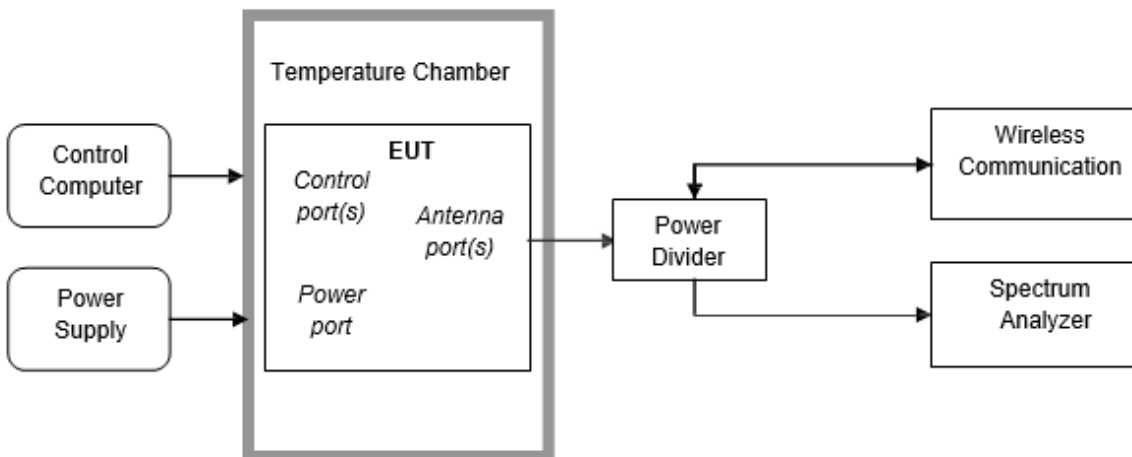

### 4.3 Test Setup 3

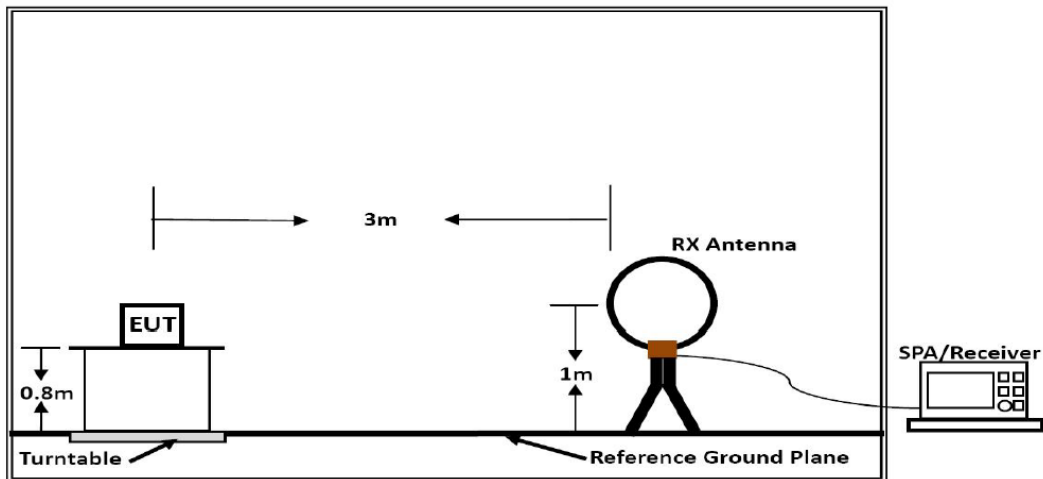

**Below 30MHz**

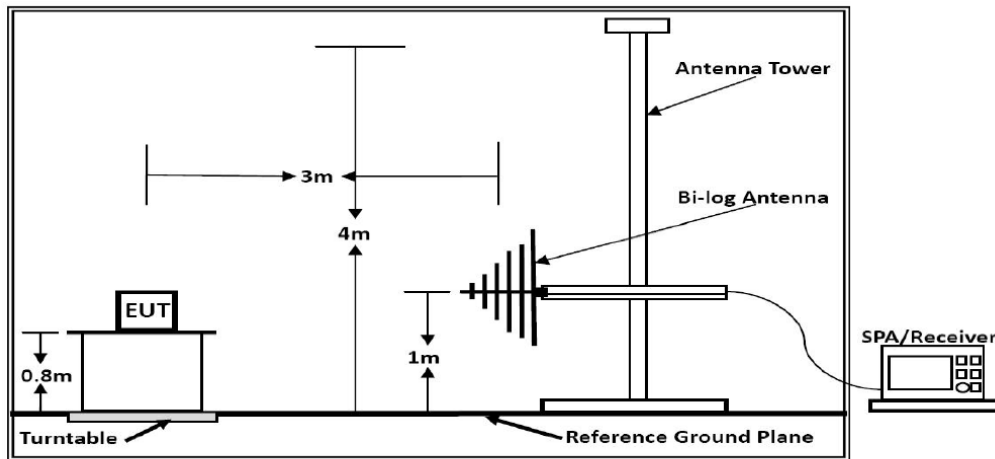

**Below 1GHz**

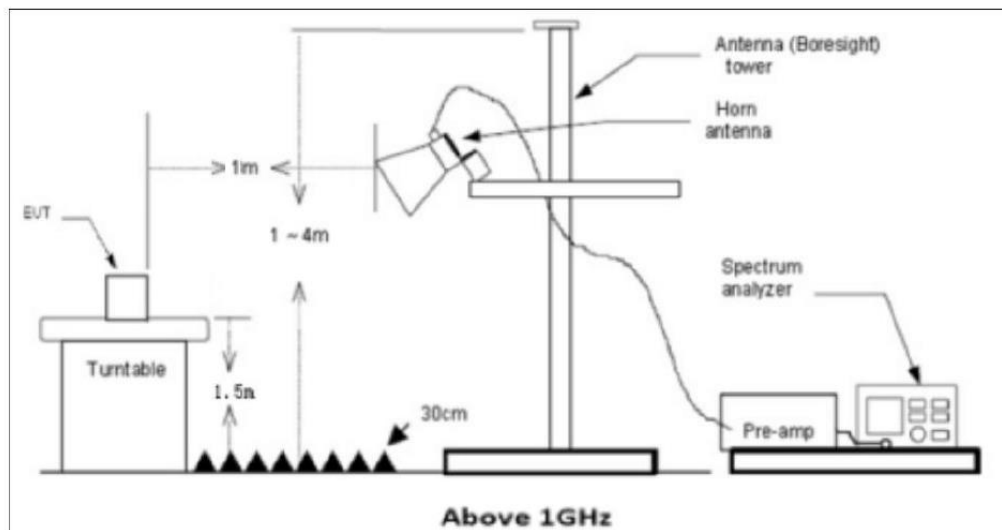

**Above 1GHz**

## 5. Description of Tests

### 5.1 Effective (Isotropic) Radiated Power

Calculate power in dBm by the following formula:

ERP (dBm) = Conducted Power (dBm) + antenna gain (dBd)

EIRP(dBm) = Conducted Power (dBm) + antenna gain (dBi)

EIRP=ERP+2.15dB

#### Test Procedures Used

FCC KDB 971168 D01 V03r01 Section 5.8.4 ;

Note: Reference test setup 1

#### Test Result

Please refer to

AIT23121308FW1\_Test Data\_N41(2496-2690)

AIT23121308FW1\_Test Data\_N77(3450-3550)

AIT23121308FW1\_Test Data\_N77(3700-3980)

AIT23121308FW1\_Test Data\_N78(3450-3550)

AIT23121308FW1\_Test Data\_N78(3700-3800)

## 5.2 Peak-Average Ratio

A peak to average ratio measurement is performed at the conducted port of the EUT. For WCDMA signals, the spectrum analyzers Complementary Cumulative Distribution Function (CCDF) measurement profile is used to determine the largest deviation between the average and the peak power of the EUT in a given bandwidth. The CCDF curve shows how much time the peak waveform spends at or above a given average power level. The percent of time the signal spends at or above the level defines the probability for that particular power level. For GSM signals, an average and a peak trace are used on a spectrum analyzer to determine the largest deviation between the average and the peak power of the EUT in a bandwidth greater than the emission bandwidth. The traces are generated with the spectrum analyzer set to zero span mode.

### Test Settings

1. The signal analyzer's CCDF measurement profile is enabled
2. Frequency = carrier center frequency
3. Measurement BW > Emission bandwidth of signal
4. The signal analyzer was set to collect one million samples to generate the CCDF curve
5. The measurement interval was set depending on the type of signal analyzed. For continuous signals (>98% duty cycle), the measurement interval was set to 1ms. For burst transmissions, the spectrum analyzer is set to use an internal "RF Burst" trigger that is synced with an incoming pulse and the measurement interval is set to less than the duration of the "on time" of one burst to ensure that energy is only captured during a time in which the transmitter is operating at maximum power

### **Test Procedures Used**

FCC KDB 971168 D01 V03r01 Section 5.7.2

Note: Reference test setup 1

### **Test result**

Please refer to

AIT23121308FW1\_Test Data\_N41(2496-2690)

AIT23121308FW1\_Test Data\_N77(3450-3550)

AIT23121308FW1\_Test Data\_N77(3700-3980)

AIT23121308FW1\_Test Data\_N78(3450-3550)

AIT23121308FW1\_Test Data\_N78(3700-3800)

### 5.3 Occupied Bandwidth

The occupied bandwidth, that is the frequency bandwidth such that, below its lower and above its upper frequency limits, the mean powers radiated are each equal to 0.5 percent of the total mean power radiated by a given emission shall be measured. The transmitter output was connected to a calibrated coaxial cable, attenuator and Spectrum analyser, the other end of which was connected to a Base Station Simulator. The Base Station Simulator was set to force the EUT to its maximum power setting. The tests were performed at three frequencies (low channel, middle channel and high channel). The span of the analyzer shall be set to capture all products of the modulation process, including the emission skirts. The resolution bandwidth shall be set to as close to 1 percent of the selected span as is possible without being below 1 percent. The video bandwidth shall be set to 3 times the resolution bandwidth. Video averaging is not permitted. Where practical, a sampling detector shall be used since a peak or, peak hold, may produce a wider bandwidth than actual. The trace data points are recovered and are directly summed in linear terms. The recovered amplitude data points, beginning at the lowest frequency, are placed in a running sum until 0.5 percent of the total is reached and that frequency recorded. The process is repeated for the highest frequency data points. This frequency is recorded. The span between the two recorded frequencies is the occupied bandwidth.

#### Test Procedures Used:

FCC KDB 971168 D01 V03r01 Section 4.2 & 4.3

#### Test Settings

1. The signal analyzer's automatic bandwidth measurement capability was used to perform the 99% occupied bandwidth and the 26dB bandwidth. The bandwidth measurement was not influenced by any intermediate power nulls in the fundamental emission.
2. RBW = 1 – 5% of the expected OBW
3. VBW  $\geq$  3 x RBW
4. Detector = Peak
5. Trace mode = max hold
6. Sweep = auto couple
7. The trace was allowed to stabilize
8. If necessary, steps 2 – 7 were repeated after changing the RBW such that it would be within 1 – 5% of the 99% occupied bandwidth observed in Step 7

Note: Reference test setup 1.

#### Test Result

Please refer to

AIT23121308FW1\_Test Data\_N41(2496-2690)

AIT23121308FW1\_Test Data\_N77(3450-3550)

AIT23121308FW1\_Test Data\_N77(3700-3980)

AIT23121308FW1\_Test Data\_N78(3450-3550)

AIT23121308FW1\_Test Data\_N78(3700-3800)

## 5.4 Band Edge Compliance

The transmitter output was connected to a calibrated coaxial cable, attenuator and Spectrum analyser, the other end of which was connected to a Base Station Simulator. The Base Station Simulator was set to force the EUT to its maximum power setting. The tests were performed at three frequencies (low channel and high channel).in the 1MHz bands immediately outside and adjacent to the frequency block a resolution bandwidth of 100kHz or 1% of the emission bandwidth of the fundamental emission of the transmitter may be employed. The EUT emission bandwidth is measured as the width of the signal between two points, outside of which all emission are attenuated at least 26dB below the transmitter power. The video bandwidth of the spectrum analyzer was set at thrice the resolution bandwidth. Detector Mode was set to peak or peak hold power.

### Test Procedures Used

FCC KDB 971168 D01 V03r01 Section 6.0

#### Test Settings

1. Start and stop frequency were set such that the band edge would be placed in the center of the plot
2. Span was set large enough so as to capture all out of band emissions near the band edge
3. RBW  $\geq$  1% of the emission bandwidth
4. VBW  $\geq$  3 x RBW
5. Detector = RMS
6. Number of sweep points  $\geq$  2 x Span/RBW
7. Trace mode = trace average for continuous emissions, max hold for pulse emissions
8. Sweep time = auto couple
9. The trace was allowed to stabilize

Note: Reference test setup 1.

### Test Result

Please refer to

AIT23121308FW1\_Test Data\_N41(2496-2690)

AIT23121308FW1\_Test Data\_N77(3450-3550)

AIT23121308FW1\_Test Data\_N77(3700-3980)

AIT23121308FW1\_Test Data\_N78(3450-3550)

AIT23121308FW1\_Test Data\_N78(3700-3800)



## 5.5 Spurious and Harmonic Emissions at Antenna Terminal

The transmitter output was connected to a calibrated coaxial cable, attenuator and Spectrum analyzer, the other end of which was connected to a Base Station Simulator. The Base Station Simulator was set to force the EUT to its maximum power setting. The tests were performed at three frequencies (low channel and high channel). The level of the carrier and the various conducted spurious and harmonic frequencies is measured by means of a calibrated spectrum analyzer. The spectrum is scanned from the lowest frequency generated in the equipment up to a frequency including its 10th harmonic. On any frequency outside a licensee's frequency block, the power of any emission shall be attenuated below the transmitter power (P) by at least  $43 + 10 \log(P)$  dB. Compliance with these provisions is based on the use of measurement instrumentation employing a resolution bandwidth of 1 MHz or greater. However, in the 1 MHz bands immediately outside and adjacent to the frequency block a resolution bandwidth of at least one percent of the emission bandwidth of the fundamental emission of the transmitter may be employed. The emission bandwidth is defined as the width of the signal between two points, one below the carrier center frequency and one above the carrier center frequency, outside of which all emission are attenuated at least 26 dB below the transmitter power.

### Test Procedures Used

FCC KDB 971168 D01 V03r01 Section 6.0

### Test Settings

1. Start frequency was set to 30MHz and stop frequency was set to at least  $10 \times$  the fundamental frequency (separated into at least two plots per channel)
2. Detector = RMS
3. Trace mode = trace average for continuous emissions, max hold for pulse emissions
4. Sweep time = auto couple
5. The trace was allowed to stabilize
6. Please see test notes below for RBW and VBW settings

Note: Reference test setup 1.

### Test Result:

Please refer to

AIT23121308FW1\_Test Data\_N41(2496-2690)

AIT23121308FW1\_Test Data\_N77(3450-3550)

AIT23121308FW1\_Test Data\_N77(3700-3980)

AIT23121308FW1\_Test Data\_N78(3450-3550)

AIT23121308FW1\_Test Data\_N78(3700-3800)

## 5.6 Field Strength of Spurious Radiation

### Below 1GHz test procedure as below:

- 1). The EUT was powered ON and placed on a 80cm high table in the chamber. The antenna of the transmitter was extended to its maximum length.
- 2). The disturbance of the transmitter was maximized on the test receiver display by raising and lowering from 1m to 4m (for the test frequency of below 30MHz, the antenna was tuned to heights 1 meter) the receive antenna and by rotating through 360° the turntable. After the fundamental emission was maximized, a field strength measurement was made.
- 3). Steps 1) and 2) were performed with the EUT and the receive antenna in both vertical and horizontal polarization.
- 4). Test the EUT in the lowest channel, the middle channel ,the Highest channel.
- 5). The radiation measurements are performed in X, Y, Z axis positioning. And found the X axis positioning which it is worse case, Only the test worst case mode is recorded in the report.
- 6). Repeat above procedures until all frequencies measured was complete.

$$E \text{ (dB}\mu\text{V/m)} = \text{Measured amplitude level (}\mu\text{V/m)} + (\text{Cable Loss (dB)} + \text{Antenna Factor (dB/m)} - \text{AMP(dB)})$$

$$\text{EIRP (dBm)} = E \text{ (dB}\mu\text{V/m)} + 20 \log D - 104.8; \text{ where D is the measurement distance in meters}$$

### Above 1GHz test procedure as below:

- 1) Different between above is the test site, change from Semi- Anechoic Chamber to fully Anechoic Chamber
- 2) Calculate power in dBm by the following formula:  
$$E \text{ (dB}\mu\text{V/m)} = \text{Measured amplitude level (dB}\mu\text{V)} + (\text{Cable Loss (dB)} + \text{Antenna Factor (dB/m)} - \text{AMP(dB)})$$
$$\text{EIRP (dBm)} = E \text{ (dB}\mu\text{V/m)} + 20 \log D - 104.8; \text{ where D is the measurement distance in meters}$$
- 3). Test the EUT in the lowest channel, the middle channel the Highest channel
- 4). The radiation measurements are performed in X, Y, Z axis positioning. And found the X axis positioning which it is worse case, Only the test worst case mode is recorded in the report.
- 5). Repeat above procedures until all frequencies measured was complete

The emission below 18G were measured at a 3m test distance, while emissions above 18GHz were measured at a 1m test distance.

### Remark:

- 1) The field strength is calculated by adding the Antenna Factor, Cable Factor & Preamplifier gain. The basic equation with a sample calculation is as follows:

$$\text{Level} = \text{Reading Level} + \text{AF(dB/m)} + \text{Factor(dB)}$$

$$\text{AF} = \text{Antenna Factor(dB/m)}$$

$$\text{Factor} = \text{Cable Factor(dB)} - \text{Preamplifier gain (dB)}$$

$$\text{Margin} = \text{Limit(dBm)} - \text{Level(dBm)}$$

- 2) Scan from 9kHz to 40GHz, The disturbance between 9KHz to 30MHz and 18GHz to 40GHz was very low, and the harmonics were the highest point could be found when testing, so only the harmonics



had been displayed. The amplitude of spurious emissions from the radiator which are attenuated more than 20dB below the limit need not be reported.

3) All modes have been tested, but only the worst case data displayed in this report.

**Test Procedures Used**

FCC KDB 971168 D01 V03r01 Section 5.8

Note: Reference test setup 3.

**Test Result:**

**LTE Band 41\_TX Mode  
Low channel**

Frequency (MHz)	Polarity (H/V)	Emission Level (dBm)	Limit (dBm)	Margin (dB)
5580	V	-40.42	-25	-15.42
3720	V	-39.69	-25	-14.69
678.6	V	-41.27	-25	-16.27
426.7	V	-48.02	-25	-23.02
5580	H	-38.78	-25	-13.78
3720	H	-40.1	-25	-15.1
676.1	H	-45.26	-25	-20.26
43.15	H	-48.02	-25	-23.02

**Middle channel**

Frequency (MHz)	Polarity (H/V)	Emission Level (dBm)	Limit (dBm)	Margin (dB)
5640	V	-40.22	-25	-15.22
3760	V	-39.16	-25	-14.16
825.6	V	-46.35	-25	-21.35
625.07	V	-42.47	-25	-17.47
5640	H	-48.2	-25	-23.2
3760	H	-40.84	-25	-15.84
801.78	H	-42.95	-25	-17.95
725.5	H	-48.95	-25	-23.95

**High channel**

Frequency (MHz)	Polarity (H/V)	Emission Level (dBm)	Limit (dBm)	Margin (dB)
5700	V	-40.44	-25	-15.44
3800	V	-41.05	-25	-16.05
652.5	V	-45.25	-25	-20.25
565.1	V	-46.12	-25	-21.12
5700	H	-38.99	-25	-13.99
3800	H	-38.27	-25	-13.27
6593	H	-46.28	-25	-21.28
531.8	H	-46.01	-25	-21.01

**LTE Band 77\_TX Mode  
Low channel**

Frequency (MHz)	Polarity (H/V)	Emission Level (dBm)	Limit (dBm)	Margin (dB)
5160	V	-40.98	-13	-27.98
3440	V	-41.28	-13	-28.28
776.5	V	-43.54	-13	-30.54
511.5	V	-46.3	-13	-33.3
5160	H	-41.36	-13	-28.36
3440	H	-41.95	-13	-28.95
521.9	H	-45.67	-13	-32.67
385.9	H	-45.8	-13	-32.8

**Middle channel**

Frequency (MHz)	Polarity (H/V)	Emission Level (dBm)	Limit (dBm)	Margin (dB)
5197.5	V	-40.02	-13	-27.02
3465	V	-39.95	-13	-26.95
662.5	V	-48.22	-13	-35.22
531.9	V	-44.02	-13	-31.02
5197.5	H	-40.99	-13	-27.99
3465	H	-39.68	-13	-26.68
530.7	H	-46.69	-13	-33.69
446.3	H	-45.55	-13	-32.55

**High channel**

Frequency (MHz)	Polarity (H/V)	Emission Level (dBm)	Limit (dBm)	Margin (dB)
5235	V	-39.72	-13	-26.72
3490	V	-40.08	-13	-27.08
706.2	V	-48.42	-13	-35.42
515.7	V	-49.02	-13	-36.02
5235	H	-39.53	-13	-26.53
3490	H	-40.58	-13	-27.58
611.5	H	-45.59	-13	-32.59
549.1	H	-46.1	-13	-33.1

**LTE Band 78\_TX Mode  
Low channel**

Frequency (MHz)	Polarity (H/V)	Emission Level (dBm)	Limit (dBm)	Margin (dB)
2110.5	V	-28.1	-13	-15.1
1406.79	V	-34.03	-13	-21.03
666.2	V	-34.18	-13	-21.18
501.53	V	-30.58	-13	-17.58
2110.5	H	-26.52	-13	-13.52
1406.79	H	-34.81	-13	-21.81
619.78	H	-34.5	-13	-21.5
498.5	H	-36.13	-13	-23.13

**Middle channel**

Frequency (MHz)	Polarity (H/V)	Emission Level (dBm)	Limit (dBm)	Margin (dB)
2121.63	V	-27.75	-13	-14.75
1414.25	V	-34.61	-13	-21.61
686.05	V	-34.76	-13	-21.76
525.6	V	-33.23	-13	-20.23
2121.63	H	-26.58	-13	-13.58
1414.25	H	-35.08	-13	-22.08
646.8	H	-36.2	-13	-23.2
575.6	H	-36.5	-13	-23.5

**High channel**

Frequency (MHz)	Polarity (H/V)	Emission Level (dBm)	Limit (dBm)	Margin (dB)
2132.24	V	-28.15	-13	-15.15
1421.44	V	-34.44	-13	-21.44
635.22	V	-33.6	-13	-20.6
585.2	V	-33.62	-13	-20.62
2132.24	H	-26.96	-13	-13.96
1421.44	H	-34.94	-13	-21.94
622.56	H	-35.73	-13	-22.73
585.9	H	-34.58	-13	-21.58

## 5.7 Frequency Stability / Temperature Variation

The frequency stability of the transmitter is measured by:

- a.) Temperature: The temperature is varied from -10°C to +50°C in 10°C increments using an environmental chamber.
- b.) Primary Supply Voltage: The primary supply voltage is varied from 85% to 115% of the nominal value for non hand-carried battery and AC powered equipment. For hand-carried, battery-powered equipment, primary supply voltage is reduced to the battery operating end point which shall be specified by the manufacturer. Specification – The frequency stability shall be sufficient to ensure that the fundamental emission stays within the authorized frequency block. The frequency stability of the transmitter shall be maintained within  $\pm 0.00025\%$  ( $\pm 2.5$  ppm ) of the center frequency.

Time Period and Procedure:

1. The carrier frequency of the transmitter is measured at room temperature (20°C to provide a reference).
2. The equipment is turned on in a “standby” condition for fifteen minutes before applying power to the transmitter. Measurement of the carrier frequency of the transmitter is made within one minute after applying power to the transmitter.
3. Frequency measurements are made at 10°C intervals ranging from -10°C to +50°C. A period of at least one half-hour is provided to allow stabilization of the equipment at each temperature level.

### Test Procedures Used

Frequency stability testing is performed in accordance with the guidelines of FCC KDB 971168 D01 V03r01 Section 9

Note: Reference test setup 2.

### Test Result

PASS

Please refer to

AIT23121308FW1\_Test Data\_N41(2496-2690)

AIT23121308FW1\_Test Data\_N77(3450-3550)

AIT23121308FW1\_Test Data\_N77(3700-3980)

AIT23121308FW1\_Test Data\_N78(3450-3550)

AIT23121308FW1\_Test Data\_N78(3700-3800)

---

(END OF REPORT)