

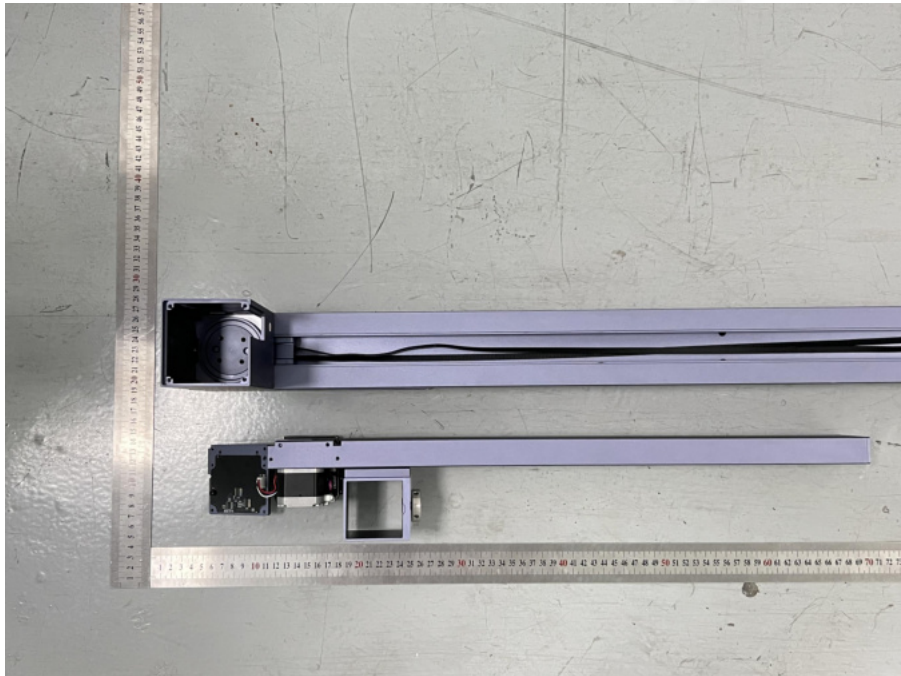

## EUT PHOTO(Internal Photos)

Test Mode: LX1 Max

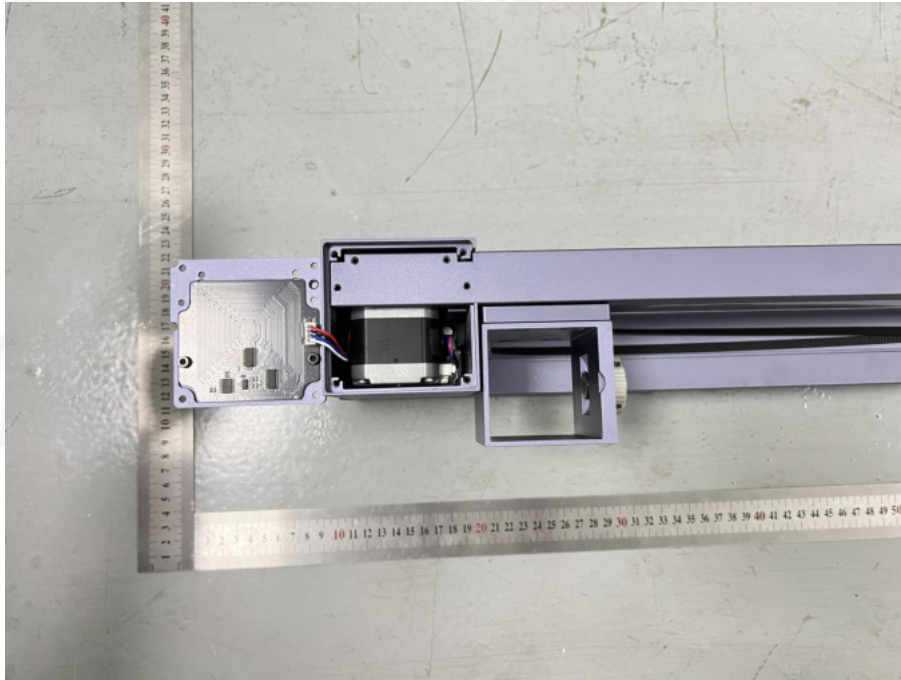

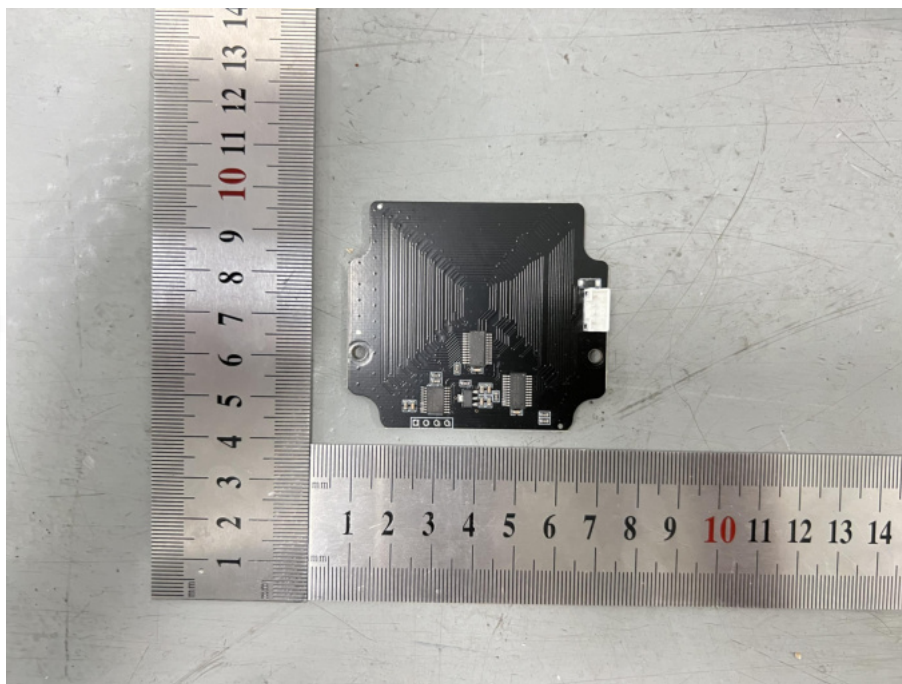
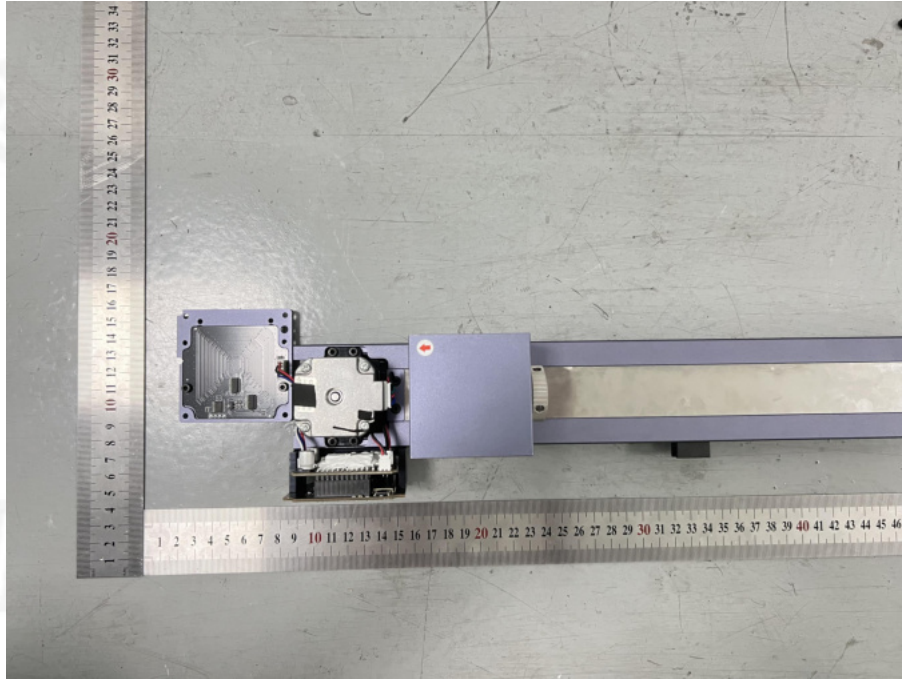



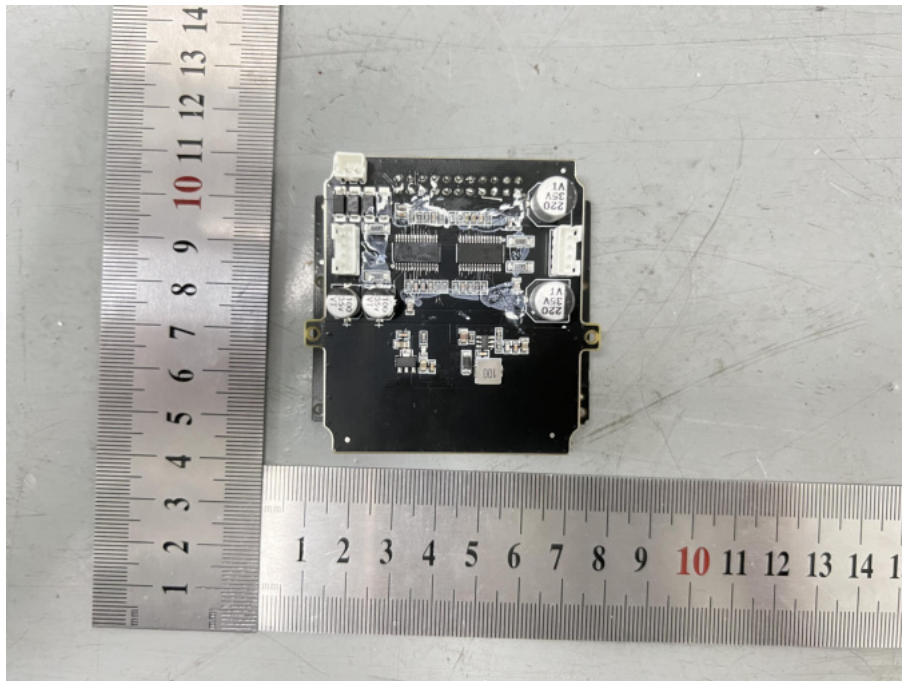
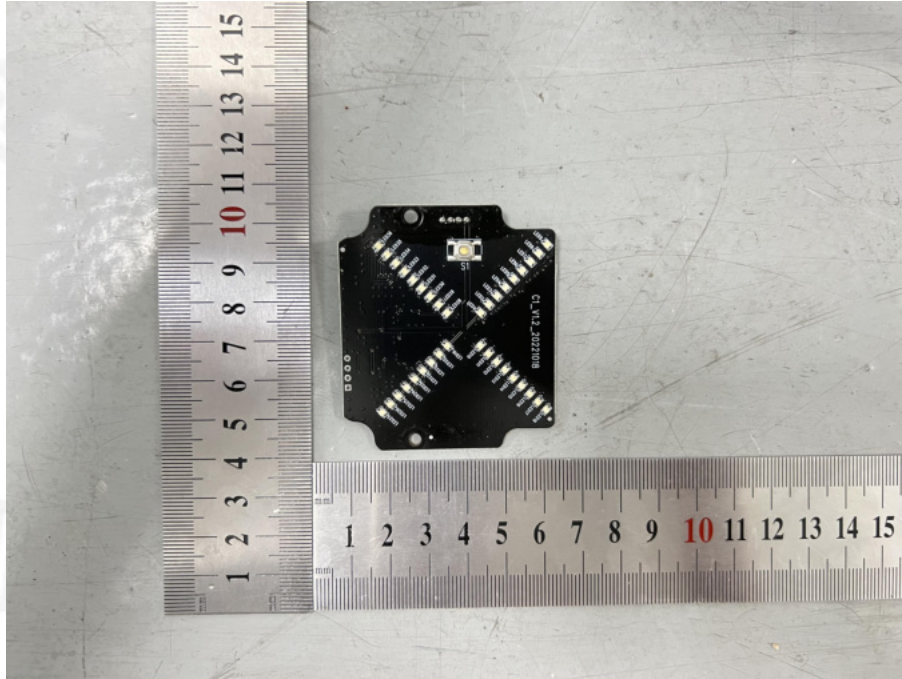

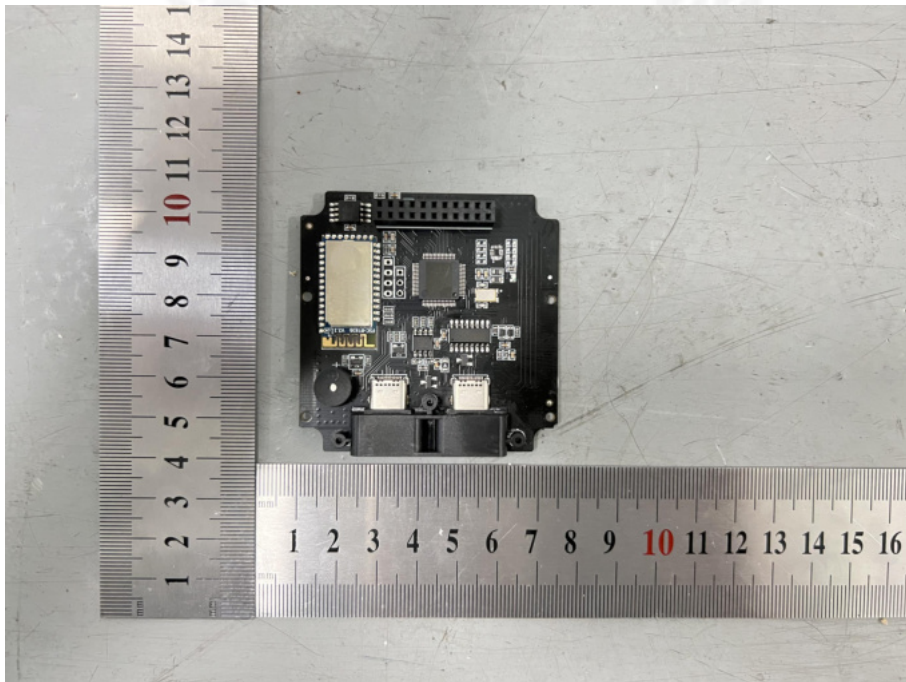
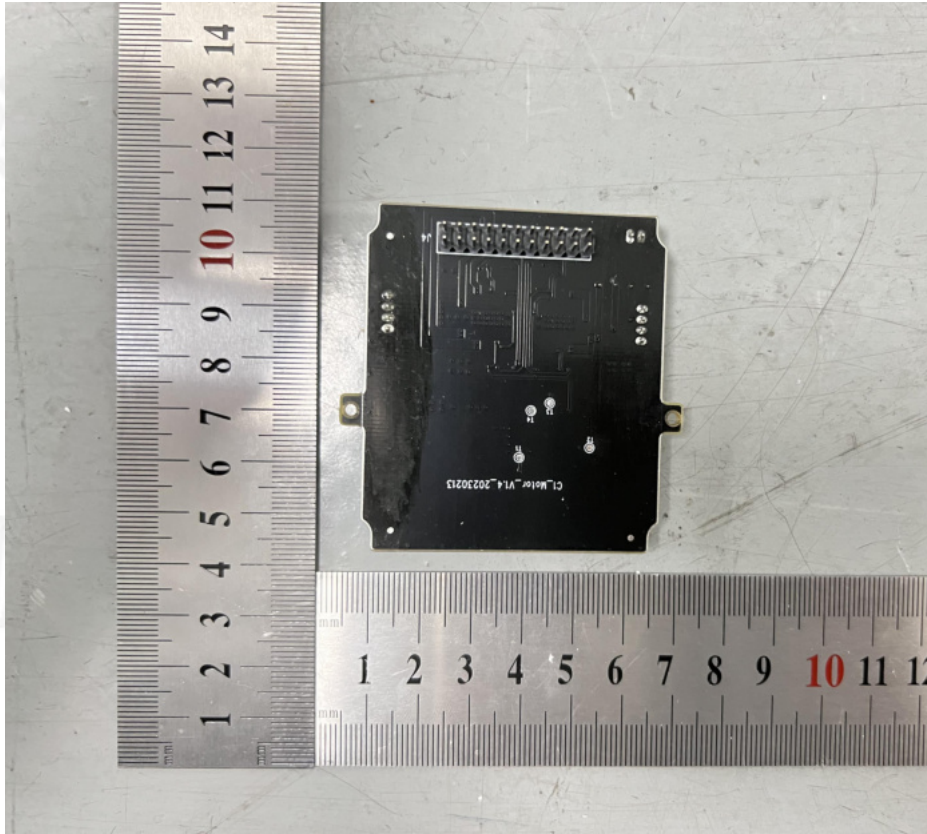



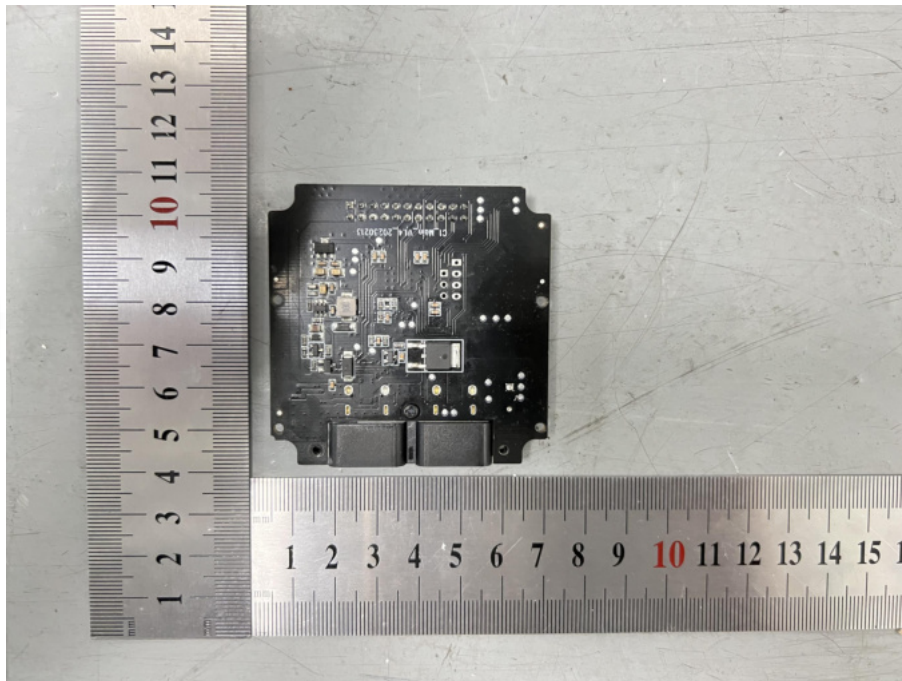
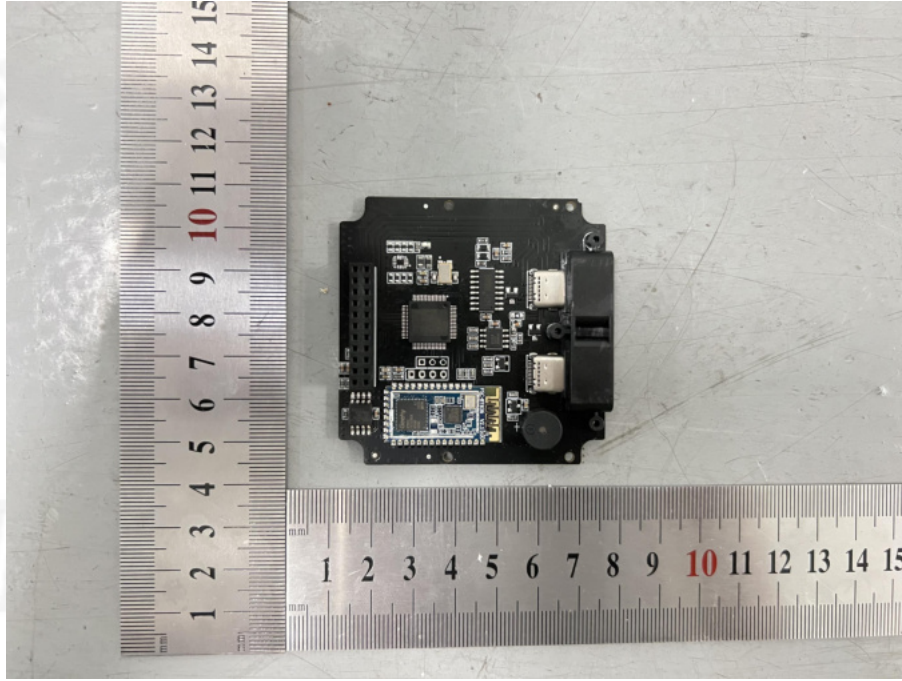

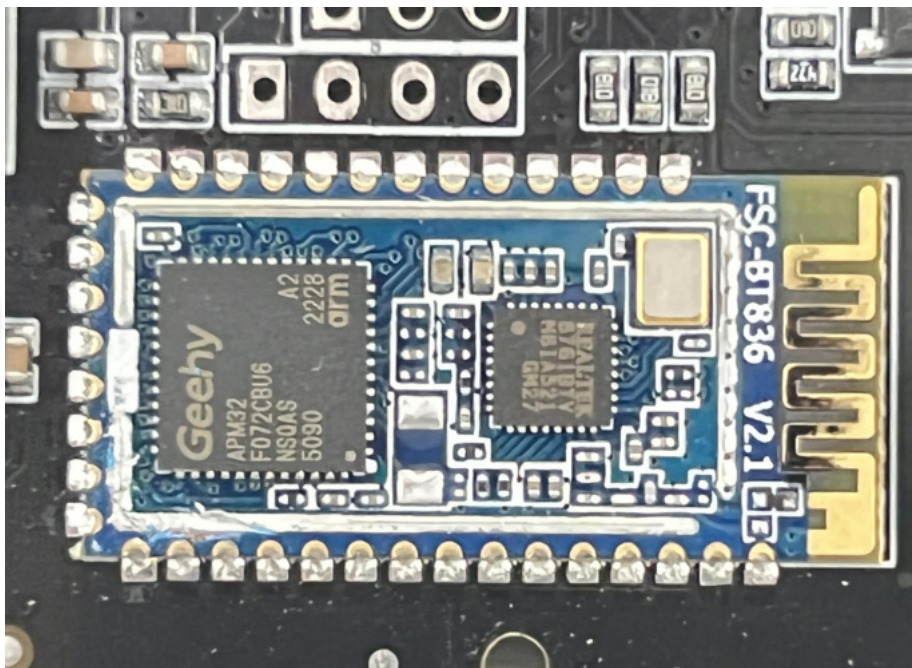
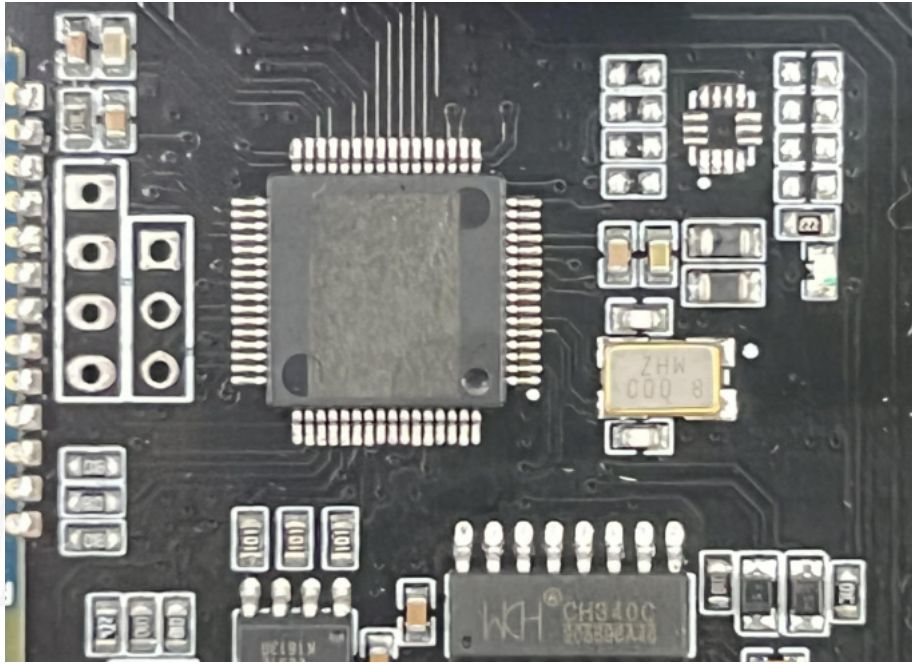



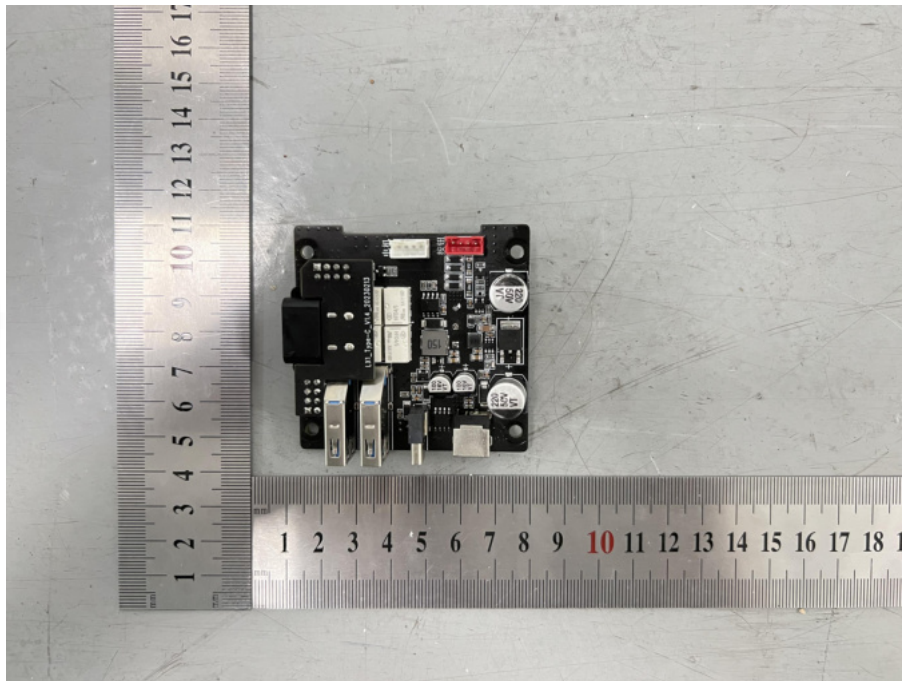
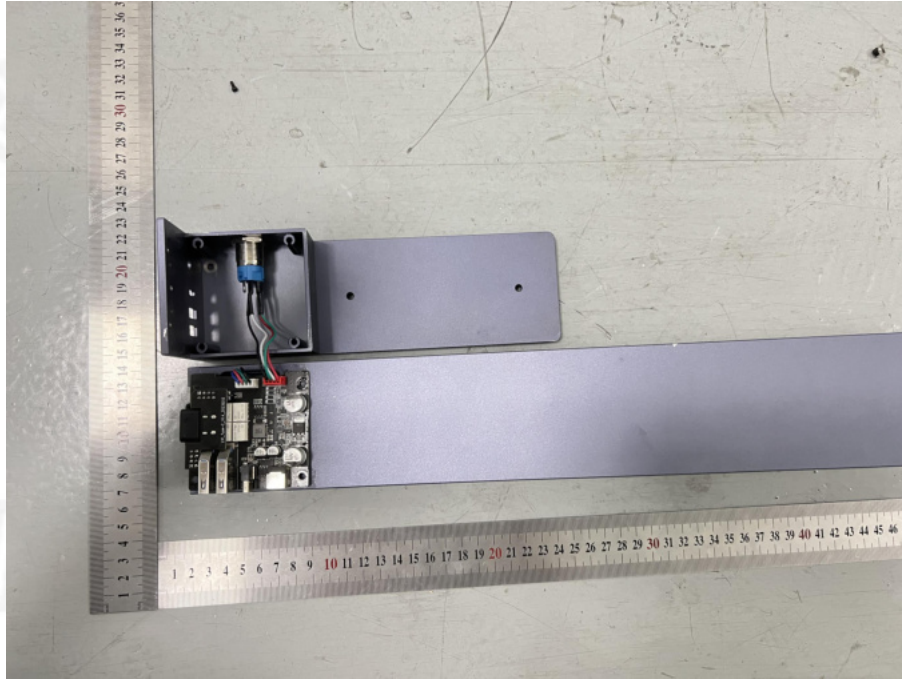

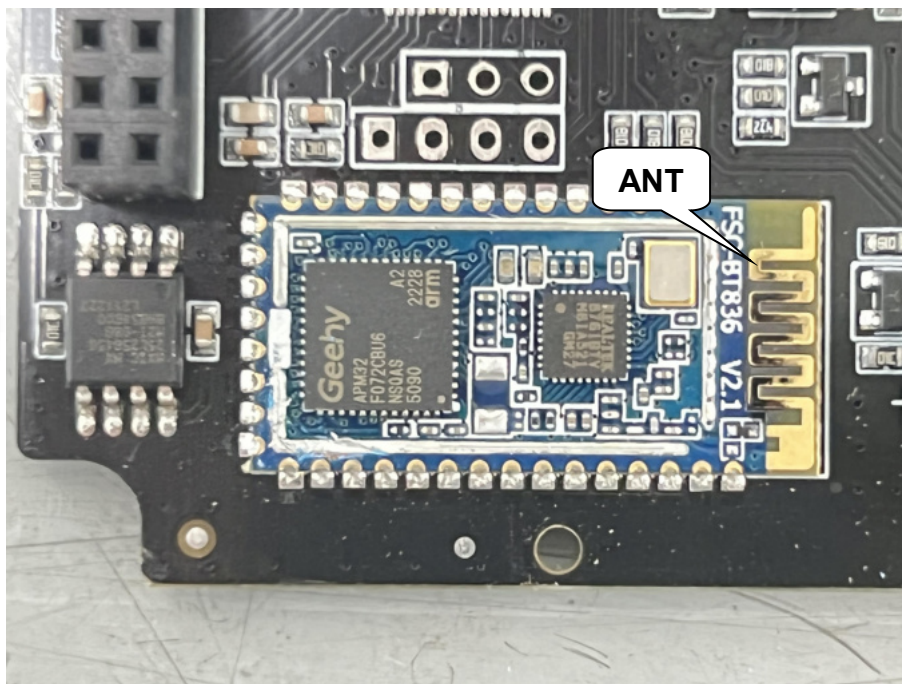
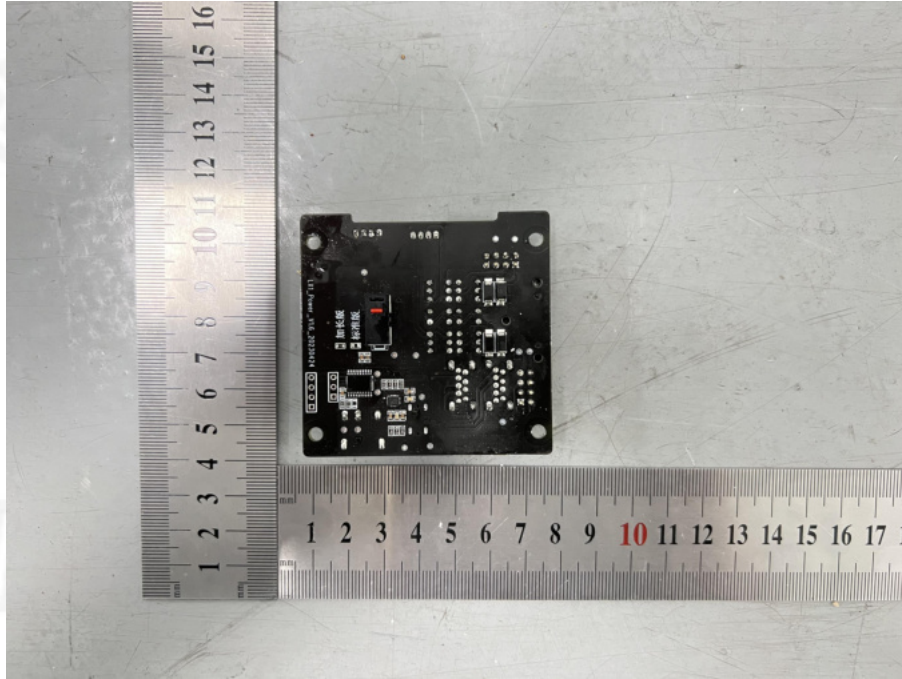

\*\*\*\*\* END OF REPORT \*\*\*\*\*