

FCC RADIO TEST REPORT

Applicant..... : Leader Lao Co., Ltd
Address..... : Lot333, Savan Park, Nongdeun, Kaysone Phomvihane, Savannakhet, Laos
Manufacturer..... : Leader Lao Co., Ltd
Address..... : Lot333, Savan Park, Nongdeun, Kaysone Phomvihane, Savannakhet, Laos
Factory..... : Leader Lao Co., Ltd
Address..... : Lot333, Savan Park, Nongdeun, Kaysone Phomvihane, Savannakhet, Laos
Product Name..... : Wireless charger
Brand Name..... : N/A
Model No. : WS21005
FCC ID..... : 2BAUN-WS21005
Measurement Standard..... : 47 CFR FCC Part 15, Subpart C
Receipt Date of Samples..... : September 19, 2024
Date of Tested..... : September 19, 2024 to September 25, 2024
Date of Report..... : September 26, 2024

This report shows that above equipment is technically compliant with the requirements of the standards above. All test results in this report apply only to the tested sample(s). Without prior written approval of Dongguan Nore Testing Center Co., Ltd, this report shall not be reproduced except in full.



Prepared by

Jenny Liu / Project Engineer



Approved by

Iori Fan / Authorized Signatory

Table of Contents

1. Summary of Test Result.....	4
2. General Description of EUT	5
3. Test Channels and Modes Detail.....	7
4. Configuration of EUT.....	7
5. Modification of EUT.....	7
6. Description of Support Device.....	7
7. Test Facility and Location	8
8. Applicable Standards and References.....	9
9. Deviations and Abnormalities from Standard Conditions	9
10. Test Conditions	9
11. Measurement Uncertainty	10
12. Sample Calculations	11
13. Test Items and Results	12
13.1 Conducted Emissions Measurement.....	12
13.2 Radiated Spurious Emissions and Restricted Bands Measurement.....	16
13.3 20dB Bandwidth Measurement.....	26
13.4 Antenna Requirement.....	28
14. Test Equipment List.....	29

1. Summary of Test Result

FCC Rules	Description of Test	Result	Remarks
§15.207 (a)	AC Power Conducted Emission	PASS	---
§15.209	Radiated Emissions	PASS	---
§15.215(c)	20dB Bandwidth	PASS	---
§15.203	Antenna Requirement	PASS	---

2. General Description of EUT

Product Information	
Product Name:	Wireless charger
Main Model Name:	WS21005
Additional Model Name:	N/A
Model Difference:	N/A
S/N:	2409-5219
Brand Name:	N/A
Hardware Version:	wirelesscharging-WS21005
Software Version:	leader.2021.11
Rating:	Input: DC 5V 2A, DC 9V 1.5A Output: 5W, 7.5W, 10W
Typical Arrangement:	Table-top
I/O Port:	Refer to user manual
Accessories Information	
Cable:	USB Line: 1.0m, unshielded, detachable
Other:	N/A
Additional Information	
Note:	N/A
Remark:	All the information above are provided by the manufacturer. More detailed feature of the EUT please refers to the user manual.

Technical Specification	
Frequency Range:	110.5-205KHz
Modulation Type:	FSK
Antenna Type:	Coil antenna
Output power for coil:	5W, 7.5W, 10W

3. Test Channels and Modes Detail

Mode		Modulation
1	Wireless Charging 5W	FSK
2	Wireless Charging 7.5W	FSK
3	Wireless Charging 10W	FSK

4. Configuration of EUT

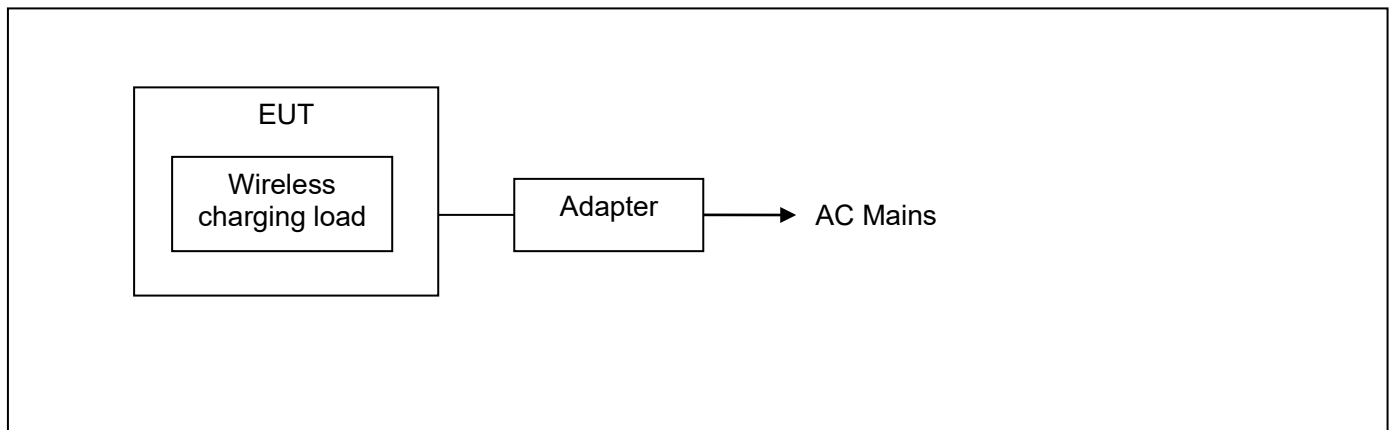

5. Modification of EUT

No modifications are made to the EUT during all test items.

6. Description of Support Device

The EUT has been tested as an independent unit together with other necessary accessories or support units. The following support units or accessories were used to form a representative test configuration during the tests.

No.	Equipment	Brand	M/N	S/N	Cable Specification	Remarks
1.	Wireless Charging Load	YBZ	001	---	---	Provided by the Lab.
2.	Adapter	HUAWEI	HW-059200CHQ	---	---	Provided by the Lab.

7. Test Facility and Location

Test Site	: Dongguan Nore Testing Center Co., Ltd. (Dongguan NTC Co., Ltd.)
Accreditations and Authorizations	<p>The Laboratory has been assessed and proved to be in compliance with CNAS/CL01 Listed by CNAS, August 13, 2018 The Certificate Registration Number is L5795. The Certificate is valid until August 13, 2030</p> <p>The Laboratory has been assessed and proved to be in compliance with ISO17025 Listed by A2LA, November 01, 2017 The Certificate Registration Number is 4429.01 The Certificate is valid until December 31, 2025</p> <p>Listed by FCC, November 06, 2017 Test Firm Registration Number: 907417</p> <p>Listed by Industry Canada, June 08, 2017 The Certificate Registration Number. Is 46405-9743A</p>
Test Site Location	: Building D, Gaosheng Science and Technology Park, Hongtu Road, Nancheng District, Dongguan City, Guangdong Province, China

8. Applicable Standards and References

According to the specifications of the manufacturer, the EUT must comply with the requirements of the following standards:

Test Standards:

47 CFR Part 15, Subpart C

ANSI C63.10-2013

References Test Guidance:

N/A

9. Deviations and Abnormalities from Standard Conditions

No additions, deviations and exclusions from the standard.

10. Test Conditions

No.	Test Item	Test Mode	Test Voltage	Tested by	Remarks
1.	AC Power Conducted Emission	1-3	AC 120V 60Hz	Chance Yuan	See note 1
2.	Radiated Emissions	1-3	AC 120V 60Hz	Chance Yuan	See note 1
3.	20dB Bandwidth	3	AC 120V 60Hz	Chance Yuan	See note 1
4.	Antenna Requirement	---	---	---	See note 1

Note:

- The testing climatic conditions for temperature, humidity, and atmospheric pressure are within: 15~35°C, 30~70%, 86~106kPa.
- AC 120V 60Hz is from the adapter.
- For test mode, only the worst case was recorded in this report.

11. Measurement Uncertainty

No.	Test Item	Frequency	Uncertainty	Remarks
1.	Conducted Emission	150KHz ~ 30MHz	±2.52 dB	---
2.	Radiated Emission Test	9kHz ~ 30MHz	±5.60 dB	---
		30MHz ~ 1GHz	±5.60 dB	---
		1GHz ~ 18GHz	±5.22 dB	---
		18GHz ~ 40GHz	±5.22 dB	---
3.	Conducted Spurious Emissions	10Hz ~ 40GHz	±1.02 dB	---
4.	RF Output Power	10Hz ~ 40GHz	±1.18 dB	
5.	Power Spectral Density	10Hz ~ 40GHz	±1.06 dB	
6.	Occupied Channel Bandwidth	---	±1.05 %	---

Note:

1. This uncertainty represents an expanded uncertainty expressed at approximately the 95% confidence level using a coverage factor of k=2.
2. The measurement uncertainty levels above are estimated and calculated according to CISPR 16-4-2.
3. The conformity assessment statement in this report is based solely on the test results, measurement uncertainty is excluded.

12. Sample Calculations

Conducted Emission						
Freq. (MHz)	Reading Level (dBuV)	Correct Factor (dB)	Measurement (dBuV)	Limit (dBuV)	Over (dB)	Detector
0.1500	35.52	9.98	45.50	65.57	-20.07	QP

Where,

Freq. = Emission frequency in MHz
 Reading Level = Spectrum Analyzer/Receiver Reading
 Corrector Factor = Insertion loss of LISN + Cable Loss + RF Switching Unit attenuation
 Measurement = Reading + Corrector Factor
 Limit = Limit stated in standard
 Margin = Measurement - Limit
 Detector = Reading for Quasi-Peak / Average / Peak

Radiated Spurious Emissions and Restricted Bands						
Freq. (MHz)	Reading Level (dBuV)	Correct Factor (dB/m)	Measurement (dBuV/m)	Limit (dBuV/m)	Over (dB)	Detector
43.5800	31.61	-6.81	24.80	40.00	-15.20	QP

Where,

Freq. = Emission frequency in MHz
 Reading Level = Spectrum Analyzer/Receiver Reading
 Corrector Factor = Antenna Factor + Cable Loss - Pre-amplifier
 Measurement = Reading + Corrector Factor
 Limit = Limit stated in standard
 Over = Margin, which calculated by Measurement - Limit
 Detector = Reading for Quasi-Peak / Average / Peak

Note: For all conducted test items, the spectrum analyzer offset or transducer is derived from RF cable loss and attenuator factor. The offset or transducer is equal to the RF cable loss plus attenuator factor.

13. Test Items and Results

13.1 Conducted Emissions Measurement

LIMITS

According to the requirements of FCC PART 15.207, the limits are as follows:

Frequency (MHz)	Quasi-peak	Average
0.15 to 0.5	66 to 56	56 to 46
0.5 to 5	56	46
5 to 30	60	50

Note: 1. If the limits for the average detector are met when using the quasi-peak detector, then the limits for the measurements with the average detector are considered to be met.
 2. The lower limit shall apply at the transition frequencies.
 3. The limit decreases linearly with the logarithm of the frequency in the range 0.15 MHz to 0.5MHz.

BLOCK DIAGRAM OF TEST SETUP

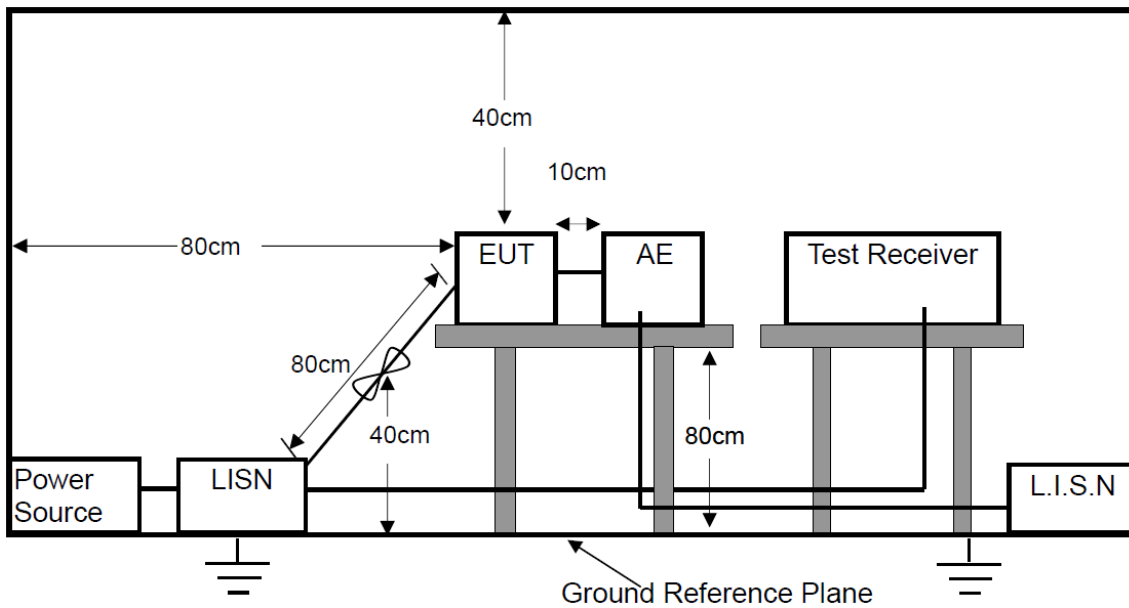

TEST PROCEDURES

- a. The EUT was placed on a wooden table 0.8m height from the metal ground plan and 0.4m from the conducting wall of the shielding room and it was kept at 0.8m from any other grounded conducting surface.
- b. All I/O cables and support devices were positioned as per ANSI C63.10.
- c. Connect mains power port of the EUT to a line impedance stabilization network (LISN).
- d. Connect all support devices to the other LISN and AAN, if needed.
- e. Scan the frequency range from 150KHz to 30MHz at both sides of AC line for maximum conducted interference checking and record the test data.

TEST RESULTS

PASS

Please refer to the following pages of the worst case.

M/N: WS21005	Testing Voltage: AC 120V / 60Hz
Phase: L1	Detector: QP & AVG
Test Mode: 3	

Conducted Emission Measurement

Date: 2024/9/21

Time: 9:03:09

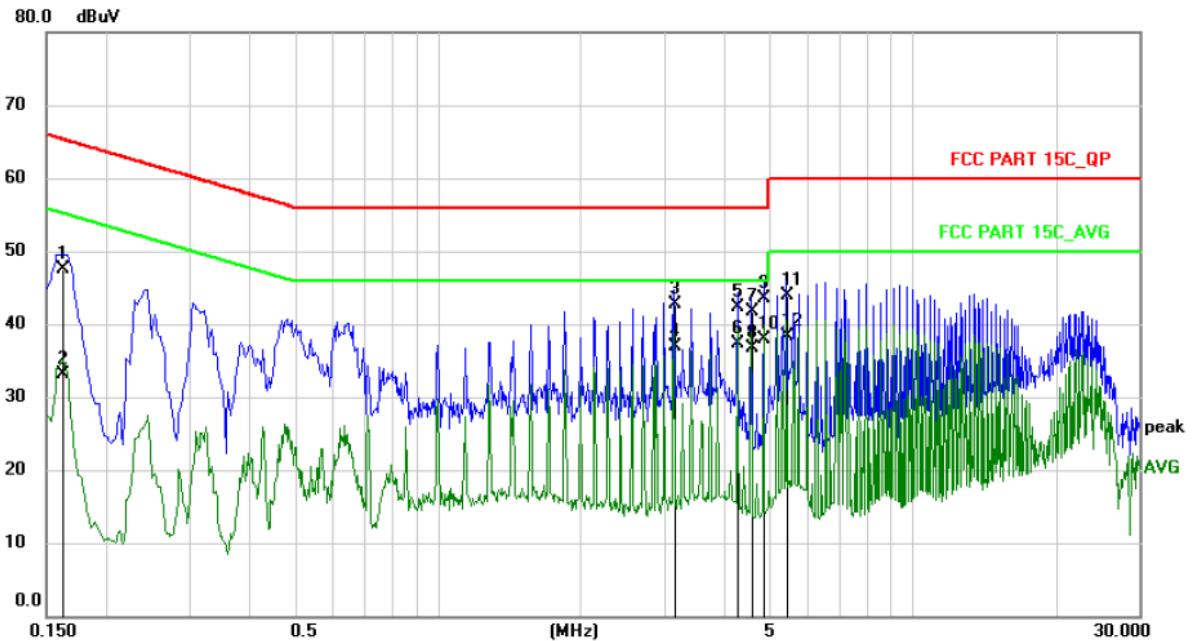

No. Mk.	Freq.	Reading Level	Correct Factor	Measurement	Limit	Over	Detector	Comment
	MHz	dBuV	dB	dBuV	dBuV	dB		
1	0.1620	37.61	9.99	47.60	65.36	-17.76	QP	
2	0.1620	23.11	9.99	33.10	55.36	-22.26	AVG	
3	3.1419	32.66	10.04	42.70	56.00	-13.30	QP	
4	3.1419	26.86	10.04	36.90	46.00	-9.10	AVG	
5	4.2857	32.25	10.05	42.30	56.00	-13.70	QP	
6	4.2857	27.25	10.05	37.30	46.00	-8.70	AVG	
7	4.5739	31.63	10.07	41.70	56.00	-14.30	QP	
8	4.5739	26.73	10.07	36.80	46.00	-9.20	AVG	
9	4.8578	33.53	10.07	43.60	56.00	-12.40	QP	
10 *	4.8578	27.83	10.07	37.90	46.00	-8.10	AVG	
11	5.4300	33.83	10.07	43.90	60.00	-16.10	QP	
12	5.4300	28.33	10.07	38.40	50.00	-11.60	AVG	

M/N: WS21005	Testing Voltage: AC 120V / 60Hz
Phase: N	Detector: QP & AVG
Test Mode: 3	

Conducted Emission Measurement

Date: 2024/9/21

Time: 9:08:52

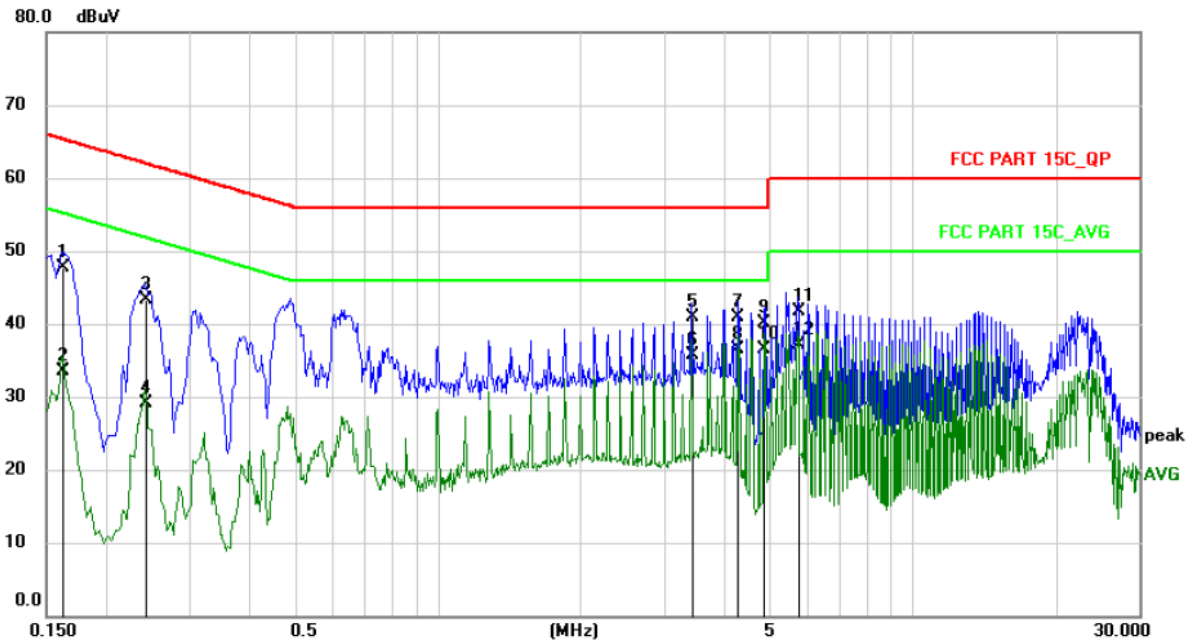

No. Mk.	Freq. MHz	Reading Level dBuV	Correct Factor dB	Measurement dBuV	Limit dBuV	Over dB	Detector	Comment
1	0.1620	37.85	9.95	47.80	65.36	-17.56	QP	
2	0.1620	23.65	9.95	33.60	55.36	-21.76	AVG	
3	0.2420	33.41	9.99	43.40	62.03	-18.63	QP	
4	0.2420	19.11	9.99	29.10	52.03	-22.93	AVG	
5	3.4300	31.00	10.00	41.00	56.00	-15.00	QP	
6	3.4300	25.80	10.00	35.80	46.00	-10.20	AVG	
7	4.2859	30.98	10.02	41.00	56.00	-15.00	QP	
8	4.2859	26.48	10.02	36.50	46.00	-9.50	AVG	
9	4.8578	30.17	10.03	40.20	56.00	-15.80	QP	
10 *	4.8578	26.57	10.03	36.60	46.00	-9.40	AVG	
11	5.7139	31.66	10.04	41.70	60.00	-18.30	QP	
12	5.7139	27.06	10.04	37.10	50.00	-12.90	AVG	

13.2 Radiated Spurious Emissions and Restricted Bands Measurement

LIMITS

Frequency range MHz	Distance Meters	Field Strengths Limit (15.209)	
		μV/m	
0.009 ~ 0.490	300	2400/F(kHz)	
0.490 ~ 1.705	30	24000/F(kHz)	
1.705 ~ 30	30	30	
30 ~ 88	3	100	
88 ~ 216	3	150	
216 ~ 960	3	200	
Above 960	3	500	
Frequency range MHz	Distance Meters	Field Strengths Limit (15.249)	
		mV/m (Field strength of fundamental)	μV/m (Field strength of Harmonics)
902 ~ 928	3	50	500
2400 ~ 2483.5	3	50	500
5725 ~ 5875	3	50	500
24000 ~ 2425000	3	250	2500

- Remark: (1) Emission level (dB)μV = 20 log Emission level μV/m
- (2) The smaller limit shall apply at the cross point between two frequency bands.
- (3) As shown in 15.35(b), for frequencies above 1000MHz, the field strength limits are based on average detector, however, the peak field strength of any emission shall not exceed the maximum permitted average limits, specified above by more than 20dB under any condition of modulation.
- (4) The frequency range scanned is from the lowest radio frequency signal generated in the device which is greater than 9 kHz to the tenth harmonic of the highest fundamental frequency or 40 GHz, whichever is lower.
- (5) §15.249(d) specifies that emissions which fall in the restricted bands, as defined in §15.205 comply with radiated emission limits specified in §15.209.

BLOCK DIAGRAM OF TEST SETUP

For Radiated Emission below 30MHz

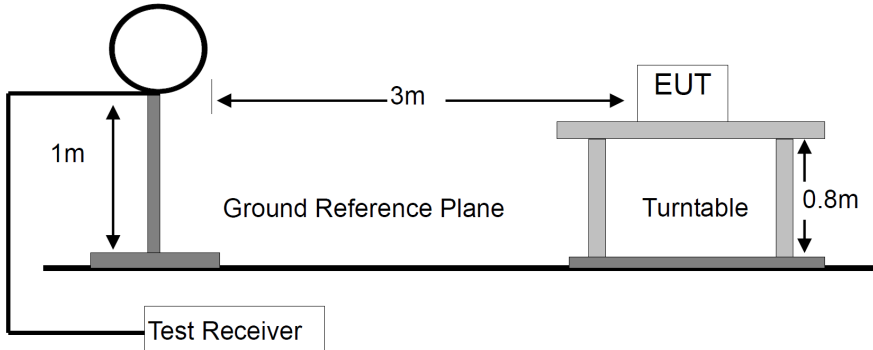

For Radiated Emission 30-1000MHz

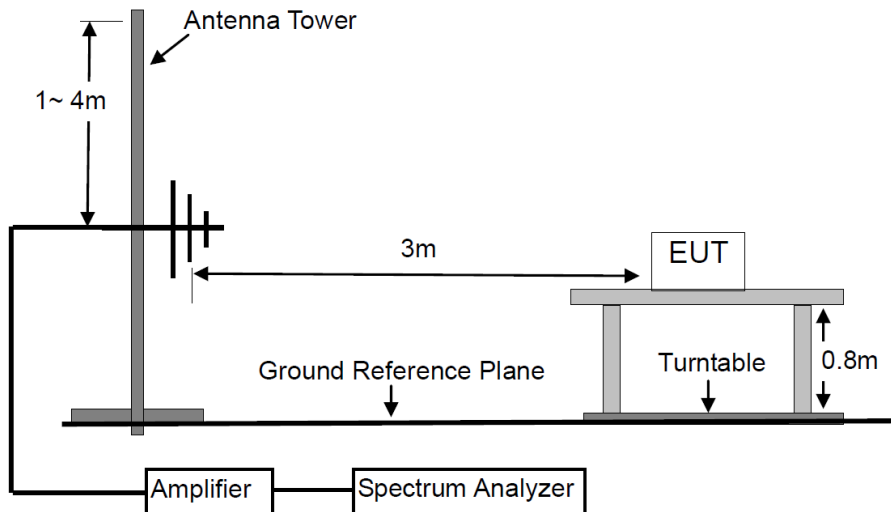

For Radiated Emission Above 1000MHz.

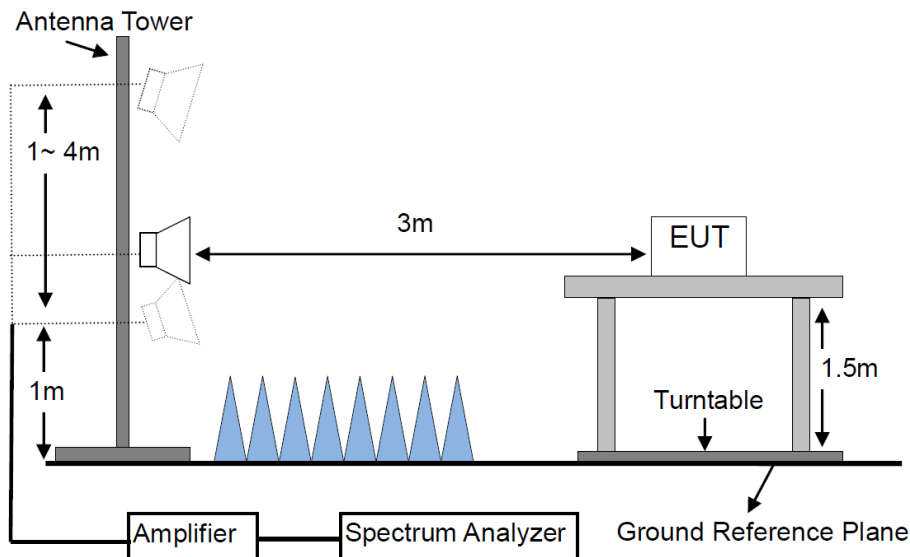

TEST PROCEDURES

- a. Below 1GHz, the EUT was placed on the top of a rotating table 0.8 meters above the ground at a 3 meter semi- anechoic chamber room.
- b. For the radiated emission test above 1GHz:
The EUT was placed on the top of a rotating table 1.5 meters above the ground at a 3 meter full anechoic chamber room. The table was rotated 360 degrees to determine the position of the highest radiation. Place the measurement antenna away from each area of the EUT determined to be a source of emissions at the specified measurement distance, while keeping the measurement antenna aimed at the source of emissions at each frequency of significant emissions, with polarization oriented for maximum response. The measurement antenna may have to be higher or lower than the EUT, depending on the radiation pattern of the emission and staying aimed at the emission source for receiving the maximum signal. The final measurement antenna elevation shall be that which maximizes the emissions. The measurement antenna elevation for maximum emissions shall be restricted to a range of heights of from 1 m to 4 m above the ground or reference ground plane.
- c. The EUT was set 3 meters away from the interference-receiving antenna, which was mounted on the top of a variable-height antenna tower.
- d. The height of antenna is varied from one meter to four meters above the ground to determine the maximum value of the field strength. Both horizontal and vertical polarizations of the antenna are set to make the measurement.
- e. For each suspected emission, the EUT was arranged to its worst case and then the antenna was tuned to heights from 1 meter to 4 meters and the rotatable table was turned from 0 degrees to 360 degrees to find the maximum reading. The test-receiver system was set to peak detect function and specified bandwidth with maximum hold mode.
- f. A Quasi-peak measurement was then made for that frequency point for below 1GHz test. PK and AV for above 1GHz emission test.

During the radiated emission test, the spectrum analyzer was set with the following configurations:

Frequency Band	Detector	Resolution Bandwidth	Video Bandwidth
9KHz-90KHz	AVG	300Hz	1KHz
91KHz-109KHz	QP	300Hz	1KHz
110KHz-490KHz	AVG	300Hz/ 9KHz	1KHz /30KHz
150KHz-30MHz	QP	10KHz	30KHz
30MHz-1000MHz	QP	120KHz	300KHz
Above 1000MHz	Peak	1 MHz	3 MHz
	Average	1 MHz	10 Hz

TEST RESULTS

PASS

Please refer to the following pages of the worst case.

M/N: WS21005	Testing Voltage: AC 120V / 60Hz
Polarization: Horizontal	Detector: QP
Test Mode: 2	Distance: 3m

Radiated Emission Measurement

Date: 2024/9/21

Time: 15:00:07

80.0 dBuV/m

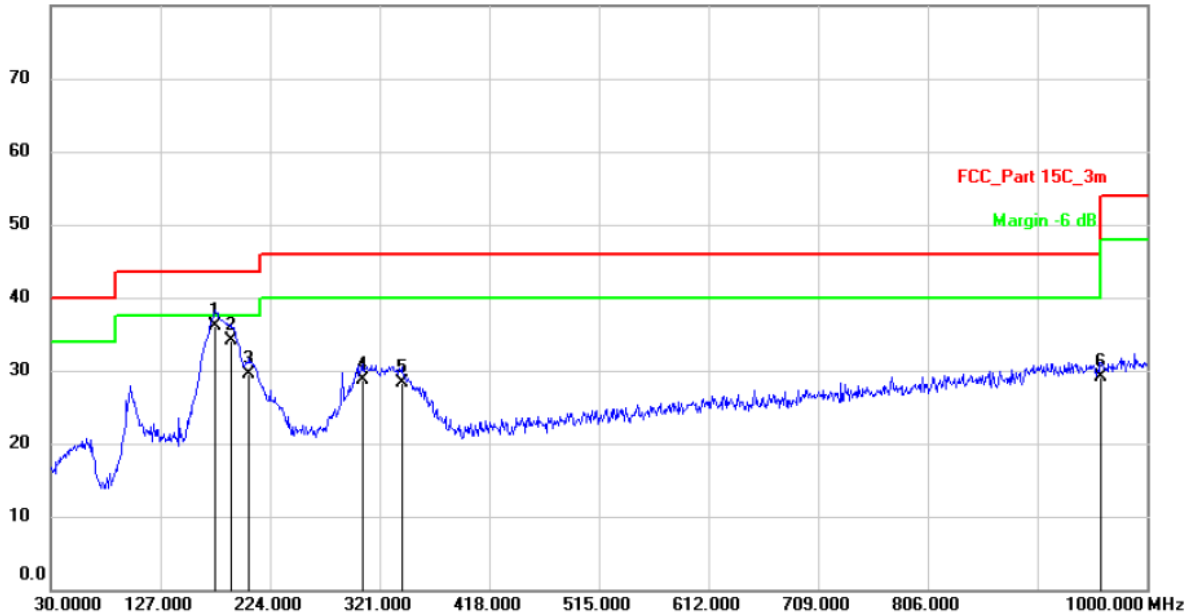

No.	Mk.	Freq. MHz	Reading Level dBuV	Correct Factor dB/m	Measure- ment dBuV/m	Limit dBuV/m	Over dB	Detector	Comment
1	*	175.5000	45.81	-9.61	36.20	43.50	-7.30	QP	
2		189.0800	42.56	-8.36	34.20	43.50	-9.30	QP	
3		205.5700	37.26	-7.66	29.60	43.50	-13.90	QP	
4		305.4800	34.17	-5.37	28.80	46.00	-17.20	QP	
5		340.4000	32.72	-4.32	28.40	46.00	-17.60	QP	
6		959.2600	22.80	6.30	29.10	46.00	-16.90	QP	

M/N: WS21005	Testing Voltage: AC 120V / 60Hz
Polarization: Vertical	Detector: QP
Test Mode: 2	Distance: 3m

Radiated Emission Measurement

Date: 2024/9/21

Time: 14:53:06

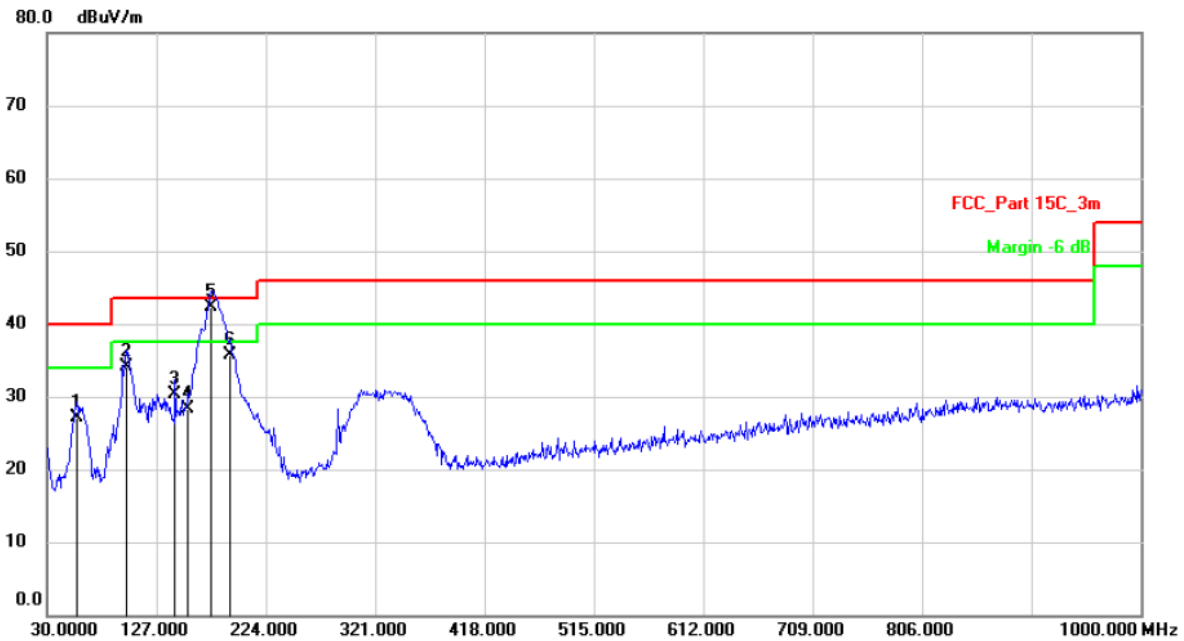

No.	Mk.	Freq. MHz	Reading Level dBuV	Correct Factor dB/m	Measure- ment dBuV/m	Limit dBuV/m	Over dB	Detector	Comment
1		56.1900	34.92	-7.72	27.20	40.00	-12.80	QP	
2		99.8399	42.60	-8.40	34.20	43.50	-9.30	QP	
3		143.4900	41.90	-11.60	30.30	43.50	-13.20	QP	
4		155.1300	39.83	-11.43	28.40	43.50	-15.10	QP	
5	*	175.5000	52.19	-9.79	42.40	43.50	-1.10	QP	
6		191.9900	44.83	-9.03	35.80	43.50	-7.70	QP	

M/N: WS21005	Testing Voltage: AC 120V / 60Hz
Polarization: Horizontal	Detector: AVG
Test Mode: 3	Distance: 3m

Radiated Emission Measurement

Date: 2024/9/21

Time: 16:30:25

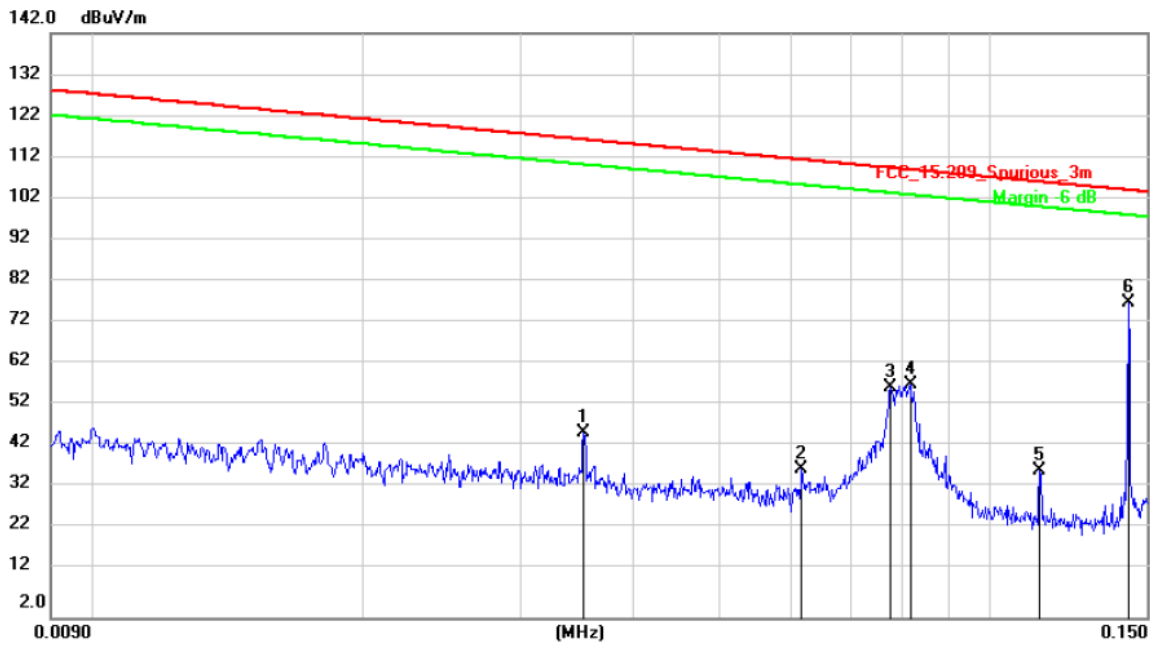

No.	Mk.	Freq.	Reading Level	Correct Factor	Measurement	Limit	Over	Detector	Comment
		MHz	dBuV	dB/m	dBuV/m	dBuV/m	dB		
1		0.0353	25.84	20.54	46.38	116.52	-70.14	AVG	
2		0.0618	16.93	20.54	37.47	111.68	-74.21	AVG	
3		0.0776	36.49	20.54	57.03	109.72	-52.69	AVG	
4		0.0816	37.18	20.54	57.72	109.28	-51.56	AVG	
5		0.1138	16.58	20.53	37.11	106.41	-69.30	AVG	
6	*	0.1428	56.99	20.52	77.51	104.45	-26.94	AVG	

M/N: WS21005	Testing Voltage: AC 120V / 60Hz
Polarization: Vertical	Detector: AVG
Test Mode: 3	Distance: 3m

Radiated Emission Measurement

Date: 2024/9/21

Time: 16:50:35

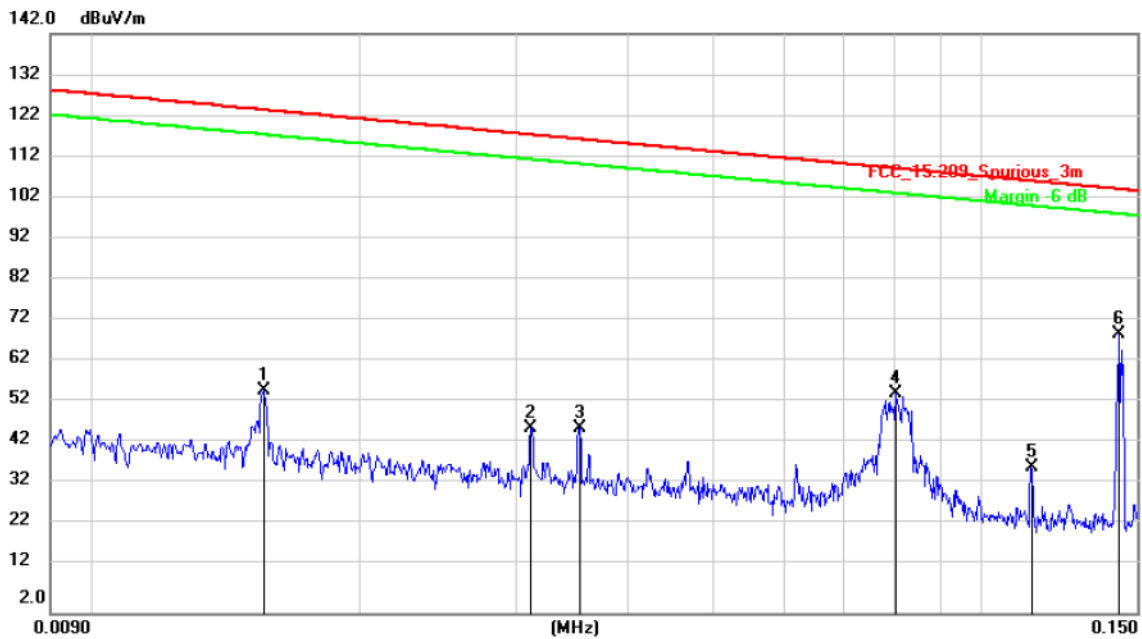

No.	Mk.	Freq.	Reading Level	Correct Factor	Measurement	Limit	Over	Detector	Comment
		MHz	dBuV	dB/m	dBuV/m	dBuV/m	dB		
1		0.0156	35.58	20.05	55.63	123.57	-67.94	AVG	
2		0.0312	26.03	20.51	46.54	117.59	-71.05	AVG	
3		0.0354	26.23	20.54	46.77	116.50	-69.73	AVG	
4		0.0803	34.58	20.54	55.12	109.42	-54.30	AVG	
5		0.1139	16.78	20.53	37.31	106.40	-69.09	AVG	
6	*	0.1428	48.98	20.52	69.50	104.45	-34.95	AVG	

M/N: WS21005	Testing Voltage: AC 120V / 60Hz
Polarization: Horizontal	Detector: AVG, QP
Test Mode: 3	Distance: 3m

Radiated Emission Measurement

Date: 2024/9/21

Time: 16:37:48

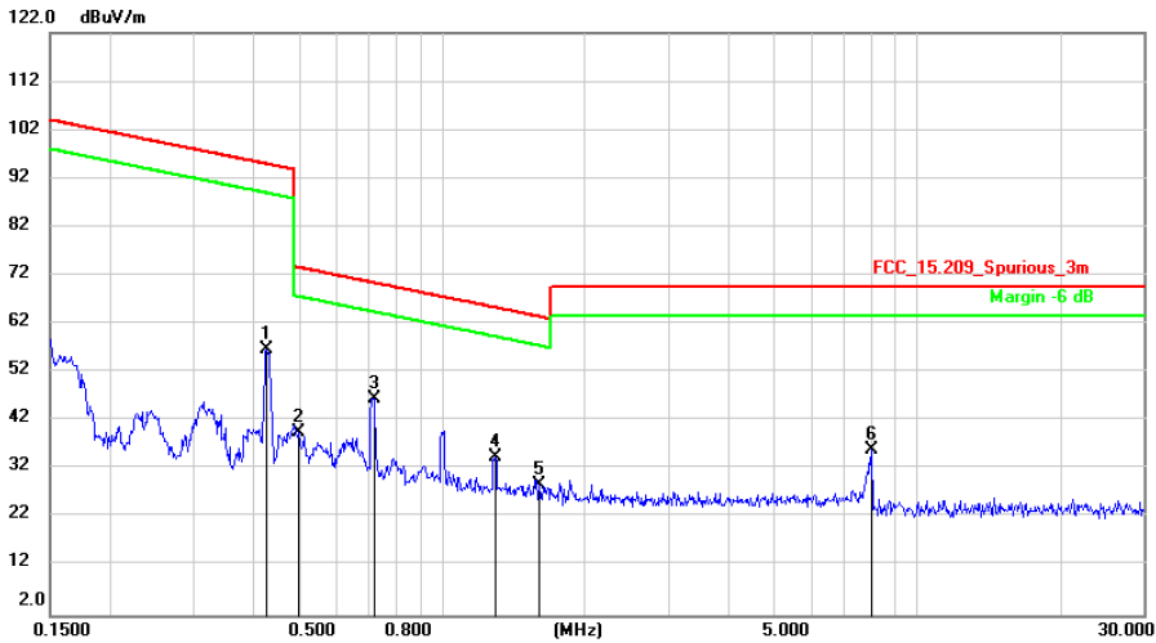

No.	Mk.	Freq.	Reading Level	Correct Factor	Measurement	Limit	Over	Detector	Comment
		MHz	dBuV	dB/m	dBuV/m	dBuV/m	dB		
1		0.4282	36.24	20.43	56.67	94.96	-38.29	AVG	
2		0.4993	19.22	20.42	39.64	73.64	-34.00	QP	
3	*	0.7197	26.26	20.41	46.67	70.46	-23.79	QP	
4		1.2960	14.26	20.40	34.66	65.35	-30.69	QP	
5		1.6019	8.39	20.40	28.79	63.51	-34.72	QP	
6		8.0198	15.41	20.51	35.92	69.50	-33.58	QP	

M/N: WS21005	Testing Voltage: AC 120V / 60Hz
Polarization: Vertical	Detector: QP
Test Mode: 3	Distance: 3m

Radiated Emission Measurement

Date: 2024/9/21

Time: 16:43:48

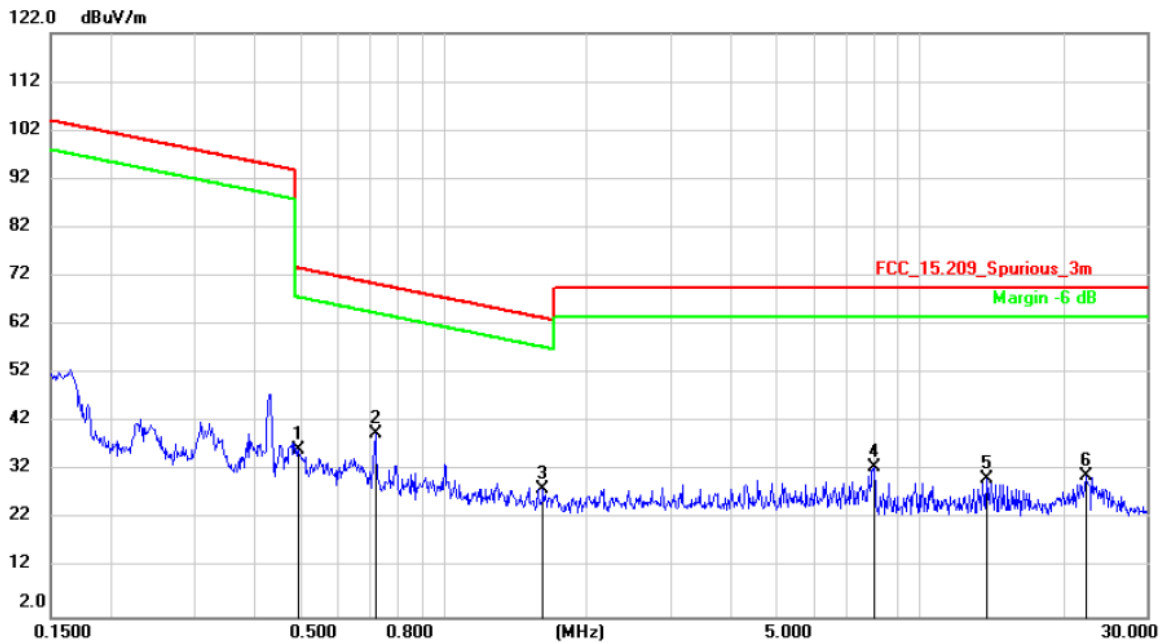

No.	Mk.	Freq.	Reading Level	Correct Factor	Measurement	Limit	Over	Detector	Comment
		MHz	dBuV	dB/m	dBuV/m	dBuV/m	dB		
1		0.4967	15.81	20.42	36.23	73.68	-37.45	QP	
2	*	0.7197	19.17	20.41	39.58	70.46	-30.88	QP	
3		1.6190	7.90	20.40	28.30	63.42	-35.12	QP	
4		8.0198	12.30	20.51	32.81	69.50	-36.69	QP	
5		13.8411	9.83	20.56	30.39	69.50	-39.11	QP	
6		22.2978	10.43	20.55	30.98	69.50	-38.52	QP	

13.3 20dB Bandwidth Measurement

LIMITS

There is no limit.

BLOCK DIAGRAM OF TEST SETUP

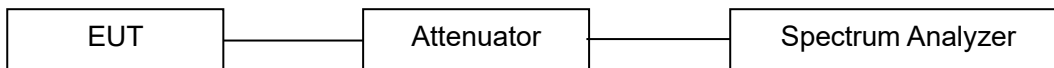

TEST PROCEDURES

The 20dB bandwidth of the emission was contained within the frequency band designated which the EUT operated. The effects, if any, from frequency sweeping, frequency hopping, other modulation techniques and frequency stability over excepted variations in temperature and supply voltage were considered, FCC Rule 15.35:

The antenna port of the EUT was connected to the input of a spectrum analyzer. Analyzer RBW was chosen so that the display was a result of the tested channel modulation. For each RF output channel investigated, the spectrum analyzer center frequency was set to the channel carrier. Use the spectrum 20dB down delta function to measure the bandwidth.

TEST RESULTS

PASS

Please refer to the following table.

FSK		
Frequency (KHz)	20dB Bandwidth (Hz)	Result
142.840	832	PASS

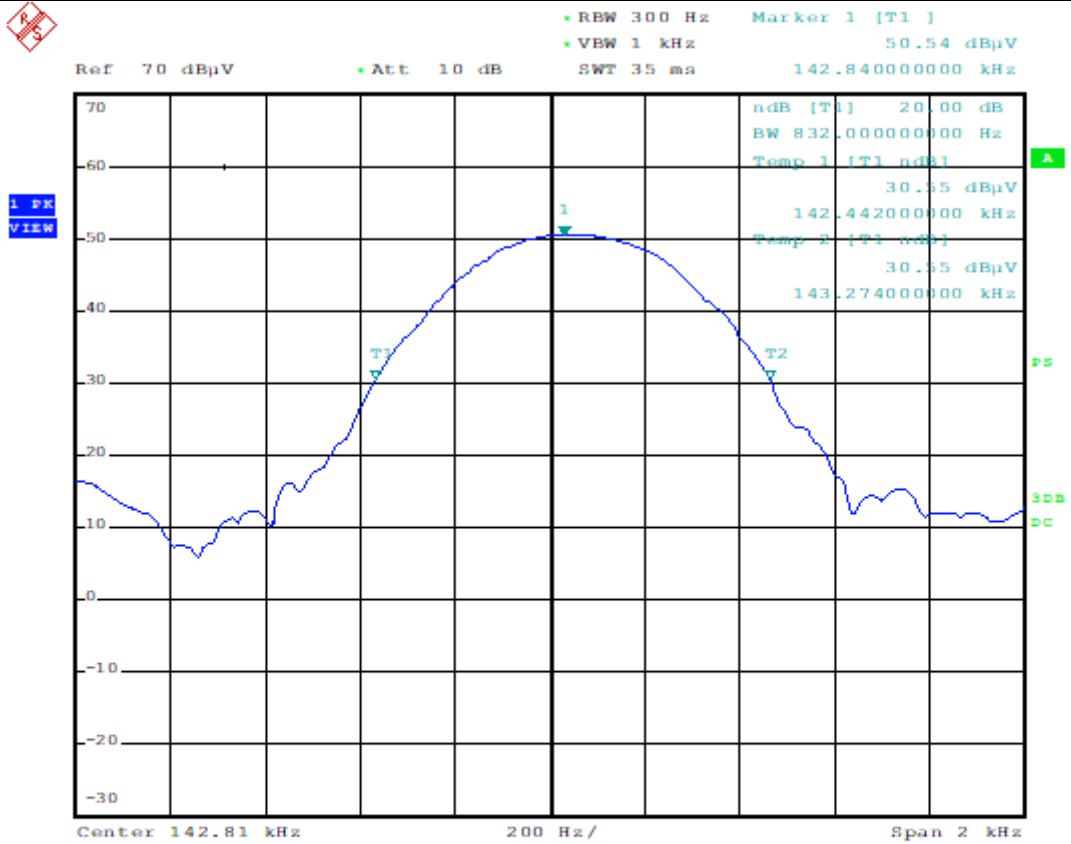

Date: 21.SEP.2024 15:21:58

13.4 Antenna Requirement

STANDARD APPLICABLE

According to of FCC part 15C section 15.203:

An intentional radiator shall be designed to ensure that no antenna other than that furnished by the responsible party shall be used with the device. The use of a permanently attached antenna or of an antenna that uses a unique coupling to the intentional radiator, the manufacturer may design the unit so that a broken antenna can be replaced by the user, but the use of a standard antenna jack or electrical connector is prohibited.

Systems operating in the 2400-2483.5MHz band that are used exclusively for fixed, point-to-point operations may employ transmitting antennas with directional gain greater than 6dBi provided the maximum peak output power of the intentional radiator is reduced by 1dB for every 3dB that the directional gain of the antenna exceeds 6dBi.

ANTENNA CONNECTED CONSTRUCTION

The antenna is coil antenna that no antenna other than furnished by the responsible party shall be used with the device. Therefore, the antenna is considered meet the requirement.

14. Test Equipment List

Item	Equipment	Manufacturer	Model No.	Serial No.	Last Cal.	Cal. Interval
1.	Test Receiver	Rohde & Schwarz	ESCI7	100837	Mar. 12, 2024	1 Year
2.	Antenna	Schwarzbeck	VULB9162	9162-010	Mar. 23, 2024	2 Year
3.	Spectrum Analyzer	Keysight	N9020A	MY54200831	Mar. 12, 2024	1 Year
4.	Spectrum Analyzer	Keysight	N9010B	MY62170254	Aug. 14, 2024	1 Year
5.	Power Sensor	DARE	RPR3006W	15I00041SNO 64	Mar. 12, 2024	1 Year
6.	Horn Antenna	COM-Power	AH-118	071078	Mar. 23, 2024	2 Year
7.	Pre-Amplifier	HP	HP 8449B	3008A00964	Mar. 12, 2024	1 Year
8.	Pre-Amplifier	HP	HP 8447D	1145A00203	Mar. 12, 2024	1 Year
9.	Loop Antenna	Schwarzbeck	FMZB 1513	1513-272	Mar. 23, 2024	2 Year
10.	Horn Antenna	COM-Power	AH-840	10100020	Mar. 23, 2024	2 Year
11.	Test Receiver	Rohde & Schwarz	ESCI	101152	Mar. 12, 2024	1 Year
12.	L.I.S.N	Rohde & Schwarz	ENV 216	101317	Mar. 12, 2024	1 Year
13.	L.I.S.N	Rohde & Schwarz	ESH2-Z5	893606/014	Mar. 12, 2024	1 Year
14.	RF Switching Unit	Compliance Direction Systems Inc.	RSU-M2	38311	Mar. 12, 2024	1 Year
15.	Temperature & Humidity Chamber	Wanshun	SS-HWHS-80	N/A	Mar. 12, 2024	1 Year
16.	DC Source	Maynuo	MY8811	N/A	Mar. 12, 2024	1 Year
17.	Temporary antenna connector	TESCOM	SS402	N/A	N/A	N/A
18.	Chamber	SAEMC	9*7*7m	N/A	Apr. 21, 2023	2 Year
19.	Test Software	EZ	EZ_EMG, NTC-3A1.1	N/A	N/A	N/A
20.	Test Software	MWRF	MTS 8310, V2.0.0.0	N/A	N/A	N/A

Note: For photographs of EUT and measurement, please refer to appendix in separate documents.

---End---