

**Videobar**

# Intelligent 4K All-in-one Video Bar

**User Manual**

**(V1.0)**

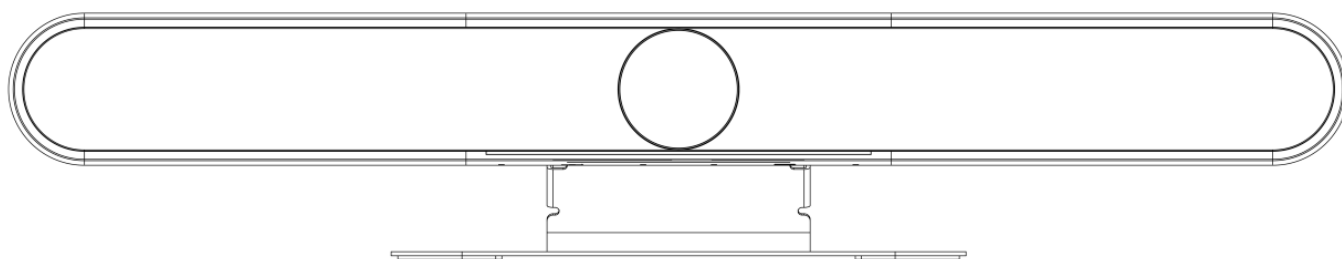

# Preface



This manual is to ensure that the user can use the product properly and avoid danger while operating. Before using this product, please read the user manual carefully and keep it properly for future reference

## Overview:

This manual describes the operation of Intelligent 4K All-in-one Video Bar.

## Graphic Symbols

Description of graphic symbols used in this manual

Symbols	Description
	This symbol indicates that the words are clarification or supplement to this article.
	This symbol indicates that negligence of the instructions may lead to mishandling that may cause injury or property damage.
	This symbol indicates a risk that may result in damage to this machine or documents. Follow the instructions to avoid property damage.

## Attention

This manual introduces functions, installations and operations for this product in details. Please read this manual carefully before installation and use.

### Precautions:

This product can only be used in the specified conditions in order to avoid any damage to the camera:

- 1) Do not expose the product to rain or moisture.
- 2) To prevent the risk of electric shock, do not open the case. Installation and maintenance should only be carried out by qualified technicians.
- 3) Do not use the product beyond the specified temperature, humidity or power supply specifications.
- 4) Please use a soft dry cloth to clean the camera. If the camera is very dirty, clean it with diluted neutral detergent; do not use any type of solvents, which may damage the surface.

### Electrical Safety:

Installation and use of this product must strictly comply with local electrical safety standards.

### Transportation:

Avoid any stress, vibration, or moisture during transportation, storage, installation and operation

### Installation:

- 1) Do not rotate the camera head violently, otherwise it may cause mechanical failure;
- 2) This product should be placed on a stable desktop or other horizontal surface. Do not install the product obliquely, otherwise it may display inclined image;
- 3) Ensure there are no obstacles within rotation range of the holder.
- 4) Do not power on before completely installation.

### Do Not Dismantle Camera :

We are not responsible for any unauthorized modification or dismantling.

### Magnetic Interference

Electromagnetic fields at specific frequencies may affect the video image. This product is Class A. It may cause radio interference in household application. Appropriate measure is required.

## FCC Statement

This device complies with part 15 of the FCC Rules. Operation is subject to the following two conditions: (1) This device may not cause harmful interference, and (2) this device must accept any interference received, including interference that may cause undesired operation.

Warning: Changes or modifications not expressly approved by the party responsible for compliance could void the user's authority to operate the equipment.

FCC NOTE: This equipment has been tested and found to comply with the limits for a Class B digital device, pursuant to part 15 of the FCC Rules. These limits are designed to provide reasonable protection against harmful interference in a residential installation. This equipment generates, uses and can radiate radio frequency energy and, if not installed and used in accordance with the instructions, may cause harmful interference to radio communications. However, there is no guarantee that interference will not occur in a particular installation. If this equipment does cause harmful interference to radio or television reception,

which can be determined by turning the equipment off and on, the user is encouraged to try to correct the interference by one or more of the following measures:

- Reorient or relocate the receiving antenna.
- Increase the separation between the equipment and receiver.
- Connect the equipment into an outlet on a circuit different from that to which the receiver is connected.
- Consult the dealer or an experienced radio/TV technician for help

### Radiation Exposure Statement

This equipment complies with FCC radiation exposure limits set forth for an uncontrolled environment. This equipment should be installed and operated with a minimum distance of 20 cm between the radiator and your body.

- English: "

This device complies with Industry Canada licence-exempt RSS standard(s).

Operation is subject to the following two conditions:

(1) this device may not cause interference, and

(2) this device must accept any interference, including interference that may cause undesired operation of the device."

- French:"

Le présent appareil est conforme aux CNR d'Industrie Canada applicables aux appareils radio exempts de licence. L'exploitation est autorisée aux deux conditions suivantes :

(1) l'appareil n' doit pas produire de brouillage, et

(2) l'utilisateur de l'appareil doit accepter tout brouillage radioélectrique subi, même si le brouillage est susceptible d'en compromettre le fonctionnement."

Le présent appareil est conforme Après examen de ce matériel aux conformité ou aux limites d'intensité de champ RF, les utilisateurs peuvent sur l'exposition aux radiofréquences et conformité d'acquérir les informations correspondantes. La distance minimale du corps à utiliser le dispositif est de 20cm.

The device is compliance with RF exposure guidelines, users can obtain Canadian information on RF exposure and compliance. The minimum distance from body to use the device is 20cm.

# Contents

1.	Quick Start.....	6
	1.1 Interfaces .....	6
	1.2 Device Startup.....	6
	1.2.1 Power on.....	6
	1.2.2 Statue Indicator Light .....	6
	1.3 Video Output .....	7
	1.4 Audio Input .....	7
	1.5 Audio Output .....	7
2.	Product Overview .....	8
	2.1 Product Introduction .....	8
	2.1.1 Dimension.....	8
	2.1.2 Supplied Accessory .....	8
	2.2 Product Features.....	9
	2.3 Technical Specification .....	10
3.	How to Use .....	13
	3.1 Remote Control .....	13
	3.2 Menu Setting.....	14
	3.2.1 Main Menu .....	14
4.	Maintenance and Troubleshooting.....	20
	4.1 Maintenance.....	20
	4.2 Troubleshooting.....	20

# 1. Quick Start

## 1.1 Interfaces

Interfaces	
USB	USB audio video in out, type C
HDMI	HDMI video output
LINE IN	Audio linear input
LINE OUT	3.5mm linear output
Extension Mic	RJ45 extension mic
Power jacket	HEC3800 power socket(DC12V), input AC110V-AC220V, output DC12V/2A

## 1.2 Device Startup

### 1.2.1 Power on

Connect device to power socket with DC12V power adapter.

### 1.2.2 Statue Indicator Light

Green lights continuously run left to right	Boot initialization in progress
Blinking Blue Lights	In Bluetooth pairing mode
Lights Turn Blue and Stay 3S	Bluetooth pairing finished
Solid Green Light	Working statue : When turn off Auto-framing&Voice tracking, all light turn green When turn on Auto-framing&Voice tracking, partial light turn green
Blinking Green Light	Standby statue(Device on without video)
Solid Red Light	Microphone Muted
Green Indicator Light On/Off	Volume up/down
Partial Light Turn Green	Partial light turns green according to the voice source

## 1.3 Video Output

1. USB: Connect device to Pcs through USB cable, and open the video software to select device to output.
2. HDMI: Connect device to monitor through HDMI cable, and then select the correct input source on the monitor to output.

## 1.4 Audio Input

1. Built-in audio: It is default that the device pick up voice through built-in mics
2. Audio input through 3.5mm linear audio cable: Connect to external pickup through 3.5mm audio cable (When connecting to external pickup, audio in automatically switch into external pickup.)

## 1.5 Audio Output

1. Built-in speaker: It is default that device output voice through built-in speaker.
2. Audio output through 3.5mm linear audio cable: Connect to external speaker through 3.5mm audio cable (When connecting to external speaker, audio out automatically switch into external speaker.)



## 2. Product Overview

### 2.1 Product Introduction

#### 2.1.1 Dimension

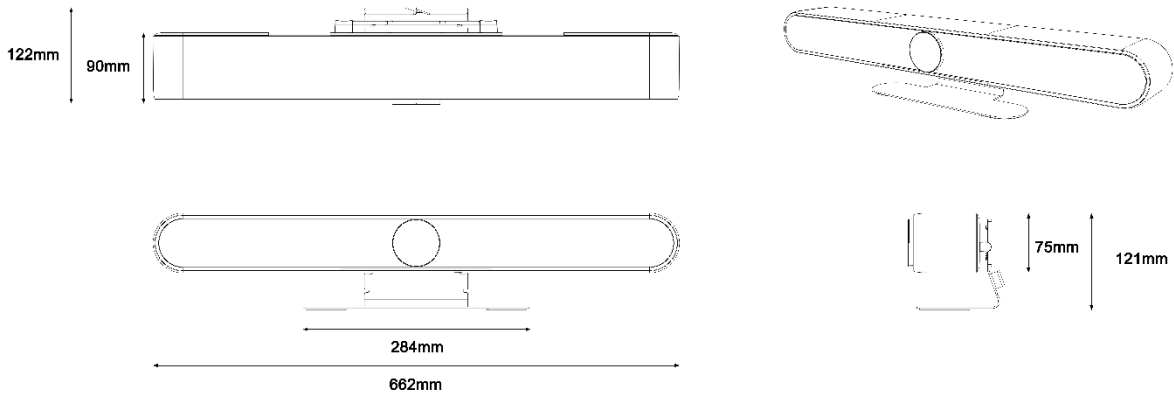

2-1 Dimension

#### 2.1.2 Supplied Accessory

When you unpack your box, please check that all the supplied accessories are included.

Items	Quantity	●Supplied ○Optional
All-in-one video bar	1	●
USB cable	1	●
Remote control	1	●
Quick start guide	1	●
Power adapter	1	●

## 2.2 Product Features

With all-in-one design, this device has 4K UHD camera, microphone array, high fidelity speaker and electric privacy cover. Boasting powerful functions like face recognition, voice localization, voice tracking, and intelligent noise reduction, this product could automatically adjust the image size according to the number of participants to present the optimal frame. It can also detect the speaker position in real time and lock the target while having a close-up, which allows users to have hands-free operation. This device has 6 array microphone composed of MEMS microphones, and it can also be matched with external cascading microphone and advanced 3A audio algorithm, you will have an exceptional full-duplex communication experience.

- **Integrated Design:** Built in 4K UHD camera, microphone array, high fidelity speaker and electric privacy cover
- **Ultra HD:** This device adopts 8 M high quality CMOS image sensor, able to capture 4K ultra HD image to present true-to-life image, bringing excellent image resolution and clarity.
- **Distortion-less Wide Angle Lens:** 120° wide angle with no distortion lens allows every participant is on the frame with no need to adjust the camera.
- **Automatic Privacy Cover:** Privacy cover will automatically close to ensure the privacy security.
- **Microphone Array:** Built in 6 array microphone enable speaker can be tracked in real time. THIS DEVICE break the distance limitation to provide virtual meeting as if you are there.
- **Built in Speaker:** Built in dual 10W high quality studio speaker, ensuring every participant can hear and be heard clearly.
- **Audio Processing:** The audio processing algorithm adopts high-fidelity 48K audio sampling rate, lossless audio transmission technology, supports AEC, AGC, ANS processing, bringing high-quality calls of 6 meters full duplex;
- **Auto Framing:** Built in face detection algorithm, automatically detect participant and provide optimal framing.
- **Bluetooth 5.0:** Connect mobile phone and other devices through Bluetooth to be used as Bluetooth speaker and microphone.
- **Low Noise and High SNR:** Low noise CMOS ensure the ultra SNR of image. The advanced 2D, 3D noise reduction technology further reduce the noise while ensuring the image clarity.
- **Powerful Compatibility:** Compatible with Windows7, windows10, Mac OS 10.10 or higher system, applicable to major cloud-based video conference platforms.

## 2.3 Technical Specification

<b>Camera</b>	Lens	FOV	120° (D) / 106° (H) / 72° (V)	
		Iris	F2.0	
		Focal Length	1.89mm	
		Digital Zoom	10X	
	Sensor	High quality CMOS sensor, effective pixel 8 million, 16:9		
	Image	Minimum Illumination	0.5Lux	
		DNR	2D & 3D	
		Focus	Auto/Manual	
		BLC	On/Off	
		Exposure	Parameter can be adjusted, and AE(Auto Exposure) is available	
		Video Adjustment	Brightness, sharpness, saturation, contrast, white balance, gain, anti-flicker, low brightness compensation and other parameters can be adjusted	
		SNR	≥50dB	
	Video Format	HDMI: 4KP30,1080P60 compatible downward USB: 4KP30,1080P60 compatible downward		
	Video Compression Format	MJPEG, YUY2, H.264, H.265, NV12		
Privacy Cover	Automatic privacy cover will close when no image output and open when there are image output.			
<b>Audio</b>	Microphone	Microphone	6 X MEMS Microphones	

		Pickup Distance	6 meters	
		Frequency Response	120 Hz–16 kHz	
	Speaker	Speaker	Built in dual speaker	
		Voltage	2*10W	
		Output Voice Pressure	80±3 dB 1.0M/1.0W	
		Frequency Response	100 Hz-20 KHz	
	Audio Processing	AEC, AGC, ANS		
<b>AI Function</b>	Group Framing	Automatically adjust the screen size according to the number of participants to present the best framing		
	Speaker Tracking	Track each speaker in real time, and ensure that the speaker is in the center of the screen.		
<b>Remote Control</b>	Remote Control	Infrared remote control		
<b>Physical Interfaces</b>	USB	USB3.0 audio video output interface, Type C Support UVC1.1, UAC1.0 and higher		
	HDMI	HDMI video output interface HDMI also compatible with HDMI2.0 standard		
	LINE IN	3.5mm audio line input interface (when an external pickup is connected, the audio input is automatically switched to the external pickup)		
	LINE OUT	3.5mm line output, can be connected to external speakers (when connecting to external speakers, the audio output will automatically switch to external speakers)		
	Expansion Mic Interface	RJ45 interface, able to connect to expansion microphone.		
	Power Interface	HEC3800 power socket (DC12V), input AC110V-AC220V output DC12V/2.5A		

<b>Indicator</b>	Bar-shaped Indicator	While displaying the working status, it can also be lit where the speaker's voice comes from.
<b>Bluetooth</b>	Bluetooth 5.0	Can be connected to a mobile phone or other device via Bluetooth as a Bluetooth microphone and speaker
<b>Compatibility</b>	Available System	Windows 7, Windows 8, Windows 10, Mac OS X, Linux, Android
<b>Power Supply Method</b>		Supply power through power adapter
<b>Working Condition</b>	Storage Temperature	-10°C ~ +70°C
	Storage Humidity	20% ~ 95%
	Working Temperature	-10°C ~ +50°C
	Working Humidity	20% ~ 80%
	Environment	Indoor
<b>Installation Method</b>	Walling Mount	Comes with walling mount bracket. While mounting, the camera need to be as close to the wall as possible.
	Desktop	Comes with desktop mounting bracket
	Installed on Monitor	Bracket for monitor installation(optional)

## 3. How to Use

### 3.1 Remote Control

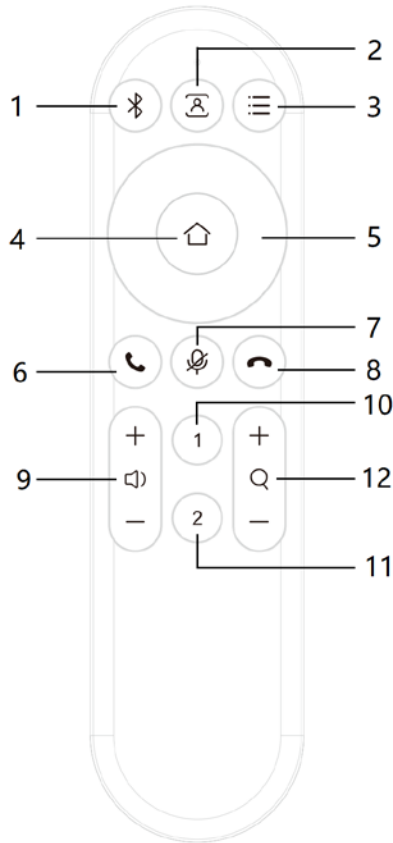

Number	Function Description
1	Bluetooth
2	Auto Framing & Voice Tracking
3	Menu
4	HOME
5	Up, down, left, right
6	Answer call
7	Microphone muted

8	Reject the incoming call
9	Volume up/down
10	Set/call out preset #1 (Long press 3 sec to set preset, short press to call out preset)
11	Set/call out preset #2 (Long press 3 sec to set preset, short press to call out preset)
12	Zoom in/out

## 3.2 Menu Setting

### 3.2.1 Main Menu

Press menu key on remote control, and use arrow to point item to be selected.

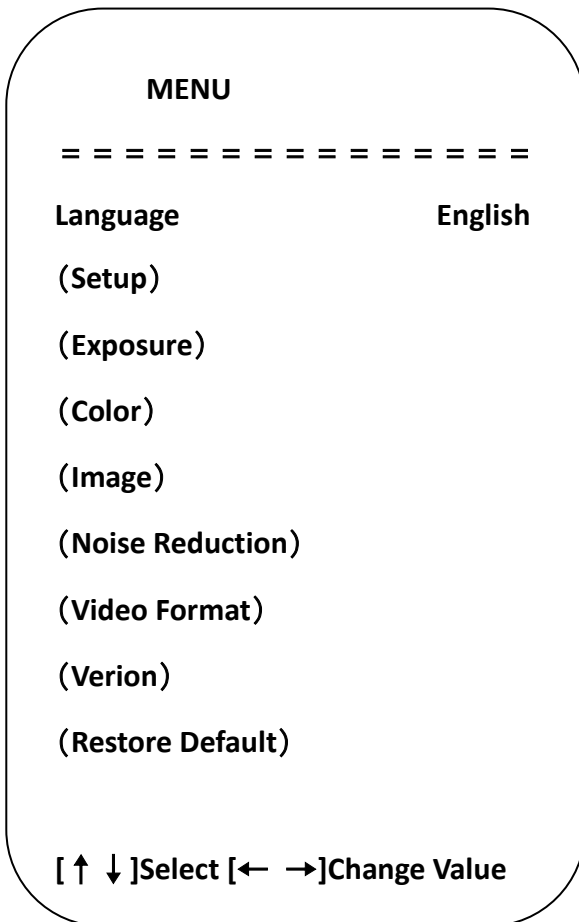

1) Language

Move arrow to (Language), and press 【← →】 to change the option

2) Setting

Move arrow to (Setting), and press 【HOME】 to enter the exposure interface.



**Image Style:** Default/standard/clear/bright/soft

**Auto Framing:** On/off

**Auto Framing Sen:** high/medium/low

**Max Framing:** 3X/5X/10X



**Voice Tracking:** on/off

**Voice Tracking Sen:** high/medium/low

**Locate Mode:** Smart mode/pan mode/movie mode/discussion mode

**Prompt Info:** On/off

**Menu Mirror:** On/off

**Transfers Mode:** Bulk/synchronization

### 3) Exposure

Move arrow to (exposure), press **【HOME】** to enter exposure interface.

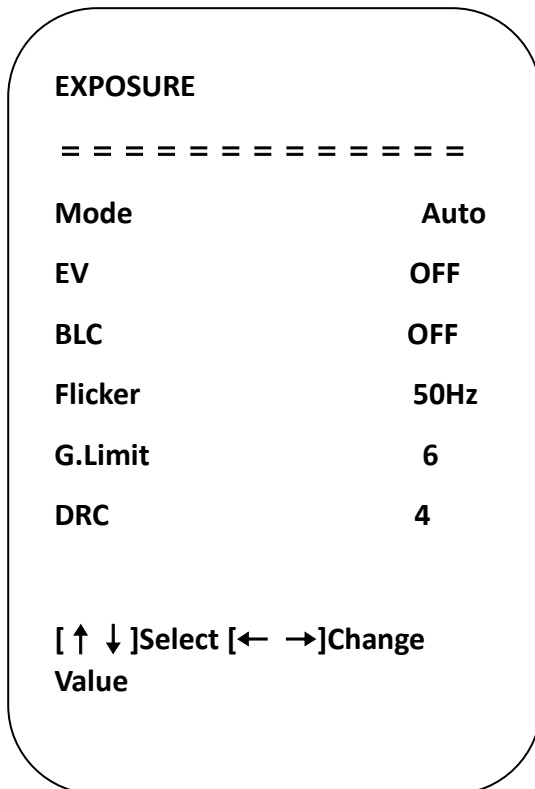

**Exposure mode:** Auto/manual/shutter priority/bright priority

**Exposure Compensation(EV):** On/off

**Compensation Level:** -7 – 7( only available in EV mode on)

**BLC:** On/off ( only available in auto mode)

**Anti-Flicker:** 50Hz, 60Hz, off (only available in auto, iris priority, bright priority mode)

**Gain Limit:** 0 – 15(only available in auto, iris priority, bright priority mode)

**Dynamic Range:** 1 – 8, off

**Shutter Priority:** 1/30, 1/50, 1/60, 1/90, 1/100, 1/120, 1/180, 1/250, 1/350, 1/500, 1/1000, 1/2000, 1/3000, 1/4000, 1/6000, 1/10000(only available in manual, and shutter priority mode)

**Bright:** 0 – 23 (only available in bright priority)

#### 4) Color

Move arrow to (color), and press **【HOME】** to enter color page.

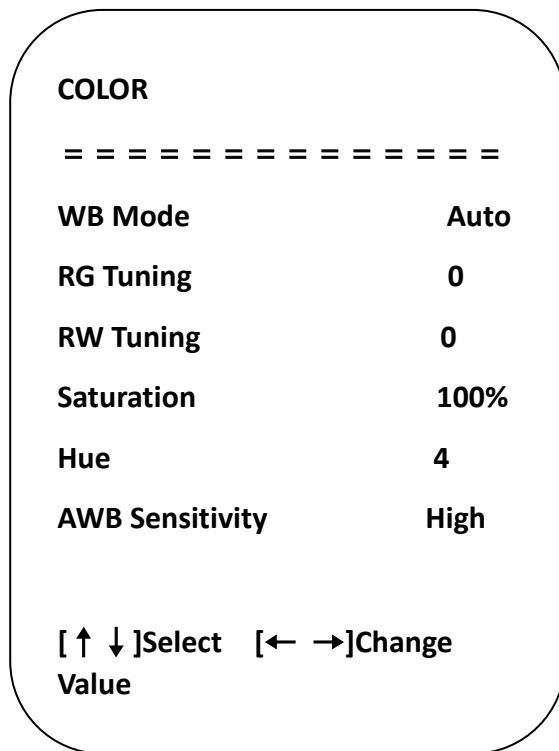

**WB Mode:** Auto/manual/one-push/specified temperature

**Saturation:** 0~127

**RG Tuning:** -10~10

**Blue Tuning:** -10~10

**AWB Sensitivity:** High/medium/low(only available in auto mode)      **Hue:** 0~8

### 5) Image

Move arrow to (image), and press **【HOME】** to enter image page.

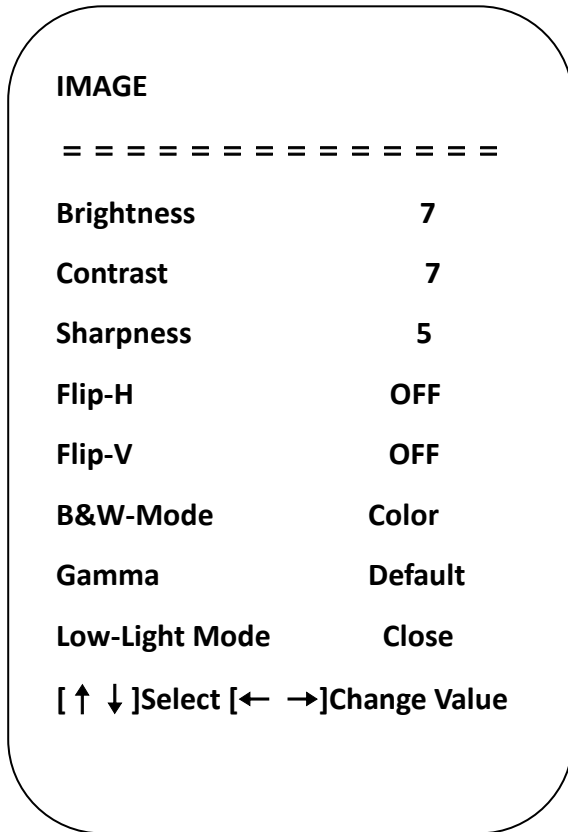

**Brightness:** 0~14

**Contrast:** 0~14

**Sharpness:** 0~15

**Flip-H:** On/off

**Flip-V:** On/off

**B&W-Mode:** Color/B&W

**Gamma:** Default, 0.34, 0.39, 0.47, 0.50

**Low-Light Mode:** On/off

### 6) Noise Reduction

Move arrow to (Noise Reduction), and press **【HOME】** to enter Noise Reduction page.

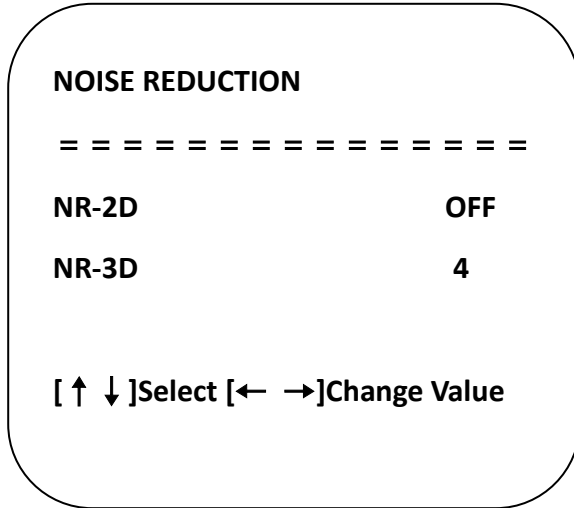

**2D NR:** Auto, manual 1~7

**3DNR:** Off, 1~8

### 7) Version

Move arrow to (version)

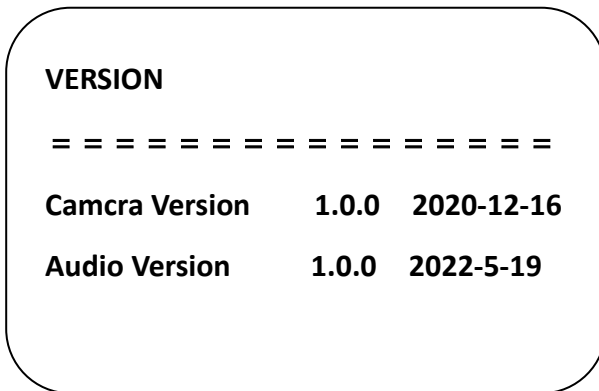

### 8) Restore Default

Move arrow to (restore default), and press **【HOME】** to enter RESTORE DEFAULT page.

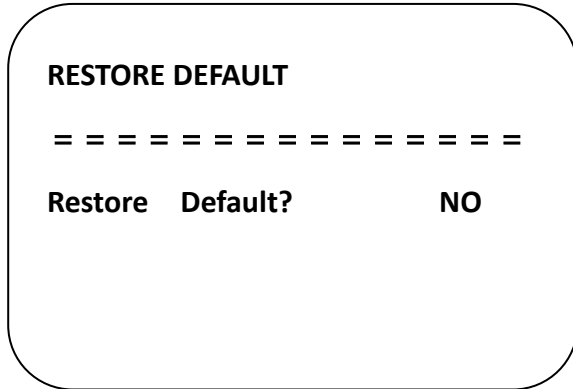

Restore default: Yes/no (color style and video format cannot be restored)

## 4. Maintenance and Troubleshooting

### 4.1 Maintenance

- 1) If the camera will not be used for a long time, please turn off the power switch.
- 2) Use a soft cloth or lotion-free tissue to clean the camera body.
- 3) Use a soft dry lint-free cloth to clean the lens. If the camera is very dirty, clean it with a diluted neutral detergent. Do not use any type of solvent or harsh detergent, which may damage the surface.

### 4.2 Troubleshooting

#### 1) No image

- a. Check whether the power cord is connected, voltage is OK, POWER lamp is lit.
- b. Check whether the camera can “self-test” after startup
- c. Check that the rotary dial on rear work normally
- d. Check that the HDMI cable is connected correctly

#### 2) Image is shaky or vibrating.

Check that the video output, video monitor cable work normally.

#### 3) Remote controller does not control the camera

- a. Check that the batter of remote control is placed properly and full of power
- b. Check that the working statue of the device is normal

c. Check whether the menu has been exited. Only after exiting the menu, the remote control can work normally; if the webpage outputs an image, the menu will not be displayed, then the menu will automatically exit and remote control can work on camera after 30 seconds without any operation

## Copyright Notice

The entire contents of this manual, whose copyright belongs to our company may not be cloned, copied or translated in any way without the explicit permission of the company. Product specifications and information referred to in this document are for reference only and as such are subject to updating at any time without prior notice