

# VANPOWERS

URBANEASE SERIES  
URBANGLIDE ULTRA

---

**EBIKE**

**USER MANUAL**

---







“

## Dear customer,

Hello from the Vanpowers team! We believe above all else that a good electric bike should be powerful, long-lasting, and infused with innovative technology. This belief is at the core of everything we do. Each meticulously crafted e-bike we deliver is a symbol of how we strive to create a better day to day commuting experience for riders all over the world.

Your Vanpowers journey begins right now, and we are so excited to share it with you.

”

- Vanpowers Team

**VANPOWERS**



**URBANEASE SERIES**  
URBANGLIDE **ULTRA**

**If you have any questions about using your e-bike, feel free to contact us at any time!**

---

**Vanpowers Bike USA**

 1120 US-22 BRIDGEWATER TOWNSHIP,  
NJ 08807, USA

 [vanpowers.com](https://vanpowers.com)  
 [service@vanpowers.bike](mailto:service@vanpowers.bike)  
 +1 (626) 991-866

---

# Electric Pedal-Assist Bicycle (EPAC) Instructions

## Pedelec / EPAC

### United States

Pedelecs are electric bikes that provide pedal assistance up to a maximum speed of 20 mph. According to US regulations, pedelecs are classified as Class 1 & Class 2 electric bikes. Depending on the model, there may also be a push assist feature that allows the bike to accelerate up to 4 mph as you walk with it. In most places, electric bikes are legally considered bicycles. You should familiarize yourself with the regulations and classifications in your region.

### Europe

A pedelec is a type of bicycle equipped with electric pedal assist functionality. It can provide assistance up to a maximum speed of 25 km/h when pedaling. Depending on the model, there may be a boost function that can accelerate the e-bike up to an additional 6 km/h (4 mph) .

### NOTICE!

The Vanpowers UrbanGlide - Ultra is classified as a Class 2 electric pedal assist bike in the United States and as an EPAC in Europe.

# CONTENTS.

USING THIS MANUAL	01
SAFETY WARNINGS	03
PRODUCT OVERVIEW	08
INSTALLATION INSTRUCTION	15
TROUBLESHOOTING ISSUES	31
CHARGING & REMOVAL OF BATTERY	33
DISPLAY INSTRUCTION	41
WARRANTY	47
CARE&MAINTENANCE	49

# 01

## USING THIS MANUAL



## Using This Manual

Thank you for choosing Vanpowers Bike. Before you get rolling, please make sure to familiarize yourself with the basics of riding safely. Ride safety is influenced by various factors, including your understanding of and proficiency with your e-bike, the e-bike's condition and maintenance history, and the riding conditions. Please note that any e-bike or other mode of transportation carries unforeseeable risks that the rider accepts by using it. As we cannot control or predict the various situations that may occur while you ride, we cannot guarantee the safe use of this bike. We hope you have a great ride!

This manual contains essential information on how to safely operate and maintain your Vanpowers Bike e-bike and its accessories. Before using the e-bike, please read and familiarize yourself with the contents of this manual, paying particular attention to safety precautions to ensure safe and proper use of the e-bike. The manual also includes many warnings regarding safe operation of the e-bike as well as the potential consequences of incorrect operation, settings, and maintenance. Please carefully read all the information in this manual and contact us immediately if you have any questions.

Please be sure to keep this manual and any accompanying documents for future reference. Additionally, please note that any updates or revisions to the contents of this manual will not be individually. Please visit to download the latest version for the most up-to-date information.



# 02 SAFETY WARNINGS



## Safety Warnings

### **WARNING**

Please carefully read the user manual and safety warnings before using your e-bike and ensure that you understand and accept all associated risks. Any loss or damage caused by improper use is the responsibility of the user.

#### **INSTRUCTIONS PERTAINING TO RISK OF FIRE or ELECTRIC SHOCK**

#### **IMPORTANT SAFETY INSTRUCTIONS**

**WARNING** –When using this product, basic precautions should always be followed, including the following:

- a) Read all the instructions before using the product.
- b) To reduce the risk of injury, close supervision is necessary when the product is used near children.
- c) Do not put fingers or hands into the product.
- d) Do not use this product if the flexible power cord or output cable is frayed, has broken insulation, or any other signs of damage.
- e) This equipment is not intended to be used at ambient temperatures less than -20°C (-4°F) or above ambient temperatures of 45°C (113°F).
- f) The battery is intended to be charged when the ambient temperature is between 0°C (32°F) and 40°C (104°F). Never charge the battery when ambient temperatures are outside this range.

SAVE THESE INSTRUCTIONS

## General warning

### **WARNING**

This e-bike is designed for adult use only. Children should only ride under adult supervision.

Please ensure that the e-bike and its components are not accessible to children under 3 years old.

The maximum total weight limit for this e-bike is 330 lbs (150 kg), and the maximum weight capacity for the rear rack is 55 lbs (25 kg). The calculation method for total weight is as follows: e-bike weight + rider weight + luggage/backpack weight = total weight. If you have any questions about the maximum weight limit, please contact Vanpowers Bike for assistance.

As with all products with mechanical components, EPACs are subject to wear and high stress. Different materials and components may react to wear and stress fatigue in different ways. If the recommended lifespan of a component has been exceeded, it may suddenly fail, possibly causing injury. Any cracks, scratches, or changes in coloring in high-stress areas indicate that the lifespan of the components in those has been exceeded and they should be replaced.

When replacing parts, be sure to use genuine replacement parts provided by the Vanpowers Bike Support Team. Using non-Vanpowers parts may cause malfunctions that can seriously affect your ride safety. Vanpowers Bike is not responsible for any damages incurred due to the rider's decision to use non-Vanpowers replacement parts.

Without the guidance of the Vanpowers Bike Service Center, do not attempt to disassemble, modify, repair, or replace any parts of the product or equipment, as this will void the warranty and may result in malfunctions and/or injuries.

Inappropriate modifications to the e-bike or its accessories can cause malfunctions. In order to reduce the risk of accidents and injuries, do not install any additional accessories that have not been purchased from or authorized by the seller, including but not limited to child safety seats and trailers.

## Riding environment

We recommend avoiding riding in wet weather, especially in damp, salty, corrosive, or dusty environments.

Avoid riding in adverse weather conditions with low visibility, such as dawn, dusk, darkness, or fog, to reduce the risk of accidents.

Do not use the product to ride in heavy rain or through streams, and do not immerse or submerge it in water or other liquids, as this may cause damage to the electrical system.

When riding on slippery roads, reduce your speed and brake in advance to ensure that the e-bike can stop safely.

Install reflectors and make sure they are clean, securely fastened, and unobstructed.

When riding at night, use lights and reflectors properly to ensure that others can see you.

Please note that insufficient lighting measures can lead to serious injury or death.

## Notes on road use

This product is designed for use on smooth asphalt, concrete, and paved surfaces. Do not ride on/over non-standard terrain, such as hills or mounds, stairs, rocks, or drops greater than 15 centimeters.

To ride the e-bike safely on the road, it is necessary to understand and comply with the safety regulations of your country or region.

To reduce the risk of injury, always wear your helmet correctly (covering the forehead) and fasten the safety buckle correctly under your chin.

You are responsible for equipping yourself and your bike with appropriate equipment (such as reflectors and lights) in accordance with local legal requirements.

Do not ride the bike in a dangerous manner. Make sure you can control the bike and do not attempt dangerous actions, including but not limited to hands-free riding, jumps, and wheelies.

## FCC Compliance Statements

This device complies with Part 15 of the FCC Rules. Operation is subject to the following two conditions: (1) this device may not cause harmful interference, and (2) this device must accept any interference received, including interference that may cause undesired operation.

Note: This equipment has been tested and found to comply with the limits for a Class B digital device, pursuant to Part 15 of the FCC Rules. These limits are designed to provide reasonable protection against harmful interference in a residential installation. This equipment generates, uses and can radiate radio frequency energy and, if not installed and used in accordance with the instructions, may cause harmful interference to radio communications. However, there is no guarantee that interference will not occur in a particular installation.

If this equipment does cause harmful interference to radio or television reception, which can be determined by turning the equipment off and on, the user is encouraged to try to correct the interference by one or more of the following measures:

- Reorient or relocate the receiving antenna.
- Increase the separation between the equipment and receiver.
- Connect the equipment into an outlet on a circuit different from that to which the receiver is connected.
- Consult the dealer or an experienced radio/TV technician for help.

### **WARNING**

Changes or modifications not expressly approved by the party responsible for compliance could void the user's authority to operate the equipment.

This equipment complies with FCC radiation exposure limits set forth for an uncontrolled environment. This transmitter must not be co-located or operating in conjunction with any other antenna or transmitter.

This equipment (the display) should be installed and operated with minimum distance 20cm between the radiator and your body.



# PRODUCT OVERVIEW

# Product Overview

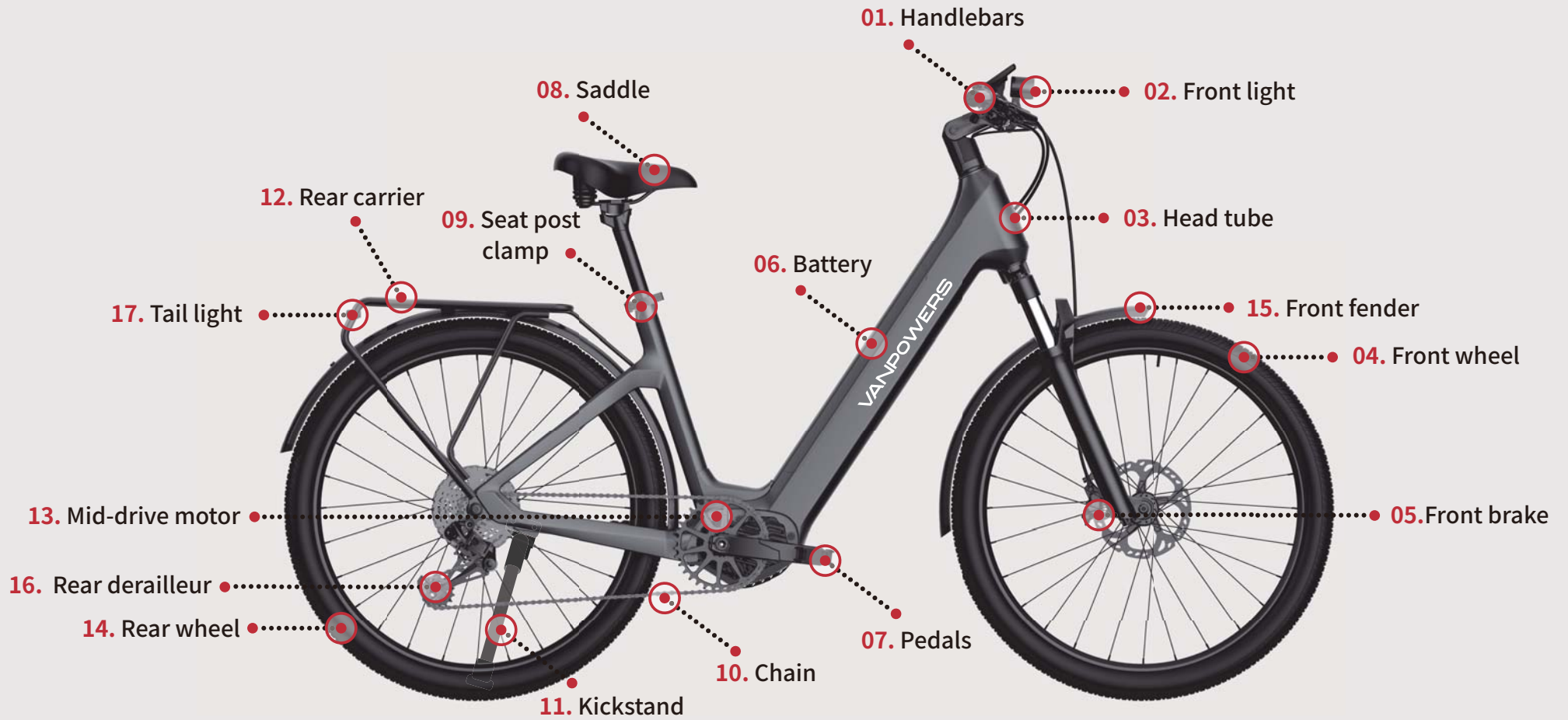

-Side view-



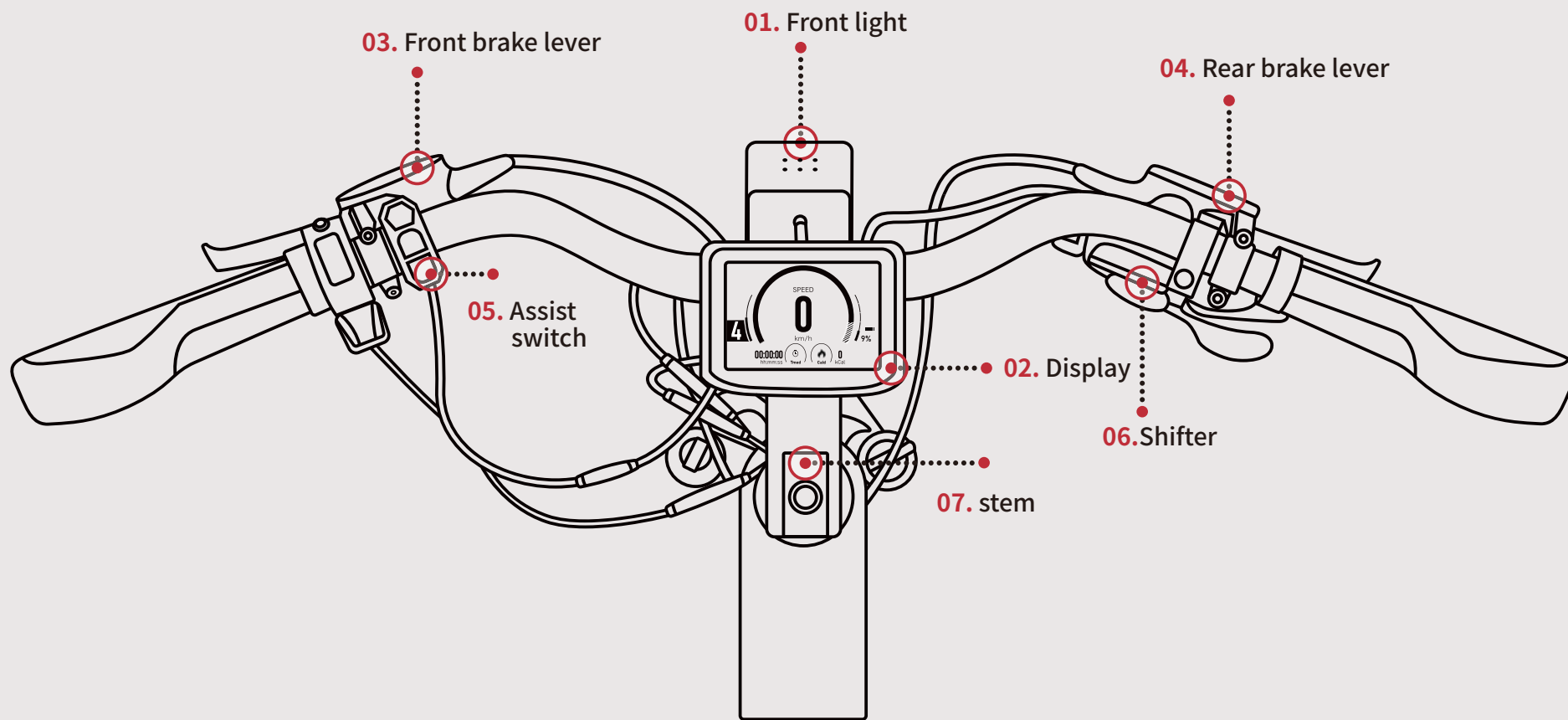

-Handlebars-



# What's in box.

0.08inch (2mm) Allen Key

0.10inch (2.5mm) Allen Key

0.12inch (3mm) Allen Key

0.16inch (4mm) Allen Key

0.20inch (5mm) Allen Key

0.24inch (6mm) Allen Key

0.32inch (8mm) Allen Key

0.40inch (10mm) Allen Key

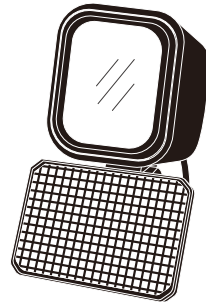

-Front light&Reflector

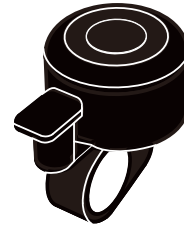

-Bell



-Thru-Axle

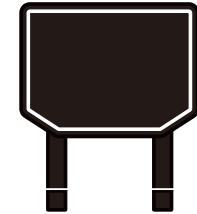

-Display

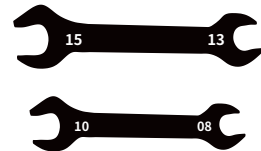

-13-15&08-10  
Open-End Wrench

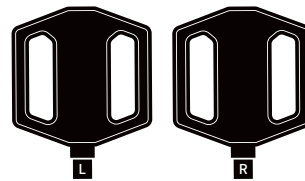

-Pedals

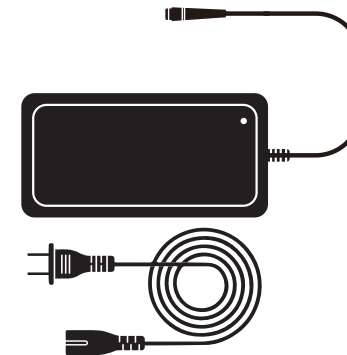

-Charger

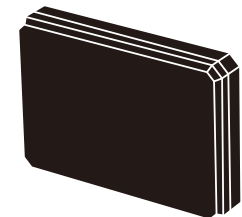

-User Manual



-Phillips Screwdriver



-keys

Please check the accessory box to ensure that all the following accessories are inside.  
If any parts are missing or damaged, please contact [the Vanpowers Bike after-sales service center](#) immediately.



# Geometry

Choosing the right size bike is an important step to ensure safety and comfort while riding. If you are unsure which size is suitable for you, please refer to the table in page 17.

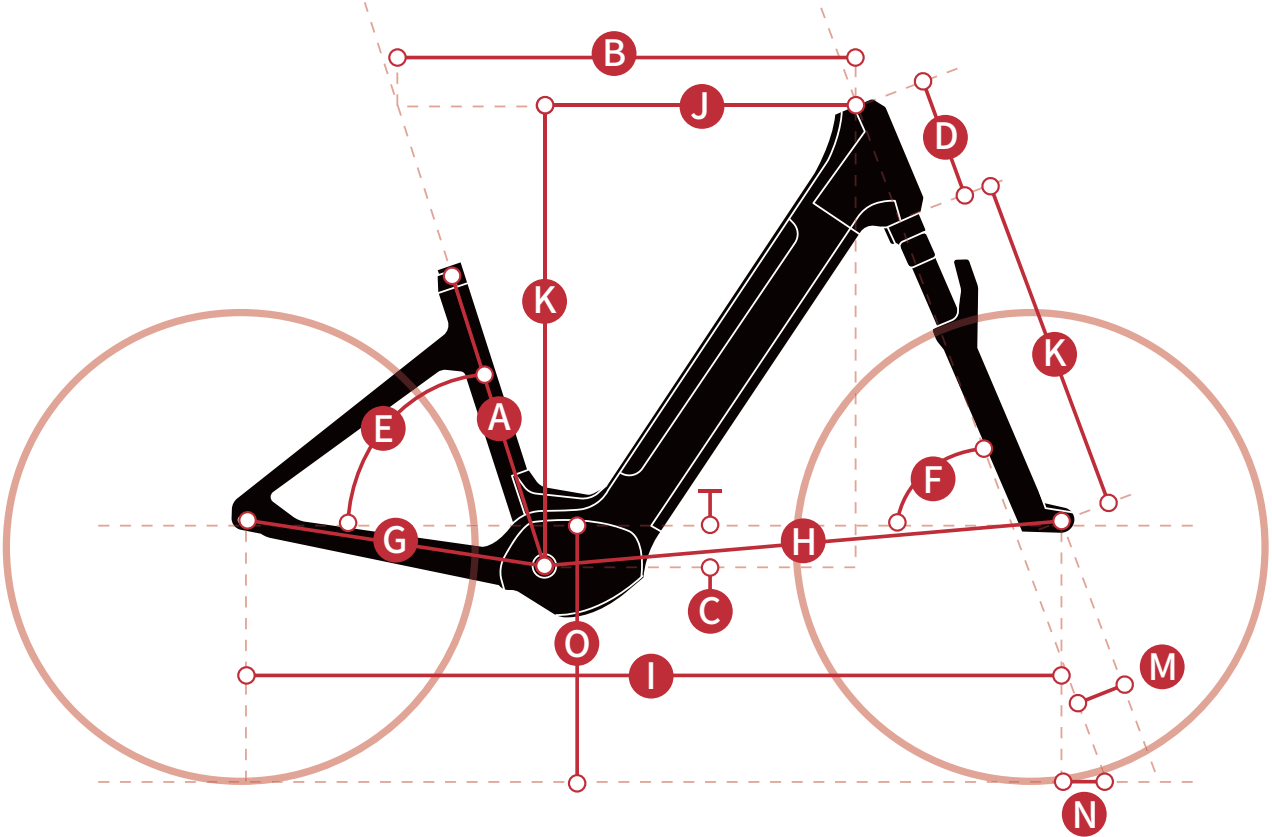

Frame Size		S	L	Frame Size		S	L
	Ideal rider height	155-175cm (5'1"-5'9")	170-190cm (5'7"-6'3")	H	Front wheel to center	736mm	758mm
A	Seat post length	440mm	460mm	I	Wheelbase	1179mm	1201mm
B	Frame length	642mm	672mm	J	Reach	440mm	468mm
C	Bottom bracket drop	70mm	70mm	K	Stack	663mm	666mm
D	Head tube length	180mm	180mm	L	Fork length	480mm	480mm
E	Seat tube angle	73°	73°	M	Fork offset	44mm	44mm
F	Head tube angle	67.5°	68°	N	Trail	98mm	94mm
G	Rear wheel to center	451mm	451mm	O	Standover height	370mm	370mm



## Specifications

Model	UrbanGlide - Ultra	Wheel diameter	27.5" × 2.2" front + rear
Max speed	20 mph (32 km/h)	Tire pressure	30–50 psi
Max load	330 lbs. / 150kg	Waterproof rating	IPX5
Motor	48V 500W Mid-drive	Mileage	Up to 60 Miles
Battery	48V 15Ah Li-ion	Mudguard	Yes
Charger	54.6V 4A	Front+ rear lights	Yes
Display	3.5"Colorful LCD	Rear rack	Yes

# INSTALLATION INSTRUCTION



## Installation Instruction

### NOTICE!

The following steps are intended to assist you in assembling your electric bike and do not constitute a complete or comprehensive guide to installation, maintenance, or repair. If you require more in-depth professional assistance, we recommend that you consult a certified and reputable bicycle mechanic to help you assemble, maintain, and/or repair your electric bike.

The directional instructions (right, left, front, back) in this manual are the same as the directions seen by the rider when sitting on the bicycle. For example, “right side” refers to the side where the rider’s right hand and foot are located.

### WARNING

Improper installation, maintenance, or use of this e-bike may result in component or performance failure, loss of control, serious injury, or death. Even if you are an experienced e-bike rider, you should carefully read and understand all documents provided in this manual before riding. If you are unsure whether you have the experience, skills, and tools necessary to perform all assembly steps correctly in this manual, please consult a local certified and reputable bicycle mechanic.

## 01 Unpack the parts and accessories



Remove the ties and tape from the box and pull open the top flap. Remove the protective packing material and keep it for later use when transporting the bicycle. If possible, recycle the remaining packaging, especially cardboard and foam. Take out the bicycle parts as well as the small box containing your charger and accessories. We recommend using wire cutters as shown in the diagram to remove the cable ties to avoid scratching the e-bike.



## 03 Install the front fender

### STEP ONE

Use a 5 mm Allen key to loosen the fender-mounting screws on the inside of the front fork bridge, as shown in the diagram. Double check that the fender is oriented correctly, align the upper fixed bracket with the screw hole on the front fork bridge, and tighten the screws again.

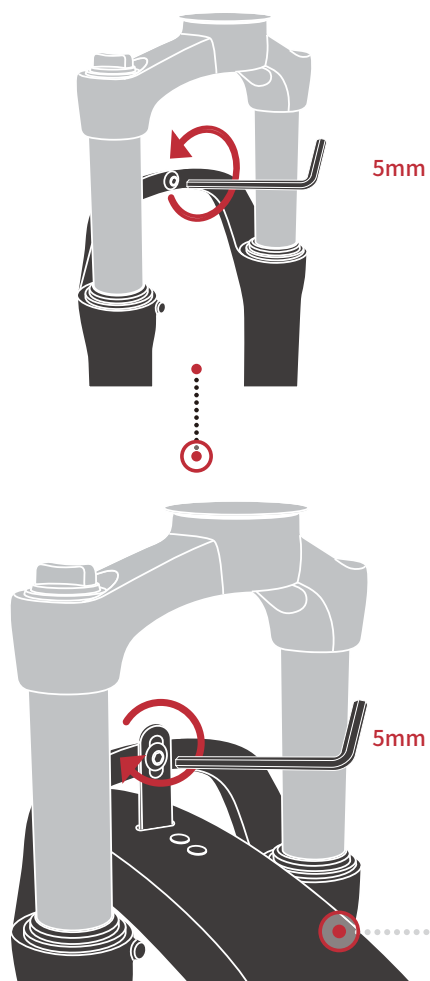

### STEP TWO

After fastening the upper bracket, use a 4 mm Allen key to remove the 2 screws at the bottom of the front fork. Then, align the legs of the front fender with the installation holes at the bottom of the front fork, and re-tighten the screws.

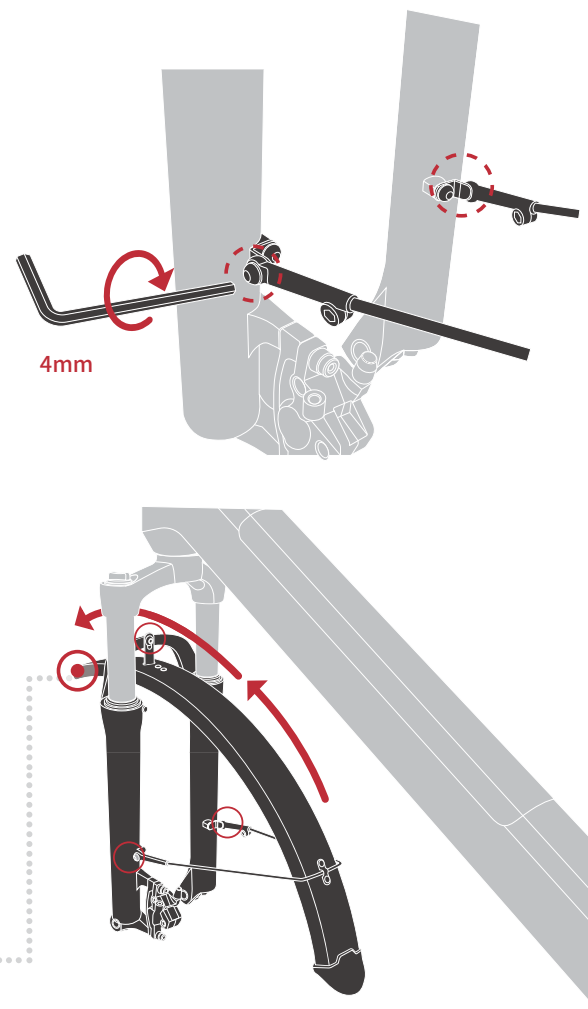



## 04 Install the front wheel

### STEP ONE

Use a 15mm open-end wrench to loosen the nuts at points ① and ②, and remove the front fork axle protection rod.

### ⚠ NOTICE!

Please note that this accessory is only used to prevent deformation of the front fork during transportation and is not necessary for installing the bicycle.

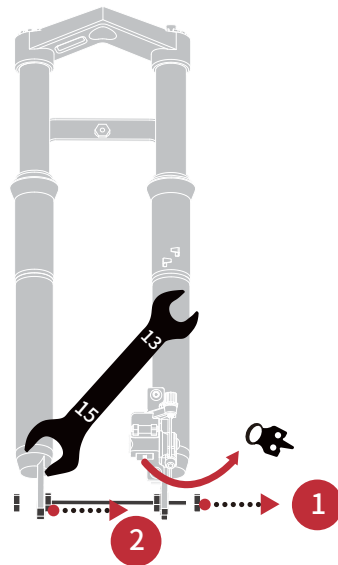

⚠ After removing the brake pads, do not squeeze the brake lever on the handlebar, as this can cause brake damage that will not allow the bike to function properly! The brakes should only be used after the front wheel is installed.

### STEP TWO

Align the rotor with the brake caliper to center the rotor between the brake pads, ensuring that the tire is also centered. Insert the front axle from the opposite side of the rotor, from right to left, and tighten it. Note that the handle is on the right side of the bike (same side as the chain).

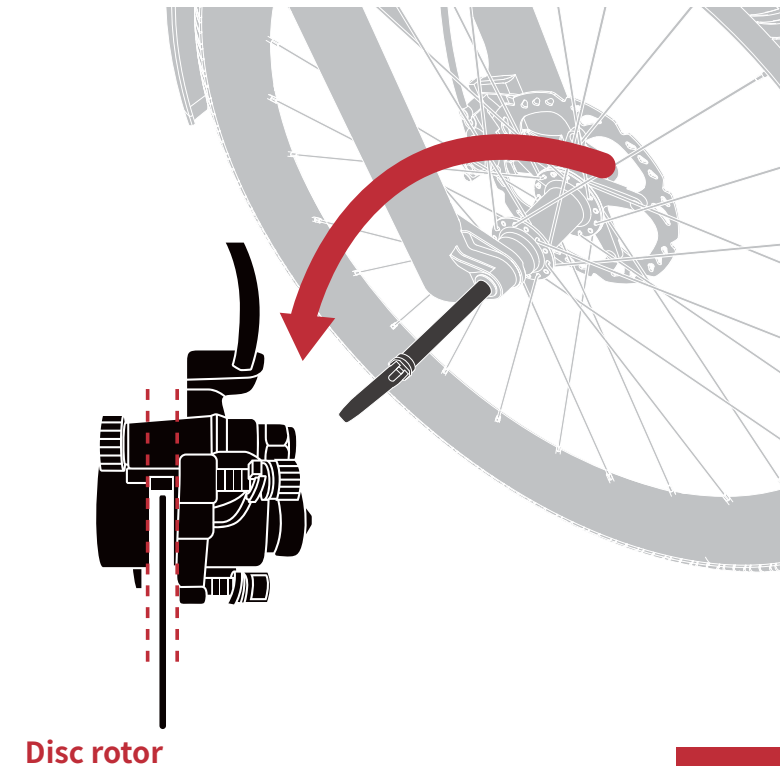

### STEP THREE

Hold the barrel axle handle with one hand and turn the barrel axle nut with the other hand until you feel resistance, then close the handle. If it is too easy or too difficult to close, adjust the tension of the barrel axle lever by tightening or loosening the nut, then lock the barrel axle.

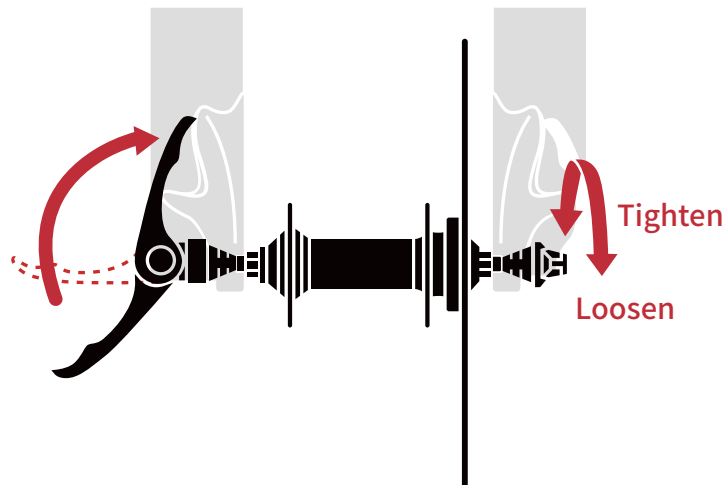

**⚠ Warning:** Contact with the sharp edge of the disc can cause serious injury. Touching the disc or brake pads with your bare skin can result in residual oil being left on the components, which may reduce braking performance. When installing the front wheel, be sure to avoid touching the disc or brake pads with your hands. If necessary, wear gloves.

### Adjust the front fender

#### STEP ONE

After installing the front wheel, check whether the direction of the front fender is in line with the direction of the wheel when viewed from the front of the bike. If not, gently adjust the position of the mudguard by moving it left or right with your hands.

#### STEP TWO

Next, check the clearance between the mudguard and the front wheel from the side and adjust the mudguard support screws on both sides with a 3 mm Allen key if one side has too little or too much clearance. Once the clearance is consistent on both sides, tighten the screws.

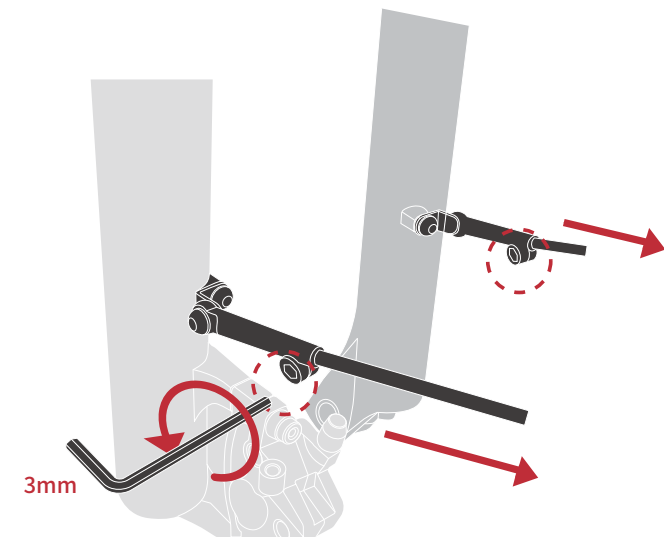

## 05 Install the display, front light, and bell

### Install the display

Face the front light direction during installation.

#### STEP ONE

Using a 2.5 mm Allen key, undo the screws on the display, attach it to the center of the handlebar, and then retighten the screws.

#### STEP TWO

Loosen the display's angle adjustment screw with a 2.5 mm Allen key, adjust the display to the appropriate angle, and then re-tighten it.

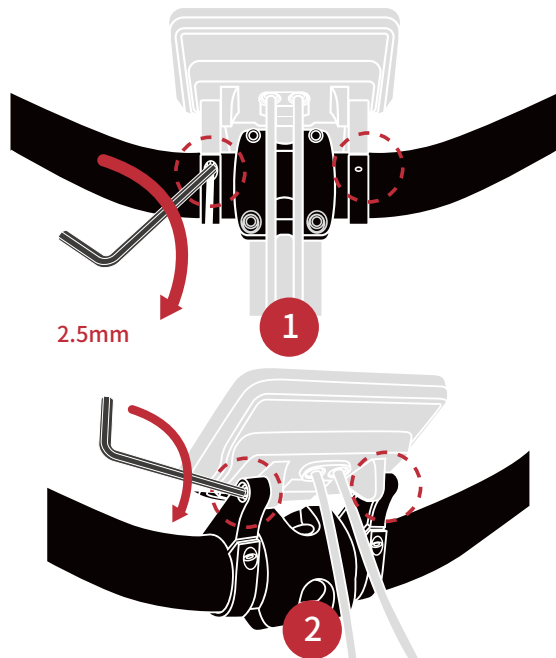

### Install the front light

#### STEP ONE

Use a 5 mm Allen key to undo the screws on the front light bracket. Then, install the front light and reflector on the front of the handlebar.

Adjust the angle of the front light to be tilted slightly downwards, then tighten the screws to secure it in place.

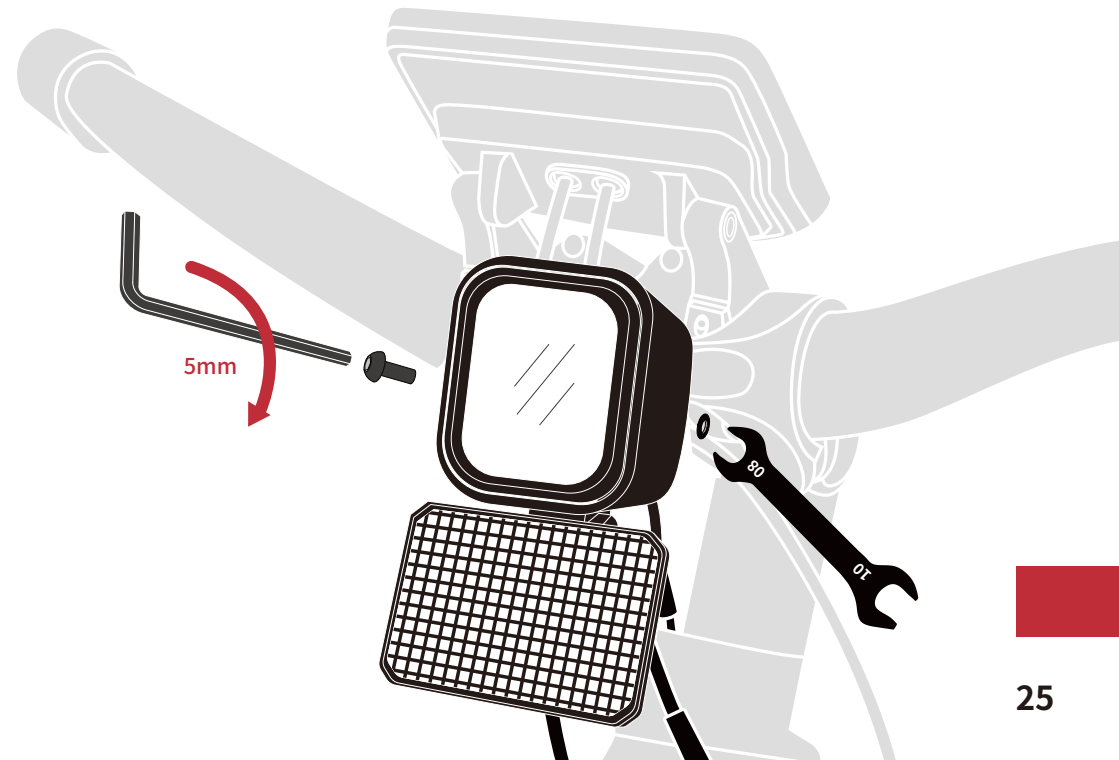

## Install the bell

### STEP ONE

Loosen the screws on the bike bell using a Phillips screwdriver, install the bell onto the right handlebar, adjust its position to where you can easily ring it while riding, and re-tighten the screws.

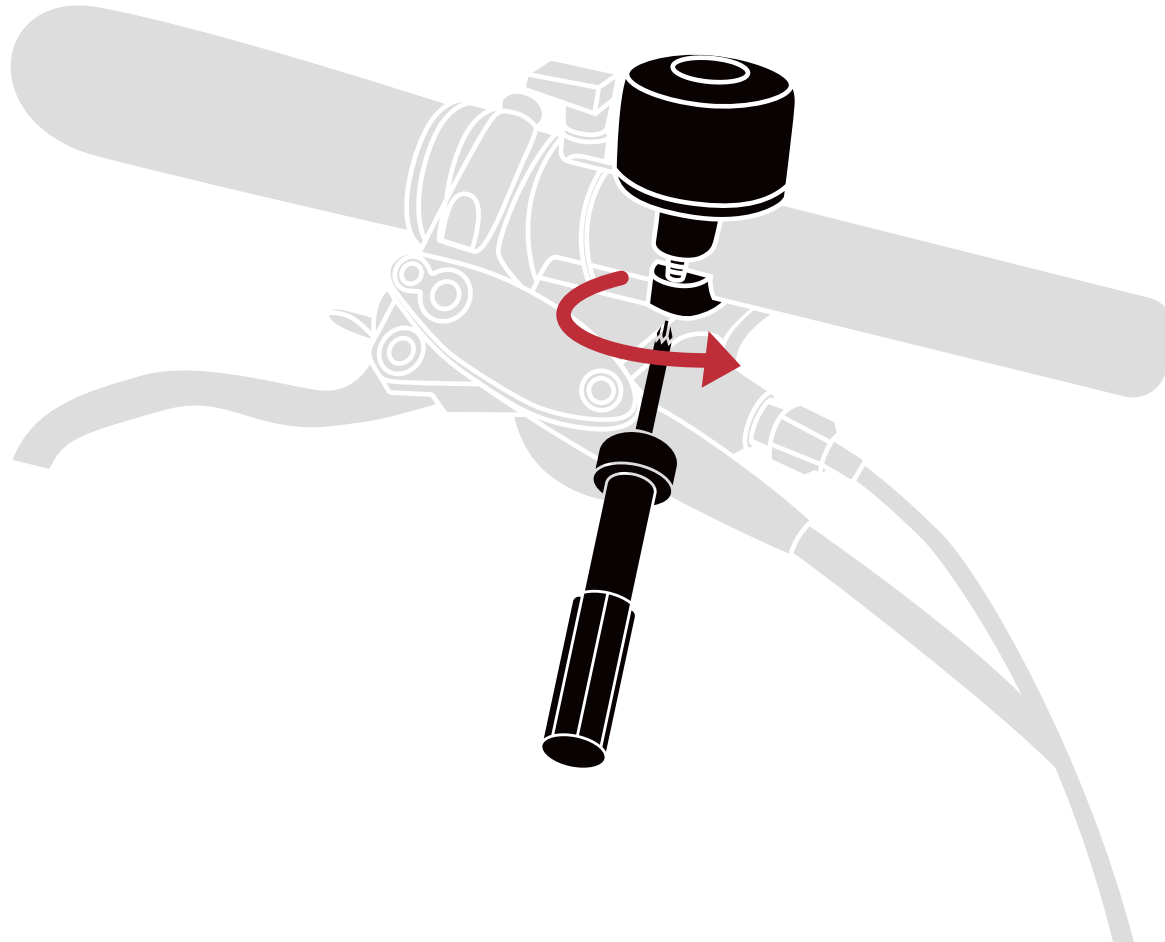

## 06 Adjust the seat

### STEP ONE

Adjust the height

Open the quick release lever on the seat post, adjust the seat to the appropriate height, and then lock it in place.

Make sure the direction of the saddle is in a straight line with the direction of the wheels.

Do not exceed the maximum height limit of the saddle.

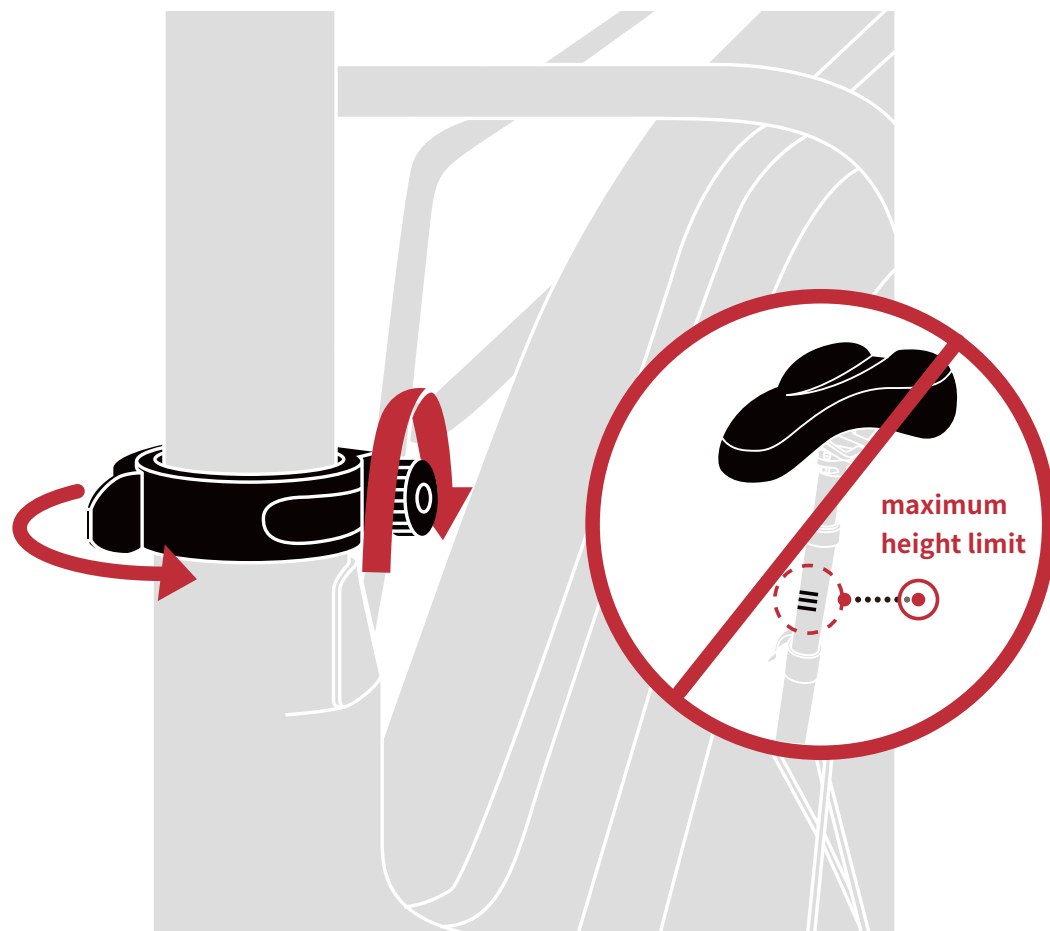

### STEP TWO

Adjust the angle and position

Use a 5 mm Allen key to loosen the screws **1** under the seat, move the seat backward or forward as needed, adjust the tilt angle to the appropriate position, then tighten the screws **1** in sequence **2**

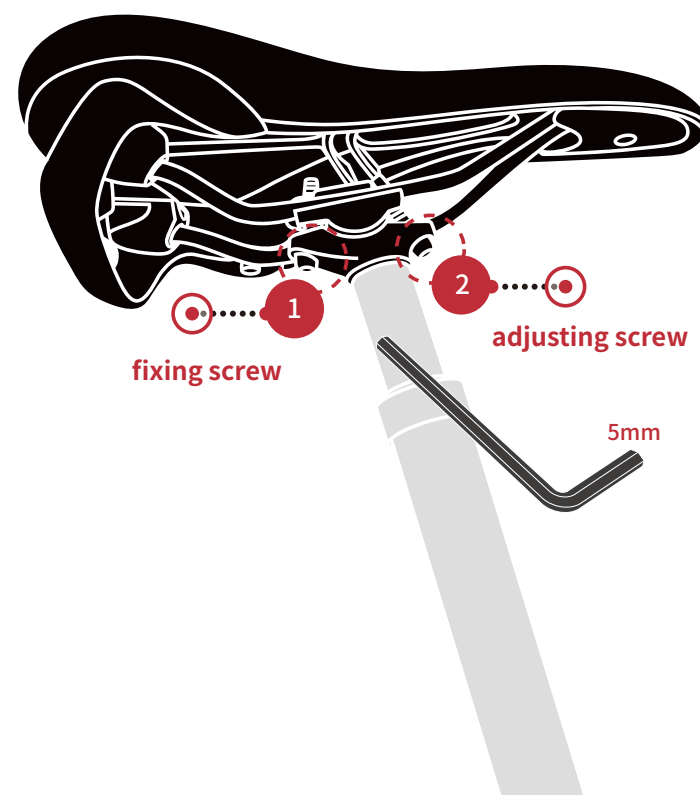

## 07 Install the pedals

### STEP ONE

Align the pedal axle labeled “L” with the hole at the end of the bicycle’s left crank arm. Hold the pedal in place with one hand and tighten the locking nut counterclockwise with the other hand. Once it becomes too hard to do by hand, use a 15 mm open-end wrench to tighten it further. Make sure the pedal axle is inserted straight into the hole.

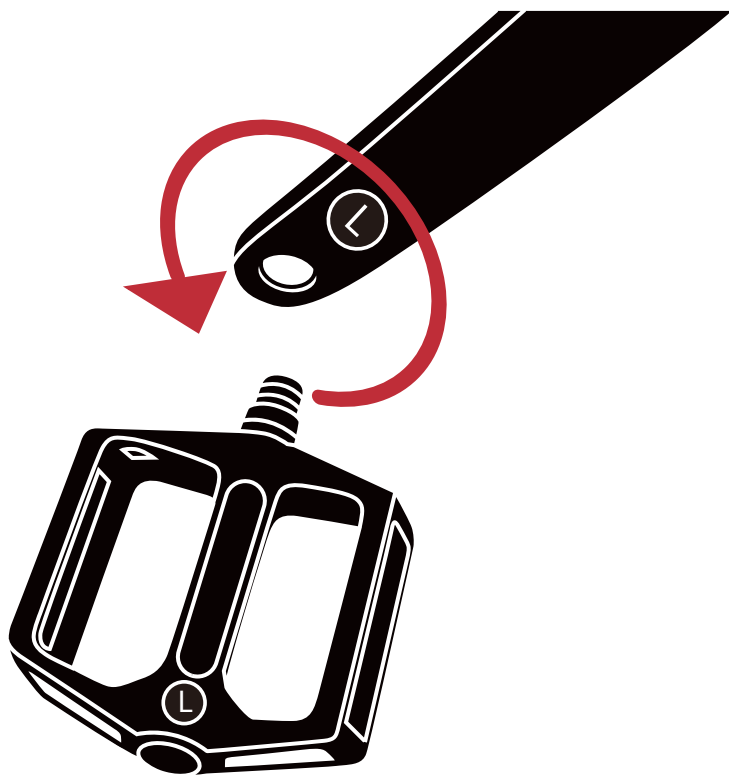

### STEP TWO

Install the right pedal following the same steps as the left pedal, using the one marked “R.” Remember to tighten the nut clockwise this time.

#### ⚠ NOTICE!

Be careful not to reverse the tightening directions, as this could damage the crank thread.

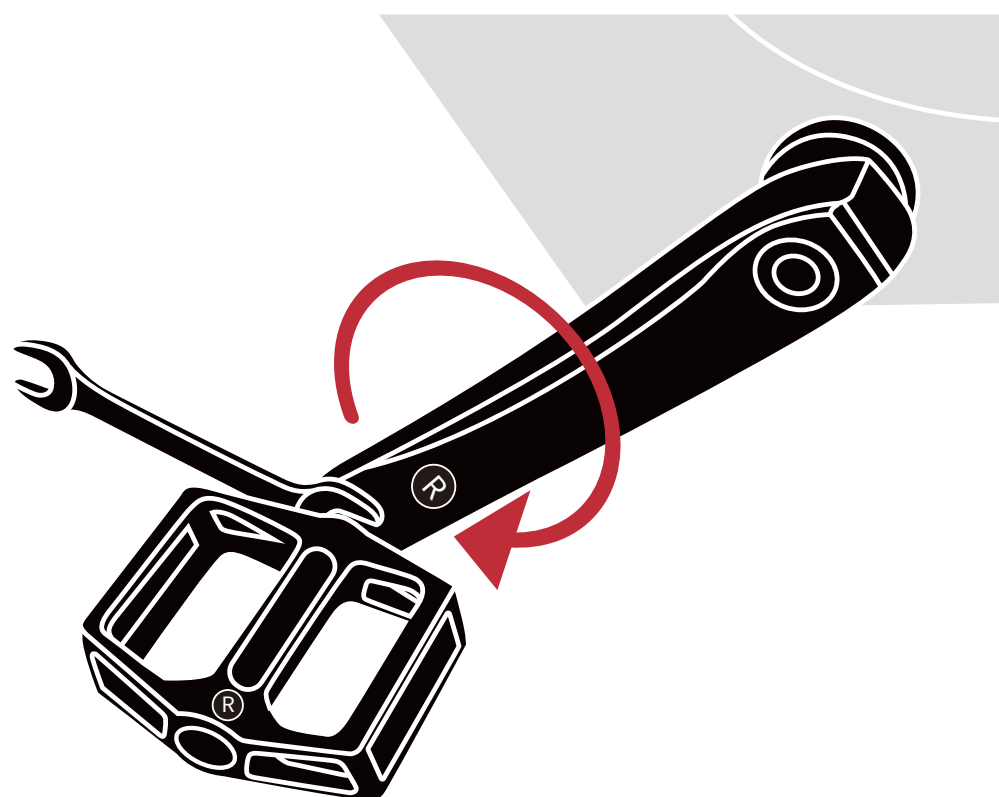





## 08 Cable management

### STEP ONE

Before connecting the cables, make sure they are free of stains, tangles, and damage and check that the number of cables is correct.

The left cross-sectional image is at the stem, and the right cross-sectional image is at the handlebars.

Cable type	Wire colors	Cross section
Display	Green	
Left&Right brake	Red	
Front Light	Red	
Display control button	Blue	

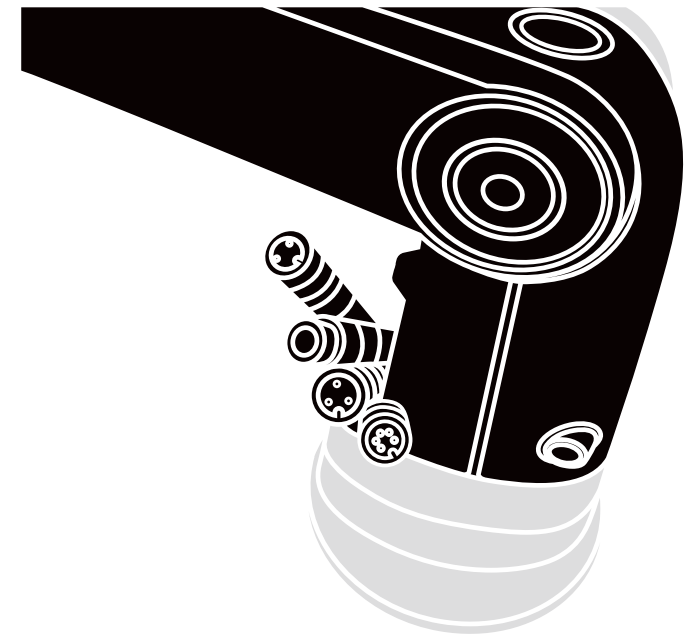

## STEP TWO

When connecting two cables, make sure that both cables have the same function, color, and notches. Ensure that the arrows on both cables are fully aligned before connecting them and that you push the cables all the way in.

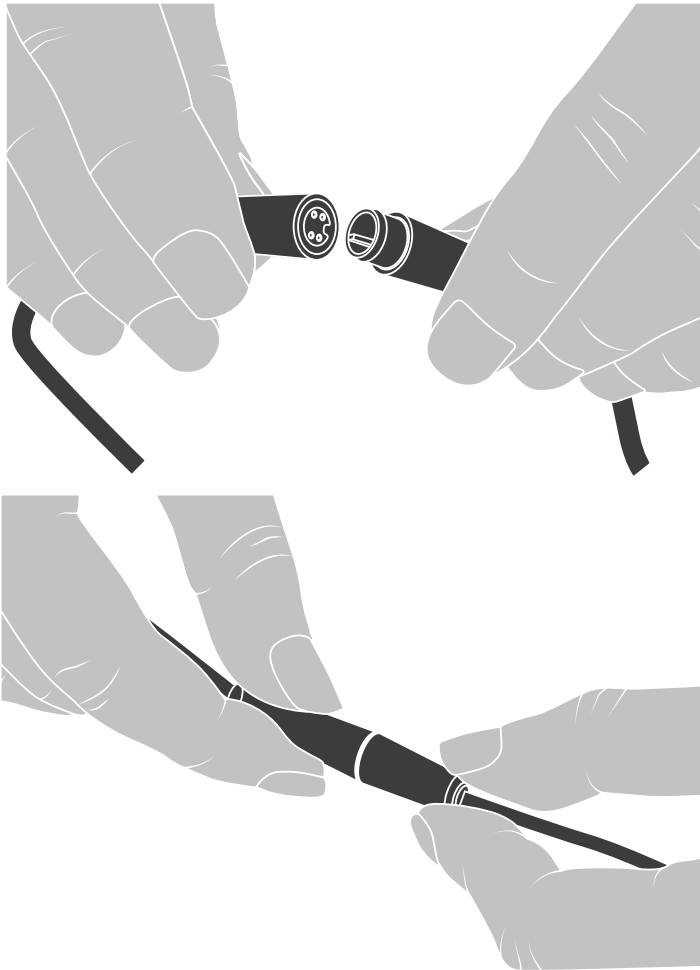

⚠ Ensure that the interface colors match and the two terminals have the same function. The notch on the two ends of the interface must correspond.

⚠ When wiring, the arrow on the connector at both ends of the wire must be aligned in a straight line. Do not forcibly insert or remove the connector.

⚠ After the wiring is completed, make sure there are no extra interfaces in the circuit, the joint is covered well, and there are no exposed wires.

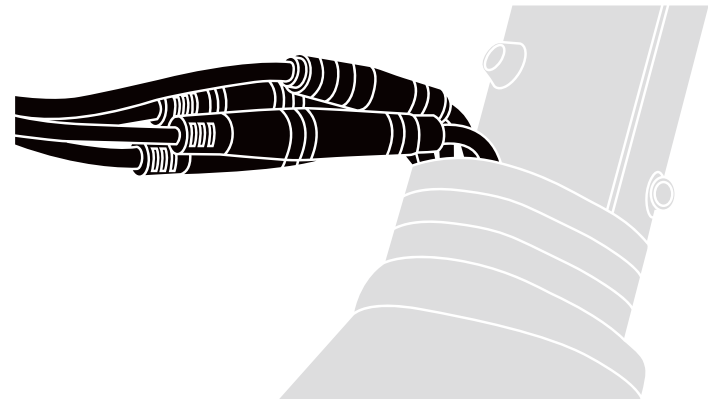



## 09 Adjust the handlebar angle

### STEP ONE

Use a 5 mm Allen key to loosen the screw on the right side of the handlebar by turning it counterclockwise. Adjust the handlebar to the desired angle and then retighten the screw.

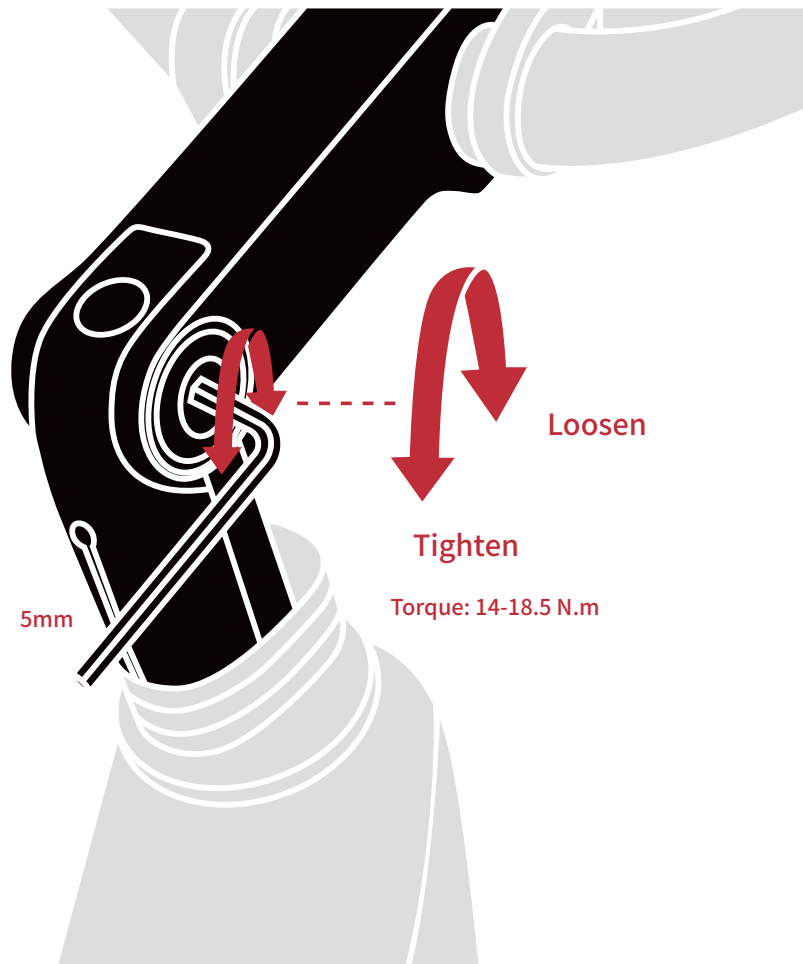

The adjustable range for the handlebar angle is 0–60°. You can adjust the handlebar angle according to your height and riding habits. The handlebar angle will affect your riding posture, so make sure that the height of the handlebar is not higher than your shoulders after adjustment.

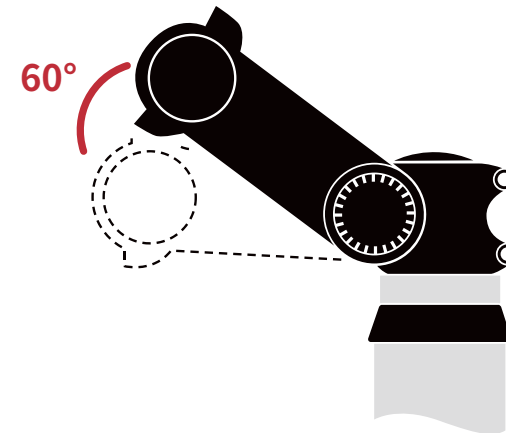

- ⚠ The angle of the handlebar will change after adjusting the handlebar stem. Make sure to readjust the handlebar to a comfortable and safe position.
- ⚠ Do not pull or twist any cables when adjusting the handlebar stem, and make sure that the connectors are securely fastened.

## 10 Adjust the front suspension

The suspension fork can move up and down to absorb bumps as you ride, making riding on rough roads more comfortable. Fully locking it can improve your pedaling efficiency.

There is a lock/unlock knob on the right side. Follow the steps below to open or close the suspension fork:

To fully lock: Turn the knob on the suspension fork clockwise until it stops.

To unlock: Turn the knob counterclockwise until it stops.

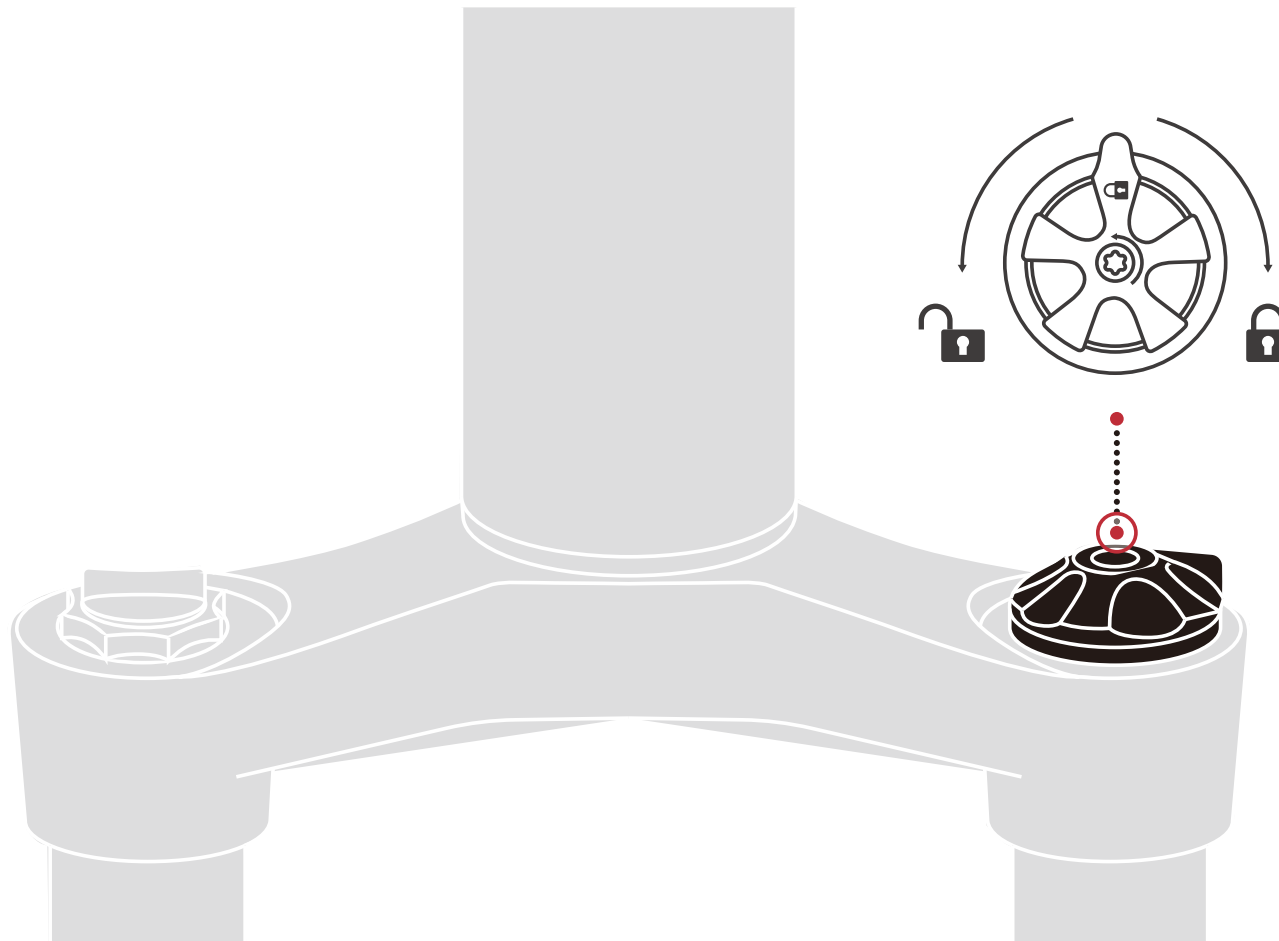

## 11 Pre-ride check

### 01 Check your tire pressure

After installing the e-bike, check the tire pressure of the front and rear tires. Before the first use, inflate the front and rear tires to the recommended pressure of 30–50 psi.

### 02 Check the brakes

Check the brakes to ensure that they are functioning normally. Note that the left brake lever brakes the front wheel, while the right brake lever brakes the rear wheel. When the brakes are applied when the e-bike is on, the brightness of the taillight will significantly increase to serve as a warning.

### 03 Saddle inspection

Rotate the saddle and check whether it is locked in place. If you can twist it, readjust it and relock the seat post's quick-release lever.

### 04 Check the gears

⚠ The E-bike can only shift gears while moving, do not shift gears while stationary. Check the e-bike's gear-shifting functionality. The number on the gear shift represents how many gears the e-bike has and corresponds to the rear derailleur's gear cassette. The cassette gears correspond to the gear shift positions from 1 to 9, with larger cogs corresponding to lower gear positions.

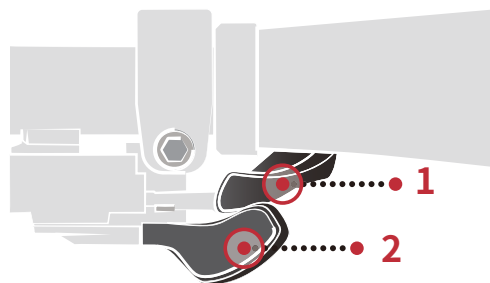

Shifting operation: To shift down one gear, press gear lever 2. To shift up one gear, pull gear lever 1.

### 05 Check the handlebars

Hold the left and right handlebar grips with both hands and twist them forcefully while keeping the e-bike still. Check whether the handlebars are securely fastened and whether the grips are loose. If the handlebars are loose, tighten the handlebar screws. If the grips are loose, use a 2.5 mm Allen key to tighten the grip-locking screws.

Check each component on the handlebar, such as the display panel, buttons, front light, gears, and brakes, to ensure they are securely installed.

## 06 Turn on the e-bike

Before the first use, fully charge the battery. Make sure the battery is securely locked onto the frame before riding. For more detailed battery and power level information, please refer to the Battery Operation section.

Press the wake-up button on the battery to wake it up. Then, long press the power button on the display to turn on the e-bike. To turn off the e-bike, long press the power button on the display again. For display operation and settings, please refer to the Display Instructions section.

Your e-bike assembly is now complete. If there are any problems or questions you encounter during assembly, please contact us as soon as possible.

To properly tighten the screws on your e-bike, a torque wrench with an adjustable range is required. Below, you can find the torque specifications for adjusting components of the e-bike during assembly. If you cannot find the torque specification you need in the table below, contact a professional for assistance.

Screw Location	Type	Torque
Handlebar	Clamp	7-9 N.m
Brake lever	Clamp	3-6 N.m
Shift lever	Clamp	7-9 N.m
Stem	Angle adjustment	14-18.5 N.m
Seat	/	10-12 N.m
Display	Angle adjustment	2-4 N.m
Bell	/	3-6 N.m
Pedals/crank arms	Open -end wrench	35-45 N.m
Mudguard	/	3-6 N.m

# TROUBLESHOOTING ISSUES



# Troubleshooting

## ⚠ NOTICE!

After assembling the e-bike according to the steps laid out in this manual, if you have any questions, please reference the following information to troubleshoot and solve the problem. If the suggestions below do not solve your problem, please contact us for assistance.

Problem	Details	Common Solutions
The display won't turn on	After assembling the e-bike and connecting the battery, pressing the power button does not turn on the display	<ul style="list-style-type: none"> <li>-Remove the battery and check the color of the indicator light. A red light means the battery is dead, and a green light means it has power.</li> <li>-After checking the battery level, reinstall it onto the e-bike. Short press the battery's start button to activate it.</li> <li>-Long press the display power button to check whether the display can be turned on and the e-bike can be used normally.</li> </ul> <p>If the above steps do not solve the problem, please contact Vanpowers Bike's customer service team immediately or seek technical support from a nearby store.</p>
After turning on the display, the motor does not work	The display starts up normally, but the motor cannot be used to generate power assistance	<p>First, check the gear indication on the display. If you are in the "N" gear state, you can switch gears by pressing the "+" button to activate the corresponding motor assistance.</p> <p>If a red error message appears on the display, it means that the screen and motor are malfunctioning. Please contact Vanpowers Bike's customer service team immediately or seek technical support at a nearby store.</p>
The battery won't charge	The battery cannot be charged or turned on properly	<p>If you are trying to charge the battery outdoors in the cold, the charging functionality may be affected due to the low temperature. We recommend bringing the battery to a warm indoor area to restore its charging functionality at room temperature.</p> <p>If you are unable to charge the battery while indoors or in a warm outdoor environment, it may be because the battery is in a state of overvoltage or undervoltage. Unplug it from the e-bike, short press the power button to turn it off and on again, and then charge the battery when it returns to normal.</p> <p>If your battery has not been used for a long time (more than three months), insert the charging cable into the battery, short press the wake-up button, and wait briefly for the battery to return to its original state.</p> <p>If the above steps do not resolve the issue, please contact Vanpowers Bike's customer service team immediately or seek technical support at a nearby store.</p>

# CHARGING & REMOVAL OF BATTERY

## 01 Battery information

Before using the battery, please familiarize yourself with all the components of the battery and charger.

A	Key	E	Battery
B	Lock	F	Frame
C	Charging port and charger cable	G	Battery button
D	Wake-up button	H	Charge level light

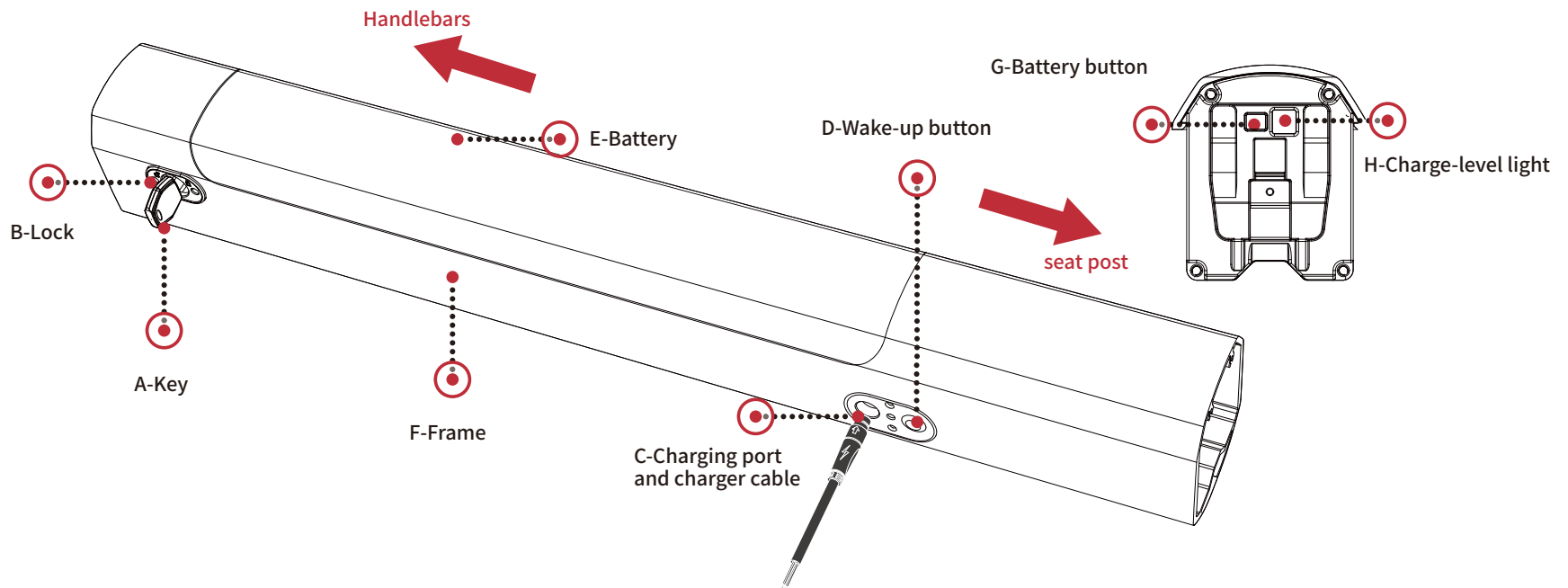



### Battery Level Indicator

There is a battery level indicator on the top of the battery. Press the button on the top of the battery, and the indicator light will display different colors to indicate the current battery level as follows:

Blue light: Full battery level (80–100%)

Green light: Normal battery level (30–80%)

Red light: Low battery level, battery needs to be charged (0–30%)

### Battery Wake-Up Button

There is a battery wake-up button on the bottom left side of the frame, next to the battery charging port. When the battery has not been used for a long time, it will enter a sleep state, and the battery will not supply power to the e-bike, meaning the display will be unable to start up. To make the battery work normally again, you need to short press the battery wake-up button to release the battery from the sleep state, after which the display can be operated normally.

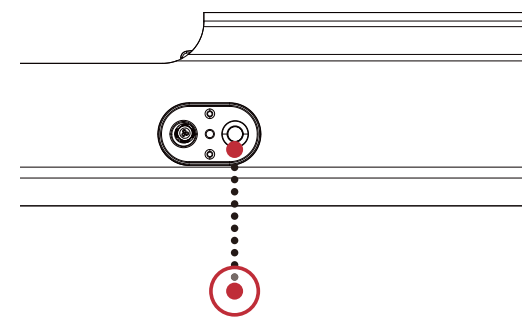

Wake-up button



## 02 Removing the Battery

To storage, transportation, safety, or charging, you can remove the battery by following these steps:

01 Insert the key into the keyhole and turn it counterclockwise 90° to the unlock position.

02 After the battery is unlocked, the top half of the battery will pop out of the frame.

03 Carefully pick up the battery, tilt it and move it away from the base contact point.

04 Pull the battery out of the base. When removing the battery from the bike, use both hands to avoid dropping it and damaging the battery. Do not touch or bend the terminal contact points.

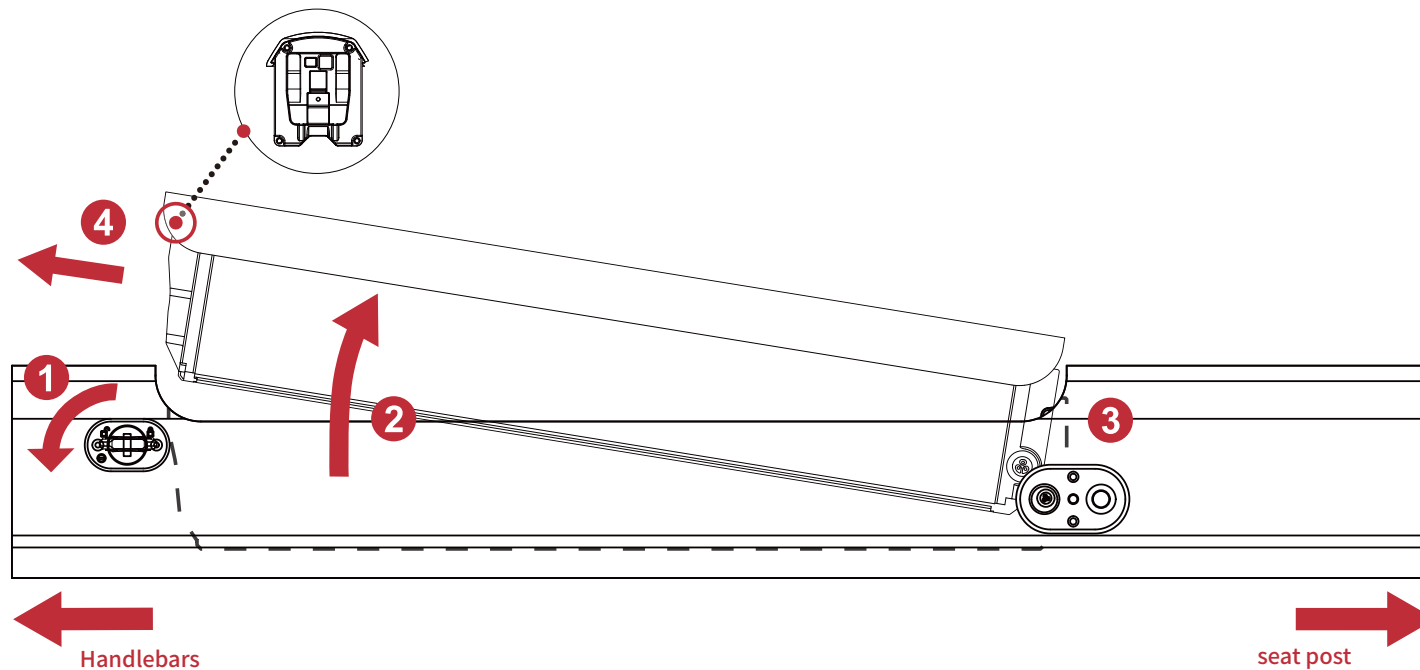

### 03 Installing the Battery

Ensure the key is inserted into the frame and kept in the open position.

1. Make sure the key is inserted into the frame in the open position.
2. Slowly push the battery along the frame until it aligns with the terminal contact points.
3. Push down on the top of the battery. Gently pull the battery up to check that it is securely in place.
4. After installing the battery, turn the key clockwise 90° to lock the battery. You will feel resistance when you try to remove the key if the battery is not fully locked.

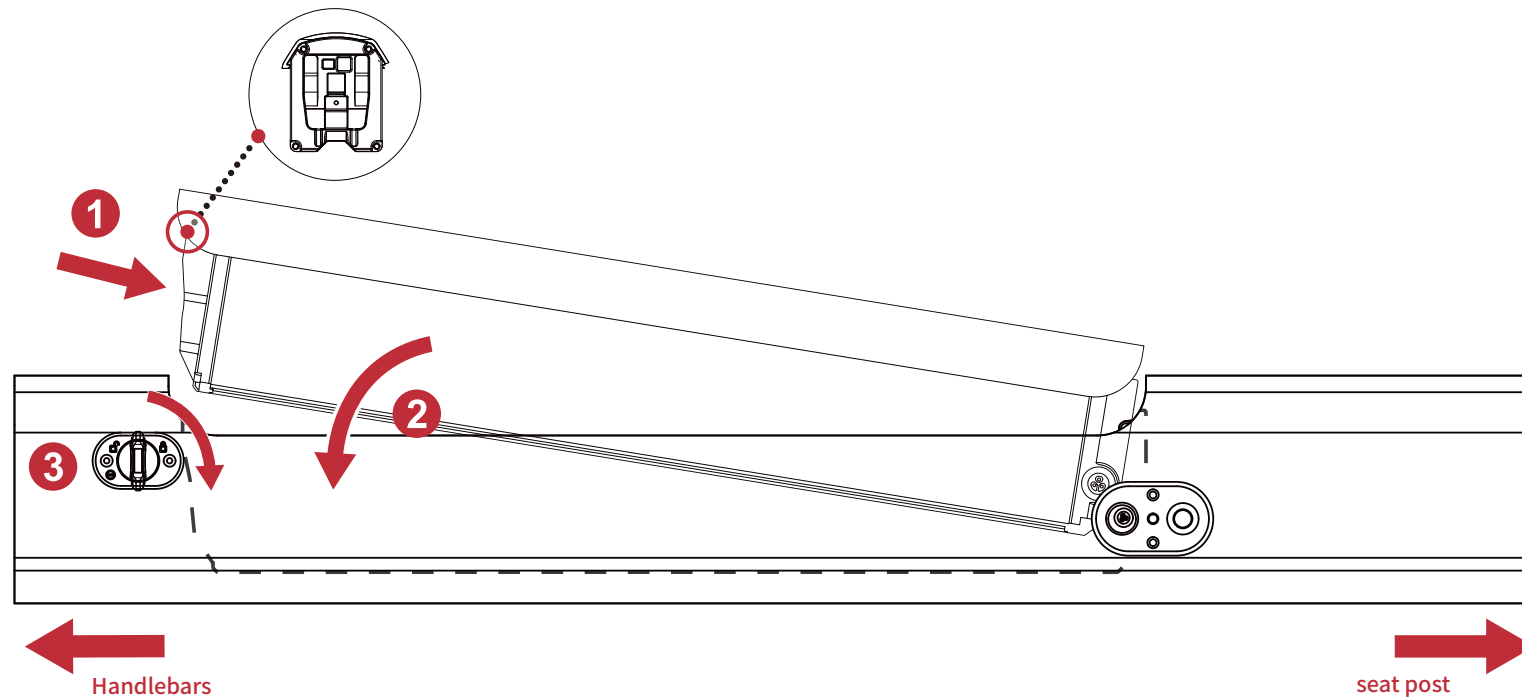

## 04 Battery Charging Methods

⚠ Always charge the battery at temperatures between 32°F and 104°F (0°C and 40°C) and make sure that the battery and charger are undamaged before charging. If you notice anything abnormal during charging, stop charging/using the battery/bike and contact the Vanpowers Bike Support Team for assistance.

When charging the battery, you have two options: charging it on the bike or charging it separately. You can use whichever charging method is most suitable according to your needs and situation. The specific steps for charging the battery while attached to the e-bike are as follows:

### A.Charging with your E-bike

01 Locate the charging port on the left side of the battery at the bottom of the down tube and remove the rubber plug from the port.

02 Insert the charging cable from the charger output into the battery charging port.

03 Plug the charger input plug into a standard AC home power outlet (110–240V 50/60 Hz). Charging has begun when the LED status light on the charger lights up red

04 When fully charged, the status light will turn green. Once charging is complete, unplug the power cord from the wall socket, remove the charging cable from the battery charging port, and finally, replace the rubber plug.

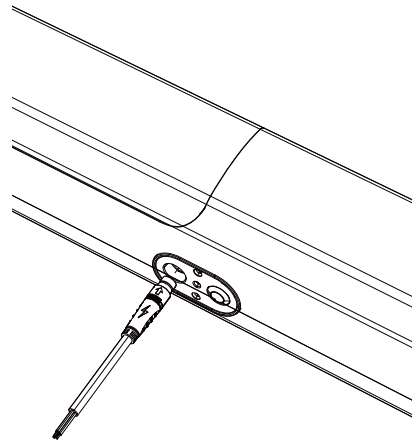

You can also remove the battery from the frame and charge it separately. The steps for charging are the same as above.

## 05 Charger Safety Information

### **WARNING**

The charger should only be used indoors in a cool, dry, well-ventilated area on a flat, stable, hard surface.

Avoid exposing the charger to liquids, dust, debris, or metallic objects. Do not cover the charger with anything while in use.

Store and use the charger in a safe area away from children.

Charging the battery to full before each use helps to prolong its lifespan and reduces the risk of overdischarge.

Do not use any charger other than the original charger you received with your order or a charger designed specifically for the particular bike that you purchased directly from Vanpowers Bike.

This charger is designed for standard household AC power sockets with 110–240V 50/60 Hz input voltage, and it automatically detects and calculates the input voltage. Do not attempt to open the charger or modify the voltage input.

Do not yank or pull on the charging cable. When unplugging, pull on the plastic plug to carefully remove the AC/DC cable.

It is normal for the charger to become moderately warm during charging. If the charger is too hot to touch, or if you smell an odor or notice any other signs of overheating, stop using the charger and contact the Vanpowers Bike Service Center.

Keep the indicator facing up when using the charger. Do not invert the charger, as this can inhibit cooling and shorten its lifespan.

 Only use the original charger provided by Vanpowers Bike or one designed for your specific bike model that is approved by Vanpowers Bike. Do not use aftermarket chargers, which may cause damage, serious injury, or death.

 Not following the battery charging information listed here may cause unnecessary damage to the charging components, battery, or charger and may result in poor battery performance or failure to work properly. Battery damage incurred this way is not covered by warranty.

## 06 Battery Safety Information

### **WARNING**

#### MOVING AND STORAGE INSTRUCTIONS

If your e-bike is in storage for more than 2 weeks, follow the instructions below to maintain the health and lifespan of the battery.

Charge (or discharge) the battery to about 75% capacity.

Do not leave the battery on the bike frame. Remove it from the bike during long-term storage.

Store the battery in a dry, climate-controlled indoor location at a temperature between 32°F and 104°F (0°C and 40°C).

Check the battery once a month and use the Vanpowers Bike charger to charge the battery back to 75% if necessary.

If stored for a prolonged period of time, keep the battery cool and dry and charge it for 2 hours every 3 months.

Do not store the battery at low or no charge, as this may permanently reduce its capacity or cause it to malfunction.

 Always follow the above instructions for storing Vanpowers Bike bicycles and batteries. Failure to follow the correct battery storage methods may cause the battery to malfunction. Replacement under these circumstances is not covered by warranty.

 If the battery is physically damaged, is non-functional, performs abnormally, or has fallen, stop using/charging it immediately and contact Vanpowers Bike.

 Please do not open the battery casing, as this will void the warranty and may cause damage to the battery, property loss, or serious injury or death.

# DISPLAY INSTRUCTIONS



# Button Functions

## 01 Button Functions

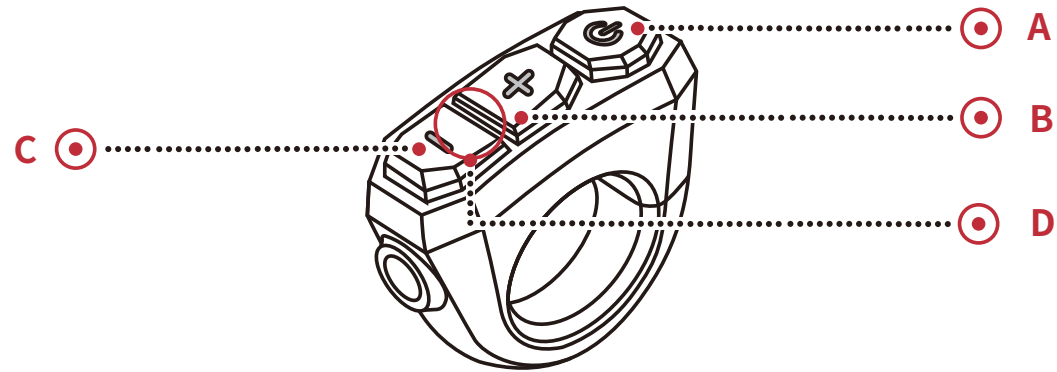

序号	Description	Short press	Press and hold (3 seconds)
A	Power button	Switch display between odometer/speed/time	Power on/off
B	“+” button	Increase assist level	Front light on/off
C	“-” button	Reduce assist level	Enter boost mode
D	+ and - buttons simultaneously	None	Enter menu interface

\*The display defaults to gear N upon start up, in which the motor will not start. You will need to switch to any other gear to enter pedal assist mode.



## 02 Introduction to Display Interface

To turn on the display, press the wake-up button at the bottom of the battery to make it exit sleep mode (see the Battery Operation section for details). Then, press and hold the power button to turn on the display. Press and hold the power button again to turn off the display. Once the display is turned on, it will show the main page, and the various data on the main page are explained as follows:

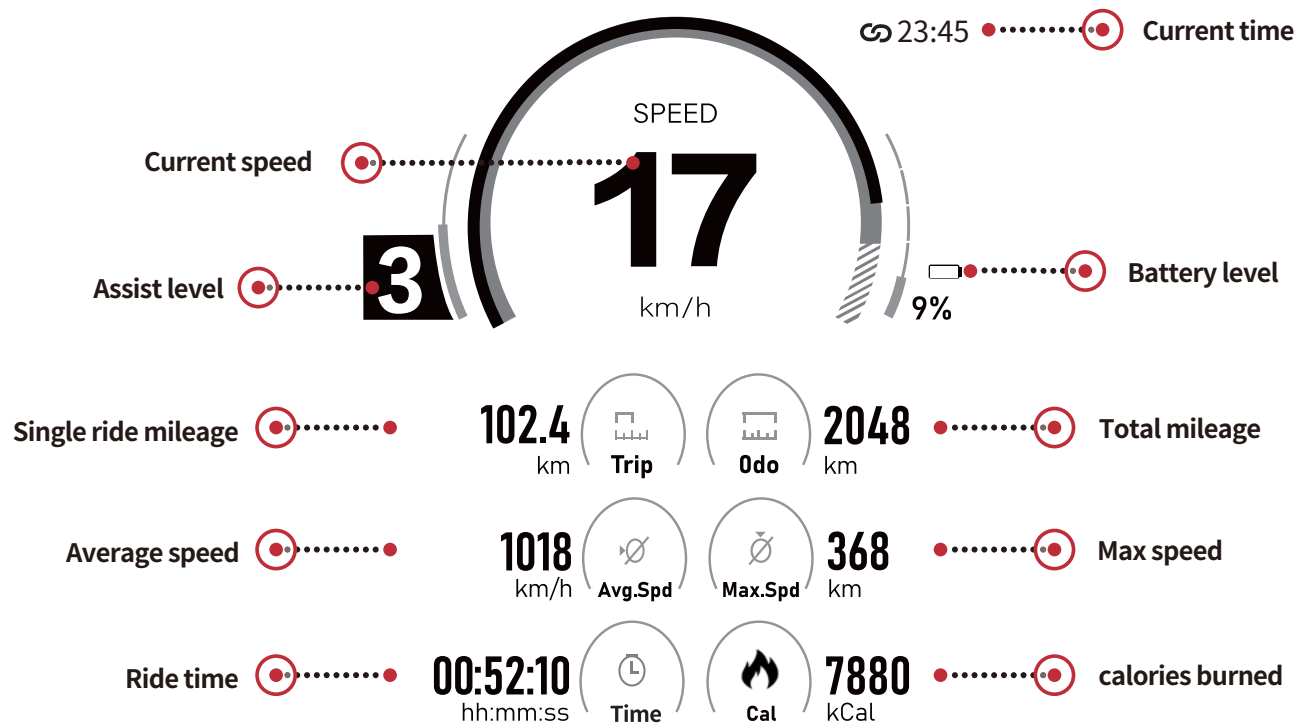

### 03 Menu Interface Settings

To ensure user safety, the menu interface can only be accessed when the e-bike is stationary (speed is 0).

With the display turned on, long press the “+” and “-” keys simultaneously to enter the menu interface. See the table below for menu interface operation instructions.

Display Unit	km
Backlight Brightness	<u>5</u>
Auto Light	OFF
Auto Power-Off	<u>99</u> min
Set Time	<u>00:00</u>
Password	
Clear Trip	
Bluetooth Connection	
System Info	
 Back	

Button(s)	Press type	Function(s)	
“+” and “-” buttons	Simultaneous long press	Enter the menu interface	
Power button	Short press	Enter the selected menu item	Confirm a value change and return to the menu item
“+” button	Short press	Move the cursor up to switch between menu	Increase the value of a parameter item
“-” button	Short press	Move the cursor downward to switch between menu items	Decrease the value of a parameter item

The following is an explanation of the functions of each menu item:

01 Display Unit: Toggle the units seen on the display between kilometers and miles.



02 Backlight Brightness: Adjust the screen's backlight brightness between 5 levels. Level 5 has the brightest screen, while level 1 has the dimmest screen. Choosing the "Auto" option means that the backlight brightness will be automatically adjusted according to the ambient light.



03 Auto Headlight: Toggle the front headlight's automatic capabilities. When on, the display panel will detect the ambient light level and automatically turn headlight on/off where appropriate.



04 Auto Power-Off: Set the automatic shutdown time for the display at a range of 0-99 minutes, with 0 meaning the display will remain on continuously



05 Set Time: Set the time by short-pressing the power button to select the hour/minute digits and using the "+" and "-" buttons to adjust the values. The hour value ranges from 00 to 23, and the minute value ranges from 00 to 59.



06 Password: Enable or disable the startup password setting.



07 Change Password: Set a 4-digit password by modify the values on the screen with the "+" and "-" buttons; press the power button to switch to the next digit, then press it again to confirm and exit.



08 Clear Trip Data: Use the "+" and "-" buttons to switch between YES and NO, then press the power button to confirm and exit. Note that resetting your trip data will not only reset your odometer, but also your trip time, average speed, max speed, and total calories burned.



09 Bluetooth Connection Settings



10 To check the current version number of the display, go to System Information and press the power button to confirm.



11 Back: Return to the main display page by pressing the power button to confirm your settings.



## 04 Display Error Codes

This electric bike is equipped with an error detection system integrated into the display. In the event of an electrical system malfunction, the display will show an error code. Below are the most common error codes. If your bike displays an error code at any time, please contact Vanpowers Support immediately or seek technical support at your nearest store.

Error Code	Definition
07	Controller overvoltage
08	Error with the hall sensor signal
09	Error with the Engine phase' s
10	Motor overheating
11	Motor temperature sensor malfunction
14	Controller overheating
25	Torque signal Error
30	Display communication failure
41	Battery Overvoltage
45	Battery temperature too high
46	Battery temperature too low

# WARRANTY



## Warranty

Vanpowers provides warranty services for its electric bicycles. If a hardware defect is found within the warranty period, we will resend the product in accordance legal limits and guidelines. The warranty covers defects in materials and workmanship discovered during normal use of the product. The warranty does not cover any damage caused by improper use; failure to follow any product instructions or perform any preventative maintenance; unauthorized repair; or external causes such as accidents, abuse, or other acts or events beyond our reasonable control.

Part	Warranty Period	Part	Warranty Period	Part	Warranty Period
Battery	24 months & 500 charge-discharge cycles	Brake lever	12 months	Seat tube	12 months
Motor	24 months	Disc brake	12 months	Pedal	12 months
Sensor	24 months	Fender	12 months	Derailleur	12 months
Controller	24 months	Chainring	12 months	Handlebar	12 months
Frame	6 years	Kickstand	12 months	Rim	12 months
Front fork	24 months	Tire	12 months	Handlebar grip	12 months
Throttle	12 months	Headlight	12 months	Bottom bracket	12 months
Display	12 months	Chain	12 months		
Charger	12 months	Seat	12 months		

# CARE & MAINTENANCE



## **WARNING**

Regular inspection and maintenance are key to ensuring safe e-bike operation and extending the lifespan of your e-bike. Wear and maintenance requirements may vary depending on usage conditions. We recommend inspecting, maintaining, and replacing the e-bike according to the intervals given in the table below.

Inspection	Distance Traveled*	Hours of Operation*	Duration of Use*
1st inspection	After 190 mi (300 km) or*	After 15 hours or*	After 3 months
2nd inspection	After 1250 mi (2000 km) or*	After 100 hours or*	After 1 year
Each subsequent inspection	After a further 1250 mi (2000 km) or*	After a further 100 hours or*	After a further 1 year

\*Whichever is the earliest

 If you use your e-bike in extremely challenging conditions or ride more than 1250 miles/2000 km per year, we recommend shortening the inspection interval and having a professional inspection every 6 months.



Your e-bike contains many components that require lubrication to operate safely. We recommend that you lubricate these key components according to the time intervals provided in the table below to ensure smooth operation of the e-bike.

<b>Part</b>	<b>Inspection Interval</b>	<b>Maintenance Method</b>
Chain	After 190 mi (300 km)	Chain oil
Brake cable and gear cable	Once a year when not functioning optimally	Silicon-free grease
Wheel bearings and pedal bearings	Once a year	Bearing grease
Fork	Once a year when not functioning optimally	Dedicated spray grease
Quick-release lever	Once a year	Grease, spray oil
Gear shift	Once a year when not functioning optimally	Spray oil



## 01 Frame and fork

Check the frame and fork for any bends or fractures

If the frame or fork is bent or fractured, contact a professional to replace them.

Do not use the bike if you notice any cracks, deformations, or discolorations.

## 02 Seat

Check whether you can rotate the seat. If it can be twisted, readjust and lock the seat post's quick-release lever.

Check whether you can move the seat horizontally.

If the seat moves, tighten the seat screws.

## 03 Brakes

Check whether the brake levers are securely fastened to the handlebars and whether they show signs of wear.

Check the front and rear brakes, motor cutoff functions, and brake lights to ensure that they are working properly.

Check the wear level of the disc and brake pads.

If they are excessively worn, replace them immediately.

## 04 Tire

Check whether the tire pressure is within the recommended parameters posted on the tire sidewall.

Check whether the tire tread has visible cracks, damage, or excessive wear.

If the tire is cracked or damaged, or if the tread depth is too low, contact a professional to replace the tire.

## 05 Wheels

Check whether the front and rear wheels can move sideways and whether the wheel nuts can rotate.

If the wheel nuts move, have a professional check the screws.

If the quick-release lever moves, adjust the quick-release lever.

Check whether the distance between the front wheel and the fork and between the rear wheel and the frame is equal.

If the distance is unequal, have a professional check and adjust the front and rear wheels.

Lift the bike and rotate the front or rear wheel to check whether the wheel swings outward.

If the wheel swings outward, have a professional check and adjust the wheel.

Check for cracks, deformations, or discoloration on the front and rear wheel hubs.

If the hub is cracked, deformed, or discolored, stop using it and replace it.

Gently squeeze the spokes with your thumb and other fingers to check whether the tension of the spokes is equal throughout.

If the tension changes or the spokes loosen, have a professional check and adjust the tension of the spokes.

## 06 Crank and Pedals

Check whether pedals are securely fastened to the crank.  
Check the crank arms for any bends or deformations and the pedals for any cracks or abnormal sounds. Replace them immediately if found.

## 07 Gears and Chain

Check whether the gear shift is securely fastened to the handlebars and undamaged.  
Inspect the appearance of the gears for any deformations and ensure that they are functioning normally with no chain slipping or jamming.  
Check the chain for any cracks, jamming or excessive wear.  
Contact professionals to replace if found.

## 08 Electric System

Inspect the cable casings for any obvious damage  
Ensure that cable connections are fully covered and free of foreign objects or exposed spots.  
Check the motor for smooth operation and secure installation.  
Inspect the display for any cracks or damage and whether it is securely fastened.  
Check the control buttons for any cracks or damage and whether the panel is securely fastened.  
Inspect the battery for any cracks or damages.  
Check the battery interface terminal for any defects.

## 09 Accessories

Check that all reflectors are installed correctly and unobstructed.  
Make sure the rear rack mounting parts are securely in place.  
Check that the taillight and taillight power cord are securely in place.  
Check for cracks, holes, or any distortions on the fenders. If any damage is found, replace them immediately.  
Check that the fenders are securely in place.



If you have any further questions about using your e-bike, feel free to contact us at any time! For information related to using the app, please refer to the accompanying app user manual.



**Made In China**



**VANPOWERS**

[vanpowers.com](http://vanpowers.com)