



FCC PART 90 SUBPART C TEST REPORT

FCC PART 90

Report Reference No......: **HK2203070911-E**
FCC ID.....: **2BALF-HELEN228**
 Compiled by Testing Engineer
 (position+printed name+signature)...: Gary Qian
 Supervised by Technical Manager
 (position+printed name+signature)...: Eden Hu
 Approved by Authorized Signatory
 (position+printed name+signature)...: Jason Zhou
 Date of issue.....: Feb. 22, 2023

Gary Qian

Eden Hu

Jason Zhou

Representative Laboratory Name : **Shenzhen HUAKE Testing Technology Co., Ltd.**
 Address: 1-2/F., Building B2, Junfeng Zhongcheng Zhizao Innovation Park,
 Heping, Fuhai Street, Bao'an District, Shenzhen, Guangdong,
 China

Testing Laboratory Name: **Shenzhen HUAKE Testing Technology Co., Ltd.**
 Address: 1-2/F., Building B2, Junfeng Zhongcheng Zhizao Innovation Park,
 Heping, Fuhai Street, Bao'an District, Shenzhen, Guangdong,
 China

Applicant's name.....: **Shanghai Helen Telecomm Co., Ltd.**
 Address: Room 1206, No 75, Hailun Road, Hongkou District, Shanghai,
 China

Test specification:
 Standard: **FCC Part 90/FCC Part 2**
 TRF Originator.....: Shenzhen HUAKE Testing Technology Co., Ltd.

Shenzhen HUAKE Testing Technology Co., Ltd. All rights reserved.
 This publication may be reproduced in whole or in part for non-commercial purposes as long as the Shenzhen HUAKE Testing Technology Co., Ltd. as copyright owner and source of the material. Shenzhen HUAKE Testing Technology Co., Ltd. takes no responsibility for and will not assume liability for damages resulting from the reader's interpretation of the reproduced material due to its placement and context.

Test item description: Helen Two-Way Radio
 Trade Mark: N/A
Manufacturer.....: **Shanghai Helen Telecomm Co., Ltd.**
 Model/Type reference.....: Helen 228
 Listed Models: Helen V8S, Helen 418, Helen 531, Helen 539, Helen 760, Helen 780
 Modulation Type: FM/4FSK
 Operation Frequency.....: From 464.5 MHz to 469.9875MHz
 Rating: DC 7.4V From Battery
 Hardware version: V1.4
 Software version: V1.4
 Result.....: **PASS**



TEST REPORT

Test Report No. :	HK2203070911-E	Feb. 22, 2023 Date of issue
--------------------------	-----------------------	--------------------------------

Equipment under Test : Helen Two-Way Radio

Model /Type : Helen 228

Listed Models : Helen V8S, Helen 418, Helen 531, Helen 539, Helen 760, Helen 780

Applicant : **Shanghai Helen Telecomm Co., Ltd.**

Address : Room 1206, No 75, Hailun Road, Hongkou District, Shanghai, China

Manufacturer : **Shanghai Helen Telecomm Co., Ltd.**

Address : Room 1206, No 75, Hailun Road, Hongkou District, Shanghai, China

Test Result:	PASS
---------------------	-------------

The test report merely corresponds to the test sample.
It is not permitted to copy extracts of these test result without the written permission of the test laboratory.



Contents

1 SUMMARY 4

1.1 TEST STANDARDS 4

1.2 Test Description 4

1.3 Test Facility 5

1.4 Statement of the measurement uncertainty 5

2 GENERAL INFORMATION 6

2.1 Environmental conditions 6

2.2 General Description of EUT 6

2.3 Description of Test Modes and Test Frequency 6

2.4 Measurement Instruments List 7

2.5 Related Submittal(s) / Grant(s) 7

2.6 Modifications 7

3 TEST CONDITIONS AND RESULTS 8

3.1 Maximum Transmitter Power 8

3.2 Occupied Bandwidth and Emission Mask 9

3.3 Modulation Characteristic 12

3.4 Frequency Stability 15

3.5 Transmitter Frequency Behavior 17

3.6 Transmitter Radiated Spurious Emission 19

3.7 Spurious Emission on Antenna Port 22

4 TEST SETUP PHOTOS OF THE EUT 24

5 PHOTOS OF THE EUT 25



1.1 TEST STANDARDS

The tests were performed according to following standards:

[FCC Rules Part 90:](#) PRIVATE LAND MOBILE RADIO SERVICES.

[TIA/EIA 603 D:June 2010:](#) Land Mobile FM or PM Communications Equipment Measurement and Performance Standards.

[FCC Part 2:](#) FREQUENCY ALLOCA-TIONS AND RADIO TREATY MAT-TERS; GENERAL RULES AND REG-ULATIONS

1.2 Test Description

Test specification clause	Test case	Verdict
FCC Part 90.205	Maximum Transmitter Power	PASS
FCC Part2.1047	Modulation Characteristic	PASS
FCC Part 90.209	Occupied Bandwidth	PASS
FCC Part 90.210	Emission Mask	PASS
FCC Part 90.213	Frequency Stability	PASS
FCC Part 90.214	Transmitter Frequency Behavior	PASS
FCC Part 90.210	Transmitter Radiated Spurious Emssion	PASS
FCC Part 90.210	Spurious Emssion On Antenna Port	PASS



1.3 Test Facility

1.3.1 Address of the test laboratory

Shenzhen HUAK Testing Technology Co., Ltd.
Add.: 1-2/F., Building B2, Junfeng Zhongcheng Zhizao Innovation Park, Heping, Fuhai Street, Bao'an District, Shenzhen, Guangdong, China

Testing Laboratory Authorization:

A2LA Accreditation Code is 4781.01.
FCC Designation Number is CN1229.
Canada IC CAB identifier is CN0045.
CNAS Registration Number is L9589.

1.4 Statement of the measurement uncertainty

The data and results referenced in this document are true and accurate. The reader is cautioned that there may be errors within the calibration limits of the equipment and facilities. The measurement uncertainty was calculated for all measurements listed in this test report acc. to CISPR 16 - 4 „Specification for radio disturbance and immunity measuring apparatus and methods – Part 4: Uncertainty in EMC Measurements“ and is documented in the Shenzhen HUAK Testing Technology Co., Ltd. quality system acc. to DIN EN ISO/IEC 17025. Furthermore, component and process variability of devices similar to that tested may result in additional deviation. The manufacturer has the sole responsibility of continued compliance of the device.

Hereafter the best measurement capability for Shenzhen HUAK Testing Technology Co., Ltd. is reported

Test Items	Measurement Uncertainty	Notes
Frequency error	25 Hz	(1)
Transmitter power conducted	0.57 dB	(1)
Transmitter power Radiated	2.20 dB	(1)
Adjacent and alternate channel power Conducted	1.20 dB	(1)
Conducted spurious emission 9KHz-12.75 GHz	1.60 dB	(1)
Radiated spurious emission 9KHz-12.75 GHz	2.20 dB	(1)
Intermodulation attenuation	1.00 dB	(1)
Maximum useable receiver sensitivity	2.80 dB	(1)
Co-channel rejection	2.80 dB	(1)
Adjacent channel selectivity	2.80 dB	(1)
Spurious response rejection	2.80 dB	(1)
Intermodulation response rejection	2.80 dB	(1)
Blocking or desensitization	2.80 dB	(1)

(1) This uncertainty represents an expanded uncertainty expressed at approximately the 95% confidence level using a coverage factor of k=2.



2 GENERAL INFORMATION

2.1 Environmental conditions

During the measurement the environmental conditions were within the listed ranges:

Normal Temperature:	25°C
Relative Humidity:	55 %
Air Pressure:	101 kPa

2.2 General Description of EUT

Name of EUT	Helen Two-Way Radio
Model Number	Helen 228, Helen V8S, Helen 418, Helen 531, Helen 539, Helen 760, Helen 780
Model Difference:	All model's the function, software and electric circuit are the same, only model named different. Test sample model: Helen 228.
Power Supply	DC 7.4V from battery
Frequency Range	464.5 MHz to 469.9875MHz
Rate Power	≤5W
Modulation Type	Analog:FM Digital:4FSK
Channel Separation	12.5KHz
Antenna Type	External antenna

Note 1: For more details, please refer to the user's manual of the EUT.

2.3 Description of Test Modes and Test Frequency

The EUT has been tested under typical operating condition. As, test modes selected as below by the technical parameters of the EUT:

Operation Mode No.	Modulation		Channel Separation	Condition	
	FM	4FSK		TX	RX
1	<input checked="" type="checkbox"/>		<input checked="" type="checkbox"/>	<input checked="" type="checkbox"/>	
2	<input checked="" type="checkbox"/>		<input checked="" type="checkbox"/>		<input checked="" type="checkbox"/>
3		<input checked="" type="checkbox"/>	<input checked="" type="checkbox"/>	<input checked="" type="checkbox"/>	
4		<input checked="" type="checkbox"/>	<input checked="" type="checkbox"/>		<input checked="" type="checkbox"/>

Test frequency list:

Modulation Type	Test Channel	Channel Separation	Test Frequency (MHz)
FM	Ch1	12.5KHz	464.5
	Ch2		467.8125
	Ch3		469.9875
4FSK	Ch1		464.5
	Ch2		467.8125
	Ch3		467.925

**2.4 Measurement Instruments List**

Item	Test Equipment	Manufacturer	Model No.	Serial No.	Calibration Date	Calibration Due Date
1	Spectrum analyzer	Agilent	N9020A	HKE-048	Feb. 17, 2023	Feb. 16, 2024
2	Signal generator	Agilent	N5182A	HKE-029	Feb. 17, 2023	Feb. 16, 2024
3	Signal generator	Agilent	83630A	HKE-028	Feb. 17, 2023	Feb. 16, 2024
4	RF automatic control unit	Tonscend	JS0806-2	HKE-060	Feb. 17, 2023	Feb. 16, 2024
5	Power Sensor	Agilent	E9300A	HKE-086	Feb. 17, 2023	Feb. 16, 2024
6	Spectrum analyzer	R&S	FSP40	HKE-025	Feb. 17, 2023	Feb. 16, 2024
7	Wireless Communication Test Set	R&S	CMU200	HKE-026	Feb. 17, 2023	Feb. 16, 2024
8	Wireless Communication Test Set	R&S	CMW500	HKE-027	Feb. 17, 2023	Feb. 16, 2024
9	RF automatic control unit	Tonscend	JS0806-2	HKE-060	Feb. 17, 2023	Feb. 16, 2024
10	Broadband antenna	Schwarzbeck	VULB 9163	HKE-012	Feb. 17, 2023	Feb. 16, 2024
11	Horn antenna	Schwarzbeck	9120D	HKE-013	Feb. 17, 2023	Feb. 16, 2024
12	Receiver	R&S	ESCI 7	HKE-010	Feb. 17, 2023	Feb. 16, 2024
13	Position controller	Taiwan MF	MF7802	HKE-011	Feb. 17, 2023	Feb. 16, 2024
14	Preamplifier	EMCI	EMC0518 45SE	HKE-015	Feb. 17, 2023	Feb. 16, 2024
15	Preamplifier	Agilent	83051A	HKE-016	Feb. 17, 2023	Feb. 16, 2024
16	High pass filter unit	Tonscend	JS0806-F	HKE-055	Feb. 17, 2023	Feb. 16, 2024
17	Spectrum analyzer	Agilent	N9020A	HKE-048	Feb. 17, 2023	Feb. 16, 2024

The calibration interval is 1 year.

2.5 Related Submittal(s) / Grant(s)

This submittal(s) (test report) is intended to comply with FCC Part 90 Rules.

2.6 Modifications

No modifications were implemented to meet testing criteria.



3 TEST CONDITIONS AND RESULTS

3.1 Maximum Transmitter Power

TEST APPLICABLE

The output power shall not exceed by more than 20 percent either the output power shown in the Radio Equipment List [available in accordance with §90.203(a)(1)] for transmitters included in this list or when not so listed, the manufacturer's rated output power for the particular transmitter specifically listed on the authorization.

TEST PROCEDURE

Measurements shall be made to establish the radio frequency power delivered by the transmitter the standard output termination. The power output shall be monitored and recorded and no adjustment shall be made to the transmitter after the test has begun, except as noted below:

If the power output is adjustable, measurements shall be made for the highest and lowest power levels. The EUT connect to the Spectrum Analyzer through 20 dB attenuator.

TEST CONFIGURATION

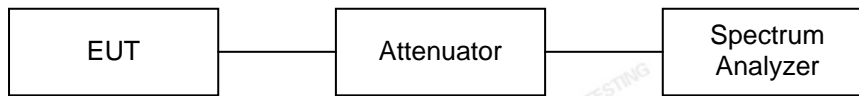

TEST RESULTS

Modulation Type	Test Channel	Test Frequency (MHz)	Test Results (dBm)	Test result
FM	Ch1	464.5	37.314	Pass
	Ch2	467.8125	37.421	
	Ch3	469.9875	37.332	
4FSK	Ch1	464.5	37.124	
	Ch2	467.8125	37.267	
	Ch3	467.925	37.241	

Note: rated power is 5W=37dBm, power limit is rated power *(±20%)



3.2 Occupied Bandwidth and Emission Mask

TEST APPLICABLE

- (a) Occupied Bandwidth: The EUT was connected to the audio signal generator and the spectrum analyzer via the main RF connector, and through an appropriate attenuator. The EUT was controlled to transmit its maximum power. Then the bandwidth of 99% power can be measured by the spectrum analyzer.
- (b) Emission Mask B: For transmitters that are equipped with an audio low-pass filter pursuant to §90.211(a), the power of any emission must be below the unmodulated carrier power (P) as follows:
 - (1) On any frequency removed from the assigned frequency by more than 50 percent, but not more than 100 percent of the authorized bandwidth: At least 25 dB.
 - (2) On any frequency removed from the assigned frequency by more than 100 percent, but not more than 250 percent of the authorized bandwidth: At least 35 dB.
 - (3) On any frequency removed from the assigned frequency by more than 250 percent of the authorized bandwidth: At least 43 + 10 log (P) dB.
- (c) Emission Mask D, 12.5 kHz channel bandwidth equipment: For transmitters designed to operate with a 12.5 kHz channel bandwidth, any emission must be attenuated below the power (P) of the highest emission contained within the authorized bandwidth as follows:
 - (1) On any frequency from the center of the authorized bandwidth f_0 to 5.625 kHz removed from f_0 : Zero dB.
 - (2) On any frequency removed from the center of the authorized bandwidth by a displacement frequency (f_d in kHz) of more than 5.625 kHz but no more than 12.5 kHz: At least 7.27(f_d - 2.88 kHz) dB.
 - (3) On any frequency removed from the center of the authorized bandwidth by a displacement frequency (f_d in kHz) of more than 12.5 kHz: At least 50 + 10 log (P) dB or 70 dB, whichever is the lesser attenuation.

TEST CONFIGURATION

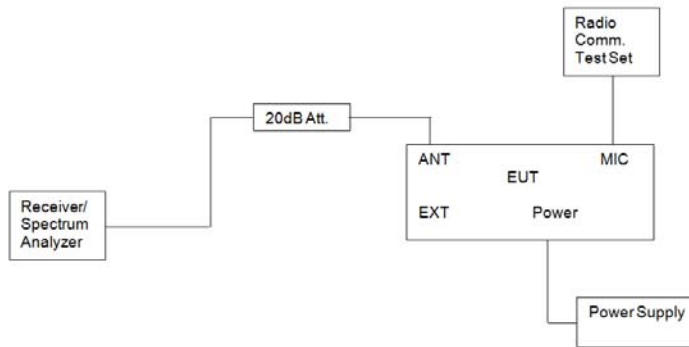

TEST PROCEDURE

- 1 The EUT was modulated by 2.5 KHz Sine wave audio signal; the level of the audio signal employed is 16 dB greater than that necessary to produce 50% of rated system deviation. Rated system deviation is 2.5 kHz (12.5 kHz channel spacing) and 5 kHz (25 kHz channel spacing).
- 2 Set SPA Center Frequency = fundamental frequency, RBW=300Hz, VBW= 3 KHz, span =50 KHz.
- 3 Set SPA Max hold. Mark peak, Set 99% Occupied Bandwidth and 26dB Occupied Bandwidth.

TEST RESULTS

Occupied Bandwidth:

Modulation	Channel	99% OBW (kHz)	26dB bandwidth (kHz)	Limit (KHz)	Result
FM	CH1	8.892	10.21	11.25	Pass
	CH2	8.316	9.150		
	CH3	8.116	9.333		
4FSK	CH1	6.810	9.508		
	CH2	7.729	10.21		
	CH3	7.259	10.07		

The results shown in this test report refer only to the sample(s) tested unless otherwise stated and the sample(s) are retained for 30 days only. This document is issued by HUAK, this document cannot be reproduced except in full with our prior written permission. The more details and the authenticity of the report will be confirmed at <http://www.cer-mark.com>.



FM Modulation

4FSK Modulation

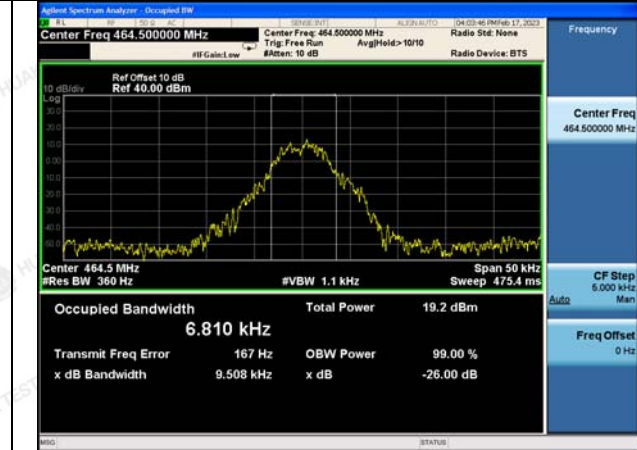

CH1

CH1

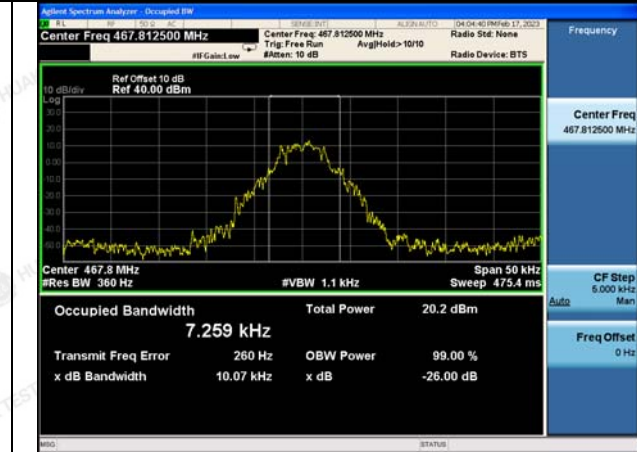
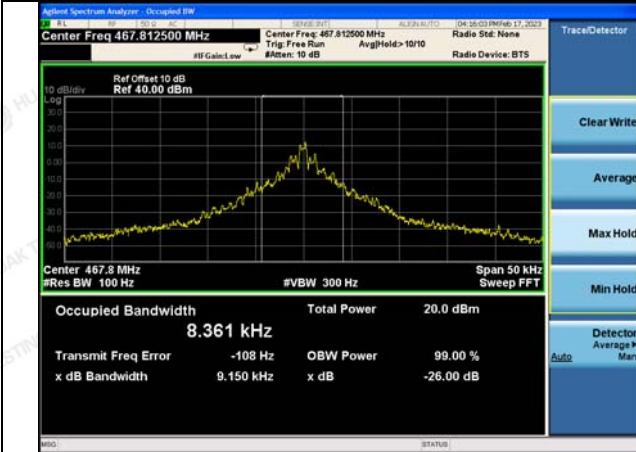

CH2

CH2

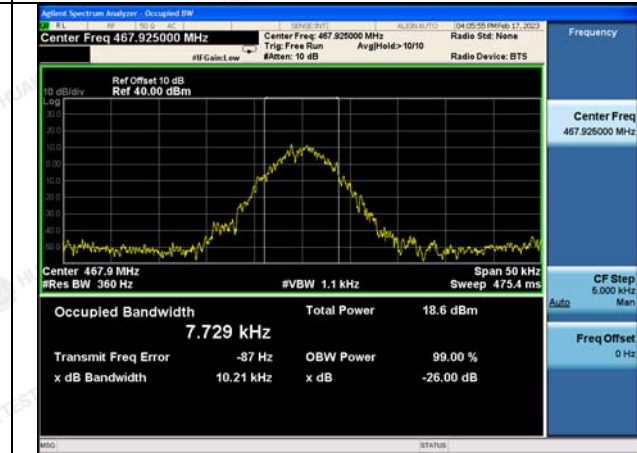
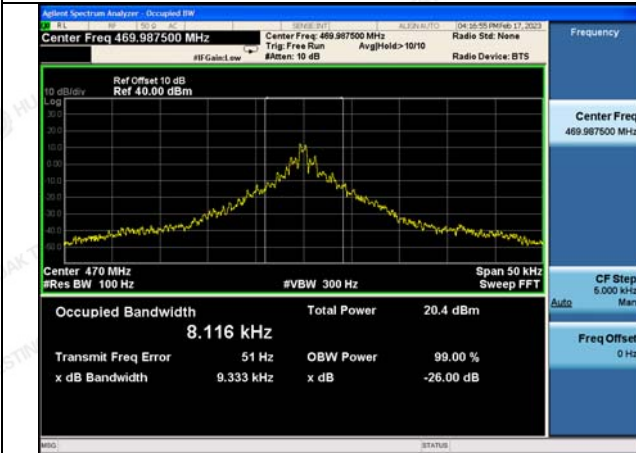

CH3

CH3

The results shown in this test report refer only to the sample(s) tested unless otherwise stated and the sample(s) are retained for 30 days only. The document is issued by HUAJ, this document cannot be reproduced except in full with our prior written permission. The more details and the authenticity of the report will be confirmed at <http://www.cer-mark.com>.

TEL : +86-755 2302 9901 FAX : +86-755 2302 9901 E-mail : service@cer-mark.com

Add: 1-2F., Building B2, Junfeng Zhongcheng Zhizao Innovation Park, Heping Community, Fuhai Street, Bao'an District, Shenzhen, Guangdong, China



FM Modulation

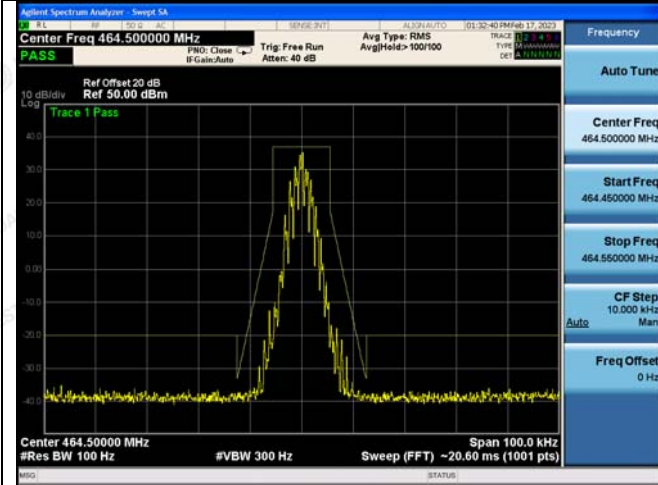

4FSK Modulation

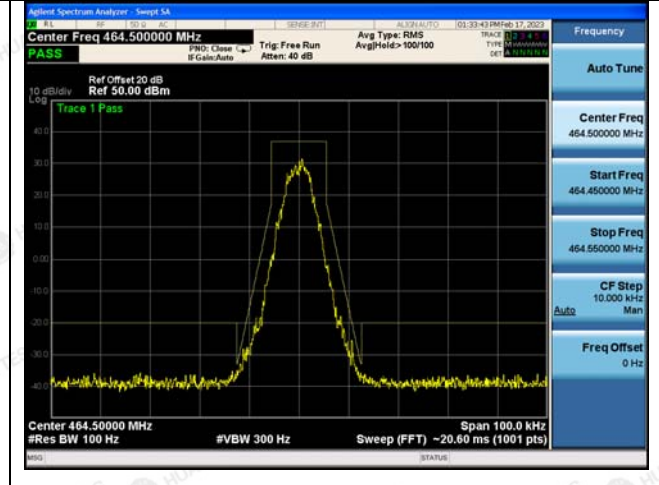

CH1

CH1

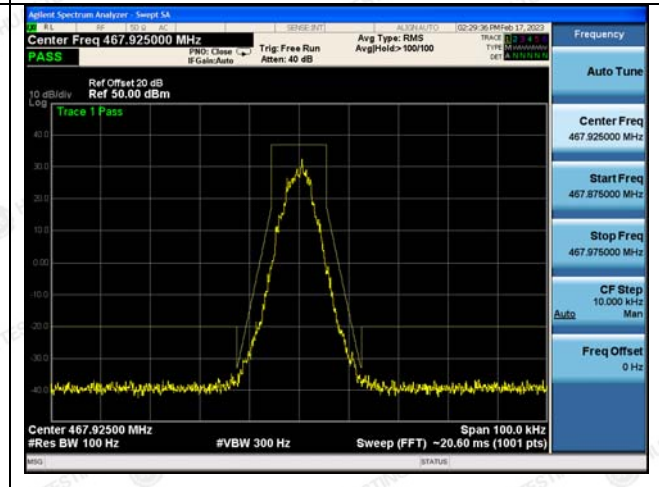
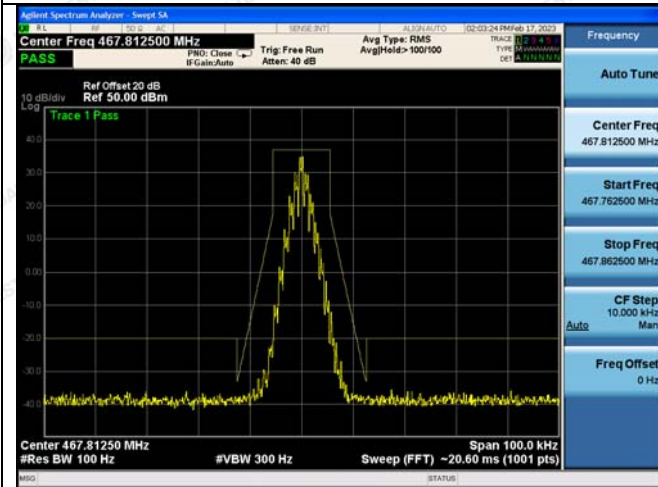

CH2

CH2

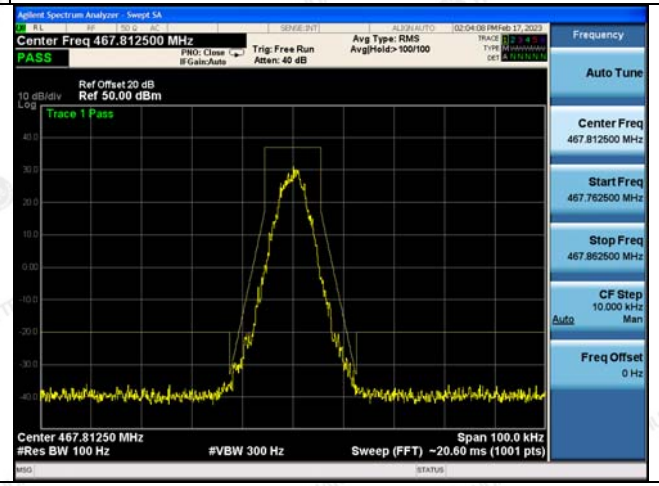
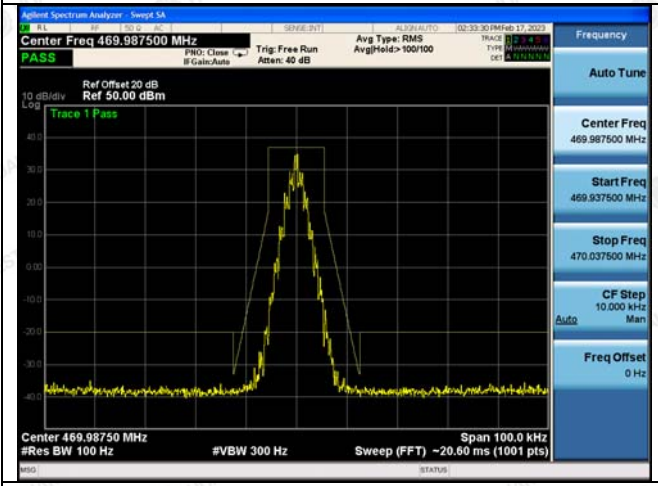

CH3

CH3

The results shown in this test report refer only to the sample(s) tested unless otherwise stated and the sample(s) are retained for 30 days only. The document is issued by HUAJ, this document cannot be reproduced except in full with our prior written permission. The more details and the authenticity of the report will be confirmed at <http://www.cer-mark.com>.

TEL : +86-755 2302 9901 FAX : +86-755 2302 9901 E-mail : service@cer-mark.com

Add: 1-2F., Building B2, Junfeng Zhongcheng Zhizao Innovation Park, Heping Community, Fuhai Street, Bao'an District, Shenzhen, Guangdong, China



3.3 Modulation Characteristic

TEST APPLICABLE

According to CFR47 section 2.1047(a), for Voice Modulation Communication Equipment, the frequency response of the audio modulation circuit over a range of 100 to 5000Hz shall be measured.

TEST PROCEDURE

Modulation Limit

- 1 Configure the EUT as shown in figure 1, adjust the audio input for 60% of rated system deviation at 1 KHz using this level as a reference (0dB) and vary the input level from -20 to +20dB. Record the frequency deviation obtained as a function of the input level.
- 2 Repeat step 1 with input frequency changing to 300, 1004, 1500 and 2500Hz in sequence.

Audio Frequency Response

- 1 Configure the EUT as shown in figure 1.
- 2 Adjust the audio input for 20% of rated system deviation at 1 KHz using this level as a reference (0dB).
- 3 Vary the Audio frequency from 100 Hz to 3 KHz and record the frequency deviation.
- 4 Audio Frequency Response = $20 \log_{10} (\text{Deviation of test frequency} / \text{Deviation of 1 KHz reference})$.

TEST CONFIGURATION

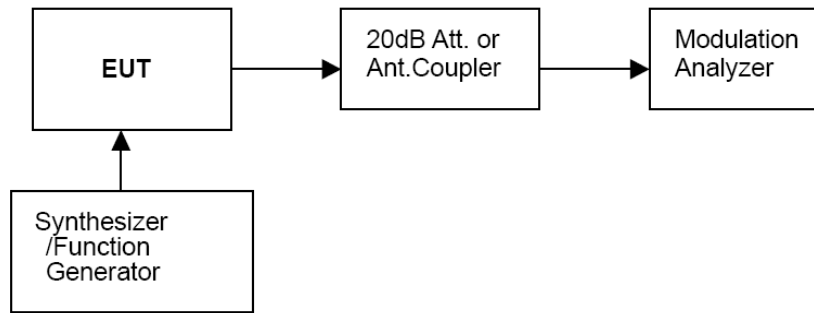

TEST RESULTS

Modulation Limit(FM):

12.5 KHz Channel Separations

Modulation Level(dB)	Peak Freq. Deviation At 300 Hz(KHz)	Peak Freq. Deviation At 1004 Hz(KHz)	Peak Freq. Deviation At 1500 Hz(KHz)	Peak Freq. Deviation At 2500 Hz(KHz)
-20	0.098	0.285	0.572	0.653
-15	0.124	0.374	0.645	0.498
-10	0.235	0.578	0.757	1.924
-5	0.354	0.776	1.586	1.773
0	0.475	1.222	1.504	2.046
+5	0.525	1.274	1.471	2.057
+10	0.633	1.574	1.723	2.149
+15	0.975	1.752	2.005	2.221
+20	1.362	1.855	2.147	2.293

The results shown in this test report refer only to the sample(s) tested unless otherwise stated and the sample(s) are retained for 30 days only. The document is issued by HUAK, this document cannot be reproduced except in full with our prior written permission. The more details and the authenticity of the report will be confirmed at <http://www.cer-mark.com>.



Modulation Limit for 12.5 KHz

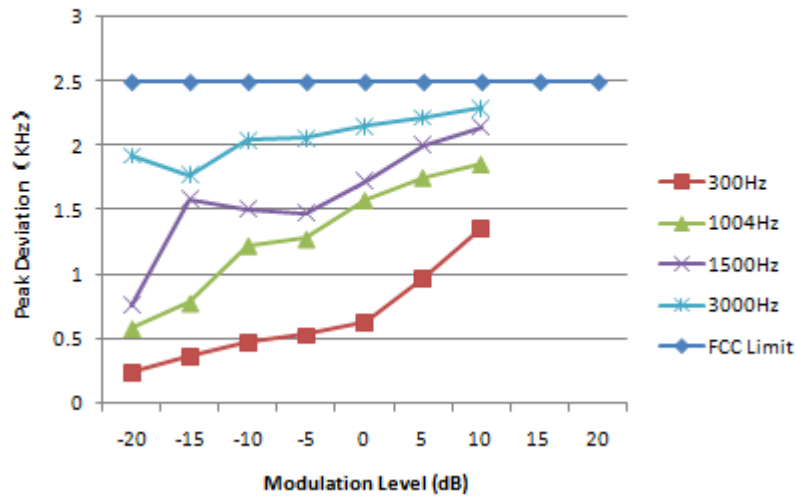

Audio Frequency Response(FM):

12.5 KHz Channel Separation

Frequency (KHz)	Frequency Deviation (KHz)	1KHz Reference Deviation (KHz)	Audio Frequency Response (dB)
0.1	0.05	0.60	-21.52
0.2	0.05	0.60	-21.53
0.3	0.09	0.60	-16.41
0.4	0.11	0.60	-14.65
0.5	0.21	0.60	-9.08
0.6	0.27	0.60	-6.93
0.7	0.37	0.60	-4.27
0.8	0.41	0.60	-3.36
0.9	0.55	0.60	-0.71
1.0	0.60	0.60	0.01
1.2	0.70	0.60	1.32
1.4	0.73	0.60	1.69
1.6	0.85	0.60	3.03
1.8	0.91	0.60	3.62
2.0	1.03	0.60	4.65
2.2	1.10	0.60	5.26
2.4	1.22	0.60	6.14
2.6	1.25	0.60	6.38
2.7	1.38	0.60	7.28
2.8	1.42	0.60	7.48
3.0	1.50	0.60	7.97
3.5	0.05	0.60	-21.58
4.0	0.04	0.60	-23.54
4.5	0.04	0.60	-23.52
5.0	0.05	0.60	-21.53

The results shown in this test report refer only to the sample(s) tested unless otherwise stated and the sample(s) are retained for 30 days only. The document is issued by HUAK, this document cannot be reproduced except in full with our prior written permission. The more details and the authenticity of the report will be confirmed at <http://www.cer-mark.com>.

TEL : +86-755 2302 9901 FAX : +86-755 2302 9901 E-mail : service@cer-mark.com

Add: 1-2F., Building B2, Junfeng Zhongcheng Zhizao Innovation Park, Heping Community, Fuhai Street, Bao'an District, Shenzhen, Guangdong, China

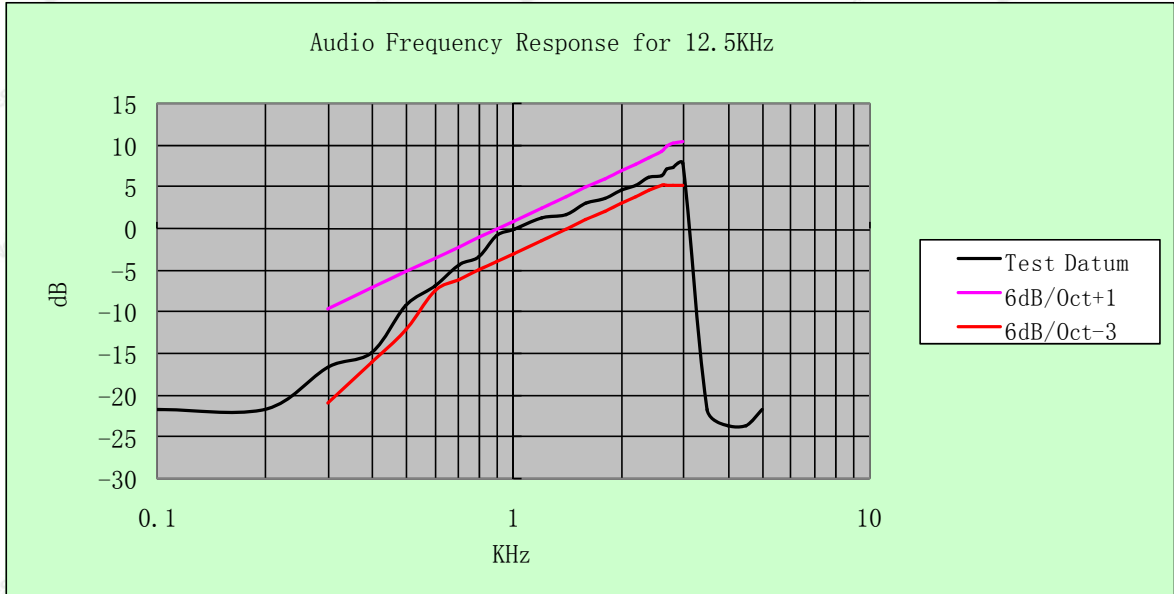

The results shown in this test report refer only to the sample(s) tested unless otherwise stated and the sample(s) are retained for 30 days only. The document is issued by HUAK, this document cannot be reproduced except in full with our prior written permission. The more details and the authenticity of the report will be confirmed at <http://www.cer-mark.com>.

TEL : +86-755 2302 9901 FAX : +86-755 2302 9901 E-mail : service@cer-mark.com

Addr: 1-2F., Building B2, Junfeng Zhongcheng Zhizao Innovation Park, Heping Community, Fuhai Street, Bao'an District, Shenzhen, Guangdong, China

3.4 Frequency Stability

LIMITS

According to 90.213, Transmitters used must have minimum frequency stability as specified in the following table.

Frequency Range (MHz)	Channel Bandwidth (KHz)	Frequency Tolerance (ppm)		
		Fixed and Base Stations	Mobile Stations	
			> 2 W	≤ 2 W
150-174 MHz	6.25	1.0	2.0	2.0
	12.5	2.5	5.0	5.0
	25	5.0	5.0	50.0*
421-512 MHz	6.25	0.5	1.0	1.0
	12.5	1.5	2.5	2.5
	25	2.5	5.0	5.0

- Stations operating in the 154.45 to 154.49 MHz or the 173.2 to 173.4 MHz bands must have a frequency stability of 5 ppm.
- Paging transmitters operating on paging-only frequencies must operate with frequency stability of 5 ppm in the 150-174 MHz band and 2.5 ppm in the 421-512 MHz band.

TEST CONFIGURATION

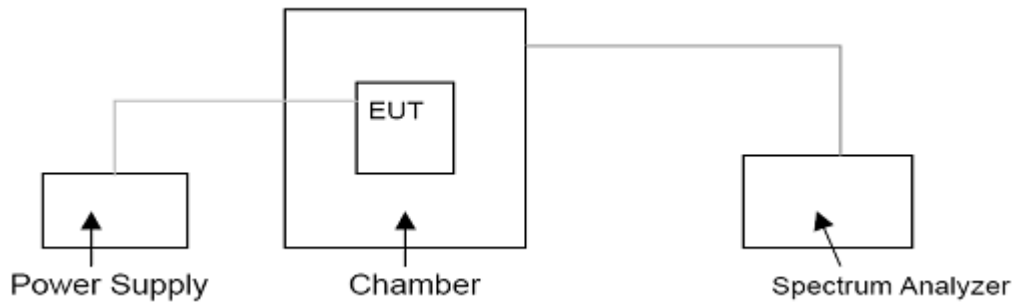

TEST PROCEDURE

The EUT was set in the climate chamber and connected to an external DC power supply. The RF output was directly connected to Spectrum Analyzer. The coupling loss of the additional cables was recorded and taken in account for all the measurements. After temperature stabilization (approx. 20 min for each stage), the frequency for the lower, the middle and the highest frequency range was recorded. For Frequency stability Vs. Voltage the EUT was connected to a DC power supply and the voltage was adjusted in the required ranges. The result was recorded.



Test conditions		Frequency error (ppm)			Limit (ppm)	Result
Voltage(V)	Temp(°C)	464.5	467.8125	469.9875		
7.40	-30	0.76	0.99	0.84	2.5	Pass
	-20	0.34	0.51	0.96		
	-10	0.36	0.64	0.79		
	0	0.45	0.57	0.43		
	10	0.86	0.83	0.34		
	20	0.63	0.26	0.20		
	30	0.57	0.51	0.40		
	40	0.31	0.37	0.70		
	50	0.17	0.63	0.78		
6.29 (85% Rated)	20	0.23	0.71	0.99		
8.51(115% Rated)	20	0.21	0.32	0.58		

4FSK:

Test conditions		Frequency error (ppm)			Limit (ppm)	Result
Voltage(V)	Temp(°C)	464.5	467.8125	467.925		
7.40	-30	0.68	0.85	0.83	2.5	Pass
	-20	0.23	0.39	0.87		
	-10	0.30	0.47	0.76		
	0	0.42	0.54	0.35		
	10	0.67	0.71	0.25		
	20	0.53	0.20	0.19		
	30	0.52	0.43	0.26		
	40	0.12	0.25	0.63		
	50	0.24	0.68	0.75		
6.29 (85% Rated)	20	0.32	0.76	1.07		
8.51(115% Rated)	20	0.11	0.34	0.51		



3.5 Transmitter Frequency Behavior

TEST APPLICABLE

Section 90.214

Transient frequencies must be within the maximum frequency difference limits during the time intervals indicated:

Time intervals ^{1, 2}	Maximum frequency difference ³	All equipment	
		150 to 174 MHz	421 to 512MHz
Transient Frequency Behavior for Equipment Designed to Operate on 25 KHz Channels			
t ₁ ⁴	± 25.0 KHz	5.0 ms	10.0 ms
t ₂	± 12.5 KHz	20.0 ms	25.0 ms
t ₃ ⁴	± 25.0 KHz	5.0 ms	10.0 ms
Transient Frequency Behavior for Equipment Designed to Operate on 12.5 KHz Channels			
t ₁ ⁴	± 12.5 KHz	5.0 ms	10.0 ms
t ₂	± 6.25 KHz	20.0 ms	25.0 ms
t ₃ ⁴	± 12.5 KHz	5.0 ms	10.0 ms
Transient Frequency Behavior for Equipment Designed to Operate on 6.25 KHz Channels			
t ₁ ⁴	±6.25 KHz	5.0 ms	10.0 ms
t ₂	±3.125 KHz	20.0 ms	25.0 ms
t ₃ ⁴	±6.25 KHz	5.0 ms	10.0 ms

- t_{on} is the instant when a 1 KHz test signal is completely suppressed, including any capture time due to phasing.
t₁ is the time period immediately following t_{on}.
t₂ is the time period immediately following t₁.
t₃ is the time period from the instant when the transmitter is turned off until t_{off}.
t_{off} is the instant when the 1 KHz test signal starts to rise.
- During the time from the end of t₂ to the beginning of t₃, the frequency difference must not exceed the limits specified in § 90.213.
- Difference between the actual transmitter frequency and the assigned transmitter frequency.
- If the transmitter carrier output power rating is 6 watts or less, the frequency difference during this time period may exceed the maximum frequency difference for this time period.

TEST CONFIGURATION

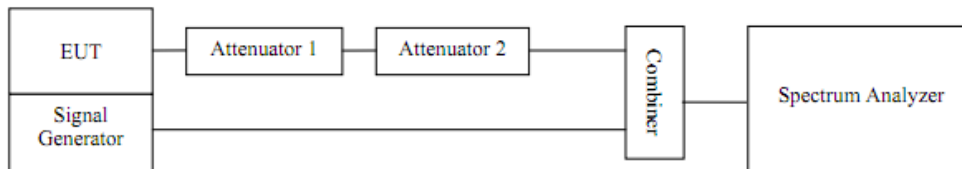

TEST PROCEDURE

- Connect the EUT and test equipment as shown in the test configuration.
- Set Spectrum Analyzer to measure FM deviation, and tune the RF frequency to transmitter assigned frequency.
- Set the signal generator to the assigned transmitter frequency and modulate it with a 1KHz tone at ± 12.5Khz deviation and set its output level to -100dBm.
- Turn on the transmitter.
- Supply sufficient attenuation via RF attenuator to provide an input level to the Spectrum Analyzer that is 40dB below the maximum allowed input power when the transmitter is operating at its rated power level. Note this power level on Spectrum Analyzer as P₀.
- Turn off the transmitter.
- Adjust the RF level of the signal generator to provide RF power equal to P₀. This signal generator RF level shall be maintained throughout the rest of the measurement.
- Remove the attenuation 1, so the input power to the Spectrum Analyzer is increased by 30dB when the transmitter is turned on.
- Adjust the vertical amplitude control of the spectrum analyzer to display the 1000Hz at ±4 divisions vertically centered on display. Set trigger mode of the Spectrum Analyzer to "Video", and tune the "trigger level" on suitable level. Then set the "trigger offset" to -10ms for turn on and -15ms for turn off.



- 10. Turn on the transmitter and the transient wave will be captured on the screen of Spectrum Analyzer. Observe the stored display. The instant when the 1 KHz test signal is completely suppressed is considered to be t_{on} . The trace should be maintained within the allowed divisions during the period t_1 and t_2 .
- 11. Then turn off the transmitter, and another transient wave will be captured on the screen of Spectrum Analyzer. The trace should be maintained within the allowed divisions during the period t_3 .

TEST RESULTS

PASS

Note: All modes have been tested,worst result recorded as below:
Modulation Type: FM

Transmitter Frequency Behavior @ 12.5 KHz Channel Separation-----Off – On

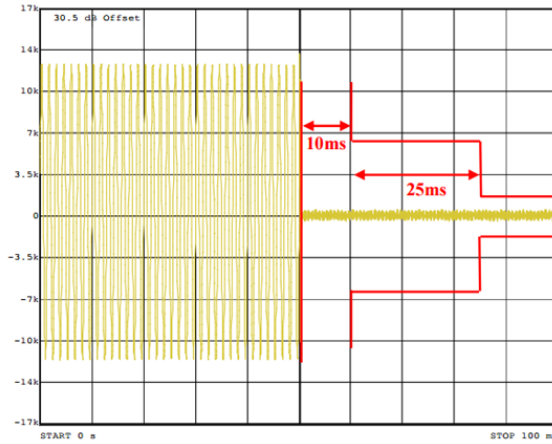

Transmitter Frequency Behavior @ 12.5 KHz Channel Separation-----On – Off

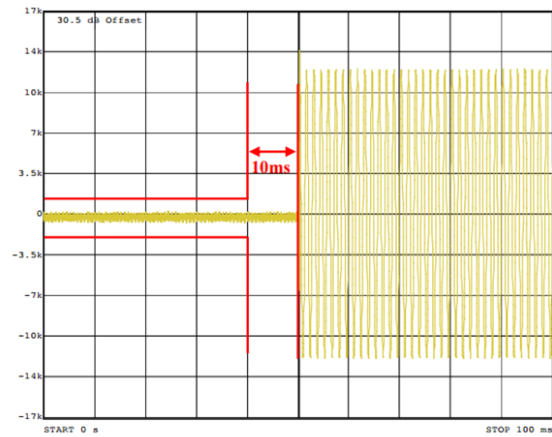

3.6 Transmitter Radiated Spurious Emission

Limit

According to the TIA/EIA 603 test method, and according to Section 90.210, the power of each unwanted emission shall be less than Transmitted Power as specified below for transmitters designed to operate with 12.5 KHz channel bandwidth:

- 1 On any frequency removed from the center of the authorized bandwidth f_0 to 5.625 KHz removed from f_0 : Zero dB
- 2 On any frequency removed from the center of the authorized bandwidth by a displacement frequency (f_d in KHz) f_0 of more than 5.625 KHz but no more than 12.5 KHz: At least 7.27dB
- 3 On any frequency removed from the center of the authorized bandwidth by a displacement frequency (f_d in KHz) f_0 of more than 12.5 KHz: At least $50+10 \log (P)$ dB or 70 dB, whichever is lesser attenuation.

TEST CONFIGURATION

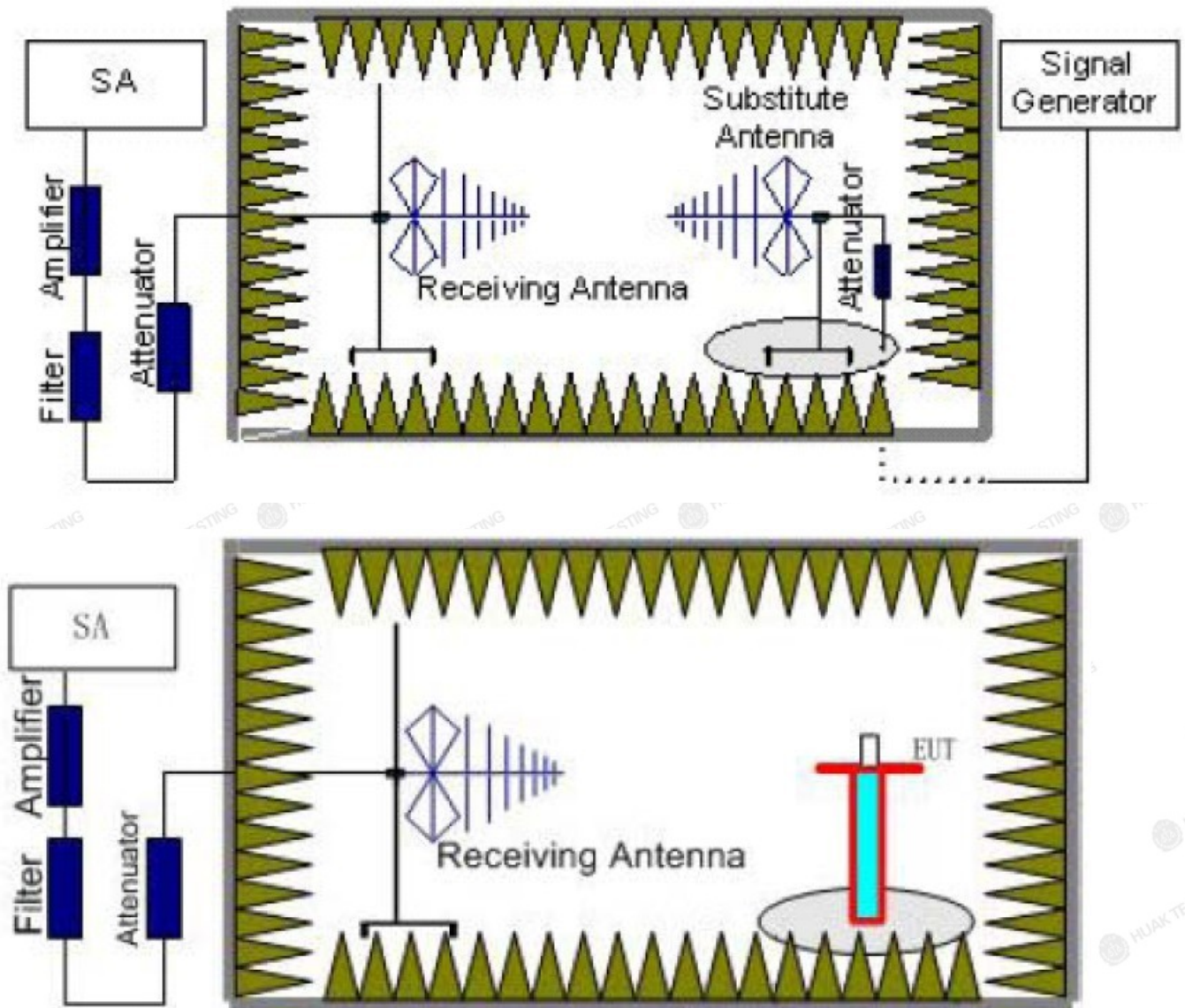



- a. EUT was placed on a 0.8 meter high non-conductive stand at a 3 meter test distance from the receive antenna. A receiving antenna was placed on the antenna mast 3 meters from the EUT for emission measurements. The height of receiving antenna is 1.0m. Detected emissions were maximized at each frequency by rotating the EUT through 360° and adjusting the receiving antenna polarization. The radiated emission measurements of all test transmit frequencies were measured with peak detector.
- b. A log-periodic antenna or double-ridged waveguide horn antenna shall be substituted in place of the EUT. The log-periodic antenna will be driven by a signal generator and the level will be adjusted till the same power value on the spectrum analyzer or receiver. The level of the spurious emissions can be calculated through the level of the signal generator, cable loss, the gain of the substitution antenna and the reading of the spectrum analyzer or receiver.
- c. The EUT is then put into continuously transmitting mode at its maximum power level during the test. Set Test Receiver or Spectrum 100 kHz below 1GHz and 1MHz above 1GHz, Sweep from 30MHz to the 10th harmonic of the fundamental frequency; and recorded the level of the concerned spurious emission point as (P_r).
- d. The EUT then replaced by a substitution antenna. In the chamber, an substitution antenna for the frequency band of interest is placed at the reference point of the chamber. An RF Signal source for the frequency band of interest is connected to the substitution antenna with a cable that has been constructed to not interfere with the radiation pattern of the antenna. A power (P_{Mea}) is applied to the input of the substitution antenna, and adjust the level of the signal generator output until the value of the receiver reach the previously recorded (P_r). The power of signal source (P_{Mea}) is recorded. The test should be performed by rotating the test item and adjusting the receiving antenna polarization. The measurement results are obtained as described below:

$$\text{Power}_{(EIRP)} = P_{Mea} - P_{cl} + G_a$$

Where;

- P_{Mea} is the recorded signal generator level
- P_{cl} is the cable loss connect between instruments
- G_a Substitution Antenna Gain

- e. This value is EIRP since the measurement is calibrated using an antenna of known gain (2.15 dBi) and known input power.
- f. ERP can be calculated from EIRP by subtracting the gain of the dipole, $ERP = EIRP - 2.15\text{dBi}$.
- g. Test site anechoic chamber refer to ANSI C63.



Remark: The measurement frequency range is from 30MHz to the 10th harmonic of the fundamental frequency; and worst spurious emissions recorded as below:

Test Frequency (MHz)	Frequency (MHz)	P _{Mea} (dBm)	P _{cl} (dB)	Distance (m)	G _a Antenna Gain(dBi)	Peak EIRP (dBm)	Limit (dBm)	Margin (dB)	Pol.
464.5	342.984	-74.59	3.54	3	12.87	-65.26	-20	45.26	V
	929.175	-57.94	4.21	3	15.48	-46.67	-20	26.67	V
	1858.00	-65.01	4.52	3	17.32	-52.21	-20	32.21	V
	2322.5	-58.42	5.24	3	18.76	-44.9	-20	24.9	V
	--	--	--	--	--	--	--	--	--
467.8125	110.720	-74.69	3.88	3	12.98	-65.59	-20	45.59	V
	346.477	-68.03	4.35	3	15.51	-56.87	-20	36.87	V
	1403.4375	-64.92	4.76	3	17.44	-52.24	-20	32.24	V
	2339.0625	-68.49	5.68	3	18.84	-55.33	-20	35.33	V
	--	--	--	--	--	--	--	--	--
469.9875	151.274	-74.73	3.95	3	13.11	-65.57	-20	45.57	V
	939.675	-58.10	4.55	3	15.65	-47	-20	27	V
	1879.95	-64.98	4.79	3	17.58	-52.19	-20	32.19	V
	2349.938	-68.67	5.84	3	18.92	-55.59	-20	35.59	V
	--	--	--	--	--	--	--	--	--

Remark:

1. $EIRP = P_{Mea}(dBm) - P_{cl}(dB) + G_a(dBi)$
2. -- Means other points for values lower than limits and not recorded.
3. $Margin = Limit - EIRP$



3.7 Spurious Emission on Antenna Port

Limit

-20 dBm

TEST CONFIGURATION

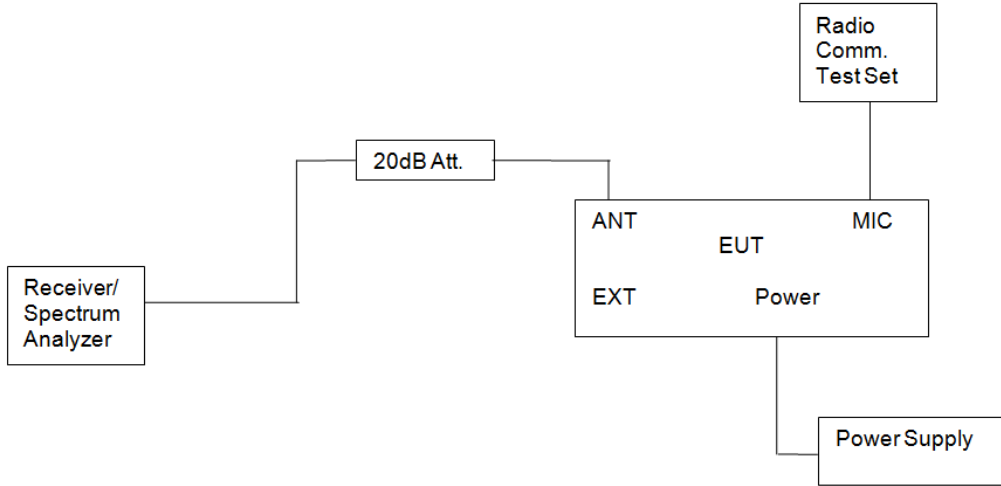

TEST PROCEDURE

The RF output of the EUT was connected to a spectrum analyzer through appropriate attenuation. The resolution bandwidth of the spectrum analyzer was set to 10 kHz/1MHz. Sufficient scans were taken to show any out of band emission up to 10th. Harmonic for the lower and the highest frequency range. Set RBW 10 kHz, VBW 30 kHz in the frequency band 30MHz to 1GHz, while set RBW=1MHz. VBW=3MHz from the 1GHz to 10th Harmonic.

TEST RESULTS

PASS

Note: All modes have been tested, worst spurious emissions recorded as below:



FM

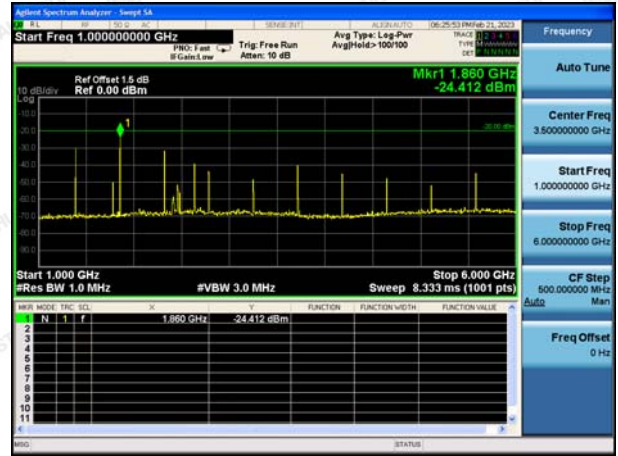
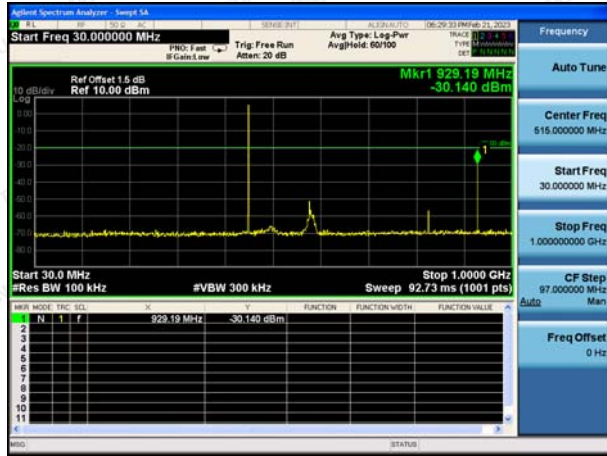

CH1

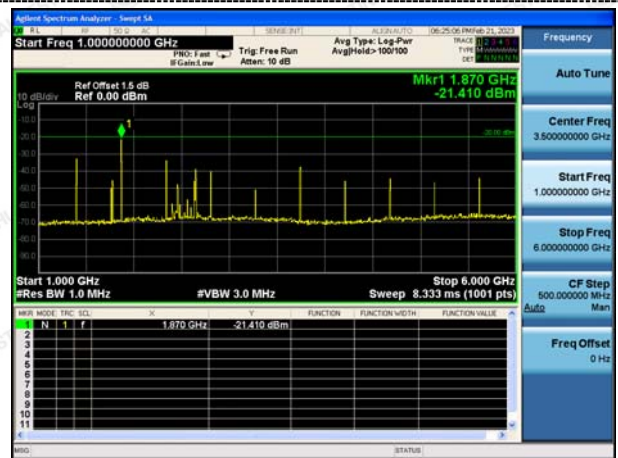
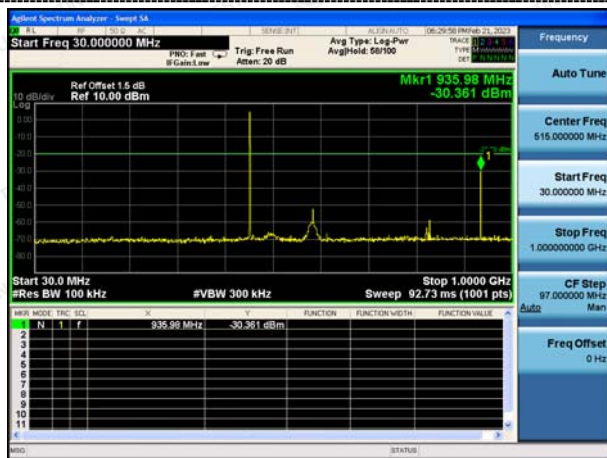

CH2

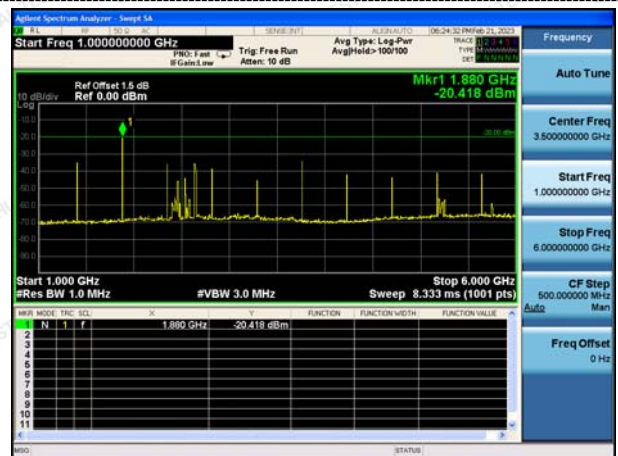
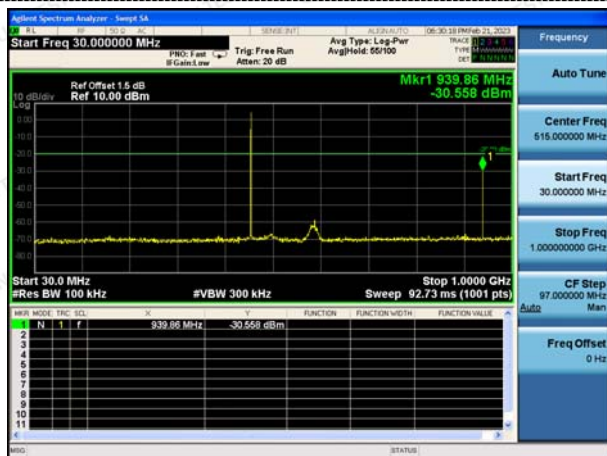

CH3

The results shown in this test report refer only to the sample(s) tested unless otherwise stated and the sample(s) are retained for 30 days only. The document is issued by HUAJ, this document cannot be reproduced except in full with our prior written permission. The more details and the authenticity of the report will be confirmed at <http://www.cer-mark.com>.

TEL : +86-755 2302 9901 FAX : +86-755 2302 9901 E-mail : service@cer-mark.com

Add: 1-2F., Building B2, Junfeng Zhongcheng Zhizao Innovation Park, Heping Community, Fuhai Street, Bao'an District, Shenzhen, Guangdong, China



4 Test Setup Photos of the EUT

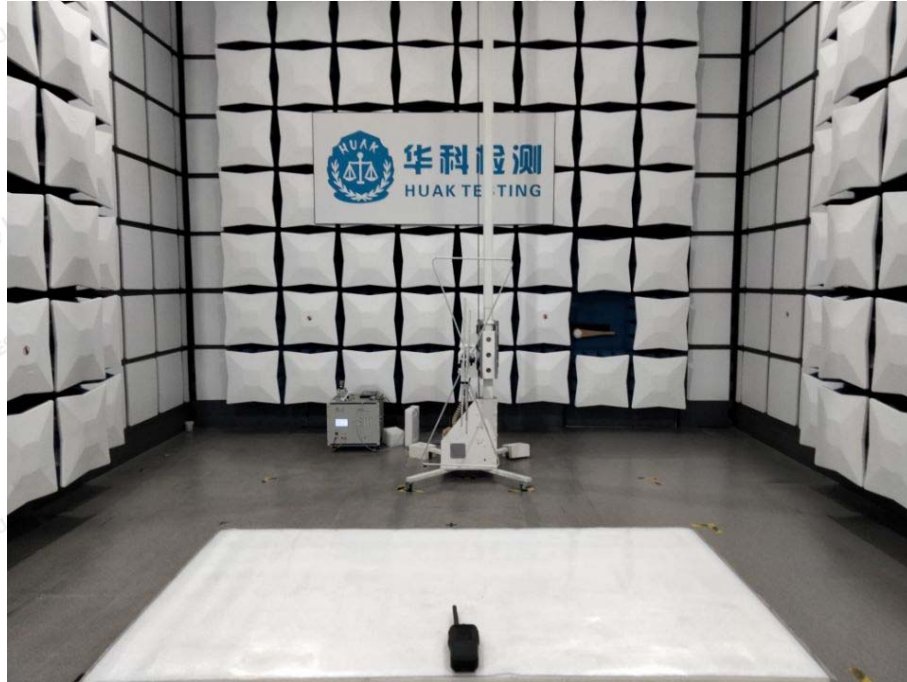

The results shown in this test report refer only to the sample(s) tested unless otherwise stated and the sample(s) are retained for 30 days only. The document is issued by HUAK, this document cannot be reproduced except in full with our prior written permission. The more details and the authenticity of the report will be confirmed at <http://www.cer-mark.com>.

TEL : +86-755 2302 9901 FAX : +86-755 2302 9901 E-mail : service@cer-mark.com

Addr: 1-2F., Building B2, Junfeng Zhongcheng Zhizao Innovation Park, Heping Community, Fuhai Street, Bao'an District, Shenzhen, Guangdong, China



5 Photos of the EUT

Reference to the report: ANNEX A of external photos and ANNEX B of internal photos.

***** **End of Report** *****