



SAR TEST REPORT

For

Shenzhen Forwell Electronics Technology Co., Ltd.

Laptop

Test Model: F152A

Additional Model No.: N/A

Prepared for : Shenzhen Forwell Electronics Technology Co., Ltd.
Address : 2nd Floor, Building A, Shatang Beifangyongfa Science and Technology Park, Jincheng Rd., Shajing, Baoan, Shenzhen, Guangdong, China

Prepared by : Shenzhen LCS Compliance Testing Laboratory Ltd.
Address : 101, 201 Bldg A & 301 Bldg C, Juji Industrial Park Yabianxueziwei, Shajing Street, Baoan District, Shenzhen, 518000, China

Date of receipt of test sample : Dec 07, 2023
Number of tested samples : 1
Sample No. : A231211063
Serial number : Prototype
Date of Test : Dec 07, 2023~ Dec 08, 2023
Date of Report : Dec 12, 2023





SAR TEST REPORT

Report Reference No. : LCSA12113121E

Date Of Issue : Dec 12, 2023

Testing Laboratory Name : Shenzhen LCS Compliance Testing Laboratory Ltd.

**Address : 101, 201 Bldg A & 301 Bldg C, Juji Industrial Park
Yabianxueziwei, Shajing Street, Baoan District, Shenzhen,
518000, China**

**Testing Location/ Procedure..... : Full application of Harmonised standards
Partial application of Harmonised standards
Other standard testing method**

Applicant's Name..... : Shenzhen Forwell Electronics Technology Co., Ltd.

**Address : 2nd Floor,Building A,Shatang Beifangyongfa Science and
Technology Park,Jincheng
Rd.,Shajing,Baoan,Shenzhen,Guangdong,China**

Test Specification:

Standard : IEEE Std C95.1, 2019& IEEE Std 1528™-2013&FCC Part 2.1093

Test Report Form No. : LCSEMC-1.0

TRF Originator : Shenzhen LCS Compliance Testing Laboratory Ltd.

Master TRF..... : Dated 2011-03

Shenzhen LCS Compliance Testing Laboratory Ltd. All rights reserved.

This publication may be reproduced in whole or in part for non-commercial purposes as long as the Shenzhen LCS Compliance Testing Laboratory Ltd. is acknowledged as copyright owner and source of the material. Shenzhen LCS Compliance Testing Laboratory Ltd. takes no responsibility for and will not assume liability for damages resulting from the reader's interpretation of the reproduced material due to its placement and context.

Test Item Description. : Laptop

Trade Mark : /

Test Model : F152A

**Operation Frequency : WLAN2.4G, WLAN5.2G, WLAN5.8G
Bluetooth4.1**

Rated Voltage: 7.74V

**Ratings : Charge Limit Voltage: 8.9V
Capacity: 5800mAh/44.892Wh**

Result : Positive

Compiled by:

Jay zhan

Supervised by:

Cary Luo

Approved by:

Gavin Liang

Jay Zhan/ File administrators

Cary Luo / Technique principal

Gavin Liang / Manager





SAR -- TEST REPORT

Test Report No. : LCSA12113121E	<u>June 01, 2023</u> Date of issue
--	---------------------------------------

Type / Model.....	: F152A
EUT.....	: Laptop
Applicant.....	: Shenzhen Forwell Electronics Technology Co., Ltd.
Address.....	: 2nd Floor,Building A,Shatang Beifangyongfa Science and Technology Park,Jincheng Rd.,Shajing,Baoan,Shenzhen,Guangdong,China
Telephone.....	: /
Fax.....	: /
Manufacturer.....	: Shenzhen Forwell Electronics Technology Co., Ltd.
Address.....	: 2nd Floor,Building A,Shatang Beifangyongfa Science and Technology Park,Jincheng Rd.,Shajing,Baoan,Shenzhen,Guangdong,China
Telephone.....	: /
Fax.....	: /
Factory.....	: Shenzhen Forwell Electronics Technology Co., Ltd.
Address.....	: 2nd Floor,Building A,Shatang Beifangyongfa Science and Technology Park,Jincheng Rd.,Shajing,Baoan,Shenzhen,Guangdong,China
Telephone.....	: /
Fax.....	: /
Test Result	
Positive	

The test report merely corresponds to the test sample.
It is not permitted to copy extracts of these test result without the written permission of the test laboratory.





Revision History

Revision	Issue Date	Revision Content	Revised By
000	Dec 12, 2023	Initial Issue	---





TABLE OF CONTENTS

- 1. TEST STANDARDS AND TEST DESCRIPTION.....6**
 - 1.1. TEST STANDARDS6
 - 1.2. TEST DESCRIPTION6
 - 1.3. GENERAL REMARKS6
 - 1.4. PRODUCT DESCRIPTION6
 - 1.5. STATEMENT OF COMPLIANCE8
- 2. TEST ENVIRONMENT9**
 - 2.1. TEST FACILITY.....9
 - 2.2. ENVIRONMENTAL CONDITIONS9
 - 2.3. SAR LIMITS9
 - 2.4. EQUIPMENTS USED DURING THE TEST10
- 3. SAR MEASUREMENTS SYSTEM CONFIGURATION11**
 - 3.1. SAR MEASUREMENT SET-UP.....11
 - 3.2. OPENSAR E-FIELD PROBE SYSTEM.....12
 - 3.3. PHANTOMS.....13
 - 3.4. DEVICE HOLDER13
 - 3.5. SCANNING PROCEDURE14
 - 3.6. TISSUE DIELECTRIC PARAMETERS FOR HEAD AND BODY PHANTOMS16
 - 3.7. TISSUE EQUIVALENT LIQUID PROPERTIES16
 - 3.8. SYSTEM CHECK17
 - 3.9. SAR MEASUREMENT PROCEDURE19
 - 3.10. POWER REDUCTION21
 - 3.11. POWER DRIFT21
- 4. TEST CONDITIONS AND RESULTS.....22**
 - 4.1. CONDUCTED POWER RESULTS22
 - 4.2. TRANSMIT ANTENNAS AND SAR MEASUREMENT POSITION.....25
 - 4.3. SAR MEASUREMENT RESULTS26
 - 4.4. SAR MEASUREMENT VARIABILITY30
 - 4.5. GENERAL DESCRIPTION OF TEST PROCEDURES30
 - 4.6. MEASUREMENT UNCERTAINTY (450MHZ-6GHZ).....31
 - 4.7. SYSTEM CHECK RESULTS32
 - 4.8. SAR TEST GRAPH RESULTS.....35
- 5. CALIBRATION CERTIFICATES41**
 - 5.1. PROBE-EPGO376 CALIBRATION CERTIFICATE.....41
 - 5.2. SID2450 DIPOLE CALIBRATION CERITICATE.....52
 - 5.3. SID5-6G DIPOLE CALIBRATION CERITICATE.....64
- 6.EUT TEST PHOTOGRAPHS77**
 - 6.1 PHOTOGRAPH OF LIQUID DEPTH.....77
- 7.SETUP PHOTOGRAPHS79**
- 8.EUT PHOTOGRAPHS80**





1. TEST STANDARDS AND TEST DESCRIPTION

1.1. Test Standards

- [IEEE Std C95.1, 2019](#): IEEE Standard for Safety Levels with Respect to Human Exposure to Electric, Magnetic, and Electromagnetic Fields, 0 Hz to 300 GHz. It specifies the maximum exposure limit of 1.6 W/kg as averaged over any 1 gram of tissue for portable devices being used within 20 cm of the user in the uncontrolled environment.
- [IEEE Std 1528™-2013](#): Measurement procedure for the assessment of specific absorption rate of human exposure to radio frequency fields from hand-held and body-mounted wireless communication devices –Part 1528: Human models, instrumentation, and procedures (Frequency range of 4 MHz to 10 GHz)
- [FCC Part 2.1093](#): Radiofrequency Radiation Exposure Evaluation: Portable Devices
- [KDB447498 D01 General RF Exposure Guidance](#) : Mobile and Portable Device RF Exposure Procedures and Equipment Authorization Policies
- [KDB865664 D01 SAR Measurement 100 MHz to 6 GHz](#) : SAR Measurement Requirements for 100 MHz to 6 GHz
- [KDB865664 D02 RF Exposure Reporting](#): RF Exposure Compliance Reporting and Documentation Considerations
- [KDB 616217 D04 SAR for laptop and tablets v01r02](#): SAR Evaluation procedures for umpc mini-tablet devices
- [KDB248227 D01 802.11 Wi-Fi SAR](#): SAR GUIDANCE FOR IEEE 802.11 (Wi-Fi) TRANSMITTERS

1.2. Test Description

The EUT battery must be fully charged and checked periodically during the test to ascertain uniform power . And Test device is identical prototype.

1.3. General Remarks

Date of receipt of test sample	:	Dec 07, 2023
Testing commenced on	:	Dec 07, 2023
Testing concluded on	:	Dec 08, 2023

1.4. Product Description

The **Shenzhen Forwell Electronics Technology Co., Ltd.**'s Model:**F152A** or the "EUT" as referred to in this report; more general information as follows, for more details, refer to the user's manual of the EUT.

General Description	
Product Name:	Laptop
Model/Type reference:	F152A
Additional Model No.:	F130A, F140A, F141A, F146G, F156A, F160A, Y140A, Y156A, X140A, X156A
Model Declaration:	Only the name is different
Hardware Version:	/
Software Version:	/
Power supply:	ated Voltage: 7.74V Charge Limit Voltage: 8.9V Capacity: 5800mAh/44.892Wh
<i>The EUT is Laptop. It is equipped with Bluetooth, WiFi2.4G, WiFi5.2G, WiFi5.8G camera functions. For more information see the following datasheet,</i>	
Technical Characteristics	
WIFI 2.4G	
Frequency Range:	2412MHz ~ 2462 MHz
Channel Spacing:	5MHz
Channel Number:	11 Channels for 20MHz bandwidth (2412~2462MHz) 7 Channels for 40MHz bandwidth (2422~2452MHz)
Modulation Type:	IEEE 802.11b: DSSS (CCK, DQPSK, DBPSK) IEEE 802.11g: OFDM (64QAM, 16QAM, QPSK, BPSK) IEEE 802.11n: OFDM (64QAM, 16QAM, QPSK, BPSK)
Antenna Description:	FPC Antenna 1, FPC Antenna 2.





WIFI 5.2G	
Frequency Range	5180MHz-5240MHz
Channel Number	4 Channels for 20MHz bandwidth(5180MHz~5240MHz) 2 channels for 40MHz bandwidth(5190MHz~5230MHz) 1 channels for 80MHz bandwidth(5210MHz)
Modulation Type	IEEE 802.11a: OFDM (64QAM, 16QAM, QPSK, BPSK) IEEE 802.11n: OFDM (64QAM, 16QAM, QPSK, BPSK) IEEE 802.11ac: OFDM (256QAM, 64QAM, 16QAM, QPSK, BPSK)
Antenna Description:	FPC Antenna 1, FPC Antenna 2.
WIFI 5.8G	
Frequency Range	5745MHz-5825MHz
Channel Number	5 channels for 20MHz bandwidth(5745MHz~5825MHz) 2 channels for 40MHz bandwidth(5755MHz~5795MHz) 1 channels for 80MHz bandwidth(5775MHz)
Modulation Type	IEEE 802.11a: OFDM (64QAM, 16QAM, QPSK, BPSK) IEEE 802.11n: OFDM (64QAM, 16QAM, QPSK, BPSK) IEEE 802.11ac: OFDM (256QAM, 64QAM, 16QAM, QPSK, BPSK)
Antenna Description:	FPC Antenna 1, FPC Antenna 2.
Bluetooth	
Bluetooth Version:	V4.1
Modulation:	GFSK, $\pi/4$ -DQPSK, 8-DPSK for Bluetooth V5.0(DSS) GFSK for Bluetooth V4.1 (DTS)
Operation frequency:	2402MHz~2480MHz
Channel number:	79 channels for Bluetooth V4.1 (DSS) 40 channels for Bluetooth V4.1 (DTS)
Channel separation:	1MHz for Bluetooth V4.1 (DSS) 2MHz for Bluetooth V4.1 (DTS)
Antenna Description:	FPC Antenna,





1.5. Statement of Compliance

The maximum of results of SAR found during testing for F152A are follows:

<Highest Reported standalone SAR Summary>

Class Class	Frequency Band	Body-worn (Report SAR _{1-g} (W/kg) Ant1 (Separation Distance 0mm)	Body-worn (Report SAR _{1-g} (W/kg) Ant2 (Separation Distance 0mm)
		DTS	WIFI2.4G
NII	WIFI5.2G	0.084	0.059
	WIFI5.8G	0.114	0.062

This device is in compliance with Specific Absorption Rate (SAR) for general population/uncontrolled exposure limits (1.6 W/kg) specified in IEEE Std C95.1, 2019 and FCC Part 2.1093, and had been tested in accordance with the measurement methods and procedures specified in IEEE Std 1528™-2013.





2. TEST ENVIRONMENT

2.1. Test Facility

The test facility is recognized, certified, or accredited by the following organizations:

Site Description

Sar Lab.

: NVLAP Accreditation Code is 600167-0.
FCC Designation Number is CN5024.
CAB identifier is CN0071.
CNAS Registration Number is L4595.
Test Firm Registration Number: 254912.

2.2. Environmental conditions

During the measurement the environmental conditions were within the listed ranges:

Temperature:	18-25 °C
Humidity:	40-65 %
Atmospheric pressure:	950-1050mbar

2.3. SAR Limits

EXPOSURE LIMITS	FCC Limit (1g Tissue)	
	SAR (W/kg)	
	(General Population / Uncontrolled Exposure Environment)	(Occupational / Controlled Exposure Environment)
Spatial Average(averaged over the whole body)	0.08	0.4
Spatial Peak(averaged over any 1 g of tissue)	1.6	8.0
Spatial Peak(hands/wrists/feet/anklesaveraged over 10 g)	4.0	20.0

Population/Uncontrolled Environments are defined as locations where there is the exposure of individual who have no knowledge or control of their exposure.

Occupational/Controlled Environments are defined as locations where there is exposure that may be incurred by people who are aware of the potential for exposure (i.e. as a result of employment or occupation).



**2.4. Equipments Used during the Test**

Item	Equipment	Manufacturer	Model No.	Serial No.	Cal Date	Due Date
1	PC	Lenovo	G5005	MY42081102	N/A	N/A
2	SAR Measurement system	SATIMO	4014_01	SAR_4014_01	N/A	N/A
4	Signal Generator	Agilent	E4438C	MY49072627	2023-06-09	2024-06-08
5	S-parameter Network Analyzer	Agilent	8753ES	US38432944	2023-06-09	2024-06-08
6	Wideband Radio Communication Tester	R&S	CMW500	103818-1	2023-10-25	2024-10-24
7	E-Field PROBE	MVG	SSE2	SN 25/22 EPGO376	2023-06-22	2024-06-21
8	DIPOLE 2450	SATIMO	SID 2450	SN 07/14 DIP 2G450-306	2021-09-29	2024-09-28
9	DIPOLE 5000-6000	MVG	SWG5500	SN 49/16 WGA 43	2021-09-22	2024-09-21
10	COMOSAR OPENCoaxial Probe	SATIMO	OCPG 68	SN 40/14 OCPG68	2023-10-25	2024-10-24
11	Communication Antenna	SATIMO	ANTA57	SN 39/14 ANTA57	2023-10-25	2024-10-24
12	FEATURE PHONEPOSITIONING DEVICE	SATIMO	MSH98	SN 40/14 MSH98	N/A	N/A
13	DUMMY PROBE	SATIMO	DP60	SN 03/14 DP60	N/A	N/A
14	SAM PHANTOM	SATIMO	SAM117	SN 40/14 SAM117	N/A	N/A
15	Liquid measurement Kit	HP	85033D	3423A03482	N/A	N/A
16	Power meter	Agilent	E4419B	MY45104493	2023-10-25	2024-10-24
17	Power meter	Agilent	E4419B	MY45100308	2023-10-25	2024-10-24
18	Power sensor	Agilent	E9301H	MY41495616	2023-10-25	2024-10-24
19	Power sensor	Agilent	E9301H	MY41495234	2023-10-25	2024-10-24
20	Directional Coupler	MCLI/USA	4426-20	03746	2023-06-09	2024-06-08

Note:

- 1) Per KDB865664D01 requirements for dipole calibration, the test laboratory has adopted three year extended calibration interval. Each measured dipole is expected to evaluate with following criteria at least on annual interval.
 - a) There is no physical damage on the dipole;
 - b) System check with specific dipole is within 10% of calibrated values;
 - c) The most recent return-loss results,measured at least annually,deviates by no more than 20% from the previous measurement;
 - d) The most recent measurement of the real or imaginary parts of the impedance, measured at least annually is within 5Ω from the previous measurement.
- 2) Network analyzer probe calibration against air, distilled water and a shorting block performed before measuring liquid parameters.



Shenzhen LCS Compliance Testing Laboratory Ltd.

Add: 101, 201 Bldg A & 301 Bldg C, Juji Industrial Park Yabianxueziwei, Shajing Street, Baoan District, Shenzhen, 518000, China

Tel: +(86) 0755-82591330 | E-mail: webmaster@lcs-cert.com | Web: www.lcs-cert.com

Scan code to check authenticity

3.SAR MEASUREMENTS SYSTEM CONFIGURATION

3.1. SAR Measurement Set-up

The OPENSAR system for performing compliance tests consist of the following items:

A standard high precision 6-axis robot (KUKA) with controller and software.

KUKA Control Panel (KCP)

A dosimetric probe, i.e., an isotropic E-field probe optimized and calibrated for usage in tissue simulating liquid. The probe is equipped with a Video Positioning System(VPS).

The stress sensor is composed with mechanical and electronic when the electronic part detects a change on the electro-mechanical switch,It sends an “Emergency signal” to the robot controller that to stop robot’s moves

A computer operating Windows XP.

OPENSAR software

Remote control with teaches pendant and additional circuitry for robot safety such as warning lamps, etc.

The SAM phantom enabling testing left-hand right-hand and body usage.

The Position device for handheld EUT

Tissue simulating liquid mixed according to the given recipes .

System validation dipoles to validate the proper functioning of the system.

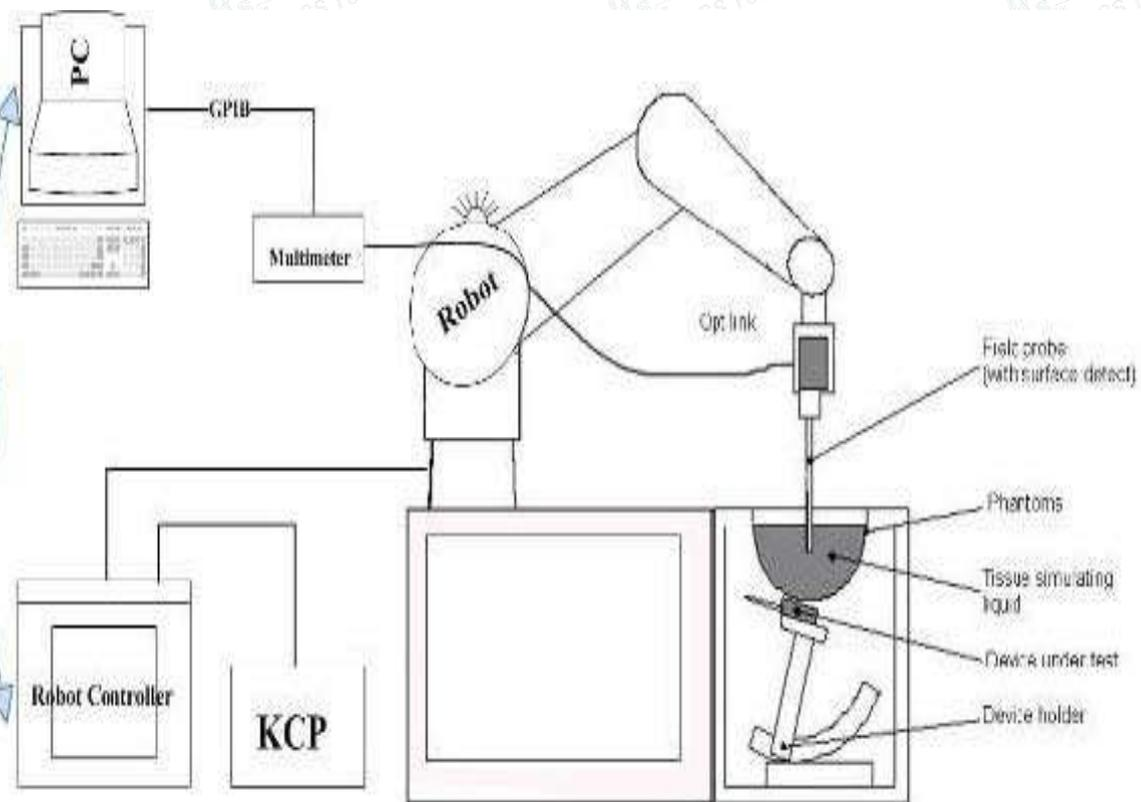

3.2. OPENSAR E-field Probe System

The SAR measurements were conducted with the dosimetric probe EPGO376 (manufactured by SATIMO), designed in the classical triangular configuration and optimized for dosimetric evaluation.

Probe Specification

Construction Symmetrical design with triangular core

Interleaved sensors

Built-in shielding against static charges

PEEK enclosure material (resistant to organic solvents, e.g., DGBE)

Calibration ISO/IEC 17025 calibration service available.

Frequency	450 MHz to 6 GHz; Linearity: 0.25 dB (450 MHz to 6 GHz)
Directivity	0.25 dB in HSL (rotation around probe axis) 0.5 dB in tissue material (rotation normal to probe axis)
Dynamic Range	0.01 W/kg to > 100 W/kg; Linearity: 0.25 dB
Dimensions	Overall length: 330 mm (Tip: 16 mm) Tip diameter: 5 mm (Body: 8 mm) Distance from probe tip to sensor centers: 2.5 mm
Application	General dosimetry up to 6 GHz Dosimetry in strong gradient fields Compliance tests of Mobile Phones

Isotropic E-Field Probe

The isotropic E-Field probe has been fully calibrated and assessed for isotropicity, and boundary effect within a controlled environment. Depending on the frequency for which the probe is calibrated the method utilized for calibration will change.

The E-Field probe utilizes a triangular sensor arrangement as detailed in the diagram below:

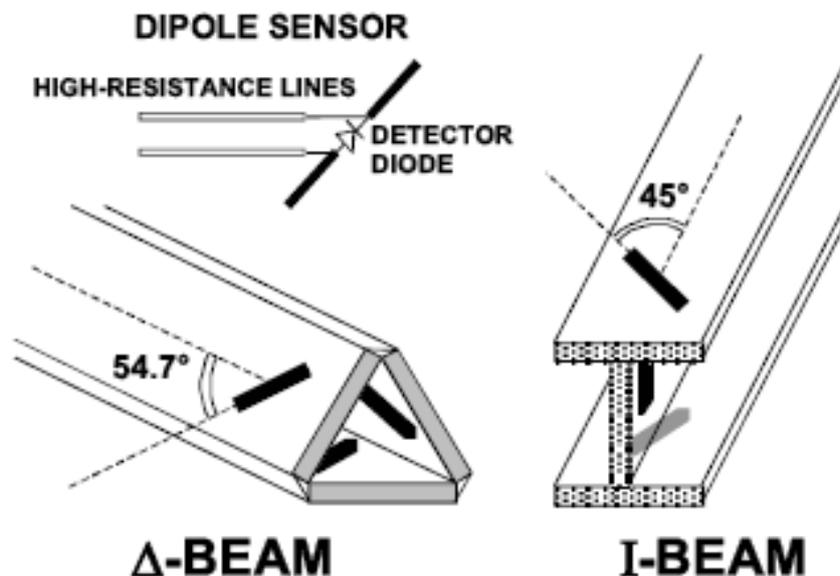

3.3. Phantoms

The SAM Phantom SAM117 is constructed of a fiberglass shell integrated in a wooden table. The shape of the shell is in compliance with the specification set in IEEE P1528 and CENELEC EN62209-1, EN62209-2:2010. The phantom enables the dosimetric evaluation of left and right hand phone usage as well as body mounted usage at the flat phantom region. A cover prevents the evaporation of the liquid. Reference markings on the Phantom allow the complete setup of all predefined phantom positions and measurement grids by manually teaching three points in the robot.

System checking was performed using the flat section, whilst Head SAR tests used the left and right head profile sections. Body SAR testing also used the flat section between the head profiles.



SAM Twin Phantom

3.4. Device Holder

In combination with the Generic Twin Phantom SAM117, the Mounting Device enables the rotation of the mounted transmitter in spherical coordinates whereby the rotation points is the ear opening. The devices can be easily, accurately, and repeatedly positioned according to the FCC and CENELEC specifications. The device holder can be locked at different phantom locations (left head, right head, flat phantom).



Device holder supplied by SATIMO





3.5. Scanning Procedure

The procedure for assessing the peak spatial-average SAR value consists of the following steps

Power Reference Measurement

The reference and drift jobs are useful jobs for monitoring the power drift of the device under test in the batch process. Both jobs measure the field at a specified reference position, at a selectable distance from the phantom surface. The reference position can be either the selected section's grid reference point or a user point in this section. The reference job projects the selected point onto the phantom surface, orients the probe perpendicularly to the surface, and approaches the surface using the selected detection method.

Area Scan

The Area Scan is used as a fast scan in two dimensions to find the area of high field values before running a detailed measurement around the hot spot. Before starting the area scan a grid spacing of 15 mm x 15 mm is set. During the scan the distance of the probe to the phantom remains unchanged. After finishing area scan, the field maxima within a range of 2 dB will be ascertained.

	≤ 3 GHz	> 3 GHz
Maximum distance from closest measurement point (geometric center of probe sensors) to phantom surface	5 mm ± 1 mm	$\frac{1}{2} \cdot \delta \cdot \ln(2)$ mm ± 0.5 mm
Maximum probe angle from probe axis to phantom surface normal at the measurement location	30° ± 1°	20° ± 1°
Maximum area scan spatial resolution: Δx_{Area} , Δy_{Area}	≤ 2 GHz: ≤ 15 mm 2 – 3 GHz: ≤ 12 mm	3 – 4 GHz: ≤ 12 mm 4 – 6 GHz: ≤ 10 mm
	When the x or y dimension of the test device, in the measurement plane orientation, is smaller than the above, the measurement resolution must be ≤ the corresponding x or y dimension of the test device with at least one measurement point on the test device.	

Zoom Scan

Zoom Scans are used to estimate the peak spatial SAR values within a cubic averaging volume containing 1 g and 10 g of simulated tissue. The default Zoom Scan is done by 7x7x7 points within a cube whose base is centered around the maxima found in the preceding area scan.

Maximum zoom scan spatial resolution: Δx_{Zoom} , Δy_{Zoom}		≤ 2 GHz: ≤ 8 mm 2 – 3 GHz: ≤ 5 mm*	3 – 4 GHz: ≤ 5 mm* 4 – 6 GHz: ≤ 4 mm*	
Maximum zoom scan spatial resolution, normal to phantom surface	uniform grid: $\Delta z_{Zoom}(n)$	≤ 5 mm	3 – 4 GHz: ≤ 4 mm 4 – 5 GHz: ≤ 3 mm 5 – 6 GHz: ≤ 2 mm	
	graded grid	$\Delta z_{Zoom}(1)$: between 1 st two points closest to phantom surface	≤ 4 mm	3 – 4 GHz: ≤ 3 mm 4 – 5 GHz: ≤ 2.5 mm 5 – 6 GHz: ≤ 2 mm
		$\Delta z_{Zoom}(n>1)$: between subsequent points	≤ 1.5 · $\Delta z_{Zoom}(n-1)$ mm	
Minimum zoom scan volume	x, y, z	≥ 30 mm	3 – 4 GHz: ≥ 28 mm 4 – 5 GHz: ≥ 25 mm 5 – 6 GHz: ≥ 22 mm	
Note: δ is the penetration depth of a plane-wave at normal incidence to the tissue medium; see IEEE Std 1528-2013 for details.				
* When zoom scan is required and the <i>reported</i> SAR from the <i>area scan based 1-g SAR estimation</i> procedures of KDB Publication 447498 is ≤ 1.4 W/kg, ≤ 8 mm, ≤ 7 mm and ≤ 5 mm zoom scan resolution may be applied, respectively, for 2 GHz to 3 GHz, 3 GHz to 4 GHz and 4 GHz to 6 GHz.				





Power Drift measurement

The drift job measures the field at the same location as the most recent reference job within the same procedure, and with the same settings. The drift measurement gives the field difference in dB from the reading conducted within the last reference measurement. Several drift measurements are possible for one reference measurement. This allows a user to monitor the power drift of the device under test within a batch process. In the properties of the Drift job, the user can specify a limit for the drift and have OPENSAR software stop the measurements if this limit is exceeded.





3.6. Tissue Dielectric Parameters for Head and Body Phantoms

The liquid is consisted of water,salt,Glycol,Sugar,Preventol and Cellulose.The liquid has previously been proven to be suited for worst-case.It's satisfying the latest tissue dielectric parameters requirements proposed by the KDB865664.

The composition of the tissue simulating liquid

Ingredient (% Weight)	750MHz		835MHz		1800 MHz		1900 MHz		2450MHz		2600MHz		5000MHz	
	Head	Body	Head	Body	Head	Body	Head	Body	Head	Body	Head	Body	Head	Body
Water	39.28	51.3	41.45	52.5	54.5	40.2	54.9	40.4	62.7	73.2	60.3	71.4	65.5	78.6
Preventol	0.10	0.10	0.10	0.10	0.00	0.00	0.00	0.00	0.00	0.00	0.00	0.00	0.00	0.00
HEC	1.00	1.00	1.00	1.00	0.00	0.00	0.00	0.00	0.00	0.00	0.00	0.00	0.00	0.00
DGBE	0.00	0.00	0.00	0.00	45.33	59.31	44.92	59.10	36.80	26.70	39.10	28.40	0.00	0.00
Triton X-100	0.00	0.00	0.00	0.00	0.00	0.00	0.00	0.00	0.00	0.00	0.00	0.00	17.2	10.7

Target Frequency (MHz)	Head	
	ϵ_r	σ (S/m)
450	43.5	0.87
750	41.9	0.89
835	41.5	0.90
900	41.5	0.97
1450	40.5	1.20
1640	40.2	1.31
1800	40.0	1.40
1900	40.0	1.40
2000	40.0	1.40
2450	39.2	1.80
2600	39.0	1.96
3000	38.5	2.40
5200	36.0	4.66
5300	35.9	4.76
5600	35.55	5.07
5800	35.3	5.27

3.7. Tissue equivalent liquid properties

Dielectric Performance of Head Tissue Simulating Liquid

Test Engineer: bob.yang									
Tissue Type	Measured Frequency (MHz)	Target Tissue		Measured Tissue				Liquid Temp.	Test Data
		σ	ϵ_r	σ	Dev.	ϵ_r	Dev.		
2450H	2450	1.8	39.2	1.87	3.89%	39	-0.51%	22.1	12/7/2023
5200H	5200	4.66	36	4.68	0.43%	35.2	-2.22%	22.4	12/7/2023
5800H	5800	5.27	35.3	5.29	0.38%	34.5	-2.27%	22.4	12/8/2023



3.8. System Check

The purpose of the system check is to verify that the system operates within its specifications at the device test frequency. The system check is simple check of repeatability to make sure that the system works correctly at the time of the compliance test;

System check results have to be equal or near the values determined during dipole calibration with the relevant liquids and test system ($\pm 10\%$).

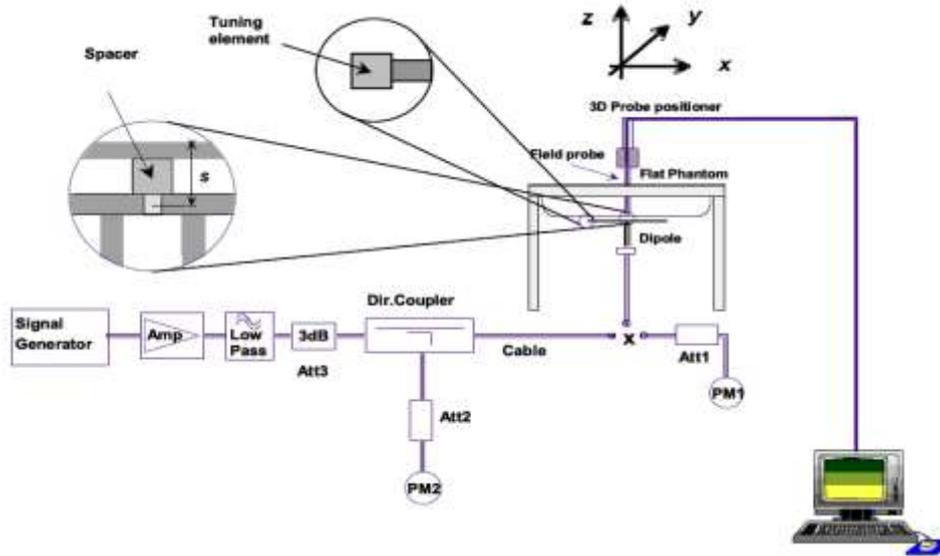

The output power on dipole port must be calibrated to 20 dBm (100mW) before dipole is connected.



Photo of Dipole Setup



**Justification for Extended SAR Dipole Calibrations**

Referring to KDB 865664D01V01r04, if dipoles are verified in return loss (<-20dB, within 20% of prior calibration), and in impedance (within 5 ohm of prior calibration), the annual calibration is not necessary and the calibration interval can be extended. While calibration intervals not exceed 3 years.

SID2450 SN 07/14 DIP 2G450-306 Extend Dipole Calibrations

Date of Measurement	Return-Loss (dB)	Delta (%)	Real Impedance (ohm)	Delta (ohm)	Imaginary Impedance (ohm)	Delta (ohm)
2021-09-29	-25.59		44.7		-1.1	
2022-09-29	-25.68	0.35	44.8	0.1	-1.0	0.1
2023-09-29	-25.70	0.43	44.5	-0.2	-1.1	0.0

SID5200 SN 49/16 DIP WGA43 Extend Dipole Calibrations

Date of Measurement	Return-Loss (dB)	Delta (%)	Real Impedance (ohm)	Delta (ohm)	Imaginary Impedance (ohm)	Delta (ohm)
2021-09-22	-8.59		19.38		13.50	
2022-09-22	-8.62	0.35	19.25	-0.13	13.47	-0.03
2023-09-22	-8.63	0.47	19.26	-0.12	13.45	-0.05

SID5800 SN 49/16 DIP WGA43 Extend Dipole Calibrations

Date of Measurement	Return-Loss (dB)	Delta (%)	Real Impedance (ohm)	Delta (ohm)	Imaginary Impedance (ohm)	Delta (ohm)
2021-09-22	-11.37		54.79		25.47	
2022-09-22	-11.42	0.44	54.68	-0.11	25.26	-0.21
2023-09-22	-11.44	0.62	54.80	0.10	25.28	-0.19

Mixture Type	Frequency (MHz)	Power	SAR _{1g} (W/Kg)	SAR _{10g} (W/Kg)	Drift (%)	1W Target		Difference percentage		Liquid Temp	Date
						SAR _{1g} (W/Kg)	SAR _{10g} (W/Kg)	1g	10g		
Head	2450	100 mW	5.49	2.518	0.08	53.89	24.15	1.87%	4.27%	22.1	12/7/2023
		Normalize to 1 Watt	54.9	25.18							
Head	5200	100 mW	15.79	5.515	3.02	165.77	57.2	-4.75%	3.58%	22.4	12/7/2023
		Normalize to 1 Watt	157.9	55.15							
Head	5800	100 mW	17.539	5.895	1.25	181.2	61.5	-3.21%	4.15%	22.4	12/8/2023
		Normalize to 1 Watt	175.39	58.95							





3.9. SAR measurement procedure

The measurement procedures are as follows:

3.11.1 Conducted power measurement

- For WWAN power measurement, use base station simulator connection with RF cable, at maximum power in each supported wireless interface and frequency band.
- Read the WWAN RF power level from the base station simulator.
- For WLAN/BT power measurement, use engineering software to configure EUT WLAN/BT continuously Transmission, at maximum RF power in each supported wireless interface and frequency band.
- Connect EUT RF port through RF cable to the power meter, and measure WLAN/BT output power.

3.11.4 WIFI Test Configuration

The SAR measurement and test reduction procedures are structured according to either the DSSS or OFDM transmission mode configurations used in each standalone frequency band and aggregated band. For devices that operate in exposure configurations that require multiple test positions, additional SAR test reduction may be applied. The maximum output power specified for production units, including tune-up tolerance, are used to determine initial SAR test requirements for the 802.11 transmission modes in a frequency band. SAR is measured using the highest measured maximum output power channel for the initial test configuration. SAR measurement and test reduction for the remaining 802.11 modes and test channels are determined according to measured or specified maximum output power and reported SAR of the initial measurements. The general test reduction and SAR measurement approaches are summarized in the following:

- The maximum output power specified for production units are determined for all applicable 802.11 transmission modes in each standalone and aggregated frequency band. Maximum output power is measured for the highest maximum output power configuration(s) in each frequency band according to the default power measurement procedures.
- For OFDM transmission configurations in the 2.4 GHz and 5 GHz bands, an “initial test configuration” is first determined for each standalone and aggregated frequency band according to the maximum output power and tune-up tolerance specified for production units.
 - When the same maximum power is specified for multiple transmission modes in a frequency band, the largest channel bandwidth, lowest order modulation, lowest data rate and lowest order 802.11a/g/n/ac mode is used for SAR measurement, on the highest measured output power channel in the initial test configuration, for each frequency band.
 - SAR is measured for OFDM configurations using the initial test configuration procedures. Additional frequency band specific SAR test reduction may be considered for individual frequency bands
 - Depending on the reported SAR of the highest maximum output power channel tested in the initial test configuration, SAR test reduction may apply to subsequent highest output channels in the initial test configuration to reduce the number of SAR measurements.
- The Initial test configuration does not apply to DSSS. The 2.4 GHz band SAR test requirements and 802.11b DSSS procedures are used to establish the transmission configurations required for SAR measurement.
- An “initial test position” is applied to further reduce the number of SAR tests for devices operating in next to the ear, UMPC mini-tablet or hotspot mode exposure configurations that require multiple test positions .
 - SAR is measured for 802.11b according to the 2.4 GHz DSSS procedure using the exposure condition established by the initial test position.
 - SAR is measured for 2.4 GHz and 5 GHz OFDM configurations using the initial test configuration. 802.11b/g/n operating modes are tested independently according to the service requirements in each frequency band. 802.11b/g/n modes are tested on the maximum average output channel.
- The Initial test position does not apply to devices that require a fixed exposure test position. SAR is measured in a fixed exposure test position for these devices in 802.11b according to the 2.4 GHz DSSS procedure or in 2.4 GHz and 5 GHz OFDM configurations using the initial test configuration procedures .
- The “subsequent test configuration” procedures are applied to determine if additional SAR measurements are required for the remaining OFDM transmission modes that have not been tested in the initial test configuration. SAR test exclusion is determined according to reported SAR in the initial test configuration and maximum output power specified or measured for these other OFDM configurations.

2.4 GHz and 5GHz SAR Procedures

Separate SAR procedures are applied to DSSS and OFDM configurations in the 2.4 GHz band to simplify DSSS test requirements. For 802.11b DSSS SAR measurements, DSSS SAR procedure applies to fixed exposure test position and initial test position procedure applies to multiple exposure test positions. When SAR measurement is required for an OFDM configuration, the initial test configuration, subsequent test configuration and initial test position procedures are applied. The SAR test exclusion requirements for 802.11g/n OFDM configurations are described in section 5.2.2.

1. 802.11b DSSS SAR Test Requirements

SAR is measured for 2.4 GHz 802.11b DSSS using either a fixed test position or, when applicable, the initial test position procedure. SAR test reduction is determined according to the following:

- When the reported SAR of the highest measured maximum output power channel (section 3.1) for the exposure configuration is ≤ 0.8 W/kg, no further SAR testing is required for 802.11b DSSS in that exposure configuration.



Shenzhen LCS Compliance Testing Laboratory Ltd.

Add: 101, 201 Bldg A & 301 Bldg C, Juji Industrial Park Yabianxueziwei, Shajing Street, Baoan District, Shenzhen, 518000, China

Tel: +(86) 0755-82591330 | E-mail: webmaster@lcs-cert.com | Web: www.lcs-cert.com

Scan code to check authenticity





- b. When the reported SAR is > 0.8 W/kg, SAR is required for that exposure configuration using the next highest measured output power channel. When any reported SAR is > 1.2 W/kg, SAR is required for the third channel; i.e., all channels require testing.
- 1. 2.4 GHz 802.11g/n OFDM SAR Test Exclusion Requirements

When SAR measurement is required for 2.4 GHz 802.11g/n OFDM configurations, the measurement and test reduction procedures for OFDM are applied (section 5.3). SAR is not required for the following 2.4 GHz OFDM conditions.

- a. When KDB Publication 447498 SAR test exclusion applies to the OFDM configuration
- b. When the highest reported SAR for DSSS is adjusted by the ratio of OFDM to DSSS specified maximum output power and the adjusted SAR is ≤ 1.2 W/kg.
- 2. SAR Test Requirements for OFDM Configurations

When SAR measurement is required for 802.11 a/g/n/ac OFDM configurations, each standalone and frequency aggregated band is considered separately for SAR test reduction. When the same transmitter and antenna(s) are used for U-NII-1 and U-NII-2A bands, additional SAR test reduction applies. When band gap channels between U-NII-2C band and 5.8 GHz U-NII-3 or §15.247 band are supported, the highest maximum output power transmission mode configuration and maximum output power channel across the bands must be used to determine SAR test reduction, according to the initial test configuration and subsequent test configuration requirements.²⁰ In applying the initial test configuration and subsequent test configuration procedures, the 802.11 transmission configuration with the highest specified maximum output power and the channel within a test configuration with the highest measured maximum output power should be clearly distinguished to apply the procedures.

3. OFDM Transmission Mode SAR Test Configuration and Channel Selection Requirements

The initial test configuration for 2.4 GHz and 5 GHz OFDM transmission modes is determined by the 802.11 configuration with the highest maximum output power specified for production units, including tune-up tolerance, in each standalone and aggregated frequency band. SAR for the initial test configuration is measured using the highest maximum output power channel determined by the default power measurement procedures (section 4). When multiple configurations in a frequency band have the same specified maximum output power, the initial test configuration is determined according to the following steps applied sequentially.

- a. The largest channel bandwidth configuration is selected among the multiple configurations with the same specified maximum output power.
- b. If multiple configurations have the same specified maximum output power and largest channel bandwidth, the lowest order modulation among the largest channel bandwidth configurations is selected.
- c. If multiple configurations have the same specified maximum output power, largest channel bandwidth and lowest order modulation, the lowest data rate configuration among these configurations is selected.
- d. When multiple transmission modes (802.11a/g/n/ac) have the same specified maximum output power, largest channel bandwidth, lowest order modulation and lowest data rate, the lowest order 802.11 mode is selected; i.e., 802.11a is chosen over 802.11n then 802.11ac or 802.11g is chosen over 802.11n.

After an initial test configuration is determined, if multiple test channels have the same measured maximum output power, the channel chosen for SAR measurement is determined according to the following. These channel selection procedures apply to both the initial test configuration and subsequent test configuration(s), with respect to the default power measurement procedures or additional power measurements required for further SAR test reduction. The same procedures also apply to subsequent highest output power channel(s) selection.

- a. Channels with measured maximum output power within $\frac{1}{4}$ dB of each other are considered to have the same maximum output.
- b. When there are multiple test channels with the same measured maximum output power, the channel closest to mid-band frequency is selected for SAR measurement.
- c. When there are multiple test channels with the same measured maximum output power and equal separation from mid-band frequency; for example, high and low channels or two mid-band channels, the higher frequency (number) channel is selected for SAR measurement.

Initial Test Configuration Procedures

An initial test configuration is determined for OFDM transmission modes according to the channel bandwidth, modulation and data rate combination(s) with the highest maximum output power specified for production units in each standalone and aggregated frequency band. SAR is measured using the highest measured maximum output power channel. For configurations with the same specified or measured maximum output power, additional transmission mode and test channel selection procedures are required (see section 5.3.2). SAR test reduction of subsequent highest output test channels is based on the reported SAR of the initial test configuration.

For next to the ear, hotspot mode and UMC mini-tablet exposure configurations where multiple test positions are required, the initial test position procedure is applied to minimize the number of test positions required for SAR measurement using the initial test configuration transmission mode.²³ For fixed exposure conditions that do not have multiple SAR test positions, SAR is measured in the transmission mode determined by the initial test configuration. When the reported SAR of the initial test configuration is > 0.8 W/kg, SAR measurement is required for the subsequent next highest measured output power channel(s) in the initial test configuration until the reported SAR is ≤ 1.2 W/kg or all required channels are tested.

4. Subsequent Test Configuration Procedures

SAR measurement requirements for the remaining 802.11 transmission mode configurations that have not been tested in the initial test configuration are determined separately for each standalone and aggregated frequency band, in each exposure





condition, according to the maximum output power specified for production units. The initial test position procedure is applied to next to the ear, UMPC mini-tablet and hotspot mode configurations. When the same maximum output power is specified for multiple transmission modes, the procedures in section 5.3.2 are applied to determine the test configuration. Additional power measurements may be required to determine if SAR measurements are required for subsequent highest output power channels in a subsequent test configuration. The subsequent test configuration and SAR measurement procedures are described in the following.

- a. When SAR test exclusion provisions of KDB Publication 447498 are applicable and SAR measurement is not required for the initial test configuration, SAR is also not required for the next highest maximum output power transmission mode subsequent test configuration(s) in that frequency band or aggregated band and exposure configuration.
- b. When the highest reported SAR for the initial test configuration (when applicable, include subsequent highest output channels), according to the initial test position or fixed exposure position requirements, is adjusted by the ratio of the subsequent test configuration to initial test configuration specified maximum output power and the adjusted SAR is ≤ 1.2 W/kg, SAR is not required for that subsequent test configuration.
- c. The number of channels in the initial test configuration and subsequent test configuration can be different due to differences in channel bandwidth. When SAR measurement is required for a subsequent test configuration and the channel bandwidth is smaller than that in the initial test configuration, all channels in the subsequent test configuration that overlap with the larger bandwidth channel tested in the initial test configuration should be used to determine the highest maximum output power channel. This step requires additional power measurement to identify the highest maximum output power channel in the subsequent test configuration to determine SAR test reduction.
 - 1). SAR should first be measured for the channel with highest measured output power in the subsequent test configuration.
 - 2). SAR for subsequent highest measured maximum output power channels in the subsequent test configuration is required only when the reported SAR of the preceding higher maximum output power channel(s) in the subsequent test configuration is > 1.2 W/kg or until all required channels are tested.
 - a) For channels with the same measured maximum output power, SAR should be measured using the channel closest to the center frequency of the larger channel bandwidth channel in the initial test configuration.
 - d. SAR measurements for the remaining highest specified maximum output power OFDM transmission mode configurations that have not been tested in the initial test configuration (highest maximum output) or subsequent test configuration(s) (subsequent next highest maximum output power) is determined by applying the subsequent test configuration procedures in this section to the remaining configurations according to the following:
 - 1) replace “subsequent test configuration” with “next subsequent test configuration” (i.e., subsequent next highest specified maximum output power configuration)
 - 2) replace “initial test configuration” with “all tested higher output power configurations.”

3.10. Power Reduction

The product without any power reduction.

3.11. Power Drift

To control the output power stability during the SAR test, SAR system calculates the power drift by measuring the E-field at the same location at the beginning and at the end of the measurement for each test position. This ensures that the power drift during one measurement is within 5%.





4. TEST CONDITIONS AND RESULTS

4.1. Conducted Power Results

According KDB 447498D01 General RF Exposure Guidance v06 Section 4.1 2) states that “Unless it is specified differently in the published RF exposure KDB procedures, these requirements also apply to test reduction and test exclusion considerations. Time-averaged maximum conducted output power applies to SAR and, as required by § 2.1091(c), time-averaged ERP applies to MPE. When an antenna port is not available on the device to support conducted power measurement, such as FRS and certain Part 15 transmitters with built-in integral antennas, the maximum output power allowed for production units should be used to determine RF exposure test exclusion and compliance.”

<WLAN 2.4GHz Conducted Power>

Mode	Channel	Frequency (MHz)	Data rate (Mbps)	tune-up (dBm) ANT1	Average Output Power (dBm) ANT1	tune-up (dBm) ANT2	Average Output Power (dBm) ANT2
IEEE 802.11b	1	2412	1	12	11.68	12	11.98
	6	2437	1	11.5	11.29	12	11.55
	11	2462	1	11	10.60	11.5	11.00
IEEE 802.11g	1	2412	6	12	11.56	12	11.74
	6	2437	6	11.5	11.05	11.5	11.25
	11	2462	6	10.5	10.46	11	10.70
IEEE 802.11n HT20	1	2412	MCS0	12	11.52	12.5	12.00
	6	2437	MCS0	11	10.54	11.5	11.42
	11	2462	MCS0	12	11.65	11	10.79
IEEE 802.11n HT40	3	2422	MCS0	11.5	11.17	12	11.71
	6	2437	MCS0	11	10.77	12	11.66
	9	2452	MCS0	11	10.54	11.5	11.21

Note:SAR is not required for the following 2.4 GHz OFDM conditions as the highest reported SAR for DSSS is adjusted by the ratio of OFDM to DSSS specified maximum output power and the adjusted SAR is ≤ 1.2 W/kg.





<WLAN 5.2G Conducted Power>

Mode	Channel	Frequency (MHz)	tune-up (dBm) ANT1	Average Conducted Output Power(dBm) ANT1	tune-up (dBm) ANT2	Average Conducted Output Power(dBm) ANT2	Worst Case Test Rate Data
IEEE 802.11a	36	5180	7.5	7.43	7	6.81	MCS0
	40	5200	8	7.66	8	7.58	MCS0
	48	5240	8.5	8.22	8	7.69	MCS0
IEEE 802.11n HT20	36	5180	7.5	7.31	7	6.82	MCS0
	40	5200	8	7.91	7.5	7.47	MCS0
	48	5240	8.5	8.24	8	7.71	MCS0
IEEE 802.11n HT40	38	5190	7.5	7.04	7	6.50	MCS0
	46	5230	8	7.76	8	7.83	MCS0
IEEE 802.11ac VHT20	36	5180	7.5	7.13	7	6.70	MCS0
	40	5200	8	7.72	7.5	7.40	MCS0
	48	5240	8	7.88	8	7.50	MCS0
IEEE 802.11ac VHT40	38	5190	7.5	7.44	7	6.57	MCS0
	46	5230	8.5	8.24	7.5	7.41	MCS0
IEEE 802.11ac VHT80	42	5210	8	7.85	8	7.76	MCS0

<WLAN 5.8GHz Conducted Power>

Mode	Channel	Frequency (MHz)	tune-up (dBm) ANT1	Conducted Output Power(dBm) ANT1	tune-up (dBm) ANT2	Conducted Output Power(dBm) ANT2
802.11a	149	5745	8	7.53	7.5	7.41
	157	5785	8	7.93	8.5	8.06
	165	5825	8	7.51	8.5	8.41
802.11n(20MHz)	149	5745	8	7.67	8	7.55
	157	5785	8	7.72	8	7.88
	165	5825	7.5	7.43	8.5	8.17
802.11n(40MHz)	151	5755	8	7.83	8	7.81
	159	5795	8	7.81	8.5	8.27
802.11ac(20MHz)	149	5745	8	7.81	8	7.70
	157	5785	8	7.89	8	7.91
	165	5825	8	7.72	8.5	8.13
802.11ac(40MHz)	151	5755	9	8.55	8	7.64
	159	5795	8	7.77	8.5	8.24
802.11ac(80MHz)	155	5775	8.5	8.17	8.5	8.15



Shenzhen LCS Compliance Testing Laboratory Ltd.

Add: 101, 201 Bldg A & 301 Bldg C, Juji Industrial Park Yabianxueziwei, Shajing Street, Baoan District, Shenzhen, 518000, China

Tel: +(86) 0755-82591330 | E-mail: webmaster@lcs-cert.com | Web: www.lcs-cert.com

Scan code to check authenticity

<BT Conducted Power>

Mode	channel	Frequency (MHz)	tune-up	Conducted Average output power (dBm)
BLE	0	2402	4	3.86
	20	2442	5	4.61
	39	2480	4	3.69
GFSK	0	2402	4.5	4.15
	39	2441	4.5	4.02
	78	2480	3.5	3.26
$\pi/4$ -DQPSK	0	2402	4.5	4.29
	39	2441	4.5	4.16
	78	2480	3.5	3.36
8DPSK	0	2402	5	4.63
	39	2441	5	4.54
	78	2480	4	3.77

Per KDB 447498 D01v06, the 1-g and 10-g SAR test exclusion thresholds for 100 MHz to 6 GHz at test separation distances ≤ 50 mm are determined by:

$[(\text{max. power of channel, including tune-up tolerance, mW}) / (\text{min. test separation distance, mm})] \cdot [\sqrt{f(\text{GHz})}] \leq 3.0$ for 1-g SAR and ≤ 7.5 for 10-g extremity SAR

f(GHz) is the RF channel transmit frequency in GHz

Power and distance are rounded to the nearest mW and mm before calculation

The result is rounded to one decimal place for comparison

Bluetooth Turn up Power (dBm)	Separation Distance (mm)	Frequency (GHz)	Exclusion Thresholds
5.0	5	2.45	1.0

Per KDB 447498 D01v06, when the minimum test separation distance is < 5 mm, a distance of 5 mm is applied to determine SAR test exclusion. The test exclusion threshold is $1.0 < 3.0$, SAR testing is not required.





4.2. Transmit Antennas and SAR Measurement Position

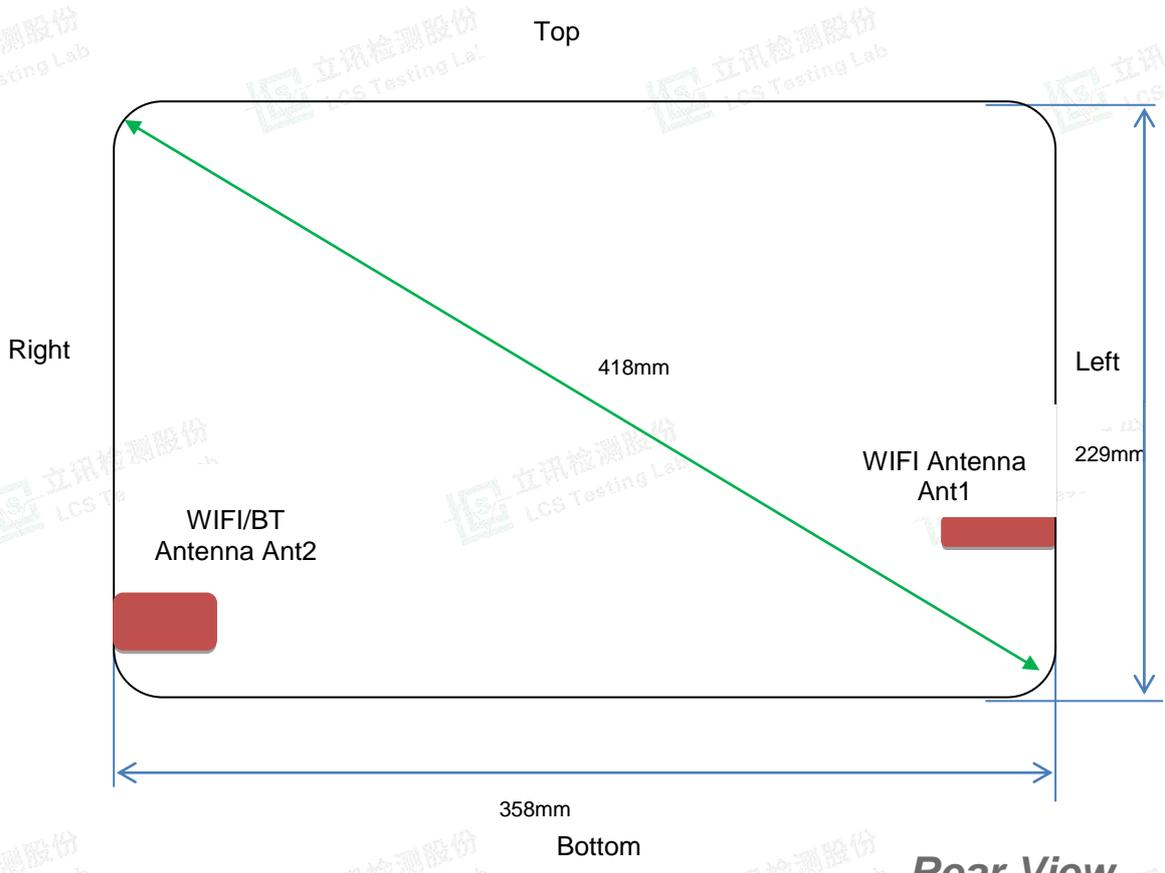

Rear View





4.3. SAR Measurement Results

The calculated SAR is obtained by the following formula:

$$\text{Reported SAR} = \text{Measured SAR} * 10^{(P_{\text{target}} - P_{\text{measured}})/10}$$

$$\text{Scaling factor} = 10^{(P_{\text{target}} - P_{\text{measured}})/10}$$

$$\text{Reported SAR} = \text{Measured SAR} * \text{Scaling factor}$$

Where

P_{target} is the power of manufacturing upper limit;

P_{measured} is the measured power;

Measured SAR is measured SAR at measured power which including power drift)

Reported SAR which including Power Drift and Scaling factor

Duty Cycle

Test Mode	Duty Cycle
WLAN2450/5200/5800	1:1

4.4.1 SAR Results

SAR Values [WIFI2.4G] ANT1

Ch.	Freq. (MHz)	Service	Test Position	Conducted Power (dBm)	Maximum Allowed Power (dBm)	Power Drift (%)	Scaling Factor	SAR-g results(W/kg)		Graph Results
								Measured	Reported	
measured / reported SAR numbers - Body (distance 0mm)										
1	2412	802.11b	Rear	11.86	12	-2.19	1.033	0.032	0.033	--

SAR Values [WIFI2.4G] ANT2

Ch.	Freq. (MHz)	Service	Test Position	Conducted Power (dBm)	Maximum Allowed Power (dBm)	Power Drift (%)	Scaling Factor	SAR-g results(W/kg)		Graph Results
								Measured	Reported	
measured / reported SAR numbers - Body (distance 0mm)										
1	2412	802.11b	Rear	11.98	12	4.31	1.005	0.027	0.027	Plot 1

SAR Values [5.2G] ANT1

Ch.	Freq. (MHz)	Service	Test Position	Conducted Power (dBm)	Maximum Allowed Power (dBm)	Power Drift (%)	Scaling Factor	SAR-g results(W/kg)		Graph Results
								Measured	Reported	
measured / reported SAR numbers - Body (distance 0mm)										
48	5240	802.11n HT20	Rear	8.24	8.5	1.77	1.062	0.079	0.084	--

SAR Values [5.2G] ANT2

Ch.	Freq. (MHz)	Service	Test Position	Conducted Power (dBm)	Maximum Allowed Power (dBm)	Power Drift (%)	Scaling Factor	SAR-g results(W/kg)		Graph Results
								Measured	Reported	
measured / reported SAR numbers - Body (distance 0mm)										
46	5230	802.11n HT40	Rear	7.83	8	-3.74	1.040	0.057	0.059	Plot 2



Shenzhen LCS Compliance Testing Laboratory Ltd.

Add: 101, 201 Bldg A & 301 Bldg C, Juji Industrial Park Yabianxueziwei, Shajing Street, Baoan District, Shenzhen, 518000, China

Tel: +(86) 0755-82591330 | E-mail: webmaster@lcs-cert.com | Web: www.lcs-cert.com

Scan code to check authenticity



SAR Values [5.8G] ANT1

Ch.	Freq. (MHz)	Service	Test Position	Conducted Power (dBm)	Maximum Allowed Power (dBm)	Power Drift (%)	Scaling Factor	SAR1-g results(W/kg)		Graph Results
								Measured	Reported	
measured / reported SAR numbers - Body (distance 0mm)										
151	5755	802.11ac(40MHz)	Rear	8.55	9	4.00	1.109	0.103	0.114	--

SAR Values [5.8G] ANT2

Ch.	Freq. (MHz)	Service	Test Position	Conducted Power (dBm)	Maximum Allowed Power (dBm)	Power Drift (%)	Scaling Factor	SAR1-g results(W/kg)		Graph Results
								Measured	Reported	
measured / reported SAR numbers - Body (distance 0mm)										
165	5825	802.11a	Rear	8.41	8.5	-3.35	1.021	0.061	0.062	Plot 3

Remark:

1. The value with blue color is the maximum SAR Value of each test band.
2. Per FCC KDB Publication 447498 D01, if the reported (scaled) SAR measured at the middle channel or highest output power channel for each test configuration is ≤ 0.8 W/kg then testing at the other channels is optional for such test configuration(s).
3. SAR is not required for the following 2.4 GHz OFDM conditions as the highest reported SAR for DSSS is adjusted by the ratio of OFDM to DSSS specified maximum output power and the adjusted SAR is $0.212[0.204*(13.50/13.00)] \leq 1.2$ W/kg.
4. MIMO is less powerful than b/g mode, MIMO testing is not required.





4.4.2 Standalone SAR Test Exclusion Considerations and Estimated SAR

Per KDB447498 requires when the standalone SAR test exclusion of section 4.3.1 is applied to an antenna that transmits simultaneously with other antennas, the standalone SAR must be estimated according to the following to determine simultaneous transmission SAR test exclusion;

● (max. power of channel, including tune-up tolerance, mW)/(min. test separation distance, mm)] • [√ f(GHz)/x] W/kg for test separation distances ≤ 50 mm;

where x = 7.5 for 1-g SAR, and x = 18.75 for 10-g SAR.

● 0.4 W/kg for 1-g SAR and 1.0 W/kg for 10-g SAR, when the test separation distances is > 50 mm

Per FCC KD B447498 D01, simultaneous transmission SAR test exclusion may be applied when the sum of the 1-g SAR for all the transmitting antenna in a specific a physical test configuration is ≤ 1.6 W/Kg. When the sum is greater than the SAR limit, SAR test exclusion is determined by the SAR to peak location separation ratio.

$$\text{Ratio} = \frac{(SAR_1 + SAR_2)^{1.5}}{(\text{peak location separation, mm})} < 0.04$$

Estimated stand alone SAR					
Communication system	Frequency (MHz)	Configuration	Maximum Power (dBm)	Separation Distance (mm)	Estimated SAR _{1-g} (W/kg)
Bluetooth*	2450	Body-worn	5.0	5	0.132

Remark:

1. Bluetooth*- Including Lower power Bluetooth
2. Maximum average power including tune-up tolerance;
3. When the minimum test separation distance is < 5 mm, a distance of 5 mm is applied to determine SAR test exclusion
4. Body as body use distance is 0mm from manufacturer declaration of user manual



4.4.3 Simultaneous Transmission Conditions

According to KDB 447498 D01 General RF exposure guidance provides two procedures for determining simultaneous transmission SAR test exclusion: Sum of SAR and SAR to Peak Location Ratio (SPLSR).

Sum of SAR

To qualify for simultaneous transmission SAR test exclusion based upon Sum of SAR the sum of the reported standalone SAR for all simultaneously transmitting antennas shall be below the applicable standalone SAR limit. If the sum of the SAR is above the applicable limit then simultaneous transmission SAR test exclusion may still apply if the requirements of the SAR to Peak Location Ratio (SPLSR) evaluation are met.

Simultaneous Transmission SAR Exclusion

According to KDB 248227 D01, simultaneous SAR provision in KDB 447498 D01 apply to determine simultaneous transmission SAR test exclusion for Wi-Fi MIMO, if the Sum of 1-g single transmission chain SAR measurements is <1.6W/kg and/or the MIMO output power is equal or less than a single chain, then no additional SAR measurements for simultaneously at the specified maximum output power of MIMO operation.

When antennas are spatially separated to the extent that SAR distributions do not overlap and can be treated independently, SAR compliance for simultaneous transmission is determined separately for each individual antenna.

The simultaneous transmission possibilities for this device are listed as below;

Simultaneous Transmission

Modulation Type	Work Frequency Band	Transmit Antenna		Antenna 1 Antenna 2 Synchronization transmits
		Antenna 1	Antenna 2	
BT	2.4GHz	No	Yes	No
IEEE 802.11b	2.4GHz	Yes	Yes	No
IEEE 802.11g	2.4GHz	Yes	Yes	No
IEEE 802.11n HT20	2.4GHz	Yes	Yes	Yes
IEEE 802.11n HT40	2.4GHz	Yes	Yes	Yes
IEEE 802.11a	5GHz	Yes	Yes	No
IEEE 802.11n HT20	5GHz	Yes	Yes	Yes
IEEE 802.11n HT40	5GHz	Yes	Yes	Yes
IEEE 802.11ac VHT20	5GHz	Yes	Yes	Yes
IEEE 802.11ac VHT40	5GHz	Yes	Yes	Yes
IEEE 802.11ac VHT80	5GHz	Yes	Yes	Yes

Note:

1. WiFi 2.4G & WiFi 5G cannot transmit simultaneously.
2. The BT and WLAN share same modular, the device not support transmit one packet including WLAN and BT together. BT and WLAN no need consider simultaneous transmission.

4.4.3.1. Sum of the SAR for 5.2GHz WiFi Results

RF Exposure Condition	Position	Standalone SAR _{1-g} (W/kg)		Σ SAR _{1-g} (W/kg)	Simultaneous SAR _{1-g} Limit (W/kg)
		Wi-Fi 5.2GHz Antenna 1	Wi-Fi 5.2GHz Antenna 2		
Body-Worn	Position 1	0.149	0.179	0.328	<1.6

4.4.3.3. Sum of the SAR for 5.8GHz WiFi Results

RF Exposure Condition	Position	Standalone SAR _{1-g} (W/kg)		Σ SAR _{1-g} (W/kg)	Simultaneous SAR _{1-g} Limit (W/kg)
		Wi-Fi 5.8GHz Antenna 1	Wi-Fi 5.8GHz Antenna 2		
Body-Worn	Position 1	0.110	0.143	0.253	<1.6



4.4. SAR Measurement Variability

According to KDB865664, Repeated measurements are required only when the measured SAR is ≥ 0.80 W/kg. If the measured SAR value of the initial repeated measurement is < 1.45 W/kg with $\leq 20\%$ variation, only one repeated measurement is required to reaffirm that the results are not expected to have substantial variations, which may introduce significant compliance concerns. A second repeated measurement is required only if the measured result for the initial repeated measurement is within 10% of the SAR limit and vary by more than 20%, which are often related to device and measurement setup difficulties. The following procedures are applied to determine if repeated measurements are required. The same procedures should be adapted for measurements according to extremity and occupational exposure limits by applying a factor of 2.5 for extremity exposure and a factor of 5 for occupational exposure to the corresponding SAR thresholds.¹⁹ The repeated measurement results must be clearly identified in the SAR report. All measured SAR, including the repeated results, must be considered to determine compliance and for reporting according to KDB 690783. Repeated measurement is not required when the original highest measured SAR is < 0.80 W/kg; steps 2) through 4) do not apply.

- 1) When the original highest measured SAR is ≥ 0.80 W/kg, repeat that measurement once.
- 2) Perform a second repeated measurement only if the ratio of largest to smallest SAR for the original and first repeated measurements is > 1.20 or when the original or repeated measurement is ≥ 1.45 W/kg (~ 10% from the 1-g SAR limit).
- 3) Perform a third repeated measurement only if the original, first or second repeated measurement is ≥ 1.5 W/kg and the ratio of largest to smallest SAR for the original, first and second repeated measurements is > 1.20 .
- 4) Perform a third repeated measurement only if the original, first or second repeated measurement is ≥ 1.5 W/kg and the ratio of largest to smallest SAR for the original, first and second repeated measurements is > 1.20

Frequency Band (MHz)	Air Interface	RF Exposure Configuration	Test Position	Repeated SAR (yes/no)	Highest Measured SAR _{1-g} (W/Kg)	First Repeated	
						Measured SAR _{1-g} (W/Kg)	Largest to Smallest SAR Ratio
2450	2.4GWLAN	Standalone	Body-Rear	no	0.183	n/a	n/a
5200	5.2GWLAN	Standalone	Body-Rear	no	0.143	n/a	n/a
5800	5.8GWLAN	Standalone	Body-Rear	no	0.113	n/a	n/a

Remark:

1. Second Repeated Measurement is not required since the ratio of the largest to smallest SAR for the original and first repeated measurement is not > 1.20 or 3 (1-g or 10-g respectively)

4.5. General description of test procedures

1. The DUT is tested using CMU 200 communications testers as controller unit to set test channels and maximum output power to the DUT, as well as for measuring the conducted peak power.
2. Test positions as described in the tables above are in accordance with the specified test standard.
3. Tests in body position were performed in that configuration, which generates the highest time based averaged output power (see conducted power results).
4. Tests in head position with GSM were performed in voice mode with 1 timeslot unless GPRS/EGPRS/DTM function allows parallel voice and data traffic on 2 or more timeslots.
5. UMTS was tested in RMC mode with 12.2 kbit/s and TPC bits set to 'all 1'.
6. WiFi was tested in 802.11b/g/n mode with 1 Mbit/s and 6 Mbit/s. According to KDB 248227 the SAR testing for 802.11g/n is not required since When the highest reported SAR for DSSS is adjusted by the ratio of OFDM to DSSS specified maximum output power and the adjusted SAR is ≤ 1.2 W/kg.
7. Required WiFi test channels were selected according to KDB 248227
8. According to FCC KDB pub 248227 D01, When there are multiple test channels with the same measured maximum output power, the channel closest to mid-band frequency is selected for SAR measurement and when there are multiple test channels with the same measured maximum output power and equal separation from mid-band frequency; for example, high and low channels or two mid-band channels, the higher frequency (number) channel is selected for SAR measurement.
9. According to FCC KDB pub 941225 D06 this device has been tested with 10 mm distance to the phantom for operation in WiFi hot spot mode.
10. Per FCC KDB pub 941225 D06 the edges with antennas within 2.5 cm are required to be evaluated for SAR to cover WiFi hot spot function.
11. According to IEEE 1528 the SAR test shall be performed at middle channel. Testing of top and bottom channel is optional.
12. According to KDB 447498 D01 testing of other required channels within the operating mode of a frequency band is not required when the reported 1-g or 10-g SAR for the mid-band or highest output power channel is:
 - ≤ 0.8 W/kg or 2.0 W/kg, for 1-g or 10-g respectively, when the transmission band is ≤ 100 MHz
 - ≤ 0.6 W/kg or 1.5 W/kg, for 1-g or 10-g respectively, when the transmission band is between 100 MHz and 200 MHz
 - ≤ 0.4 W/kg or 1.0 W/kg, for 1-g or 10-g respectively, when the transmission band is ≥ 200 MHz





13. IEEE 1528-2003 require the middle channel to be tested first. This generally applies to wireless devices that are designed to operate in technologies with tight tolerances for maximum output power variations across channels in the band.
14. Per KDB648474 D04 require when the reported SAR for a body-worn accessory, measured without a headset connected to the handset, is < 1.2 W/kg.
15. Per KDB648474 D04 require when the separation distance required for body-worn accessory testing is larger than or equal to that tested for hotspot mode, using the same wireless mode test configuration for voice and data, such as UMTS and Wi-Fi, and for the same surface of the phone, the hotspot mode SAR data may be used to support body-worn accessory SAR compliance for that particular configuration (surface)
16. 10-g extremity SAR is required only for the surfaces and edges with hotspot mode 1-g SAR > 1.2 W/kg.
17. Per KDB648474 D04 require for phablet SAR test considerations, For Mobile Phones with a display diagonal dimension > 15.0 cm or an overall diagonal dimension > 16.0 cm, When hotspot mode applies, 10-g extremity SAR is required only for the surfaces and edges with hotspot mode 1-g reported SAR > 1.2 W/kg.
18. 10-g extremity SAR is required only for the surfaces and edges with hotspot mode 1-g SAR > 1.2 W/kg.

4.6. Measurement Uncertainty (450MHz-6GHz)

Not required as SAR measurement uncertainty analysis is required in SAR reports only when the highest measured SAR in a frequency band is ≥ 1.5 W/kg for 1-g SAR according to KDB865664D01.



Shenzhen LCS Compliance Testing Laboratory Ltd.

Add: 101, 201 Bldg A & 301 Bldg C, Juji Industrial Park Yabianxueziwei, Shajing Street, Baoan District, Shenzhen, 518000, China

Tel: +(86) 0755-82591330 | E-mail: webmaster@lcs-cert.com | Web: www.lcs-cert.com

Scan code to check authenticity

4.7. System Check Results

Test mode:2450MHz(Head)
 Product Description:Validation
 Model:Dipole SID2450
 E-Field Probe:SSE2(SN 25/22 EPGO376)
 Test Date: Dec 7, 2023

Medium(liquid type)	HSL_2450
Frequency (MHz)	2450.0000
Relative permittivity (real part)	39.00
Conductivity (S/m)	1.87
Input power	100mW
Crest Factor	1.0
Conversion Factor	2.60
Variation (%)	-0.080000
SAR 10g (W/Kg)	2.518256
SAR 1g (W/Kg)	5.490011
SURFACE SAR	VOLUME SAR

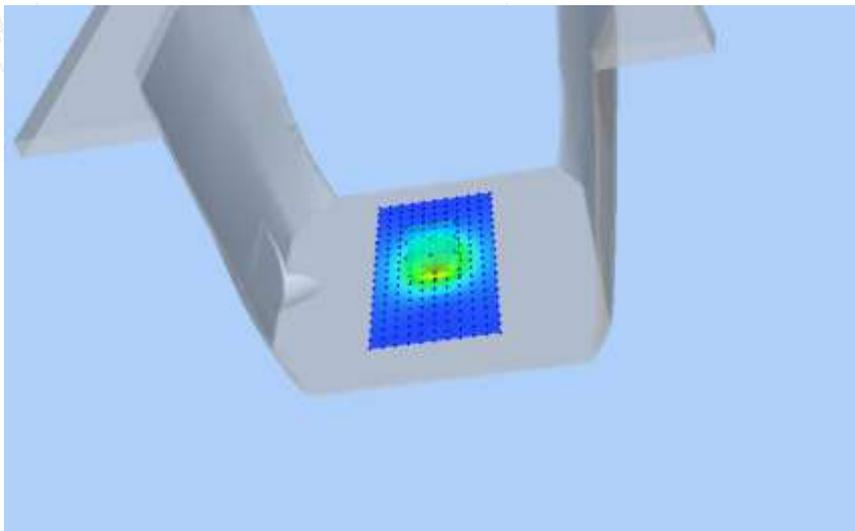
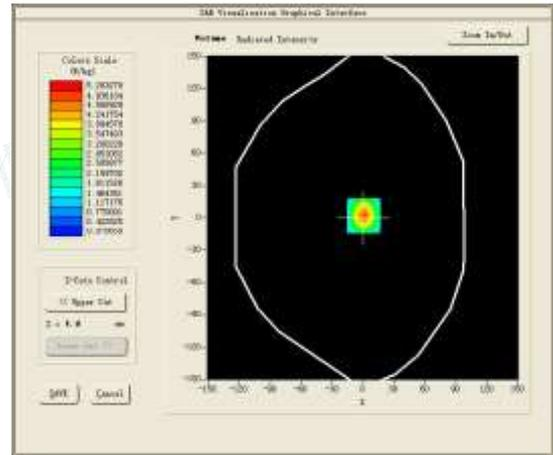
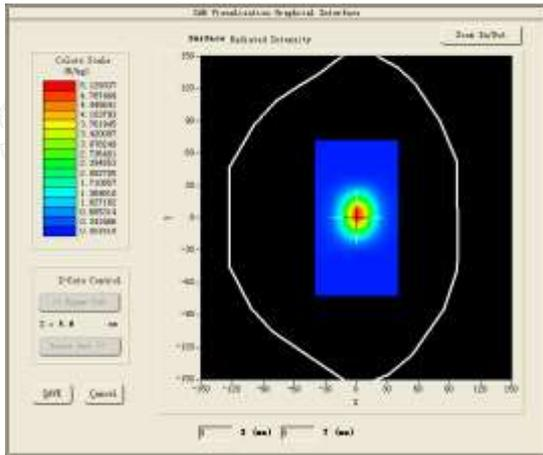

Test mode:5200MHz(Head)
 Product Description:Validation
 Model:Dipole SID5000
 E-Field Probe: SSE2(SN 25/22 EPGO376)
 Test Date: Dec 7, 2023

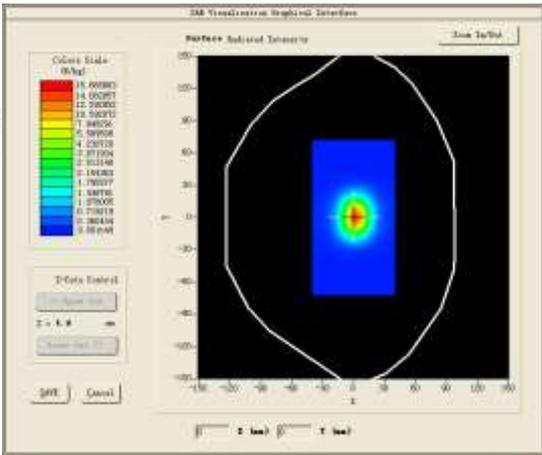
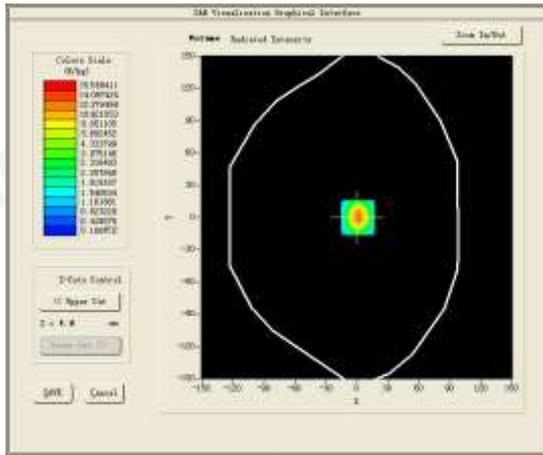
Medium(liquid type)	HSL_5000
Frequency (MHz)	5200.0000
Relative permittivity (real part)	35.2
Conductivity (S/m)	4.68
Input power	100mW
Crest Factor	1.0
Conversion Factor	1.85
Variation (%)	-3.020000
SAR 10g (W/Kg)	5.515236
SAR 1g (W/Kg)	15.788612
SURFACE SAR	VOLUME SAR
	

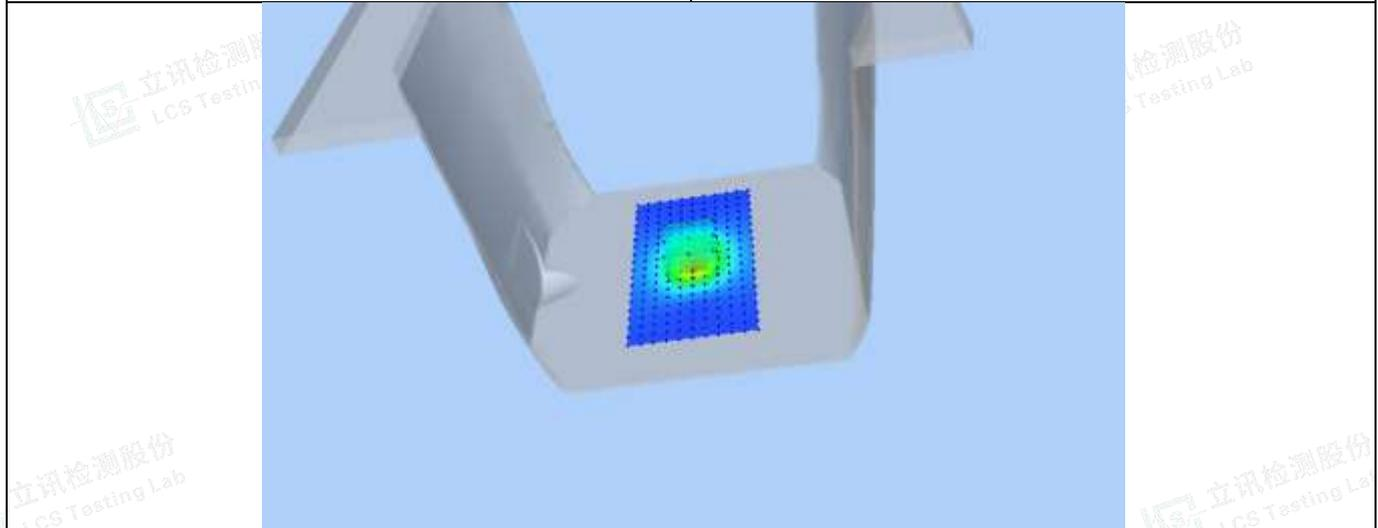

Test mode:5800MHz(Head)
 Product Description:Validation
 Model:Dipole SID5000
 E-Field Probe: SSE2(SN 25/22 EPGO376)
 Test Date: Dec 8, 2023

Medium(liquid type)	HSL_5000
Frequency (MHz)	5800.0000
Relative permittivity (real part)	34.5
Conductivity (S/m)	5.29
Input power	100mW
Crest Factor	1.0
Conversion Factor	2.01
Variation (%)	-1.250000
SAR 10g (W/Kg)	5.895254
SAR 1g (W/Kg)	17.539485

SURFACE SAR

VOLUME SAR

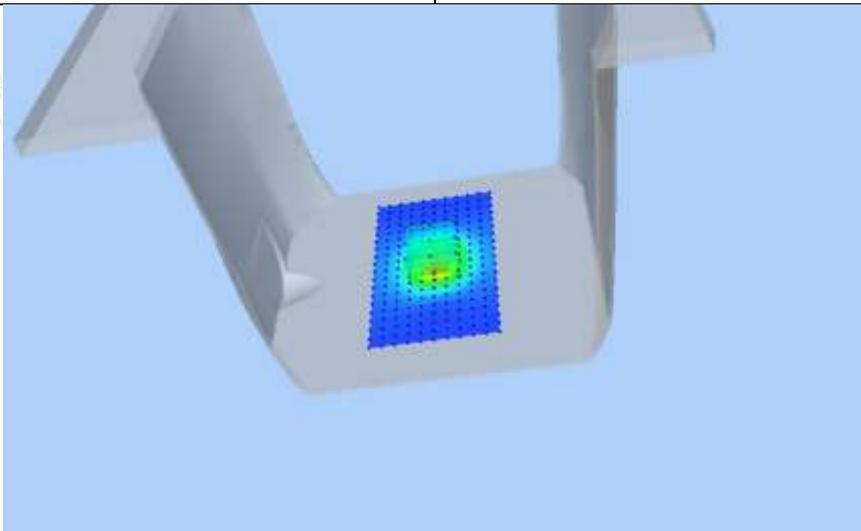
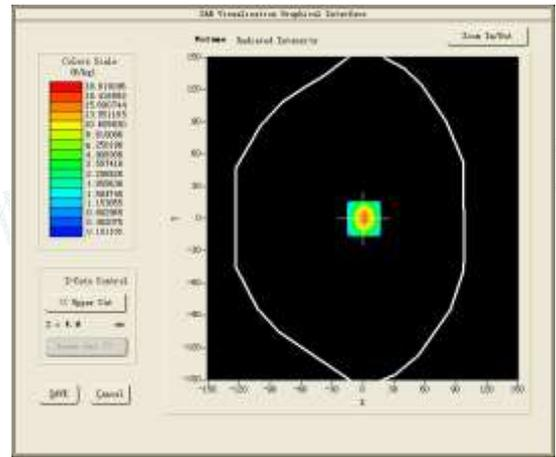
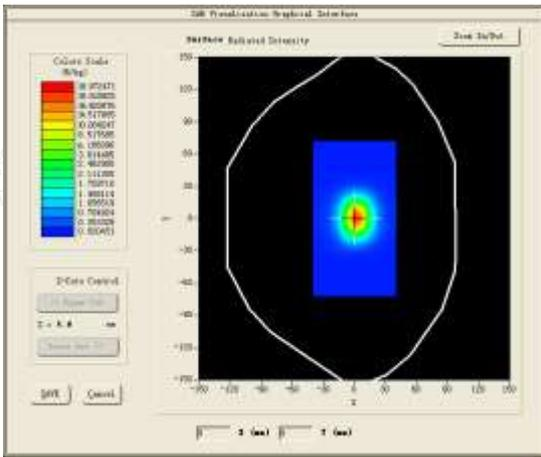

4.8 SAR Test Graph Results

SAR plots for the highest measured SAR in each exposure configuration, wireless mode and frequency band combination according to FCC KDB 865664 D02;

#1

Test Mode: 802.11b (WiFi2.4G), (Body Rear Side) ANT1

Product Description: Laptop

Model:F152A

Test Date: Dec 7, 2023

Medium(liquid type)	HSL_2450
Frequency (MHz)	2412.0000
Relative permittivity (real part)	38.94
Conductivity (S/m)	1.88
E-Field Probe	SN 25/22 EPGO376
Crest Factor	1.0
Conversion Factor	2.60
Sensor	4mm
Area Scan	dx=12mm dy=12mm
Zoom Scan	7x7x7,dx=5mm dy=5mm dz=5mm
Variation (%)	0.420000
SAR 10g (W/Kg)	0.024219
SAR 1g (W/Kg)	0.032413
SURFACE SAR	VOLUME SAR

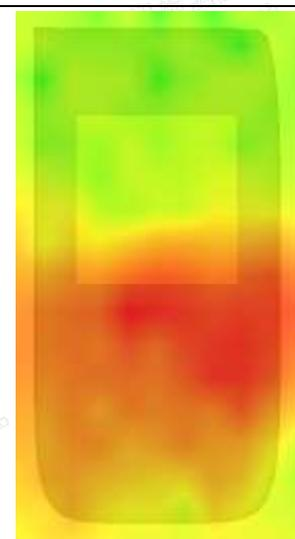
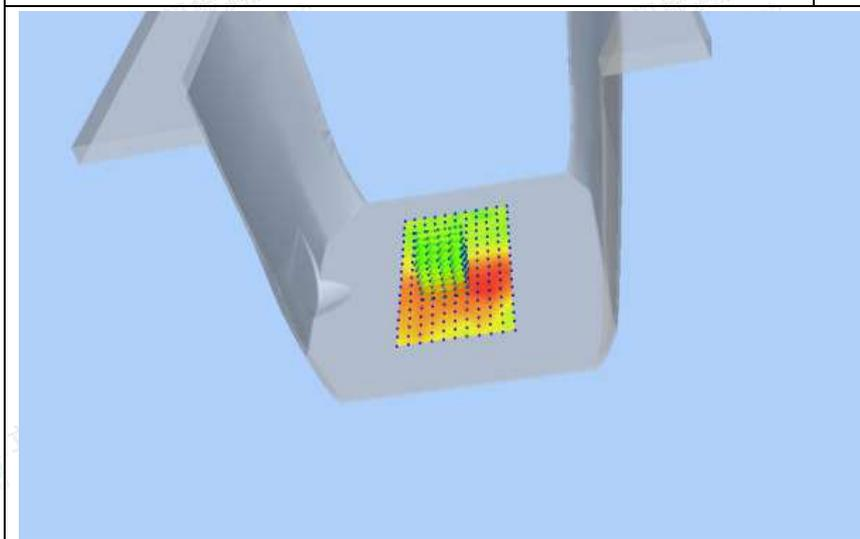
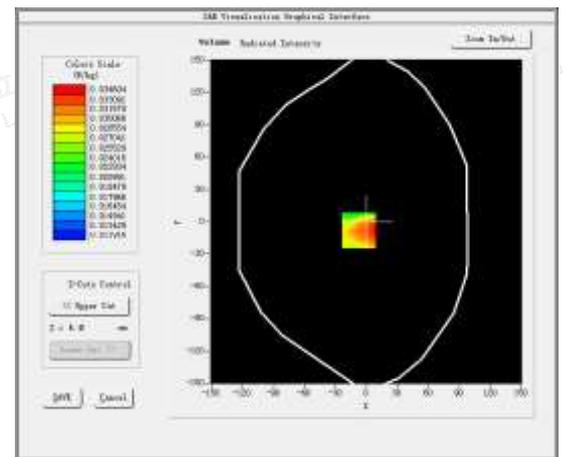
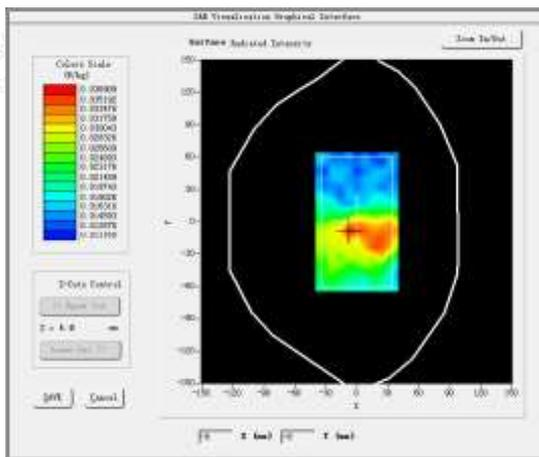

#2

Test Mode: 802.11b (WiFi2.4G), (Body Rear Side) ANT2

Product Description: Laptop

Model:F152A

Test Date: Dec 7, 2023

Medium(liquid type)	HSL_2450
Frequency (MHz)	2412.0000
Relative permittivity (real part)	38.94
Conductivity (S/m)	1.88
E-Field Probe	SN 25/22 EPGO376
Crest Factor	1.0
Conversion Factor	2.60
Sensor	4mm
Area Scan	dx=12mm dy=12mm
Zoom Scan	7x7x7,dx=5mm dy=5mm dz=5mm
Variation (%)	0.420000
SAR 10g (W/Kg)	0.019994
SAR 1g (W/Kg)	0.027221
SURFACE SAR	VOLUME SAR

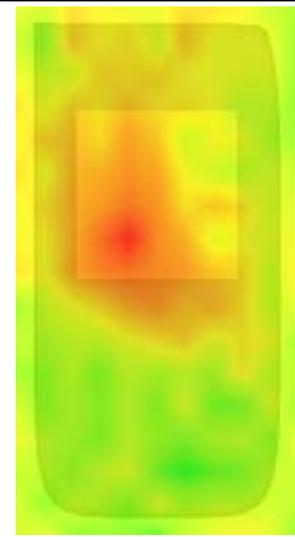
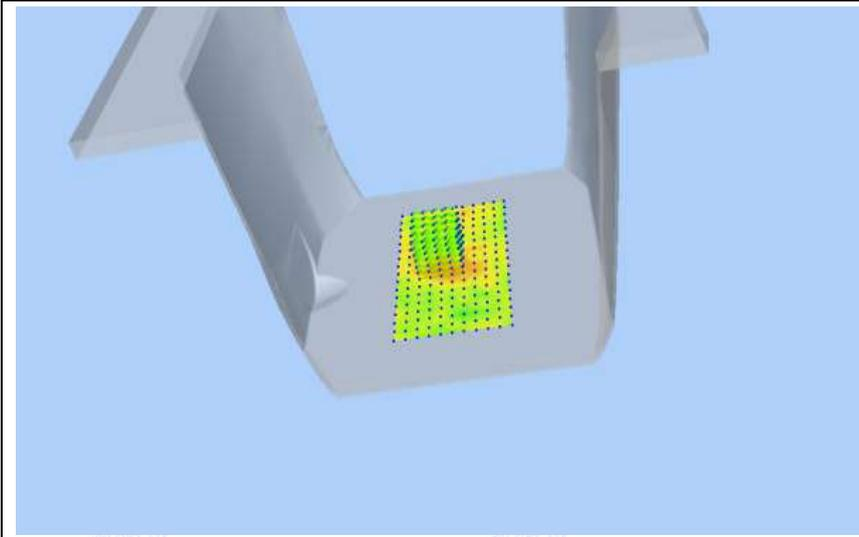
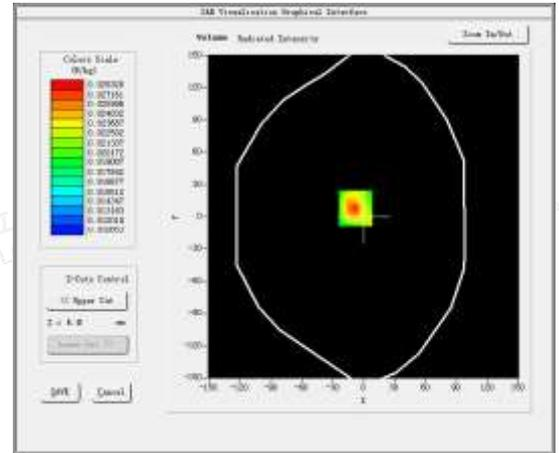
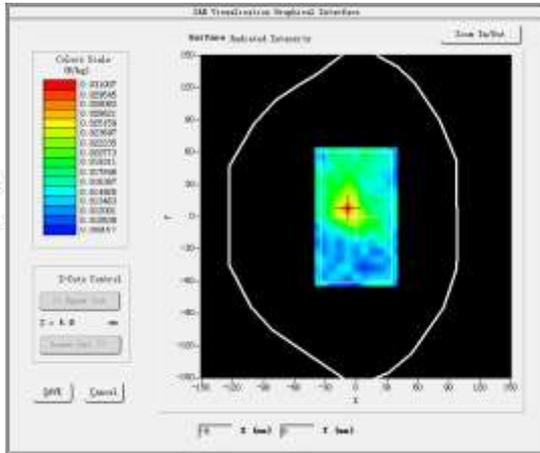

#3

Test Mode: 802.11n HT20 (WiFi5.2G), (Body Rear Side) ANT1

Product Description: Laptop

Model:F152A

Test Date: Dec 7, 2023

Medium(liquid type)	HSL_5200
Frequency (MHz)	5240.0000
Relative permittivity (real part)	35.11
Conductivity (S/m)	4.69
E-Field Probe	SN 25/22 EPGO376
Crest Factor	1.0
Conversion Factor	1.85
Sensor	4mm
Area Scan	dx=10mm dy=10mm
Zoom Scan	7x7x12,dx=4mm dy=4mm dz=2mm
Variation (%)	-0.850000
SAR 10g (W/Kg)	0.054008
SAR 1g (W/Kg)	0.078728
SURFACE SAR	VOLUME SAR

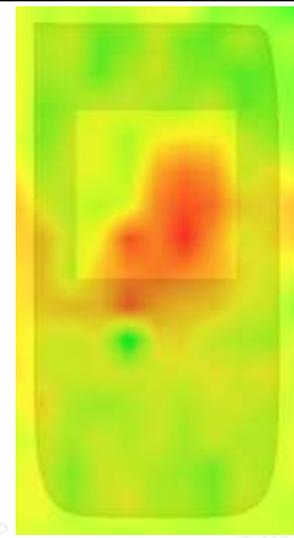
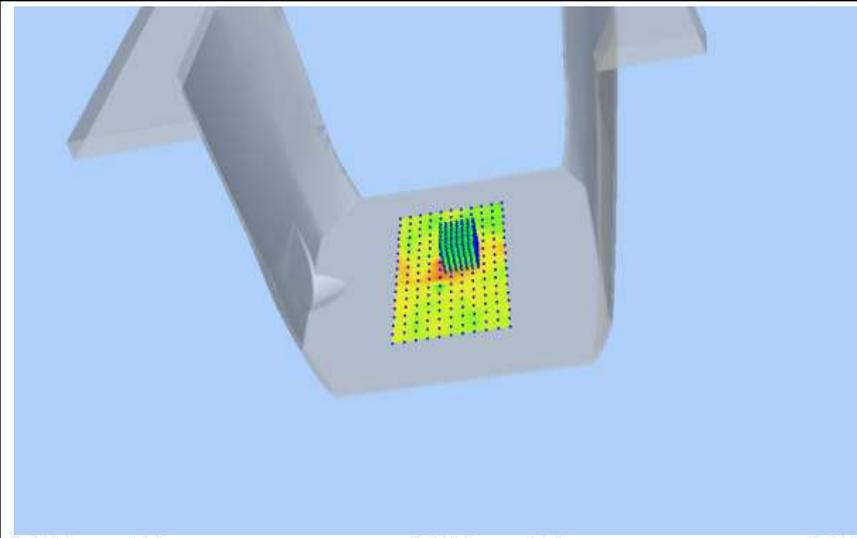
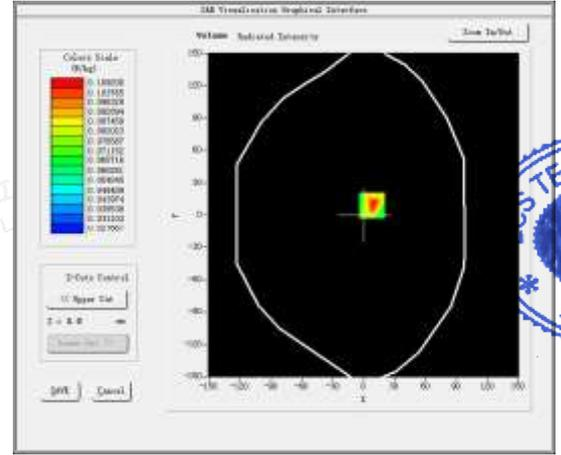
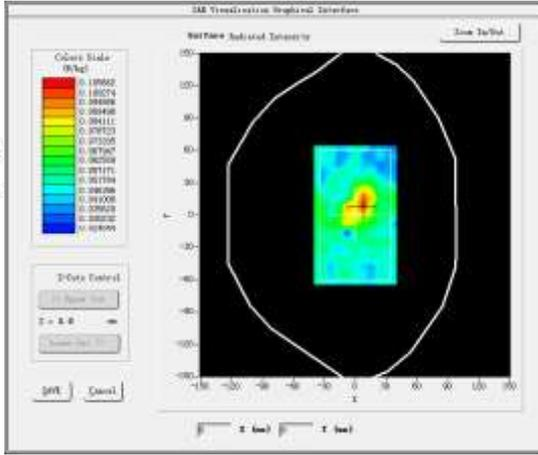

#4

Test Mode: 802.11n HT40 (WiFi5.2G), (Body Rear Side) ANT2

Product Description: Laptop

Model:F152A

Test Date: Dec 7, 2023

Medium(liquid type)	HSL_5200
Frequency (MHz)	5230.0000
Relative permittivity (real part)	35.11
Conductivity (S/m)	4.69
E-Field Probe	SN 25/22 EPGO376
Crest Factor	1.0
Conversion Factor	1.85
Sensor	4mm
Area Scan	dx=10mm dy=10mm
Zoom Scan	7x7x12,dx=4mm dy=4mm dz=2mm
Variation (%)	-0.850000
SAR 10g (W/Kg)	0.047857
SAR 1g (W/Kg)	0.057029
SURFACE SAR	VOLUME SAR

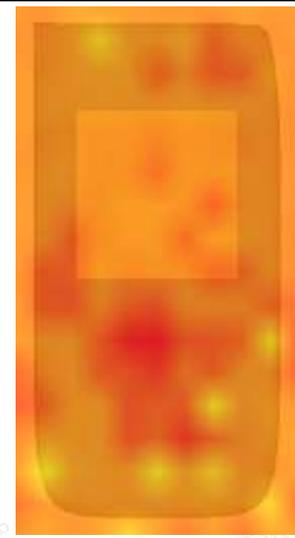
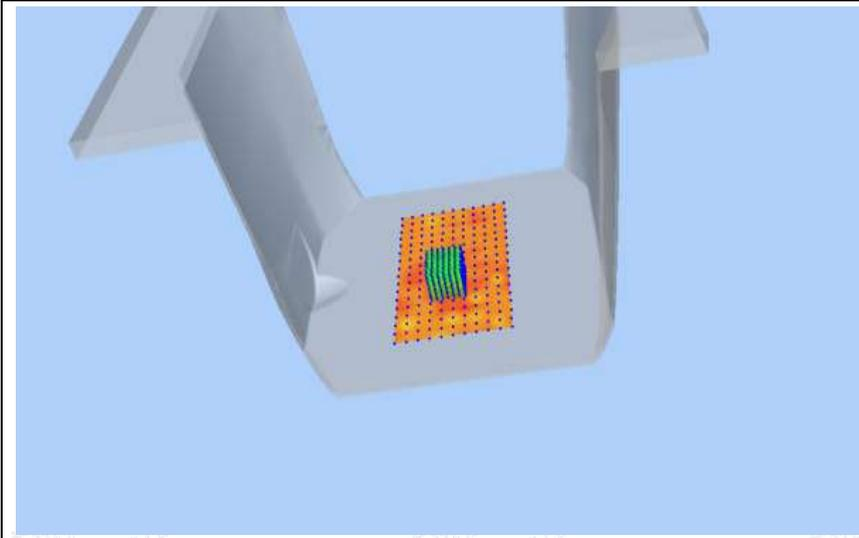
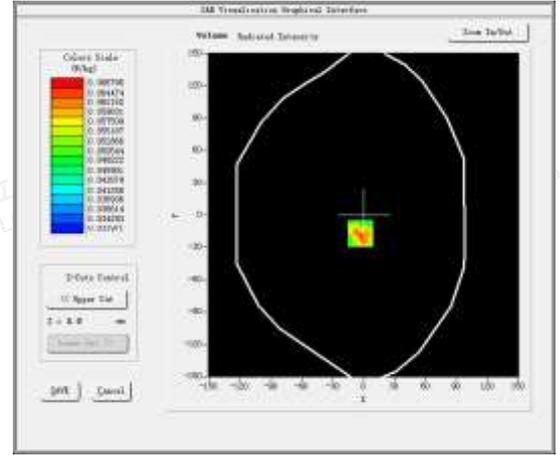
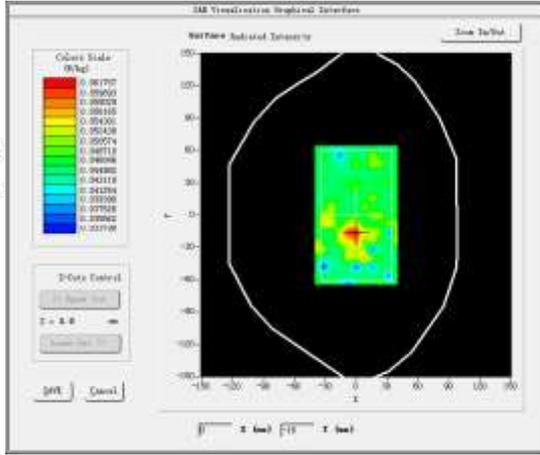

#5

Test Mode: 802.11ac(40MHz) (WiFi5.8G), (Body Rear Side) ANT1

Product Description: Laptop

Model:F152A

Test Date: Dec 8, 2023

Medium(liquid type)	HSL_5800
Frequency (MHz)	5755.0000
Relative permittivity (real part)	34.36
Conductivity (S/m)	5.32
E-Field Probe	SN 25/22 EPGO376
Crest Factor	1.0
Conversion Factor	2.01
Sensor	4mm
Area Scan	dx=10mm dy=10mm
Zoom Scan	7x7x12,dx=4mm dy=4mm dz=2mm
Variation (%)	-0.940000
SAR 10g (W/Kg)	0.070743
SAR 1g (W/Kg)	0.102616
SURFACE SAR	VOLUME SAR

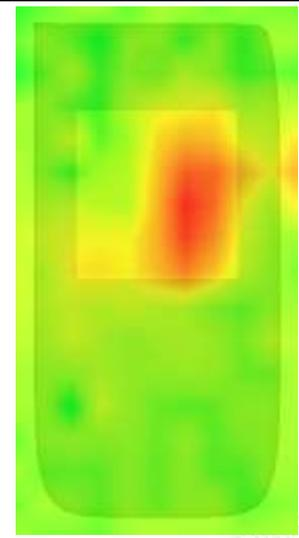
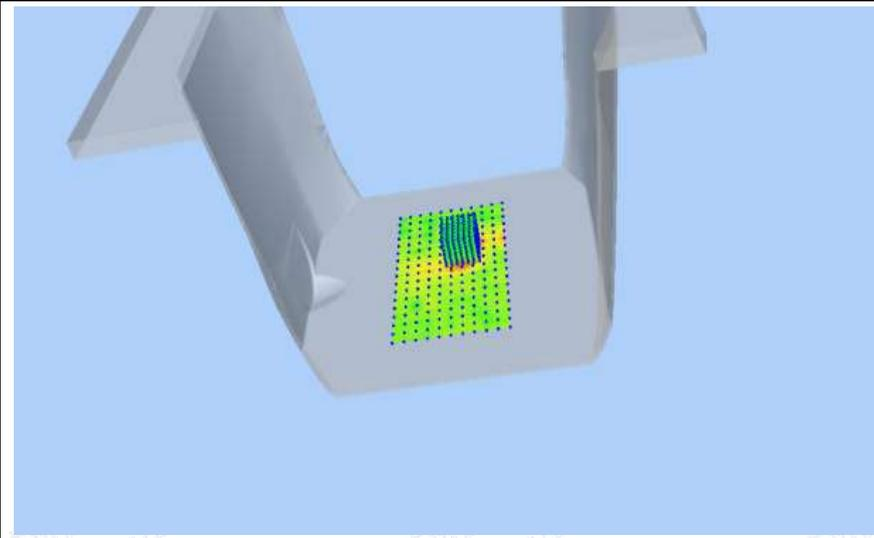
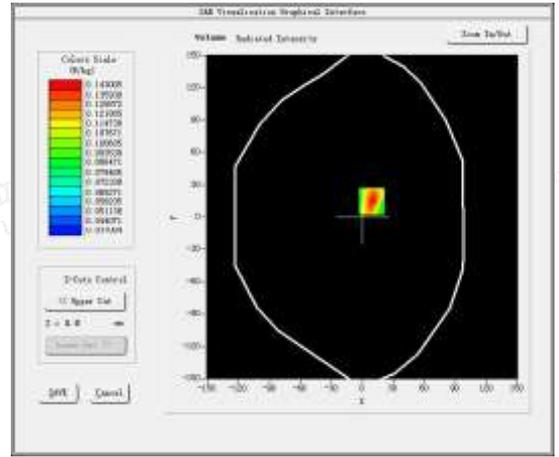
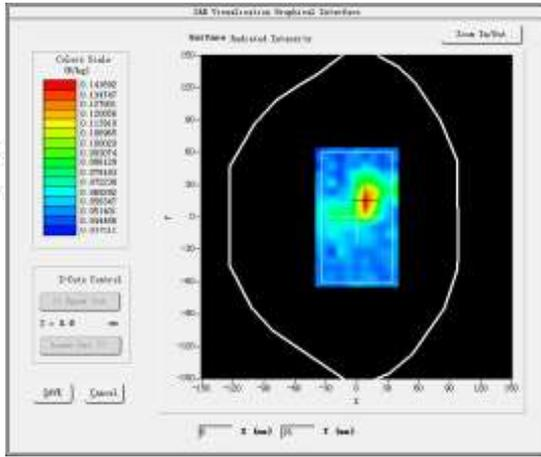

#6

Test Mode: 802.11a (WiFi5.8G), (Body Rear Side) ANT2

Product Description: Laptop

Model:F152A

Test Date: Dec 8, 2023

Medium(liquid type)	HSL_5800
Frequency (MHz)	5825.0000
Relative permittivity (real part)	34.36
Conductivity (S/m)	5.32
E-Field Probe	SN 25/22 EPGO376
Crest Factor	1.0
Conversion Factor	2.01
Sensor	4mm
Area Scan	dx=10mm dy=10mm
Zoom Scan	7x7x12,dx=4mm dy=4mm dz=2mm
Variation (%)	-0.940000
SAR 10g (W/Kg)	0.051232
SAR 1g (W/Kg)	0.061825
SURFACE SAR	VOLUME SAR

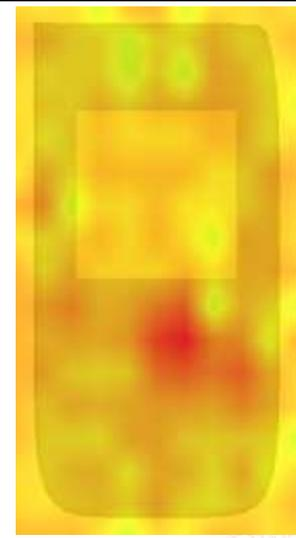
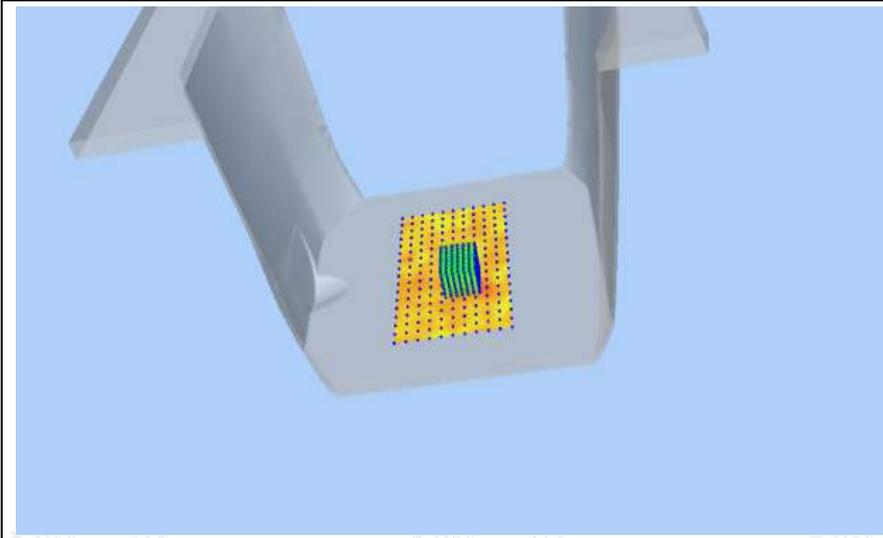
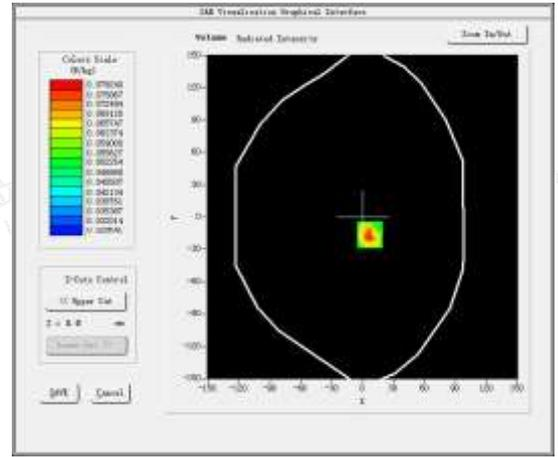
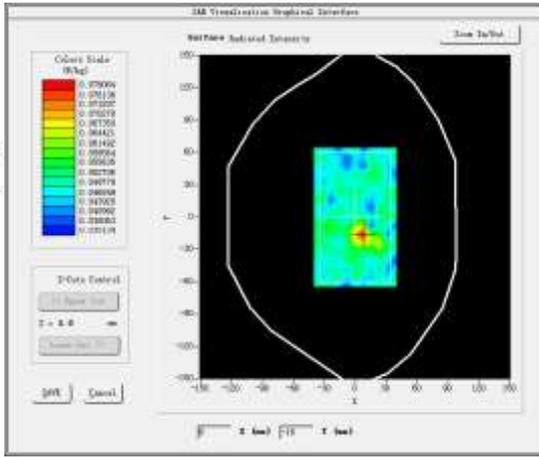

5. CALIBRATION CERTIFICATES

5.1 Probe-EPGO376 Calibration Certificate



COMOSAR E-Field Probe Calibration Report

Ref : ACR.180.4.42.BES.A

**SHENZHEN LCS COMPLIANCE TESTING
LABORATORY LTD.**
1F., XINGYUAN INDUSTRIAL PARK, TONGDA ROAD, BAO'AN
BLVD
BAO'AN DISTRICT, SHENZHEN, GUANGDONG, CHINA
MVG COMOSAR DOSIMETRIC E-FIELD PROBE
SERIAL NO.: SN 25/22 EPGO376

Calibrated at MVG
Z.I. de la pointe du diable
Technopôle Brest Iroise – 295 avenue Alexis de Rochon
29280 PLOUZANE - FRANCE

Calibration date: 06/22/2023



Accreditations #2-6792
Scope available on www.cofrac.fr

The use of the Cofrac brand and the accreditation references is prohibited from any reproduction.

Summary:

This document presents the method and results from an accredited COMOSAR Dosimetric E-Field Probe calibration performed at MVG, using the CALIPROBE test bench, for use with a MVG COMOSAR system only. The test results covered by accreditation are traceable to the International System of Units (SI).





COMOSAR E-FIELD PROBE CALIBRATION REPORT

Ref: ACR.180.4.42.BES.A

	<i>Name</i>	<i>Function</i>	<i>Date</i>	<i>Signature</i>
<i>Prepared by :</i>	Jérôme Le Gall	Measurement Responsible	6/23/2023	
<i>Checked & approved by:</i>	Jérôme Luc	Technical Manager	6/23/2023	
<i>Authorized by:</i>	Yann Toutain	Laboratory Director	6/23/2023	

2023.06.23
13:37:50 +02'03'

	<i>Customer Name</i>
<i>Distribution :</i>	Shenzhen LCS Compliance Testing Laboratory Ltd.

<i>Issue</i>	<i>Name</i>	<i>Date</i>	<i>Modifications</i>
A	Jérôme Le Gall	6/23/2023	Initial release





COMOSAR E-FIELD PROBE CALIBRATION REPORT

Ref: ACR.180.442.BES.A

TABLE OF CONTENTS

1 Device Under Test 4

2 Product Description 4

 2.1 General Information 4

3 Measurement Method 4

 3.1 Linearity 4

 3.2 Sensitivity 4

 3.3 Lower Detection Limit 5

 3.4 Isotropy 5

 3.1 Boundary Effect 5

4 Measurement Uncertainty 6

5 Calibration Measurement Results 6

 5.1 Sensitivity in air 6

 5.2 Linearity 7

 5.3 Sensitivity in liquid 8

 5.4 Isotropy 9

6 List of Equipment 10



Template_ACR.DDD.N.YY.MVGB.ISSUE_COMOSAR Probe vK

This document shall not be reproduced, except in full or in part, without the written approval of MVG. The information contained herein is to be used only for the purpose for which it is submitted and is not to be released in whole or part without written approval of MVG.





COMOSAR E-FIELD PROBE CALIBRATION REPORT

Ref: ACR.180.442.BES.A

1 DEVICE UNDER TEST

Device Under Test	
Device Type	COMOSAR DOSIMETRIC E FIELD PROBE
Manufacturer	MVG
Model	SSE2
Serial Number	SN 25/22 EPGO376
Product Condition (new / used)	New
Frequency Range of Probe	0.15 GHz-6GHz
Resistance of Three Dipoles at Connector	Dipole 1: R1=0.193 MΩ Dipole 2: R2=0.188 MΩ Dipole 3: R3=0.198 MΩ

2 PRODUCT DESCRIPTION

2.1 GENERAL INFORMATION

MVG's COMOSAR E field Probes are built in accordance to the IEC/IEEE 62209-1528 and FCC KDB865664 D01 standards.



Figure 1 – MVG COMOSAR Dosimetric E field Probe

Probe Length	330 mm
Length of Individual Dipoles	2 mm
Maximum external diameter	8 mm
Probe Tip External Diameter	2.5 mm
Distance between dipoles / probe extremity	1 mm

3 MEASUREMENT METHOD

The IEC/IEEE 62209-1528 and FCC KDB865664 D01 standards provide recommended practices for the probe calibrations, including the performance characteristics of interest and methods by which to assess their affect. All calibrations / measurements performed meet the fore mentioned standards.

3.1 LINEARITY

The evaluation of the linearity was done in free space using the waveguide, performing a power sweep to cover the SAR range 0.01W/kg to 100W/kg.

3.2 SENSITIVITY

The sensitivity factors of the three dipoles were determined using a two step calibration method (air and tissue simulating liquid) using waveguides as outlined in the standards.

Page: 4/11

Template_ACR.DDD.N.YY.MVGB.ISSUE_COMOSAR Probe vK

This document shall not be reproduced, except in full or in part, without the written approval of MVG. The information contained herein is to be used only for the purpose for which it is submitted and is not to be released in whole or part without written approval of MVG.





3.3 LOWER DETECTION LIMIT

The lower detection limit was assessed using the same measurement set up as used for the linearity measurement. The required lower detection limit is 10 mW/kg.

3.4 ISOTROPY

The axial isotropy was evaluated by exposing the probe to a reference wave from a standard dipole with the dipole mounted under the flat phantom in the test configuration suggested for system validations and checks. The probe was rotated along its main axis from 0 to 360 degrees in 15-degree steps. The hemispherical isotropy is determined by inserting the probe in a thin plastic box filled with tissue-equivalent liquid, with the plastic box illuminated with the fields from a half wave dipole. The dipole is rotated about its axis (0°–180°) in 15° increments. At each step the probe is rotated about its axis (0°–360°).

3.1 BOUNDARY EFFECT

The boundary effect is defined as the deviation between the SAR measured data and the expected exponential decay in the liquid when the probe is oriented normal to the interface. To evaluate this effect, the liquid filled flat phantom is exposed to fields from either a reference dipole or waveguide. With the probe normal to the phantom surface, the peak spatial average SAR is measured and compared to the analytical value at the surface.

The boundary effect uncertainty can be estimated according to the following uncertainty approximation formula based on linear and exponential extrapolations between the surface and $d_{be} + d_{step}$ along lines that are approximately normal to the surface:

$$SAR_{uncertainty}[\%] = \Delta SAR_{be} \frac{(d_{be} + d_{step})^2}{2d_{step}} \frac{(e^{-d_{be}/\delta})}{\delta/2} \text{ for } (d_{be} + d_{step}) < 10 \text{ mm}$$

where

$SAR_{uncertainty}$	is the uncertainty in percent of the probe boundary effect
d_{be}	is the distance between the surface and the closest <i>zoom-scan</i> measurement point, in millimetre
Δ_{step}	is the separation distance between the first and second measurement points that are closest to the phantom surface, in millimetre, assuming the boundary effect at the second location is negligible
δ	is the minimum penetration depth in millimetres of the head tissue-equivalent liquids defined in this standard, i.e., $\delta \approx 14$ mm at 3 GHz;
ΔSAR_{be}	in percent of SAR is the deviation between the measured SAR value, at the distance d_{be} from the boundary, and the analytical SAR value.

The measured worst case boundary effect SAR uncertainty[%] for scanning distances larger than 4mm is 1.0% Limit (2%).





4 MEASUREMENT UNCERTAINTY

The guidelines outlined in the IEC/IEEE 62209-1528 and FCC KDB865664 D01 standards were followed to generate the measurement uncertainty associated with an E-field probe calibration using the waveguide technique. All uncertainties listed below represent an expanded uncertainty expressed at approximately the 95% confidence level using a coverage factor of k=2, traceable to the Internationally Accepted Guides to Measurement Uncertainty.

Uncertainty analysis of the probe calibration in waveguide					
ERROR SOURCES	Uncertainty value (%)	Probability Distribution	Divisor	ci	Standard Uncertainty (%)
Expanded uncertainty 95 % confidence level k = 2					14 %

5 CALIBRATION MEASUREMENT RESULTS

Calibration Parameters	
Liquid Temperature	20 +/- 1 °C
Lab Temperature	20 +/- 1 °C
Lab Humidity	30-70 %

5.1 SENSITIVITY IN AIR

Normx dipole 1 (μV/(V/m) ²)	Normy dipole 2 (μV/(V/m) ²)	Normz dipole 3 (μV/(V/m) ²)
0.76	0.78	0.76

DCP dipole 1 (mV)	DCP dipole 2 (mV)	DCP dipole 3 (mV)
106	107	108

Calibration curves $e_i=f(V)$ ($i=1,2,3$) allow to obtain E-field value using the formula:

$$E = \sqrt{E_1^2 + E_2^2 + E_3^2}$$





COMOSAR E-FIELD PROBE CALIBRATION REPORT

Ref: ACR.180.442.BES.A

Calibration curves

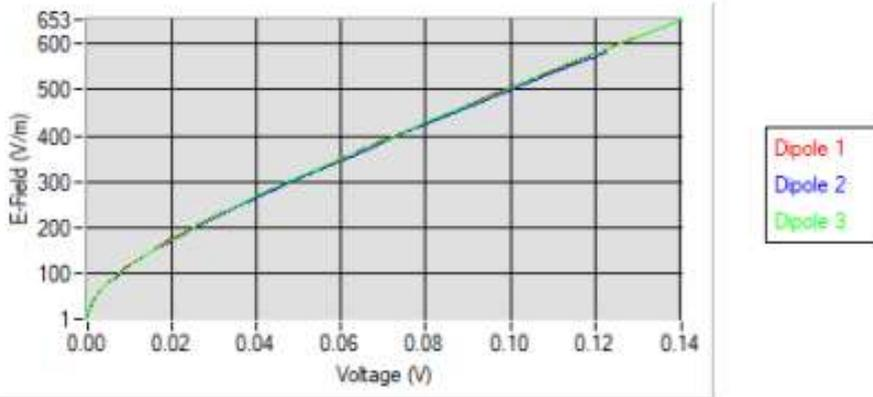

5.2 LINEARITY

Linearity

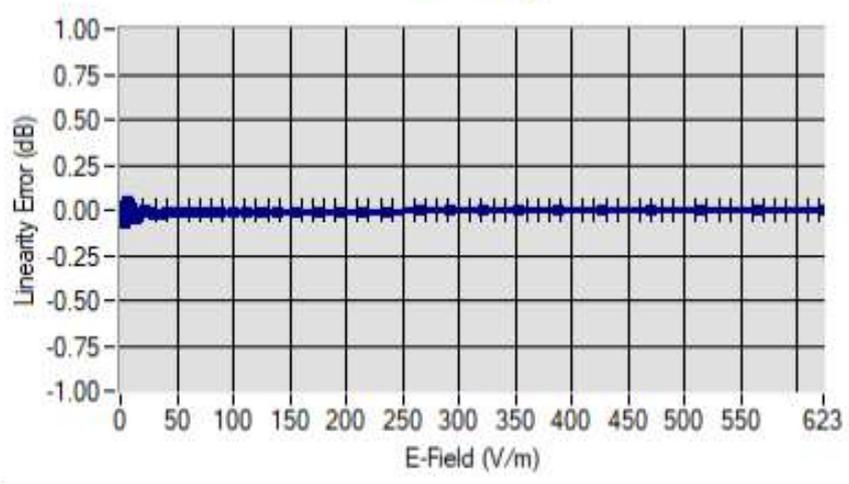

Linearity: +/-1.81% (+/-0.08dB)

Template_ACR.DDD.N.YY.MVGB.ISSUE_COMOSAR Probe vK

This document shall not be reproduced, except in full or in part, without the written approval of MVG. The information contained herein is to be used only for the purpose for which it is submitted and is not to be released in whole or part without written approval of MVG.





COMOSAR E-FIELD PROBE CALIBRATION REPORT

Ref: ACR.180.4.42.BES.A

5.3 SENSITIVITY IN LIQUID

Liquid	Frequency (MHz +/- 100MHz)	ConvF
HL450*	450*	1.74*
BL450*	450*	1.67*
HL750	750	1.69
BL750	750	1.73
HL850	835	1.75
BL850	835	1.80
HL900	900	1.87
BL900	900	1.85
HL1800	1800	2.09
BL1800	1800	2.15
HL1900	1900	2.14
BL1900	1900	2.27
HL2000	2000	2.31
BL2000	2000	2.34
HL2300	2300	2.46
BL2300	2300	2.51
HL2450	2450	2.60
BL2450	2450	2.70
HL2600	2600	2.39
BL2600	2600	2.50
HL5200	5200	1.85
BL5200	5200	1.81
HL5400	5400	2.07
BL5400	5400	2.00
HL5600	5600	2.19
BL5600	5600	2.11
HL5800	5800	2.01
BL5800	5800	1.97

* Frequency not cover by COFRAC scope, calibration not accredited

LOWER DETECTION LIMIT: 7mW/kg





COMOSAR E-FIELD PROBE CALIBRATION REPORT

Ref: ACR.180.4.42.BES.A

5.4 ISOTROPY

HL1800 MHz

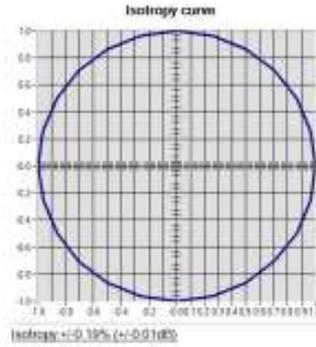



COMOSAR E-FIELD PROBE CALIBRATION REPORT

Ref: ACR.180.4.42.BES.A

6 LIST OF EQUIPMENT

Equipment Summary Sheet				
Equipment Description	Manufacturer / Model	Identification No.	Current Calibration Date	Next Calibration Date
CALIPROBE Test Bench	Version 2	NA	Validated. No cal required.	Validated. No cal required.
Network Analyzer	Rohde & Schwarz ZVM	100203	08/2021	08/2024
Network Analyzer	Agilent 8753ES	MY40003210	10/2022	10/2025
Network Analyzer – Calibration kit	HP 85033D	3423A08186	06/2021	06/2027
Multimeter	Keithley 2000	1160271	02/2023	02/2026
Signal Generator	Rohde & Schwarz SMB	106589	03/2022	03/2025
Amplifier	MVG	MODU-023-C-0002	Characterized prior to test. No cal required.	Characterized prior to test. No cal required.
Power Meter	NI-USB 5680	170100013	06/2021	06/2024
Power Meter	Rohde & Schwarz NRVD	832839-056	11/2022	11/2025
Directional Coupler	Krytar 158020	131467	Characterized prior to test. No cal required.	Characterized prior to test. No cal required.
Waveguide	MVG	SN 32/16 WG4_1	Validated. No cal required.	Validated. No cal required.
Liquid transition	MVG	SN 32/16 WGLIQ_0G900_1	Validated. No cal required.	Validated. No cal required.
Waveguide	MVG	SN 32/16 WG6_1	Validated. No cal required.	Validated. No cal required.
Liquid transition	MVG	SN 32/16 WGLIQ_1G500_1	Validated. No cal required.	Validated. No cal required.
Waveguide	MVG	SN 32/16 WG8_1	Validated. No cal required.	Validated. No cal required.
Liquid transition	MVG	SN 32/16 WGLIQ_1G800B_1	Validated. No cal required.	Validated. No cal required.
Liquid transition	MVG	SN 32/16 WGLIQ_1G800H_1	Validated. No cal required.	Validated. No cal required.
Waveguide	MVG	SN 32/16 WG10_1	Validated. No cal required.	Validated. No cal required.
Liquid transition	MVG	SN 32/16 WGLIQ_3G500_1	Validated. No cal required.	Validated. No cal required.
Waveguide	MVG	SN 32/16 WG12_1	Validated. No cal required.	Validated. No cal required.

Page: 10/11

Template_ACR.DDD.N.YY.MVGB.ISSUE_COMOSAR Probe vK

This document shall not be reproduced, except in full or in part, without the written approval of MVG. The information contained herein is to be used only for the purpose for which it is submitted and is not to be released in whole or part without written approval of MVG.





COMOSAR E-FIELD PROBE CALIBRATION REPORT

Ref: ACR.180.4.42.BES.A

Liquid transition	MVG	SN 32/16 WGLIQ_5G000_1	Validated. No cal required.	Validated. No cal required.
Temperature / Humidity Sensor	Testo 184 H1	44225320	06/2021	06/2024

Template_ACR.DDD.N.YY.MVGB.ISSUE_COMOSAR Probe vK

This document shall not be reproduced, except in full or in part, without the written approval of MVG. The information contained herein is to be used only for the purpose for which it is submitted and is not to be released in whole or part without written approval of MVG.





5.2 SID2450 Dipole Calibration Certificate



SAR Reference Dipole Calibration Report

Ref : ACR.287.8.14.SATU.A

**SHENZHEN LCS COMPLIANCE TESTING
LABORATORY LTD.**
**1F., XINGYUAN INDUSTRIAL PARK, TONGDA ROAD,
BAO'AN BLVD**
BAO'AN DISTRICT, SHENZHEN, GUANGDONG, CHINA
SATIMO COMOSAR REFERENCE DIPOLE
FREQUENCY: 2450 MHZ
SERIAL NO.: SN 07/14 DIP 2G450-306

Calibrated at SATIMO US
2105 Barrett Park Dr. - Kennesaw, GA 30144



09/29/2021

Summary:

This document presents the method and results from an accredited SAR reference dipole calibration performed in SATIMO USA using the COMOSAR test bench. All calibration results are traceable to national metrology institutions.





SAR REFERENCE DIPOLE CALIBRATION REPORT

Ref: ACR.287.8.14.SATU.A

	<i>Name</i>	<i>Function</i>	<i>Date</i>	<i>Signature</i>
<i>Prepared by :</i>	Jérôme LUC	Product Manager	10/12/2021	<i>JS</i>
<i>Checked by :</i>	Jérôme LUC	Product Manager	10/12/2021	<i>JS</i>
<i>Approved by :</i>	Kim RUTKOWSKI	Quality Manager	10/12/2021	<i>Kim Rutkowski</i>

	<i>Customer Name</i>
<i>Distribution :</i>	Shenzhen LCS Compliance Testing Laboratory Ltd.

<i>Issue</i>	<i>Date</i>	<i>Modifications</i>
A	10/12/2021	Initial release

This document shall not be reproduced, except in full or in part, without the written approval of SATIMO. The information contained herein is to be used only for the purpose for which it is submitted and is not to be released in whole or part without written approval of SATIMO.





TABLE OF CONTENTS

1 Introduction.....4

2 Device Under Test.....4

3 Product Description4

 3.1 General Information 4

4 Measurement Method 5

 4.1 Return Loss Requirements 5

 4.2 Mechanical Requirements 5

5 Measurement Uncertainty..... 5

 5.1 Return Loss 5

 5.2 Dimension Measurement 5

 5.3 Validation Measurement 5

6 Calibration Measurement Results..... 6

 6.1 Return Loss and Impedance 6

 6.2 Mechanical Dimensions 6

7 Validation measurement 7

 7.1 Head Liquid Measurement 7

 7.2 SAR Measurement Result With Head Liquid 7

 7.3 Body Liquid Measurement 9

 7.4 SAR Measurement Result With Body Liquid 9

8 List of Equipment 11

This document shall not be reproduced, except in full or in part, without the written approval of SATIMO. The information contained herein is to be used only for the purpose for which it is submitted and is not to be released in whole or part without written approval of SATIMO.





1 INTRODUCTION

This document contains a summary of the requirements set forth by the IEEE 1528, OET 65 Bulletin C and CEI/IEC 62209 standards for reference dipoles used for SAR measurement system validations and the measurements that were performed to verify that the product complies with the fore mentioned standards.

2 DEVICE UNDER TEST

Device Under Test	
Device Type	COMOSAR 2450 MHz REFERENCE DIPOLE
Manufacturer	Satimo
Model	SID2450
Serial Number	SN 07/14 DIP 2G450-306
Product Condition (new / used)	New

A yearly calibration interval is recommended.

3 PRODUCT DESCRIPTION

3.1 GENERAL INFORMATION

Satimo's COMOSAR Validation Dipoles are built in accordance to the IEEE 1528, OET 65 Bulletin C and CEI/IEC 62209 standards. The product is designed for use with the COMOSAR test bench only.

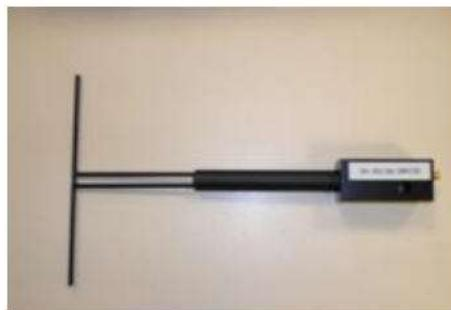

Figure 1 – Satimo COMOSAR Validation Dipole

Page: 4/11

*This document shall not be reproduced, except in full or in part, without the written approval of SATIMO.
The information contained herein is to be used only for the purpose for which it is submitted and is not to be released in whole or part without written approval of SATIMO.*





4 MEASUREMENT METHOD

The IEEE 1528, OET 65 Bulletin C and CEI/IEC 62209 standards provide requirements for reference dipoles used for system validation measurements. The following measurements were performed to verify that the product complies with the fore mentioned standards.

4.1 RETURN LOSS REQUIREMENTS

The dipole used for SAR system validation measurements and checks must have a return loss of -20 dB or better. The return loss measurement shall be performed against a liquid filled flat phantom, with the phantom constructed as outlined in the fore mentioned standards.

4.2 MECHANICAL REQUIREMENTS

The IEEE Std. 1528 and CEI/IEC 62209 standards specify the mechanical components and dimensions of the validation dipoles, with the dimensions frequency and phantom shell thickness dependent. The COMOSAR test bench employs a 2 mm phantom shell thickness therefore the dipoles sold for use with the COMOSAR test bench comply with the requirements set forth for a 2 mm phantom shell thickness.

5 MEASUREMENT UNCERTAINTY

All uncertainties listed below represent an expanded uncertainty expressed at approximately the 95% confidence level using a coverage factor of k=2, traceable to the Internationally Accepted Guides to Measurement Uncertainty.

5.1 RETURN LOSS

The following uncertainties apply to the return loss measurement:

Frequency band	Expanded Uncertainty on Return Loss
400-6000MHz	0.1 dB

5.2 DIMENSION MEASUREMENT

The following uncertainties apply to the dimension measurements:

Length (mm)	Expanded Uncertainty on Length
3 - 300	0.05 mm

5.3 VALIDATION MEASUREMENT

The guidelines outlined in the IEEE 1528, OET 65 Bulletin C, CENELEC EN50361 and CEI/IEC 62209 standards were followed to generate the measurement uncertainty for validation measurements.

Scan Volume	Expanded Uncertainty
1 g	20.3 %
10 g	20.1 %

Page: 5/11

This document shall not be reproduced, except in full or in part, without the written approval of SATIMO. The information contained herein is to be used only for the purpose for which it is submitted and is not to be released in whole or part without written approval of SATIMO.





6 CALIBRATION MEASUREMENT RESULTS

6.1 RETURN LOSS AND IMPEDANCE

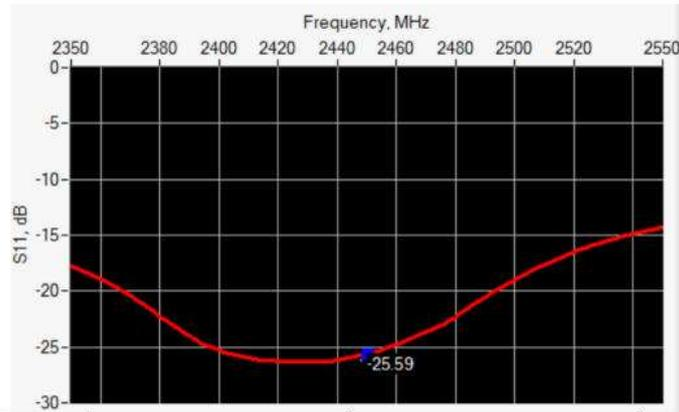

Frequency (MHz)	Return Loss (dB)	Requirement (dB)	Impedance
2450	-25.59	-20	44.7 Ω - 1.1 jΩ

6.2 MECHANICAL DIMENSIONS

Frequency MHz	L mm		h mm		d mm	
	required	measured	required	measured	required	measured
300	420.0 ±1 %.		250.0 ±1 %.		6.35 ±1 %.	
450	290.0 ±1 %.		166.7 ±1 %.		6.35 ±1 %.	
750	176.0 ±1 %.		100.0 ±1 %.		6.35 ±1 %.	
835	161.0 ±1 %.		89.8 ±1 %.		3.6 ±1 %.	
900	149.0 ±1 %.		83.3 ±1 %.		3.6 ±1 %.	
1450	89.1 ±1 %.		51.7 ±1 %.		3.6 ±1 %.	
1500	80.5 ±1 %.		50.0 ±1 %.		3.6 ±1 %.	
1640	79.0 ±1 %.		45.7 ±1 %.		3.6 ±1 %.	
1750	75.2 ±1 %.		42.9 ±1 %.		3.6 ±1 %.	
1800	72.0 ±1 %.		41.7 ±1 %.		3.6 ±1 %.	
1900	68.0 ±1 %.		39.5 ±1 %.		3.6 ±1 %.	
1950	66.3 ±1 %.		38.5 ±1 %.		3.6 ±1 %.	
2000	64.5 ±1 %.		37.5 ±1 %.		3.6 ±1 %.	
2100	61.0 ±1 %.		35.7 ±1 %.		3.6 ±1 %.	
2300	55.5 ±1 %.		32.6 ±1 %.		3.6 ±1 %.	
2450	51.5 ±1 %.	PASS	30.4 ±1 %.	PASS	3.6 ±1 %.	PASS
2600	48.5 ±1 %.		28.8 ±1 %.		3.6 ±1 %.	
3000	41.5 ±1 %.		25.0 ±1 %.		3.6 ±1 %.	
3500	37.0 ±1 %.		26.4 ±1 %.		3.6 ±1 %.	
3700	34.7 ±1 %.		26.4 ±1 %.		3.6 ±1 %.	

This document shall not be reproduced, except in full or in part, without the written approval of SATIMO. The information contained herein is to be used only for the purpose for which it is submitted and is not to be released in whole or part without written approval of SATIMO.





7 VALIDATION MEASUREMENT

The IEEE Std. 1528, OET 65 Bulletin C and CEI/IEC 62209 standards state that the system validation measurements must be performed using a reference dipole meeting the fore mentioned return loss and mechanical dimension requirements. The validation measurement must be performed against a liquid filled flat phantom, with the phantom constructed as outlined in the fore mentioned standards. Per the standards, the dipole shall be positioned below the bottom of the phantom, with the dipole length centered and parallel to the longest dimension of the flat phantom, with the top surface of the dipole at the described distance from the bottom surface of the phantom.

7.1 HEAD LIQUID MEASUREMENT

Table with 5 columns: Frequency (MHz), Relative permittivity (eps_r) (required, measured), and Conductivity (sigma) S/m (required, measured). Rows list frequencies from 300 to 3500 MHz.

7.2 SAR MEASUREMENT RESULT WITH HEAD LIQUID

The IEEE Std. 1528 and CEI/IEC 62209 standards state that the system validation measurements should produce the SAR values shown below (for phantom thickness of 2 mm), within the uncertainty for the system validation. All SAR values are normalized to 1 W forward power. In bracket, the measured SAR is given with the used input power.

Table with 2 columns: Parameter and Value. Parameters include Software (OPENSAR V4), Phantom (SN 20/09 SAM71), Probe (SN 18/11 EPG122), Liquid (Head Liquid Values: eps_r : 39.0 sigma : 1.77), Distance between dipole center and liquid (10.0 mm), and Area scan resolution (dx=8mm/dy=8mm).

This document shall not be reproduced, except in full or in part, without the written approval of SATIMO. The information contained herein is to be used only for the purpose for which it is submitted and is not to be released in whole or part without written approval of SATIMO.





SAR REFERENCE DIPOLE CALIBRATION REPORT

Ref: ACR.287.8.14.SATU.A

Zoon Scan Resolution	dx=8mm/dy=8mm/dz=5mm
Frequency	2450 MHz
Input power	20 dBm
Liquid Temperature	21 °C
Lab Temperature	21 °C
Lab Humidity	45 %

Frequency MHz	1 g SAR (W/kg/W)		10 g SAR (W/kg/W)	
	required	measured	required	measured
300	2.85		1.94	
450	4.58		3.06	
750	8.49		5.55	
835	9.56		6.22	
900	10.9		6.99	
1450	29		16	
1500	30.5		16.8	
1640	34.2		18.4	
1750	36.4		19.3	
1800	38.4		20.1	
1900	39.7		20.5	
1950	40.5		20.9	
2000	41.1		21.1	
2100	43.6		21.9	
2300	48.7		23.3	
2450	52.4	53.89 (5.39)	24	24.15 (2.42)
2600	55.3		24.6	
3000	63.8		25.7	
3500	67.1		25	

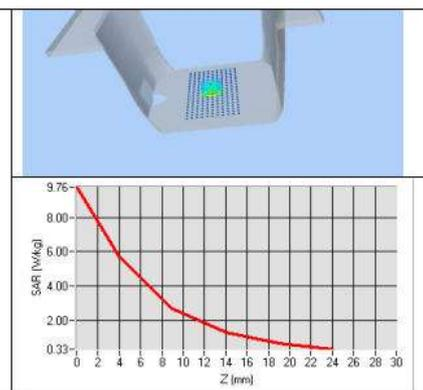
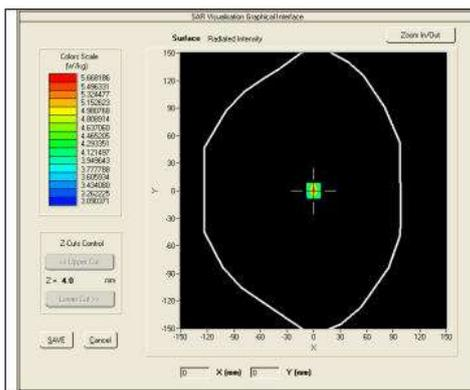

This document shall not be reproduced, except in full or in part, without the written approval of SATIMO. The information contained herein is to be used only for the purpose for which it is submitted and is not to be released in whole or part without written approval of SATIMO.





7.3 BODY LIQUID MEASUREMENT

Frequency MHz	Relative permittivity (ϵ_r')		Conductivity (σ) S/m	
	required	measured	required	measured
150	61.9 ±5 %		0.80 ±5 %	
300	58.2 ±5 %		0.92 ±5 %	
450	56.7 ±5 %		0.94 ±5 %	
750	55.5 ±5 %		0.96 ±5 %	
835	55.2 ±5 %		0.97 ±5 %	
900	55.0 ±5 %		1.05 ±5 %	
915	55.0 ±5 %		1.06 ±5 %	
1450	54.0 ±5 %		1.30 ±5 %	
1610	53.8 ±5 %		1.40 ±5 %	
1800	53.3 ±5 %		1.52 ±5 %	
1900	53.3 ±5 %		1.52 ±5 %	
2000	53.3 ±5 %		1.52 ±5 %	
2100	53.2 ±5 %		1.62 ±5 %	
2450	52.7 ±5 %	PASS	1.95 ±5 %	PASS
2600	52.5 ±5 %		2.16 ±5 %	
3000	52.0 ±5 %		2.73 ±5 %	
3500	51.3 ±5 %		3.31 ±5 %	
5200	49.0 ±10 %		5.30 ±10 %	
5300	48.9 ±10 %		5.42 ±10 %	
5400	48.7 ±10 %		5.53 ±10 %	
5500	48.6 ±10 %		5.65 ±10 %	
5600	48.5 ±10 %		5.77 ±10 %	
5800	48.2 ±10 %		6.00 ±10 %	

7.4 SAR MEASUREMENT RESULT WITH BODY LIQUID

Software	OPENSAR V4
Phantom	SN 20/09 SAM71
Probe	SN 18/11 EPG122
Liquid	Body Liquid Values: ϵ_{ps}' : 53.0 sigma : 1.93
Distance between dipole center and liquid	10.0 mm
Area scan resolution	dx=8mm/dy=8mm
Zoon Scan Resolution	dx=8mm/dy=8mm/dz=5mm
Frequency	2450 MHz
Input power	20 dBm
Liquid Temperature	21 °C
Lab Temperature	21 °C
Lab Humidity	45 %

Page: 9/11

This document shall not be reproduced, except in full or in part, without the written approval of SATIMO. The information contained herein is to be used only for the purpose for which it is submitted and is not to be released in whole or part without written approval of SATIMO.





SAR REFERENCE DIPOLE CALIBRATION REPORT

Ref: ACR.287.8.14.SATU.A

股份
ng Lab

Frequency MHz	1 g SAR (W/kg/W)	10 g SAR (W/kg/W)
	measured	measured
2450	54.65 (5.46)	24.58 (2.46)

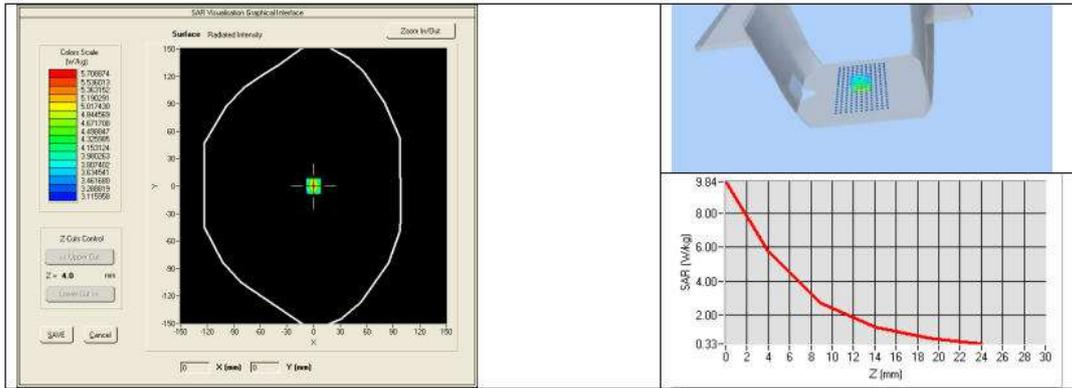

This document shall not be reproduced, except in full or in part, without the written approval of SATIMO. The information contained herein is to be used only for the purpose for which it is submitted and is not to be released in whole or part without written approval of SATIMO.

股份
ng Lab



Frequency MHz	1 g SAR (W/kg/W)	10 g SAR (W/kg/W)
	measured	measured
2450	54.65 (5.46)	24.58 (2.46)

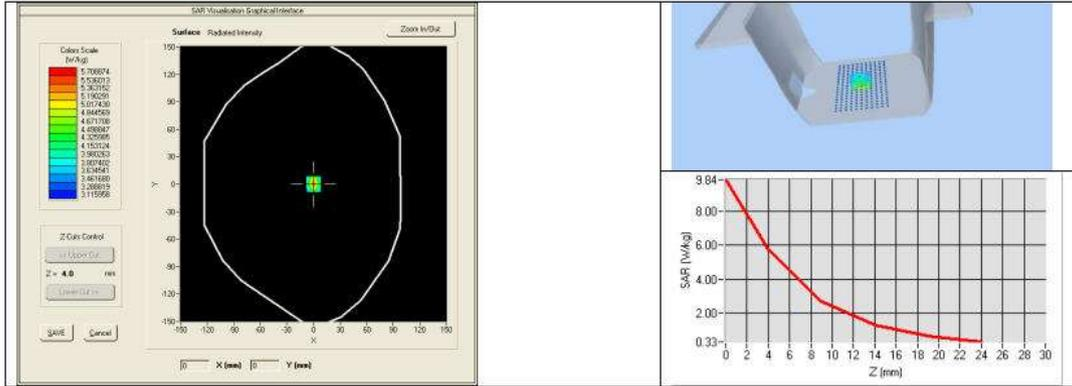



8 LIST OF EQUIPMENT

Equipment Summary Sheet				
Equipment Description	Manufacturer / Model	Identification No.	Current Calibration Date	Next Calibration Date
SAM Phantom	Satimo	SN-20/09-SAM71	Validated. No cal required.	Validated. No cal required.
COMOSAR Test Bench	Version 3	NA	Validated. No cal required.	Validated. No cal required.
Network Analyzer	Rhode & Schwarz ZVA	SN100132	02/2021	02/2024
Calipers	Carrera	CALIPER-01	12/2021	12/2023
Reference Probe	Satimo	EPG122 SN 18/11	10/2023	10/2024
Multimeter	Keithley 2000	1188656	12/2021	12/2023
Signal Generator	Agilent E4438C	MY49070581	12/2021	12/2023
Amplifier	Aethercomm	SN 046	Characterized prior to test. No cal required.	Characterized prior to test. No cal required.
Power Meter	HP E4418A	US38261498	12/2021	12/2023
Power Sensor	HP ECP-E26A	US37181460	12/2021	12/2023
Directional Coupler	Narda 4216-20	01386	Characterized prior to test. No cal required.	Characterized prior to test. No cal required.
Temperature and Humidity Sensor	Control Company	11-661-9	8/2021	8/2024

This document shall not be reproduced, except in full or in part, without the written approval of SATIMO. The information contained herein is to be used only for the purpose for which it is submitted and is not to be released in whole or part without written approval of SATIMO.





5.3 SID5-6G Dipole Calibration Certificate



SAR Reference Waveguide Calibration Report

Ref : ACR.273.5.18.SATU.A

**SHENZHEN LCS COMPLIANCE TESTING
LABORATORY LTD.**
**1F., XINGYUAN INDUSTRIAL PARK, TONGDA
ROAD, BAO'AN BLVD BAO'AN DISTRICT,
SHENZHEN, GUANGDONG, CHINA**
**MVG COMOSAR
REFERENCE WAVEGUIDE**
FREQUENCY: 5000-6000 MHZ
SERIAL NO.: SN 49/16 WGA 43

Calibrated at MVG US
2105 Barrett Park Dr. - Kennesaw, GA 30144



Calibration Date: 09/22/2021

Summary:

This document presents the method and results from an accredited SAR reference waveguide calibration performed in MVG USA using the COMOSAR test bench. All calibration results are traceable to national metrology institutions.





SAR REFERENCE WAVEGUIDE CALIBRATION REPORT

Ref: ACR.273.5.18.SATU.A

	<i>Name</i>	<i>Function</i>	<i>Date</i>	<i>Signature</i>
<i>Prepared by :</i>	Jérôme LUC	Product Manager	09/28/2021	<i>JS</i>
<i>Checked by :</i>	Jérôme LUC	Product Manager	09/28/2021	<i>JS</i>
<i>Approved by :</i>	Kim RUTKOWSKI	Quality Manager	09/28/2021	<i>Kim Rutkowski</i>

	<i>Customer Name</i>
<i>Distribution :</i>	Shenzhen LCS Compliance Testing Laboratory Ltd.

<i>Issue</i>	<i>Date</i>	<i>Modifications</i>
A	09/28/2021	Initial release

This document shall not be reproduced, except in full or in part, without the written approval of MVG. The information contained herein is to be used only for the purpose for which it is submitted and is not to be released in whole or part without written approval of MVG.





SAR REFERENCE WAVEGUIDE CALIBRATION REPORT

Ref: ACR.273.5.18.SATU.A

TABLE OF CONTENTS

1 Introduction.....4

2 Device Under Test4

3 Product Description4

 3.1 General Information 4

4 Measurement Method4

 4.1 Return Loss Requirements 4

 4.2 Mechanical Requirements 4

5 Measurement Uncertainty..... 5

 5.1 Return Loss 5

 5.2 Dimension Measurement 5

 5.3 Validation Measurement 5

6 Calibration Measurement Results 5

 6.1 Return Loss 5

 6.2 Mechanical Dimensions 6

7 Validation measurement 7

 7.1 Head Liquid Measurement 7

 7.2 Measurement Result 7

 7.3 Body Measurement Result 10

8 List of Equipment 13

This document shall not be reproduced, except in full or in part, without the written approval of MVG. The information contained herein is to be used only for the purpose for which it is submitted and is not to be released in whole or part without written approval of MVG.





SAR REFERENCE WAVEGUIDE CALIBRATION REPORT

Ref: ACR.273.5.18.SATU.A

股份
ng Lab

1 INTRODUCTION

This document contains a summary of the requirements set forth by the IEEE 1528 and CEI/IEC 62209 standards for reference waveguides used for SAR measurement system validations and the measurements that were performed to verify that the product complies with the fore mentioned standards.

2 DEVICE UNDER TEST

Device Under Test	
Device Type	COMOSAR 5000-6000 MHz REFERENCE WAVEGUIDE
Manufacturer	MVG
Model	SWG5500
Serial Number	SN 49/16 WGA 43
Product Condition (new / used)	Used

A yearly calibration interval is recommended.

3 PRODUCT DESCRIPTION

3.1 GENERAL INFORMATION

MVG's COMOSAR Validation Waveguides are built in accordance to the IEEE 1528 and CEI/IEC 62209 standards.

4 MEASUREMENT METHOD

The IEEE 1528 and CEI/IEC 62209 standards provide requirements for reference waveguides used for system validation measurements. The following measurements were performed to verify that the product complies with the fore mentioned standards.

4.1 RETURN LOSS REQUIREMENTS

The waveguide used for SAR system validation measurements and checks must have a return loss of -8 dB or better. The return loss measurement shall be performed with matching layer placed in the open end of the waveguide, with the waveguide and matching layer in direct contact with the phantom shell as outlined in the fore mentioned standards.

4.2 MECHANICAL REQUIREMENTS

The IEEE 1528 and CEI/IEC 62209 standards specify the mechanical dimensions of the validation waveguide, the specified dimensions are as shown in Section 6.2. Figure 1 shows how the dimensions relate to the physical construction of the waveguide.

This document shall not be reproduced, except in full or in part, without the written approval of MVG. The information contained herein is to be used only for the purpose for which it is submitted and is not to be released in whole or part without written approval of MVG.



股份
ng Lab



5 MEASUREMENT UNCERTAINTY

All uncertainties listed below represent an expanded uncertainty expressed at approximately the 95% confidence level using a coverage factor of $k=2$, traceable to the Internationally Accepted Guides to Measurement Uncertainty.

5.1 RETURN LOSS

The following uncertainties apply to the return loss measurement:

Frequency band	Expanded Uncertainty on Return Loss
400-6000MHz	0.1 dB

5.2 DIMENSION MEASUREMENT

The following uncertainties apply to the dimension measurements:

Length (mm)	Expanded Uncertainty on Length
3 - 300	0.05 mm

5.3 VALIDATION MEASUREMENT

The guidelines outlined in the IEEE 1528 and CEI/IEC 62209 standards were followed to generate the measurement uncertainty for validation measurements.

Scan Volume	Expanded Uncertainty
1 g	20.3 %
10 g	20.1 %

6 CALIBRATION MEASUREMENT RESULTS

6.1 RETURN LOSS IN HEAD LIQUID

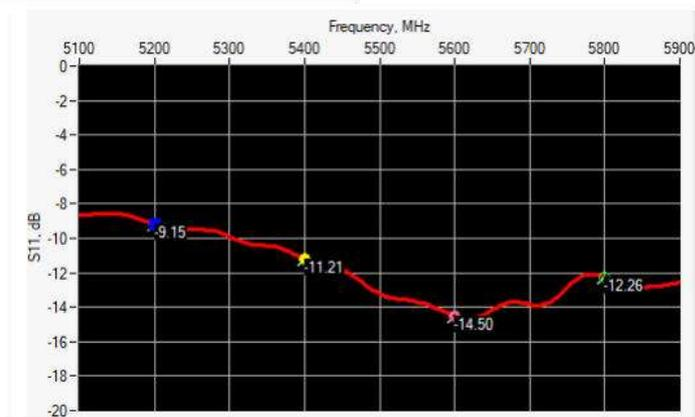

Page: 5/13

*This document shall not be reproduced, except in full or in part, without the written approval of MVG.
The information contained herein is to be used only for the purpose for which it is submitted and is not to be released in whole or part without written approval of MVG.*





SAR REFERENCE WAVEGUIDE CALIBRATION REPORT

Ref: ACR.273.5.18.SATU.A

Frequency (MHz)	Return Loss (dB)	Requirement (dB)	Impedance
5200	-9.15	-8	20.57 Ω + 11.55 jΩ
5400	-11.21	-8	75.27 Ω + 4.08 jΩ
5600	-14.50	-8	33.91 Ω - 8.72 jΩ
5800	-12.26	-8	53.07 Ω + 23.41 jΩ

6.2 RETURN LOSS IN BODY LIQUID

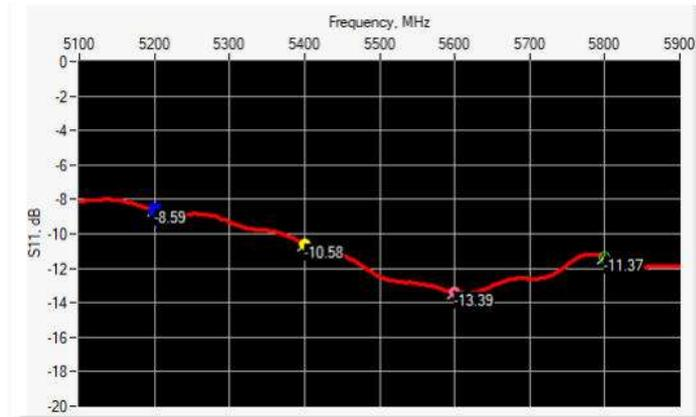

Frequency (MHz)	Return Loss (dB)	Requirement (dB)	Impedance
5200	-8.59	-8	19.38 Ω + 13.50 jΩ
5400	-10.58	-8	77.13 Ω + 1.81 jΩ
5600	-13.39	-8	30.95 Ω - 7.75 jΩ
5800	-11.37	-8	54.79 Ω + 25.47 jΩ

6.3 MECHANICAL DIMENSIONS

Frequency (MHz)	L (mm)		W (mm)		Lr (mm)		Wr (mm)		T (mm)	
	Required	Measured	Required	Measured	Required	Measured	Required	Measured	Required	Measured
5200	40.39 ± 0.13	PASS	20.19 ± 0.13	PASS	81.03 ± 0.13	PASS	61.98 ± 0.13	PASS	5.3*	PASS
5800	40.39 ± 0.13	PASS	20.19 ± 0.13	PASS	81.03 ± 0.13	PASS	61.98 ± 0.13	PASS	4.3*	PASS

* The tolerance for the matching layer is included in the return loss measurement.

This document shall not be reproduced, except in full or in part, without the written approval of MVG. The information contained herein is to be used only for the purpose for which it is submitted and is not to be released in whole or part without written approval of MVG.



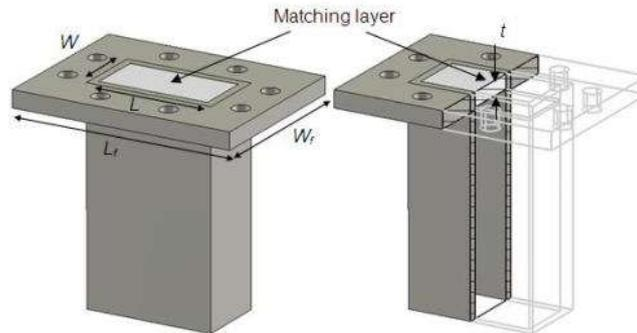

Figure 1: Validation Waveguide Dimensions

7 VALIDATION MEASUREMENT

The IEEE Std. 1528 and CEI/IEC 62209 standards state that the system validation measurements must be performed using a reference waveguide meeting the fore mentioned return loss and mechanical dimension requirements. The validation measurement must be performed with the matching layer placed in the open end of the waveguide, with the waveguide and matching layer in direct contact with the phantom shell.

7.1 HEAD LIQUID MEASUREMENT

Frequency MHz	Relative permittivity (ϵ_r')		Conductivity (σ) S/m	
	required	measured	required	measured
5000	36.2 \pm 10 %		4.45 \pm 10 %	
5100	36.1 \pm 10 %		4.56 \pm 10 %	
5200	36.0 \pm 10 %	PASS	4.66 \pm 10 %	PASS
5300	35.9 \pm 10 %		4.76 \pm 10 %	
5400	35.8 \pm 10 %	PASS	4.86 \pm 10 %	PASS
5500	35.6 \pm 10 %		4.97 \pm 10 %	
5600	35.5 \pm 10 %	PASS	5.07 \pm 10 %	PASS
5700	35.4 \pm 10 %		5.17 \pm 10 %	
5800	35.3 \pm 10 %	PASS	5.27 \pm 10 %	PASS
5900	35.2 \pm 10 %		5.38 \pm 10 %	
6000	35.1 \pm 10 %		5.48 \pm 10 %	

7.2 SAR MEASUREMENT RESULT WITH HEAD LIQUID

At those frequencies, the target SAR value can not be generic. Hereunder is the target SAR value defined by MVG, within the uncertainty for the system validation. All SAR values are normalized to 1 W net power. In bracket, the measured SAR is given with the used input power.

Page: 7/13

This document shall not be reproduced, except in full or in part, without the written approval of MVG. The information contained herein is to be used only for the purpose for which it is submitted and is not to be released in whole or part without written approval of MVG.





SAR REFERENCE WAVEGUIDE CALIBRATION REPORT

Ref: ACR.273.5.18.SATU.A

Software	OPENSAR V4
Phantom	SN 20/09 SAM71
Probe	SN 18/11 EPG122
Liquid	Head Liquid Values 5200 MHz: cps' :35.64 sigma : 4.67 Head Liquid Values 5400 MHz: cps' :36.44 sigma : 4.87 Head Liquid Values 5600 MHz: cps' :36.66 sigma : 5.17 Head Liquid Values 5800 MHz: cps' :35.31 sigma : 5.31
Distance between dipole waveguide and liquid	0 mm
Area scan resolution	dx=8mm/dy=8mm
Zoon Scan Resolution	dx=4mm/dy=4m/dz=2mm
Frequency	5200 MHz 5400 MHz 5600 MHz 5800 MHz
Input power	20 dBm
Liquid Temperature	21 °C
Lab Temperature	21 °C
Lab Humidity	45 %

Frequency (MHz)	1 g SAR (W/kg)		10 g SAR (W/kg)	
	required	measured	required	measured
5200	159.00	165.77 (16.58)	56.90	57.20 (5.72)
5400	166.40	173.20 (17.32)	58.43	59.22 (5.92)
5600	173.80	179.61 (17.96)	59.97	60.98 (6.10)
5800	181.20	186.77 (18.68)	61.50	62.84 (6.28)

SAR MEASUREMENT PLOTS @ 5200 MHz

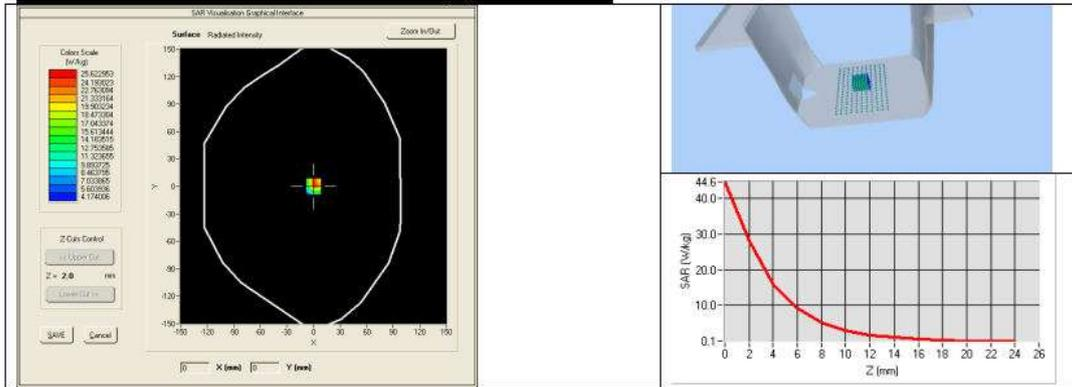

This document shall not be reproduced, except in full or in part, without the written approval of MVG. The information contained herein is to be used only for the purpose for which it is submitted and is not to be released in whole or part without written approval of MVG.





SAR REFERENCE WAVEGUIDE CALIBRATION REPORT

Ref: ACR.273.5.18.SATU.A

股份
ng Lab

SAR MEASUREMENT PLOTS @ 5400 MHz

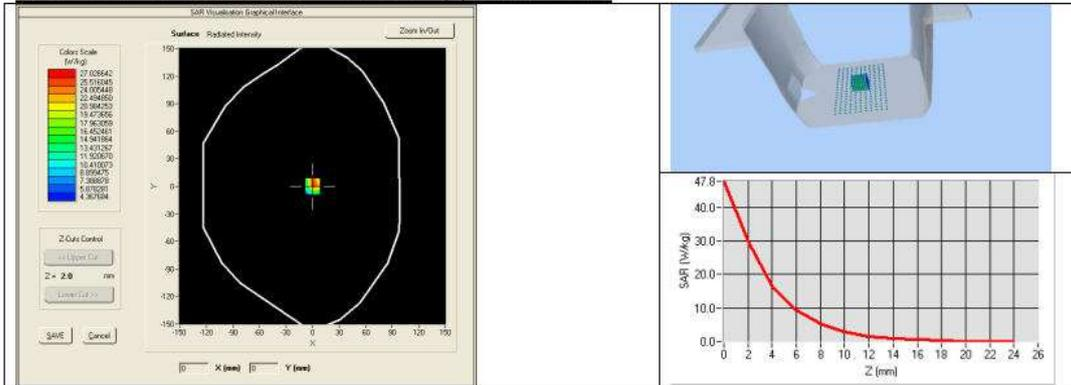

SAR MEASUREMENT PLOTS @ 5600 MHz

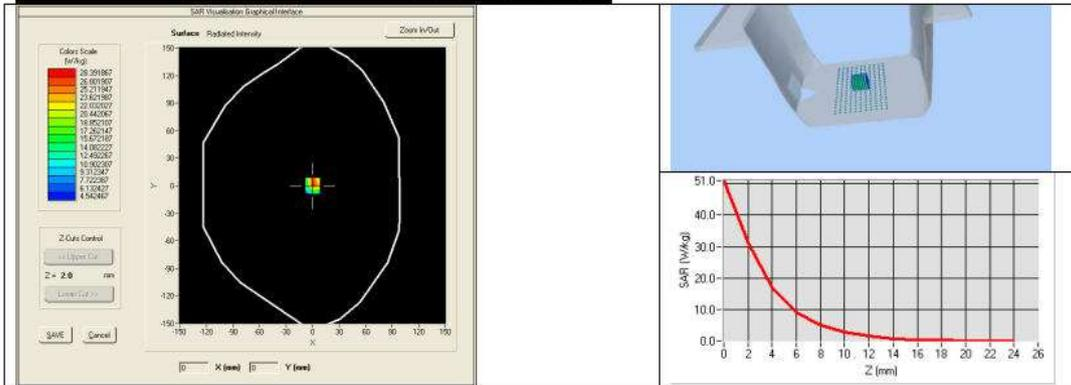

SAR MEASUREMENT PLOTS @ 5800 MHz

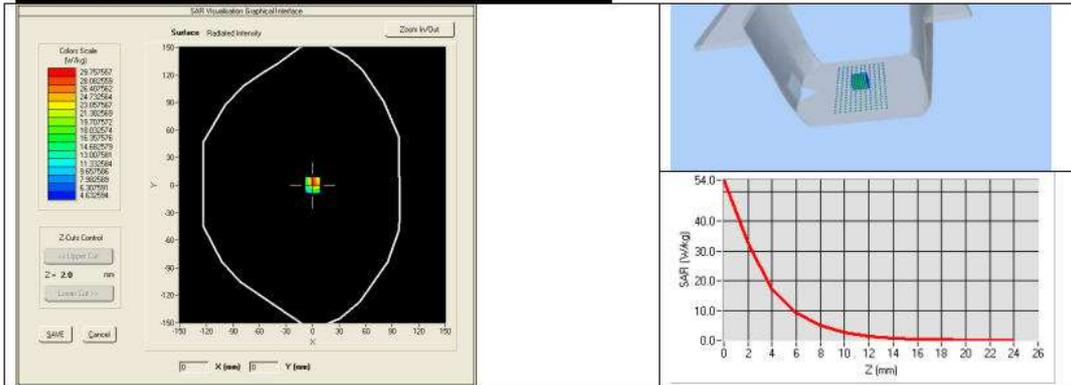

This document shall not be reproduced, except in full or in part, without the written approval of MVG. The information contained herein is to be used only for the purpose for which it is submitted and is not to be released in whole or part without written approval of MVG.

股份
ng Lab





SAR REFERENCE WAVEGUIDE CALIBRATION REPORT

Ref: ACR.273.5.18.SATU.A

股份
ng Lab

7.3 BODY LIQUID MEASUREMENT

Frequency MHz	Relative permittivity (ϵ_r)		Conductivity (σ) S/m	
	required	measured	required	measured
5200	49.0 \pm 10 %	PASS	5.30 \pm 10 %	PASS
5300	48.9 \pm 10 %		5.42 \pm 10 %	
5400	48.7 \pm 10 %	PASS	5.53 \pm 10 %	PASS
5500	48.6 \pm 10 %		5.65 \pm 10 %	
5600	48.5 \pm 10 %	PASS	5.77 \pm 10 %	PASS
5800	48.2 \pm 10 %	PASS	6.00 \pm 10 %	PASS

7.4 SAR MEASUREMENT RESULT WITH BODY LIQUID

Software	OPENSAR V4
Phantom	SN 20/09 SAM71
Probe	SN 18/11 EPG122
Liquid	Body Liquid Values 5200 MHz: ϵ_r :48.64 σ : 5.51 Body Liquid Values 5400 MHz: ϵ_r :46.52 σ : 5.77 Body Liquid Values 5600 MHz: ϵ_r :46.79 σ : 5.77 Body Liquid Values 5800 MHz: ϵ_r :47.04 σ : 6.10
Distance between dipole waveguide and liquid	0 mm
Area scan resolution	dx=8mm/dy=8mm
Zoon Scan Resolution	dx=4mm/dy=4m/dz=2mm
Frequency	5200 MHz 5400 MHz 5600 MHz 5800 MHz
Input power	20 dBm
Liquid Temperature	21 °C
Lab Temperature	21 °C
Lab Humidity	45 %



Frequency (MHz)	1 g SAR (W/kg)	10 g SAR (W/kg)
	measured	measured
5200	159.09 (15.91)	56.13 (5.61)
5400	164.56 (16.46)	57.31 (5.73)
5600	172.25 (17.23)	59.72 (5.97)
5800	177.77 (17.78)	61.06 (6.11)

This document shall not be reproduced, except in full or in part, without the written approval of MVG. The information contained herein is to be used only for the purpose for which it is submitted and is not to be released in whole or part without written approval of MVG.

股份
ng Lab





SAR REFERENCE WAVEGUIDE CALIBRATION REPORT

Ref: ACR.273.5.18.SATU.A

股份
ng Lab

BODY SAR MEASUREMENT PLOTS @ 5200 MHz

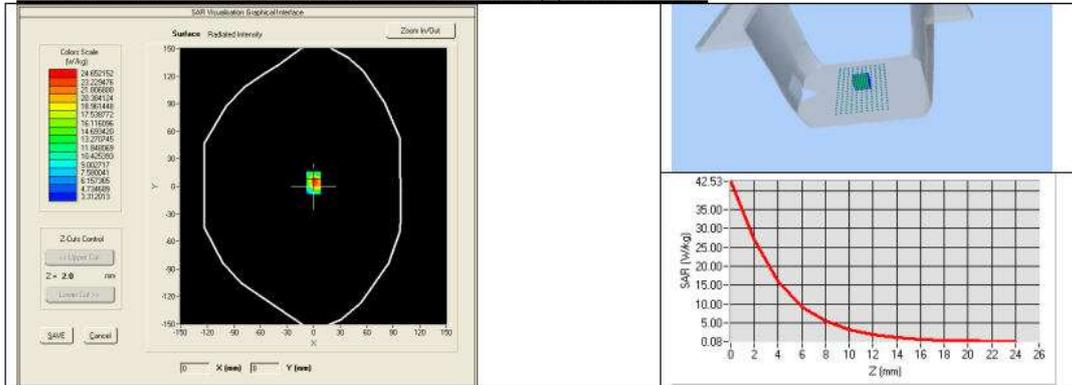

BODY SAR MEASUREMENT PLOTS @ 5400 MHz

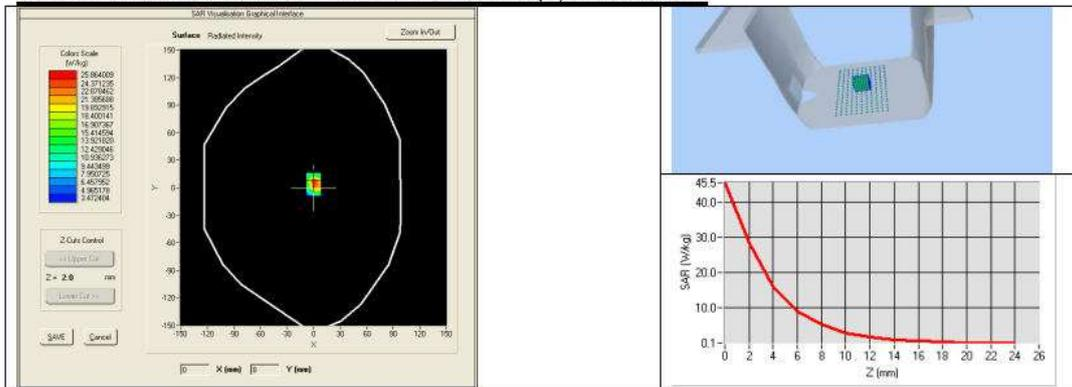

BODY SAR MEASUREMENT PLOTS @ 5600 MHz

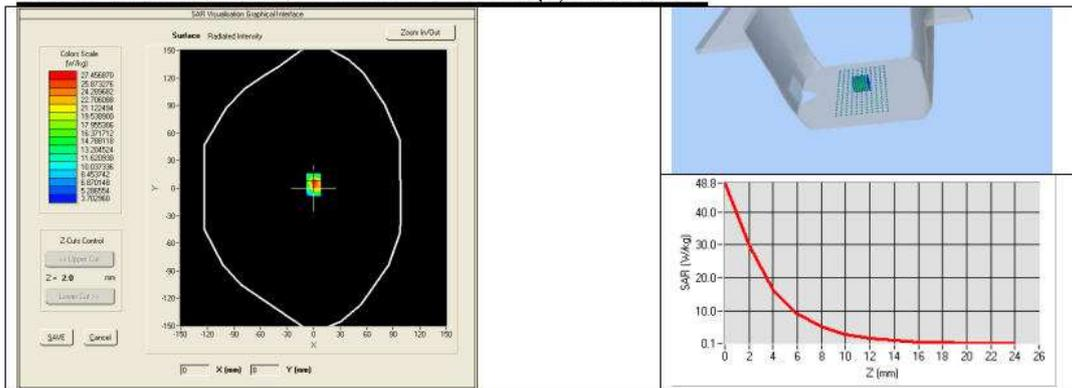

This document shall not be reproduced, except in full or in part, without the written approval of MVG. The information contained herein is to be used only for the purpose for which it is submitted and is not to be released in whole or part without written approval of MVG.

股份
ng Lab





SAR REFERENCE WAVEGUIDE CALIBRATION REPORT

Ref: ACR.273.5.18.SATU.A

BODY SAR MEASUREMENT PLOTS @ 5800 MHz

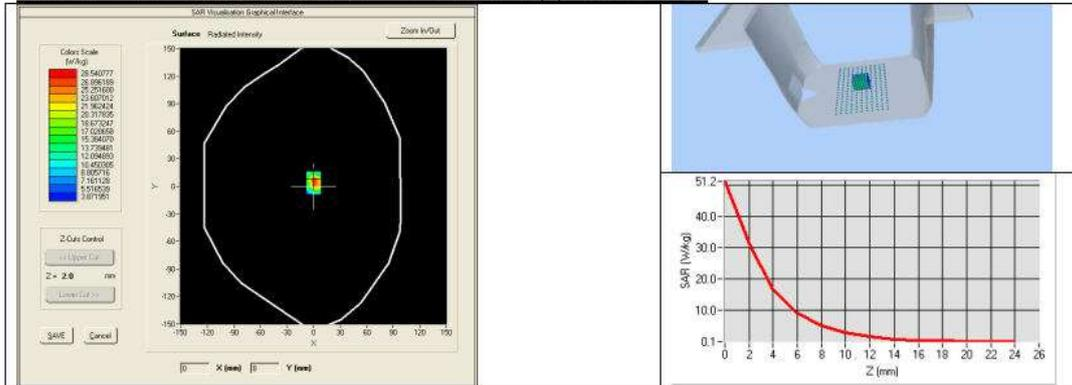

This document shall not be reproduced, except in full or in part, without the written approval of MVG. The information contained herein is to be used only for the purpose for which it is submitted and is not to be released in whole or part without written approval of MVG.





8 LIST OF EQUIPMENT

Equipment Summary Sheet				
Equipment Description	Manufacturer / Model	Identification No.	Current Calibration Date	Next Calibration Date
Flat Phantom	MVG	SN-20/09-SAM71	Validated. No cal required.	Validated. No cal required.
COMOSAR Test Bench	Version 3	NA	Validated. No cal required.	Validated. No cal required.
Network Analyzer	Rhode & Schwarz ZVA	SN100132	06/2021	06/2024
Calipers	Carrera	CALIPER-01	01/2023	01/2026
Reference Probe	MVG	EPG122 SN 18/11	08/2023	08/2024
Multimeter	Keithley 2000	1188656	01/2023	01/2026
Signal Generator	Agilent E4438C	MY49070581	01/2023	01/2026
Amplifier	Aethercomm	SN 046	Characterized prior to test. No cal required.	Characterized prior to test. No cal required.
Power Meter	HP E4418A	US38261498	11/2023	11/2026
Power Sensor	HP ECP-E26A	US37181460	01/2023	01/2026
Directional Coupler	Narda 4216-20	01386	Characterized prior to test. No cal required.	Characterized prior to test. No cal required.
Temperature and Humidity Sensor	Control Company	150798832	11/2023	11/2026

This document shall not be reproduced, except in full or in part, without the written approval of MVG. The information contained herein is to be used only for the purpose for which it is submitted and is not to be released in whole or part without written approval of MVG.



6.EUT TEST PHOTOGRAPHS

6.1 Photograph of liquid depth



Photograph of the depth in the Head Phantom (2450MHz, 15.7cm depth)



Photograph of the depth in the Head Phantom (5200MHz, 16.4cm depth)





Photograph of the depth in the Head Phantom (5800MHz, 15.3cm depth)

立讯检测股份
LCS Testing Lab

立讯检测股份
LCS Testing Lab

立讯检测股份
LCS Testing Lab

立讯检测股份
LCS Testing Lab

立讯检测股份
LCS Testing Lab

立讯检测股份
LCS Testing Lab

立讯检测股份
LCS Testing Lab





7.SETUP PHOTOGRAPHS

Please refer to separated files for Test Setup Photos of SAR.





8.EUT PHOTOGRAPHS

Please refer to separated files for Test Setup Photos of SAR

.....**The End of Test Report**.....

